

66548 U.S. PTO



PATENT

IN THE UNITED STATES PATENT AND TRADEMARK OFFICE

In re the patent of:)
)
 Arthur R. HAIR)
)
 U.S. Patent No. 5,191,573)
)
 Issued: March 2, 1993)
)
 Application No. 07/586,391)
)
 Filed: September 18, 1990)
)
 For: METHOD FOR TRANSMITTING A DESIRED)
 DIGITAL VIDEO OR AUDIO SIGNAL)
 _____)

66548 U.S. PTO
90007402



Docket No. NAPSP001

Date: January 31, 2005

CERTIFICATE OF EXPRESS MAILING

I hereby certify that this paper and the documents and/or fees referred to as attached herein are being deposited with the United States Postal Service on January 31, 2005 in an envelope as "Express Mail Post Office to Addressee" service under 37 CFR § 1.10, Mailing Label Number EV 577446420 US, addressed to the Commissioner for Patents, P.O. Box 1450, Alexandria, VA 22313-1450.

Albert S. Penfla

**REQUEST FOR *EX PARTE* REEXAMINATION
TRANSMITTAL FORM**

Commissioner for Patents
Mail Stop *Ex Parte* Reexam
P.O. Box 1450
Alexandria, VA 22313-1450

1. This is a request for *ex parte* reexamination pursuant to 37 CFR 1.510 of U.S. Patent No. 5,191,573, which issued March 2, 1993 (the '573 patent). The request is made by a third-party requester.

2. The name and address of the person requesting reexamination is:

Napster, Inc. (formerly Roxio, Inc. and majority owner of Napster, L.L.C.)
Los Angeles Office 02/09/2005 NTW11TY 00000005 90007402
9044 Melrose Ave.
Los Angeles, CA 90069.

3. A check in the amount of \$2,520.00 to cover the *ex parte* reexamination fee is enclosed. 2820.00 OP
37 CFR 1.20(c)(1).

4. The Commissioner is authorized to charge any fees beyond the amount enclosed which may be required, or to credit any overpayment, to Deposit Account No. 50-0805 (Order No. NAPSP001).

5. A copy of the '573 patent to be reexamined having a double column format on one side of a separate paper is enclosed (a Certificate of Correction for the '573 patent also is enclosed). 37 CFR 1.510(b)(4).

6. Reexamination of claims 1-6 is requested.

7. A copy of every patent or printed publication relied upon is submitted herewith including a listing thereof on Form PTO-1449.

8. The attached detailed request includes at least the following items:

a. A statement identifying each substantial new question of patentability based on prior patents and printed publications. 37 CFR 1.510(b)(1); and

b. An identification of every claim for which reexamination is requested, and a detailed explanation of the pertinency and manner of applying the cited art to every claim for which reexamination is requested. 37 CFR 1.510(b)(2).

9. It is certified that a copy of this request has been served in its entirety on the patent owner as provided in 37 CFR 1.33(c). The name and address of the party served and the date of service are:

Ansel M. Schwartz, Registration No. 30,587
201 N. Craig Street, Suite 304
Pittsburgh, PA 15213

Date of Service: January 31, 2005 (by overnight courier).

10. Correspondence Address: Direct all communication about the reexamination to:

Albert S. Penilla
MARTINE PENILLA & GENCARELLA, LLP
710 Lakeway Drive, Suite 200
Sunnyvale, CA 94085
(408) 749-6900
Customer Number 25920.

11. The patent is the subject of the following concurrent proceeding:

Copending litigation styled: SightSound Technologies, Inc. v. Roxio, Inc. and Napster, L.L.C., U.S. District Court for the Western District of Pennsylvania, Civil Action No. 04-1549.

Respectfully submitted,
MARTINE PENILLA & GENCARELLA, LLP



Albert S. Penilla (for third-party requester)
Reg. No. 39,487

710 Lakeway Drive, Suite 200
Sunnyvale, CA 94085
(408) 749-6900
Customer No. 25920

IN THE UNITED STATES PATENT AND TRADEMARK OFFICE

In re *Ex Parte* Reexamination of:

Arthur R. Hair

U.S. Patent No. 5,191,573

Issued: March 2, 1993

For: METHOD FOR TRANSMITTING
A DESIRED DIGITAL VIDEO OR
AUDIO SIGNAL

Examiner: Nguyen, Hoa T.
(Prior Examiner)

Group Art Unit: 2413
(Prior Examination)

**REQUEST FOR *Ex Parte*
REEXAMINATION
UNDER 37 CFR § 1.510**

Date: January 31, 2005

Mail Stop *Ex Parte* Reexam
Honorable Commissioner of Patents and Trademarks
P.O. Box 1450
Alexandria, VA 22313-1450

TABLE OF CONTENTS

I. INTRODUCTION..... 1

II. RELATED AND CO-FILED REQUESTS FOR REEXAMINATION 2

III. CURRENT STATUS OF THE '573 PATENT..... 2

IV. CLAIMS FOR WHICH REEXAMINATION IS REQUESTED 3

V. PRIOR ART PATENTS AND PUBLICATIONS..... 3

VI. STATEMENT POINTING OUT SUBSTANTIAL NEW QUESTIONS OF
PATENTABILITY AND DESCRIPTION OF THE RELEVANT PRIOR ART 4

 A. GALLAGHER (GB 2 178 275 A): Claims 1 – 6 of the Hair '573 Patent
 Are Anticipated Under 35 U.S.C. § 102 by Gallagher and/or Are Rendered
 Obvious Under 35 U.S.C. § 103 by Gallagher in view of Gremillet,
 Freeny, Akashi, Hellman, Elmer-Dewitt or Ferrarini. 5

 B. GREMILLET (U.S. Pat. No. 4,499,568): Claims 1 – 6 of the Hair '573
 Patent Are Anticipated Under 35 U.S.C. § 102 by Gremillet and/or Are
 Rendered Obvious Under 35 U.S.C. § 103 by Gremillet in view of
 Gallagher, Freeny, Akashi, Hellman, Elmer-Dewitt or Ferrarini..... 13

 C. FREENY, JR. (U.S. Pat. No. 4,528,643): Claims 1 – 6 of the Hair '573
 Patent Are Anticipated Under 35 U.S.C. § 102 by Freeny. 22

VII. CONCLUSION..... 26

**REQUEST FOR REEXAMINATION
OF U.S. PATENT NO. 5,191,573**

I. INTRODUCTION

This Request for *Ex Parte* Reexamination of U.S. Patent No. 5,191,573 (“the ‘573 patent”) raises substantial new questions of patentability with respect to the ‘573 patent based on prior art not cited or considered during the prosecution of the ‘573 patent. During the prosecution of the ‘573 patent, prior art references Gallagher, Gremillet and Freeny were neither disclosed nor considered by the Examiner.

The ‘573 patent is directed to a method for electronically selling and transferring desired digital audio or video signals through telecommunications lines from a first memory of a first party to a second memory of a second party. The Gallagher prior art reference also teaches a method, system and apparatus for selling and transferring through telecommunications lines, recorded digital audio and video data between a source unit, which may belong to an artist, a database, which may be housed by a record company, and user units, which belong to the general public.

Similarly, Gremillet teaches a method and system for the electronic sale of digital audio signals and recorded information over telecommunications lines, including telephone lines, cables and optical fibres. The digital audio signals are stored in an information bank at a distribution center and are distributed to user equipment that includes a recording device.

In addition, Freeny teaches a method and system of transferring digital information which includes forming a connection through telecommunications lines between a first memory of a first party and a second memory of a second party, the first memory having the digital signals, selling electronically by the first party to the second party through the telecommunications lines the desired digital signals, transferring the desired digital signals from the first party to the second party through those lines while the second memory is in possession

and control of the second party and the step of storing the digital signals in the second memory.

Gallagher, Gremillet and Freeny each individually anticipate all claims of the '573 patent. Additionally, Gallagher, Gremillet and Freeny in combination with other prior art references, cited below, render all claims of the '573 patent obvious.

Accordingly, because Gallagher, Gremillet and Freeny alone and in combination with other prior art references raise substantial new questions of patentability, this Request for Reexamination of the '573 patent should be granted.

II. RELATED AND CO-FILED REQUESTS FOR REEXAMINATION

In addition to this Request for Reexamination of the '573 patent, separate Requests for Reexamination of U.S. Patent Nos. 5,675,734 (the "'734 patent'") and 5,966,440 (the "'440 patent'") have also been concurrently filed. The '573, '734 and '440 patents are all related, disclose identical inventions, claim priority to the same June 13, 1988 earliest filing date, and were issued from continuation applications from the same parent application. Moreover, the three patents also share similar specifications and identical drawings.

III. CURRENT STATUS OF THE '573 PATENT

The '573 patent is currently in litigation in the District Court for the Western District of Pennsylvania in a case styled SightSound Technologies, Inc. v. Roxio, Inc. and Napster, L.L.C., Civil Action No. 04-1549. The case is in its infancy and no formal discovery has taken place. Pursuant to the Court's request, Requestor has filed a Motion to Stay the case pending the outcome of the Reexamination proceedings.

Previously, the '573 patent was in litigation in another case, also in the District Court for the Western District of Pennsylvania, styled as SightSound.com Incorporated v. N2K, Inc., CDnow, Inc., and CDnow Online, Inc., Civil Action No. 98-0118. That case settled before

trial with no judicial determination of the invalidity of the '573 patent.

The '440 and '734 patents are also at issue in the current litigation, and were also at issue in the previous litigation.

IV. CLAIMS FOR WHICH REEXAMINATION IS REQUESTED

Reexamination is requested for all claims, claims 1 through 6.

V. PRIOR ART PATENTS AND PUBLICATIONS

Pursuant to 37 C.F.R. § 1.555 Requestor brings to the attention of the Examiner the following references, all of which are listed on the enclosed form PTO-1449, along with copies of the listed references:

Reference Name	Reference Description
"Gallagher"	Great Britain Patent GB 2 178 275 A, "Recorded Data Transfer System," filed July 16, 1986, published February 4, 1987.
"Gremillet"	U.S. Pat. No. 4,499,568, "Process for the Teledistribution of Recorded Information and a System for Performing This Process," filed December 13, 1982, issued February 12, 1985.
"Freeny"	U.S. Patent No. 4,528,643, "System For Reproducing Information In Material Objects At a Point of Sale Location," filed January 10, 1983, issued on July 9, 1985.
"Akashi"	Japanese Patent Application No. S62-284496 to H. Akashi, "Automated Music Purchasing System," filed on June 3, 1986 and published on December 10, 1987. (Translation included.)
"Hellman"	U.S. Pat. No. 4,658,093, Software Distribution System, filed July 13, 1983, issued on April 14, 1987.
"Ferrarini"	Ferrarini, "Direct Connections for Software Selections," Business Computer Systems, February 1984.
"Rosch"	"ComNet for the PC," <i>PC Magazine</i> , August 1983.
"Elmer-Dewitt"	"Calling Up an On-Line Cornucopia," <i>Time</i> , April 7, 1986.

“Jordan”	<i>Communications and Networking for the IBM PC, 1983.</i>
-----------------	--

For the reasons discussed below, the prior art patents and printed publications submitted herein raise substantial new questions of patentability of claims 1 through 6 of the ‘573 patent.

VI. STATEMENT POINTING OUT SUBSTANTIAL NEW QUESTIONS OF PATENTABILITY AND DESCRIPTION OF THE RELEVANT PRIOR ART

This Request for *Ex Parte* Reexamination of the ‘573 patent raises the following substantial new questions of patentability:

1. Whether claims 1 – 6 are anticipated under 35 U.S.C. § 102 by **Gallagher**;
2. Whether claims 1 – 6 are anticipated under 35 U.S.C. § 102 by **Gremillet**;
3. Whether claims 1 – 6 are anticipated under 35 U.S.C. § 102 by **Freeny**;
4. Whether claims 1 – 6 are rendered obvious under 35 U.S.C. § 103 by **Gallagher** in view of **Gremillet, Freeny, Akashi, Hellman, Elmer-Dewitt** or **Ferrarini**;
5. Whether claims 1 – 6 are rendered obvious under 35 U.S.C. § 103 by **Gremillet** in view of **Gallagher, Freeny, Akashi, Hellman, Elmer-Dewitt** or **Ferrarini**;
6. Whether claims 1 – 6 are rendered obvious under 35 U.S.C. § 103 by **Freeny** in view of **Gallagher, Gremillet, Akashi, Hellman, Elmer-Dewitt** or **Ferrarini**.

In the following claim charts, the left hand column lists the claims of the ‘573 patent and the right-hand column identifies the relevant portions of the cited references and explains their pertinence which anticipates under 35 U.S.C. § 102. The right hand column also explains how, in combination with other prior art, the cited references render the Hair ‘573 patent obvious under 35 U.S.C. § 103, as specifically described below.

A. GALLAGHER (GB 2 178 275 A): Claims 1 – 6 of the Hair '573 Patent Are Anticipated Under 35 U.S.C. § 102 by Gallagher and/or Are Rendered Obvious Under 35 U.S.C. § 103 by Gallagher in view of Gremillet, Freeny, Akashi, Hellman, Elmer-Dewitt or Ferrarini.

Gallagher (GB 2 178 275 A) was not cited or considered by the Examiner during the prosecution of the Hair '573 patent. Gallagher was filed on July 16, 1986 and published on February 4, 1987, prior to the earliest priority date of June 13, 1988 of the Hair '573 patent. Accordingly, Gallagher is prior art to the Hair patent.

Gallagher discloses and teaches a method, system and apparatus for transferring recorded digital audio and video data between a source unit, a database which may be housed by a record company and user units. Gallagher at Abstract. The system includes forming a connection through telecommunication lines (which include high speed telephone links by way of modems, or regular telephone links, fibre optic links, electro-magnetic waves or any other suitable medium) between a first memory of a first party and a second memory of a second party, the first memory having the digital audio or video signals, selling electronically by the first party to the second party through the telecommunications lines the desired digital audio or video signals, transferring the desired digital signals from the first party to the second party through the telecommunications lines while the second memory is in possession and control of the second party (at a remote location) and storing the digital signals in the second memory which includes hard disks. Gallagher at 1. Gallagher also teaches encryption and decryption of the digital audio or video signals for the prevention of unlawful copying and piracy. Gallagher at 1. Additionally, Gallagher discloses that the sale of the digital audio or video signal is through the user units, for example through the user's personal computer. Gallagher at 1.

Accordingly, the Gallagher patent raises substantial new questions of patentability

of the Hair '573 patent.

GREAT BRITAIN PATENT GB 2 178 275 A TO GALLAGHER	
Claim	Prior Art Disclosure Rendering Hair Anticipated or Obvious, Including Motivation to Combine
<p>1. A method for transmitting a desired digital audio signal stored on a first memory of a first party to a second memory of a second party comprising the steps of:</p>	<p>Gallagher teaches a "recorded data transfer system" of "digital data" in the "entertainment industry" such as "audio or visual" data. (Gallagher at 1:5, 1:8, 1:6-7, 1:91, Figs. 2 & 3). Gallagher also discloses that "the artist's material is digitized before it reaches the buffer stage." (Gallagher at 1:72-73) The desired digital audio signal is stored on a first memory of a first party, which is a "database having a main computer, . . . a data storage and processing system, means for controlling the storage and processing of data . . ." (Gallagher at 1:13-16) Additionally, the first party in Gallagher can be the "source unit" which can also contain the first memory, and it "comprises a storage medium 11." (Gallagher at 1:67-69) Gallagher also discloses that the first memory "media for storage of data would be floppy disk, hard disk, optical or laser disk, magnetic tape, integrated circuit memory or any other suitable medium." (Gallagher at 1:32-35) Gallagher teaches that the desired digital audio signal is transmitted to the second memory of a second party, a "user unit having . . . a means for storing/recalling and/or processing data received from the database." (Gallagher at 1:21-22) Gallagher also discloses that the second memory "media for storage of data would be floppy disk, hard disk, optical or laser disk, magnetic tape, integrated circuit memory or any other suitable medium." (Gallagher at 1:32-35)</p>
<p>transferring money electronically via a telecommunication lien [sic] to the first party at a location remote from the second memory and controlling use of the first memory from the second party financially distinct from the first party, said second party controlling use and in possession of the second memory;</p>	<p>Gallagher teaches the electronic transfer of money via a telecommunication line: Gallagher discloses "sale to the general public via their user units." (Gallagher at 1:49-50) Gallagher also discloses "home-buying of material" and "immediate access to material." (Gallagher at 2:92-93) Gallagher discloses that the telecommunication line is "high speed telephone links by way of modems. However, normal telephone links, fibre optic links, electro-magnetic waves or any other suitable medium may be used." (Gallagher at 1:28-31) Moreover, during prosecution of the '573 Patent, the inventor, Mr. Hair filed a declaration under 37 CFR § 1.132 where he stated "One skilled in the art would know that an electronic sale inherently assumes a transferring of money by providing a credit card number (since that is the only way for electronic sales to occur) coupled with a transferring of a service or product. The use of transferring money across telecommunication connections, such as by telephoning the agent who has the hard disc over the phone lines, for obtaining data on the hard disc is well known to one skilled in the art to be part of electronic sales." See '573 Patent File Wrapper, Paper No. 27 at 2. Gallagher teaches that the first party is at a location remote from the second memory, that the first party is in controlling use of the first memory and that the second party is in controlling use and in possession of the second memory: "The source unit (first party) could belong to a recording artist, the main unit (also called a database) to a major record company (first party) and user units to the general public (second party with the second memory)." (Gallagher at 1:44-46) The user unit/consumer can be at "home." (Gallagher at 2:92) The database (first memory) is "housed by a record company" (first party). (Gallagher at 1:7-10)</p>

Accordingly, Gallagher discloses at least a first and second party at remote locations. **Gallagher teaches that the first party and second party are financially distinct:** Gallagher discloses a "record company" that would provide the digital data "for sale to the general public." (Gallagher at 1:46-50). In addition, Hair admitted that "[o]ne skilled in the art would know since the music is distributed through electronic sale, 'the second party must be financially distinct from the first party' or there could be no sale." See '734 Patent File Wrapper, 1/3/94 Hair Decl., p. 3-4.

In addition, it would have been obvious to a person skilled in the art at the time to electronically sell digital audio and video signals via telecommunications lines. **Freeny** expressly discloses the combination of "selling electronically" digital audio and video signals over telecommunications lines. Freeny at 12:31-36 ("a consumer credit card number also might be communicated . . . so the owner of the information could approve the sale and, in effect, charge the sale to the consumer credit card number").

Hellman also discloses the combination of "selling electronically" digital audio and video signals over telecommunications lines. Hellman at 5:57-6:2 ("Base unit 12 generates and communicates to authorization and billing unit 13 a signal representing a user originated request for software use...BILLING INFORMATION is a credit car[d] number or similar means for billing the user of the software.").

Akashi also discloses the combination of "selling electronically" digital audio and video signals over telecommunications lines. Akashi at 1 (Akashi discloses an "Automated Music Purchasing System" which "communicates via telephone lines" and "sells recorded music via the telephone line."). Akashi at 2 (Akashi distinguishes the "conventional system of selling recorded music," that is, through "music sales outlets."). Akashi at 2, 5, Fig. 2 (the "automated music purchasing system network."). Akashi at 4 (a record company need "not require the current distribution channels" [music sales outlets] and thus the "user would be able to easily as well as freely search for and purchase desired music from home.").

Elmer-Dewitt also discloses the combination of "selling electronically" digital audio and video signals over telecommunications lines. Elmer-Dewitt at 69 ("Today anybody with a computer, a modem and a deep line of credit can buy an airline ticket to Cleveland, rent a Hertz car at the airport, book a room at the Sheraton, buy a novel from Waldenbooks, check the closing prices on Wall Street and purchase 100 shares of IBM—without ever getting up from the computer.")

Ferrarini also discloses the combination of "selling electronically" digital audio and video signals over telecommunications lines. Ferrarini ("If you decide to buy, you receive the software, complete with documentation, via your microcomputer and the telephone lines. . . . Recently, a handful of companies have established services that allow users to purchase software just this way. If they are successful, delivering software via the telephone will become a major method of distribution within the next few years.").

Gremillet also discloses the combination of "selling electronically" digital audio and video signals over telecommunications lines. Gremillet at 2:32, 52,

	<p>58, 3:4-22 (“subscribers,” “calls from subscribers”), Abstract (“vending recorded information”).</p> <p><u>See also</u> ‘573 Prosecution History, Paper No. 27 at 2.: “One skilled in the art would know that an electronic sale inherently assumes a transferring of money by providing a credit card number (since that is the only way for electronic sales to occur) coupled with a transferring of a service or product. The use of transferring money across telecommunication connections, such as by telephoning the agent who has the hard disc over the phone lines, for obtaining data on the hard disc is well known to one skilled in the art to be part of electronic sales.”</p> <p><u>See also</u> ‘573 Prosecution History, 5/5/94 IDS at 2 (Hair admits that “[t]his patent [U.S. Patent No. 4,789,863 to Bush] discloses a pay per view entertainment system.”).</p> <p><u>See also</u> ‘734 Prosecution History, 1/3/94 Hair Decl. at 5 (“[E]lectronic sales’ as disclosed refers to the well known practices of ‘transferring’ and verifying monies across telephone lines such as by a ‘credit card’; or by ‘charging a fee’ to the second party, so the second party can gain access to the first party’s memory through telecommunications lines to select the desired digital video or digital audio signals.”).</p> <p>Accordingly, the electronic sale of digital audio and video signals via telecommunications lines would have been obvious to one of ordinary skill in the art at the relevant time.</p>
<p>connecting electronically via a telecommunications line the first memory with the second memory such that the desired digital audio signal can pass therebetween;</p>	<p>Gallagher teaches connecting the first and second memories via the telecommunications line: Gallagher discloses that “[t]he media for data transfer is preferably high speed telephone links by way of modems. However, normal telephone links, fibre optic links, electro-magnetic waves or any other suitable medium may be used.” (Gallagher at 1:28-31) Gallagher discloses that “[t]he data is transferred from the source unit to the database where it is processed for storage in library form whereby selected data can be transmitted to any user and/or source unit in national or foreign territories.” (Gallagher at 1:39-43) The source unit, database and user units each have memories. (Gallagher at 1:67-69, 1:13-16, 1:21-22)</p>
<p>transmitting the desired digital audio signal from the first memory with a transmitter in control and possession of the first party to a receiver having the second memory at a location determined by the second party, said receiver in possession and control of the second party; and</p>	<p>Gallagher discloses transmitting the desired digital audio signal from the first memory with a transmitter in control and possession of the first party: a “transmitter/receiver” at the source unit (Gallagher at 1:74, Fig. 1) and at the database (Gallagher at 1:81-82, Fig. 2)”) to a receiver having the second memory in possession and control of the second party at a location determined by the second party: a “transmitter/ receiver” at the user unit (Gallagher at 1:87-88, Fig. 3). Because the transmitter/receiver is at the source unit or at the database, it is inherently in possession of the first party. Similarly, the transmitter/receiver at the user unit is in the possession and control of the second party where the location of the second party is “in national or foreign territories” (Gallagher at 1:42-43), and that the user unit/consumer (second party) can be at “home” (Gallagher at 2:92). Therefore the location of the receiver and second memory is determined by the second party.</p>
<p>storing the digital signal in the</p>	<p>Gallagher discloses the storing of the digital signal in the second</p>

second memory.	memory: Gallagher discloses a “user unit having . . . a means for storing/recalling and/or processing data received from the database.” (Gallagher at 1:21-22) Gallagher also discloses that “[t]he media for storage of data would be floppy disk, hard disk, optical or laser disk, magnetic tape, integrated circuit memory or any other suitable medium.” (Gallagher at 1:32-35).
2. A method as described in claim 1 including after the transferring step, the steps of searching the first memory for the desired digital audio signal; and selecting the desired digital audio signal from the first memory.	Gallagher discloses the steps of searching the first memory for the desired information (digital audio signal) after the transferring step and selecting the desired information from the first memory. Gallagher discloses that “[t]he user . . . can log on to the data base and make her/his selection according to a supplied menu.” (Gallagher at 1:102-104)
3. A method as described in claim 2 wherein the transferring step includes the steps of telephoning the first party controlling use of the first memory by the second party; providing a credit card number of the second party controlling the second memory to the first party controlling the first memory so the second party is charged money.	<p>Gallagher discloses that the transferring step includes the step of the second party “user unit/consumer” first telephoning the first party “source unit” or “database” controlling use of the first memory and providing the second party’s credit card number so the second party is charged money. See claim 1 above, Gallagher discloses “sale to the general public via their user units.” (Gallagher at 1:49-50) Gallagher also discloses “home-buying of material” and “immediate access to material.” (Gallagher at 2:92-93)</p> <p>In addition, it would have been obvious to a person skilled in the art at the time to electronically sell digital audio and video signals via telecommunications lines. Gallagher expressly discloses the combination of “selling electronically” digital audio and video signals over telecommunications lines. Gallagher at 1:49-50 (“sale to the general public via their user units,” “home-buying of material” and “immediate access to material”).</p> <p>Additionally, Freeny discloses the combination of “selling electronically” digital audio and video signals over telecommunications lines. Freeny at 12:31-36 (“a consumer credit card number also might be communicated . . . so the owner of the information could approve the sale and, in effect, charge the sale to the consumer credit card number”).</p> <p>Hellman also discloses the combination of “selling electronically” digital audio and video signals over telecommunications lines. Hellman at 5:57-6:2 (“Base unit 12 generates and communicates to authorization and billing unit 13 a signal representing a user originated request for software use. . . BILLING INFORMATION is a credit card number or similar means for billing the user of the software.”).</p> <p>Akashi also discloses the combination of “selling electronically” digital audio and video signals over telecommunications lines. Akashi at 1 (Akashi discloses an “Automated Music Purchasing System” which “communicates via telephone lines” and “sells recorded music via the telephone line.”). Akashi at 2 (Akashi distinguishes the “conventional system of selling</p>

	<p>recorded music," that is, through "music sales outlets."). Akashi at 2, 5, Fig. 2 (the "automated music <i>purchasing</i> system network."). Akashi at 4 (a record company need "not require the current distribution channels" [music sales outlets] and thus the "user would be able to easily as well as freely search for and <i>purchase desired music from home.</i>").</p> <p>Elmer-Dewitt also discloses the combination of "selling electronically" digital audio and video signals over telecommunications lines. Elmer-Dewitt at 69 ("Today anybody with a computer, a modem and a deep line of credit can buy an airline ticket to Cleveland, rent a Hertz car at the airport, book a room at the Sheraton, buy a novel from Waldenbooks, check the closing prices on Wall Street and purchase 100 shares of IBM—without ever getting up from the computer.")</p> <p>Ferrarini also discloses the combination of "selling electronically" digital audio and video signals over telecommunications lines. Ferrarini ("If you decide to buy, you receive the software, complete with documentation, via your microcomputer and the telephone lines. . . . Recently, a handful of companies have established services that allow users to purchase software just this way. If they are successful, delivering software via the telephone will become a major method of distribution within the next few years.").</p> <p>Gremillet also discloses the combination of "selling electronically" digital audio and video signals over telecommunications lines. Gremillet at 2:32, 52, 58, 3:4-22 ("subscribers," "calls from subscribers"), Abstract ("vending recorded information").</p> <p><u>See also</u> '573 Prosecution History, Paper No. 27 at 2.: "One skilled in the art would know that an electronic sale inherently assumes a transferring of money by providing a credit card number (since that is the only way for electronic sales to occur) coupled with a transferring of a service or product. The use of transferring money across telecommunication connections, such as by telephoning the agent who has the hard disc over the phone lines, for obtaining data on the hard disc is well known to one skilled in the art to be part of electronic sales."</p> <p><u>See also</u> '573 Prosecution History, 5/5/94 IDS at 2 (Hair admits that "[t]his patent [U.S. Patent No. 4,789,863 to Bush] discloses a pay per view entertainment system.").</p> <p><u>See also</u> '734 Prosecution History, 1/3/94 Hair Decl. at 5 ("'[E]lectronic sales' as disclosed refers to the well known practices of 'transferring' and verifying monies across telephone lines such as by a 'credit card'; or by 'charging a fee' to the second party, so the second party can gain access to the first party's memory through telecommunications lines to select the desired digital video or digital audio signals.").</p> <p>Accordingly, the electronic sale of digital audio and video signals via telecommunications lines would have been obvious to one of ordinary skill in the art at the relevant time.</p>
4. A method for transmitting a	See claim 1 above. Gallagher further discloses that information transmitted

desired digital video signal stored on a first memory of a first party to a second memory of a second party comprising the steps of:	includes digital video. (Gallagher at 1:5, 1:8, 1:6-7, 1:91, Figs. 2 & 3)
transferring money electronically via a telecommunications line to the first party at a location remote from the second memory and controlling use of the first memory, from a second party financially distinct from the first party, said second party in control and in possession of the second memory;	See claim 1 above.
connecting electronically via a telecommunications line the first memory with the second memory such that the desired digital video signal can pass therebetween;	See claim 1 above. Gallagher further discloses that information transmitted includes digital video signals. (Gallagher at 1:5, 1:8, 1:6-7, 1:91, Figs. 2 & 3)
transmitting the desired digital video signal from the first memory with a transmitter in control and possession of the first party to a receiver having the second memory at a location determined by the second party, said receiver in possession and control of the second party; and	See claim 1 above. Gallagher further discloses that information transmitted includes digital video signals. (Gallagher at 1:5, 1:8, 1:6-7, 1:91, Figs. 2 & 3)
storing the digital signal in the second memory.	See claim 1 above. Gallagher further discloses that information transmitted includes digital video signals. (Gallagher at 1:5, 1:8, 1:6-7, 1:91, Figs. 2 & 3)
5. A method as described in claim 4 including after the transferring money step, the step of searching the first memory for the desired digital signal and selecting the desired digital signal from the first memory.	See claim 2 above. Gallagher further discloses that information stored, searched and selected from the first memory includes digital video signals. (Gallagher at 1:5, 1:8, 1:6-7, 1:91, Figs. 2 & 3)
6. A method as described in claim 5 wherein the transferring step includes the steps of telephoning the first party controlling use of the first memory by the second party controlling the second memory; providing a credit card number of the second party controlling the	See claim 3 above.

second memory to the first party controlling the first memory so the second party controlling the second memory is charged money.	
--	--

B. GREMILLET (U.S. Pat. No. 4,499,568): Claims 1 – 6 of the Hair '573 Patent Are Anticipated Under 35 U.S.C. § 102 by Gremillet and/or Are Rendered Obvious Under 35 U.S.C. § 103 by Gremillet in view of Gallagher, Freeny, Akashi, Hellman, Elmer-Dewitt or Ferrarini.

Gremillet (US 4,499,568) was filed on December 13, 1982 in the United States and has a foreign application priority date of December 16, 1981 (France). Gremillet issued on February 12, 1985, prior to the earliest filing date of June 13, 1988 of the Hair patents. It was not cited during the prosecution of the '573 patent. Accordingly, Gremillet is prior art to the Hair patents.

Gremillet teaches a process and system for vending recorded information over telecommunications lines. Gremillet at Abstract. The system includes forming a connection through telecommunication lines between a first memory of a first party and a second memory of a second party, the first memory having the recorded information including digital audio, selling by the first party to the second party through the telecommunications lines the desired digital audio or video signals, transferring the desired digital signals from the first party to the second party through the telecommunications lines while the second memory is in possession and control of the second party (at a remote location) and storing the digital signals in the second memory.

Gremillet specifically teaches vending digital audio. Gremillet at 2:29-31. The telecommunications lines include broadcast means, such as antennae, optical fibres, cables and telephone lines. Gremillet at 4:1-7 and Claim 5. Individual musical works are kept at a vendor's location in a first memory (an "information bank"). Users request musical works from this distribution center and the distribution center transmits the requested songs to them, all over telecommunications lines. The user equipment magnetically records the incoming audio material

onto a memory. Moreover, Gremillet teaches the playback of audio from this memory medium. Gremillet at Fig. 1 (sound restoration system with speakers). Further, Gremillet discloses the well known componentry described by Hair, such as control integrated circuits and random access memory. Gremillet at Fig. 2.

While Gremillet does not specifically detail the use of credit cards for vending digital audio signals, these means would have been generally known to one of ordinary skill in the art. In prosecution, Hair himself relied on “the well known practices of ‘transferring’ and verifying monies across telephone lines such as by a ‘credit card’; or by ‘charging a fee’ to the second party, so the second party can gain access to the first party’s memory through telecommunications lines to select the desired digital video or digital audio signals,” to overcome a rejection for inadequate written description. ‘734 Prosecution History, 1/3/94 Hair Decl., p. 5. Moreover, such details would have been obvious in light of Gallagher, Freeny and Ferrarini.

Though Gremillet’s preferred embodiment is specifically related to digital audio, the specification broadly teaches “vending recorded information.” Thus, in view of other references such as Gallagher and Rosch, Gremillet renders digital video obvious. Moreover, in prosecution Hair admitted that the electronic sale of digital video was well known. ‘734 Prosecution History, 1/3/94 Hair Decl., p. 5. (referring to “the well known practices of ‘transferring’ and verifying monies across telephone lines such as by a ‘credit card’; or by ‘charging a fee’ to the second party, so the second party can gain access to the first party’s memory through telecommunications lines to select the desired digital video or digital audio signals,” in order to overcome a rejection for lack of written description.)

Accordingly, the Gremillet patent raises substantial new questions of patentability of the Hair ‘573 patent.

U.S. PAT. NO. 4,499,568 TO GREMILLET

Claim	Prior Art Disclosure Rendering Hair Anticipated or Obvious, Including Motivation to Combine
<p>1. A method for transmitting a desired digital audio signal stored on a first memory of a first party to a second memory of a second party comprising the steps of:</p>	<p>Gremillet teaches a method for transmitting a desired <u>digital audio</u> signal from a <u>first memory</u> of a first party to a <u>second memory</u> of a <u>second party</u>. Gremillet discloses a distribution centre, which “comprises a bank of musical recordings.” 3:38-39, Fig. 1. <i>See</i> Fig. 1 (“Information bank” 11); 3:4-6 (“a distribution center comprising an information recording bank...”). The distribution centre stores the recordings on disk or tape. <i>See</i> 3:40-41 (“video disk or a video recorder”). Gremillet discloses “user equipment [that] comprises ... a video recorder.” 3:55-56. <i>See</i> Fig. 1 (“Video Recording” 23); 4:37-37. (“The recording can be kept on the video recorder for the purpose of listening to it later...”).</p>
<p>transferring money electronically via a telecommunication lien to the first party at a location remote from the second memory and controlling use of the first memory from the second party financially distinct from the first party, said second party controlling use and in possession of the second memory;</p>	<p>Gremillet discloses a memory at, a distribution centre (<u>first party</u>), which “comprises a bank of musical recordings.” 3:38-39. <i>See</i> Fig. 1 (“Information bank” 11); 3:4-6 (“a distribution center comprising an information recording bank...”). The distribution centre stores the recordings on disk or tape. <i>See</i> 3:40-41 (“video disk or a video recorder”).</p> <p>Gremillet discloses a memory at the <u>second party</u> (the user). <i>See</i> 3:55-56 (“user equipment [that] comprises ... a video recorder.”) <i>See</i> Fig. 1 (“Video Recording” 23); 4:37-37. (“The recording can be kept on the video recorder for the purpose of listening to it later...”).</p> <p>As a distributor of digital audio data over telecommunications lines and his or her users would be engaged in a commercial transaction, that the two parties were <u>financially distinct</u> would be inherent. Hair himself argued this very point during prosecution. <i>See</i> Prosecution history for the ‘734 patent, 1/3/94 Hair Decl., p. 3-4 (“One skilled in the art would know since the music is distributed through electronic sale, ‘the second party must be financially distinct from the first party’ or there could be no sale.”).</p> <p>The distribution centre and user were <u>remote</u>. <i>See</i> 1:8-10 (“The present invention relates to a process for the teledistribution or <i>remote</i> distribution of recorded information or data and to a system for performing the process.”) (emphasis added).</p> <p>Moreover, Gremillet teaches vending recorded information over telecommunication lines and a person of skill in the art would know that telephone lines connect parties residing at <u>remote locations</u>. Hair himself argued this point during prosecution. <i>See</i> Prosecution history for the ‘573 patent, 6/25/92 Amendment, p. 15 (“the memories are at different locations and by being connected by telecommunication lines have to be remote.”).</p> <p>Gremillet’s invention relates to “vending” recorded information. Abstract. As vending is the same as “sale” Gremillet taught the <u>sale of digital audio</u>. Furthermore, the fact that Gremillet mentions “subscribers”</p>

	<p>throughout his patent indicates he envisioned a commercial format for his invention. Moreover, the fact that Gremillet sought a patent entails that he intended for digital audio signals to be sold. If he had no commercial intentions then a patent would have been unnecessary.</p> <p>In addition, it would have been obvious to a person skilled in the art at the time to electronically <u>sell</u> digital audio and video signals via telecommunications lines. Gallagher expressly discloses the combination of “selling electronically” digital audio and video signals over telecommunications lines. Gallagher at 1:49-50 (“sale to the general public via their user units,” “home-buying of material” and “immediate access to material”).</p> <p>Additionally, Freeny discloses the combination of “selling electronically” digital audio and video signals over telecommunications lines. Freeny at 12:31-36 (“a consumer credit card number also might be communicated . . . so the owner of the information could approve the sale and, in effect, charge the sale to the consumer credit card number”).</p> <p>Hellman also discloses the combination of “selling electronically” digital audio and video signals over telecommunications lines. Hellman at 5:57-6:2 (“Base unit 12 generates and communicates to authorization and billing unit 13 a signal representing a user originated request for software use...BILLING INFORMATION is a credit car[d] number or similar means for billing the user of the software.”).</p> <p>Akashi also discloses the combination of “selling electronically” digital audio and video signals over telecommunications lines. Akashi at 1 (Akashi discloses an “Automated Music <i>Purchasing</i> System” which “communicates via telephone lines” and “<i>sells</i> recorded music via the telephone line.”). Akashi at 2 (Akashi distinguishes the “conventional system of selling recorded music,” that is, through “music sales outlets.”). Akashi at 2, 5, Fig. 2 (the “automated music <i>purchasing</i> system network.”). Akashi at 4 (a record company need “not require the current distribution channels” [music sales outlets] and thus the “user would be able to easily as well as freely search for and <i>purchase desired music from home.</i>”).</p> <p>Elmer-Dewitt also discloses the combination of “selling electronically” digital audio and video signals over telecommunications lines. Elmer-Dewitt at 69 (“Today anybody with a computer, a modem and a deep line of credit can buy an airline ticket to Cleveland, rent a Hertz car at the airport, book a room at the Sheraton, buy a novel from Waldenbooks, check the closing prices on Wall Street and purchase 100 shares of IBM—without ever getting up from the computer.”)</p> <p>Ferrarini also discloses the combination of “selling electronically” digital audio and video signals over telecommunications lines. Ferrarini (“If you decide to buy, you receive the software, complete with documentation, via your microcomputer and the telephone lines. . . . Recently, a handful of companies have established services that allow users to purchase software just this way. If they are successful, delivering software via the telephone will become a major method of distribution within the next few years.”).</p>
--	--

	<p>See also '573 Prosecution History, Paper No. 27 at 2.: "One skilled in the art would know that an electronic sale inherently assumes a transferring of money by providing a credit card number (since that is the only way for electronic sales to occur) coupled with a transferring of a service or product. The use of transferring money across telecommunication connections, such as by telephoning the agent who has the hard disc over the phone lines, for obtaining data on the hard disc is well known to one skilled in the art to be part of electronic sales."</p> <p>See also '573 Prosecution History, 5/5/94 IDS at 2 (Hair admits that "[t]his patent [U.S. Patent No. 4,789,863 to Bush] discloses a pay per view entertainment system.").</p> <p>See also '734 Prosecution History, 1/3/94 Hair Decl. at 5 ("[E]lectronic sales' as disclosed refers to the well known practices of 'transferring' and verifying monies across telephone lines such as by a 'credit card'; or by 'charging a fee' to the second party, so the second party can gain access to the first party's memory through telecommunications lines to select the desired digital video or digital audio signals.").</p> <p>Accordingly, the electronic sale of digital audio and video signals via telecommunications lines would have been obvious to one of ordinary skill in the art at the relevant time.</p>
<p>connecting electronically via a telecommunications line the first memory with the second memory such that the desired digital audio signal can pass there between;</p>	<p>Gremillet at Fig. 1 shows the first memory and second memory connected via a transmission channel (consisting of broadcast, cable or optical fibre (4:3-7)) and by a telephone line.</p> <p>Gremillet covers digital audio, a technology considered conventional at the time of Gremillet's patent. See 1:11-12 ("The scope of the application relates to the teledistribution of musical works..."); 2:29-31 "However, from the structural standpoint it involves conventional digital or analog signal..."; 2:67-68 ("The message can be transmitted in either analog or digital manner"); see also 5:1-4; Claim 3 ("wherein the transmission of the message takes place in a digital manner."); along with Claims 1 ("corresponding to sound") and 4 ("the information consists of musical works").</p>
<p>transmitting the desired digital audio signal from the first memory with a transmitter in control and possession of the first party to a receiver having the second memory at a location determined by the second party, said receiver in possession and control of the second party; and</p>	<p>Gremillet's disclosure of a "transmission channel" and telephone lines anticipates the <u>transmission of digital audio</u> and video signals over telecommunications lines and telephone lines in the '573 patent. See 2:57-59 ("transmitting to the requesting subscriber the said message by means of a transmission channel"); Fig. 1 (transmission channel; telephone network). See also, 3:18-23; 34-36; 4:1-7 ("Transmission channel is able to transmit data from the distribution centre to each of the subscribers equipment. The flow rate is at least 50Mbits/s. It can comprise broadcasting means consisting of a transmitter, a transmitting antenna, a receiving antenna, or a cable or optical fibres."); Claim 5 ("a means for connecting subscribers to the distribution centre via a telephone network.").</p> <p>Gremillet's disclosure of "subscriber equipment" (3:11) and "user equipment" (3:55) anticipates distribution to a <u>location determined by the second party</u>, as claimed by Hair. Claim 1 ("in equipment housed with</p>

	<p>the requesting subscriber”).</p> <p>In any event, the <u>location determined by the second party</u> limitation was added into the specification of the ‘573 and related patents in a response to office action. Specification support was only added later. <i>See</i> Prosecution history for the ‘734 patent, January 3, 1994 Amendment (“1/3/94 Amendment”), p. 6 (“The second party control unit 50 is placed by the second party location determined by the second party which is remote from the first party control unit 20.”) If this limitation were not “inherent” it would be new matter. As there has been no finding yet that this limitation represents new matter, it must be understood to be within the knowledge of one of ordinary skill.</p>
<p>storing the digital signal in the second memory.</p>	<p>Gremillet discloses the storage of audio at the user’s terminal. <i>See</i> 2:21-22 (teaching that the user equipment should store audio signals on “an apparatus generally suitable for recording picture signals”); 4:23-25 (“The information received by [user] equipment is then transmitted to magnetoscope, where it is recorded at the fast speed.”).</p>
<p>2. A method as described in claim 1 including after the transferring step, the steps of searching the first memory for the desired digital audio signal; and selecting the desired digital audio signal from the first memory.</p>	<p>Searching for and selecting the desired digital audio signal are anticipated by Gremillet. Gremillet teaches searching the supplier’s memory for particular selections. <i>See</i> 4:12-20 (“The user wishing to listen to a work belonging to the collection recorded in the centre 10 supplies the latter with the references of the chosen work by means of the telephone line...Centre selects the chosen work, reads it and transmits...”).</p> <p>It would be obvious to a person skilled in the art that a user could select from choices in the distribution center’s memory. This is admitted in Hair’s own prosecution history. <i>See</i> Prosecution history for the ‘734 patent, 1/3/94 Hair Decl., p. 5 (“[E]lectronic sales’ as disclosed refers to the <u>well known practices</u> of ‘transferring’ and verifying monies across telephone lines such as by a ‘credit card’; or by ‘charging a fee’ to the second party, so the second party can gain access to the first party’s memory through telecommunications lines to <u>select</u> the desired digital video or digital audio signals.”) (emphasis added).</p> <p>Ferrarini discloses the perusal of the supplier’s (first party’s) memory for selecting software. 37 (“TSC transactions are initiated by contacting the demonstration bulletin board...After furnishing your name, address, telephone number, and credit card number (Mastercard, VISA, or American Express) you can peruse a catalog of software descriptions and prices...”). It would have been obvious to combine Ferrarini’s teachings re: searching and selecting software with Gremillet, because a person of ordinary skill in the art would have known that digital audio was substitutable for software. <i>See</i> ‘440 Prosecution History, 1/4/96 Office Action at 4 (“[O]ne of ordinary skill in the art, based on common knowledge and common sense, would be able to recognize a substitution of the contents of the software program signals with audio/video signals.”).</p> <p>Gallagher discloses that “[t]he user . . . can log on to the data base and make her/his selection according to a supplied menu.” (Gallagher at 1:102-104)</p>

<p>3. A method as described in claim 2 wherein the transferring step includes the steps of telephoning the first party controlling use of the first memory by the second party; providing a credit card number of the second party controlling the second memory to the first party controlling the first memory so the second party is charged money.</p>	<p>The use of a credit card number over telephone lines would have been obvious to one of skill in the art.</p> <p><u>See</u> '734 Prosecution History, 1/3/94 Hair Decl. at 5 (“[E]lectronic sales’ as disclosed refers to the <u>well known practices</u> of ‘transferring’ and verifying monies across telephone lines such as by a ‘credit card’; or by ‘charging a fee’ to the second party, so the second party can gain access to the first party’s memory through telecommunications lines to select the desired digital video or digital audio signals.”).</p> <p><u>See</u> '573 Prosecution History, Paper No. 27 at 2.: “One skilled in the art would know that an electronic sale inherently assumes a transferring of money by providing a credit card number (since that is the only way for electronic sales to occur) coupled with a transferring of a service or product. The use of transferring money across telecommunication connections, such as by telephoning the agent who has the hard disc over the phone lines, for obtaining data on the hard disc is well known to one skilled in the art to be part of electronic sales.”</p> <p>Gallagher expressly discloses the combination of “selling electronically” digital audio and video signals over telecommunications lines. Gallagher at 1:49-50 (“sale to the general public via their user units,” “home-buying of material” and “immediate access to material”).</p> <p>Additionally, Freeny discloses the combination of “selling electronically” digital audio and video signals over telecommunications lines. Freeny at 12:31-36 (“a consumer credit card number also might be communicated . . . so the owner of the information could approve the sale and, in effect, charge the sale to the consumer credit card number”).</p> <p>Hellman also discloses the combination of “selling electronically” digital audio and video signals over telecommunications lines. Hellman at 5:57-6:2 (“Base unit 12 generates and communicates to authorization and billing unit 13 a signal representing a user originated request for software use...BILLING INFORMATION is a credit car[d] number or similar means for billing the user of the software.”).</p> <p>Akashi also discloses the combination of “selling electronically” digital audio and video signals over telecommunications lines. Akashi at 1 (Akashi discloses an “Automated Music <i>Purchasing System</i>” which “communicates via telephone lines” and “<i>sells</i> recorded music via the telephone line.”). Akashi at 2 (Akashi distinguishes the “conventional system of selling recorded music,” that is, through “music sales outlets.”). Akashi at 2, 5, Fig. 2 (the “automated music <i>purchasing system network</i>.”). Akashi at 4 (a record company need “not require the current distribution channels” [music sales outlets] and thus the “user would be able to easily as well as freely search for and <i>purchase desired music from home</i>.”).</p> <p>Elmer-Dewitt also discloses the combination of “selling electronically” digital audio and video signals over telecommunications lines. Elmer-Dewitt at 69 (“Today anybody with a computer, a modem and a deep line of credit can buy an airline ticket to Cleveland, rent a Hertz car at the airport, book a room at the Sheraton, buy a novel from Waldenbooks,</p>
--	--

	<p>check the closing prices on Wall Street and purchase 100 shares of IBM—without ever getting up from the computer.”)</p> <p>Ferrarini also discloses selling data electronically over telecommunications lines. Ferrarini (“If you decide to buy, you receive the software, complete with documentation, via your microcomputer and the telephone lines. . . . Recently, a handful of companies have established services that allow users to purchase software just this way. If they are successful, delivering software via the telephone will become a major method of distribution within the next few years.”).</p> <p><u>See also</u> ‘573 Prosecution History, 5/5/94 IDS at 2 (Hair admits that “[t]his patent [U.S. Patent No. 4,789,863 to Bush] discloses a pay per view entertainment system.”).</p> <p>Accordingly, the electronic sale of digital audio and video signals via telecommunications lines would have been obvious to one of ordinary skill in the art at the relevant time.</p>
<p>4. A method for transmitting a desired digital video signal stored on a first memory of a first party to a second memory of a second party comprising the steps of:</p>	<p>All limitations of this claim except for <u>digital video</u> are found in Claim 1 above. The repeated limitations are anticipated by Gremillet for the reasons stated above. The application of Gremillet’s invention to <u>digital video</u> would have been obvious to one of ordinary skill in the art.</p>
<p>transferring money electronically via a telecommunications line to the first party at a location remote from the second memory and controlling use of the first memory, from a second party financially distinct from the first party, said second party in control and in possession of the second memory;</p>	<p>Rosch discloses “digital video” transfer via telecommunications lines. Rosch at 228 (discussing “Networking Video” using “Video Van Gogh” product; “A digitized picture can also be sent—albeit very slowly, very slowly—over a standard telephone line using the ComNet modem.”). Moreover it teaches “a synthesis of many divergent branches of personal computing, networks (Ethernet), a modem, <u>voice and video communication</u>...”. Rosch at 226. As both sound and video once digitized are nothing more than data, they could be transferred using the same means. Rosch at 228 (“The resulting picture is handled by both computer and ComNet as regular data.”) Thus, the interchangeability of digital audio and video was well known within the art, providing a motivation to combine the teachings of Rosch with those of Gremillet.</p>
<p>connecting electronically via a telecommunications line the first memory with the second memory such that the desired digital video signal can pass therebetween;</p>	<p>Jordan also discloses the combination of the combination of “digital video” transfer via telecommunications lines. Jordan at 174 (“[In Britain] VIDEOTEX uses the equally familiar telephone system to interactively communicate information. . . . [I]n the case of VIDEOTEX, stand-alone computers can be adapted to receive alphanumeric or graphics information. . . . Alphaphotographic technology allows the transmission of photo quality images and is being developed as a follow-on capability for all VIDEOTEX systems.”).</p>
<p>transmitting the desired digital video signal from the first memory with a transmitter in control and possession of the first party to a receiver having the second memory at a location determined by the second party, said receiver in possession and control of the second party; and</p>	<p>Elmer-Dewitt also discloses “digital video” transfer via telecommunications lines. Elmer-Dewitt at 69 (“The FBI prints descriptions of its ten most wanted criminals, complete with digitized</p>

<p>storing the digital signal in the second memory.</p>	<p>descriptions of its ten most wanted criminals, complete with digitized mug shots for quick identification.”).</p> <p><u>See</u> ‘440 Prosecution History, 1/4/96 Office Action at 4 (“Ogaki et al discloses all that is claimed except that he does not disclose transferring audio or video signals. However he does disclose transferring the software programs through telecommunication lines for distributing or selling these programs to consumers. Lightner discloses transferring audio/video signals through telecommunications lines for distributing or selling to purchasers. It would have been obvious to one of ordinary skill in the art to transfer or sell[] distribute audio/video signals in the system and method taught by Ogaki et al. It would have been obvious because one of ordinary skill in the art, based on common knowledge and common sense, would be able to recognize a substitution of the contents of the software program signals with audio/video signals.”).</p> <p>Gallagher expressly discloses “digital video” transfer via telecommunications lines. Gallagher at 1:5, 1:8, 1:6-7, 1:91, Figs. 2 & 3 (Gallagher discloses the transfer of desired digital video audio in a “recorded data transfer system” of “digital data” in the “entertainment industry” such as “audio or <i>visual</i>” data.) Gallagher also expressly discloses a “video display.” Gallagher at Fig. 3 (“audio/video conversion”). Gallagher at 1:90-92 (“suitable conversion apparatus 34 for audio and/or visual reproduction”).</p> <p>Additionally, Freeny also expressly discloses “digital video” transfer via telecommunications lines. Freeny at 1:10-14, 6:32-37 (“Information embodied in recordings . . . video games, motion pictures, software . . . electronic games . . . and the like,” “received on the input line 16 may be in an analog format or in a digital format.”).</p> <p>Accordingly, “digital video” transfer via telecommunications lines would have been obvious to one of ordinary skill in the art at the relevant time.</p>
<p>5. A method as described in claim 4 including after the transferring money step, the step of searching the first memory for the desired digital signal and selecting the desired digital signal from the first memory.</p>	<p>All limitations of this claim except for digital video are found in Claim 2 above. The repeated limitations are anticipated by Gremillet for the reasons stated in Claim 2 above and the digital video limitation is anticipated and/or obvious for the reasons provided in Claim 4 above.</p>
<p>6. A method as described in claim 5 wherein the transferring step includes the steps of telephoning the first party controlling use of the first memory by the second party controlling the second memory; providing a credit card number of the second party controlling the second memory to the first party controlling the first memory so the second party controlling the second memory is charged money.</p>	<p>All limitations of this claim except for digital video are found in Claim 3 above. The repeated limitations are anticipated by Gremillet for the reasons stated in Claim 3 above and the digital video limitation is anticipated and/or for the reasons provided in Claim 4 above.</p>

C. FREENY, JR. (U.S. Pat. No. 4,528,643): Claims 1 – 6 of the Hair '573 Patent Are Anticipated Under 35 U.S.C. § 102 by Freeny.

Freeny was not cited or considered by the Examiner during the prosecution of the Hair '573 Patent. The Freeny patent was cited and considered during the subsequent prosecution of the related Hair '440 patent. During prosecution of the Hair '440 patent, the Examiner issued a final rejection of all claims based on the Freeny patent. In response to this final rejection, Hair filed an appeal and argued a contrary construction of the Freeny patent by a district court in a patent infringement action brought by the owner of the Freeny patent against Compuserve. Interactive Gift Express, Inc. v. Compuserve Inc., see '440 Patent File Wrapper, Paper 17, p. 41. Relying on the district court's construction of the Freeny patent, the Examiner then allowed the Hair patent to issue. Subsequent thereto, however, the Federal Circuit reversed the district court's construction of the Freeny patent that the Examiner had relied upon in allowing the Hair '440 patent to issue. Accordingly, the very basis on which the Examiner distinguished Freeny and allowed the '440 patent to issue over it, was rejected by the Federal Circuit.

Accordingly, Freeny presents substantial new questions of patentability with respect to the '573 patent, for which Freeny has never been considered by the Examiner.¹

For a more in depth analysis of the history of the Freeny patent and its consideration by the Examiner during the prosecution of the '440 patent, the District Courts and the Federal Circuit, please see the accompanying Appendix A.

¹ In SightSound.com Incorporated v. N2K, Inc., CDnow, Inc., and CDnow Online, Inc., Civil Action No. 98-0118, (W.D. Penn. 1998), a district court denied summary judgment on the issue of whether Freeny anticipates the '734 and '440 patents, however, this determination is of limited relevance for purposes of this Reexamination proceeding. First, on a motion for summary judgment, the district court is precluded from making factual determinations regarding anticipation, and is required to deny summary judgment if there are genuine issues of material fact. In contrast, the PTO is vested with the authority to make factual determinations regarding anticipation and/or obviousness. Second, the district court's ruling did not address whether Freeny anticipated the '573 patent, as this Request does, since the Freeny patent was not before the court at that time.

U.S. PATENT NO. 4,528,643 TO FREENY

Claim	Prior Art Disclosure Rendering Hair Anticipated or Obvious, Including Motivation to Combine
<p>1. A method for transmitting a desired digital audio signal stored on a first memory of a first party to a second memory of a second party comprising the steps of:</p>	<p>Freeny teaches a method of transmitting "information," including digital audio signals (Freeny, Fig. 1, Col. 1:10-14, 6:32-37, 11:19-21, 24:8-10) stored on a first memory of a first party (Freeny Fig. 1, Col. 5:1-4, "an information control machine 14 that stores encoded information") to a second memory of a second party (Freeny Fig. 1, Col. 5:35-39, 13:25-36; 13:31-36, "an information manufacturing machine 14 constructed to store received encoded information"); <i>See also</i>, '440 Patent File Wrapper, Paper 7, pp. 2-3.</p>
<p>transferring money electronically via a telecommunication lien [sic] to the first party at a location remote from the second memory and controlling use of the first memory from the second party financially distinct from the first party, said second party controlling use and in possession of the second memory;</p>	<p>Freeny discloses the electronic transfer of money via a telecommunication line (Freeny 21:56-60 "communication link 18 is a transmission type of communication such as a transmission over the airways for via telephone lines") from the second party "consumer" to the first party "owner" that are financially distinct from one another (Freeny Col. 13:25-36, "It should be noted that additional data also can be communicated . . . [f]or example, a consumer credit card number also might be communicated . . . so the owner of the information could approve the sale and, in effect, charge the sale to the consumer credit card number." Freeny Col. 13:31-36, "If a consumer desired to pay cash, the owner of the point of sale location could input the owner's credit card number so the owner of the information could approve the sale and, in effect, charge the sale to the credit card number of the owner of the point of sale location."), such that the first party is in controlling use of the first memory at a location that is remote from the second memory (Freeny Fig. 1, Col. 5:1-4, 5:32-50, <i>see also</i>, <i>IGE</i>, 256 F.3d 1323, 1333 the information control machine, which is located at a location remote from the point of sale location (IMM) is in controlling use of the first party (owner of the information) which approves or disapproves requests for information from the consumer and, if approves the request, authorizes transmission and reproduction of information requested by the consumer, and the second party is in controlling use and in possession of the second memory (Freeny Col. 13:14-17 "a consumer selects a particular record album for purchase, for example, the catalog code and the IMM code are inputted into the manufacturing control unit" Freeny Fig. 1, Col. 5:32-50, "each of the information manufacturing machines 14 is located at a point of sale location . . . at a remote location with respect to the information control machine 12." The Federal Circuit held that based on the claims and specification of Freeny, a home can be a point of sale location. <i>See IGE</i>, 256 F.3d 1323, 1333. Accordingly, a consumer is in possession and control of the memory at either his home computer or the IMM from which he is purchasing the information for transmission. Freeny Col. 5:47-50 "The point of sale location is a location where a consumer goes to purchase material objects embodying predetermined or preselected information.").</p>
<p>connecting electronically via a telecommunications line the first memory with the second memory such that the desired digital audio signal can pass therebetween;</p>	<p>Freeny discloses a first memory "information control machine 12" connected electronically via a telecommunications line "communications link" to the second memory "information manufacturing machine" such that desired digital audio signals can pass therebetween. (Freeny, Fig. 1, Col. 5:18-21 the information control machine 12 provides the information stored therein for communication to particular information manufacturing</p>

**REQUEST FOR REEXAMINATION
OF U.S. PATENT NO. 5,191,573**

	<p>stored therein for communication to particular information manufacturing machines 12 via the communication link 18. Freeny Col. 21:57-60 "the communication link 18 is a transmission type of communication such as a transmission over the airways or via telephone lines or via television cables." Freeny, Col.1:10-14, 32-37, 11:19-21, 24:8-10 "Information embodied in recordings . . . video games, motion pictures, software . . . electronic games . . . and the like." See 1:10-14. "The information received on the input line 16 may be in an analog format or in a digital format. If the information on line 16 is in an analog format, the information transform unit 26 initially converts the received information from the analog format to a digital format." Fig. 1, col. 6:32-37. "Information embodied in recordings also may be in a digital form." Col 11:19-21. "Referring to the example of information embodied in recordings, high quality music requires a bandwidth of 20KHz and, when digitized. . . ." Col. 24:8-10.).</p>
<p>transmitting the desired digital audio signal from the first memory with a transmitter in control and possession of the first party to a receiver having the second memory at a location determined by the second party, said receiver in possession and control of the second party; and</p>	<p>Freeny discloses transmitting the desired digital audio signal from the first memory with a transmitter in control and possession of the first party (Freeny Fig. 1, Col. 7:53-62 "the information file unit 28 [of the information control unit 12] is constructed and adapted . . . to provide this encoded information along with the IMM code on the communication link 20 for communication to the information manufacturing machine 14." Freeny, Col. 8:40-42 "the information file unit 28 [of the information control unit 12] is adapted to communicate all of the information stored therein") to a receiver having the second memory in possession and control of the second party at a location determined by the second party (Freeny, Fig. 1, Col. 9:39-41 "the master file unit 32 [of the information manufacturing machine 14] is constructed and adapted to receive encoded information." Col. 5:47-50 "The point of sale location is a location where a consumer goes to purchase material objects embodying predetermined or preselected information.").</p>
<p>storing the digital signal in the second memory.</p>	<p>Freeny discloses the storing of the digital signal in the second memory (Freeny Fig. 1, Col. 5:35-39, 13:25-36; 13:31-36, "an information manufacturing machine 14 constructed to store received encoded information").</p>
<p>2. A method as described in claim 1 including after the transferring step, the steps of searching the first memory for the desired digital audio signal; and selecting the desired digital audio signal from the first memory.</p>	<p>Freeny discloses the steps of searching the first memory for the desired information (digital audio signal) after the transferring step and selecting the desired information from the first memory. (Freeny Col. 13:25-36, discloses that additional information such as a consumer credit card number can be communicated with each request reproduction code. Once the first memory receives the consumer credit card number and the order is accepted, thereby completing the transferring step, the information control machine is searched for the desired information (digital audio signal)).</p>
<p>3. A method as described in claim 2 wherein the transferring step includes the steps of telephoning the first party controlling use of the first memory by the second party;</p>	<p>Freeny discloses that the transferring step includes the step of the second party "consumer" first telephoning the first party "owner" controlling use of the first memory and providing the second party's credit card number so the second party is charged money. (See claim 1 above, Freeny Col. 13:25-36, "It should be noted that additional data also can be</p>

providing a credit card number of the second party controlling the second memory to the first party controlling the first memory so the second party is charged money.	communicated . . . [f]or example, a consumer credit card number also might be communicated . . . so the owner of the information could approve the sale and, in effect, charge the sale to the consumer credit card number.” Freeny Col. 13:31-36, “If a consumer desired to pay cash, the owner of the point of sale location could input the owner’s credit card number so the owner of the information could approve the sale and, in effect, charge the sale to the credit card number of the owner of the point of sale location.”).
4. A method for transmitting a desired digital video signal stored on a first memory of a first party to a second memory of a second party comprising the steps of:	See claim 1 above. Freeny further discloses that information transmitted includes digital video. Freeny, Col. 3:36-40; 3:62-64; 6:32-37, 11:19-21, 16:42-46.
transferring money electronically via a telecommunications line to the first party at a location remote from the second memory and controlling use of the first memory, from a second party financially distinct from the first party, said second party in control and in possession of the second memory;	See claim 1 above.
connecting electronically via a telecommunications line the first memory with the second memory such that the desired digital video signal can pass therebetween;	See claim 1 above. Freeny further discloses that information transmitted includes digital video signals. Freeny, Col. 3:36-40; 3:62-64; 6:32-37, 11:19-21, 16:42-46.
transmitting the desired digital video signal from the first memory with a transmitter in control and possession of the first party to a receiver having the second memory at a location determined by the second party, said receiver in possession and control of the second party; and	See claim 1 above. Freeny further discloses that information transmitted includes digital video signals. Freeny, Col. 3:36-40; 3:62-64; 6:32-37, 11:19-21, 16:42-46.
storing the digital signal in the second memory.	See claim 1 above. Freeny further discloses that information stored in the second memory includes digital video signals. Freeny, Col. 3:36-40; 3:62-64; 6:32-37, 11:19-21, 16:42-46.
5. A method as described in claim 4 including after the transferring money step, the step of searching the first memory for the desired digital signal and selecting the desired digital signal from the first	See claim 2 above. Freeny further discloses that information stored, searched and selected from the first memory includes digital video signals. Freeny, Col. 3:36-40; 3:62-64; 6:32-37, 11:19-21, 16:42-46.

memory.	
6. A method as described in claim 5 wherein the transferring step includes the steps of telephoning the first party controlling use of the first memory by the second party controlling the second memory; providing a credit card number of the second party controlling the second memory to the first party controlling the first memory so the second party controlling the second memory is charged money.	See claim 3 above.

VII. CONCLUSION

The prior art documents referred to above were not of record in the file of the Hair '573 patent. Since the claims in the Hair patent are not patentable over these prior art documents, substantial new questions of patentability are raised. Further, these prior art documents are closer to the subject matter of Hair than any prior art cited during the prosecution of the Hair patent. These prior art documents provide disclosures and teachings not considered during the prosecution of the Hair patent.

In view of the above, it is respectfully requested that reexamination be granted based upon the substantial new questions of patentability presented. It is further respectfully requested that each of claims 1 through 6 be rejected over the prior art for the reasons specified above.

Dated: January 31, 2005

Respectfully submitted,
MARTINE PENILLA & GENCARELLA, LLP



Albert S. Penilla (for third-party requester)
Reg. No. 39,487

710 Lakeway Drive, Suite 200
Sunnyvale, CA 94085
(408) 749-6900
Customer No. 25920

APPENDIX A

The Freeny Prior Art Reference - U.S. Patent No. 4,528,643 ("Freeny")

Freeny, U.S. Patent No. 4,528,643, anticipates the Hair Patents based on an intervening decision by the Federal Circuit reversing the claim construction of Freeny that Hair and the Examiner relied upon to allow the '440 patent to issue. As explained in detail below, notwithstanding Hair's attempts to distinguish Freeny, the Examiner repeatedly rejected the '440 patent as obvious in light of Freeny. Subsequent thereto, and during the course of litigation involving Freeny, a New York District Court construed Freeny in a manner that supported Hair's interpretation. Hair appealed the final rejection, relying on the District Court's ruling that was in support of Hair's interpretation of Freeny, and ultimately convinced the Examiner to withdraw his rejections based on Freeny. However, after issuance of the '440 patent, the Court of Appeals for the Federal Circuit reversed the very ruling by the District Court upon which Hair—and the Examiner—had relied to procure allowance of the '440 patent. Accordingly, with the grounds upon which Hair argued to overcome the Examiner's final rejection eviscerated by the Federal Circuit, Freeny stands to invalidate the '573 patent, especially since it was never raised during its prosecution.

U.S. Patent No. 5,966,440 to Hair, was filed June 6, 1995, as application no. 08/471,964 ("the '964 application") and issued October 12, 1999. During the prosecution of the '964 application in December 1995, Freeny was cited by the Examiner in a notice of references cited. In an office action dated January 4, 1996, the Examiner rejected all originally filed claims 1 through 31 as anticipated by Lightner and obvious over Ogaki in view of Lightner. Then, in a May 7, 1996 Examiner Interview Summary Record, the Examiner stated that "[a]pplicant explains the different concept between [] used invention and the teachings of prior art of record

(Lightner, Ogaki et al and Freeny, Jr.). Applicant will amend the independent claims to include different concept discussed.” See ‘440 File Wrapper, paper 4. In a July 3, 1996 amendment responsive to the January 4, 1996 office action and the examiner interview, Hair amended his claims and stated that the “key distinction and limitation” of the claimed invention and Freeny is that “the purchaser plays the information in the same machine which receives the information.” *Id.* at 58 (emphasis added). That is, “the second party control unit or apparatus or device or receiver which receives the signals has the capability of also playing the signals.” *Id.* at 57-58 (emphasis in original). Applicant further argued that the “claimed invention combines the transfer function with the playing function so a user does not have to go off somewhere else and play the information.” *Id.* at 59.

Thereafter, in an October 9, 1996 office action, in response to the amendment, the Examiner once again rejected all of the claims under 35 U.S.C. § 103 as being unpatentable over Freeny. The Examiner stated that “Freeny et al does not specifically teach the step of or a mechanism for ‘playing through speakers of the second party control unit the digital video or digital audio signals in the second memory.’” *Id.* at paper 7, p. 3. “The step of playing the video or audio digital signals at the second party unit would have been an obvious matter of optimization of design for optimizing verification of transferring the signal which is (sic) not seen to add patentable weight to the claimed method.” *Id.* “It would have been obvious because even though Freeny does not specifically teach the use of play-back feature, one of ordinary skill in the art would obviously be able to recognize that a system can record information such as that of Freeny can also play said information which system has been well known in the recording art.” *Id.*

Applicant (Hair), in an April 9, 1997 response, argued that Freeny does not teach

to play the audio or video signal, that there is no suggestion to play the copied signals, and that only with the hindsight of applicant's claimed invention and specification would one skilled in the art find applicant's claimed invention obvious over Freeny. *See id.* at 2-10.

Finally, the Examiner, in a July 10, 1997 final office action, repeated the obviousness rejection based on Freeny, stating: "Applicant mainly argues that Freeny does not teach reproducing/playing-back after transferring of the signals and thus the claimed invention should be considered distinguishable over Freeny. The argument is not found to be persuasive because it would have been obvious to one of ordinary skill in the art, in light of the teaching of Freeny, that play-back/reproducing after transferring the signals, based on personal common sense, would have been obvious within a level of ordinary skill in the art to verify the quality of the transferred signals since verification of integrity of signals/data/information, etc. has been well known in the art." *See id.* at Paper 10, pp. 2-3.

Hair, in a January 9, 1998 response, put forth a declaration attempting to show secondary consideration evidence of nonobviousness in an attempt to distinguish the teachings of Freeny to overcome the Examiner's § 103 rejection based on Freeny. *See id.* at Paper 13, p.5. Applicant reiterated his argument that Freeny teaches away from the claimed invention because Freeny does not provide for playback of the desired digital audio or video signals from the second memory. Hair further argued that (1) "the Examiner is using non-analogous art in reaching for a basis of rejection of the claimed invention" *id.* at p. 5; and (2) "the Examiner is using hindsight from applicant's own specification and claims to take the teachings of Freeny and then the argument that it would be obvious to add a playing mechanism to the teachings of Freeny to arrive at applicant's claimed invention." *Id.* at p. 17. In response, the Examiner issued an advisory action, maintaining rejection of all claims and further stating that "link(s) is required

to be established between the merits of the claimed invention and the evidence of secondary considerations (i.e., exhibits A, B, C).” *Id.*, paper 15.

While this was occurring in the Patent office, the owner of the Freeny patent brought suit for patent infringement against Compuserve, which resulted in a May 15, 1998 decision by a federal district court that construed various terms of the Freeny patent. *See Interactive Gift Express, Inc. v. Compuserve Inc.*, 1998 WL 247485, 47 U.S.P.Q.2d 1797 (S.D.N.Y. 1998) (attached as Exhibit 1).

Back at the Patent Office, Hair appealed from the Examiner’s final rejection in view of the Freeny patent by filing an appeal brief on June 9, 1998, in which he quoted from the District Court decision construing the claims of Freeny. *See* ‘440 File Wrapper, Paper 17, pp. 39-41. In relying on the District Court decision, Hair stated: “Besides not teaching or suggesting a playing capability, Freeny does not teach transferring digital video or digital audio signals to a second memory using telecommunications lines from a first memory, where the second memory is in the possession and control of the second party, as well as additional limitations which are not taught by Freeny.” *Id.* at 41. Hair further stated to the Examiner, “Appellant’s view is not simply argument but law determined on May 13, 1998, by the United States District Court for the Southern District of New York in Interactive Gift Express” *Id.*

Relying on the District Court’s decision, Hair argued that his invention is distinguishable from Freeny on three grounds. *See id.* at 41. First, “Freeny teaches a point of sale location where a consumer goes to purchase material objects embodying predetermined or preselected information.” *Id.* “In appellant’s claim 1, the second party already has the second memory so the second party does not have the step of going anywhere to get the second memory nor does the second party have the step of purchasing the material object to get the information.”

Id.

Second, “Freeny teaches a required step of transferring the information from the ICM to the IMM before the information can be transferred to the consumer and before the consumer even appears at the IMM to order the information.” *Id.* at 41-42. “Appellant’s invention does not need this step.” *Id.* at 42.

Third, Hair argued that according to the District Court in *Interactive Gift Express*, Freeny does not teach real-time download of information, whereas appellant’s invention supports real-time downloading of information. *Id.*

After the appeal, the Examiner deferred to the District Court’s decision, and Hair’s arguments based thereon, and issued a notice of allowability on September 15, 1998.

Subsequent to the issuance of the ‘440 Patent, the Court of Appeals for the Federal Circuit on July 13, 2001 in *Interactive Gift Express, Inc. v. Compuserve Inc.*, 256 F.3d 1323 (Fed. Cir. 2001) (attached as Exhibit 2), decided an appeal in the *Interactive Gift Express* case, reversing the District Court judge and directly contradicting what Hair presented to the Examiner as law. The Federal Circuit found error in the District Court’s construction of all the claim terms of the Freeny patent that the District Court construed and Hair relied on to procure issuance of the ‘440 patent. *Id.* at 1333. In particular, the Federal Circuit held that “a home can be a point of sale location” and that the “functions of the IMM are all of a type that can be performed within a computer, and it is well within the reasonable expectation of a person skilled in the art. . . .” *Id.* at 1335 & 1339. This ruling effectively removed Hair’s first argument. In particular, a person operating their home computer as an IMM can request digital audio and video signals for transfer from a first party computer to the home computer acting as an IMM. Thus, according to the Federal Circuit, Freeny teaches that a consumer would already have the

second memory at their home and would not have to perform the steps of going somewhere to access the second memory and purchasing a material object to get the information downloaded to the second memory of their computer.

The Federal Circuit also reversed the District Court's ruling that Freeny does not "cover real-time transactions where the requested item of information is transmitted to the IMM at the time it is requested by the consumer." *Id.* at 1342. The Federal Circuit held that "in the specification [of the Freeny patent], two embodiments are disclosed which operate in real-time and send information after a request is made." *Id.* at 1343. "In both of these embodiments, the 'providing' of information is performed after 'receiving the request reproduction code.'" *Id.* Further, "[a]lthough the specification [of the Freeny patent] describes these two non-preferred embodiments as impractical and uneconomical, respectively, it does not characterize them as inoperative nor is there anything in the specification which would nullify the effect of the disclosure in supporting a claim construction that is not limited to the predelivery of information." *Id.* Thus, the Federal Circuit's ruling directly vitiated Hair's remaining two arguments, that Freeny does not disclose real-time transactions and that Freeny requires that information is transferred to the second memory before the consumer even appears at the IMM to order the information.

Thus, the Federal Circuit's ruling alone eliminated each and every basis under which Hair distinguished the '440 patent claims over Freeny. Consequently, Hair anticipates, or at the very least renders the claims of the '440 patent obvious.

More recently, a Pennsylvania District Court construed various claims of the Hair patent and issued an order on a summary judgment motion relating to the Freeny reference. The Pennsylvania District Court stated that "the Freeny Patent teaches away from the Hair invention,

primarily because the device to which the information is downloaded is not the device on which the consumer plays back the recording, an element which is critical to the Asserted Claims” *SightSound.com Incorporated v. N2K, Inc., CDnow, Inc., and CDnow Online, Inc.*, Civil Action No. 98-0118, at 52-53 (W.D. Penn. 1998) (attached as Exhibit 3). The Court further stated that “material object ‘does not encompass the hard disk component of a home personal computer’ and the material object must be offered for sale, and be purchasable, at the point of sale location.” *Id.* at 53.

The Pennsylvania District Court’s interpretation does not change the fact that Freeny anticipates each and every limitation of the Hair patent.¹ Specifically, in reconciling the Pennsylvania District Court’s ruling and the Federal Circuit’s ruling it is clear that Freeny discloses that a consumer’s home computer can be a point of sale location (IMM) where a consumer purchases digital information (digital audio or video signals) in real-time. That is, a consumer desiring to purchase digital audio/video signals with Freeny’s disclosed invention, can purchase information from a first party for transferring to the memory of the consumer’s home computer after requesting the information, at which time the information would be resident in the consumer’s home computer. Accordingly, at that moment, Freeny fully anticipates the Hair patent. Freeny merely discloses the additional step of reproducing the information stored in the consumer’s home computer onto a “material object” such as a floppy disk or CD that is separate and distinct from the computer’s hard disk, as the Pennsylvania District Court points out.

¹ “While the Patent Office may accord deference to factual findings made by a district court, the determination of whether a substantial new question of patentability exists will be made independently of the court’s decision on validity and is not controlling on the Office.” MPEP § 2286 (“Because of the different standards of proof and claim interpretation employed by the District Courts and the Office, . . . [w]hen the initial question as to whether the prior art raises a substantial new question of patentability as to a patent claim is under consideration, the existence of a final court decision of claim validity in view of the same or different prior art does not necessarily mean that no new question is present.”) (emphasis added) (*Citing In re Zletz*, 893 F.2d 319, 321 (Fed. Cir. 1989); *In re Eitter*, 756 F.2d 852 (Fed. Cir. 1985)).

Thus, under the Federal Circuit's interpretation of the Freeny patent, Freeny anticipates the claims of the '440 patent, or at the very least renders the claims obvious, notwithstanding the Pennsylvania District Court's ruling. Accordingly, Freeny raises substantial new questions of patentability with respect to the '440 patent. For this reason and because the Freeny patent was not raised during the prosecution of the '573 patent, Freeny raises substantial new questions of patentability with respect to the '573 patent as well. Any argument that the patentee in this Reexamination may make to overcome Freeny, in light of the above history, would run afoul of the Federal Circuit's Decision in *Interactive Gift Express* and should be given no weight.



US005191573A

United States Patent [19]

[11] Patent Number: **5,191,573**

Hair

[45] Date of Patent: **Mar. 2, 1993**

[54] **METHOD FOR TRANSMITTING A DESIRED DIGITAL VIDEO OR AUDIO SIGNAL**

4,654,799 3/1987 Ogaki et al. 364/479

[76] Inventor: **Arthur R. Hair**, 301 Oaklawn Dr., Pittsburgh, Pa. 15241

Primary Examiner—Hoa Nguyen
Attorney, Agent, or Firm—Ansel M. Schwartz

[21] Appl. No.: **586,391**

[57] **ABSTRACT**

[22] Filed: **Sep. 18, 1990**

The present invention is a method for transmitting a desired digital video or audio signal stored on a first memory of a first party to a second memory of a second party. The method comprises the steps of transferring money via a telecommunications line to the first party from the second party. Additionally, the method comprises the step of then connecting electronically via a telecommunications line the first memory with the second memory such that the desired signal can pass therebetween. Next, there is the step of transmitting the desired digital signal from the first memory with a transmitter in control and in possession of the first party to a receiver having the second memory at a location determined by the second party. The receiver is in possession and in control of the second party. There is also the step of then storing the digital signal in the second memory.

Related U.S. Application Data

[63] Continuation of Ser. No. 206,497, Jun. 13, 1988, abandoned.

[51] Int. Cl.⁵ **G11B 5/86; G11B 7/00; G11B 11/00**

[52] U.S. Cl. **369/84; 235/381; 235/380; 369/33; 369/34; 369/15; 369/85**

[58] Field of Search **369/33, 34, 13, 15, 369/84, 85; 235/380, 381, 375; 364/479, 410**

[56] **References Cited**

U.S. PATENT DOCUMENTS

3,718,906	2/1973	Lightner	235/381
3,990,710	11/1976	Hughes	369/34
4,567,359	1/1986	Lockwood	235/381
4,647,989	3/1987	Geddes	235/381

6 Claims, 2 Drawing Sheets

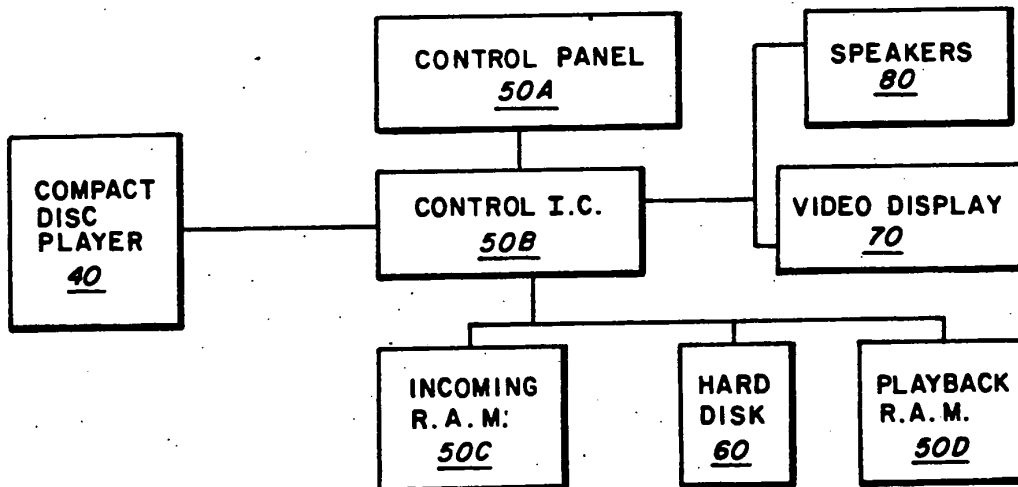

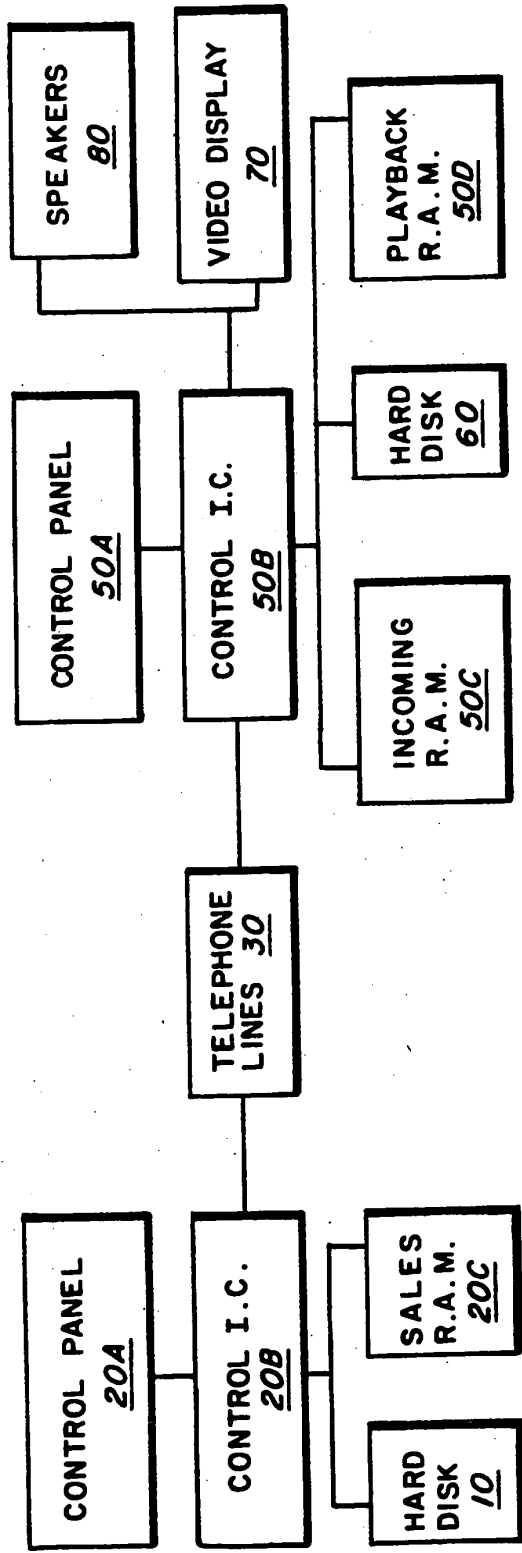

FIG. 1

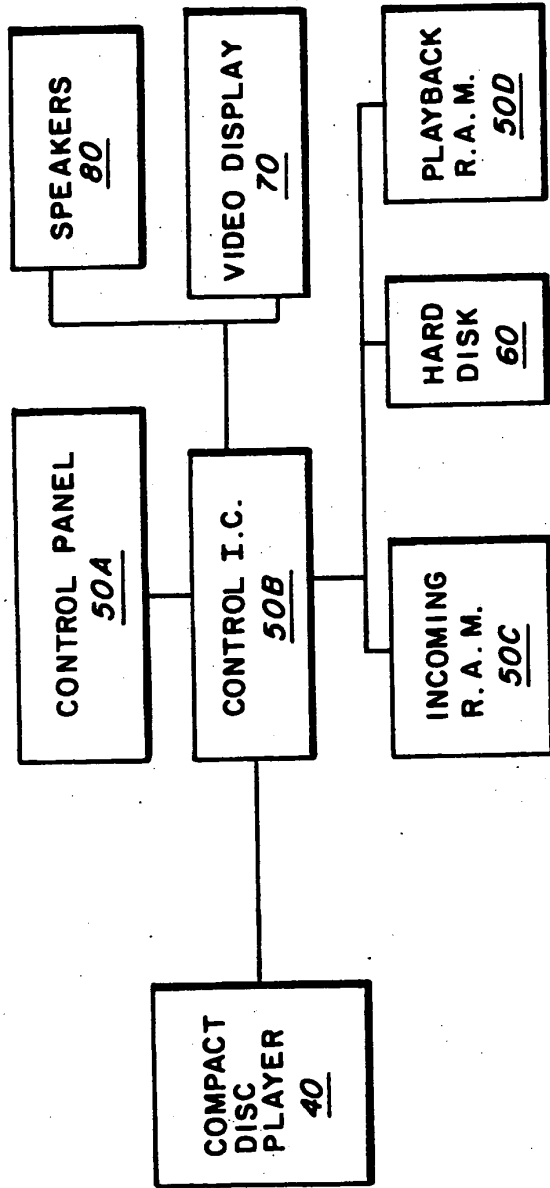

FIG. 2

METHOD FOR TRANSMITTING A DESIRED DIGITAL VIDEO OR AUDIO SIGNAL

This is a continuation of copending application Ser. No. 07/206,497 filed on Jun. 13, 1988, now abandoned.

FIELD OF THE INVENTION

The present invention is related to a method for the electronic sales and distribution of digital audio or video signals, and more particularly, to a method which a user may purchase and receive digital audio or video signal from any location which the user has access to a telecommunications line.

BACKGROUND OF THE INVENTION

The three basic mediums (hardware units) of music: records, tapes, and compact discs, greatly restricts the transferability of music and results in a variety of inefficiencies.

CAPACITY: The individual hardware units as cited above are limited as to the amount of music that can be stored on each.

MATERIALS: The materials used to manufacture the hardware units are subject to damage and deterioration during normal operations, handling, and exposure to the elements.

SIZE: The physical size of the hardware units imposes constraints on the quantity of hardware units which can be housed for playback in confined areas such as in automobiles, boats, planes, etc.

RETRIEVAL: Hardware units limit the ability to play, in a sequence selected by the user, songs from different albums. For example, if the user wants to play one song from ten different albums, the user would spend an inordinate amount of time handling, sorting, and cueing the ten different hardware units.

SALES AND DISTRIBUTION: Prior to final purchase, hardware units need to be physically transferred from the manufacturing facility to the wholesale warehouse to the retail warehouse to the retail outlet, resulting in lengthy, lag time between music creation and music marketing, as well as incurring unnecessary and inefficient transfer and handling costs. Additionally, tooling costs required for mass production of the hardware units and the material cost of the hardware units themselves, further drives up the cost of music to the end user.

QUALITY: Until the recent invention of Digital Audio Music, as used on Compact Discs, distortion free transfer from the hardware units to the stereo system was virtually impossible. Digital Audio Music is simply music converted into a very basic computer language known as binary. A series of commands known as zeros or ones encode the music for future playback. Use of laser retrieval of the binary commands results in distortion free transfer of the music from the compact disc to the stereo system. Quality Digital Audio Music is defined as the binary structure of the Digital Audio Music. Conventional analog tape recording of Digital Audio Music is not to be considered quality inasmuch as the binary structure itself is not recorded. While Digital Audio Music on compact discs is a technological breakthrough in audio quality, the method by which the music is sold, distributed, stored, manipulated, retrieved, played and protected from copyright infringements remains as inefficient as with records and tapes.

COPYRIGHT PROTECTION: Since the invention of tape recording devices, strict control and enforcement of copyright laws have proved difficult and impossible with home recorders. Additionally, the recent invention of Digital Audio Tape Recorders now jeopardizes the electronic copyright protection of quality Digital Audio Music on Compact Discs or Digital Audio Tapes. If music exists on hardware units, it can be copied.

Accordingly, it is an objective of this invention is to provide a new and improved methodology/system to electronically sell and distribute Digital Audio Music.

A further objective of this invention to provide a new and improved methodology/system to electronically store and retrieve Digital Audio Music.

Another objective of this invention is to provide a new and improved methodology/system to electronically manipulate, i.e., sort, cue, and select, Digital Audio Music for playback.

Still another objective of this invention is to offer a new and improved methodology/system which can prevent unauthorized electronic copying of quality Digital Audio Music.

SUMMARY OF THE INVENTION

Briefly, this invention accomplishes the above cited objectives by providing a new and improved methodology/system of electronic sales, distribution, storage, manipulation, retrieval, playback, and copyright protection of Digital Audio Music. The high speed transfer of Digital Audio Music as prescribed by this invention is stored onto one piece of hardware, a hard disk, thus eliminating the need to unnecessarily handle records, tapes, or compact discs on a regular basis. This invention recalls stored music for playback as selected/programmed by the user. This invention can easily and electronically sort stored music based on many different criteria such as, but not limited to, music category, artist, album, user's favorite songs, etc. An additional feature of this invention is the random playback of songs, also based on the user's selection. For example, the user could have this invention randomly play all jazz songs stored on the user's hard disk, or randomly play all songs by a certain artist, or randomly play all of the user's favorite songs which the user previously electronically "tagged" as favorites. Further, being more specific, the user can electronically select a series of individual songs from different albums for sequential playback.

This invention can be configured to either accept direct input of Digital Audio Music from the digital output of a Compact Disc, such transfer would be performed by the private user, or this invention can be configured to accept Digital Audio Music from a source authorized by the copyright holder to sell and distribute the copyrighted materials, thus guaranteeing the protection of such copyrighted materials. Either method of electronically transferring Digital Audio Music by means of this invention is intended to comply with all copyright laws and restrictions and any such transfer is subject to the appropriate authorization by the copyright holder. Inasmuch as Digital Audio Music is software and this invention electronically transfers and stores such music, electronic sales and distribution of the music can take place via telephone lines onto a hard disk. This new methodology/system of music sales and distribution will greatly reduce the cost of goods sold

and will reduce the lag time between music creation and music marketing from weeks down to hours.

The present invention is a method for transmitting a desired digital video or audio signal stored on a first memory of a first party to a second memory of a second party. The method comprises the steps of transferring money via a telecommunications line to the first party from the second party. Additionally, the method comprises the step of then connecting electronically via a telecommunications line the first memory with the second memory such that the desired digital signal can pass therebetween. Next, there is the step of transmitting the desired digital signal from the first memory with a transmitter in control and in possession of the first party to a receiver having the second memory at a location determined by the second party. The receiver is in possession and in control of the second party. There is also the step of then storing the digital signal in the second memory.

Further objectives and advantages of this invention will become apparent as the following description proceeds and the particular features of novelty which characterize this invention will be pointed out in the claims annexed to and forming a part of this declaration.

BRIEF DESCRIPTION OF THE SEVERAL VIEWS OF DRAWINGS

For a better understanding of this invention, reference should be made to the following detailed description, taken in conjunction with the accompanying drawings, in which:

FIG. 1 is a pictorial flow chart which may be used in carrying out the teachings of this invention for the purposes of electronic sales, distribution, storage, manipulation, retrieval, playback, and copyright protection of Digital Audio Music; and

FIG. 2 is a pictorial flow chart which may be used in carrying out the teachings of this invention for the purposes of electronic storage, manipulation, retrieval, and playback of Digital Audio Music.

DESCRIPTION OF THE PREFERRED EMBODIMENT

Referring now to the FIG. 1, this invention is comprised of the following:

- 10 Hard Disk of the copyright holder
- 20 Control Unit of the copyright holder
 - 20a Control Panel
 - 20b Control Integrated Circuit
 - 20c Sales Random Access Memory Chip
- 30 Telephone Lines/Input Transfer
- 50 Control Unit of the user
 - 50a Control Panel
 - 50b Control Integrated circuit
 - 50c Incoming Random Access Memory Chip
 - 50d Play Back Random Access Memory Chip
- 60 Hard Disk of the user
- 70 Video Display Unit
- 80 Stereo Speakers

The Hard Disk 10 of the agent authorized to electronically sell and distribute the copyrighted Digital Audio Music is the originating source of music in the configuration as outlined in FIG. 1. The Control Unit 20 of the authorized agent is the means by which the electronic transfer of the Digital Audio Music from the agent's Hard Disk 10 via the Telephone Lines 30 to the user's Control Unit 50 is possible. The user's Control Unit would be comprised of a Control Panel 50a, a Control

Integrated Circuit 50b, an Incoming Random Access Memory Chip 50c, and a Play Back Random Access Memory Chip 50d. Similarly, the authorized agent's Control Unit 20 would have a control panel and control integrated circuit similar to that of the user's Control Unit 50. The authorized agent's Control Unit 20, however, would only require the Sales Random Access Memory Chip 20c. The other components in FIG. 1 include a Hard Disk 60, a Video (display Unit 70, and a set of Stereo Speakers 80:

Referring now to FIG. 2, with the exception of a substitution of a Compact Disc Player 40 (as the initial source of Digital Audio Music) for the agent's Hard Disk 10, the agent's Control Unit 20, and the Telephone Lines 30 in FIG. 1, FIG. 2 is the same as FIG. 1.

In FIG. 1 and FIG. 2, the following components are already commercially available: the agent's Hard Disk 10, the Telephone Lines 30, the Compact Disc Player 40, the user's Hard Disk 60, the Video Display Unit 70, and the Stereo Speakers 80. The Control Units 20 and 50, however, would be designed specifically to meet the teachings of this invention. The design of the control units would incorporate the following functional features:

- 1) the Control Panels 20a and 50a would be designed to permit the agent and user to program the respective Control Integrated Circuits 20b and 50b,
- 2) the Control Integrated Circuits 20b and 50b would be designed to control and execute the respective commands of the agent and user and regulate the electronic transfer of Digital Audio Music throughout the system, additionally, the sales Control Integrated Circuit 20b could electronically code the Digital Audio Music in a configuration which would prevent unauthorized reproductions of the copyrighted material,
- 3) the Sales Random Access Memory Chip 20c would be designed to temporarily store user purchased Digital Audio Music for subsequent electronic transfer via telephone lines to the user's Control Unit 50,
- 4) the Incoming Random Access Memory Chip 50c would be designed to temporarily store Digital Audio Music for subsequent electronic storage to the user's Hard Disk 60,
- 5) the Play Back Random Access Memory Chip 50d would be designed to temporarily store Digital Audio Music for sequential playback.

The foregoing description of the Control Units 20 and 50 is intended as an example only and thereby is not restrictive with respect to the exact number of components and/or its actual design.

Once the Digital Audio Music has been electronically stored onto the user's Hard Disk 60, having the potential to store literally thousands of songs, the user is free to perform the many functions of this invention. To play a stored song, the user types in the appropriate commands on the Control Panel 50a, and those commands are relayed to the Control Integrated Circuit 50b which retrieves the selected song from the Hard Disk 60. When a song is retrieved from the Hard Disk 60 only a replica of the permanently stored song is retrieved. The permanently stored song remains intact on the Hard Disk 60, thus allowing repeated playback. The Control Integrated Circuit 50b stores the replica onto the Play Back Random Access Memory Chip 50d at a high transfer rate. The Control Integrated Circuit 50b then sends the electronic output to the Stereo Speakers 80 at a controlled rate using the Play Back Random Access

Memory Chip 50d as a temporary staging point for the Digital Audio Music.

Unique to this invention is that the Control Unit 50 also serves as the user's personal disk jockey. The user may request specific songs to be electronically cued for playback, or may request the Control Unit 50 to randomly select songs based on the user's criteria. All of these commands are electronically stored in random access memory enabling the control unit to remember prior commands while simultaneously performing other tasks requested by the user and, at the same time, continuing to play songs previously cued.

Offering a convenient visual display of the user's library of songs is but one more new and improved aspect of this invention. As the Control Unit 50 is executing the user's commands to electronically sort, select, randomly play, etc., the Video Display Screen 70 is continually providing feedback to the user. The Video Display Screen 70 can list/scroll all songs stored on the Hard Disk 60, list/scroll all cued songs, display the current command function selected by the user, etc. Further expanding upon the improvements this invention has to offer, the Video Display Screen 70 can display the lyrics of the song being played, as well as the name of the song, album, artist, recording company, date of recording, duration of song, etc. This is possible if the lyrics and other incidental information are electronically stored to the Hard Disk 60 with the Digital Audio Music.

The present invention is a method for transmitting a desired digital video or audio signal stored on a first memory of a first party to a second memory of a second party. The method comprises the steps of transferring money via a telecommunications line to the first party from the second party. Additionally, the method comprises the step of then connecting electronically via a telecommunications line the first memory with the second memory such that the desired digital signal can pass therebetween. Next, there is the step of transmitting the desired digital signal from the first memory with a transmitter in control and in possession of the first party to a receiver having the second memory at a location determined by the second party. The receiver is in possession and in control of the second party. There is also the step of then storing the digital signal in the second memory.

In summary, there has been disclosed a new and improved methodology/system by which Digital Audio Music can be electronically sold, distributed, transferred, and stored. Further, there has been disclosed a new and improved methodology/system by which Digital Audio Music can be electronically manipulated, i.e., sorted, cued, and selected for playback. Further still, there has been disclosed a new and improved methodology/system by which the electronic manipulation of Digital Audio Music can be visually displayed for the convenience of the user. Additionally, there has been disclosed a new and improved methodology/system by which electronic copyright protection of quality Digital Audio Music is possible through use of this invention.

Since numerous changes may be made in the above described process and apparatus and different embodiments of the invention may be made without departing from the spirit thereof, it is intended that all matter contained in the foregoing description or shown in the accompanying drawings shall be interpreted as illustrative, and not in a limiting sense. Further, it is intended that this invention is not to be limited to Digital Audio

Music and can include Digital Video, Digital Commercials, and other applications of digital information.

I claim:

1. A method for transmitting a desired digital audio signal stored on a first memory of a first party to a second memory of a second party comprising the steps of:

transferring money electronically via a telecommunication line to the first party at a location remote from the second memory and controlling use of the first memory from the second party financially distinct from the first party, said second party controlling use and in possession of the second memory;

connecting electronically via a telecommunications line the first memory with the second memory such that the desired digital audio signal can pass therebetween;

transmitting the desired digital audio signal from the first memory with a transmitter in control and possession of the first party to a receiver having the second memory at a location determined by the second party, said receiver in possession and control of the second party; and

storing the digital signal in the second memory.

2. A method as described in claim 1 including after the transferring step, the steps of searching the first memory for the desired digital audio signal; and selecting the desired digital audio signal from the first memory.

3. A method as described in claim 2 wherein the transferring step includes the steps of telephoning the first party controlling use of the first memory by the second party; providing a credit card number of the second party controlling the second memory to the first party controlling the first memory so the second party is charged money.

4. A method for transmitting a desired digital video signal stored on a first memory of a first party to a second memory of a second party comprising the steps of:

transferring money electronically via a telecommunications line to the first party at a location remote from the second memory and controlling use of the first memory, from a second party financially distinct from the first party, said second party in control and in possession of the second memory;

connecting electronically via a telecommunications line the first memory with the second memory such that the desired digital video signal can pass therebetween;

transmitting the desired digital video signal from the first memory with a transmitter in control and possession of the first party to a receiver having the second memory at a location determined by the second party, said receiver in possession and control of the second party; and

storing the digital signal in the second memory.

5. A method as described in claim 4 including after the transferring money step, the step of searching the first memory for the desired digital signal and selecting the desired digital signal from the first memory.

6. A method as described in claim 5 wherein the transferring step includes the steps of telephoning the first party controlling use of the first memory by the second party controlling the second memory; providing a credit card number of the second party controlling the second memory to the first party controlling the first memory so the second party controlling the second memory is charged money.

• • • • •

UNITED STATES PATENT AND TRADEMARK OFFICE
CERTIFICATE OF CORRECTION

PATENT NO. : 5,191,573
DATED : March 2, 1993
INVENTOR(S) : Arthur R. Hair

Page 1 of 3

It is certified that error appears in the above-identified patent and that said Letters Patent is hereby corrected as shown below:

- Column 1, line 12, replace "signal" with -- signals -- .
- Column 1, line 17, replace ":" with -- , i.e., -- .
- Column 1, line 38, replace "cueing" with -- queuing -- .
- Column 1, line 40, replace "transferred" with -- transferred -- .
- Column 1, line 42, replace "&he" with -- the -- .
- Column 1, line 43, replace "lengthly," with -- lengthy -- .
- Column 1, line 44, replace "unnessary" with -- unnecessary -- .
- Column 1, line 47, after "units", first occurrence, insert -- , -- .
- Column 2, line 10, delete "is", second occurrence.
- Column 2, line 13, after "invention" insert -- is -- .
- Column 2, line 19, replace "cue" with -- queue -- .
- Column 2, line 36, delete "-".
- Column 2, line 59, replace "transfering" with -- transferring -- .
- Column 2, line 59, replace "Audic" with -- Audio -- .
- Column 2, line 64, replace "an" with -- and -- .
- Column 3, line 36, replace "; and" with -- . -- .
- Column 3, line 67, after "unit", second occurrence, insert -- 50 -- .

UNITED STATES PATENT AND TRADEMARK OFFICE
CERTIFICATE OF CORRECTION

Page 2 of 3

PATENT NO. : 5,191,573
DATED : March 2, 1993
INVENTOR(S) : Arthur R. Hair

It is certified that error appears in the above-identified patent and that said Letters Patent is hereby corrected as shown below:

- Column 4, line 4, after "panel" insert -- 20a -- .
- Column 4, line 5, after "circuit" insert -- 20b -- .
- Column 4, line 9, replace "(display" with -- Display -- .
- Column 4, lines 32 and 33, replace "system, additionally," with -- system. Additionally. -- .
- Column 5, line 4, replace "jocky" with -- jockey -- .
- Column 5, line 5, replace "cued" with -- queued -- .
- Column 5, line 11, replace "stime" with -- time -- .
- Column 5, line 12, replace "cued" with -- queued -- .
- Column 5, line 20, replace "cued" with -- queued -- .
- Column 5, line 28, replace "to" with -- on -- .
- Column 5, line 32, replace "steps" with -- step -- .
- Column 5, line 52, replace "cued" with -- queued -- .
- Column 5, line 53, replace "beer" with -- been -- .
- Column 6, line 9, replace "lian" with -- line -- .
- Column 6, line 9, after "party" insert -- , -- .

UNITED STATES PATENT AND TRADEMARK OFFICE
CERTIFICATE OF CORRECTION

PATENT NO. : 5,191,573
DATED : March 2, 1993
INVENTOR(S) : Arthur R. Hair

Page 3 of 3

It is certified that error appears in the above-identified patent and that said Letters Patent is hereby corrected as shown below:

Column 6, line 11, after "memory" insert -- , -- .

Column 6, line 41, after "party" insert -- , -- .

Title page, item [57]

In the abstract, line 4, replace "steps" with -- step -- .

In the abstract, line 9, after "desired" insert -- digital -- .

Signed and Sealed this
Twenty-first Day of December, 1993

Attest:



BRUCE LEHMAN

Attesting Officer

Commissioner of Patents and Trademarks

Form 1449 (Modified) Information Disclosure Statement By Applicant (Use Several Sheets if Necessary)	Atty Docket No: NAPSP001	U.S. Patent No. 5,191,573
	Applicant: Arthur R. Hair Issue Date: March 2, 1993	Group:

U.S. Patent Documents

Examiner Initial	No.	Patent No.	Date	Patentee	Class	Sub-class
	A	4,499,568	2/1985	Gremillet		
	B	4,528,643	7/1985	Freeny, Jr.		
	C	4,658,093	4/1987	Hellman		
	D					
	E					
	F					
	G					
	H					
	I					
	J					
	K					

Foreign Patent or Published Foreign Patent Application

Examiner Initial	No.	Document No.	Publication Date	Country or Patent Office	Class	Sub-class	Translation	
							Yes	No
	L	GB 2 178 275 A	2/1987	United Kingdom				
	M	62-284496	12/1987	Japan			X	
	N							
	O							
	P							

Other Documents

Examiner Initial	No.	Author, Title, Date, Place (e.g. Journal) of Publication
	Q	Jordan, Larry E. and Churchill, Bruce, <i>Communications and Networking for the IBM PC</i> , Robert J. Brady Co., Bowie, MD (1983).
	R	W. Rosch, "ComNet for the PC," <i>PC Magazine</i> , August 1983, pp. 225-228.
	S	E. Ferrarini, "Direct Connections for Software Selections," <i>Business Computer Systems</i> , February 1984, pp. 35+ (4 pages total).
	T	P. Elmer-DeWitt, "Calling up an on-line cornucopia; computer networks are supermarkets of services and information," <i>Time</i> , April 7, 1986 (two-page electronic version obtained at http://www.highbeam.com).
Examiner		Date Considered

Examiner: Initial citation considered. Draw line through citation if not in conformance and not considered. Include copy of this form with next communication to applicant.

(12) UK Patent Application (19) GB (11)

2 178 275 A

(43) Application published 4 Feb 1987

(21) Application No 8617315

(22) Date of filing 16 Jul 1986

(30) Priority data

(31) 8518350 (32) 20 Jul 1985 (33) GB

(71) Applicants
Bernard Gallagher
282 Pickhurst Lane, West Wickham, Kent BR4 0HT
Yasmin Hashmi
282 Pickhurst Lane, West Wickham, Kent BR4 0HT

(72) Inventors
Bernard Gallagher
Yasmin Hashmi

(74) Agent and/or Address for Service
Matthews Haddan & Co., Haddan House, 33 Elmfield Road,
Bromley, Kent BR1 1SU

(51) INT CL⁴
H04H 1/00 H04L 27/10

(52) Domestic classification (Edition I)
H4R CSC
H4P AFC

(56) Documents cited
GB A 2121656 GB A 2117210 GB A 2063026
EP A2 0140593 EP A2 0082077

(58) Field of search
H4R
Selected US specifications from IPC sub-class H04H

(54) Recorded data transfer system

(57) A recorded data transfer system is provided particularly for use in the entertainment industry whereby digital data may be transferred between a source unit, a database which may be housed by a record company and user units.

The transfer system comprises

- a) a database having a main computer, a caller/called interface, a transmitter/receiver interface, and a data storage and processing system, means for controlling the storage and processing of data,
- b) at least one source unit having a means for communication with said database and means for the storage and processing of data, and
- c) at least one user unit having means for communication with the database and a means for storing/recalling and/or processing data received from the database. Preferably the user unit includes playback apparatus.

The database includes means for transmitting bytes of data in the form of a plurality of frequencies, each frequency being assigned to only one bit of the word.

GB 2 178 275 A

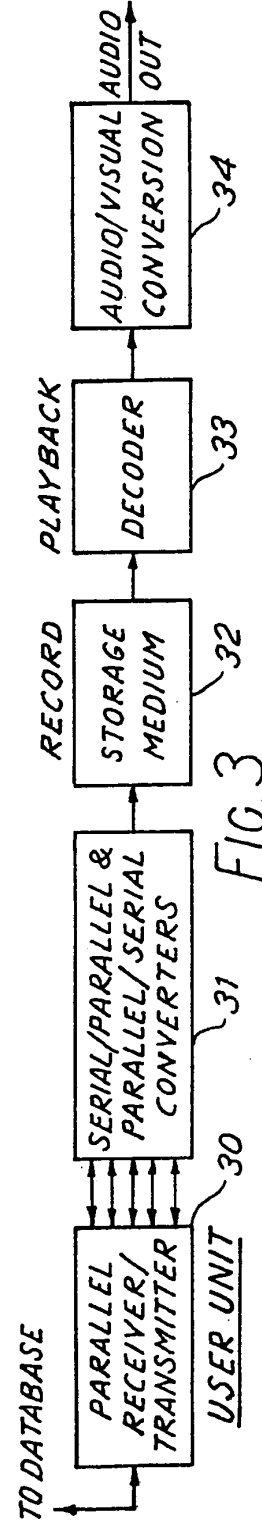
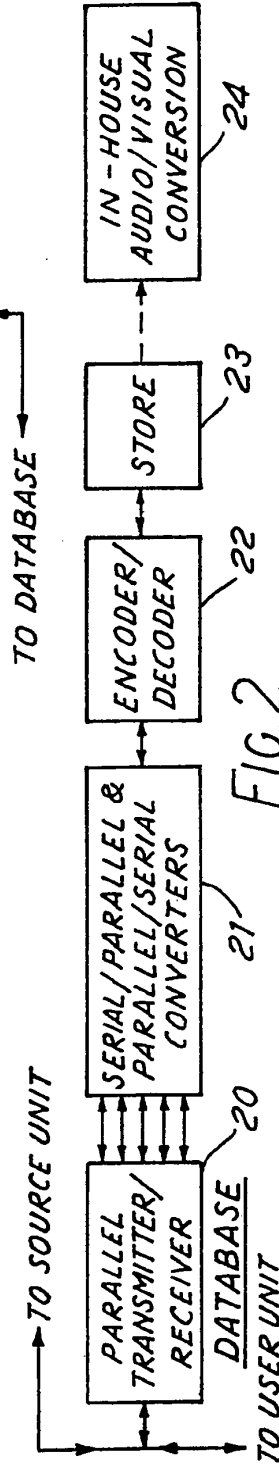
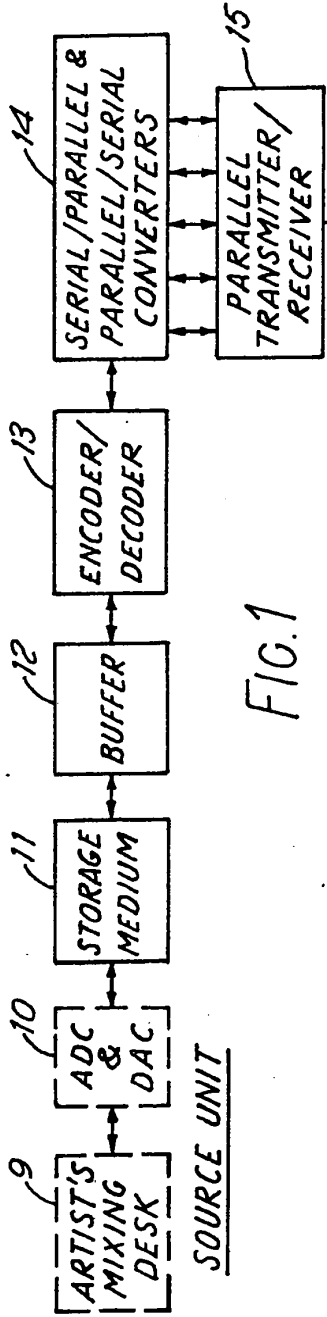

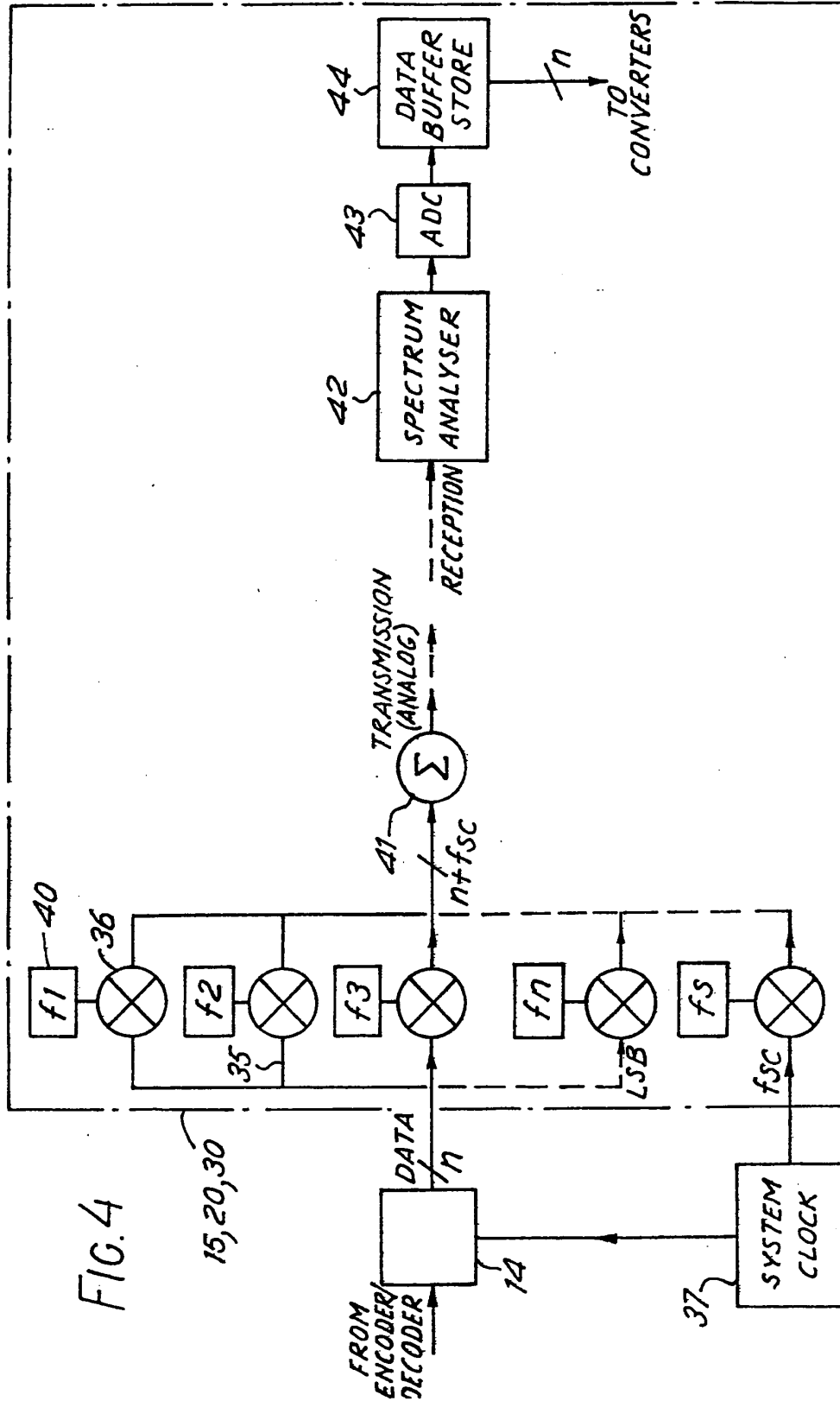

FIG. 4

SPECIFICATION

Recorded data transfer system

5 This invention relates to a recorded data transfer system particularly for use in the entertainment industry whereby digital data may be transferred between a source unit, a database which may be housed by a record company, and a user unit either
10 directly or indirectly.

According to the invention there is provided a recorded data transfer system comprising

a) a database having a main computer, a caller/called interface, a transmitter/receiver interface, a data storage and processing system, means for controlling the storage and processing of data, means for controlling the process of being called by one or more user units or another database, and

b) at least one user unit having means for communication with said database including a transmitter/receiver interface and means for storing/recalling and/or processing data received from the database.

Preferably the transfer system includes at least one source unit having a means for communication with said database including a transmitter/receiver interface, and means for the storage and processing of data.

The media for data transfer is preferably high speed telephone links by way of modems. However, normal telephone links, fibre optic links, electro-magnetic waves or any other suitable medium may be used.

The media for storage of data would be floppy disk, hard disk, optical or laser disk, magnetic tape, integrated circuit memory or any other suitable medium.

The system may incorporate anti-piracy methods such as the encryption or encoding of data either generally or uniquely.

The data is transferred from the source unit to the database where it is processed for storage in library form whereby selected data can be transmitted to any user and/or source unit in national or foreign territories.

The source unit could belong to a recording artist, the main unit to a major record company and user units to the general public. The artist would transfer a master mix to the record company who would store it, having processed it if necessary, and recall it, when necessary for sale to the general public via their user units. By arranging for the data to be encoded/encrypted uniquely for each user unit, the borrowing or unlawful copying of material could be eliminated. This method could also be used to ensure security between all units.

The invention will now be described by way of example with reference to the accompanying drawings in which:-

FIGURE 1 is a block diagram of a possible configuration of the source (artist's) unit,

FIGURE 2 is a block diagram of a possible configuration for the main (database or record company's) unit, FIGURE 3 is a block diagram of a possible configura-

tion for the user unit, and

FIGURE 4 is a diagram of a parallel transmitter/receiver as a possible means of communication between units.

From Figure 1 it is seen that the source unit, which will be located, for example, at the artist's recording studio, comprises a storage medium 11, a buffer 12, an encoder/decoder 13, a serial/parallel and parallel/serial converter 14, and a parallel transmitter/receiver 15. It is assumed that the artist's material is digitised before it reaches the buffer stage. Although a parallel transmitter/receiver is preferable. However, depending on the type of processor used, for example a transputer, serial to parallel conversion may not be necessary as the data will be available in parallel form. In the case of some transmission media with very high serial speeds, serial to parallel conversion may also not be necessary.

The database, Figure 2, comprises a parallel transmitter/receiver 20, a serial/parallel and parallel/serial converter 21, an encoder/decoder 22 and a buffer store 23. Conversion of data may take place at the record company for in-house audio or visual reproduction by means of a conversion system 24.

The user unit, Figure 3, comprises a parallel receiver/transmitter 30, a serial/parallel and parallel/serial converter 31, a storage medium 32 such as video tape or optical disk, a decoder 33 and suitable conversion apparatus 34 for audio and/or visual reproduction.

It is assumed that recorded material may be sent and received by both the source unit and the database and that the user unit may only receive recorded material. Decoding (if applicable) should preferably be actuated between the storage medium and conversion thus eliminating the possibility of material being usefully borrowed or copied.

By means of the parallel/receiver transmitter the artist can transmit a newly recorded work direct to the record company. The user on the other hand can log on to the data base and make her/his selection according to a supplied menu. Suitable security coding may be provided between the source unit and the data base and likewise between the data base and the user unit and between data bases.

At present all transfer of data between remote systems is done serially or by phase/amplitude modulation. In the preferred arrangement the parallel transmitter/receiver allows parallel transmission of data words using a form of frequency shift keying described below.

The parallel transmitter/receiver of each of the source unit, database and user unit comprises the same components. However, as an example there is shown in Figure 4 the transmitter/receiver (15,20,30 respectively of Figures 1, 2 and 3) of which the components for transmission are shown to the left of the diagram and the components for receiving are shown to the right. In the transmitter portion the outputs 35 (most significant bit to least significant bit) or the serial/parallel and parallel/serial converter 14 are connected to the inputs of a series of frequency

The drawing(s) originally filed was (were) informal and the print here reproduced is taken from a later filed formal copy.

multipliers 36 fed respectively by preselected frequencies 40. The outputs of the multipliers 40 are fed to a mixer 41 in which the individual frequencies are summed as a single analog signal for serial transmission.

In use a word or frame of recorded data is clocked onto the multiplying lines where each individual bit is multiplied by its own unique frequency ($f_1, f_2 \dots f_n$). The individual frequencies are chosen so that addition of all possible combinations will not result in an error. For example, if most significant bit (M.S.B.) is 'hi' then the frequency f_1 will be fed to a mixer 41, if it is 'lo' then f_1 will not appear and no combination of the other frequencies f_2 - f_n will result in f_1 being apparent. Clock pulses of frequency f_{sc} form a system clock 37 which clocks the data out from the converter 14 can also be multiplied by a frequency f_s and transmitted as a frequency and recovered at the receiving end (e.g. by phase lock looping) for use in synchronisation.

The frequencies which are mixed in the mixer 41 are then sent as an analog signal over the transmission medium where the signal is received by a spectrum analyser 42 forming part of parallel transmitter receiver (21 of Figure 2).

If the transmission medium is an ordinary telephone system then the bandwidth is restricted to 3 kHz. Therefore, depending on the number of bits used per word, the frequencies used to represent the bits will have to be within this bandwidth. For example if the lowest frequency to be used is 200 Hz—which will represent the L.S.B. then if 16 bits are used per word, the difference between each frequency could be $\frac{3000 - 200}{16} = 175$ Hz i.e. the frequency used to represent the L.S.B. + 1 would be $200 + 175 = 375$ Hz etc. British Telecom protocols would not be broken due to the system clock frequency being continuously present during data transfers. It must be noted however, that current technology requires at least 2 cycles of a frequency to be transmitted in order for that frequency to be recognised by receiver circuitry. The rate of transmission is therefore determined by the lowest frequency used so normal telephone links would seem impractical for this purpose, and the above serves only as an example.

If the transmission medium is one in which modulation is used (either AM, FM, PCM or PM [Phase modulation]) then the output from the mixer stage could be modulated in the same way as ordinary speech and demodulated at the receiving end (in this example at the database) the received word or frame must be filtered for each individual frequency and this is carried out by the spectrum analyser 42 having either separate filters for each frequency or a carrier sweep filter which would detect whether the frequencies are present or not. If a frequency is present the filter will give an output voltage to represent that bit; if not there will be a zero.

To synchronise the system, the system clock, which has been sent along with the bit frequencies can be recovered and used as a READ clock. This clock could be sent at a lower frequency than the L.S.B. for example. The voltages then have to be 'squared off' and converted into suitable digital levels by an analog to digital converter 43 which can then be stored.

The recorded data transfer system of the present

invention affords the following advantages:

- a) For the company;
 - 1) The elimination of supply and demand problems.
 - 2) The elimination of production costs.
 - 3) The elimination of distribution costs.
 - 4) The elimination of sales force.
 - 5) Built-in stock control.
 - 6) The elimination of piracy within the recorded data system.
 - 7) The immediate transfer of master information inland and overseas.
 - 8) Vast reduction in storage space.
- b) For the artist;
 - 1) Immediate and secure transfer of master mix information to the company.
 - 2) Immediate access to master mix information from any territory.
 - 3) An enhanced royalty accounting system due to the built-in stock control.
 - 4) Increased promotion on product due to aforementioned reduction in costs.
- c) For the consumer;
 - 1) Master mix quality of recorded material.
 - 2) Greatly increased choice of material irrespective of territory.
 - 3) Home-buying of material.
 - 4) Immediate access to material.
 - 5) The opportunity to refurbish collection irrespective of deletions.

CLAIMS

1. A recorded data transfer system comprising
 - a) a database having a main computer, a caller/called interface, a transmitter/receiver interface, a data storage and processing system, means for controlling the storage and processing of data, means for controlling the process of being called by one or more user units or another database, and
 - b) at least one user unit having means for communication with said database including a transmitter/receiver interface and means for storing/recalling and/or processing data received from the database.
2. A data transfer system as claimed in Claim 1, including at least one source unit having a means for communications with said database including a transmitter/receiver interface, and means for the storage and processing of data.
3. A data transfer system as claimed in Claim 1 or 2, wherein said transmitter/receiver interface is in the form of a parallel/serial device.
4. A data transfer system as claimed in Claim 3, wherein said parallel/serial transmitter/receiver comprises a plurality of frequency multipliers arranged in an array to receive a parallel word or frame input, means for supplying to said multipliers with signals of different frequencies so that each individual bit of the word or frame is multiplied by its own unique frequency, and means for summing the frequencies at the output of the multipliers to provide an analog signal for serial transmission.
5. A data transfer system as claimed in Claim 4, wherein said transmitter/receiver includes a spectrum analyser for receiving serial analog signals, an analog to digital converter and a data buffer store.
6. A data transfer system as claimed in Claim 5,

wherein a further multiplier is provided for receiving the system clock pulses which are multiplied by a unique frequency and summed with the multiplied frequencies representing the word or frame, said clock pulses being recovered by said spectrum analyser for the purpose of synchronisation.

7. A parallel/serial transmitter/receiver for a data transfer system comprising a plurality of frequency multipliers arranged in an array to receive a parallel word or frame input, means for supplying to said multipliers with signals of different frequencies so that each individual bit of the word or frame is multiplied by its own unique frequency, and means for summing the frequencies at the output of the multipliers to provide an analog signal for serial transmission.

8. A parallel/serial transmitter/receiver as claimed in Claim 7, including a spectrum analyser for receiving serial analog signals, an analog to digital converter and a data buffer store.

9. A recorded data transfer system as claimed in Claim 1, substantially as described by way of example with reference to Figures 1 and 2.

10. A parallel/serial transmitter/receiver as claimed in Claim 7, substantially as described by way of example with reference to Figure 4.

Printed in the United Kingdom for Her Majesty's Stationery Office, 8818935, 2/87 18996. Published at the Patent Office, 25 Southampton Buildings, London WC2A 1AY, from which copies may be obtained.

⑯ 日本国特許庁 (J P)

⑰ 特許出願公開

⑱ 公開特許公報 (A)

昭62-284496

⑲ Int. Cl.⁴
G 07 F 17/00

識別記号 庁内整理番号
7347-3E

⑳ 公開 昭和62年(1987)12月10日

審査請求 未請求 発明の数 1 (全3頁)

㉑ 発明の名称 レコード音楽の自動販売システム

㉒ 特 願 昭61-127327

㉓ 出 願 昭61(1986)6月3日

㉔ 発 明 者 明 石 久 信 東京都杉並区西荻北2-5-20-505

㉕ 出 願 人 明 石 久 信 横浜市南区平楽155-2-801

明 細 書

1. 発明の名称

レコード音楽の自動販売システム

2. 特許請求の範囲

コンピュータ通信手段を内蔵した録音再生装置と、レコード音楽データ及びそのレコードリストと作曲家、曲目、演奏者等のレコード情報を蓄積したホストコンピュータとを電話回線で連絡し、上記録音再生装置からのアクセスによって上記のレコード音楽データを上記ホストコンピュータから上記録音再生装置へ送信することを特徴とするレコード^{音楽}の自動販売システム。

3. 発明の詳細な説明

(1) 産業上の利用分野

この発明はレコード音楽を電話回線を介して自動販売するシステムに関する。

(2) 従来の技術

従来のレコード音楽の販売システムは、レコード会社が録音された音楽をLPレコード又はデジ

タル・オーディオ・ディスク(コンパクト・ディスク)として製造し、レコード販売店等を介して消費者に販売提供していた。

(3) 発明が解決しようとする問題点

上記の従来のレコードディスク販売システムでは、ディスク製造に多大な設備と費用を要し、更に流通から販売までの経路における商品管理等に多大の費用と手数を要する。また、レコード会社によるレコードディスクの廃盤という事態もしばしば起こり、音楽愛好家が欲しいレコードを買えないという事態を招いていた。

(4) 問題点を解決するための手段

以上のような問題点を解決するために、デジタル録音された音楽及び従来のアナログ録音された音楽をデジタル化して利用することを前提に、この発明は次のような構成をとっている。すなわち、コンピュータ通信手段を内蔵した録音再生装置と、レコード音楽データ及びそのレコードリストと作曲家、曲目、演奏者等のレコード情報を蓄積したホストコンピュータとを電話回線で連絡し、上記

録音再生装置からのアクセスによって上記のレコード音楽データを上記ホストコンピュータから上記録音再生装置へ送信するように構成されている。

(6) 作用

レコード音楽データとそのレコードリスト及び作曲家、曲目、演奏者等のレコード情報を集めたホストコンピュータの総合データベースに、コンピュータ通信手段を内蔵した録音再生装置によってアクセスし、接続したTVモニター、もしくは専用モニターを用いて、目的のリスト等の音楽情報を検索し、検索できたら録音再生装置からレコード音楽データ送信希望の信号を発信し、タイムシェアリング方式もしくはパケット交換方式などによって、この発信信号をホストコンピュータで処理し送信し、録音装置内のRAMにダウンロードし、レコード音楽データをデジタル録音する。

(6) 実施例

第1図は、この発明のレコード音楽の自動販売システムに使用されるコンピュータ通信手段を内蔵した録音再生装置の一実施例を示す概略構成図、

自動販売システムは、上記の録音再生装置1と、この録音再生装置1に接続されたモニター12とを各家庭の端末として構成され、タイムシェアリング方式もしくはパケット交換方式で録音再生装置1が通信回線網13に接続されている。この通信回線網13は公衆通信回線または光ケーブル専用通信回線であって、望ましくは光ケーブル専用通信回線を使用する。録音再生装置1は通信回線網13を介してホストコンピュータ14のデータベースに接続されている。ホストコンピュータ14のデータベースには、レコード会社15の保有するデジタル録音またはアナログ録音をデジタル化したレコード音楽データAと、そのレコードリストBと、作曲家、曲目、演奏者等に関するレコード情報Cが蓄積保存されている。

以上のように構成されたネットワークシステムは、双方向通信システムであり、このシステムの伝送制御方式は有手順方式のベーシック手順もしくはHDL C手順などが用いられる。

次にこの発明のレコード音楽の自動販売システ

第2図はレコード音楽の自動販売システムのネットワークを示す概略構成図である。

録音再生装置1は書き込み後すぐに読み出せる追記型の光ディスクを用いるコンパクト・ディスク・デッキもしくはデジタル・オーディオ・テープレコーダーのどちらでもよく、一例としてコンパクト・ディスク・デッキによって説明する。

録音再生装置1には、コンピュータ通信手段であるNCU(電話網制御ユニット)2、モデム3、通信LSI4、CPU5、出力フレームバッファ6、映像信号発生装置7が組み込まれている。NCU2は外部の電話線8に接続され、NCU2とモデム3の間に電話機9が接続されている。CPU5は書き込み可能な追記型の光ディスク録音再生装置10に接続されているとともに、外部のコントロールユニット11にも接続されている。映像信号発生装置7は外部のモニター12に接続されている。

上記の録音再生装置1は、第2図に示す自動販売システムのネットワークに接続される。この自

ムの操作手順を説明する。

- イ. コントロールユニット11によって送信(アクセス)信号を発する。
- ロ. このアクセス信号が通信LSI4によって制御されているCPU5で処理され、モデム3に送られる。このモデム3でデジタル信号がアナログ信号に変換される。ここでNCU2によって電話線8が電話機9からコンピュータに切り換えられ、ホストコンピュータ14にアクセスする。
- ハ. アクセスされたホストコンピュータ14から返信信号(メニュー画面データ)が送られ、録音再生装置1側から送信した時と逆の手順で録音再生装置1内で処理される。
- ニ. モニター12の画面によって確認しながら、コントロールユニット11によって任意のデータを選択し、初期の送信手順と同様に、CPU5→通信LSI4→モデム3→NCU2→電話線8の順で、順次選択の信号を送信する。
- ホ. これらの相互通信によって目的のデータが発見できた時、ユーザーはそのデータをホストコン

ピュータ14から電話線8→NCU2→モデム3→通信LSI4→CPU5の順で処理し、レコード音楽データをRAMにダウンロードし、光ディスク録音再生装置10によって書き込み可能な光ディスクに書き込む。

(7) 発明の効果

この発明のレコード音楽の自動販売システムによれば、現在のレコード流通経路が不必要となり、レコード会社はレコード音楽のデータだけを保有すればよく、レコードの大幅なコストダウンがはかれる。また、ユーザーは家庭にしながら大量のレコードリストの中から、希望のレコード音楽を自由に、しかも容易に検索し、購入できる。さらに、レコーディング・データそのものが商品であるため、従来の販売システムのような廃盤はなくなり、未開拓のユーザーの開拓が低コストで可能となる。

4. 図面の簡単な説明

第1図は、この発明のレコード音楽の自動販売システムに使用される録音再生装置の実施例を示

す概略構成図、第2図は、レコード音楽の自動販売システムのネットワークを示す概略構成図である。

- 1…録音再生装置 2…NCU 3…モデム
- 4…通信LSI 5…CPU
- 6…出力フレームバッファ
- 7…映像信号発生装置 8…電話線
- 9…電話機 10…光ディスク録音再生装置
- 11…コントロールユニット 12…モニター
- 13…通信回線網 14…ホストコンピュータ
- 15…レコード会社

特許出願人 明石久信

第1図

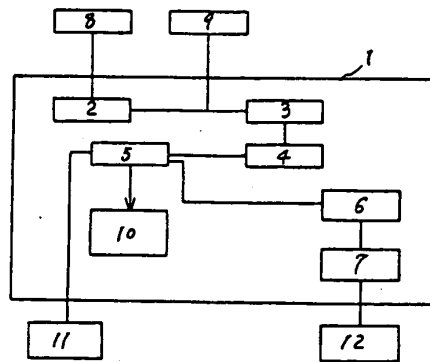

第2図

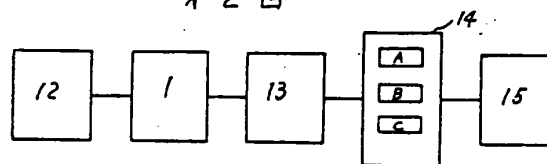

(19) Japan Patent Office (JP)
(12) Unexamined Patent Applications Publication (A)

(11) Japanese Patent Application Kokai Publication: S62-284496
(43) Kokai Publication Date: December 10, 1987

[English] Int.Cl.	Identification Symbol	JPO File Number
G 07 F 17/00		7347-3E

Request for Examination: Not Yet Requested
Number of Inventions: 1
Number of Pages: 3

(54) Name of invention: Automated Music Purchasing System

(21) Application Number: S61-127327

(22) Date Filed: June 3, 1986

(72) Inventor: Hisanobu Akashi
2-5-20 Nishiogikita #505 Suginami-ku, Tokyo

(71) Applicant: Hisanobu Akashi
155-2 Heiraku #801, Minami-ku, Yokohama-shi

Specification

1. Title of the Invention: Automated Music Purchasing System

2. Claims:

The present invention is an Automated Music Purchasing System which enables users to access recorded music data from a host computer, which stores recording information, such as recorded music data, record lists, composers, titles, performers, etc. The system utilizes a personal computer recording/recording reproduction device which communicates via telephone lines.

3. Detailed Explanation of the Invention:

(1) Industrial Field of Application

The present invention pertains to a system which automatically sells recorded music via the

telephone line.

(2) Prior Art

The conventional system of selling recorded music is that a record company manufactures an LP record or digital audio disc (compact disc) of recorded music which it sells to consumers by way of music sales outlets, etc.

(3) Problem to be solved by the invention

The above-mentioned conventional method for selling recorded music entails considerable costs and facilities to manufacture music discs, as well as the cost and time involved for merchandise management, etc. in the distribution to sales process. In addition, record companies often discontinue record discs, resulting in a situation whereby music consumers are not able to purchase the record they want.

(4) Means for Solving the Problems

In order to address the above problems, the present invention, which is based on the utilizing of digital music as well as analog-recorded conventional music which has been put into a digitalized format, is made up as follows:

The present invention is an Automated Music Purchasing System which utilizes telephone lines to transmit recorded music data from a host computer, which stores recording information, such as recorded music data, record lists, composers, titles, performers, etc., to the said recording/reproduction device installed in a personal computer.

(5) Operation

Utilizing a music recording/reproducing device which can access the host computer's comprehensive database of information on musical recordings (such as recorded music data, record lists, composers, titles, performers, etc.) the system allows a search for the desired music recording information, such as a recording list, utilizing TV monitors connected to the system or the dedicated computer monitor to display the information. When the desired music information is found by the system, the recording/reproducing device sends a signal notifying to the host computer that it wants to download the recorded music data. The host computer then sends the data to the recording device utilizing a timesharing or a packet switching method thereby enabling the data to be downloaded to the recording device RAM to be digitally recorded.

(6) Embodiment

Figure 1 shows a simple block diagram of the embodiment of the present invention's recording/reproducing device which transmits data via personal computers. Figure 2 is a simple block diagram which shows the Automated Music Purchasing System network.

Though the recording/reproducing device (1) can be used employing recordable optical discs

which can read immediately after writing, or employing a digital audio tape recorder. For the purpose of simplicity, the following section is explained using compact disc recorder:

In the recording/reproducing device (1), NCU (telephone network control unit) (2) is employed as the computer communication method; using modem (3), communication LSI (4), CPU (5), output frame buffer (6) and picture signal generator (7).

NCU (2) is connected to the external telephone line (8), with telephone (9) connecting the NCU (2) and the modem (3). CPU (5) is connected to the recordable- optical disk recording/reproducing device (10), as well as to the external control unit (11). The image signal transmission device is connected to the external monitor (12).

The said recording/reproducing device (1) is connected to the Automated Music Purchasing System Network as shown in Figure 2. This Automatic Music Purchasing System is made up of the said recording/reproducing device (1) and the monitor (12), which is connected to the recording/reproducing device (1), which are set up as terminals in each user's household with the recording/reproducing device (1) connected to the communications line network (13) utilizing a timesharing or packet switching method. The communications line network (13) can employ either a public telephone company service or an optical cable-dedicated communication line (though preferably it should be an optical cable-dedicated communication line). The recording/reproducing device (1) is connected to the host computer's data base (14) via the communications line network (13). The host computer data base (14) stores record company (15) record music data of digitally recorded or digitally recorded analog music A, its record list B and record information on composers, names of music and performers, etc.

The network system, made up in the above-described manner, is a two-way communication system and transmission control system as well as a transmission control system that employs either basic control mode procedure or HDLC procedure for the network system.

Operation procedures for this invention are outlined as follows:

- a) Control unit (11) sends an access signal
- b) The access signal is processed by the communication LSI(4)'s CPU (5) and is sent to modem (3). The digital signal is converted to analog by modem (3); then, via the NCU (2), telephone line (8) is changed from telephone device (9) to computer which then accesses host computer (14).
- c) The accessed host computer (14) sends a response signal (menu screen data) which is

processed via the recording/reproducing device (1) in a set of procedures which are the reverse of those employed when the recording/reproducing device (1) sent the original signal.

d) Using the monitor screen (12), user chooses desired data using control unit (11) sending selection data in the same order of the initial transmission procedures as shown below:

CPU (5) ⇔ communication LSI (4) ⇒ modem (3) ⇒ NUC (2) ⇒ telephone line (8)

e) When the desired data has been found, user accesses and processes the data from the host computer (14) via telephone line (8) ⇒ NUC (2) ⇒ modem (3) ⇒ communication LSI (4) ⇔ CPU (5) and then downloads the record music data to RAM which records data onto recordable optical disc using the optical disk recording/reproducing device.

(7) Effect of the invention

With this invention, a record company need only to maintain the data of recorded music and would therefore not require the current distribution channels which would result in considerable cost reduction. In addition, user would be able to easily as well as freely search for and purchase desired music from home. Furthermore, since the recording data becomes the merchandize itself, discontinuing music will not become necessary as it does in the conventional selling system. New users can also be easily drawn in to the system at little cost.

4. Brief Description of the Drawings:

Figure 1 is a simple block diagram of an embodiment of the recording/reproducing device used in this invention, and Figure 2 is a simple block diagram which shows the Automated Music Purchasing System Network.

Patent Applicant: Hisanobu Akashi

- 1: Recording/reproducing device
- 2: NCU
- 3: Modem
- 4: Communication LSI
- 5: CPU
- 6: Output frame buffer
- 7: Picture signal generator
- 8: Telephone line
- 9: Telephone devise
- 10: Optical disk recording/reproducing device

- 11: Control unit
- 12: Monitor
- 13: Communications line network
- 14: Host computer
- 15: Record company

Figure 1

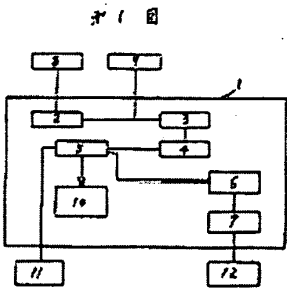
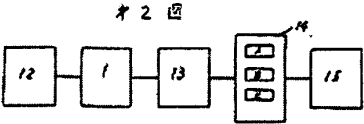

Figure 2





UNITED STATES PATENT AND TRADEMARK OFFICE

UNITED STATES DEPARTMENT OF COMMERCE
 United States Patent and Trademark Office
 Address: COMMISSIONER FOR PATENTS
 P.O. Box 1450
 Alexandria, Virginia 22313-1450
 www.uspto.gov



Bib Data Sheet

CONFIRMATION NO. 2998

SERIAL NUMBER 90/007,402	FILING OR 371(c) DATE 01/31/2005 RULE	CLASS 369	GROUP ART UNIT 2655	ATTORNEY DOCKET NO. NAPS001
------------------------------------	---	---------------------	-------------------------------	---------------------------------------

APPLICANTS
 5191573, Residence Not Provided;
 Sightsound.com Incorporated(Owner), Mt. Lebanon, PA;
 Napster, Inc.(3rd Pty. Req.), Los Angeles, CA;
 Albert S. Penilla, Sunnyvale, CA

**** CONTINUING DATA *******
 This application is a REX of 07/586,391 09/18/1990 PAT 5,191,573
 which is a CON of 07/206,497 06/13/1988 ABN

**** FOREIGN APPLICATIONS *******

Foreign Priority claimed <input type="checkbox"/> yes <input type="checkbox"/> no	STATE OR COUNTRY	SHEETS DRAWING	TOTAL CLAIMS 6	INDEPENDENT CLAIMS 2
35 USC 119 (a-d) conditions met <input type="checkbox"/> yes <input type="checkbox"/> no <input type="checkbox"/> Met after Allowance				
Verified and Acknowledged	Examiner's Signature	Initials		

ADDRESS
 Ansel M. Schwartz
 425 N. Craig Street Suite 301
 Pittsburgh ,PA 15213

TITLE
 METHOD FOR TRANSMITTING A DESIRED DIGITAL VIDEO OR AUDIO SIGNAL

FILING FEE RECEIVED 2520	FEES: Authority has been given in Paper No. _____ to charge/credit DEPOSIT ACCOUNT No. _____ for following:	<input type="checkbox"/> All Fees
		<input type="checkbox"/> 1.16 Fees (Filing)
		<input type="checkbox"/> 1.17 Fees (Processing Ext. of time)
		<input type="checkbox"/> 1.18 Fees (Issue)
		<input type="checkbox"/> Other _____
		<input type="checkbox"/> Credit

Reexamination	Control No.	Applicant(s)
	90/007402	5191573
	Certificate Date	Certificate Number

Requester	Correspondence Address:	<input type="checkbox"/> Patent Owner	<input checked="" type="checkbox"/> Third Party
<p>Albert S. Penilla MARTINE PENILLA & GENCARELLA, LLP 710 Lakeway Drive Suite 200 Sunnyvale CA 94085</p>			

LITIGATION REVIEW <input type="checkbox"/>	(examiner initials)	(date)
Case Name	Director Initials	

COPENDING OFFICE PROCEEDINGS	
TYPE OF PROCEEDING	NUMBER
1.	
2.	
3.	
4.	

Application Number 	Application No. 90/007,402	Applicant(s) 5191573	
	Examiner	Art Unit 2655	

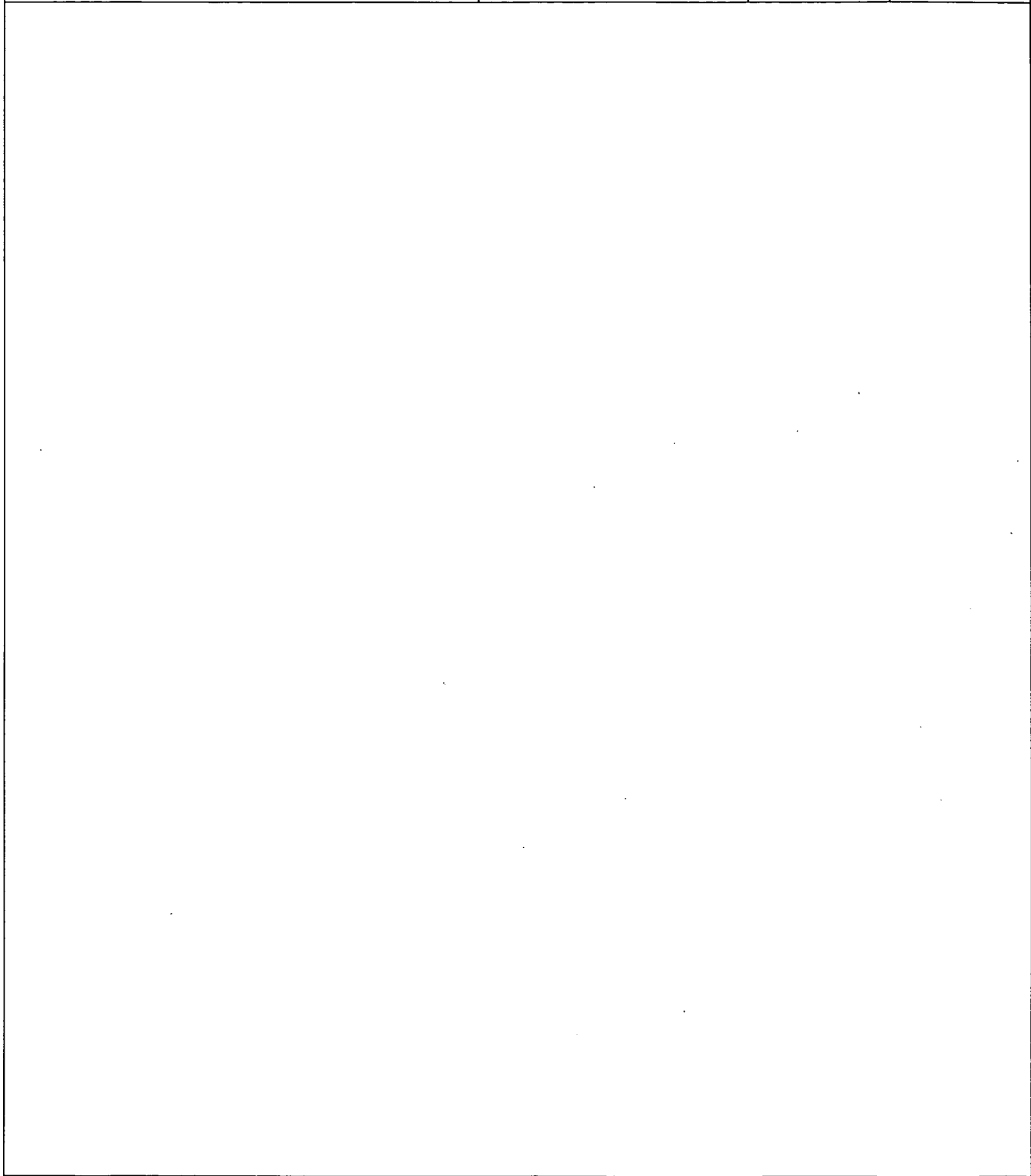

Index of Claims



Application No.

90/007,402

Examiner

Applicant(s)

5191573

Art Unit

2655

√	Rejected
=	Allowed

-	(Through numeral) Cancelled
÷	Restricted

N	Non-Elected
I	Interference

A	Appeal
O	Objected

Claim		Date									
Final	Original										
1											
2											
3											
4											
5											
6											
7											
8											
9											
10											
11											
12											
13											
14											
15											
16											
17											
18											
19											
20											
21											
22											
23											
24											
25											
26											
27											
28											
29											
30											
31											
32											
33											
34											
35											
36											
37											
38											
39											
40											
41											
42											
43											
44											
45											
46											
47											
48											
49											
50											

Claim		Date									
Final	Original										
51											
52											
53											
54											
55											
56											
57											
58											
59											
60											
61											
62											
63											
64											
65											
66											
67											
68											
69											
70											
71											
72											
73											
74											
75											
76											
77											
78											
79											
80											
81											
82											
83											
84											
85											
86											
87											
88											
89											
90											
91											
92											
93											
94											
95											
96											
97											
98											
99											
100											

Claim		Date									
Final	Original										
101											
102											
103											
104											
105											
106											
107											
108											
109											
110											
111											
112											
113											
114											
115											
116											
117											
118											
119											
120											
121											
122											
123											
124											
125											
126											
127											
128											
129											
130											
131											
132											
133											
134											
135											
136											
137											
138											
139											
140											
141											
142											
143											
144											
145											
146											
147											
148											
149											
150											

Issue Classification 	Application No. 90/007,402	Applicant(s) 5191573	
	Examiner	Art Unit 2655	

ISSUE CLASSIFICATION											
ORIGINAL				CROSS REFERENCE(S)							
CLASS	SUBCLASS			CLASS	SUBCLASS (ONE SUBCLASS PER BLOCK)						
369	084										
INTERNATIONAL CLASSIFICATION											
			/								
			/								
			/								
			/								
			/								
(Assistant Examiner) (Date)				(Primary Examiner) (Date)						Total Claims Allowed:	
(Legal Instruments Examiner) (Date)										O.G. Print Claim(s)	

<input type="checkbox"/> Claims renumbered in the same order as presented by applicant		<input type="checkbox"/> CPA		<input type="checkbox"/> T.D.		<input type="checkbox"/> R.1.47	
Final	Original	Final	Original	Final	Original	Final	Original
	1		31		61		91
	2		32		62		92
	3		33		63		93
	4		34		64		94
	5		35		65		95
	6		36		66		96
	7		37		67		97
	8		38		68		98
	9		39		69		99
	10		40		70		100
	11		41		71		101
	12		42		72		102
	13		43		73		103
	14		44		74		104
	15		45		75		105
	16		46		76		106
	17		47		77		107
	18		48		78		108
	19		49		79		109
	20		50		80		110
	21		51		81		111
	22		52		82		112
	23		53		83		113
	24		54		84		114
	25		55		85		115
	26		56		86		116
	27		57		87		117
	28		58		88		118
	29		59		89		119
	30		60		90		120
							121
							122
							123
							124
							125
							126
							127
							128
							129
							130
							131
							132
							133
							134
							135
							136
							137
							138
							139
							140
							141
							142
							143
							144
							145
							146
							147
							148
							149
							150
							151
							152
							153
							154
							155
							156
							157
							158
							159
							160
							161
							162
							163
							164
							165
							166
							167
							168
							169
							170
							171
							172
							173
							174
							175
							176
							177
							178
							179
							180
							181
							182
							183
							184
							185
							186
							187
							188
							189
							190
							191
							192
							193
							194
							195
							196
							197
							198
							199
							200
							201
							202
							203
							204
							205
							206
							207
							208
							209
							210

Search Notes



Application No.	Applicant(s)
90/007,402	5191573
Examiner	Art Unit
	2655

SEARCHED			
Class	Subclass	Date	Examiner

INTERFERENCE SEARCHED			
Class	Subclass	Date	Examiner

SEARCH NOTES (INCLUDING SEARCH STRATEGY)		
	DATE	EXMR

Patent Assignment Abstract of Title

Total Assignments: 3

Application #: 07586391 **Filing Dt:** 09/18/1990 **Patent #:** 5191573 **Issue Dt:** 03/02/1993

PCT #: NONE

Publication #: NONE

Pub Dt:

Inventor: ARTHUR R. HAIR

Title: METHOD FOR TRANSMITTING A DESIRED DIGITAL VIDEO OR AUDIO SIGNAL

Assignment: 1

Reel/Frame: 007656/0701 **Received:** 10/20/1995 **Recorded:** 10/02/1995 **Mailed:** 02/21/1996 **Pages:** 4

Conveyance: ASSIGNMENT OF ASSIGNORS INTEREST (SEE DOCUMENT FOR DETAILS).

Assignor: HAIR, ARTHUR R.

Exec Dt: 09/20/1995

Assignee: PARSEC SIGHT/SOUND, INC.

1518 ALLISON DRIVE
UPPER ST. CLAIR, PENNSYLVANIA 15241

Correspondent: ANSEL M. SCHWARTZ
425 N. CRAIG STREET
PITTSBURGH, PA 15123

Assignment: 2

Reel/Frame: 010776/0703 **Received:** 05/16/2000 **Recorded:** 05/03/2000 **Mailed:** 07/14/2000 **Pages:** 16

Conveyance: CHANGE OF NAME (SEE DOCUMENT FOR DETAILS).

Assignor: PARSEC SIGHT/SOUND, INC.

Exec Dt: 04/26/2000

Assignee: SIGHTSOUND.COM INCORPORATED
733 WASHINGTON ROAD, SUITE 400
MT. LEBANON, PENNSYLVANIA 15228

Correspondent: ANSEL M. SCHWARTZ
ONE STERLING PLAZA
201 N. CRAIG STREET, SUITE 304
PITTSBURGH, PA 15213

Assignment: 3

Reel/Frame: 012506/0415 **Received:** 01/30/2002 **Recorded:** 10/24/2001 **Mailed:** 04/25/2002 **Pages:** 6

Conveyance: NOTICE OF GRANT OF SECURITY INTEREST

Assignor: SIGHTSOUND TECHNOLOGIES, INC.

Exec Dt: 10/01/2001

Assignees: KENYON & KENYON

ONE BROADWAY
NEW YORK, NEW YORK 10004
SCHWARTZ, ANSEL M.
ONE STERLING PLAZA
201 N. CRAIG STREET, SUITE 304
PITTSBURGH, PENNSYLVANIA 15213
WATERVIEW PARTNERS, LLP
ONE STERLING PLAZA
152 WEST 57TH STREET, 46TH FLOOR
NEW YORK, NEW YORK 10019
D&DF WATERVIEW PARTNERS, L.P.

ONE STERLING PLAZA
152 WEST 57TH STREET, 46TH FLOOR
NEW YORK, NEW YORK 10019

Correspondent: PAUL, WEISS, RIFKIND, WHARTON & GARRISON
DEBORAH HARTNETT
1285 AVENUE OF THE AMERICAS
NEW YORK, NY 10019

Search Results as of: 2/25/2005 4:37:41 P.M.

If you have any comments or questions concerning the data displayed, contact OPR / Assignments at 703-308-9723
Web interface last modified: Oct. 5, 2002



UNITED STATES PATENT AND TRADEMARK OFFICE

UNITED STATES DEPARTMENT OF COMMERCE
United States Patent and Trademark Office
Address: COMMISSIONER FOR PATENTS
P.O. Box 1430
Alexandria, Virginia 22313-1450
www.uspto.gov

REEXAM CONTROL NUMBER	FILING OR 371 (c) DATE	PATENT NUMBER
90/007,402	01/31/2005	5191573

CONFIRMATION NO. 2998

Albert S. Penilla
MARTINE PENILLA & GENCARELLA LLP
710 Lakeway Drive Suite 200
Sunnyvale, CA 94085



Date Mailed: 02/28/2005

NOTICE OF REEXAMINATION REQUEST FILING DATE

(Third Party Requester)

Requester is hereby notified that the filing date of the request for reexamination is 01/31/2005, the date the required fee of \$2,520 was received.

A decision on the request for reexamination will be mailed within three months from the filing date of the request for reexamination. (See 37 CFR 1.515(a)).

A copy of the Notice is being sent to the person identified by the requester as the patent owner. Further patent owner correspondence will be the latest attorney or agent of record in the patent file. (See 37 CFR 1.33). Any paper filed should include a reference to the present request for reexamination (by Reexamination Control Number).

cc: Patent Owner

Ansel M. Schwartz
425 N. Craig Street Suite 304-
Pittsburgh, PA 15213

M. A. Smith

Office of Patent Legal Administration
Central Reexamination Unit (571) 272-7750 ; FAX (571) 273-0100

PART 3 - OFFICE COPY

UNITED STATES PATENT AND TRADEMARK OFFICE

UNITED STATES DEPARTMENT OF COMMERCE
 United States Patent and Trademark Office
 Address: COMMISSIONER FOR PATENTS
 P.O. Box 1450
 Alexandria, Virginia 22313-1450
 www.uspto.gov

REEXAM CONTROL NUMBER	FILING OR 371 (c) DATE	PATENT NUMBER
90/007,402	01/31/2005	5191573

Ansel M. Schwartz
 425 N. Craig Street Suite 304
 Pittsburgh, PA 15213

CONFIRMATION NO. 2998

REEXAM ASSIGNMENT NOTICE



OC000000015285419

Date Mailed: 02/28/2005

NOTICE OF ASSIGNMENT OF REEXAMINATION REQUEST

The above-identified request for reexamination has been assigned to Art Unit 2655. All future correspondence to the proceeding should be identified by the control number listed above and directed to the assigned Art Unit.

A copy of this Notice is being sent to the latest attorney or agent of record in the patent file or to all owners of record. (See 37 CFR 1.33(c)). If the addressee is not, or does not represent, the current owner, he or she is required to forward all communications regarding this proceeding to the current owner(s). An attorney or agent receiving this communication who does not represent the current owner(s) may wish to seek to withdraw pursuant to 37 CFR 1.36 in order to avoid receiving future communications. If the address of the current owner(s) is unknown, this communication should be returned within the request to withdraw pursuant to Section 1.36.

cc: Third Party Requester(if any)

Albert S. Penilla
 MARTINE PENILLA & GENCARELLA LLP
 710 Lakeway Drive Suite 200
 Sunnyvale, CA 94085

 Office of Patent Legal Administration

Central Reexamination Unit (571) 272-7750 ; FAX (571) 273-0100

PART 3 - OFFICE COPY

Access DB# 14702

SEARCH REQUEST FORM

Scientific and Technical Information Center

Requester's Full Name: Pinchus Laufer Examiner #: 73139 Date: 3/2/05
Art Unit: 2100 Phone Number 272-3599 Serial Number: 90/007,402
Mail Box Location: 1C81 Results Format Preferred (circle): PAPER DISK E-MAIL

If more than one search is submitted, please prioritize searches in order of need.

Please provide a detailed statement of the search topic, and describe as specifically as possible the subject matter to be searched. Include the elected species or structures, keywords, synonyms, acronyms, and registry numbers, and combine with the concept or utility of the invention. Define any terms that may have a special meaning. Give examples or relevant citations, authors, etc, if known. Please attach a copy of the cover sheet, pertinent claims, and abstract.

Title of Invention: _____

Inventors (please provide full names): _____

Earliest Priority Filing Date: _____

**For Sequence Searches Only* Please include all pertinent information (parent, child, divisional, or issued patent numbers) along with the appropriate serial number.*

Litigation
5,191,573

Inventor: Arthur R. Hair

O.G. Date March 29, 2005

STAFF USE ONLY	Type of Search	Vendors and cost where applicable
Searcher: <u>Shirelle Green</u>	Sequence (#) _____	<u>STN</u>
Searcher Phone #: <u>306-4767</u>	AA Sequence (#) _____	Dialog _____
Searcher Location: <u>4B40</u>	Structure (#) _____	<u>Questel/Orbit 24.68</u>
Date Searcher Picked Up: <u>3/8/05</u>	Bibliographic _____	Dr.Link _____
Date Completed: <u>3/8/05</u>	Litigation <input checked="" type="checkbox"/>	<u>Lexis/Nexis</u>
Searcher Prep & Review Time: _____	Fulltext _____	Sequence Systems _____
Clerical Prep Time: _____	Patent Family _____	<u>WWW/Internet</u>
Online Time: <u>15</u>	Other _____	Other (specify) _____

1 of 1 DOCUMENT

UNITED STATES PATENT AND TRADEMARK OFFICE GRANTED PATENT

5191573

Link to Claims Section

March 2, 1993

Method for transmitting a desired digital video or audio signal

REEXAM-LITIGATE:

NOTICE OF LITIGATION

Sightsound Technologies, Inc., a Delaware corporation v. Roxio, Inc., a Delaware corporation, et al, Filed October 8, 2004, D.C. W.D. Pennsylvania (Pittsburgh), Doc. No. 04-CV-1549

INVENTOR: Hair, Arthur R. - 301 Oaklawn Dr., Pittsburgh, Pennsylvania, United States (US), 15241

APPL-NO: 586391 (07)

FILED-DATE: September 18, 1990

GRANTED-DATE: March 2, 1993

ASSIGNEE-AFTER-ISSUE: October 2, 1995 - ASSIGNMENT OF ASSIGNORS INTEREST (SEE DOCUMENT FOR DETAILS)., PARSEC SIGHT/SOUND, INC. 1518 ALLISON DRIVE UPPER ST. CLAIR PENNSYLVANIA 15241, Reel and Frame Number: 07656/0701

May 3, 2000 - CHANGE OF NAME (SEE DOCUMENT FOR DETAILS)., SIGHTSOUND.COM INCORPORATED 733 WASHINGTON ROAD, SUITE 400 MT. LEBANON PENNSYLVANIA 15228, Reel and Frame Number: 10776/0703

October 24, 2001 - NOTICE OF GRANT OF SECURITY INTEREST, D&DF WATERVIEW PARTNERS, L.P. ONE STERLING PLAZA 152 WEST 57TH STREET, 46TH FLOOR NEW YORK NEW YORK 10019; KENYON & KENYON ONE BROADWAY NEW YORK NEW YORK 10004; SCHWARTZ, ANSEL M. ONE STERLING PLAZA 201 N. CRAIG STREET, SUITE 304 PITTSBURGH PENNSYLVANIA 15213; WATERVIEW PARTNERS, LLP ONE STERLING PLAZA 152 WEST 57TH STREET, 46TH FLOOR NEW YORK NEW YORK 10019, Reel and Frame Number: 12506/0415

ENGLISH-ABST:

The present invention is a method for transmitting a desired digital video or audio signal stored on a first memory of a first party to a second memory of a second party. The method comprises the steps of transferring money via a telecommunications line to the first party from the second party. Additionally, the method comprises the step of then connecting electronically via a telecommunications line the first memory with the second memory such that the desired signal can pass therebetween. Next, there is the step of transmitting the desired digital signal from the first memory with a transmitter in control and in possession of the first party to a receiver having the second memory at a location determined by the second party. The receiver is in possession and in control of the second party. There is also the step of then storing the digital signal in the second memory.

LEXIS-NEXIS
Library: PATENTS
File: ALL

1 of 2 DOCUMENTS

Sightsound.com, Inc. v. N2K, Inc.

Civil Action No. 98-0118

**UNITED STATES DISTRICT COURT FOR THE WESTERN DISTRICT OF
PENNSYLVANIA**

2003 U.S. Dist. LEXIS 25503

October 23, 2003, Decided

DISPOSITION: [*1] Defendants' motion for summary judgment denied. Plaintiff's motion for summary judgment dismissing defendants' affirmative defenses and counterclaims granted.

CASE SUMMARY:

PROCEDURAL POSTURE: In plaintiff patentee's infringement action, defendant company moved for summary judgment on grounds that the patents-in-suit were invalid and that the patentee's method of calculating damages was invalid. The patentee moved for summary judgment with regard to the affirmative defense and counterclaims of inequitable conduct.

OVERVIEW: Claims of the patents related to copy protection features believed to be commercially desirable for preventing unauthorized copying of downloaded files. The company argued the claims lacked enablement required by 35 U.S.C.S. § 112; alternatively, they and the other asserted claims were anticipated by prior art under 35 U.S.C.S. § 102 or were rendered obvious under 35 U.S.C.S. § 103. The company's enablement argument rested on an overly restrictive definition of "prevent." The patentee's definition of "prevent" set out in its brief in opposition ("presenting a technical obstacle sufficient to impede the ordinary customer from duplicating the purchased digital audio signal") was appropriate to the facts. The anticipation claim failed; inter alia, a patent issued to a Japanese inventor described only the possibility of using a control unit in a way that anticipated the use of one of the patents-in-suit, not the necessity required by law. The obviousness claim also failed; numerous disputed questions of fact existed, including the teachings of prior art references, what one skilled in the art in 1988 would be motivated to combine, and the weight to be given to secondary considerations.

OUTCOME: The patentee's motion was granted. The company's motion was denied.

OPINION:

... [*3] download music to their personal computers over telecommunications lines. (Id.)

Several years later, on March 2, 1993, the United States Patent and Trademark Office ("PTO") issued *United States Patent No. 5,191,573* ("the '573 Patent") to Mr. Hair who later assigned [*4] all his rights, title and interest in the '573 Patent to a company he co-founded, known as Parsec Sight/Sound, Inc. ("Parsec.") He also assigned to Parsec two ...

LEXIS-NEXIS
Library: PATENTS
File: CASES

2 of 2 DOCUMENTS

Sightsound.com Inc. v. N2k, Inc.

Civil Action No. 98-118

UNITED STATES DISTRICT COURT FOR THE WESTERN DISTRICT OF
PENNSYLVANIA

185 F. Supp. 2d 445; 2002 U.S. Dist. LEXIS 6828

February 8, 2002, Decided

DISPOSITION: **[**1]** Defendants' objection overruled and exhibit admitted into evidence.

CASE SUMMARY:

PROCEDURAL POSTURE: In this patent infringement action, plaintiff, the patent holder, sought to introduce an exhibit from the deposition testimony of the inventor. The defendants, the alleged infringers, objected.

OVERVIEW: This was a patent infringement action filed by the holder of three patents which were directed to commercially-acceptable systems and methods for selling music and video in digital form over telecommunications lines. The holder accused the alleged infringers of infringing multiple claims of the patents through the practice of downloading digital music over the internet. The court held that the holder's proposed deposition designations were extrinsic evidence which was responsive to arguments made by the infringers. They were, in that respect, relevant to the inquiry before the court. In light of the fact that the undersigned sat in an advisory position, and that the record should tend more towards over-inclusiveness than not, the court held that the exhibit would be admitted. After a hearing was held, at which expert testimony, demonstrative evidence, exhibits, and arguments were offered by the parties, the magistrate judge recommended several conclusions of law regarding claim construction.

OUTCOME: The alleged infringers' objection to the patent holder's exhibit was overruled, and the exhibit was admitted into evidence. The magistrate judge recommended that the claims in suit be construed in the manner set forth.

OPINION:

... **[*453]** **[**3]** Sightsound.com, Inc. ("Sightsound") accuses defendants N2K, Inc. ("N2K"), CDnow, Inc., and CDnow Online, Inc. (collectively referred to as "CDnow" or "defendants") of infringing multiple claims of U. **[**4]** S. Patent Nos. 5,191,573 ("the '573 Patent"), 5,675,734 ("the '734 Patent"), and 5,966,440 ("the '440 Patent") through the practice of downloading digital music over the internet. n1

n1 Of course, the court is not concerned with the accused product or practice at this ...

No Documents Found!

No documents were found for your search (**5191573** or **5,191,573**).
Click the "Edit Search" button below to try again. You may want to try one or more of the following:

- Check for spelling errors.
- Remove some search terms.
- Use a less restrictive date range.
- Use more common search terms. "Suggested Words and Concepts" are displayed on the search form when you click on Edit Search.

[Edit Search](#)

[About LexisNexis](#) | [Terms and Conditions](#)

Copyright © 2005 LexisNexis, a division of Reed Elsevier Inc. All rights reserved.

LEXIS-NEXIS
Library: PATENTS
File: JNLS

1 of 13 DOCUMENTS

Copyright 2004 Omega Communications, Inc.
Intellectual Property Today

April, 2004

SECTION: INTERNETINFO.COLUMN; Pg. 49

LENGTH: 718 words

HEADLINE: Will the Price of Music Downloads Include Patent License Fees?

BYLINE: BY W. SCOTT PETTY; Scott Petty, a Patent Attorney with King & Spalding, focuses on intellectual property issues for computer software, telecommunications and e-commerce companies. Scott can be contacted by telephone at 404.572.2888 or via e-mail at spetty@kslaw.com.

BODY:

...action against N2K, Inc. in the U.S. District Court for the Western District Court of Pennsylvania (Civil Action 98-0118). SightSound alleged that N2K, Inc. infringed U.S. Patent Nos. 5,191,573 and 5,675,734, which date back to a patent application filed in 1988, well in advance of the commercialization of the Internet. .CDNow, Inc. acquired N2K, Inc. in 2000. In turn, SightSound added ...

LEXIS-NEXIS
Library: NEWS
File: CURNEWS

2 of 13 DOCUMENTS

Copyright 2002 Gale Group, Inc.
ASAP
Copyright 2002 Rutgers University
Rutgers Computer & Technology Law Journal

March 22, 2002

SECTION: No. 1, Vol. 28; Pg. 61; ISSN: 0735-8938

IAC-ACC-NO: 84020686

LENGTH: 24588 words

HEADLINE: The multiple unconstitutionality of business method patents: common sense, congressional consideration, and constitutional history.

BYLINE: Pollack, Malla

BODY:

...business patents. See, e.g., 146 CONG. REC. E1659 (daily ed. of Oct. 4, 2000) (statement of Rep. Berman) (criticizing recent grant of obvious business patents including U.S. Patent No. 5,191,573 (issued Mar. 2 1993) for a method of selling audiovisual products over the internet and U.S. Patent No. 5,825,651 (issued Oct. 20, 1998) for a method of allowing internet ...

6 of 13 DOCUMENTS

Copyright 1999 The New York Law Publishing Company
The National Law Journal

November 22, 1999, Monday

SECTION: PATENT LAW; Pg. B9

LENGTH: 2106 words

HEADLINE: Business methods

BYLINE: Bradley C. Wright; Mr. Wright is a shareholder and registered patent attorney at Washington, D.C.'s Banner & Witcoff Ltd. He can be reached at wright@bannerwitcoff.com.

BODY:

...patent covering the sale of music in electronic form over a network, such as the Internet. The company, Parsec Sight/ Sound Inc., has sued N2K Inc. for infringing the patented method (Patent No. 5,191,573, titled "Method for Transmitting a Desired Digital Video or Audio Signal").

One reason these business-method patents are receiving more attention may be that the Internet has laid bare the advertising and sales techniques of ...

7 of 13 DOCUMENTS

Copyright 1999 Responsive Database Services, Inc.
Business and Management Practices
Mondaq Business Briefing - Hale and Dorr LLP, US

November 3, 1999

RDS-ACC-NO: 02275027

LENGTH: 2096 words

HEADLINE: US: Business Methods Patents - The Effects Of State Street On Electronic Commerce And The Internet

BYLINE: Alter, Scott M

BIBLIOGRAPHY:

7. Patent number 5,191,573 and 5,675,734
.....
...

8 of 13 DOCUMENTS

Copyright 1999 The New York Law Publishing Company
The National Law Journal

October 25, 1999, Monday

SECTION: INTELLECTUAL PROPERTY; Focus on Patent; Pg. C8

LENGTH: 2014 words

HEADLINE: 'State Street' sets stage for new patents, battles

BYLINE: BY SCOTT M. ALTER, SPECIAL TO THE NATIONAL LAW JOURNAL; Mr. Alter is a partner in the Washington, D.C., office of Boston's Hale and Dorr L.L.P.

BODY:

...transmitting a digital audio signal from the memory storage of a first party to the memory storage of a second party, in conjunction with the electronic transfer of money to the first party.

n6 Patent nos. 5,191,573 and 5,675,734.

Sightsound.com has been pursuing licensing fees from various companies that offer music that can be downloaded from the Internet. In a letter said to have been sent to some of these companies, Sightsound.com asserted that its patents control "the ...

9 of 13 DOCUMENTS

Copyright 1999 Aspen Publishers, Inc., All rights reserved
The Computer Lawyer

October, 1999

SECTION: PATENT; Vol. 16, No. 10; Pg. 3

LENGTH: 11742 words

HEADLINE: What the General Intellectual Property Practitioner Should Know about Patenting Business Methods

BYLINE: by David L. Hayes; David L. Hayes is a partner and is Chairman of the Intellectual Property Practice Group at Fenwick & West in Palo Alto. CA. Copyright © 1999 Fenwick & West LLP.

BODY:

...system. The items purchased in the store by the customer are recorded, and any matches between the coupons selected and the items purchased are determined electronically. The customer is immediately credited in accordance with the terms of the matched coupons.

5,191,573

Title: "Method for Transmitting a Desired Digital Video or Audio Signal"

Priority Filing Date: June 13, 1988

Issue Date: Mar. 2, 1993

Held by: Originally issued to ...

...by Sightsound.com.

Synopsis: Contains correlative system claims for a system that implements the general method for transmitting digital content on demand claimed in US Pat. No. 5,191,573 described above.

Enforcement: In January 1999, a company called Sightsound.com asserted this and the 5,191,573 patent above against MP3.com and GoodNoise Corp. See note above.

5,692,132

Title: "System and Method for Conducting Cashless Transactions on a Computer Network"

Priority Filing Date: ...

10 of 13 DOCUMENTS

Copyright 1999 Salon.com, Inc.
Salon.com

March 9, 1999 Tuesday

SECTION: Feature

LENGTH: 2469 words

HEADLINE: How can they patent that?

BYLINE: By Peter Wayner

BODY:

...an American: They "invented" the practice of locking up the data traveling over the Internet between the customer and the store -- that is, they use encryption functions to hide credit card account numbers from prying eyes.

Or consider patents 5191573 and 5675734, created by Arthur Hair when he lived in Pittsburgh. He claims to have invented the concept of "selling electronically ... through telecommunications lines, the desired digital video or digital audio signals" -- in short, pay- ...

...for argument in the system. Nonetheless, the material in the book can't be claimed as an invention by someone after the book is published.

Andrew Milne, an engineer for N2K, is evaluating what patents 5191573 and 5675734 mean to his company's plans for selling music over the Internet. He's already been doing research looking for past products and services that might qualify as prior art, and he's uncovered a wide range. ...

?us5191573/pn

** SS 1: Results 1

Search statement 2

?prt full nonstop legalall

1/1 PLUSPAT - (C) QUESTEL-ORBIT- image
PN - US5191573 A 19930302 [US5191573]
TI - (A) Method for transmitting a desired digital video or audio signal
PA - (A) HAIR ARTHUR R (US)
IN - (A) HAIR ARTHUR R (US)
AP - US58639190 19900918 [1990US-0586391]
FD - Cont. of US206497 19880613 [1988US-0206497] (Abandoned)
PR - US58639190 19900918 [1990US-0586391]
- US20649788 19880613 [1988US-0206497]
IC - (A) G11B-005/86 G11B-007/00 G11B-011/00
EC - G07F-017/16
- G11B-020/00P
- G11B-027/00V
- G11B-027/034
- G11B-027/10A1
- G11B-027/34
- H04H-001/02
- H04N-007/173B2
PCL - ORIGINAL (O) : 369084000; CROSS-REFERENCE (X) : 235380000 235381000
369015000 369085000
DT - Basic
CT - US3718906; US3990710; US4567359; US4647989; US4654799
STG - (A) United States patent
AB - The present invention is a method for transmitting a desired digital video or audio signal stored on a first memory of a first party to a second memory of a second party. The method comprises the steps of transferring money via a telecommunications line to the first party from the second party. Additionally, the method comprises the step of then connecting electronically via a telecommunications line the first memory with the second memory such that the desired signal can pass therebetween. Next, there is the step of transmitting the desired digital signal from the first memory with a transmitter in control and in possession of the first party to a receiver having the second memory at a location determined by the second party. The receiver is in possession and in control of the second party. There is also the step of then storing the digital signal in the second memory.

1/1 LGST - (C) EPO
PN - US5191573 A 19930302 [US5191573]
AP - US58639190 19900918 [1990US-0586391]
ACT - 19931221 US/CC-A
CERTIFICATE OF CORRECTION
- 19951002 US/AS02-A
ASSIGNMENT OF ASSIGNOR'S INTEREST
OWNER: PARSEC SIGHT/SOUND, INC. 1518 ALLISON DRIVE UPPER; EFFECTIVE
DATE: 19950920
- 19951002 US/AS02-A
ASSIGNMENT OF ASSIGNOR'S INTEREST
OWNER: HAIR, ARTHUR R.; EFFECTIVE DATE: 19950920
- 20000503 US/AS-A
ASSIGNMENT
OWNER: SIGHTSOUND.COM INCORPORATED 733 WASHINGTON ROAD, S; EFFECTIVE
DATE: 20000426
CHANGE OF NAME;ASSIGNOR:PARSEC SIGHT/SOUND, INC.;REEL/FRAME:010776/0703

- 20011024 US/AS-A
ASSIGNMENT
OWNER: KENYON & KENYON ONE BROADWAY NEW YORK NEW YORK 100; EFFECTIVE
DATE: 20011001
NOTICE OF GRANT OF SECURITY INTEREST;ASSIGNOR:SIGHTSOUND TECHNOLOGIES,
INC.;REEL/FRAME:012506/0415

- 20011024 US/AS-A
ASSIGNMENT
OWNER: SCHWARTZ, ANSEL M. ONE STERLING PLAZA 201 N. CRAIG; EFFECTIVE
DATE: 20011001
NOTICE OF GRANT OF SECURITY INTEREST;ASSIGNOR:SIGHTSOUND TECHNOLOGIES,
INC.;REEL/FRAME:012506/0415

- 20011024 US/AS-A
ASSIGNMENT
OWNER: WATERVIEW PARTNERS, LLP ONE STERLING PLAZA 152 WES; EFFECTIVE
DATE: 20011001
NOTICE OF GRANT OF SECURITY INTEREST;ASSIGNOR:SIGHTSOUND TECHNOLOGIES,
INC.;REEL/FRAME:012506/0415

- 20011024 US/AS-A
ASSIGNMENT
OWNER: D&DF WATERVIEW PARTNERS, L.P. ONE STERLING PLAZA 1; EFFECTIVE
DATE: 20011001
NOTICE OF GRANT OF SECURITY INTEREST;ASSIGNOR:SIGHTSOUND TECHNOLOGIES,
INC.;REEL/FRAME:012506/0415

UP - 2004-38

1/1 CRXX - (C) CLAIMS/RRX
PN - 5,191,573 A 19930302 [US5191573]
PA - Hair, Arthur R
ACT - 19951002 REASSIGNED
ASSIGNMENT OF ASSIGNORS INTEREST

Assignor: HAIR, ARTHUR R. DATE SIGNED: 09/20/1995

Assignee: PARSEC SIGHT/SOUND, INC. 1518 ALLISON DRIVE UPPER ST. CLAIR
PENNSYLVANIA 15241

Reel 007656/Frame 0701

Contact: ANSEL M. SCHWARTZ 425 N. CRAIG STREET PITTSBURGH, PA 15123

- 20000503 REASSIGNED
CHANGE OF NAME

Assignor: PARSEC SIGHT/SOUND, INC., DATE SIGNED: 04/26/2000

Assignee: SIGHTSOUND.COM INCORPORATED, 733 WASHINGTON ROAD, SUITE 400,
MT. LEBANON, PENNSYLVANIA, 15228

Reel 010776/Frame 0703

Contact: ANSEL M. SCHWARTZ, ONE STERLING PLAZA, 201 N. CRAIG STREET,
SUITE 304, PITTSBURGH, PA 15213

- 20011024 REASSIGNED
NOTICE OF GRANT OF SECURITY INTEREST

Assignor: SIGHTSOUND TECHNOLOGIES, INC., DATE SIGNED: 10/01/2001

Assignee: KENYON & KENYON, ONE BROADWAY, NEW YORK, NEW YORK, 10004
SCHWARTZ, ANSEL M., ONE STERLING PLAZA, 201 N. CRAIG STREET, SUITE

304, PITTSBURGH, PENNSYLVANIA, 15213
WATERVIEW PARTNERS, LLP, ONE STERLING PLAZA, 152 WEST 57TH STREET,
46TH FLOOR, NEW YORK, NEW YORK, 10019
D&DF WATERVIEW PARTNERS, L.P., ONE STERLING PLAZA, 152 WEST 57TH
STREET, 46TH FLOOR, NEW YORK, NEW YORK, 10019



Reel 012506/Frame 0415

Contact: PAUL, WEISS, RIFKIND, WHARTON & GARRISON, DEBORAH HARTNETT,
1285 AVENUE OF THE AMERICAS, NEW YORK, NY 10019

1/1 LITA - (C) Thomson Derwent
AN - P1998-06-59
FS - PATENT (P)
PN - US5191573 19930302 (Utility)
PF - not available
DF - not available
CT - not available
DN - not available
ACT - A complaint was filed.
OPN - US5675734

Search statement 2

?

 Reexamination 	Control No. 90/007,407 ²	Applicant(s)
	Certificate Date	Certificate Number

Requester	Correspondence Address:	<input type="checkbox"/> Patent Owner	<input checked="" type="checkbox"/> Third Party
<p>Albert S. Penilla MARTINE PENILLA & GENCARELLA LLP 710 Lakeway Drive, Suite 200 Sunnyvale, CA 94085</p>			

LITIGATION REVIEW <input type="checkbox"/>	BL (examiner initials)	3/16/05 (date)
Case Name		Director Initials
SightSound Technologies, Inc. v. Floxio 10/8/04 D.C. W.D. Pennsylvania (Ritz) Doc. No. 04-CV-1544		

COPENDING OFFICE PROCEEDINGS	
TYPE OF PROCEEDING	NUMBER
1. Reexam	90/007,402
2. Reexam	90/007,403
3. Pending Pending Applicant	09/286,892
4.	



UNITED STATES PATENT AND TRADEMARK OFFICE

UNITED STATES DEPARTMENT OF COMMERCE
United States Patent and Trademark Office
Address: COMMISSIONER FOR PATENTS
P.O. Box 1450
Alexandria, Virginia 22313-1450
www.uspto.gov

APPLICATION NO.	FILING DATE	FIRST NAMED INVENTOR	ATTORNEY DOCKET NO.	CONFIRMATION NO.
90/007,402	01/31/2005	5191573	NAPS001	2998

7590 03/18/2005
Ansel M. Schwartz
425 N. Craig Street Suite 301
Pittsburgh, PA 15213

EXAMINER

Lawler, Benjamin

ART UNIT PAPER NUMBER

2132

DATE MAILED: 03/18/2005

Please find below and/or attached an Office communication concerning this application or proceeding.



**UNITED STATES DEPARTMENT OF COMMERCE
Patent and Trademark Office**

Address: ASSISTANT COMMISSIONER FOR PATENTS

Washington, D.C. 20231

APPLICATION NO./ CONTROL NO.	FILING DATE	FIRST NAMED INVENTOR / PATENT IN REEXAMINATION	ATTORNEY DOCKET NO.
90/007,402	01/31/2005	5191573	NAPSP001

Albert S. Penilla
MARTINE PENILLA & GENCARELLA LLP
710 Lakeway Drive, Suite 200
Sunnyvale, CA 94085

EXAMINER

Lanier, Benjamin

ART UNIT	PAPER
----------	-------

2132

DATE MAILED: 03/18/05

Please find below and/or attached an Office communication concerning this application or proceeding.

Commissioner of Patents and Trademarks

CC: Ansel M. Schwartz
201 N. Craig Street, Suite 304
Pittsburgh, PA 15213



UNITED STATES PATENT AND TRADEMARK OFFICE

Commissioner for Patents
United States Patent and Trademark Office
P.O. Box 1450
Alexandria, VA 22313-1450
www.uspto.gov

DO NOT USE IN PALM PRINTER

(THIRD PARTY REQUESTER'S CORRESPONDENCE ADDRESS)

Napster, Inc.

Los Angeles Office

9044 Melrose Ave.

Los Angeles, CA 90069

EX PARTE REEXAMINATION COMMUNICATION TRANSMITTAL FORM

REEXAMINATION CONTROL NO. 90/007,402.

PATENT NO. 5191573.

ART UNIT 2132.

Enclosed is a copy of the latest communication from the United States Patent and Trademark Office in the above identified *ex parte* reexamination proceeding (37 CFR 1.550(f)).

Where this copy is supplied after the reply by requester, 37 CFR 1.535, or the time for filing a reply has passed, no submission on behalf of the *ex parte* reexamination requester will be acknowledged or considered (37 CFR 1.550(g)).

Order Granting / Denying Request For Ex Parte Reexamination	Control No. 90/007,402	Patent Under Reexamination 5191573	
	Examiner Benjamin E Lanier	Art Unit 2132	

--The MAILING DATE of this communication appears on the cover sheet with the correspondence address--

The request for *ex parte* reexamination filed 31 January 2005 has been considered and a determination has been made. An identification of the claims, the references relied upon, and the rationale supporting the determination are attached.

Attachments: a) PTO-892, b) PTO-1449, c) Other: _____

1. The request for *ex parte* reexamination is GRANTED.

RESPONSE TIMES ARE SET AS FOLLOWS:

For Patent Owner's Statement (Optional): TWO MONTHS from the mailing date of this communication (37 CFR 1.530 (b)). **EXTENSIONS OF TIME ARE GOVERNED BY 37 CFR 1.550(c).**

For Requester's Reply (optional): TWO MONTHS from the **date of service** of any timely filed Patent Owner's Statement (37 CFR 1.535). **NO EXTENSION OF THIS TIME PERIOD IS PERMITTED.** If Patent Owner does not file a timely statement under 37 CFR 1.530(b), then no reply by requester is permitted.

2. The request for *ex parte* reexamination is DENIED.

This decision is not appealable (35 U.S.C. 303(c)). Requester may seek review by petition to the Commissioner under 37 CFR 1.181 within ONE MONTH from the mailing date of this communication (37 CFR 1.515(c)). **EXTENSION OF TIME TO FILE SUCH A PETITION UNDER 37 CFR 1.181 ARE AVAILABLE ONLY BY PETITION TO SUSPEND OR WAIVE THE REGULATIONS UNDER 37 CFR 1.183.**

In due course, a refund under 37 CFR 1.26 (c) will be made to requester:

- a) by Treasury check or,
- b) by credit to Deposit Account No. _____, or
- c) by credit to a credit card account, unless otherwise notified (35 U.S.C. 303(c)).

cc:Requester (if third party requester)

DETAILED ACTION

Reexamination

1. The patent owner is reminded of the continuing responsibility under 37 CFR 1.565(a) to apprise the Office of any litigation activity, or other prior or concurrent proceeding, involving Patent No. 5,191,573 throughout the course of this reexamination proceeding. The third party requester is also reminded of the ability to similarly apprise the Office of any such activity or proceeding throughout the course of this reexamination proceeding. See MPEP §§ 2207, 2282 and 2286.
2. A substantial new question of patentability affecting claims 1-6 of United States Patent Number 5,191,573 ("the '573 patent") is raised by the request for *ex parte* reexamination.
3. The prior art cited by the third party, specifically Gallagher (GB 2,178,275 A), Gremillet (U.S. Patent No. 4,499,568), and Freeny (U.S. Patent No. 4,528,643), were not previously cited or considered by the Examiner during the prosecution of the '573 patent or its parent application. Gallagher teaches a method, system and apparatus for transferring recorded digital audio and video data between a source unit, a database housed by a record company and end user units. Gremillet discloses a process and system for vending digital audio and video information over telecommunication lines between a first memory of a first party and second memory of a second party. Freeny discloses a method of transmitting digital audio information stored on a first memory of a first party to a second memory of a second party. A reasonable examiner would consider the Gallagher and Gremillet references important in deciding whether or not the claims are patentable.

Art Unit: 2132

4. Extensions of time under 37 CFR 1.136(a) will not be permitted in these proceedings because the provisions of 37 CFR 1.136 apply only to "an applicant" and not to parties in a reexamination proceeding. Additionally, 35 U.S.C. 305 requires that *ex parte* reexamination proceedings "will be conducted with special dispatch" (37 CFR 1.550(a)). Extensions of time in *ex parte* reexamination proceedings are provided for in 37 CFR 1.550(c).

5. In order to ensure full consideration of any amendments, affidavits or declarations, or other documents as evidence of patentability, such documents must be submitted in response to this Office action. Submissions after the next Office action, which is intended to be a final action, will be governed by the requirements of 37 CFR 1.116, which will be strictly enforced.

6. The request for *Ex Parte* Reexamination of U.S. Patent No. 5,191,573 is **GRANTED**.

7. All claims 1-6 will be examined in this reexamination proceeding.

Conclusion

8. Any inquiry concerning this communication or earlier communications from the examiner should be directed to Benjamin E Lanier whose telephone number is 571-272-3805. The examiner can normally be reached on M-Th 7:30am-5:00pm, F 7:30am-4pm.

If attempts to reach the examiner by telephone are unsuccessful, the examiner's supervisor, Gilberto Barron can be reached on 571-272-3799. The fax phone number for the organization where this application or proceeding is assigned is 703-872-9306.

Art Unit: 2132

Information regarding the status of an application may be obtained from the Patent Application Information Retrieval (PAIR) system. Status information for published applications may be obtained from either Private PAIR or Public PAIR. Status information for unpublished applications is available through Private PAIR only. For more information about the PAIR system, see <http://pair-direct.uspto.gov>. Should you have questions on access to the Private PAIR system, contact the Electronic Business Center (EBC) at 866-217-9197 (toll-free).



Benjamin E. Lanier

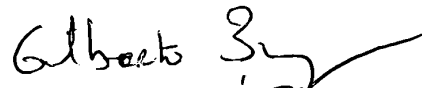

GILBERTO BARRÓN JR.
SUPERVISORY PATENT EXAMINER
TECHNOLOGY CENTER 2100

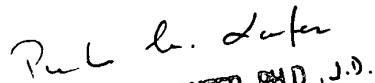

PAUL M. LAUFER, PH.D., J.D.
SPECIAL PROGRAM EXAMINER
TECHNOLOGY CENTER 2100



UNITED STATES PATENT AND TRADEMARK OFFICE

UNITED STATES DEPARTMENT OF COMMERCE
United States Patent and Trademark Office
Address: COMMISSIONER FOR PATENTS
P.O. Box 1450
Alexandria, Virginia 22313-1450
www.uspto.gov

APPLICATION NO.	FILING DATE	FIRST NAMED INVENTOR	ATTORNEY DOCKET NO.	CONFIRMATION NO.
90/007,402	01/31/2005	5191573	NAPS001	2998
	7590	06/21/2005	EXAMINER	
Ansel M. Schwartz 425 N. Craig Street Suite 301 Pittsburgh, PA 15213			ART UNIT	PAPER NUMBER

DATE MAILED: 06/21/2005

Please find below and/or attached an Office communication concerning this application or proceeding.



UNITED STATES PATENT AND TRADEMARK OFFICE

Commissioner for Patents
United States Patent and Trademark Office
P.O. Box 1450
Alexandria, VA 22313-1450
www.uspto.gov

DO NOT USE IN PALM PRINTER

(THIRD PARTY REQUESTER'S CORRESPONDENCE ADDRESS)

Albert S. Penilla
MARTINE PENILLA & GENCARELLA, LLP
710 Lakeway Drive, Suite 200
Sunnyvale, CA 94085

EX PARTE REEXAMINATION COMMUNICATION TRANSMITTAL FORM

REEXAMINATION CONTROL NO. 90/007,402.

PATENT NO. 5191573.

ART UNIT 2132.

Enclosed is a copy of the latest communication from the United States Patent and Trademark Office in the above identified *ex parte* reexamination proceeding (37 CFR 1.550(f)).

Where this copy is supplied after the reply by requester, 37 CFR 1.535, or the time for filing a reply has passed, no submission on behalf of the *ex parte* reexamination requester will be acknowledged or considered (37 CFR 1.550(g)).

Office Action in Ex Parte Reexamination	Control No. 90/007,402	Patent Under Reexamination 5191573	
	Examiner Benjamin E. Lanier	Art Unit 2132	

-- The MAILING DATE of this communication appears on the cover sheet with the correspondence address --

- a Responsive to the communication(s) filed on _____. b This action is made FINAL.
c A statement under 37 CFR 1.530 has not been received from the patent owner.

A shortened statutory period for response to this action is set to expire 2 month(s) from the mailing date of this letter. Failure to respond within the period for response will result in termination of the proceeding and issuance of an *ex parte* reexamination certificate in accordance with this action. 37 CFR 1.550(d). **EXTENSIONS OF TIME ARE GOVERNED BY 37 CFR 1.550(c).** If the period for response specified above is less than thirty (30) days, a response within the statutory minimum of thirty (30) days will be considered timely.

Part I THE FOLLOWING ATTACHMENT(S) ARE PART OF THIS ACTION:

- | | |
|--|---|
| 1. <input type="checkbox"/> Notice of References Cited by Examiner, PTO-892. | 3. <input type="checkbox"/> Interview Summary, PTO-474. |
| 2. <input checked="" type="checkbox"/> Information Disclosure Statement, PTO-1449. | 4. <input type="checkbox"/> _____. |

Part II SUMMARY OF ACTION

- 1a. Claims 1-6 are subject to reexamination.
- 1b. Claims _____ are not subject to reexamination.
2. Claims _____ have been canceled in the present reexamination proceeding.
3. Claims _____ are patentable and/or confirmed.
4. Claims 1-6 are rejected.
5. Claims _____ are objected to.
6. The drawings, filed on _____ are acceptable.
7. The proposed drawing correction, filed on _____ has been (7a) approved (7b) disapproved.
8. Acknowledgment is made of the priority claim under 35 U.S.C. § 119(a)-(d) or (f).
a) All b) Some* c) None of the certified copies have
1 been received.
2 not been received.
3 been filed in Application No. _____.
4 been filed in reexamination Control No. _____.
5 been received by the International Bureau in PCT application No. _____.
* See the attached detailed Office action for a list of the certified copies not received.
9. Since the proceeding appears to be in condition for issuance of an *ex parte* reexamination certificate except for formal matters, prosecution as to the merits is closed in accordance with the practice under *Ex parte* Quayle, 1935 C.D. 11, 453 O.G. 213.
10. Other: _____

cc: Requester (if third party requester)

DETAILED ACTION

Claim Rejections - 35 USC § 103

1. The following is a quotation of 35 U.S.C. 103(a) which forms the basis for all obviousness rejections set forth in this Office action:

(a) A patent may not be obtained though the invention is not identically disclosed or described as set forth in section 102 of this title, if the differences between the subject matter sought to be patented and the prior art are such that the subject matter as a whole would have been obvious at the time the invention was made to a person having ordinary skill in the art to which said subject matter pertains. Patentability shall not be negated by the manner in which the invention was made.

2. The factual inquiries set forth in *Graham v. John Deere Co.*, 383 U.S. 1, 148 USPQ 459 (1966), that are applied for establishing a background for determining obviousness under 35 U.S.C. 103(a) are summarized as follows:

1. Determining the scope and contents of the prior art.
2. Ascertaining the differences between the prior art and the claims at issue.
3. Resolving the level of ordinary skill in the pertinent art.
4. Considering objective evidence present in the application indicating obviousness or nonobviousness.

3. Claims 1-6 are rejected under 35 U.S.C. 103(a) as being unpatentable over Gallagher GB 2,178,275 A, in view of Freeny, U.S. Patent No. 4,528,643. Referring to claims 1, 3, 4, 6, Gallagher discloses a recorded data transfer system is provided for use in the entertainment industry where digital data is transferred between a source unit that stores the digital data in a database and individual user units (Abstract) that contain a means for storage the digital data and a transmitter/receiver interface for conducting the transfer (Page 1, lines 19-22), which meets the limitation of connecting electronically via a telecommunications line the first memory with the second memory such that the desired digital audio signal can pass there between, transmitting the desired digital audio signal from the first memory with a transmitter in control and possession of the first party to a receiver having the second memory at a location determined by the second

Art Unit: 2132

party, said receiver in possession and control of the second party. Once the source unit receives the digital data from the recording artists, the source unit stores the digital data and makes it available for sale to the general public via their user units (Page 1, lines 44-50). The user units contain a means for storing/recalling data received from the database (Page 1, lines 19-22), which meets the limitation of storing the digital signal in the second memory. Once the user receives and stores the digital data, the user can recall the digital data (Page 1, line 21) and playback the digital data on the user unit by way of a playback apparatus (Abstract). Gallagher does not go into specific detail about how this electronic sale of the digital data is made to the general public via their user units. Freeny discloses a method of electronically distributing and selling audio and video data by way of having the requesting user transmit a consumer credit card number along with their request for the audio and video data (Col. 13, lines 25-29). This step allows the owner of the data to approve the sale and charge the sale to the consumer credit card number (Col. 13, lines 30-31), which meets the limitation of transferring money electronically via a telecommunication line to the first party at a location remote from the second memory and controlling use of the first memory from the second party financially distinct from the first party, said second party controlling use and in possession of the second memory, the transferring step includes the step of telephoning the first party controlling use of the first memory by the second party, providing a credit card number of the second party controlling the second memory to the first party controlling the first memory so the second party is charged money. It would have been obvious to one of ordinary skill in the art at the time the invention was made to have the requesting user's of Gallagher transmit a consumer credit card number along with their request for the digital data so that the source unit could approve and charge the

sale of the digital data to the consumer credit card because this method of electronic sale allows the owner of the information to receive directly the compensation for sale of a recording and such compensation is received before the reproduction is authorized as taught in Freeny (Col. 13, lines 36-39).

Referring to claims 2, 5, Gallagher discloses that the users can log into the data base and make their selection of the desired audio or video data to be purchased (Page 1, lines 102-104), which meets the limitation of after the transferring step, the steps of searching the first memory for the desired digital audio signal, and selecting the desired digital audio signal from the first memory.

Conclusion

4. A shortened statutory period for response is set for **two month** from the mailing date of this Office Action.

In order to ensure full consideration of any amendments, affidavits or declarations, or other documents as evidence of patentability, such documents must be submitted in response to this Office action. Submissions after the next Office action, which is intended to be a final action, will be governed by the requirements of 37 DFR 1.116, which will be strictly enforced. The patent owner is reminded of the continuing responsibility under 37 CFR 1.565(a), to apprise the Office of any litigation activity, or other prior or concurrent proceeding, involving Patent No. 5,966,440 throughout the course of this reexamination proceeding. See MPEP §§ 2207, 2282 and 2286.

5. Any inquiry concerning this communication or earlier communications from the examiner should be directed to Benjamin E. Lanier whose telephone number is 571-272-3805. The examiner can normally be reached on M-Th 7:30am-5:00pm, F 7:30am-4pm.

If attempts to reach the examiner by telephone are unsuccessful, the examiner's supervisor, Gilberto Barron can be reached on 571-272-3799. The fax phone number for the organization where this application or proceeding is assigned is 703-872-9306.

Information regarding the status of an application may be obtained from the Patent Application Information Retrieval (PAIR) system. Status information for published applications may be obtained from either Private PAIR or Public PAIR. Status information for unpublished applications is available through Private PAIR only. For more information about the PAIR system, see <http://pair-direct.uspto.gov>. Should you have questions on access to the Private PAIR system, contact the Electronic Business Center (EBC) at 866-217-9197 (toll-free).

Benjamin E. Lanier

GILBERTO BARRÓN JR.
SUPERVISORY PATENT EXAMINER
TECHNOLOGY CENTER 2100

Reexam 90/007, 402

Form 1449 (Modified) Information Disclosure Statement By Applicant (Use Several Sheets if Necessary)	Atty Docket No: NAPSP001 Applicant: Arthur R. Hair Issue Date: March 2, 1993	U.S. Patent No. 5,191,573 Group: 2132
--	--	--

U.S. Patent Documents

Examiner Initial	No.	Patent No.	Date	Patentee	Class	Sub-class
HA BB BL	A	4,499,568	2/1985	Gremillet	 	
	B	4,528,643	7/1985	Freeny, Jr.		
	C	4,658,093	4/1987	Hellman		
	D					
	E					
	F					
	G					
	H					
	I					
	J					
	K					

Foreign Patent or Published Foreign Patent Application

Examiner Initial	No.	Document No.	Publication Date	Country or Patent Office	Class	Sub-class	Translation	
							Yes	No
HA BB	L	GB 2 178 275 A	2/1987	United Kingdom	 	 		
	M	62-284496	12/1987	Japan				X
	N							
	O							
	P							

Other Documents

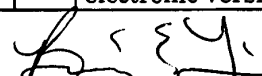
Examiner Initial	No.	Author, Title, Date, Place (e.g. Journal) of Publication
HA BB BL BL	Q	Jordan, Larry E. and Churchill, Bruce, <i>Communications and Networking for the IBM PC</i> , Robert J. Brady Co., Bowie, MD (1983).
	R	W. Rosch, "ComNet for the PC," <i>PC Magazine</i> , August 1983, pp. 225-228.
	S	E. Ferrarini, "Direct Connections for Software Selections," <i>Business Computer Systems</i> , February 1984, pp. 35+ (4 pages total).
	T	P. Elmer-DeWitt, "Calling up an on-line cornucopia; computer networks are supermarkets of services and information," <i>Time</i> , April 7, 1986 (two-page electronic version obtained at http://www.highbeam.com).
Examiner		
	Date Considered	6/13/05

Examiner: Initial citation considered. Draw line through citation if not in conformance and not considered. Include copy of this form with next communication to applicant.

Index of Claims



Application/Control No.

90/007,402

Examiner

Benjamin E. Lanier

Applicant(s)/Patent under Reexamination

5191573

Art Unit

2132

✓	Rejected
=	Allowed

-	(Through numeral) Cancelled
+	Restricted

N	Non-Elected
I	Interference

A	Appeal
O	Objected

Claim		Date			
Final	Original				
	1				
	2				
	3				
	4				
	5				
	6				
	7				
	8				
	9				
	10				
	11				
	12				
	13				
	14				
	15				
	16				
	17				
	18				
	19				
	20				
	21				
	22				
	23				
	24				
	25				
	26				
	27				
	28				
	29				
	30				
	31				
	32				
	33				
	34				
	35				
	36				
	37				
	38				
	39				
	40				
	41				
	42				
	43				
	44				
	45				
	46				
	47				
	48				
	49				
	50				

Claim		Date			
Final	Original				
	51				
	52				
	53				
	54				
	55				
	56				
	57				
	58				
	59				
	60				
	61				
	62				
	63				
	64				
	65				
	66				
	67				
	68				
	69				
	70				
	71				
	72				
	73				
	74				
	75				
	76				
	77				
	78				
	79				
	80				
	81				
	82				
	83				
	84				
	85				
	86				
	87				
	88				
	89				
	90				
	91				
	92				
	93				
	94				
	95				
	96				
	97				
	98				
	99				
	100				

Claim		Date			
Final	Original				
	101				
	102				
	103				
	104				
	105				
	106				
	107				
	108				
	109				
	110				
	111				
	112				
	113				
	114				
	115				
	116				
	117				
	118				
	119				
	120				
	121				
	122				
	123				
	124				
	125				
	126				
	127				
	128				
	129				
	130				
	131				
	132				
	133				
	134				
	135				
	136				
	137				
	138				
	139				
	140				
	141				
	142				
	143				
	144				
	145				
	146				
	147				
	148				
	149				
	150				



UNITED STATES PATENT AND TRADEMARK OFFICE

UNITED STATES DEPARTMENT OF COMMERCE
 United States Patent and Trademark Office
 Address: COMMISSIONER FOR PATENTS
 P.O. Box 1450
 Alexandria, Virginia 22313-1450
 www.uspto.gov



Bib Data Sheet

CONFIRMATION NO. 2998

SERIAL NUMBER	FILING OR 371(c) DATE	CLASS	GROUP ART UNIT	ATTORNEY DOCKET NO.	
90/007,402	01/31/2005	369	2655	NAPS001	
APPLICANTS					
5191573, Residence Not Provided; Sightsound.com Incorporated(Owner), Mt. Lebanon, PA; Napster, Inc.(3rd Pty. Req.), Los Angeles, CA; Albert S. Penilla, Sunnyvale, CA					
** CONTINUING DATA *****					
This application is a REX of 07/586,391 09/18/1990 PAT 5,191,573 <i>BC</i> which is a CON of 07/206,497 06/13/1988 ABN					
** FOREIGN APPLICATIONS ***** NONE <i>BC</i>					
Foreign Priority claimed <input type="checkbox"/> yes <input checked="" type="checkbox"/> no		STATE OR COUNTRY	SHEETS DRAWING	TOTAL CLAIMS	INDEPENDENT CLAIMS
35 USC 119 (a-d) conditions met <input type="checkbox"/> yes <input checked="" type="checkbox"/> no <input type="checkbox"/> Met after					
Verified and Acknowledged		Allowance <i>BC</i>		6	2
Examiner's Signature		Initials			
ADDRESS					
Ansel M. Schwartz 425 N. Craig Street Suite 301 Pittsburgh ,PA 15213					
TITLE					
METHOD FOR TRANSMITTING A DESIRED DIGITAL VIDEO OR AUDIO SIGNAL					
FILING FEE RECEIVED 2520	FEES: Authority has been given in Paper				<input type="checkbox"/> All Fees
	No. _____ to charge/credit DEPOSIT ACCOUNT				<input type="checkbox"/> 1.16 Fees (Filing)
	No. _____ for following:				<input type="checkbox"/> 1.17 Fees (Processing Ext. of time)
					<input type="checkbox"/> 1.18 Fees (Issue)
					<input type="checkbox"/> Other _____
					<input type="checkbox"/> Credit



UNITED STATES PATENT AND TRADEMARK OFFICE

UNITED STATES DEPARTMENT OF COMMERCE
United States Patent and Trademark Office
Address: COMMISSIONER FOR PATENTS
P.O. Box 1450
Alexandria, Virginia 22313-1450
www.uspto.gov

APPLICATION NO.	FILING DATE	FIRST NAMED INVENTOR	ATTORNEY DOCKET NO.	CONFIRMATION NO.
90/007,402	01/31/2005	5191573	NAPS001	2998

7590 07/13/2005
Ansel M. Schwartz
425 N. Craig Street Suite 301
Pittsburgh, PA 15213

EXAMINER

Gilberton Barron, Jr.

ART UNIT PAPER NUMBER

2132

DATE MAILED: 07/13/2005

Please find below and/or attached an Office communication concerning this application or proceeding.



DO NOT USE IN PALM PRINTER

(THIRD PARTY REQUESTER'S CORRESPONDENCE ADDRESS)

Albert S. Penilla
MARTINE PENILLA & GENCARELLA, LLP
710 Lakeway Drive, Suite 200
Sunnyvale, CA 94085

EX PARTE REEXAMINATION COMMUNICATION TRANSMITTAL FORM

REEXAMINATION CONTROL NO. 90/007,402.

PATENT NO. 5191573.

ART UNIT 2132.

Enclosed is a copy of the latest communication from the United States Patent and Trademark Office in the above identified *ex parte* reexamination proceeding (37 CFR 1.550(f)).

Where this copy is supplied after the reply by requester, 37 CFR 1.535, or the time for filing a reply has passed, no submission on behalf of the *ex parte* reexamination requester will be acknowledged or considered (37 CFR 1.550(g)).

Ex Parte Reexamination Interview Summary	Control No. 90/007,402	Patent Under Reexamination 5191573	
	Examiner Gilberto Barron Jr.	Art Unit 2132	

All participants (USPTO personnel, patent owner, patent owner's representative):

- (1) Gilberto Barron Jr. (3) Ansel Schwartz
(2) Benjamin E. Lanier (4) Arthur Hair

Date of Interview: 13 July 2005

Type: a) Telephonic b) Video Conference
c) Personal (copy given to: 1) patent owner 2) patent owner's representative)

Exhibit shown or demonstration conducted: d) Yes e) No.
If Yes, brief description: _____

Agreement with respect to the claims f) was reached. g) was not reached. h) N/A.
Any other agreement(s) are set forth below under "Description of the general nature of what was agreed to..."

Claim(s) discussed: none in particular.

Identification of prior art discussed: Gallagher, Freeny.

Description of the general nature of what was agreed to if an agreement was reached, or any other comments:
Mr. Schwartz discussed inherency issues in Gallagher, and prior court decisions with respect to the Freeny reference.

(A fuller description, if necessary, and a copy of the amendments which the examiner agreed would render the claims patentable, if available, must be attached. Also, where no copy of the amendments that would render the claims patentable is available, a summary thereof must be attached.)

A FORMAL WRITTEN RESPONSE TO THE LAST OFFICE ACTION MUST INCLUDE PATENT OWNER'S STATEMENT OF THE SUBSTANCE OF THE INTERVIEW. (See MPEP § 2281). IF A RESPONSE TO THE LAST OFFICE ACTION HAS ALREADY BEEN FILED, THEN PATENT OWNER IS GIVEN **ONE MONTH** FROM THIS INTERVIEW DATE TO PROVIDE THE MANDATORY STATEMENT OF THE SUBSTANCE OF THE INTERVIEW (37 CFR 1.560(b)). THE REQUIREMENT FOR PATENT OWNER'S STATEMENT CAN NOT BE WAIVED. **EXTENSIONS OF TIME ARE GOVERNED BY 37 CFR 1.550(c).**

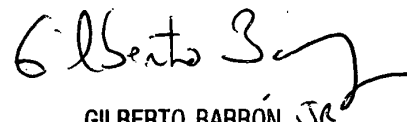
GILBERTO BARRÓN JR.
SUPERVISORY PATENT EXAMINER
TECHNOLOGY CENTER 2100

cc: Requester (if third party requester)

Examiner's signature, if required



08/19/05

Practitioner's Docket No. HAIR-1 CONT

PATENT

IN THE UNITED STATES PATENT AND TRADEMARK OFFICE

U.S. Patent No. 5,191,573

In re application of: Arthur R. Hair
Reexamination Control No.: 90/007,402
Reexamination Filed: 01/31/2005
For: TRANSMISSION SYSTEM

Group No.: 2132
Examiner: Benjamin E. Lanier

Mail Stop Ex Parte Reexamination
Commissioner for Patents
P.O. Box 1450
Alexandria, VA 22313-1450

AMENDMENT TRANSMITTAL

- 1. Transmitted herewith is an amendment for this application.

STATUS

- 2. Applicant is a small entity. A statement was already filed.

CERTIFICATION UNDER 37 C.F.R. §§ 1.8(a) and 1.10*
(When using Express Mail, the Express Mail label number is mandatory;
Express Mail certification is optional.)

I hereby certify that, on the date shown below, this correspondence is being:

MAILING

X deposited with the United States Postal Service in an envelope addressed to the Commissioner for Patents, P.O. Box 1450, Alexandria, VA 22313-1450.

37 C.F.R. § 1.8(a)
with sufficient postage as first class mail.

37 C.F.R. § 1.10*
X as "Express Mail Post Office to Addressee"
Mailing Label No. EL700964471US (mandatory)

TRANSMISSION

facsimile transmitted to the Patent and Trademark Office, (703)

09/06/2005 NSALDANA 00000011 90007402

Signature: Tracey L. Klaas (handwritten signature) 100.00 OP

Date: 8/18/05

Tracey L. Klaas
(type or print name of person certifying)

* Only the date of filing (§ 1.6) will be the date used in a patent term adjustment calculation, although the date on any certificate of mailing or transmission under § 1.8 continues to be taken into account in determining timeliness. See § 1.703(f). Consider "Express Mail Post Office to Addressee" (§ 1.10) or facsimile transmission (§ 1.6(d)) for the reply to be accorded the earliest possible filing date for patent term adjustment calculations.

EXTENSION OF TERM

3. The proceedings herein are for a patent application and the provisions of 37 C.F.R. 1.136 apply. Applicant believes that no extension of term is required. However, this conditional petition is being made to provide for the possibility that applicant has inadvertently overlooked the need for a petition for extension of time.

FEE FOR CLAIMS

4. The fee for claims (37 C.F.R. 1.16(b)-(d)) has been calculated as shown below:

	(Col. 1)	(Col. 2)	(Col. 3)		SMALL ENTITY
	CLAIMS REMAINING AFTER AMENDMENT	HIGHEST NO PREVIOUSLY PAID FOR	PRESENT EXTRA		ADDIT. FEE
TOTAL	6	- 20	= 0	x \$	25.00 = \$ 0.00
INDEP.	2	- 3	= 0	x \$	100.00 = \$ 0.00
FIRST PRESENTATION OF MULTIPLE DEPENDENT CLAIM				+ \$	0.00 = \$ 0.00
				TOTAL ADDIT. FEE	\$ 0.00

No additional fee for claims is required.

FEE DEFICIENCY

5. If an additional extension and/or fee is required, charge Account No. 19-0737.

If an additional fee for claims is required, charge Account No. 19-0737.

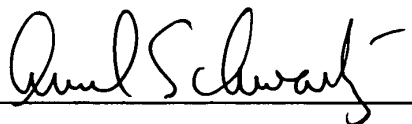

Ansel M. Schwartz
 Registration No. 30,587
 Attorney at Law
 201 N. Craig Street
 Suite 304
 Pittsburgh, PA 15213
 412-621-9222



08/19/05

IN THE UNITED STATES PATENT AND TRADEMARK OFFICE

In re Application of:)	
)	
ARTHUR R. HAIR)	
)	
Reexamination Control No. 90/007,402)	
)	
Reexamination Filed: January 31, 2005)	TRANSMISSION SYSTEM
)	
Patent Number: 5,191,573)	
)	
Examiner: Benjamin E. Lanier)	

Pittsburgh, Pennsylvania 15213

August 18, 2005

Mail Stop *Ex Parte* Reexamination
Commissioner for Patents
P.O. Box 1450
Alexandria, VA 22313-1450

Sir:

RESPONSE

In response to the Office Action for the above-identified reexamination dated
June 21, 2005, please enter the following remarks.

Claims

Claim 1 (original): A method for transmitting a desired digital audio signal stored on a first memory of a first party to a second memory of a second party comprising the steps of:

transferring money electronically via a telecommunications line to the first party at a location remote from the second memory and controlling use of the first memory from the second party financially distinct from the first party, said second party controlling use and in possession of the second memory;

connecting electronically via a telecommunications line the first memory with the second memory such that the desired digital audio signal can pass therebetween;

transmitting the desired digital audio signal from the first memory with a transmitter in control and possession of the first party to a receiver having the second memory at a location determined by the second party, said receiver in possession and control of the second party; and

storing the digital signal in the second memory.

Claim 2 (original): A method as described in Claim 1 including after the transferring step, the steps of searching the first memory for the desired digital audio signal; and selecting the desired digital audio signal from the first memory.

Claim 3 (original): A method as described in Claim 2 wherein the transferring step includes the steps of telephoning the first party controlling use of the first memory by the second party; providing a credit card number of the second party controlling the second memory to the first party controlling the first memory so the second party is charged money.

Claim 4 (original): A method for transmitting a desired digital video signal stored on a first memory of a first party to a second memory of a second party comprising the steps of:

transferring money electronically via a telecommunications line to the first party location remote from the second memory and controlling use of the first memory, from a second party financially distinct from the first party, said second party in control and in possession of the second memory;

connecting electronically via a telecommunications line the first memory with the second memory such that the desired digital video signal can pass therebetween;

transmitting the desired digital video signal from the first memory with a transmitter in control and possession of the first party to a receiver having the second memory at a location determined by the second party, said receiver in possession and control of the second party; and

storing the digital signal in the second memory.

Claim 5 (original): A method as described in Claim 4 including after the transferring money step, the step of searching the first memory for the desired digital signal and selecting the desired digital signal from the first memory.

Claim 6 (original): A method as described in Claim 5 wherein the transferring step includes the steps of telephoning the first party controlling use of the first memory by the second party controlling the second memory; providing a credit card number of the second party controlling the second memory to the first party controlling the first memory so the second party controlling the second memory is charged money.

REMARKS

Claims 1-6 are currently active.

The Examiner has rejected Claims 1-6 as being unpatentable over Gallagher in view of Freeny. Patentee respectfully traverses this rejection. The teachings of Freeny cannot be combined with the teachings of Gallagher to arrive at Patentee's claimed invention.

In *SightSound v. N2K*, the District Court in its Order on page 53, discussed the decision by the Federal Circuit of the *Interactive Gift Express Inc. v. CompuServe, Inc.*, 256 F.3D 1323, 1334 (Fed. Cir. 2001). The District Court stated that the court in *Interactive Gift Express* affirmed the lower court's construction of the term "material object" in the Freeny patent to be (a) separate and distinct from the IMM, (b) removed from the IMM after purchase, and (c) intended for use away from the point-of-sale location. Id. at 1336. The Federal Circuit Court stated, "these three conditions . . . are fundamental to the meaning of a material object as clearly and consistently specified in the patent description." Id. at 1337. The Court explicitly noted that the (material object) is on which the information is recorded (does not encompass a hard disk component of a home personal computer) and the material object (must be offered for sale, and be purchasable, at [the] point-of-sale location []). Id. at 1338. Since one using the Hair invention purchases only the signals, not the material object

on which they are stored, and since the Sightsound Patents specifically reference the consumers system as incorporating a hard disk, the Freeny patent, as construed by the Federal Circuit Court in Interactive Gift Express arguably teaches away from the Hair invention in at least two ways. (See, e.g., Claims 13 and 14 of the '440 patent as discussed in the Magistrate's Report at 65.)

In other words, the Court held that Freeny was teaching a vending machine, for instance, inside the user's living room where the user would have to pay for the tape to be dispensed. That is, Freeny teaches the first party is in possession and control of the second memory, not the second party, as found in Patentee's claimed invention.

Accordingly, there is a legal holding from the District Court in Sightsound, supra, that Freeny teaches away from Patentee's claimed invention.

As the Examiner is aware, teachings cannot be taken out the context in which they are found. For the Examiner to apply the teachings of Freeny in regard to the teachings of Gallagher would be to ignore the clear context of Freeny which is to teach away from Patentee's claimed invention.

This position regarding the inappropriateness by law of combining the teachings of Freeny and Gallagher is applied to all the pending claims. Accordingly, all the pending claims are patentable over the applied art of record.

Patentee also brings to the attention of the Examiner that the U.S. District Court for the Western District of Pennsylvania in its Order of Court Decision dated October 23, 2003, in *Sightsound.com, Inc. v. N2K*, on page 58, found that secondary considerations of copying, skepticism on the part of those skilled in the art as to the viability of such a system, long-felt but unsatisfied needs, and unsuccessful attempts by others to solve the problem underlying the claimed invention existed. Enclosed with this Amendment as Attachment A are the relevant pages provided to the court to establish the secondary considerations of patentability titled "Secondary Considerations of Patentability Evidence". In regard to any obviousness rejection, this finding of secondary considerations of patentability dictates the claims are patentable.

This evidence shows that there was a long-felt need for a simple system for electronically distributing digital audio. Despite the number of efforts displayed by the prior art presented by defendants, none of the prior art systems ever survived as a consumer-oriented mass-market distribution system for digital music distribution. See Tygar rebuttal report at page 80. The only solutions including all of the magic ingredients for a viable

system are the claims presented in the Hair patents. The Hair claimed invention offers the advantages of allowing consumers to use their home computers to purchase, download and play back the desired digital audio music using a single device. See Tygar rebuttal report at page 80. Furthermore, the major record labels and other major companies have formed a series of joint ventures introducing online services to electronically sell digital audio for download to customers over the Internet, such as MusicNet (owned by Bertelsmann, EMI, AOL Time Warner and RealNetworks), iTunes (owned by Apple Computer Company), and PressPlay, (owned by Vivendi Universal and Sony). The services are offering downloading of digital audio music for sale over the Internet to consumers who will use their home computers to purchase and play music. See Exhibit P of Attachment A (tab 1, showing PC software implementing copy protection; tabs 2-6, showing representative on line digital audio providers). Such recognition by the music industry of the advantages of electronic sales of digital audio is further secondary evidence of non-obviousness. Included with this Attachment A is also the Settlement Agreement between the parties in the Sightsound.com, Inc. v. N2K lawsuit, wherein \$3.3 million dollars was paid to Sightsound by N2K as part of the settlement, and the Final Order by the District Court in this lawsuit dated February 20, 2004, holding that the Hair patents are valid. The Settlement Agreement and the Final Order is additional secondary evidence of patentability.

It should be noted that the Requester did not inform the U.S. Patent and Trademark Office of the secondary evidence of the Settlement Agreement and the associated \$3.3 million payment, nor of the Final Order by the District Court holding the three Hair patents were valid. Furthermore, the District Court was aware, specifically considered and even discussed the Freeny reference and the Federal Court's decision that occurred after the issuance of the last of the three Hair patents (discussed above herein) that Freeny taught away from the Hair claimed invention. It is respectfully submitted that Requester should have specifically informed the U.S. Patent and Trademark Office of these very relevant facts, just as an applicant or Patentee has a duty of disclosure with the U.S. Patent and Trademark Office.

It should also be noted that it is common knowledge of the success of Apple Computer Company with its download business, iTunes, and the current lawsuit for patent infringement of Napster by the real party in interest of the subject patent. The pleadings of this lawsuit have recently been provided to the Examiner in an Information Disclosure Statement in U.S. patent application serial number 09/286,892. A printout of the web page of iTunes of Apple Computer showing over 500 million downloads is included with Attachment A, which further updates the information identified by the District Court in Sightsound, supra.

If there is any document that is mentioned by Patentee which would be easier for the Examiner to review by requesting Patentee for it rather than having to go through all the Information Disclosure Statements submitted, Patentee would be glad to provide it to the Examiner.

A copy of this entire response has also been mailed to the Requester.

An Information Disclosure Statement is enclosed. Copies of all non-U.S. patent references identified in the Information Disclosure Statement can be found in U.S. patent application serial number 09/286,892.

In view of the foregoing amendments and remarks, it is respectfully requested that the outstanding rejections and objections to this application be reconsidered and withdrawn, and Claims 1-6, now in this application be allowed.

Respectfully submitted,

ARTHUR R. HAIR

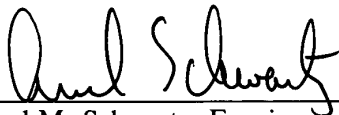
By 
Ansel M. Schwartz, Esquire
Reg. No. 30,587
One Sterling Plaza
201 N. Craig Street, Suite 304
Pittsburgh, PA 15213
(412) 621-9222

Attorney for Patentee

CERTIFICATE OF SERVICE

The undersigned hereby certifies that a true and correct copy of the foregoing Response was mailed via first class, United States Mail, postage prepaid, this 18th day of August, 2005, to the following:

Mr. Albert S. Penilla
Martine, Penilla & Gencarella, LLP
710 Lakeway Drive, Suite 200
Sunnyvale, CA 94085

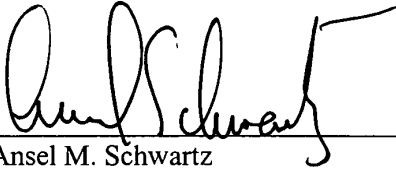
By: 
Ansel M. Schwartz
Attorney for Patentee

SIGHTSOUND.COM v N2K
11052/1

Index of Prior Art

Examiner's Initials	TAB NO.	PARENT NO.	INVENTOR	FILING DATE	DESCRIPTION
	1	5,428,606	Muskowitz	June 30, 1993	Invention relating to an info. network and to a digital info exchange system
	2	5,132,992	Yurt et al.	January 7, 1991	Audio/video transmission and receiving system
	3	5,130,792	Tindell et al.	February 1, 1990	Store and forward video system
	4	5,191,573	Hair	September 18, 1990	Method for transmitting a digital audio/video signal
	5	5,675,734	Hair	February 27, 1996	System for transmitting digital video/audio signals
	6	5,966,440	Hair	June 6, 1995	System and method for transmitting desired digital video/audio signals
	7	4,999,806	Chernow et al.	September 4, 1987	Software distribution system
	8	Re: 35,184	Walker	October 17, 1986	Remote transaction

Examiner's Initials	TAB NO.	PATENT NO.	INVENTOR	FILING DATE	DESCRIPTION
				system	
	9	3,244,809	Fuller et al.	February 26, 1962 Signal distribution systems	
	10	3,696,297	Otero	September 1, 1970 Broadcast communications system including a plurality of subscriber stations for selection receiving and replacing	
	11	3,718,906	Lightner	June 1, 1971 Vending system for remotely accessible store information	
	12	3,824,597	Berg	November 9, 1970 Data transmission network	
	13	3,947,882	Lightner	November 29, 1972	Vending system for remotely accessible stored information
	14	3,990,710	Hughes	March 1, 1971	Coin-operated recording machine
	15	4,028,733	Ullicki	July 7, 1973	Pictorial info retrieval system

Examiner's Initials	TAB NO.	PATENT NO.	INVENTOR	FILING DATE	DESCRIPTION
	16	4,045,776	Wheelwright et al.	April 19, 1976	Electronic phonograph selector and memory system
	17	4,108,365	Hughes	January 15, 1976	Coin-operated recording machine
	18	4,124,773	Elkins	November 26, 1976	Audio storage and distribution system
	19	4,300,040	Gould et al.	November 13, 1979	Ordering terminal
	20	4,335,809	Wain	January 29, 1980	Entertainment machines
	21	4,370,649	Fuerle	May 19, 1981	Payment responsive data network display
	22	4,422,093	Pargee	January 27, 1983	Television burst service
	23	4,499,568	Gremiller	December 13, 1982	Process for tele-distribution of recorded info and system for it
	24	4,506,387	Walter	May 25, 1983	Process for tele-distribution of recorded info and system for it
	25	4,520,404	Von Kohorn	August 23, 1982	System apparatus and method for recordings and editing broadcast transmissions
	26	4,521,806	Abraham	August 19, 1982	Recording program communication system
	27	4,521,857	Reynolds, III	May 17, 1982	Aviation weather information dissemination system
	28	4,586,430	Freeny	January 19, 1985	System for reproducing info in material objects eta paint

Examiner's Initials	TAB NO.	PATENT NO.	INVENTOR	FILING DATE	DESCRIPTION
	29	4,533,948	McNamara et al.	April 30, 1982	CATV Communications system of sale location
	30	4,536,856	Hiroishi	September 20, 1980	Method of and apparatus for controlling the display of video signal information
	31	4,538,176	Nakjimo et al	November 26, 1979	Buffer memory dispersion type video/audio transmission system
	32	4,567,359	Lockwood	May 24, 1984	Automatic info goods and services dispensing
	33	4,567,512	Abraham	September 28, 1983	Recorded program communication system
	34	4,605,973	Von Kohorn	March 25, 1985	System apparatus and method for recordings and editing broadcast transmission
	35	4,647,989	Geddes	March 18, 1983	Videocassette selection machine
	36	4,648,037	Valentino	March 15, 1984	Method and apparatus for benefit and financial communication
	37	4,658,093	Hellman	July 11, 1983	Software distribution system
	38	4,667,802	Verduin et al.	October 1, 1984	Video jukebox
	39	4,672,613	Foxworthy et al.	November 1, 1985	System for transferring digital data bet. A hot device and a recording medium
	40	4,674,055	Ogaki	May 29, 1984	Software vending system

Examiner's Initials	TAB NO.	PATENT NO.	INVENTOR	FILING DATE	DESCRIPTION
	41	4,688,105	Bloch et al	May 10, 1985	Video recording system
	42	4,703,465	Parker	December 14, 1985	Method and apparatus for producing and audio magnetic tape recording from a preselected music library
	43	4,725,977	Izumi et al	February 28, 1986	Cartridge programming system and method with a central and local program library
	44	4,739,510	Jeters et al	April 2, 1982	Direct broadcast satellite signal transmission system
	45	4,754,483	Weaver	August 25, 1987	Data compression system and method for audio signals
	46	4,755,872	Bestler et al.	July 29, 1985	Impulse pay per view system and method
	47	4,759,060	Hayashi et al.	October 31, 1985	Decoder for a pay t.v. system
	48	4,761,684	Clark et al.	November 14, 1986	Telephone access display system
	49	4,763,317	Lehman et al	December 13, 1985	Digital communications network architecture for providing universal info services
	50	4,766,581	Lorn et al.	August 7, 1984	Info retrieval system an method using independent user stations
	51	4,787,050	Suzuki	November 12, 1986	Apparatus For Managing Software Bending Machine
	52	4,789,863	Bush	January 13, 1988	Pay per view entertainment system

Examiner's Initials	TAB NO.	PATENT NO.	INVENTOR	FILING DATE	DESCRIPTION
	53	4,792,849	McCalley et al.	August 4, 1987	Digital interactive communication system
	54	4,797,918	Lee et al.	April 15, 1987	Subscription controller t.v. programming
	55	4,829,372	McCalley et al.	August 20, 1987	Presentation player
	56	4,894,789	Yee	February 22, 1988	TV Data capture device
	57	4,918,588	Barrett et al.	December 31, 1986	Office automation system w/ integrated image management
	58	4,949,187	Cohen	December 16, 1988	Video communication system having a remotely controlled control sources of video/audio data
	59	5,003,384	Durdan et al	April 1, 1988	Set top interface transactions in an impulse pay per view t.v. system
	60	5,019,900	Clark et al.	August 1, 1988	Telephone access display system
	61	5,041,921	Schettler	December 17, 1987	System for recording custom albums from a library of pre-recorded items
	62	5,089,885	Clark	August 1, 1988	Telephone Access Display System With Remote Monitoring
	63	5,099,422	Foresman et al.	March 17, 1989	Compiling system method of producing individually customized recording media
	64	5,191,410	McCalley et al.	February 5, 1991	Interactive multimedia presentation and communication system

Examiner's Initials	TABS	TITLE	AUTHOR	SOURCE
	65	From the news desk	D. Needle	Info World, May 11, 1984
	66	Computer system organization: Problems of the 1980's	H. Apfelbaum, et al.	Computer Sept. 1978, Vol. II, No. 9
	67	System for capturing, storing and playing back large data bases at home	D.C. Gazis S.S. Soo	IBM Technical Disclosure Bulletin, Vol. 23, No. 2, p. 856, July 1980
	68	Jimmy Bowen: Music Row's Prophet of change	L. Chappell	Advantage, Vol.9, No. 10, p.38, October 1986
	69	Rock Around the Database	L. Dotto	Information Technal., Vol. 57, No. 9, pp. 128-135, September 1984
	70	Home (computer) terminal musical program selection	P.L. Rosenfeld	IBM Technical Disclosure Bulletin, Vol. 23, NO. 78, p 3440
	71	A Harmonious Musical Interface	S. Cunningham	Network World, Inc., September 8, 1986
	72	Electronic Orchestra in your livingroom	S. Mace	InfoWorld, March 25, 1985, p. 29
Examiner's Initials	TABS	TITLE	AUTHOR	SOURCE
	74	Cable Scan	No Author	, October 1983
	75	A review of digital audio techniques	M. Willcocks	Journal of the Audio Engineering Society, Vol. 26, No. 12, pp. 56, 58, 60, 62, 64, Jan-Feb 1978

76	Digital Music Will Launch the Home Music Store	G. Gulick	Satellite News, 81-11-09, pp. 7
77	Telecommunications in the coming decades	S.B. Weinstein	IEE Spectrum, Nov 19??, p. 62
78	Electronic Banking Goes to Market	T.S. Perry	IEE Spectrum, Feb 19??, p. 46
79	Gordon Bell calls for a U.S. Research Network	G. Gordon Bell	IEEE Spectrum p. 54
80	As Patents Multiply, Web Sites Find Lawsuits Are a Click Away	S. Hansell	New York Times, Dec. 11, 1999, A1
81	The Tony Basile Home Page	The PAN NETWORK	The PAN Network, Dec 12, 1999
82	Tele computing - Direct Connections for Software Selections	E. Ferrarini	Business computer systems, Feb. 1984
83	Young Arcadians Come Home	D.N.	Info. World, Vol. 5, Number 27
84	Two way Cable System Using Residential CATV Facilities	Semir Sirazi, et al	ICCE 84, June 7, 1984, LaSalle III - Digest of Technical Papers.
85	News	D. Caruso	InfoWorld, April 16, 1984
86	Pay Per View Entertainment System	PTO	US Patent and Trademark Office, Patent Bibliographic Database, 1/26/00

	87	Software Distribution System	PTO	US Patent and Trademark Office, patent Bibliographic Database, 1/26/00
	88	Dig-Music: An On Demand Digital Music Selection System utilizing CATV Facilities	Y. Want G.M. Campbell	IEEE Transactions on Consumer Electronics, Vol. CE-28, No. 3, August 1982, p. xviii
	89	Transmission of Musical Info. in a teletext multiplexed broadcasting system	Y. Sugimori, et al.	IEEE International Conference on Consumer Electronics, 1985 - Digest of Technical Papers.
	90	An Encrypted Digital Audio System for Conventional Cable System	K. Kitagawa, et al.	IEEE International Conference on Consumer Electronics, 1985 - Digest of Technical Papers
	91	Telephone computers - a look at the one per Desk Telecomputer	D. Pountain	BYTE U.K., June 1985
	92	Music Software for the Apple Macintosh	C. Yavelow	Computer Music Journal, Vol. 9, No. 3, Fall 1985
	93	NAPLPS Videotex Frame Creation System with Automatic Encoding of Input Images	T. Fujimori	IEEE Transactions on Consumer Electronics, Vol. CE-31, No. 3, August 1985
	94	Picture Transmission for Videotex	K. Ngan, et al.	IEEE Transactions on Consumer Electronics, Vol. CE-31, No. 3, August 1985
	95	A System for	N. Kihara, et al.	IEEE Transactions on Consumer electronics, Vol. CE-

		Transmitting Electronic Photographs		28, No. 3, August 1982
	96	A Low cost High Performance Picture Display for Photovideotex	G.P. Hudson C.P. Arbutnot	IEEE Transactions on Consumer Electronics, Vol. CE-32, August 1986
	97	The Coding of Graphics Animation in a Videotext Terminal	C. Paboucsidis	1986 IEEE International Conference on Consumer Electronics, Digest of technical Papers, June 1986
	98	Videotext Programs Videorecorder (VPV)	U. Bensch	1984, IEEE International Conference on Consumer Electronics, Digest of technical Papers June 1984
	99	Picture Transmission for Videotex	H. Weng Cheong N. King Ngi	1988, IEEE International Conference on Consumer Electronics, Digest of technical Papers June 1988 Digital Still Picture Recorder Utilizing an Ordinary Audio Cassette Decks. Kageyama, et al. 1985 IEEE International Conference on Consumer Electronics, Digest of technical Papers, June 1985
	100	Digital Still Picture Recorder Utilizing an Ordinary Audio Cassette Deck	S. Kageyama, et al.	1985 IEEE International Conference on Consumer Electronics, Digest of Technical Papers, June 1985
	101	A New digital Audio and Data Transmission System Using the CATV Network	Y. Kojima, et al.	IEEE Transactions on Consumer Electronics, Vol. CE-30, No. 3, August 1984
		A Simple Technique for	N.D. Jotwani	IEEE Transactions on Consumer Electronics, Vol. CE-

	102	Video Image Transmission	K.L. Mong	33, No. 1, February 1987
	103	Third Party Profile: Control Video Corporation	no author	Control Video Corp. Web Site
	104	Dial-A-Game-GameLine module links WCS With Game Bank	D. Burns	Digital Antic, Vol. 2, No. 4, July 1983, p. 82
	105	Remembering the GameLine	D. Skelton	http://ccwf.ccutexas.edu
	106	Digitalized Voice Comes of Age Part 1 - Trade Offs	B. Occhiogrosso	Data Communications, March 1978
	107	A New Digital Audio and Data Transmission System Using the CATV Network	Y. Kojima, et al.	IEEE Transactions on Consumer Electronics, Vol. CE-30, No. 3, August 1984
	108	A Packet Video/Audio System Using the Asynchronous Transfer Mode Technique	H.J. Chao, et al	IEEE Transactions on Consumer Electronics, Vol. 35, No. 2, May 1989
	109	Digital Audio Data Transmission in a Coaxial Cable Environment	R. Scheuerer, et al	IEEE Transactions on Consumer Electronics, Vol. 35, No. 2, May 1989? (Illegible)
	110	Transmission of Musical info, in a Teletext Multiplexed Broadcasting system	Y. Sugimori, et al	IEEE Transactions on Consumer Electronics, Vol. CE-29, No. 3, August 1983

111	4004 Futures for Teletext and Videotex in the US	R.P. Plummer, et al	IEEE Transactions on Consumer Electronics, Vol. CE-25, No. 3, July 1979
112	Teletex/Viewdata LSI	B. Harden, et al.	IEEE Transactions on Consumer Electronics, Vol. CE-25, No. 3, July 1979
113	Prestel - the World's First Public View data Service	R.D. Bright, et al.	IEEE Transactions on Consumer Electronics, Vol. CE-25, No. 3, July
114	Teletext and Viewdata (costs as Applied to the US Market	G.O. Crowther	IEEE Transactions on Consumer Electronics, Vol. CE-25, No. 3, July 1979
115	Telidon - A Review	H. Brown W. Sawchuk	IEEE Communications Magazine, Jan 1981
116	Videotex Services: Network and Terminal Alternatives	J.M. Costa A.M. Chitnis	IEEE Transactions on Consumer Electronics, Vol. CE-25, No. 3, July 1979
117	System and Hardware Considerations of Home Terminals With Telephone Computer Access	J. Blank	IEEE Transactions on Consumer Electronics, Vol. CE-25, No. 3, July 1979
118	Profile - Career Update		Key board News, April 1985
119	Telecommunications - Let Your Telephone Do the Sampling	B. Tolinski	KSC, April 1986
120	PAN: Meeting Place for the Industry	P. Leopold	Electronic Musician, Sept. 1986

121	A Harmonious Musical Interface - Instrument Connectivity is Music to Composer's ears.	S. Cunningham	Network World, Sept 8, 1986 (Vol. 3, No 27)
122	Teaching Computers to Emulate Bach	J.S. Newton	The New York Times, Sunday, March 1, 1987
123	Getting Into PAN	S. Lloyd	Sonics (nothing else appears)
124	MIDI By Modem: The Future in Now	P. Leopold	Conference Paper - Music and Digital Technology
125	The Information Source of the Future is Online now: Electronic Bulletin Boards	G. Armbruster	Keyboard Magazine, Dec 1985
126	MIDI - Musical Instrument Digital Interface	J. Aikin	Keyboard Magazine, January 1986
127	MIND Over MIDI - Diary of a Mad MIDI Specialist	J. Cooper	Keyboard Magazine, June 1986
128	Cover of the KEYBOARD MAGAZINE and Advertisement from Hybrid Acts, Inc.		Keyboard Magazine, July 1986
129	What is Musical Property? - The Ethics of Sampling	S. Alvaro	Keyboard Magazine, October 1986

130	Collection of MIDI Stereo Advertisements		Electronic Musician, Vol. 5, No. 2, Feb 1989
131	In the Public Eye: Free Atari Software	J. Johnson	Electronic Musician, Vol. 5, No. 10, October 1989
132	Going Online - A Guide to elec. Bulletin board System	M. Rivers	Electronic Musician, Vol. 6, No. 11, November 1990
133	*Page of EM Classifieds		Electronic Musician, November 1989
134	Advertisements		Electronic Musician, August 1989
135	EM Classifieds		Electronic Musician, July 1989
136	Advertisements		Electronic Musician, July 1989
137	Start Me Up? - the Music Biz Meets the personal computer	B. Krepack R. Firestone	Published by Medic Press, Copyright 1986
138	A Harmonious Musical Interface	S. Cunningham	1986 Network world, September 8, 1986
139	Synth - Bank	USPTO	USPTO -Trademark Text and Database
140	Managing the Intellectual Property Lifecycle	B. Bell A. Brown, Jr.	A excerpt from an article available at Synthbank.com 1998, Synthbank. Inc.
141	*List of E-Bulletin Boards with an attached EM page of ads		ON-line Resources/Electronic Bulletin Boards
142	An Upeat Way to Order; worth watching	G. Charlish	1988 The Financial Times (Lexis-Nexis)

143	MUSICNET	USPTO	USPTO - Trademark
144	PC Forum Attendees Call for Cooperation with Government	S. Higgins	Westlaw, Monday, March 1, 1993
145	Data Highways... Can we get there from here?	J. Burgess	The Washington Post, May 2, 1993 (Lexis-Nexis)
146	MNI Interactive to Revolutionize the Way Consumers Select and Purchase Entertainment Products		PR Newswire Association, Jan 17, 1994
147	The Interactive Age - Can The Exalted Vision Become a Reality?	M. W. Miller	The Wall Street Journal, Thursday, Oct 14, 1993
148	Music Net Let's Consumer's Fingers do the Walking	J. McCullaugh	Billboard, Saturday, October 16, 1993 (Westlaw)
149	"Rolling Stone" Takes Music to The Phone	S. Donaton A. Z. Cuneo	Advertising Age, July 11, 1994 (Lexis-Nexis)
150	Most Silicon Valley Ventures Beat the Odds	S. Herhold	Knight - Ridder Tribune Business News, Feb. 14, 1999
151	*Entire September Issue		Electronic Musician, Sept. 1986
152	Digit Download - Guidelines for the Architecture of Audio Technical		Preliminary White Paper Version 1.0 March 2, 1999 (CDN 03994-004038)

		Facilities at an Online Music Retail Site		
	153	US Patent No. 4, 999,806	Software distribution system	USPTO
	154	US Patent No. 4,359,223	Interactive video playback system	USPTO
	155	USPTO Certificate of Correction - Patent No. 4,528,643	System for Reproducing information in material objects at a point at sale location	USPTO
	156	The Telharmonium: An Early Breakthrough in Electronic Music	T. Holmes	Gyrofrog Communications Electronic and Experimental Music 1996
	157	Free Music Downloads	CDNow	CDNow Web Site (CDN 000078-85)
	158	Gameline - the Incredible New Way to Play Video Games		Gameline brochure
	159	Downloading and Tele-delivery of Computer Software, Music and Video		International Resource Development, Inc. (DN 021217-021432)
	160	Downloading and Tele-		International Resource

		delivery of Computer Software, Music and Video		Development, Inc. July 1983 (CDN 021433-021664)
	161	The Development of a Commercial Tele software Service	A. Sweet	Tele software Cavendish Conference Center 27-28 Sept. 1984. Publication No. 60 [61] Institution of Electronic and Radio Engineers
	162	Tele software - The Computer in Your TV set	J. Hedger	New Electronics, Vol. 13, No. 245, December 9, 1980
	163	Tele Software: Adding Intelligence to Teletext	R. Eason J. Hedger	Proceedings IEEE, Vol. 126, No. 12, December 1979
	164	Receiving Tele Software With CCT	J.R. Kinghorn	Tele software Cavendish Conference Center 27-28 Sept. 1984. Publication No. 60 [61] Institution of Electronic and Radio Engineers
	165	Games Tele Software on Cable	T.J. Havelock	Tele software Cavendish Conference Center 27-28 Sept. 1984. Publication No. 60 [61] Institution of Electronic and Radio Engineers
	166	Broadcast Tele Software Experience With ORACLE	J. Hedges	View data and Videotext, 1980-1981: A Worldwide Report
	167	The UK Teletext Standard for Tele Software Transmissions	D.J. Rayer	View data and Videotext, 1980-1981: A Worldwide Report
	168	Music from the skies promised by firm serving	S. Chase	The Washington Post, October 19, 1981

		cable users		
	169	Abstract -	L. Landro	The Wall Street Journal, October 14, 1981
	170	Abstract -	No author listed	UPI - October 13, 1981
	171	Hi-Tech <i>do-Dads</i> for the man of the house	No author listed	Trends
	172	New Products Programmed for Consumers	No author listed	Computer Report
	173	Electronics show had variety of new home equipment	No author listed	Hi-Fi News and Record Reviews, 1985
	174	New Telerecording Method for Audio	No author listed	BM/E, October 1985
	175	Cable TV Moves To The Music	A.L. Yarrow	NY Times, July 4, 1982
	176	What is Stalling the Record Business?	No author listed	Business Week, November 30, 1981
	177	Labels Gear Up For Home Music Store	No author listed	Billboard Magazine, April 6, 1991
	178	The Record Shop of the Future May Be In Your Parlour	Hans Fantel	NY Times, November 22, 1981
	179	The Latest Technology	R. Harrington	Washington Post, June 28, 1981
	180	Thaddeus Cahill and the	No author listed	http://nicemusic4.music.niu.edu

		Telharmonium (electric instrument)		
181		Thaddeus Cahill's Dynamophone/Telharmonium (1897)	No author listed	http://www.obsolete.com
182		Book Review: Magic Music From The Telharmonium	P. Hertz	http://www.obsolete.com
183		Telharmonium	No author listed	http://www.britannica.com
184		Keyboard and Tactile Interfaces	No author listed	In The Third Person, October 1999
185		No Time To Shop For Software	J. Paioff	Infoworld, August 20, 1984
186		Warner Amex QUBE Cable Communications	No author listed	http://www.electricblue.com
187		A Blast From The Past	P. Conger	http://www.cableworld.com , March 28, 1998
188		Where Is Everyone Now	No author listed	http://www.electricblue.com
189		Juke Box History 1934 thru 1951	Gert Almind	http://www.ljukebox.dk
190		The Shyvers Multiphone	No author listed	http://www.dyz.com
191		Dead Medium: Telephonic Jukeboxes: The Shyvers Multiphone...	B. Sterling	http://www.wps.com

192	Downloading and Teledelivery of computer software, games, music, and video	Int'l. Resource Dev. Inc.	US Copyright Application, Registration 1-243-407
193	Compusonics Digitizes Phone Lines	No author listed	Digital Audio, September 1985
194	AT&T Demo	No author listed	Pro Sound News, September 9, 1985
195	Videogames and Electronic Toys		Int'l Resources Dev. Inc., May 1983
196	Compusonics Eyes Options; Will Flagship Computer Make Direct CD Copies?	M. Harrington	Information Access Co., March 30, 1987
197	Direct Broadcast's Potential For Delivering Data Service	E. Holmes	Data Communications, September 1984
198	Sonus Music Products	C. Roads	Computer Music Journal, Spring 1987
199	Advertisement: Gameline package		http://www.geocities.com
200	Computer Music Networks	C. Roads	Computer Music Journal, Fall 1986
201	Announcements	C. Roads	Computer Music Journal, Summer 1986
202	CVC Gameline Master Module	No author listed	http://ccwf.cc.utexas.edu

	203	Oregon Corporate Records	Re: Synth-Bank	Oregon Secretary of State			
	204	Lexis Search Manual (Entire Manual)					
	205	Affidavit of Edgar Magnin and Exhibits			US Dist Ct for the Southern Dist. Of New York		
	206	Transcript: Max Conference			02/27/93		
	207	Exhibits To Compuserve's Brief On Claim Interpretation	Jones, Day, Reavis & Pogue		Filed in US Dist. Ct. For The Southern Dist. Of New York		
Examiner's Initials	TAB NO.	PATENT NO.	INVENTOR	FILING DATE	DESCRIPTION		
	208	4,359,223	Baer et al.	November 1, 1979	Interactive Video Playback System		
	209	4,636,876	Schwartz	September 17, 1984	Audio Digital Recording and Playback System		
	210	4,755,889	Schwartz	August 12, 1986	Audio and Video Digital Recording and Playback System		
	211	4,559,570	Schwartz	May 14, 1984	Magnetic Storage System		
	212	4,758,908	James	September 12, 1986	Method and Apparatus For Substituting A Higher Quality Audio Soundtrack For A Lesser Quality Audio Soundtrack During Reproduction Of The Lesser Quality Audio Soundtrack And A Corresponding Visual Picture		

Examiner's Initials	TAB NO.	PATENT NO.	INVENTOR	FILING DATE	DESCRIPTION
	213	5,307,456	Mackay	January 28, 1992	Integrated Multi-Media Production And Authoring System
	214	4,675,904	Silverman	August 11, 1983	Method For Detecting Suicidal Predisposition
	215	4,682,248	Schwartz	September 17, 1985	Audio and Video Digital Recording Playback System
	216	4,472,747	Schwartz	April 19, 1983	Audio-Digital Recording And Playback System
Examiner's Initials	TAB NO.	DESCRIPTION	AUTHOR	PUBLICATION	
	217	AES Presentations		AES Preprints	
	218	Brochure; Overview articles, etc on PAN	PAN Network		
	219	Brochure: NERAC			
	220	CompuSonics DSP-1000 World's First DARPS		CompuSonics Advertisement	
	221	We Mean Business	C.S. Kaplan	Con. Elec. Daily, May 10, 1984	
	222	Letter to Shareholders	D. Schwartz	CompuSound, Inc. January 6, 1984	
	223	Letter to Shareholders	D. Schwartz	CompuSound, Inc., April 6, 1984	
	224	Letter to Shareholders	D. Schwartz	CompuSound, Inc., July 16, 1984	
	225	Letter to Shareholders	D. Schwartz	CompuSound, Inc., May 31, 1985	

Examiner's Initials	TAB NO.	DESCRIPTION	AUTHOR	PUBLICATION
	226	Manufacturing Update		Audio Video Inter. June 1984
	227	CompuSonics Fuses Computer, Audio Into "Worlds First" HDR	M. Golden	CES Trade News Daily, June 4, 1984
	228	Digital Sound Now on Computer Disks	S. Booth	Consumer Elec. Daily, June 3, 1984
	229	CompuSonics Readies Floppy disc to record.....		HFS Newspaper, June 4, 1984
	230	Floppy disc may be the next music Makers		Business Week, May 28, 1984
	231	CompuSonics: Another Digital Audio Std	N. Weinstock	MIX, August 1984
	232	The State of RCA		TV Digest, May 21, 1984
	233	CompuSonics DSP-1000....		CES Exhibition - D&E, 1984
	234	Optical -Disk based Digital Audio System	B. Robinson	Electronic Engineering Times, September 1, 1986
	235	Brochure - CompuSonics DSP-1000		CompuSonics Corp.
	236	Business Plan Overview		CompuSonics, Corp., June 14, 1984
	237	CompuSonics Corp. Corporate Profile		Audio Video International
	238	Toward Electronic Delivery of Music	J.P. Stautter	CompuSonics Corp.
	239	Company sees Future in Digital	J. Hendon	Rocky MountainNews, July 22, 1984
	240	Floppy-Disk Audio System	A. Mereson	Science Digest, November 1984
	241	Recording Music on Floppy Discs	A. Zuckerman	High Technology, May 1984

Examiner's Initials	TAB NO.	DESCRIPTION	AUTHOR	PUBLICATION
	242	Digital Recording System Uses floppy - discs		Audio Times, May 1984
	243	Brochure		CompuSonics Corp.
	244	Hi-Fi Floppy	CADES	P.C. World, April 1985
	245	New Hi-Fi Horizons	D. Canada	Stereo Review, December 1984
	246	Specs. And Implem. of computer Audio console for Digital Mixing and Recording	D. Schwartz	AES 76th Convention, NYC, June 20, 1984
	247	A High Speed Telecommunications Interface for Digital Audio Transmission and Reception	H. H. Sohn	CompuSonics Corp.
	248	The Audio Computer and its applications	Schwartz & Stautner	CompuSonics Corp.
	249	Engineering Your Own Digital Audio Broadcast System	D. Schwartz	CompuSonics Corp.
	250	Memo: To Mr. Kapp; from D. Schwartz	D. Schwartz	CompuSonics Corp., April 26, 1990
	251	CompuSonics DSP 2002 - Preliminary User Manual		CES, June 1984
	252	Digital Mark. Corp. Video Real Estate System	JPS	CompuSonics Corporation
	253	Memo: to Holmbraker et al.	D. Schwartz	CompuSonics Corporation
	254	Assembly Procedure for DS 1500		CompuSonics Corporation

Examiner's Initials	TAB NO.	DESCRIPTION	AUTHOR	PUBLICATION
	255	Application Notes: CSX Digital Signaling Processing		CompuSonics Corporation
	256	DMS Lecture		CompuSonics Corporation, 1991
	257	Application Notes: DSP 1000 Digital Audio Disc Recorder		CompuSonics Corporation
	258	Automated Merchandising System for Computer Software, Patent #4,949,257	Orbach	USPTO
	259	Letter to E. Kraeutler, Esq. Re: CDNews/Liquid Audio	I. Gross	Wilson, Sonsini, Goodrich and Rosati - April 14, 2000
	260	Patent License Agreement	Schoen & Hooban	Ergon Technology Associates Corp.
	261	The Home Terminal		IRD, Inc., August 1978
	262	Rolm Plugs CBX Into		EMMS - May 2, 1983
	263	Employee Non-Competition Agreement		CDNow, Inc.
	264	Letter to D. Berl, Esq.	K.J. Choi	Lucent Technologies
	265	Video Explosion on the way for buyers	M. Galligan	US News and World Report, June 18, 1984
	266	Hi-Fi in the '80's : Not only Alive and well.....	L. Feldman	Information Access Co., July 1984
	267	The Search for the Digital Recorder	B. Dumaine	Time, Inc., November 12, 1984
	268	Ultimate Integration: Putting Software theory into.....	J. Balga	Information Access Co., February 12, 1985

Examiner's Initials	TAB NO.	DESCRIPTION	AUTHOR	PUBLICATION
	269	Technology Review	R. Welch	The American Banker, December 12, 1986
	270	Remembering the Gameline	D. Skelton	www.mindspring.com
	271	Gameline Module links with game bank	D. Burns	www.atarimagazines.com
	272	Allison 7 Video	Allison	EE 380 2/18/87
	273	Telesoftware - Value Added Teletext	J. Hedger	IEEE Transactions on Consumer Electronics; Feb 1980, Volume CE-26
	274	Telesoftware: Home Computing Via Broadcast Teletext	J. Hedger	IEEE Transactions on Consumer Electronics; July 1999, Volume CE-25, No. 3
	275	The Future of Television as The Home Communications Terminal		International Resource Development Inc., August 1981 (CDN 23101 - 23109)
	276	Videogames & Electronic Toys	note	International Resource Development, INC May 1983 (CDN 023054)
	277	Telepay vs. Videodisc		International Resource Development INC., September 1982 (CDN 023068)
	278	Health, Wealth & Self-Improvement Home Software		International Resource Development INC., September 1985 (CDN 023091)
	279	Telecommunications Market Opportunities		International Resource Development INC., November 1985 (CDN 023110-023138)
	280	VideoPrint (Contents)		June 22, 1983 (CDN 023139-23142)

Examiner's Initials	TAB NO.	DESCRIPTION	AUTHOR	PUBLICATION
	281	CompSonics/Carts		September 9, 1985 (CDN 023143)
	282	Current Samples (Compusonics Digitizes Phone Lines)		September 1985 (CDN 023144)
	283	(BME) Station Automation (New Telerecording Method for Audio)		October 1985 (CDN 023145-23146)
	284	High-Tech do-Dads for the man of the house (Sound Investments)		(CDN 023147-23150)
	285	New Software (Delivery over the phone)		Telephone Software Connection INC. October, 1982 (CDN023151)
	286	Communications (No time to shop for software)	Jessica Paioff	August 20, 1984 (CDN023152)
	287	Warner Amex QUBE Cable Communications	Peggy Conger	(CDN 023153-023157)
	288	Warner Amex QUBE Cable Communications (Articles)		(CDN 023158)
	289	QUBE-ists (Where is everyone now?)		(CDN 023159-23160)
	290	THE SHYVERS MULTIPHONE		(CDN023161-23162)
	291	Dead medium: Telephonic Jukeboxes: The Shyvers Multiphone (MULTIPHONE)		(CDN 023163-23166)

Examiner's Initials	TAB NO.	DESCRIPTION	AUTHOR	PUBLICATION
	292	Jukebox History 1934-1951		(CDN 023167-23173)
	293	New Music Box (Keyboard and Tactile Interfaces)		October 1999 (CDN 023174-23180)
	294	Britannica.com (telharmonium)		(CDN 023181)
	295	Book Review (Magic Music from the Telharmonium)	Paul Hertz	The Scarecrow Press. Inc.,(CDN 023182)
	296	Thaddeus Cahill (Dynamophone/Telharmonium) 1897		(CDN 023183-23186)
	297	Thaddeus Cahill and the Telharmonium (electric instrument)		(CDN 023187-23189)
	298	Style (The Latest Technology)	Richard Harrington	June 28, 1981 (CDN 023190-23191)
	299	Financial		October 13, 1981 (Tuesday) (CDN 023192)
	300	Labels Gear Up For "Home Music Store"	Earl Paige Ken Terry Bill Holland	April 6, 1991 (CDN 023193-23194)
	301	ABSTRACT (Home Music Store)	Laura Landro	October 14, 1981 (Wednesday) (CDN 023195)
	302	Washington Business (Music From the Skies Promised By Firm Serving Cable Users)	Scott Chase	October 19, 1981 (Monday) (CDN 023196)
	303	Arts and Leisure Desk (Sounds: The Record)	Hans Fantel	November 22, 1981 (Sunday) (CDN

Examiner's Initials	TAB NO.	DESCRIPTION	AUTHOR	PUBLICATION
		Shop Of The Future May In Your Parlor)		023197-23199)
	304	MEDIA & ADVERTISING (What is stalling the record business)		November 30, 1981. (Industrial Edition) (CDN 023200-23202)
	305	Financial Desk (CABLE TV MOVES TO THE MUSIC	Andrew L. Yarrow	July 4, 1982 (L.City Final Edition) (CDN 023203-23204
	306	TSC WRITE-UPS		(CDN 023552)
	307	Telephone Software Connection, Inc. (The Hayes Micromodem II)		(CDN 023553-23554
	308	TSC Bibliography (CALL-APPLE)		(CDN 023556-23567)
	309	COMPUTERS (TELEPHONE SOFTWARE CONNECTION)		(CDN 023559)
	310	ARTICLE REFERENCES (NOW YOUR HOME)		POPULAR MECHANICS, March 1981. (CDN 023555-23568)
	311	Buyers Guide (BRANCH CENTERS)		(CDN 023569-23570)
	312	News Link (Software delivery now at 2400 baud)		December 1985. (CDN 023571)
	313	TELEPHONE SOFTWARE CONNECTION		(CDN 023572-23573)
	314	Software (Online Tip)		(CDN 023574)
	315	TELECOMMUNICATING (PC-TALK.III)		(CDN 023575)
	316	POLL(Adults believe children know more	Lawrence	October 16, 1985. (CDN 023576)

Examiner's Initials	TAB NO.	DESCRIPTION	AUTHOR	PUBLICATION
		about computers)	Kilman	
	317	Electronic Mail (TELEPHONE SOFTWARE CONNECTION)		(CDN 023577)
	318	Data Communications (PROTECTING YOUR NETWORK DATA)	Elisabeth Horwitt	(CDN 023578)
	319	To Catch A Thief (Microcomputer)		July 1985. (CDN 023579-23583)
	320	Caller Response (Services) (Shopping for software at home, by phone)		(CDN 023584)
	321	ONLINE CONSULTING (PLANNING, PROGRAMMING & TRAINING)		(CDN 023585)
	322	Entry (Entry goes on line!)		(CDN 023586)
	323	UNIQUE (2000 New Articles Screened Each Day)		(CDN 023587)
	324	Entry (Entry Magazine)		(CDN 023588)
	325	Satin and lace, and a message base (A board is a board)	Dru Simon	(CDN 023589)
	326	REFLECTIONS (on the videotex industry)	Carole Houze Gerber	(CDN 023590)
	327	SOFTWARE ONLINE (HELP FOR DISABLED COMPUTER USERS)		(CDN 023591)
	328	Telescan Analyzer & Telescan Database		December 1984. (CDN 023592)

Examiner's Initials	TAB NO.	DESCRIPTION	AUTHOR	PUBLICATION
	329	Reader Service (Phone secretary II)		December 1984. (CDN 023593-23595)
	330	Communications Software (Software Communications Inc.)		November 1984 (CDN 023596-023601)
	331	COMMUNICATIONS (No time to shop for software?)	Jessica Paioff	August 20, 1984 (023602)
	332	Link (Telephone Software)		May 1984. (CDN 023603-23621)
	333	Sample of Available Graphics Programs (Manufacturer)		October 1984 (CDN 023607)
	334	RAM Required		October 1984 (CDN 023608)
	335	TELECOMMUNICATING	Art Kleiner	Spring 1984 (CDN 023610-23611)
	336	WHOLE EARTH RECOMMENDED TELECOMMUNICATION TOOLS (TERMINAL PROGRAMS)		February 1984 (CDN 023612-23613)
	337	MITTE (Finding MITTE)		Spring 1984 (CDN 023614-23618)
	338	ELECTRONIC MAIL PROGRAMS (MCI Mail)		Spring 1984 (CDN 023619)
	339	COMPUTER CONFERENCING SYSTEMS (CompuServe Special Interest Groups (SIGs))		Spring 1984 (CDN 023620)
	340	UNCORRECTED PAGE PROOF (HOW RO GET FREE SOFTWARE)	Alfred Glossbrenner	(CDN 023622)
		The Treasure Trove (Comments; Diversi-		

Examiner's Initials	TAB NO.	DESCRIPTION	AUTHOR	PUBLICATION
	341	DOS)		DSR, INC (CDN 023623-23630)
	342	In Search of the Consummate Time Manager (Effective Management)	Margaret P. Ezell	(CDN 023631-23632)
	343	Display (meet, report, sell, plan)		(CDN 023633)
	344	TURNING POINT (TIME IS MONEY)		(CDN 023634)
	345	LECTION		May 1984 (CDN 023635-23636)
	346	GETTING ON COMMUNI (PROVEDERS AND CONSUMERS)	Ed Magnin	Telephone Software Connection, Inc. March 1984 (CDN 023637-23638)
	347	Telecommunications (A Software Vending Machine)	Ed Magnin	Telephone Software Connection, Inc. March 1984 (CDN 023639)
	348	Telecommunications (Auto Modem)	Michael J. O'Neil	March 1984 (CDN023640)
	349	Micro Software Distribution (Now, Software Is Distributed By Wire	Ronald R. Cooke	November 1983 (CDN 023642)
	350	References : Offices and Numbers.		1984 (CDN 023643-23660)
	351	SOFTALK (SubLogic)		December 1983 (CDN 023661-23676)
	352	THE TRS CONNECTION		November 1983 9CDN 023677-023679)
	353	Display (THE ACCESS UNLIMITED MICRO SHOPPING CENTER)		November 1983 (CDN 023680)
	354	Telecommunications (Telecommunications Adviser)	Ed Magnin	Telephone Software Connection Inc. November 1983 (CDN 023681-23682)

Examiner's Initials	TAB NO.	DESCRIPTION	AUTHOR	PUBLICATION
	355	Communications (Special Delivery Software)	Lisa B. Stahr	October 1983 (CDN 023683-23686)
	356	PLUMB (EMPLOYMENT WANT ADS GO ONLINE)		June 1983 (CDN 23688-23695)
	357	Apple's New Image		(CDN 023696)
	358	Tech (Lisa And Software Writers- No Love At First Byte?)	Jessica Schwartz	(CDN 023697-23698)
	359	Display (DATAMOST)		(CDN 023699)
	360	Cider (What's New This Month)		June 1983 (CDN 023700-23701)
	361	Display (2ND Generation Spreadsheet)		(CDN 023702)
	362	Telecommunications (Telecommunications Adviser)	Ed Magnin	Telephone Software Connection Inc. June 1983 (CDN 023703-23704)
	363	Cider BOOK SHELF		June 1983 (CDN 023705-23706)
	364	Telecommunications (Telecommunications Adviser) "Acoustic"	Ed Magnin	Telephone Software Connection Inc. June 1983 (CDN 023707-23709)
	365	Downloader's Supermarket		June 1983 (CDN 023710)
	366	LETTERS (Krell Responds to review of LOGO)		(CDN 023711)
	367	Display (Apple Orchard) Peelings II responds.		November 2 1983 (CDN 023712-23713)

Examiner's Initials	TAB NO.	DESCRIPTION	AUTHOR	PUBLICATION
	368	Display (NIBBLE IS TERRIFIC)		(CDN 023714)
	369	TECHNOLOGY (Electronic Software Delivery Threatens Mail And Store Sales)	William M. Bulkeley	April 11, 1983 (CDN 023716-23717) THE WALL STREET JOURNAL
	370	ET PHONES OFFICE (Electronic Transfer)		April 1983 (CDN 023718-23721) The Digest
	371	Western Union's Easylink Gets Direct Telex-To-PC Connection		March 21, 1983 (CDN 023722)Information System News
	372	The Book Of Software		1983 (CDN 02723-23725)
	373	SOFTALK CLASSIFIED ADVERTISING (THE PREDICTOR)		April 1983 (CDN023726-23729 SOFTALK
	374	Programs boogie with-o-tech (Sales styles and marking strategies: A hard look at software)	Joanne Cleaver	(CDN023730-23731) HOME COMPUTER
	375	MARKETING MOVES (Information services move modems)	Deborah de Peyster	March 7 1983 (CDN 023733) ISO WORLD
	376	Computer-Based Business Files (Available file transfer software)		March/April 1983 (CDN 023734-23735)
	377	CHAPTER II USING YOUR THUNDERCLOCK PLUS (APPLICATIONS SOFTWARE PACKAGES SUPPORTING THE THUNDERLOCK PLUS)		(CDN 023736)
	378	THUNDERCLOCK PLUS (USER'S		(CDN 023737)

Examiner's Initials	TAB NO.	DESCRIPTION	AUTHOR	PUBLICATION
		GUIDE)		
	379	Pinball wizardry's gone electronic (the home computer)	Duane Sandul	(CDN 023738)
	380	Programmed to trim that waistline (the home computer)	Duane Sandul	February 5, 1983 (CDN 023739)
	381	High adventure (the home computer)	Duane Sandul	(CDN 023740)
	382	VARIATION ON A THEME		December 1982 (CDN 023742)
	383	PROGRAMMERS LIBRARY	Paul Leighton	December 1982 (CDN 023743-23744)
	384	THE ARCADE MACHINE (INTRODUCTION)	Chris Iochumson Doug Carlston	(CDN 023745)
	385	Telephone Transfer II (INTRODUCTION)	Leifton Paul Ed Magnin	November 1982 (CDN 023746)
	386	PRINTOGRAPHER (INTRODUCTION)	Stephen Billard	(CDN023747)
	387	CONNECTING YOUR COMPUTER TO A MODEM: WHERE TO START	Bill Chalgren	(CDN 023748-23756)
	388	L.I.S.A. (LASER SYSTEMS INTERACTIVE SYBOLIC ASSEMBLER) V. 1.5		(CDN 023757-23758)
	389	RECENT COMPUTER SCIENCE BOOKS MODIFYING YOUR MONITOR		(CDN 023759-23763)

Examiner's Initials	TAB NO.	DESCRIPTION	AUTHOR	PUBLICATION
	390	PROGRAM	Leighton Paul	(CDN023764-23765)
	391	Modems: Hooking your Computer to the World	Stan Miastkowski George Stewart	December 1982 (CDN 023766-23772)
	392	BUSINESS (Telephone Software Connection)		December 1982 (CDN 023774-23787)
	393	Displays (COOSOL COMPUTER PRODUCTS)		December 1982 (CDN 023788)
	394	Displays: APPLE (Amper-Magic)		December 1982 (CDN 023789)
	395	TOMORROW'S APPLES TODAY (TELEPHONE TRANSFER II)		November 1982 (CDN 023790-23792)
	396	Display: (Music Maker ETC.)		(CDN 023793)
	397	A GUIDE TO COMMUNICATION SOFTWARE PACKAGES (Cutting line cost)		October 1982 CDN 023794-23807)
	398	DATA COMMUNICATION PROFESSIONALS:(ENGINEERING DEPARTMENT MANAGER-SOFTWARE		October 1982 (CDN 023808)
	399	MODEMS AND THE MICROMODEM II	Athol H. Cohen	(CDN 023809-23818
	400	SOFTWARE (Arcade Math)		September/October 1982 (CDN 023819-23821)

Examiner's Initials	TAB NO.	DESCRIPTION	AUTHOR	PUBLICATION
	401	MARKETING (Makers Transform the Ways Computer Programs Are Sold)	Susan Chace	August 26, 1982 (CDN 023822)
	402	LETTER PERFECT DATA PERFECT EDIT 6502 (LETTER PERFECT)		(CDN023823-23826)
	403	PATCHING DOS THE EASY WAY	Leighton Paul	(CDN 023827)
	404	Display: TOGETHER, LOCKSMITH, THE INSPECTOR AND WATSON		(CDN 023828)
	405	ELECTRONIC MAIL SYSTEM ENHANCES DELPHI METHOD	Bernard S. Husbands	1982 (CDN 023829-23832)
	406	NEW PRODUCTS (Save Civilization in Your Spare Time)		May 1982 (CDN 023833-23843)
	407	JUST A CALL AWAY (Dial Up Software Service)		(CDN 023844)
	408	Display: RADIO & RECORDS		(CDN 023845)
	409	Display: SHE'S NO STRANGER NOW		(CDN 023846)
	410	Radio & Records: Letter to ED Magnin	Pam Bellamy	April 22, 1982 (CDN 023847)
	411	How to buy a personal computer (Here We Go Again)		(CDN 023849-23850)
	412	What's New? (Overlay Compiler)		March 1982 (CDN 023851-23852)
	413	Display: PURE POWER		February 1982 (CDN 023854)

Examiner's Initials	TAB NO.	DESCRIPTION	AUTHOR	PUBLICATION
	414	NEW PRODUCTS: Not Just Another Chess Game (Championship chess)		February 1982 (CDN 023855)
	415	NEW ELECTRONIC MAIL SERVICE ON-LINE		(CDN 023856)
	416	Display: Arithmetic Teacher (Problems for Solving Fractions)		(CDN 023857)
	417	A Guide to Personal Computers (PERSONAL-COMPUTER HARDWARE)	Steve Ditlea	December 14, 1981 CDN 02386223870) NEW YORK
	418	A Line On Friendly Utilities	Theron Fuller	(CDN 023871-23874)
	419	Conferences Goes On-Line (Ethernet Online)		(CDN 023875-23881)
	420	TERMINAL DATA	Jeffrey Mazur	September 1981 (CDN 023882-23885)
	421	DATALOOP: Smartmodem announced at NCC '81		July 2, 1981 (CDN 023886-23893)
	422	RESEARCH:	George Bond	July 7, 1981 (CDN 023894-23896)
	423	MARKET CHARTER		June 1981 (CDN 023897-23901)
	424	TELEPHONE SOFTWARE CONNECTION (Phone Log)		February 1981 (CDN 023902)
	425	Display: FASTER THAN A SPEEDING TYPIST		(CDN 023903)
	426	MARKETALK NEWS (Multi-Media		January 1981 (CDN 023904-23905)

Examiner's Initials	TAB NO.	DESCRIPTION	AUTHOR	PUBLICATION
		Video)		
	427	DIAL-YO DIRECTORY (Talking Terminals	Frank J. Derfler, Jr.	January 1981 (CDN 023906-23907)
	428	APPLE CART (Books)	Chuck Carpenter	(CDN 023908-23910)
	429	Display: SPACE WAR AND INVASION		(CDN 023911)
	430	MARKETTALK NEWS (Hardhat Software)		November 1980 (CDN 023912-23913)
	431	ADMIN.:HELLO CBS NEWS (Letter to Ed)		(CDN 023915-23916)
	432	Display: ADVANCED ELECTRONICS		(CDN 023918)
	433	NOVATION PREMIERES NEW EXHIBIT AT TWO LOS ANGELES SHOWS		(CDN 023919-23923)
	434	MICROPROCESSOR NEWSLETTER : Microprocessor Training Center		June 5, 1980 (CDN 023924-23932)
	435	THE TELEPHONE SOFTWARE EXPERIENCE A REVIEW (OF SORTS)	Val J. Golding	May 1980 (CDN 023933-23935)
	436	BIBLIOGRAPHY (hand notes)		(CDN 023917-23732)
	437	Display ;Our Records of Growth		May 1979 (CDN 023937)
	438	Display: PURCHASE AND RECEIVE SOFTWARE		(CDN 023953)
	439	Letter from License Department to		July 19, 1979 (CDN 023938)

Examiner's Initials	TAB NO.	DESCRIPTION	AUTHOR	PUBLICATION
		Edgar&Marilyn Magnin		
	440	COPY OF BUSINESS LICENSE (BUSINESS LICENSE APPLICATION)	Edgar & Marilyn Magnin	(CDN 023939-23940)
	441	Letter from J. Walker Owens RE: NEW BUSINESS OPERATOR (WELCOME)	J. Walker Owens	August 9, 1979 (CDN 023941-23944)
	442	Software for the Apple II (DYNAMAZE ,ULTRA BLOCKADE) GAMES)		(CDN 023945-23946)
	443	Display : Telephone Software Connection (MANY THANKS FOR YOUR RECENT ORDER)		(CDN 023947)
	444	Price Log (ANSWERING MACHINES, WRITE-EDIT& SEND)		(CDN 023951-23952)
	445	Display : ADVERTISEMENT (DESK CALCULATOR II)		July 1980 (CDN 023950)
	446	Instructions: Computer with header		(CDN 023954)
	447	MICROSOFT CONSUMER PRODUCTS CONTINUING THE MICROSOFT TRADITION (ANNOUNCING MICROSOFT CONSUMER PRODUCTS)		(CDN 023955)
	448	THE APPLE ORCHARD (COMPUTERWORLD PRINTER INT ROUTINE)		March/April 1980 (CDN 023956)

Examiner's Initials	TAB NO.	DESCRIPTION	AUTHOR	PUBLICATION
	449	VOLUME TABLE OF CONTENTS (\$11,0)		July/August 1980 (CDN 023957-23959)
	450	SUP'R'TERMINAL (SPECIFICATIONS)		(CDN 023960)
	451	CALL-APPLE (functions, remin.)		March/April 1980 (CDN 023961)
	452	CALL-APPLE (STOCK MARKET DATA RETRIEVAL ONE THE SOURCE)	Hersch Pilloff	March/April 1980 (CDN 023962)
	453	CBS NEWS CREW FROM WALTER CRONKITE	David Dow	September 9, 1980 (CDN 023963-23965)
	454	Telephone Software Connection (PHONE LOG)		(CDN 023966-23969)
	455	Advertising for quicker shopping over computer (GO-MOKU)		(CDN 023970-23971)
	456	Advertising for Pet and Apple II Users (PASCAL)		November/December 1980 (CDN 023973)
	457	Letter from Telephone software Connection (REGARDING THE ELECTRONIC COMMUNICATION SERVICE)		March (CDN 023977)
	458	Letter (OFFERING INTRODUCTION)		(CDN 023979-23983)
	459	Letter from Ed Magnin REF: TSC/ TELEMAIL USER)	Ed Magnin	February 8, 1982 (CDN 023984)
	460	NOW YOUR HOME COMPUTER CAN CALL OTHER COMPUTERS ONE THE	Neil Shapiro	March 1981 (CDN 023985-23987)

Examiner's Initials	TAB NO.	DESCRIPTION	AUTHOR	PUBLICATION
		TELEPHONE		
	461	Advertising (SHAPE BUILDER, TERMINAL PROGRAMS, DOUBLE DOS, MATH TUTOR)		March 1981 (CDN 023988-23990)
	462	SOFTALK (MICROMATE'S MICRONET-IT PLUGS IN THE GAME PORT)		May (CDN 023991)
	463	VOIDED BLANK CHECK #1513		May (CDN 023998)
	464	CORVUS CONTROLLING 3 APPLES (WE HAVE NEW PHONE NUMBERS)		May 18, 1981 (CDN 023999)
	465	PREDICTING THE FUTURE WITH ELECTRONIC MAIL (THE TELENET WAY)	Bernard S. Husbands	October 1981 (CDN 024000-24001)
	466	PROGRAM SHOPPING BY PHONE : SOFTWARE CO. DOWNLOADS PROGRAMS	Michael Swaine	October 19, 1981 (CDN 024002)
	467	TELEPHONE SOFTWARE CONNECTION, INC. (THE HAYES MICROMODEM II : I'VE NEVER BROUGHT A BETTER SLAVE		July 1981 (CDN 024003)
	468	ADVERTISING (SHAPE BUILDER)		CDN 024006-24008)
	469	ADVERTISING (TELEPHONE TRANSFER ID)		(CDN 024009)
	<u>470??</u>			

Examiner's Initials	TAB NO.	DESCRIPTION	AUTHOR	PUBLICATION
	471	Display: THE FP REPORT		(CDN 024018) TELEPHONE SOFTWARE CONNECTION. INC.
	472	Display: ORDER VIA MODEM		(CDN 024019)
	473	PRICE LOG		June 2, 1982 (CDN 02492023422)
	474	PRICE LOG CONT.)		October 21, 1982 (CDN 024023)
	475	Display: TELEPHONE SOFTWARE CONNECTION (ADDRESS POSTAGE)		(CDN 024024-24025)
	476	TELEPHONE SOFTWARE CONNECTION (Letter to Apple Dealer)	Ed Magnin	(CDN 024026)
	477	Display (MR. SMARTYPANTS)		(CDN 024028-24030)
	478	Display (DISK-CRYPTION)		(CDN 024031-24032)
	479	Display (VIDEO LIBRARIAN		(CDN 024033-24035)
	480	Display (WORLD CURRENCY TRADER)		(CDN 024036-24037)
	481	Display (WORKING MODEL OF TELEPHONE SOFTWARE)		(CDN 024038)
	482	TELEPHONE SOFTWARE CONNECTION (Letter to AppleCat Owner)	Ed Magnin	(CDN 024039-24040)
	483	TELEPHONE SOFTWARE CONNECTION : THE HAYES MICROMODEM II (I've never bought		May 1980 (CDN 024041-24042)

Examiner's Initials	TAB NO.	DESCRIPTION	AUTHOR	PUBLICATION
		better slave)		
	484	SPECIAL MEMO TO EDUCATORS	Ed Magnin	(CDN 024043-24044)
	485	TELEPHONE SOFTWARE CONNECTION (BACKGROUNG PIECE		(CDN 024045-24049)
	486	Display : VEND-O-DISK		(CDN 024050-24052)
	487	Letter to Programmer	Ed Magnin	(CDN 024053-24054)
	488	NEWS FROM T.S.C.		April 1983 (CDN 024055-24058)
	489	NEWS FROM T.S.C.		June 1983 (CDN 024059-24062)
	490	WHAT IS VOICEMAIL?		(CDN 024063-24065)
	491	TELEPHONE SOFTWARE CONNECTION (INTRODUCTION)	ED Magnin	(CDN 024066-24067)
	492	NEWS FROM T.S.C.		October 1983 (CDN 024068-24071)
	493	HOW TO ORDER : MODEM		024072-24077)
	494	Telecommunication (TELEDELIVERY)		(CDN 024084)
	495	NEWS FROM T.S.C.		June 1984 (CDN 024085-24088)
	496	PlumbLine (BASE COMPUTERS)		(CDN 024089-24090)
	497	NEWS FROM T.S.C.		December 1984 (CDN 024091-24094)
	498	NEWS FROM T.S.C.		March 1985 (CDN 024095-24098)
	499	Display: PHONE SECRETARY		(CDN 024099-24100)

Examiner's Initials	TAB NO.	DESCRIPTION	AUTHOR	PUBLICATION
	500	TELEPHONE SOFTWARE CONNECTION (BACKGROUND PIECES)		(CDN 024101-24106)
	501	TELEPHONE SOFTWARE CONNECTION (TOP SECRET) Displays		(CDN 02410724113)
	502	Display (Before 1984)		(CDN 024114)
	503	Display: IF YOU HAVE AN APPLE (phone list)		(CDN 024115-24117)
	504	Display (THE FP REPORT)		(CDN 024118-24119)
	505	THE HAYE'S MICROMODEM II		CDN 024120-24121)
	506	PRICE LOG		(CDN 024122-24123)
	507	NEWS FROM T.S.C.		October 1983 (CDN 024124)
	508	Display: Instructions on Software Delivery)		(CDN 024125)
	509	PRICE LOG		(CDN 024126-24127)
	510	NEWS FROM T.S.C.		June 1983 (CDN 024128-24129)
	511	PRICE LOG		(CDN 024130-24131)
	512	NEWS FROM T.S.C.		(CDN 024132-24133)
	513	Display (PHONE SECRETARY II (54)		CDN 024134)
	514	Letter to Programmer	Ed Magnin	(CDN 024135)

Examiner's Initials	TAB NO.	DESCRIPTION	AUTHOR	PUBLICATION
	515	PROGRAMMERS' PIPELINE(DESCRIPTION SLIP)		(CDN 024136-24137)
	516	Display: WORLD CURRENCY TRADER		(CDN 024138)
	517	PRICE LOG		(CDN 024139-24140)
	518	Display: ORDER VIA MODEM		(CDN 024141)
	519	Display: SIX GREAT WAYS TO ADD TO YOUR SUMMER FUN!		CDN 024142)
	520	PHONE LOG		(CDN 024143-24144)
	521	NEWS FROM T.S.C. (RECENT OFFERINGS)		March 1985 (CDN 024145)
	522	SPOTLIGHT ON GRAPHICS (SHAPE BUILDER)		CDN 024146-24148)
	523	DISK LABELMAKER (#73)		CDN 024149)
	524	NEWS FROM T.S.C. (TERMINAL PROGRAM II)		(CDN 024150-24152)
	525	FREE UPDATE TO DESK CALENDAR II		(CDN 024153)
	526	NEWS FROM T.S.C.		June 1984 (CDN 024154-24156)
	527	Display : (DISK-CRYPTION)		(CDN 024157-24158)
	528	Display: (PHONE SECRETARY) (#54)		(CDN 024159-24160)
	529	COMMUNICATION (TERMINAL		(CDN 024161-24168)

Examiner's Initials	TAB NO.	DESCRIPTION	AUTHOR	PUBLICATION
		PROGRAM)		
	530	DIALING INSTRUCTIONS		(CDN 024169)
	531	Telecommunications Adviser	Ed Magnin	November 1983 (CDN 024170-24171)
	532	GETTING ON COMMUNI ((PROVIDERS AND CONSUMERS)	Ed Magnin	March 1984 (CDN 021417224173)
	533	ONLINE TIPS		(CDN 024174)
	534	Display: List (SOFTWARE SALES)		April 11, 1983 (CDN 024175)
	535	A SOFTWARE VENDING MACHINE	Ed Magnin	March 1984 (CDN 024176)
	536	MARKETING (Makers Transform the Ways Computer Programs Are Sold)	Susan Chace	August 26, 1982 (CDN 024177) THE WALL STREET JOURNAL
	537	TECHNOLOGY (Electronic Software Delivery Threatens Mail and Store Sales)		May 6, 1983 (CDN 024178)
	538	Western Union: Mailgram (Letter to Microcomputer User)		(CDN 024179)
	539	Apple//c Baud Rate Problem (Dialing Instructions)		(CDN 024180)
	540	Display: Recent Offerings		March 1985 (CDN 024181-24184)
	541	Letter to Prometheus Modem Owner	Ed Magnin	(CDN 024185)
	542	Display: PHONE SECRETARY// (54)		(CDN 024186-24187)
	543	FUTURE DEVELOPMENTS IN		(CDN 024188)

Examiner's Initials	TAB NO.	DESCRIPTION	AUTHOR	PUBLICATION
		TELECOMMUNICATION		
	544	RESPONSES (FUTURE DEVELOPMENTS IN TELECOMMUNICATION)		(CDN 024189)
	545	CHARTS (USES FOR TELECOMMUNICATION LINKS)		(CDN 024190-24192)
	546	PROLOGUE (THE COMMUNICATION SATELLITE)		(CDN 024193-24194)
	547	ANALOG VERSUS DIGITAL TRANSMISSION		(CDN 024195-24206)
	548	CABLE TELEVISION AND ITS POTENTIAL		(CDN 024207-24209)
	549	Display : Qube gets you into the action		(CDN 024210)
	550	TERMINALS IN THE HOME		(CDN 024211-24223)
	551	A FUTURE SCENARIO		(CDN 024224-24246)
	552	SIGNAL COMPRESSION		(CDN 024247-24261)
	553	Letter from Ed Magnin (MONTHLY RENTAL)	Ed Magnin	(CDN 024262-24264)
	554	JITTERS		July 29, 1996 (CDN 024265) Business Week
	555	E-COMMERCE: WHO OWNS THE		July 29 1996(CDN 02466-24267)

Examiner's Initials	TAB NO.	DESCRIPTION	AUTHOR	PUBLICATION
		RIGHTS?		
	556	"A pilot has to believe in his equipment. (ROLEX)		(CDN 024268)
	557	Retailers cheer end of patent challenge	Dan Goodin	April 2, 1999 (CDN 024269-24271)
	558	Patently Offensive	Shoshana Berger	(CDN 024272)
	559	Magnin & Associates (Video Game, Film & TV)		(CDN 024273-24274)
	560	Documents (Appendix F: Decimal Tokens for Keywords)		(CDN 024275-24276)
	561	Appendix F: Decimal Tokens For Key words		(CDN 024277)
	562	PRIVATE PEOPLE (Easing the way for libel suits)		(CDN 024278)
	563	MAY THE SOURCE BE WITH YOU	Christopher Byron	(CDN 024279)
	564	INFORMATION SERVICES: MODEMS		(CDN 024280)
	565	A SOURCE OF RICHES	Alfred Glossbrenner	August 1983 (CDN 024281-24284)
	566	ELECTRONIC JACKPOT	Alfred Glossbrenner	September 1983 (CDN 024285-24287)
		CONSUMER AND SPECIALIZED ON-		

Examiner's Initials	TAB NO.	DESCRIPTION	AUTHOR	PUBLICATION
	567	LINE SERVICES		(CDN 024288-24290)
	568	CALCULATION PROGRAMS		(CDN 024291-24293)
	569	WHAT IS VIEWDATA		CDN 024294-24302)
	570	PM ELECTRONICS MONITOR	Neil Shapiro	(CDN 024303)
	571	DIAL-UP SOFTWARE NETWORKS	Jules H. Gilder	May 1980 (CDN 024304-24306)
	572	SOFTWARE AND DATA VIA TELEPHONE		October 1980 (CDN 024307-24310)
	573	DIAL-UP SOFTWARE NETWORKS	Herb Friedman	October 1992 (024311-24314)
	574	Documents (Ticketmaster to Lick Competition by Buying It)		(CDN 024315-24316)
	575	TICKETMASTER (memo)	Alan Citron Michael Cleply	February 26, 1991 (CDN 024317-24318) Los Angeles Times
	576	TICKETMASTER: 20 Years (INDUSTRY'S #1 HAS A TICKET TO RULE)	Adam Sandler	(CDN 024319-24321)
	577	ELECTRONIC LIFE	Michael Crichto	1983 (CDN 024322)
	578	THE NAKED COMPUTER (Telesoftware ?)	Rochester, Gantz, William Marrow + Co.	(CDN 024323)

Examiner's Initials	TAB NO.	DESCRIPTION	AUTHOR	PUBLICATION
	579	COMPUTERS FOR EVERYBODY (Downloading Programs)	Jerry Willis	1984 (CDN 024324-24328)
	580	TELECOMMUNICATIONS IN THE INFORMATION AGE (Videotext Chapter 12)	Singleton	1983 (CDN 024329-24340)
	581	UNITED STATES PATENT (LOCKWOOD)		May 3, 1994 (CDN 024341-24343)
	582	UNITED STATES PATENT (YURIS, et. al.)		January 27, 1981 (CDN 024344)
	583	UNITED STATES PATENT (KELLY, et. al.)		May 15, 1984 (CDN 024345)
	584	UNITED STATES PATENT (HELLMAN)		April 14, 1987 (CDN 024346-24347)
	585	Documents (THE WIRED SOCIETY)	James Martin	(CDN 02434824349)
	586	NEW USE OF TELEVISION (VIEWDATA)		(CDN 024350)
	587	NEWS (DO-IT-YOURSELF NEWSPAPERS)		(CDN 024351)
	588	SPIDERWEBS (PIERRE TEILHARD de CHARDIN		(CDN 024352-24353)
	589	INSTANT MAIL (DIGITIZED MESSAGES)		(CDN 024354)
	590	INFORMATION DELUGE		(CDN 024355)

Examiner's Initials	TAB NO.	DESCRIPTION	AUTHOR	PUBLICATION
	591	SATELLITE AGE (Chapter Fourteen HOME)		CDN 024356-24366)
	592	James Martin & Co. Executive Profiles (James Martin)		October 25, 1996 (CDN 024367-24368) JM & Co.
	593	2. NEWS (Dow Jones News/ Retrieval's Free-Text Search)		1985 (CDN 024369-24383)
	594	COMPUTERS (TELESUN)		(CDN 024384-24387)
	595	16 FULL-SERVICE (THE SOURCE)		(CDN 024388-24408)
	596	Article 49 of 88 PATNEWS : Another reason why the E-Data patent is invalid	Gregory Atharonian	October 16, 1996 (CDN 024409-24410) Deja News
	597	Article 1 of 25 PATNEWS: Mor PTO gossip on Zaache,Edata, Hyatt	Gregory Atharonian	October 18, 1996 (CDN 024411-24412)
	598	Display: TSC Rreview		(CDN 024413)
	599	UNITED STATES POSTAL SERVICE (Documents & Letters)		(CDN 024414-24423)
	600	THE HOME ACCOUNTANT, REVISITED (Responds to reviews)		(CDN 024424-24426)
	601	DFX (Introductions)	Graeme Scott	(CDN 024427-24442)
	602	PEELINGS REVIEW (Introductions)		November 12, 1982 (CDN 024443)
	603	PELLINGS II (Programmers Library)		NOVEMBER 10, 1982 (CDN 024444-24454)

Examiner's Initials	TAB NO.	DESCRIPTION	AUTHOR	PUBLICATION
	604	Letter (TRIAL TERMINAL)	K.F. MOSELEY	March 10, 1981 (CDN 024455)
	605	K.F. MOSELEY'S TVINTERFACE 8 EVALUATION (TIME AND MONEY METER)	Ed Magnin	(CDN 024456-24457)
	606	A.D.A.M. II NEWSLETTER (ACKNOWLEDGEMENT)		May 13, 1981 (CDN 024458-24465)
	607	PEELINGS II (Publication of Apple Software Reviews)		August 6, 1980 (CDN 024467-24500)

Examiner's Initials	TAB NO.	DESCRIPTION	AUTHOR	PUBLICATION
	608	Apple-Cart (Input From Readers)	Chuck Carpenter	(CDN 024501-24503) CREATIVE COMPUTING
	609	CALL-APPLE (THE TELEPHONE SOFTWARE EXPERIENCE A REVIEW (OF SORT))	Val Golding	(CDN 024504)
	610	SOFTALK (Peachy Writer)		September 1982 (CDN 024505)
	611	SOFTALK (Performer Printer Format Board)		(CDN 024506)
	612	Extra Copy RE: KM		(CDN 024507-24508)
	613	MARKETING (Makers Transform Ways Computer Programs Are Sold)	Susan Chace	August 26, 1982 (CDN 024509) THE WALL STREET JOURNAL

Examiner's Initials	TAB NO.	DESCRIPTION	AUTHOR	PUBLICATION
	614	MARKETING (SOME COMPUTER JUNKIES)	Susan Chace	August 26, 1982 (CDN 024510) THE WALL STREET JOURNAL
	615	EXTRA		(CDN 024511)
	616	New Products (Save Civilization in Your Spare Time)		May 1982 (CDN 024512) POPULAR COMPUTING
	617	EXTRA		(CDN 024513)
	618	What's New? (Overlay Compiler)		March 1982 (CDN 024514)
	619	The Information Directory Says It All! (SUBJECT INDEX)		(CDN 024515)
	620	Tap New Markets! (Information Directory)		(CDN 024516)
	621	THE 21ST CENTURY LIBRARY (Information Directory)	Anne M. Helfrich	March 16, 1982 (CDN 024517-24524)
	622	ELECTRONIC MAIL (APPLICATIONS FOR MANAGEMENT)		(CDN 024525-24534)
	623	InfoWorld (AVL Eagle)		October 19, 1981
	624	TSC (MICROCOMPUTING)		October 15, 1981 (CDN 024536)
	625	ELECTRONIC DISTRIBUTION (Trial Builder)		(CDN 024537-24546)
	626	MUSIC (Honey. They're Downloading Our Song)	Patrick M. Reilly	(CDN 024547-24548)

Examiner's Initials	TAB NO.	DESCRIPTION	AUTHOR	PUBLICATION
	627	WHO'S NEWS (Foundation Health Names Malik Hasan As CEO and President)		May 13, 1997 (CDN 024549)
	628	INDUSTRY FOCUS (Middlemen Find Ways to Survive Cyberspace Shopping)	David Bank	December 12, 1996 (CDN 024550)
	629	Egghead Inc. Ships Software Over Internet (Ingram Micro Inc.)	David Bank	November 8, 1996 (CDN 024551)
	630	Tom Clancy, Virtus Start Firm for On-Line Games		November 13, 1996 (CDN 024552)
	631	N2K Hires Phil Ramone to Start Up A Music Label Linked to the Internet	Patrick M. Reilly	November 18, 1996 (CDN 024553)
	632	BUSINESS BRIEFS (AT&T UNVEILS A SERVICES TO HELP BUSINESSES SET UP SHOP ON INTERNET)	JamesSanberg	October 9, 1996 (CDN 024554)
	633	TECHNOLOGY & HEALTH (Industry. Net Customers to Be Offered On-Line Payment Services From PNC)	Raju Nariseti	September 25, 1996 (CDN024555)
	634	Vague New World (Digital Media Business Takes Form as a Battle Of Complex Alliances).		(CDN 024556-24558)
	635	Music Firms Vow to Block New CD System	Meg Cox	May 14, 1993 (CDN 024559-24560)
	636	BUSINESS (Blockbuster plans to stock CDs electronically)		May 12, 1993 (CDN 024561)

Examiner's Initials	TAB NO.	DESCRIPTION	AUTHOR	PUBLICATION
	637	TECHNOLOGY & HEALTH (Belcore to Demonstrate System For Delivering Movies By Phone)	Mary Lu Carnevale	November 9, 1992 (CDN 024562)
	638	TECHNOLOGY (IBM COMMITS MORE THAN \$100 MILLION ON VENTURE TO RELAY VIDEO, OTHER DATA)	Michael W, Miller	September 16, 1992 (CDN 024563-24564)
	639	IBM TO UNVEIL PLAN TO SKIP DISKS, SEND SOFTWARE BY SATELLITE (GM's Hughes Network Joins Big Blue Alliance to Serve Retailers and Corporations)	Bart Ziegler	November 1, 1994 (CDN 024565-24566)
	640	Software Industry Bulletin (SIB THIRD QUARTER 1985 SOFTWARE EMPLOYMENT SURVEY)		October 14, 1985 (CDN 024567-24568)
	641	DOWNLOAD (VENDORS KICK OFF FALL SEASON WITH TELEDELIVERY VENTURES)		September 1985 (CDN 024569-24583)
	642	SPEED>S (ELECTRONIC DELIVERY OF SOFTWARE)		(CDN 024584-24595)
	643	PHONE MEMO		April 19, 1985 (CDN 024596-24600)
	644	Letter to Nathaniel Forbes (MCI MAIL LETTER)	Ed Magnin	April 8, 1985 (CDN 024601-24607)
	645	SPEED>S (THE INSIDE STORY)		April 8, 1985 (CDN 024608-24623)
		Document: Letter to Nathaniel Forbes		

Examiner's Initials	TAB NO.	DESCRIPTION	AUTHOR	PUBLICATION
	646	(EXPRESS MAIL)	Ed Magnin	March 29, 1985 (CDN 024624-24630)
	647	GIMCRAX, INC (The leader in electronic delivery of software)		December 5, 1984 (CDN024631-24636)
	648	SPEED>S (New Edition of SPEED>S disk Now Available)		(CDN 024637)
	649	SPEED>S (Postage)		(CDN 024638)
	650	SPEED>S (Over 50 Lotus 1-2-3 templates to be available exclusively on SPEED>S!		(CDN 024639)
	651	SPEED>S (Postage)		(CDN 024640)
	652	SPEED>S (Open An Electronic Library for Your Company Software)		(CDN 024641)
	653	SPEED>S (Postage)		January 27, 1986 (CDN 024642)
	654	GIMCRAX LAUNCHES FILE DELIVERY SERVICE		December 23, 1985 (CDN 24643)
	655	SPEED>S (WHAT MODEM SHOULD I BUY)		November 22, 1985 (CDN 024644)
	656	Display (SPEED>S)		December 2, 1985 (CDN 024645)
	657	SPEED>S (NOW! Try SPEED>S Electronic Delivery!)		October 21, 1985 (CDN 024646)
	658	SPEED>S (YOUR FIRST ISSUE ON THE SPEED>S PASSWORD!)		(CDN 024647)

Examiner's Initials	TAB NO.	DESCRIPTION	AUTHOR	PUBLICATION
	659	INTERNATIONAL VIDEOTEX TELETEXT NEWS (GIMCRAX TO DOWNLOAD)		August 1984 (CDN 024648)
	660	SPEED>S (SPEED>S MEAN BUSINESS)		(CDN 024649-24652)
	661	NEWS FROM THE SOURCE (NAT FORBES PROMOTED TO DIRECTOR OF SALES FOR STC)		(CDN 024653-24654)
	662	SPEED>S (SPEED>S MEAN BUSINESS)		(CDN 024655-24658)
	663	HANDWRITTEN NOTES		(CDN 024659-24665)
	664	HANDWRITTEN NOTES (NAT FORBES)		March 28, 1985 (CDN 24666-24668)
	665	NET TO TRANSMIT VIDEOTEX, GAMES TO 12 MILLION USER	Jim Bartimo	June 13, 1983 (CDN 024669) COMPUTER WORLD
	666	Vending machines for software: What will Japan think up next? (Games only)		June 1985 (CDN 024670) Data Communications
	667	Electronic Software Distributor To Show System to Retailers	Rory J. O'Connor	May 30, 1983 (CDN 024671)
	668	Software Industry Bulletin (ELECTRONIC SOFTWARE DISTRIBUTORS)		(CDN 024672-24675)
	669	SOFTWARE (Why try to stock software like physical goods? Why not just reproduce it as needed)		(CDN 0924676-24683)

Examiner's Initials	TAB NO.	DESCRIPTION	AUTHOR	PUBLICATION
	670	Mr. Download: An Interview with William von Meister		(CDN 024684-24693)
	671	Letter to Bob Peyser (Telephone Software Connections)	Ed Magnin	March 25, 1985 (CDN 02469424700)
	672	DIRECT -NET (Micro Marketworld Readers)	Bill James	February 1, 1985 (CDN 024701-24702)
	673	Cutting Out the Middleman (Looking to expand their customer base)	Myron Berger	(CDN 024703-24708)
	674	SHOP BY MODEM (Software Without Manuals)		(CDN 024709)
	675	Speak the Universal Lanaguage (POWERHOUSE)		(CDN 024710)
	676	Letter to Ed Magnin (SOFTWARE AUTHOR ROYALTY AGREEMENT)	Fonnie Clifton	October 17, 1983 (CDN 024711-24733)
	677	BUY SOFTWARE VIA MODEM (DEFINE THE NEED)	Elizabeth Ferrarini	(CDN 024734-24745)
	678	ABC VIDEO ENTERPRISES TELEFIRST PROJECT HAD BOOSTERS & DOUBTERS		May 1, 1984 (CDN 024746)
	679	DOWNLOAD (MICRPRO & ADAPSO SUE AMERICAN BRANDS, ALLEGE SOFTWARE PIRACY)		February 1985 (CDN 024747-24762)
	680	Coleco, AT&T Unit to Form Joint Venture	Bob Davis	(CDN 024763)

Examiner's Initials	TAB NO.	DESCRIPTION	AUTHOR	PUBLICATION
		To Distribute Video Games By Telephone		
	681	ELECTRONIC(PULLING THE PLUG ON ELECTRONIC PUBLISHING)		(CDN 024764-24766)
	682	SOFTWARE (SOFTWARE DIRECTORIES GO ON-LINE)	Joanne Gamlin	(CDN 024767-24780)
	683	SAY IT WITH REMOTE ROM SOFTWARE DELIVERY (Looking Ahead With Software News)		(CDN 024781)
	684	IT'S NOT THE SAME OLD 'HELP' ANYMORE (Buzz Word)	Mary-Beth Santarelli	(CDN 024782)
	685	ARE YOU GETTING READY FOR ELECTRONIC SOFTWARE DELIVERY?	Richard Lewis	February 1984 (CDN 024783-24788)
	686	Hammerly files suit against PC Telemart		(CDN 024789)
	687	MICRO SOFTWARE TODAY (EDUCATION: ENTERTAINMENT)		(CDN 024790)
	688	DISTRIBUTION & RETAILING (XANTE TO DISTRIBUTE SOFTWARE ELECTRONICALLY TO MASS MERCHANTISERS)		(CDN 024791)
	689	SYSTEMS : Software Engineering (Letter from Phil Klamm)	Phil Klamm	January 20, 1984 (CDN 024792)
	690	ROM-LABS (ELECTRONIC SOFTWARE DISTRIBUTION SYSTEM)		January 3, 1984 (CDN 024793-24802)

Examiner's Initials	TAB NO.	DESCRIPTION	AUTHOR	PUBLICATION
	691	VAN DIVER'S (The Most Resourceful Directories for the IBM PC		(CDN 024803)
	692	SOFTWARE DISTRIBUTION: SMOOTH GOING NOW : ROCKY ROAD AHEAD	Steve Burke	(CDN 024804)
	693	Romox is hoping to have system in 3,000 stores by end of '84		(CDN 024805)
	694	Display (SOFT TOUCH)		January 12, 1984 (CDN 024806)
	695	BUGS IN ELECTRONIC SOFTWARE DISTRIBUTION NOT WORKED OUT (ELECTRONIC DISTRIBUTION)	Lisa Raleigh	(CDN 024807-24809)
	696	ANNOUNCING A NEW IN-DEPTH STUDY AND ANALYSIS OF (Downloading & Teledelivery of Computer Software, Music & Video)	Nancy L. Stocker	March 11, 1986 (CDN 024810-24824)
	697	CERTIFICATE OF COPY REGISTRATION (TIME AND MONEY METER)	Edgar J. Magnin	March 8, 1982 (CDN 024825-24840)
	698	CERTIFICATE OF COPY REGISTRATION (QUICK CLOCK ADJUST)	Edgar J. Magnin	(CDN 024841-24847)
	699	CERTIFICATE OF COPY REGISTRATION (MATH TUTOR)	Edgar J. Magnin	July 18, 1981 (CDN 024848-24864)
	700	Document: DELIVERY NOTICE ((CDN 024865

Examiner's Initials	TAB NO.	DESCRIPTION	AUTHOR	PUBLICATION
		CERTIFIED)		
	701	Document: POSTAL RECEIPT (CERTIFIED) From : Ed & Marilyn Magnin		March 27, 1981 (CDN 024866)
	702	RECEIPT FOR CERTIFIED MAIL #288727		March 6, 1981 (CDN 024867)
	703	INSTRUCTIONS :CERTIFIED MAIL FEE, OPTIONAL SERVICES		(CDN 024868)
	704	Letter from Edgar J. Magnin (COPYRIGHTS REGISTRATION: TERMINAL PROGRAMS	Edgar J. Magnin	March 5, 1981 (CDN 024869-24889)
	705	RECEIPT (REGISTER OF COPYRIGHTS)		November 4, 1980 (CDN 024890-24905
	706	RECEIPT (REGISTER OF COPYRIGHTS: LIBRARY OF CONGRESS		September 3, 1980 (CDN 024906-24927)
	707	CERTIFICATE OF COPYRIGHT REGISTRATION (PHONE SECRETARY)	Edgar J. Magnin	November 4, 1980 (CDN 024929-24934)
	708	Letter from Edgar J. Magnin (COPYRIGHT REGISTRATION: PHONE SECRETARY)	Edgar J. Magnin	August 27, 1980 (CDN 024935-24946)
	709	Letter from Edgar J. Magnin (CALL TSC, PICTURE TRANSFER, GO-MOKU, CHESS CONNECTION	Edgar J. Magnin	May 30, 1980 (CDN 024947-24951)
	710	CERTIFICATE OF COPYRIGHT REGISTRATION (GO-MOKU)	Edgar J. Magnin	June 9, 1980 (CDN 024952-24960)

Examiner's Initials	TAB NO.	DESCRIPTION	AUTHOR	PUBLICATION
	711	CERTIFICATE OF COPYRIGHT REGISTRATION (CHESS CONNECTION)	Craig Crossman	(CDN 024961-24971)
	712	CERTIFICATE OF COPYRIGHT REGISTRATION (GO-MOKU)	Edgar J. Magnin	(CDN 024972-24981)
	713	CERTIFICATE OF COPYRIGHT REGISTRATION (CALL TSC)	Edgar J. Magnin	(CDN 024982-24986)
	714	CERTIFICATE OF COPYRIGHT REGISTRATION (PICTURE TRANSFER PROGRAM)	Edgar J. Magnin	(CDN 024987-25002) April 1980
	715	Letter from Edgar J. Magnin :APPLICATIONS FOR COPYRIGHT (ANSWERING MACHINE, WRITE- EDIT & SEND, TELEPHONE TRANSFER PROGRAM)	Edgar J. Magnin	March 28, 1980 (CDN 025003-25007)
	716	CERTIFICATE OF COPYRIGHT REGISTRATION (WRITE- EDIT & SEND	Edgar J. Magnin	(CDN 025008-25018)
	717	CERTIFICATE OF COPYRIGHT REGISTRATION (TELEPHONE TRANSFER PROGRAM)	Edgar J. Magnin	(CDN 025019-25033)
	718	CERTIFICATE OF COPYRIGHT REGISTRATION (ANSWERING MACHINE)	Edgar J. Magnin	(CDN 025035-25046)
	719	CERTIFIED RECEIPTS: CERTIFICATE	Leighton Paul	October (CDN 025047-25095)

Examiner's Initials	TAB NO.	DESCRIPTION	AUTHOR	PUBLICATION
		OF COPYRIGHT REGISTRATION (TELEPHONE TRANSFER II)		
	720	CERTIFICATE OF COPYRIGHT REGISTRATION (TELEGAMMON)	Anton Dahbura, JR.	(CDN 025096-25139)
	721	Letter to Mr. Ledbetter RE: Correspondence of 3/12/82 control # 2-054-0414(M)	Edgar J. Magnin	October 4, 1982 (CDN 025140-25212)
	722	CERTIFICATE OF COPYRIGHT REGISTRATION (PHONE SECRETARY II)	Edgar J. Magnin	September 6, 1983 (CDN 025213-25253)
	723	CERTIFICATE OF COPYRIGHT REGISTRATION (FIFTEEN. PUZZLE)	Edgar J. Magnin	7, 1985 (CDN 025254-25313)
	724	Letter to Mr. Magnin: RE: FRACTION TUTOR (TX 1 384 355) sand TYPING SPEED BUILDER (CERTIFICATE OF COPYRIGHT REGISTRATION (FRACTION TUTOR)	Edgar J. Magnin Larry M. Schultz	January 4, 1985 (CDN 025314-25344)
	725	RECEIPT FOR CERTIFIED MAIL (CERTIFICATE OF COPYRIGHT REGISTRATION (PICTURE PUZZLE PROGRAMS)	Edgar J. Magnin	(CDN 25345-25380)
	726	CERTIFICATE OF COPYRIGHT REGISTRATION (QUICK COMPARE)	Leighton Paul	(CDN 025381-25405)
	727	Telephone Software Connection, Inc. (PROGRAM LISTING)		(CDN 025406-25408)

Examiner's Initials	TAB NO.	DESCRIPTION	AUTHOR	PUBLICATION
	728	SERIAL LISTING		(CDN 025409)
	729	SERIAL LISTING (CON'T)		(CDN 025410)
	730	COPYRIGHT STATUS (PROGRAMS, COPYRIGHT NOTICE ETC.)		(CDN 02541125412731)
	731	RECEIPTS FOR CERTIFIED MAIL : Letter from Edgar J. Magnin to Register of Copyrights (INSTANT MENU) CERTIFIED OF COPYRIGHT REGISTRATION	Edgar J. Magnin	June 6/11 1985 (CDN 025413-25448)
	732	RECEIPTS FOR CERTIFIED MAIL: Letter from Edgar J. Magnin to Register of Coping (CERTIFIED OF COPYRIGHT REGISTRATION) : MORTGAGE ANALYZER	Eagar J. Magnin	(CDN 025449-25475)
	733	CompuSonics Version 1.05 (THE DRIVE EVENT CONTROL LOOP FOR THE DSP-1000)		July 17, 1987 (CDN 025476-255545)
	734	Documents (ROUTING FOR THE MACHINE, ROUTINES REQUIRED TO READ AND TO THE FRONT PANES)"		March 11, 1987 (CDN 025546-25667)
	735	CompuSonics D S P 2002 version 1.00 (PRELIMINARY USER MANUAL		August 28, 1985 (CDN 025668-25707)
	736	AUDIO COMPUTER OWNERS GUIDE		(CDN 025708)

Examiner's Initials	TAB NO.	DESCRIPTION	AUTHOR	PUBLICATION
		(ADVERTISING)		
	737	QUICK REFERENCE CARD (OPERATIONS)		(CDN 025709-25767)
	738	AN ALGORITHM AND ARCHITECTURE FOR CONSTANT-Q SPECTRUM ANALYSIS (ABSTRACT)	Gary W. Schwede	April 1983 (CDN 025768-25771)
	739	AES (PRESENTED AT THE 76th CONVENTION 1984 OCTOBER 8-11 NEW YORK)		(CDN 025772-025775)
	740	COMMAND AND STATUS REGISTERS (RECEIVE DATA COUNT REGISTER)		CDN 025776-25786)
	741	Letter to David M. Schwartz (RE: THE PREPRINTS FROM THE AES 78th CONVENTION)	Patricia M. Macdonald	November 18, 1985 (CDN 25787-25817)
	742	EFFICIENT DATA REDUCTION FOR DIGITAL AUDIO USING A DIGITAL FILTER ARRAY (PURPOSE)	John P. Staunter. David M. Horowitz	1986 (CDN 025818-25821)
	743	AES (PRESENTED AT THE 83rd CONVENTION 1987 OCTOBER 16-19 NEW YORK)	David M. Schwartz	(CDN 025822-25829)
	744	AES (PRESENTED AT THE 83rd CONVENTION 1987 OCTOBER 16-19 NEW YORK)	John Staunter Sriram Jayasimha	(CDN 025830-25836)

Examiner's Initials	TAB NO.	DESCRIPTION	AUTHOR	PUBLICATION
	745	AES (PRESENTED AT THE 84th CONVENTION 1988 MARCH 1-4 PARIS	J.P. Stautner	(CDN 025837-25854)
	746	THE DIGITAL AUDIO CARTRIDGE DISK RECORDER, REPRODUCER AND EDITOR FOR BROADCAST USE	David M. Schwartz	(CDN 025855-25866)
	747	TOWARDS ELECTRONIC DELIVERY OF MUSIC(1.0 INTRODUCTION	John P. Stautner	(CDN 025867-25873)
	748	ARCHITECTURE OF A REAL TIME DIGITAL FILTERBANK PROCESSOR FOR TEMPERED, AUDITORY, AND CRITICAL-BAND ANALYSIS/SYNTHESIS	Gary W. Schwede	(CDN 025874-25875)
	749	A FUNCTIONAL OVERVIEW OF THE COMPUSONICS DSP-2000 SERIES		(CDN 025876-25877)
	750	MUSICAL RECORDING, EDITING AND PRODUCTION USING THE COMPUSONICS DSP-2004	John P. Stautner	(CDN 025878-258790)
	751	STRATEGIES FOR THE REPRESENTATION AND DATA REDUCTION OF DIGITAL MUSIC SIGNALS (WORK PERFORMED AND METHODS EMPLOYED	John P. Stautner	June 20, 1984 (CDN 025880-25881)
	752	ANALYSIS AND SYNTHESIS OF MUSIC USING THE AUDITORY TRANSFORM	J. Stautner	Submitted to Dept. of Electrical Engineering and Computer Science, Massachusetts Institute of Technology

Examiner's Initials	TAB NO.	DESCRIPTION	AUTHOR	PUBLICATION
				May, 1983 CDN025895
	753	ALGORITHMS AND ARCHITECTURES FOR CONSTANT-Q FOURIER SPECTRUM ANALYSIS	G. Schwede	Dissertation submitted to University of California, Berkeley November 28, 1983 CDN026097
	754	Letter to Shareholders	D. Schwartz	CompuSonics CDN026261
	755	From the News Desk		Info World Newsweekly, June 4, 1984 Volume 6, Issue 23 CDN026263
	756	Manufacturing Update		International Audio Video, June 1984 CDN026264
	757	CompuSonics Pro Equipment & Services		Cover of Billboard Newspaper CDN026265
	758	CompuSonics Fuses Computer, Audio Into "World's First" Home Digital Recorder	M. Golden	CES Trade News Daily, p. 10 June 4, 1984 CDN026266
	759	Digital Sound Now On Computer Disks	S. Booth	Consumer Electronics Show Daily June 3, 1984 CDN026267
	760	CompuSonics Reads Floppy Disk to Record and Play Back Music		HFD - The Weekly Home Furnishings Newspaper June 4, 1984

Examiner's Initials	TAB NO.	DESCRIPTION	AUTHOR	PUBLICATION
	761	Technology Awards to CompuSonics		CDN026268 CDN026269
	762	CompuSonics DSP 1000 Digital Audio Disk Recorder Specifications		CompuSonics Corporation CDN026270
	763	CompuSonic Bows Totally Digital		Pro Sound News, New York, NY June 8, 1984
	764	Floppy Disks May Be the Next Music Makers		Business Week May 28, 1984 CDN026272
	765	Studio Design Special		Mix - The Recording Industry Magazine August 1984
	766	CompuSonics: Another Digital Audio Standard	N. Weinstock	Mix, Vol. 8, No. 8, p. 24 CDN026274
	767	CompuSonics: Another Digital Audio Standard	N. Weinstock	Mix, Vol. 8, No. 8, p. 26 CDN026275
	768	CompuSonics Readies Floppy Disk to Record and Play Back Music		HFD, Electronics, Section 1 June 4, 1984 CDN026276
	769	The State of RCA		TV Digest, p. 14 May 21, 1984 CDN026277
	770	Display - CompuSonics Photographs		CDN026278

Examiner's Initials	TAB NO.	DESCRIPTION	AUTHOR	PUBLICATION
	771	Display - CES Exhibition Design and Engineering 1984		CDN026280
	772	Specifications - CompuSonics DSP 1000 Digital Disk Recorder/Player		CompuSonics Corporation CDN026281
	773	Article - Watch Out Digital Discs: Here Comes Floppy Audio		Unknown
	774	Specifications - CompuSonics DSP 1000 Digital Disk Recorder/Player		CompuSonics Corporation
	775	Optical-Disk-Digital Audio System Premieres	B. Robinson	Electronic Engineering Times, Issue 397 September 1, 1986 CDN026284
	776	Specifications - CompuSonics DSP 1000 Digital Disk Recorder/Player		CompuSonics Corporation
	777	CompuSonics Business Plan Overview		June 14, 1984 CDN026286
	778	Cover - Fortune Magazine		November 12, 1984 CDN026289
	779	Advertisement - CompuSonics Corporate Profile	D. Schwartz	Audio Video International CDN026290
	780	Toward Electronic Delivery of Music: Sending and Receiving High Fidelity Digital Music	J. Staunter	CompuSonics Corporation CDN026291
	781	Company Sees Future in Digital Recorders	J. Hendon	Rocky Mountain News

Examiner's Initials	TAB NO.	DESCRIPTION	AUTHOR	PUBLICATION
				July 22, 1984
	782	Floppy-Disk Audio System	A. Mereson	Science Digest November, 1984 CDN026299
	783	Recording Music on Floppy Disks	A. Zuckerman	High Technology May 1986 CDN026300
	784	Article - Sound is Big at Consumer Show	L. Mortwaki	Seattle Washington Times June 8, 1984 CDN026301
	785	Digital Recording System Uses Floppy Disks		Audio Times, Vol. 26, No. 5 May, 1984 CDN026302
	786	CompuSonics Advertisement		CDN026304
	787	Advertisement - MicroPro's WordStar 2000		CDN026305
	788	Hi-Fi Floppy	K. Yates	PC World, Vol. 3, Issue 4 CDN026306
	789	The Digitization of Music	K. Yates	PC World, Vol. 3, Issue 4 CDN026308
	790	A Sonic Glossary	K. Yates	PC World, Vol. 3, Issue 4 CDN026311
	791	New Hi-Fi Horizons	D. Ranada	Stereo Review, December 1984 CDN026313

Examiner's Initials	TAB NO.	DESCRIPTION	AUTHOR	PUBLICATION
	792	Specifications and Implementation of a Computer Audio Console for Digital Mixing and Recording	D. Schwartz	AES 76th Convention, NYC June 20, 1984 CDN026317
	793	A High Speed Telecommunications Interface for Digital Audio Transmission and Reception	H. Sohn	Abstract CDN026319
	794	The Audio Computer and Its Applications	D. Schwartz; J. Stauber	CompuSonics Corporation CDN026332
	795	Engineering Your Own Digital Audio Broadcast System	D. Schwartz	CompuSonics Corporation CDN026343
	796	Tab - Pay 2 Tape '90		CDN026362
	797	Fax Cover Sheet to Michael Kapp from D. Schwartz	D. Schwartz	April 26, 1990 CDN026363
	798	Fax Memo to Michael Kapp from D. Schwartz	D. Schwartz	April 26, 1990
	799	Pay Per Listen Cable Audio System - Notes to Viewgraph Presentation	CompuSonics	CDN026365
	800	Pay Per Listen Cable Audio System - System Payback Analysis	CompuSonics	CDN026366
	801	Pay Per Listen Cable Audio System - Provide the In-Home Music Taper with a Wide Variety of Source Material	CompuSonics	CDN026367
		Pay Per Listen Cable Audio System -		

Examiner's Initials	TAB NO.	DESCRIPTION	AUTHOR	PUBLICATION
	802	Provide the In-Home Music Taper with a Wide Variety of Source Material	CompuSonics	CDN026368
	803	Pay Per Listen Cable Audio System - Audio Database Format Options	CompuSonics	CDN026374
	804	Pay Per Listen Cable Audio System - Billboard Top 100 LPS Format	CompuSonics	CDN026375
	805	Pay Per Listen Cable Audio System - Program Publication Options	CompuSonics	CDN026379
	806	Letter to Shareholder from D. Schwartz	D. Schwartz	November 21, 1984 CDN026381
	807	Letter to Shareholder from D. Schwartz	D. Schwartz	October 10, 1985 CDN026382
	808	Display Photograph		CDN026384
	809	Display Photograph		CDN026385
	810	CompuSonics DSP2002 Preliminary User Manual		CDN026386
	811	Display - Hardware Spec		CDN026387
	812	Internal Data		CDN026388
	813	DSP-1000 Series		CDN026389
	814	Digital Marketing Corporation Video Real Estate System		June 7, 1986 CDN026390

Examiner's Initials	TAB NO.	DESCRIPTION	AUTHOR	PUBLICATION
	815	Agenda for June 7, 1988 Meeting		CDN026393
	816	Agenda for May 31, 1988 Meeting	CompuSonics	CDN026394
	817	Advertisement - Digilist Video Multiple Listing Service	Digital Marketing Corporation	CDN026395
	818	Advertisement - Digilist Video Multiple Listing Service	Digital Marketing Corporation	CDN026396
	819	Advertisement - Digilist Video Multiple Listing Service	Digital Marketing Corporation	CDN026398
	820	Memo to B. Holmbraker, B. Alderfer, R. Dahl, H. Fong from D. Schwartz	D. Schwartz	CompuSonics Financial/Technical Status January 12, 1987 CDN026399
	821	Manual - Assembly Procedure for the DSP1500		CDN026401
	822	Specifications - CompuSonic DSP 1000		CDN026440
	823	DSP 1000 Digital Audio Disk Recorder Application Notes		CDN026489
	824	The Home Terminal		International Resource Development, pp. 149-158 August 1978 CDN026745

Examiner's Initials	TAB NO.	DESCRIPTION	AUTHOR	PUBLICATION
	825	ROLM PLUGS CBX INTO IBM WORLD		Electronic Mail & Message Systems Vol. 7, No. 9 May 2, 1983 CDN026768
	826	CONTROL VIDEO ENTERS DOWNLINE LOADING BUSINESS		Electronic Mail & Message Systems Vol. 7, No. 11 June 1, 1983 CDN026771
	827	EMMS Article		Electronic Mail & Message Systems Vol. 7, No. 14, p. 17 July 15, 1983 CDN026775
	828	THE OTHER HALF OF THE IBM PC		Electronic Mail & Message Systems Vol. 7, No. 16 August 15, 1983 CDN026776
	829	ELECTRONIC MESSAGE SYSTEMS AND THE HOME TERMINAL		Electronic Mail & Message Systems Vol. 3, No. 12 June 15, 1979 CDN026779
	830	EMMS Article		Electronic Mail & Message Systems Vol. 3, No. 15, p. 13 August 1, 1979 CDN026784
	831	EMMS Article		Electronic Mail & Message Systems Vol. 6, No. 11, p. 20

Examiner's Initials	TAB NO.	DESCRIPTION	AUTHOR	PUBLICATION
	832	EMMS Article		June 1, 1982 CDN026785
	833	EMMS Article		Electronic Mail & Message Systems Vol. 6, No. 15, p. 14 August 2, 1982 CDN026786
	834	FIBER-OPTICS WILL SHAKE THE UTILITIES		Electronic Mail & Message Systems Vol. 9, No. 20 November 1, 1985 CDN026792
	835	BRITISH TELECOM OFFERS FREE ELECTRONIC MAIL SERVICES		Electronic Mail & Message Systems Vol. 10, No. 7 April 1, 1986 CDN026797
	836	PROFIT PROTECTION - RISKY BUSINESS		Electronic Mail & Message Systems Vol. 12, No. 16 August 15, 1988 CDN026801
	837	EMMS Article		Electronic Mail & Message Systems Vol. 12, No. 21 November 1, 1988

Examiner's Initials	TAB NO.	DESCRIPTION	AUTHOR	PUBLICATION
	838	CompuSonics to Bow Digital Audio Floppy Disk Player/Recorder; CD Rival?	C. Kaplan	CDN026811 Consumer Electronics Daily, Vol. VIII, No. 5, Issue 8 May 10, 1984 CDN026255
	839	HOME TELECOMMUNICATIONS IN THE 1980's		International Resource Development, Inc. April 1980, Report 150 CDN026812
	840	THE FUTURE OF TELEVISION		International Resource Development, Inc. August 1981, Report 176 CDN026914
	841	HEALTH, WEALTH & SELF-IMPROVEMENT HOME SOFTWARE		International Resource Development, Inc. September 1985, Report 670 CDN026935
	842	TELECOMMUNICATIONS MARKET OPPORTUNITIES		International Resource Development, Inc. November 1985, Report 676 CDN026955
	843	TELEPAY VS. VIDEO DISC		International Resource Development, Inc. September 1982, Report 510 CDN027013
	844	VIDEO GAMES & ELECTRONIC TOYS		International Resource Development, Inc. May 1983, Report 550 CNDN027034
	845	DELIBERATELY LEFT BLANK		

Examiner's Initials	TAB NO.	DESCRIPTION	AUTHOR	PUBLICATION
	846	PAYMENTS RECEIVED FOR REPORT #558 DOWNLOADING AND TELEDELIVERY OF COMPUTER SOFTWARE, GAMES & MUSIC	Kenneth G. Bosomworth	January 9, 2001 CDN027138
	847	ARTICLE - COMPUSONICS/CARTS AT&T DEMO		Pro Sound News September 9, 1985 CDN027183
	848	INTENTIONALLY OMITTED DOCUMENTS CDN027190-CDN027734		3/13/01 Letter to N. Bigas from R. Gruwell 03/09/01 Letter M. Neblett from N. Bigas 03/05/01 Letter to M. Neblett from N. Bigas
	849	TRANSCRIPTION OF VIDEOTAPE		EE 380 - 2/18/87 - ALLISON 7 CDN027735
	850	THE DIGITAL AUDIO PROCESSING STATION: A NEW CONCEPT IN AUDIO POSTPRODUCTION	J. Moorer; C. Abbott; Peter Nye et al.	Journal of Audio Engineering Society, Vol. 34, No. 6, June, 1986, pp. 454-464 CDN027783
	851	ON DIGITAL I/O FORMAT	T. Doi	Sony Corporation Presented at AES Digital Audio Technical Committee, Hamburg, West Germany March 16, 1981 CDN027794
	852	PCM PROGRAM TRANSMISSION AND COMMUNICATION NETWORK FOR THE NORWEGIAN BROADCASTING	R. Andersen; K. Ronning	Journal of the Audio Engineering Society Volume 28, Number 4 April, 1980

Examiner's Initials	TAB NO.	DESCRIPTION	AUTHOR	PUBLICATION
		CORPORATION		
	853	A FIBRE OPTIC MULTI-CHANNEL COMMUNICATION LINK DEVELOPED FOR REMOTE INTERCONNECTION IN A DIGITAL AUDIO CONSOLE	P. Lidbetter S. Douglas	Presented at the 80th Convention, Audio Engineering Society Reprint (Preprint 2330 D6) March 4-7, 1986 CDN027830
	854	BBC DIGITAL AUDIO -- A DECADE OF ON-AIR OPERATION	D. Stripp	BBC, London, United Kingdom Collected Papers from the Audio Engineering Society Premiere Conference, Rye, New York June 3-6, 1982 CDN027846
	855	PROCESSING SYSTEMS FOR THE DIGITAL AUDIO STUDIO	M. Jones	Neve Electronics International Limited, Royston, Hertfordshire, United Kingdom Collected Papers from the Audio Engineering Society Premiere Conference, Rye, New York June 3-6, 1982 CDN027852
	856	LARGE SCALE ACOUSTICS	D. Hawkins	Studio Sound and Broadcast Engineering March, 1985
	857	BBC DIGITAL CONTROL VEHICLE 12 MONTHS ON	K. Spencer-Allen	Diary-Diary, Studio Sound, p. 32-33 November, 1986
	858	WDR NEVE DSP NOW IN USE		Diary-Diary, Studio Sound, p. 18 August, 1986

Examiner's Initials	TAB NO.	DESCRIPTION	AUTHOR	PUBLICATION
	859	DIGITAL MASTERING TAPE ONE		Studio Sound, pp. 36, 38, 40 August, 1986
	860	DIGITAL SOUND SIGNALS: THE PRESENT BBC DISTRIBUTION SYSTEM AND A PROPOSAL FOR BIT- RATE REDUCTION BY DIGITAL COMPANDING	M. Croll; D. Osborne; C. Spicer	International Broadcasting Convention September 23-27, 1974
	861	AUDIO ENGINEERING HANDBOOK	K. Benson	AUDIO ENGINEERING HANDBOOK All-Digital Studio, pp. 4.37 - 4.38 Transmission Systems, pp. 4.57 Stereo with Television, p. 4.59 © 1988 CDN027884
	862	HANDBOOK OF RECORDING ENGINEERING	J. Eargle	The All-Digital Studio, pp. 373-375 © 1986 CDN027892
	863	ROUTING OF DIGITAL AUDIO SIGNALS IN A RADIO BROADCASTING CENTRE	N. Gilchrist; G. Crowe G. Legg	Eleventh International Broadcasting Convention September 19-23, 1986 CDN027897
	864	SIGNAL ROUTING IN A DIGITAL SOUND STUDIO	G. Roe; C. Caine	Eleventh International Broadcasting Convention September 19-23, 1986 CDN027902
	865	MULTI-PURPOSE RADIO LINKS	P. Marchant;	International Broadcasting Convention September 18-21, 1982

Examiner's Initials	TAB NO.	DESCRIPTION	AUTHOR	PUBLICATION
		SYSTEM FOR NEWS COVERAGE	I. Buffham	CDN027907
	866	DOCAT - DIGITAL, OPTICAL CATV TRUNK SYSTEM	G. Mogensen; B. Petersen; H. Steffensen	International Broadcasting Convention September 18-21, 1982 CDN027913
	867	DIGITAL TRANSMISSION SYSTEM FOR TELEVISION, SOUND AND ASSOCIATED DATA	A. Jones; D. Kitson	Tenth International Broadcasting Convention September 21-25, 1984 CDN027918
	868	DIGITAL SOUND MIXING IN THE ANALOGUE STUDIO	M. Jones; D. Langford; D. Tilsley	Tenth International Broadcasting Convention September 21-25, 1984 CDN027923
	869	DIGITAL SPEECH NETWORKS	B. Gold	Proceedings of the IEEE, Vol. 65, No. 12 December, 1977 CDN027939
	870	THE DIGITAL CODING OF HIGH-QUALITY MUSICAL SOUND	J. Moorer	Journal of the Audio Engineering Society Vol. 27, No. 9, pp. 657-666 September, 1979 CDN027962
	TAB	PATENT NO.	INVENTOR	FILING DATE
	871	Japanese Patent No. 62-284496		December 12, 1987
	872	3,602,891	Clark et al.	March 10, 1969

Examiner's Initials	TAB NO.	DESCRIPTION	AUTHOR	PUBLICATION
	TABS	TITLE	AUTHOR	SOURCE
	873	DIGITAL AUDIO FOR CABLE TELEVISION	C. Robbins	1986 NCTA Technical Papers, pp. 21-24 CDN028131
	874	SPEECH UNDERSTANDING SYSTEMS	Massachusetts Inst. of Technology, Lincoln Lab.	U.S. Department of Commerce, National Technical Information Service May 31, 1973 CDN028138
	875	SPEECH UNDERSTANDING SYSTEMS	Massachusetts Inst. of Technology, Lincoln Lab.	U.S. Department of Commerce, National Technical Information Service January 15, 1974 CDN028166
	876	INFORMATION PROCESSING TECHNIQUES PROGRAM, VOLUME I. PACKET SPEECH/ACOUSTIC CONVOLVERS	Massachusetts Inst. of Technology, Lincoln Lab.	U.S. Department of Commerce, National Technical Information Service June 30, 1976 CDN028198
	TAB	PATENT NO.	INVENTOR	FILING DATE
	877	Japanese Laid Open Kokai Patent Application 62-284496	Hisanobu Akashi	June 3, 1986
	TABS	TITLE	AUTHOR	SOURCE
	878	SPEECH ANALYSIS SYNTHESIS AND PERCEPTION	J. Flanagan	Bell Laboratories Channel Vocoders, pp. 323-405 CDN028247
	879	DIGITIZATION OF AUDIO: A	B. Blesser	Journal of the Audio Engineering Society

Examiner's Initials	TAB NO.	DESCRIPTION	AUTHOR	PUBLICATION
	880	COMPREHENSIVE EXAMINATION OF THEORY, IMPLEMENTATION AND CURRENT PRACTICE	C. Yavelow	Volume 26, Number 10 October, 1978 CDN028268
	881	PERSONAL COMPUTERS AND MUSIC: THE STATE OF THE ART	B. Moog	Journal of the Audio Engineering Society Volume 35, No. 3 March, 1987 CDN028301
	882	MIDI: MUSICAL INSTRUMENT DIGITAL INTERFACE	J. Moorer	Journal of the Audio Engineering Society Volume 34, No. 5 May, 1986 CDN028325
	883	HOW DOES A COMPUTER MAKE MUSIC?	P. Craven M. Gerzon	Computer Music Journal, Volume II, Number 1 pp. 32-37 CDN028357
	884	LOSSLESS CODING FOR AUDIO DISCS	C. Todd; G. Davidson; M. Davis, et al.	Journal of the Audio Engineering Society Volume 44, No. 9 September, 1996 CDN028342
	885	AC-3: FLEXIBLE PERCEPTUAL CODING FOR AUDIO TRANSMISSION AND STORAGE		Paper presented at the 96th Convention of the Audio Engineering Society, February 26-March 1, 1994 Dolby Laboratories, San Francisco CDN028365
		MASTERLINE SOFTWARE BY PHONE		APPLE II USER'S MANUAL

Examiner's Initials	TAB NO.	DESCRIPTION	AUTHOR	PUBLICATION
				KH000015
	886	MASTERLINE SOFTWARE BY PHONE		COMMODORE 64 USER'S MANUAL KH000017
	887	MASTERLINE SOFTWARE BY PHONE		COMMODORE SOFTWARE EDITION FOR THE BELLSOUTH MASTER MODULE KH000028
	888	ELECTRONIC GAMES MAGAZINE		June 1983 KH000055
	889	GAMELINER MAGAZINE		October 1983 KH0000181
	890	MASTERLINE SOFTWARE BY PHONE, ISSUE TWO		APPLE SOFTWARE EDITION FOR THE BELLSOUTH MASTER MODULE KH0000209
	891	ELECTRONIC GAMES MAGAZINE		October, 1983 KH0000245
	892	APPLE II REFERENCE MANUAL		N2K04850
	893	VAX/VMS ACCOUNTING UTILITY REFERENCE MANUAL		September, 1984 N2K05242
	894			
	895	U.S. Patent 4,654,799 to Ogaki		March 31, 1987
	896	U.S. Patent 5,191,193 to Le Roux		March 2, 1993

Examiner's Initials	TAB NO.	DESCRIPTION	AUTHOR	PUBLICATION
	897			



08/19/05

Practitioner's Docket No. HAIR-1 CONT

PATENT

IN THE UNITED STATES PATENT AND TRADEMARK OFFICE

U.S. Patent No. 5,191,573
In re application of: Hair, Arthur R.
Reexamination Control No.: 90/007,402
Reexamination Filed: January 31, 2005
For: TRANSMISSION SYSTEM

Group No.: 2132
Examiner: Benjamin E. Lanier

Mail Stop Ex Parte Reexamination
Commissioner for Patents
P.O. Box 1450
Alexandria, VA 22313-1450

TRANSMITTAL OF INFORMATION DISCLOSURE STATEMENT
BEFORE MAILING DATE OF EITHER A FINAL ACTION
OR NOTICE OF ALLOWANCE (37 C.F.R. § 1.97(c))

TIME OF TRANSMITTAL OF ACCOMPANYING
INFORMATION DISCLOSURE STATEMENT

- 1. The information disclosure statement transmitted herewith is being filed after three months of the filing date of this national application or the date of entry of the national stage as set forth in Section 1.491 in an international application or after the mailing date of the first Office action on the merits, whichever event occurred last but before the mailing date of either
(1) a final action under § 1.113 or
(2) a notice of allowance under § 1.311

CERTIFICATION UNDER 37 C.F.R. §§ 1.8(a) and 1.10*
(When using Express Mail, the Express Mail label number is mandatory;
Express Mail certification is optional.)

I hereby certify that, on the date shown below, this correspondence is being:

MAILING

X deposited with the United States Postal Service in an envelope addressed to the Commissioner for Patents, P.O. Box 1450, Alexandria, VA 22313-1450.

37 C.F.R. § 1.8(a)
with sufficient postage as first class mail.

37 C.F.R. § 1.10*
X as "Express Mail Post Office to Addressee"
Mailing Label No. EL700964471US (mandatory)

TRANSMISSION

facsimile transmitted to the Patent and Trademark Office, (703)

Signature
Tracey L. Klaas

Date: 8/18/05

Tracey L. Klaas
(type or print name of person certifying)

* Only the date of filing (§ 1.6) will be the date used in a patent term adjustment calculation, although the date on any certificate of mailing or transmission under § 1.8 continues to be taken into account in determining timeliness. See § 1.703(f). Consider "Express Mail Post Office to Addressee" (§ 1.10) or facsimile transmission (§ 1.6(d)) for the reply to be accorded the earliest possible filing date for patent term adjustment calculations.

(2) a notice of allowance under § 1.311

whichever occurs first.

FEE

2. Accompanying this transmittal is the fee for submission of an information disclosure statement under section 1.97(c). (\$180.00)

FEE PAYMENT

3. Applicant elects the option to pay the fee set forth in 37 C.F.R. § 1.17(p) for submission of an information disclosure statement under § 1.97(c) (\$180.00).

Fee due \$180.00

METHOD OF PAYMENT OF FEE

4. Attached is a check in the amount of \$180.00.

A duplicate of this paper is attached.

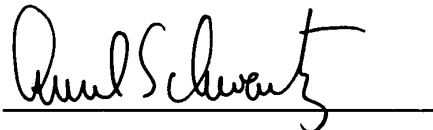

Ansel M. Schwartz
Registration No. 30,587
Attorney at Law
201 N. Craig Street
Suite 304
Pittsburgh, PA 15213
412-621-9222



08/19/05

Practitioner's Docket No. HAIR-1 CONT

PATENT

IN THE UNITED STATES PATENT AND TRADEMARK OFFICE

U.S. Patent No. 5,191,573
In re application of: Hair, Arthur R.
Reexamination Control No.: 90/007,402
Reexamination Filed: January 31, 2005
For: TRANSMISSION SYSTEM

Group No.: 2132
Examiner: Benjamin E. Lanier

Mail Stop Ex Parte Reexamination
Commissioner for Patents
P.O. Box 1450
Alexandria, VA 22313-1450

TRANSMITTAL OF INFORMATION DISCLOSURE STATEMENT
BEFORE MAILING DATE OF EITHER A FINAL ACTION
OR NOTICE OF ALLOWANCE (37 C.F.R. § 1.97(c))

TIME OF TRANSMITTAL OF ACCOMPANYING
INFORMATION DISCLOSURE STATEMENT

- 1. The information disclosure statement transmitted herewith is being filed after three months of the filing date of this national application or the date of entry of the national stage as set forth in Section 1.491 in an international application or after the mailing date of the first Office action on the merits, whichever event occurred last but before the mailing date of either
(1) a final action under § 1.113 or
(2) a notice of allowance under § 1.311

CERTIFICATION UNDER 37 C.F.R. §§ 1.8(a) and 1.10*
(When using Express Mail, the Express Mail label number is mandatory;
Express Mail certification is optional.)

I hereby certify that, on the date shown below, this correspondence is being:

MAILING

X deposited with the United States Postal Service in an envelope addressed to the Commissioner for Patents, P.O. Box 1450, Alexandria, VA 22313-1450.

37 C.F.R. § 1.8(a)
with sufficient postage as first class mail.

37 C.F.R. § 1.10*
X as "Express Mail Post Office to Addressee"
Mailing Label No. EL700964471US (mandatory)

TRANSMISSION

facsimile transmitted to the Patent and Trademark Office, (703)

Signature
Tracy L. Klaas

Date: 8/18/05

Tracy L. Klaas
(type or print name of person certifying)

* Only the date of filing (§ 1.6) will be the date used in a patent term adjustment calculation, although the date on any certificate of mailing or transmission under § 1.8 continues to be taken into account in determining timeliness. See § 1.703(f). Consider "Express Mail Post Office to Addressee" (§ 1.10) or facsimile transmission (§ 1.6(d)) for the reply to be accorded the earliest possible filing date for patent term adjustment calculations.

(2) a notice of allowance under § 1.311

whichever occurs first.

FEE

2. Accompanying this transmittal is the fee for submission of an information disclosure statement under section 1.97(c). (\$180.00)

FEE PAYMENT

3. Applicant elects the option to pay the fee set forth in 37 C.F.R. § 1.17(p) for submission of an information disclosure statement under § 1.97(c) (\$180.00).

Fee due \$180.00

METHOD OF PAYMENT OF FEE

4. Attached is a check in the amount of \$180.00.

A duplicate of this paper is attached.

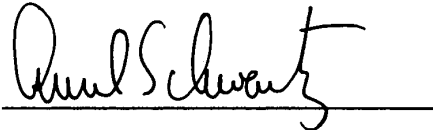

Ansel M. Schwartz
Registration No. 30,587
Attorney at Law
201 N. Craig Street
Suite 304
Pittsburgh, PA 15213
412-621-9222

ATTACHMENT A

Secondary Considerations of Patentability Evidence

66155 U.S. PTO



08/19/05

IN THE UNITED STATES DISTRICT COURT
FOR THE WESTERN DISTRICT OF PENNSYLVANIA

SIGHTSOUND.COM INCORPORATED,)

Plaintiff,)

-vs-)

Civil Action No. 98-0118

N2K, INC., CDNOW, INC., and CDNOW ONLINE,)
INC.,)

Defendant.)

AMBROSE, Chief District Judge.

ORDER OF COURT

And now, this 23rd day of October, 2003, after careful consideration and for the reasons set forth in the Opinion accompanying this Order, it is ordered that the Motion for Summary Judgment by Defendants N2K, Inc., CDNow, Inc., and CDNowOnline, Inc. (Docket No. 159), is denied.

It is further ordered that Plaintiff's Motion for Summary Judgment (Docket No. 156) is granted in its entirety and that all affirmative defenses and counterclaims relating to inequitable conduct raised by N2K, Inc., CDNow, Inc., and CDNowOnline, Inc., are dismissed with prejudice.

A Pre-Trial/Settlement Conference will be held on Wednesday, November 12,

the cited cases, despite not having a clear idea of how Defendants' single-sentence argument relates to them, and find that all three concentrate on commercial success, only one of many secondary considerations which may be offered by a patentee. See Cable Electric, id. at 1027, holding that for commercial success to have "true relevance" to the question of nonobviousness, that success must be shown to be due to the nature of the patented subject matter, rather than to economic and commercial factors unrelated to the technical quality of the patented subject matter; Sjolund, id. at 1582, concluding that evidence of commercial success was irrelevant because the aspect of the invention to which its success was attributed was not part of the claimed invention. Windsurfing Int'l, which also discusses commercial success, focuses on the weight a district court may properly give to secondary considerations, concluding that the weight should correlate to the objective evidence provided to support them. 782 F.2d at 1000.

Here, I have noted Plaintiff's arguments that at the time the Sightsound Patents were issued, there were numerous examples of secondary considerations: copying, skepticism on the part of those skilled in the art as to the viability of such a system, long-felt but unsatisfied needs, and unsuccessful attempts by others to solve the problem underlying the claimed invention. Given nothing substantive from Defendants in their Reply Brief to refute these claims, I accept them as presented by Plaintiff for purposes of deciding this summary judgment motion.

5. Conclusion:

Conflicts in the evidence on factual issues are not to be resolved on summary

IN THE UNITED STATES DISTRICT COURT
FOR THE WESTERN DISTRICT OF PENNSYLVANIA

<hr/>)	
Sightsound.com Incorporated,)	
)	
	Plaintiff,)	
v.)	Civil Action No.: 98-0118
)	
N2K, Inc., CDnow, Inc., and)	
CDnow Online, Inc.,)	
)	
	Defendants.)	
<hr/>)	

REBUTTAL EXPERT REPORT OF JUSTIN DOUGLAS TYGAR, PH.D.

K. Indicia of Non-Obviousness

Each of the systems described by Dr. Moorer and Dr. Shamos missed a critical ingredient, so none of them ever survived as a consumer-oriented mass-market distribution system for digital music distribution. The only system that has all the magic ingredients is the one disclosed and claimed by the patents in this case. Its embodiments offered consumers a way to integrate their home computers to purchase, download, and play digital music using a single device – their personal computer. It also offered the content distributors a combination that allows it to ensure that digital music and video files are easily pirated.

CONCLUSION

I conclude that the “electronically coding” step in claims 1 and 2 of the ‘734 patent and claims 6 and 8 of the ‘440 patent is enabled by the specification of the ‘734 and ‘440 patents. I also conclude that none of the prior art cited by the Shamos and Moorer reports anticipates or renders obvious any of the asserted claims.

④

EXHIBIT P

IN THE UNITED STATES DISTRICT COURT
FOR THE WESTERN DISTRICT OF PENNSYLVANIA

Sightsound.com Inc.,

Plaintiff,

v.

N2K, Inc., CDnow, Inc., and
CDnow Online, Inc.,

Defendants.

CIVIL ACTION

98-0118

Judge Ambrose

DECLARATION OF CLYDE E. FINDLEY

1. My name is Clyde E. Findley. I am an attorney in the law firm of Kenyon & Kenyon, 1500 K Street, NW, Washington, D.C., 20005.

2. On May 8, 2003, I visited the website available at the following URL:
<http://www.microsoft.com/windows/windowsmedia/wm7/drm/architecture.aspx>. The pages attached at Tab 1 are true and correct copies of the web pages available at that website.

3. On May 8, 2003, I visited the website available at the following URL:
<http://www.pressplay.com/theservice.html>. The pages attached at Tab 2 are true and correct copies of the web pages available at that website.

4. On May 8, 2003, I visited the website available at the following URL:
<http://www.pressplay.com/faq.html>. The pages attached at Tab 3 are true and correct copies of the web pages available at that website.

5. On May 8, 2003, I visited the website available at the following URL:
<http://www.apple.com/music/store/>. The pages attached at Tab 4 are true and correct copies
of the web pages available at that website.

6. On May 8, 2003, I visited the website available at the following URL:
http://www.listen.com/rhap_about.jsp?sect=catalogs. The pages attached at Tab 5 are true
and correct copies of the web pages available at that website.

7. On May 8, 2003, I visited the website available at the following URL:
http://www.listen.com/rhap_about.jsp?sect=feat. The pages attached at Tab 6 are true and
correct copies of the web pages available at that website.

I declare under penalty of perjury under the laws of the United States of America that
the foregoing is true and correct.

Dated:

May 8, 2003

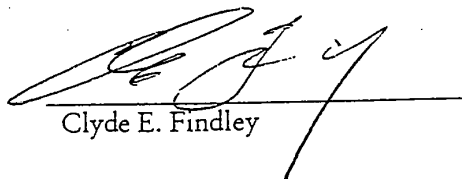
Clyde E. Findley

THIS PAGE BLANK (USPTO)



Windows Media Home | Windows Media Worldwide

Search for:

WINDOWS MEDIA HOME

DOWNLOADS

- TECHNOLOGIES & TOOLS
- Overview of Windows Media
- Consumer Electronics
- Digital Rights Management

- What is DRM?
- Why is DRM Important?
- How to Deploy DRM
- DRM Architecture
- Licensing Information
- System Requirements
- Authorized Codecs
- Partners & Providers
- Freemove Software
- Tutorials

- Encoder
- Format
- Microsoft Producer
- Players
- SDK
- Server
- Codecs

- COOL STUFF
- DEMOS
- HOW-TO

GET DOWN TO BUSINESS

PRESS

COMMUNITY



Architecture of Windows Media Rights Manager

When a consumer acquires an encrypted media file from a Web site, he or she must also acquire a license that contains a key to unlock the file before the content can be played. Content owners can easily set these licenses and keys in motion by protecting their content files with Microsoft® Windows Media® Rights Manager and then distributing the content to consumers.

The following illustration shows how content is protected, distributed, and used with Windows Media Rights Manager:



Windows Media Rights Manager Flow

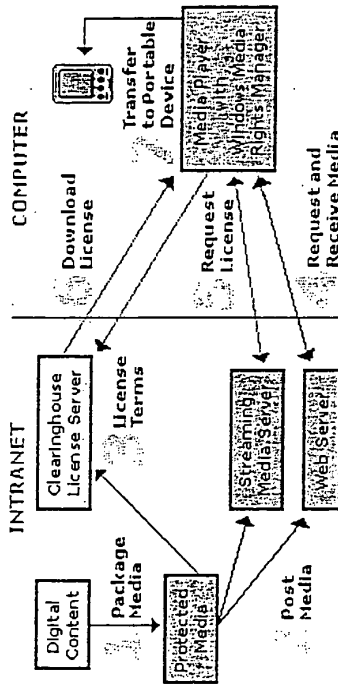

This diagram can be explained in terms of:

[How Windows Media Rights Manager Works Licenses and keys](#)

[▲ Back to the top](#)

How Windows Media Rights Manager Works

Windows Media Rights Manager lets content providers deliver songs, videos, and other digital media content over the Internet in a protected, encrypted file format. Windows Media Rights Manager helps protect digital media (such as songs and videos) by packaging digital media files. A packaged media file contains a version of a media file that has been encrypted and locked with a "key." This packaged file is also bundled with additional information from the content provider. The result is a packaged media file that can only be played by a person who has obtained a license.

<http://www.microsoft.com/windows/windowsmedia/wm7/drm/architecture.aspx>

The basic Windows Media Rights Manager process is as follows:

- 1. Packaging**
Windows Media Rights Manager packages the digital media file. The packaged media file has been encrypted and locked with a "key." This key is stored in an encrypted license, which is distributed separately. Other information is added to the media file, such as the URL where the license can be acquired. This packaged digital media file is saved in Windows Media Audio format (with a .wma file name extension) or Windows Media Video format (with a .wmv file name extension).
- 2. Distribution**
The packaged file can be placed on a Web site for download, placed on a media server for streaming, distributed on a CD, or e-mailed to consumers. Windows Media Rights Manager permits consumers to send copy-protected digital media files to their friends, as well.
- 3. Establishing a License Server**
The content provider chooses a license clearing house that stores the specific rights or rules of the license and implements the Windows Media Rights Manager license services. The role of the clearing house is to authenticate the consumer's request for a license. Digital media files and licenses are distributed and stored separately, making it easier to manage the entire system.
- 4. License Acquisition**
To play a packaged digital media file, the consumer must first acquire a license key to unlock the file. The process of acquiring a license begins automatically when the consumer attempts to acquire the protected content, acquires a predefined license, or plays the file for the first time. Windows Media Rights Manager either sends the consumer to a registration page where information is requested or payment is required, or "silently" retrieves a license from a clearing house.
- 5. Playing the Media File**
To play the digital media file, the consumer needs a media player that supports Windows Media Rights Manager. The consumer can then play the digital media file according to the rules or rights that are included in the license. Licenses can have different rights, such as start times and dates, duration, and counted operations. For instance, default rights may allow the consumer to play the digital media file on a specific computer and copy the file to a portable device. Licenses, however, are not transferable. If a consumer sends a packaged digital media file to a friend, this friend must acquire his or her own license to play the file. This PC-by-PC licensing scheme ensures that the packaged digital media file can only be played by the computer that has been granted the license key for that file.

[▲ Back to the top](#)

License and Keys

How Keys Work

The content owner locks their content with a "key" to create a packaged file. Before the consumer can play the file, the license clearing house creates a license containing the key that can unlock the packaged file and download the license to the consumers PC. The following diagram shows how keys are created and used in Windows Media Rights Manager.

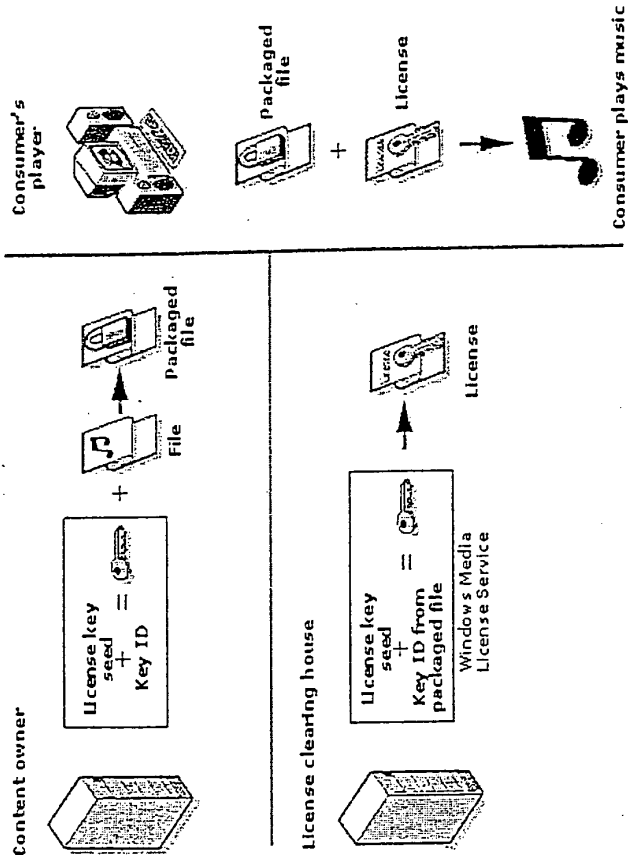

To generate a key, a license key seed and a key ID are needed:

- The license key seed is a value that is known only to the content owner and license clearing house.
- The key ID is created by the content owner for each Windows Media file. This value is included in the packaged file.

When the license clearing house needs to issue a license for a packaged file, a key can be recreated by retrieving the key ID from the packaged file. The Windows Media License Service uses the license key seed (which the clearing house provides) and the key ID from the packaged file to create a key. The key is included in the license sent to the consumer's computer. Using the key included in the license, the player on the consumer's computer can open and play the protected file.

[▲ Back to the top](#)

How Licenses Work

Each license contains the key to unlock the Windows Media file. The license also contains the rights, or rules, that govern the use of the digital media file. The content owner sets these rights to determine which actions are allowed from minimal control over playback to more restrictive licenses. The licenses in Windows Media Rights Manager can support a wide range of different business rules, including:

- How many times can a file be played.

Right navigation

- Which devices a file can be played or transferred on. For example, rights can specify if consumers can transfer the file to portable devices that are compliant with the Secure Digital Music Initiative (SDMI).
- When the user can start playing the file and what is the expiration date.
- If the file can be transferred to a CD recorder (burner).
- If the user can back up and restore the license.
- What security level is required on the client to play the Windows Media file.
- And many others.

Licenses can be delivered in different ways and at different times, depending on the business model. The content owner might want licenses pre-delivered, or they might want the license delivered after a consumer has downloaded and attempted to play a packaged file for the first time. Licenses can be delivered with or without the consumer being aware of the process using silent or non-silent license delivery.

▲ [Back to the top](#)

Support | Windows Media Newsletter



© 2003 Microsoft Corporation. All rights reserved. Terms of use | Privacy Statement | Security | Accessibility

THIS PAGE BLANK (USPTO)

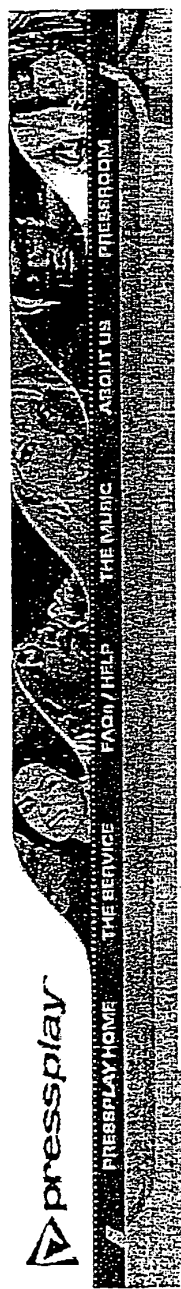

the service

pressplay offers a number of service plans so that you can choose the plan which is right for you.

<p>UNLIMITED</p>	<p>UNLIMITED PLUS</p>	<p>ANNUAL PLUS</p>	<p>3 day free trial Unlimited Streams Unlimited Downloads TRY IT NOW</p>
<p>\$9.95 per month Unlimited Streaming Unlimited Downloads</p>	<p>\$17.95 per month Unlimited Streaming Unlimited Downloads 10 Portable Downloads per month</p>	<p>\$179.40 per year - a \$14.95/month value Unlimited Streaming Unlimited Downloads 120 Portable Downloads on Day 1 of Membership</p>	<p>CLICK HERE</p>

All tiers of service offer the ability to buy as many extra packs of 5, 10, or 20 Portable Downloads as you would like. Portable Download packs are available for \$5.95 for the 5-pack; \$9.95 for the 10-pack and \$18.95 for the 20-pack.

Service Notes: Unlimited streaming and downloading is available on all tiers of the pressplay service. Portable Downloads may be kept after your membership is cancelled, transferred to compatible portable music devices; and burned to a CD or copied to a Net MD™ device. Most portable music devices on the market are compatible with pressplay. [Click here](#) for a complete list of compatible devices. For more details about our service plans, please review our [Terms and Conditions](#).

[Terms and Conditions](#) [Privacy Policy](#)
©2001-2002 pressplay

THIS PAGE BLANK (USPTO)



frequently asked questions

Top Ten FAQs

- [General](#)
- [Help for pressplay Members](#)
- [Registration and Installation](#)
- [Subscription Management and Policies](#)
- [Finding Music and Content](#)
- [Streams](#)
- [Downloads](#)
- [Portable Downloads](#)
- [Community Features](#)

FAQs are frequently asked questions about the pressplay policies and service. These FAQs apply to both the standalone pressplay application and pressplay for Windows Media Player 9 Series. Where the steps differ, the following icons are used to help distinguish the difference:

 CLIENT ONLY

This icon refers to steps or answers that are specific to the pressplay client application.

 FOR WINDOWS MEDIA PLAYER

This icon refers to steps or answers that are specific to pressplay for Windows Media Player 9 Series.

 HELP

1. What is pressplay?
2. What is pressplay for Windows Media Player 9 Series?
3. What are the minimum system requirements to use pressplay?
4. How does the free trial work?
5. Is my credit card information safe?
6. Is there a minimum time commitment to sign up for the service?
7. How do I contact pressplay Customer Care?
8. I forgot my password or member name. What do I do?
9. What is a Portable Download?
10. What labels are represented in the pressplay service?

GENERAL

- What is pressplay?
- What's new in pressplay 2.5?
- What is pressplay for Windows Media Player 9 Series?
- What is Gateway Music Vault by pressplay?
- How does the free trial work?
- What is the Member Get Member promotion?
- What is a stream?
- What is a download?
- What is a Portable Download?
- What is a portable device transfer?

- What is a Sony Net MD™?
- What is a burn?
- Can I block *pressplay* tracks with explicit content?
- Where can I find information about the *pressplay* Privacy Policy?
- Is *pressplay* available outside the United States?
- What are the benefits of upgrading to Windows Media Player 9 Series?
- How do I contact Windows Media Player Series 9 Customer Support?
- Which music labels are represented in the *pressplay* service?
- I lost *pressplay* from my computer, or want to get it on another computer, how can I download and install the *pressplay* software? Can I access my *pressplay* service from another location, such as work, home, or even on the road?
- How do I queue up tracks so they start playing after the ones that are currently playing finish?
- How do I access *pressplay* Help?
- Helping with *pressplay* playback issues**
- How do I contact *pressplay* Customer Care
- I am not able to sign in to *pressplay*. What do I do?
- I forgot my password or member name. What do I do?
- Can I copy my downloaded tracks to another computer?
- I lost my *pressplay* downloads. How do I get them back?
- Helping with *pressplay* playback issues**
- Minimum System Requirements
- What are the minimum system requirements to use *pressplay*?
- How do I download and install the *pressplay* software?
- How do I get the Windows Media Player?
- Registration**
- What credit cards can I use to purchase a *pressplay* membership?
- Is my credit card information safe?
- What names can I use for my member name?
- Is there a minimum time commitment to sign up for the *pressplay* service?
- Do I have to sign up for the *pressplay* service through an affiliate?
- If I am signed up for *pressplay* through Windows Media Player 9 Series, can I also listen to my *pressplay* account through the standalone *pressplay* application?
- Will removing the *pressplay* service from Windows Media Player 9 Series, cancel my membership?
- How do I get *pressplay* back if I accidentally removed it from Windows Media Player 9 Series?
- Installation technical questions**
- Will *pressplay* work if I am behind a firewall?
- How do I get updates for *pressplay* software?
- How do I launch *pressplay*?
- Helping with *pressplay* playback issues**
- If I cancel, do I get to keep my downloads and/or Portable Downloads?
- Can I share my *pressplay* membership with others?
- Can I access my existing *pressplay* membership through Windows Media Player 9 Series?
- How do I cancel my *pressplay* membership?
- How can I reactivate a previously canceled membership?
- I used up all the Portable Downloads in my membership plan before my membership period was over-Is there a way I can get more Portable Downloads?
- Helping with *pressplay* playback issues**
- What is the basis for the recommendations in the recommendation engine?
- How can I browse through recent or past hits from the Billboard Charts?
- How can I find out what music has recently been added to *pressplay*?
- How can I find out more information about an artist or album?
- What is radio *pressplay*?
- Can I skip tracks on radio *pressplay* or view what's in the queue?

How does the "Build Your Own Station" feature work and how are the tracks selected?

What's New

What file format and bitrate are the streaming tracks?
Do I have to be online to stream a track?
How do I play an entire album?

FAQs

What file format and bitrate are the download tracks?
How does the quality of a download track compare to a streaming track or CD?
Can I stream tracks or use other applications while I am downloading?
Can I copy my downloaded tracks to another computer?
If my hard drive fails or I get a new computer, how can I regain access to my downloads?
Do I have to be online to play a downloaded track?
Can I make a download permanent so it never expires?

How to Use

Can I purchase my downloads outright so I can play them after I am a *pressplay* member?
What is a Portable Download pack?
How do I purchase a Portable Download pack?
Can I burn and transfer an entire album?
Which CD Burners are supported by the Roxio CD burning software?
Which portable music players are supported by *pressplay*?
How do I transfer Portable Downloads to a portable device using the *pressplay* application?
Which tracks can I copy to a Net MD™ device?
How many times can I burn or copy the same Portable Download?
If I do not use up my Portable Download credits, do they carry over into the next billing period?
Can I use my player or another application to burn *pressplay* tracks?
Which tracks am I allowed to burn to CD?
How do I get the Roxio Basic CD Label Creator?
Who can I contact if I am having issues with my portable music player?

Accounting

What is the *pressplay* Message Board?
How do I create or edit my Public Profile?
How can I see what other members are listening to?
How do I make it so my member name does not appear under Now Streaming?
How can I view other members' collections?

Legal

What is *pressplay*?
pressplay is the premier on-demand music service that will change the way you discover music. For a low monthly fee, you can search, browse, and instantly listen (via streaming) to an unlimited number of full-length songs of your choice from your favorite artists while you are connected to the Internet. The *pressplay* service also lets you download an unlimited number of high quality music files to your computer, and play them as much as you want as long as your membership is active. In addition, you can make your own compilations, or playlists, and you can even burn your favorite tracks to a CD or transfer them to portable devices.

What's new in *pressplay* 2.5?

Here are some of the major new features included with version 2.5:

- **Custom Radio** - let *pressplay* build your own personalized radio stations based on your listening preferences.
- **The Mix** - build your own compilations based on professionally programmed playlists. You can burn these custom mixes and even print customized CD inserts and labels for your CD.
- **Billboard Charts** - peruse the top hits of today or seasons past.

<http://www.pressplay.com/faq.html>

- **Member Get Member** - share *pressplay* with your friends and family and get rewarded! Not only will you receive 10 free Portable Downloads if your referral signs up for *pressplay*, but so will they!
- **30-Second Clips** - for tracks that are Portable Download only, we are providing 30-second clips to let you preview the tracks before burning or transferring.

pressplay version 2.5 also contains many usability and performance enhancements, as well as some behind-the-scene changes that will enable us to bring you some exciting new features in the future. Stay tuned!

What is *pressplay* for Windows Media Player 9 Series?
pressplay for Windows Media Player 9 Series lets you experience *pressplay* through the 9 Series player interface. All the benefits available from the standalone *pressplay* application are now conveniently available as a service through the 9 Series player, including unlimited streaming and downloading, and the option to purchase your *pressplay* tracks as Portable Downloads that are yours to keep. You can copy and transfer your Portable Downloads using the 9 Series player and can also merge your *pressplay* collection with your other digital media so you collect and listen to your music all in one place.

What is Gateway Music Vault by *pressplay*?
Gateway Music Vault by *pressplay* is an innovative partnership between *pressplay* and Gateway that lets you purchase a Gateway PC pre-loaded with the *pressplay* service. In addition to the *pressplay* service pre-loaded on the PC, certain models will come pre-loaded with up to 2,000 songs in conjunction with a special introductory offer.

How does the free trial work?
When you sign up for any *pressplay* plan, you receive a 3-day free trial that consists of unlimited streams and downloads. If at any point during these 3 days you decide to cancel, your *pressplay* membership will end and your credit card will not be billed. At the end of the 3-day trial, the plan you selected at registration will begin and your credit card will be charged. You will have access to the tracks you downloaded during your free trial for as long as you are an active subscriber.

What is the Member Get Member promotion?
The Member Get Member program provides a convenient way to refer friends and family to *pressplay* and also get rewarded at the same time! For each person that becomes a paid member from your referral, you will receive 10 free Portable Downloads. In addition, if your friend signs up by your Member Get Member referral, they will also receive 10 free Portable Downloads. Look for Member Get Member promotional links on the HOME page and other locations throughout *pressplay*.

What is a stream?
Streaming means you can listen on-demand while you are connected to the Internet, without having to download the track to your hard drive. Streaming is like playing a song on the radio, except with *pressplay* you can choose what you want to hear and when you want to hear it. *pressplay* streams are on-demand with the freedom to pause, rewind, or skip ahead. All tiers of the *pressplay* service offer unlimited streaming of commercial-free tracks from the *pressplay* library.

What is a download?
A download is a digital music file that you transfer to your computer using *pressplay*. You can play downloads as much as you want as long as your membership is active, and you can listen to them online or offline. All tiers of the *pressplay* service offer unlimited downloading of near CD-quality tracks from the *pressplay* library.

What is a Portable Download?
Portable Downloads are downloads which become permanent copies on your hard drive even if you are no longer a *pressplay* member. You can burn Portable Downloads to CD and transfer them to supported portable devices.

What is a portable device transfer?
A portable device (PD) allows you to transfer and play your Portable Downloads away from your computer via a portable music player. All *pressplay* members will be able to transfer tracks to compatible portable devices. To find out if your portable device is compatible, go to:

http://www.pressplay.com/compatible_devices.html

What is a Sony Net MD?
The Sony Net MD product line uses MiniDiscs (MD) to copy and playback your digital tracks. You can use the *pressplay* application to copy Portable Downloads to any of the products that support Net MD.

<http://www.pressplay.com/faq.html>

What is a burn?

"Burning music" is the process of copying Portable Downloads to a compact disc, which can then be played on any CD player. All *pressplay* members will be able to make CDs from their collections. You can burn an entire album, or you can burn a mixed CD with just your select favorites.

Can I block *pressplay* tracks with explicit content?

Yes. Any member that wants to block tracks with explicit content can simply change their settings in the **Member Information** section of *pressplay*.

Where can I find information about the *pressplay* Privacy Policy?

You can find information about the *pressplay* Privacy Policy at the following site:

<http://www.pressplay.com/privacypolicy.html>

Is *pressplay* available outside the United States?

Currently, *pressplay* is available to residents of the United States.

What are the benefits of upgrading to Windows Media Player 9 Series?

There are many reasons to upgrade to Windows Media Player 9 Series including reduced buffering and better stream quality. You can benefit from the enhancements of Windows Media Player 9 even if you are using the *pressplay* standalone application, as it uses 9 Series technology behind the scenes. You can get the latest free version of the 9 Series player at:

<http://windowsmedia.microsoft.com/download/download.asp>

How do I contact Windows Media Player 9 Series Customer Support?

If you have questions or issues with your Windows Media Player 9 Series, please refer to the Microsoft Website for support information:

<http://support.microsoft.com>

Which music labels are represented in the *pressplay* service?

pressplay members have access to one of the largest online music catalogs, which is constantly growing and currently features songs from all five major record companies--Universal Music Group, Sony Music Entertainment, EMI Recorded Music, Warner Music Group and BMG--and many independent labels.

I lost *pressplay* from my computer, or want to get it on another computer, how can I download and install the *pressplay* software? Can I access my *pressplay* service from another location, such as work, home, or even on the road?

You can access your *pressplay* account from your home or office, or anywhere that you have Internet access. You can play streaming files from anywhere that you have Internet access, and store your downloads on up to two computers.

To re-download *pressplay* or install it on another computer, click on the appropriate link corresponding to the affiliate you signed up with:

- [pressplay on MSN Music members click here](#)
- [pressplay on Yahoo! members click here](#)
- [Roxio *pressplay* members click here](#)
- [pressplay on MP3.com members click here](#)
- [pressplay on Sony's Musicclub members click here](#)
- [pressplay members click here](#)
- [Gateway Music Vault by *pressplay* members click here](#)
- [Rto *pressplay* members click here](#)
- [pressplay \(generic\) members click here](#)

Click on the provided link to download *pressplay*.

<http://www.pressplay.com/faq.html>

- Verify that you are signing in under the correct affiliate. If the affiliate listed on the sign-in page is not the affiliate you signed up with, then click the link to switch to another account, and then choose the correct affiliate to sign-in.
- For *pressplay* on MSN Music members, verify that you are using the correct MSN .NET Passport sign-in (e-mail address) and NOT your *pressplay* member name to sign in. If you can't remember your MSN .NET Passport sign-in or password, contact MSN for assistance:
 - <https://memberservices.passport.com/>

If you are still unable to sign in, then try calling a *pressplay* Customer Care representative at 888.660.2265 and provide us with your sign-in and password so we can verify whether the issue is with your specific sign-in, or whether it is an issue with your computer configuration.

I forgot my password or member name. What do I do?

The password and member name recovery process varies with each affiliate:

- *pressplay* on MSN Music members use the MSN .NET Passport to sign in. The .NET Passport e-mail address or password can be changed by following the instructions on the .NET Passport sign-in, or by going to the following URL: https://memberservices.passport.com/ppsecure/MSRV_ResetPW.asp
- All other *pressplay* affiliate members use the Integrated *pressplay* sign in. Please contact a Customer Care representative at 888.660.2265 to reset your password or recover your member name.

Can I copy my downloaded tracks to another computer?

You can store and listen to your downloads on up to two computers (the original computer you downloaded the track on, and one additional computer). For example, if you downloaded the track at home, you can also have another copy of the download on your computer at work. To do this, you need to first install *pressplay* on the secondary computer, and use the **Sync/Restore** feature.

I lost my *pressplay* downloads. How do I get them back?

CLIENT ONLY

When you launch *pressplay*, your default directory is scanned for the presence of your downloads. If a download is not in the default directory, it will have a **Status of Missing** on the **DOWNLOAD STATUS** sub-tab (under **MY COLLECTION**). Click the **restart download** button to re-download the track.

My Windows

If you delete a download from the 9 Series player Media Library, you can get the download back by going back to *pressplay*, searching for the track and downloading it again.

What are the minimum system requirements to use *pressplay*?

pressplay's minimum system requirements are as follows:

- Operating System—Windows 98, Windows 2000, Windows Me, or Windows XP

Note: *pressplay* is not supported on *Windows 95*, *Windows NT*, or *Macintosh*.

- Processor—Intel Pentium-class CPU equivalent or better
- Memory—64MB of RAM minimum
- Hard Drive—approximately 2 MB for *pressplay* and 12-15 MB for Windows Media Player (if not already installed)
- Sound Card—sound card and speakers
- Browser—Microsoft Internet Explorer version 5.01 or higher

1. Go to the **Services** tab on the 9 Series player.
2. Follow the link to sign up for *pressplay*.
3. Follow the link for "I am already a member!"
4. Click the link to install *pressplay*.
5. Follow the installation instructions and then sign into *pressplay* when prompted.

Will pressplay work if I am behind a firewall?
pressplay will work behind most firewalls. If you are having difficulties installing *pressplay*, upgrading your Windows Media Player, or streaming or downloading songs, we would suggest that you temporarily disable the firewall, or lower the security settings to see if this may be an issue.

How do I get updates for pressplay software?

CLIENT ONLY
 To update your version of the *pressplay* application, choose **Update pressplay** from the **My Account** drop-down menu. You are then guided through the update process if an update is available.

For Windows Media Player 9 Series
 If you are using the *pressplay* plug-in for Windows Media Player 9 Series, the *pressplay* plug-in will update itself automatically if an update is available.

How do I launch pressplay?

CLIENT ONLY
 You can access *pressplay* through the *pressplay* icon on your desktop.

For Windows Media Player 9 Series
pressplay for the Windows Media Player 9 Series is accessed via the **Services** button along the left side.

If I cancel, do I get to keep my downloads and/or Portable Downloads?
 If you choose to cancel your *pressplay* membership, you get to keep the Portable Downloads you acquired. However, you will lose the ability to play the regular downloads at the end of the period you paid through.

If you decide to come back to *pressplay* within six months, you can regain access to your entire download collection (using the **Sync/Restore** feature) after you sign up again using the same member name and password.

Can I share my pressplay membership with others?
 Your *pressplay* membership is for your personal use only. If you give others access to your *pressplay* account, keep in mind that only one concurrent user is allowed on your account at a time and the tracks they make Portable Downloads will count against your membership.

Can I access my existing pressplay membership through Windows Media Player 9 Series?

Absolutely! You can listen to your *pressplay* membership on either version of *pressplay*. To access your existing *pressplay* membership through Windows Media Player 9 Series:

1. Install the 9 Series player (this can be obtained at <http://windowsmedia.microsoft.com/download/download.asp>).
2. Click the **Services** button on the 9 Series player.
3. Follow the *pressplay* link.
4. Follow the "I am already a member!" link.

Note: *The different versions of pressplay are treated as separate installations and you will need to perform a Sync/Restore to listen to your downloads on the other version.*

How do I cancel my pressplay membership?

<http://www.pressplay.com/faq.html>

If you wish to cancel your membership:

1. CLIENT ONLY
Select **Account Status** from the **My Account** drop-down menu.
My Windows
Click **OPTIONS/HELP** from the **HOME** tab, and then click on **Account Status**.
2. Click on the **To cancel your membership** link.
3. Review the terms of cancellation and click **CONTINUE**.

Your membership will be terminated at the end of the billing period you paid through.

If you would ever like to reactivate your *pressplay* membership in the future, you can do so by signing up again through the same *pressplay* affiliate (follow the "I am already a member" link) and use the same member name and password. If you reactivate within six months, you will regain access to all of your existing downloads and playlists.

How can I reactivate a previously canceled membership?

To reactivate a canceled membership, sign into *pressplay* through the same affiliate with the same member name and password that you had before. You should receive a "Welcome Back to *pressplay*" page with a link to reactivate your account. If you reactivate your membership with the same member name/password within 6 months from when you canceled, you can regain access to your downloads using the Sync/Restore feature.

Note: If you need any help during the reactivation process, please feel free to contact pressplay Customer Care at 888.660.2265 and we can reactivate your membership for you.

If you no longer have *pressplay* installed on your computer, you can first download the *pressplay* application from one of the following sites (depending on which affiliate you originally signed up through):

- *pressplay* on **MSN Music** members click here
- *pressplay* on **Yahoo! Music** members click here
- **Roxio *pressplay*** members click here
- *pressplay* on **MP3.com** members click here
- *pressplay* on **Sony's Musicclub** members click here
- *pressplay* connect members click here
- **Gateway Music Vault by *pressplay*** members click here
- **Rio *pressplay*** members click here
- *pressplay* (generic) members click here

Once you download the *pressplay* application, sign in with the same member name and password and you should see a link to reactivate your account.

My Windows

If you signed up for *pressplay* through **Windows Media Player 9 Series** or wish to use *pressplay* through the 9 Series player:

1. Install the 9 Series player. This can be obtained at: <http://windowsmedia.microsoft.com/download/download.asp> If you do not have it already.
2. Click the **Services** button on the 9 Series player.
3. Follow the *pressplay* link.
4. Follow the "I am already a member" link.

<http://www.pressplay.com/faq.html>

I used up all the Portable Downloads in my membership plan before my membership period was over-is there a way I can get more Portable Downloads?

pressplay offers all members and trial participants the ability to purchase additional Portable Download packs to supplement your membership plan. You can purchase a 5-pack of Portable Downloads for \$5.95, a 10-pack for \$9.95, or a 20-pack for \$18.95. These Portable Download pack credits are good for as long as you are an active member. If you have a pressplay Unlimited or Unlimited Plus membership plan, you can also consider upgrading to a pressplay Annual Plus membership plan that provides 120 Portable Downloads for the year, all available on day one of your membership.

What is the basis for the recommendations in the recommendation engine?

The recommendations from pressplay's programming team are based on what other members are streaming, downloading, making portable, and searching for. The recommendations are served to the right of the search results window and are listed in order of artists with the greatest number of similarities to the artist the recommendations are based on.

Note: Occasionally the number and order of artist recommendations may be affected by the number of artists in the pressplay system and the inclusion of suggested new artists with no established usage history.

How can I browse through recent or past hits from the Billboard Charts?

pressplay features Billboard Charts that let you browse the most popular hits from today or relive the hits of years past. To view the Billboard charts:

1. Go to the **FIND MUSIC** tab and click the **BILLBOARD CHARTS** sub-tab.
2. From the chart drop-down menu, select the Billboard chart type that you would like to browse.
3. From the folders below, select the year and season that you want to view the hits from.
4. Click the **BROWSE** button.

How can I find out what music has recently been added to pressplay?

Check the "today: just added to pressplay" section on the homepage. This is updated daily with highlights of artists and tracks that have been recently added to pressplay. You can also **BROWSE NEW ADDITIONS** from the **FIND MUSIC** tab to browse through the content that has been most recently added.

To browse through the content that has been recently added to the pressplay service:

1. Go to the **FIND MUSIC** tab.
2. Click on **BROWSE NEW ADDITIONS**.

The last 1000 tracks that have been added to the pressplay service display, organized by artist and ranked by popularity in the service. You can sort these results alphabetically by artist by clicking on the **Artists** column header.

How can I find out more information about an artist or album?

Select an artist and click the **artist/album info** button (or right-click and choose **Artist Info** or **Album Info**). Information is provided that includes related artists, a discography, and a biography of the artist. Alternatively, you can simply click on the album thumbnail when the track is playing to view the artist information.

What is Radio pressplay?

Radio pressplay stations are professionally programmed, commercial-free stations customized to suit your tastes. Every time you listen to Radio pressplay, a new playlist of tracks is generated based on the station you choose. You can perform the same actions that you can perform on a playlist, such as skip, rewind, and view what's in the queue.

Can I skip tracks on Radio pressplay or view what's in the queue?

You can perform the same actions on Radio pressplay that you can perform on a playlist, such as skip a track, rewind to hear the track again, and view what's in the queue to play next.

How does the "Build Your Own Station" feature work and how are the tracks selected?

The build me a station feature of Radio pressplay lets you build a customized radio station based on your listening preferences. A 200-track playlist is created on-the-fly based on recommendations from the tracks you have downloaded in your collection. Playlist are genre-based, so if you have downloaded tracks from different genres you can get a variety of different playlists. Each time you click **BUILD NOW**,

a new station is created that could be based on a different genre (if your collection spans genres). And each time you click **BUILD NOW** a new selection of tracks will be selected, so each time you get a unique listening experience. If you do not have at least 10 downloads in your collection, then the playlist will be based on your favorite genre.

What file format and bitrate are the streaming tracks?

pressplay uses Windows Media Audio for streaming files. The music is streamed at 20, 32, or 96 Kbps depending on your connection speed.

- Dial-up-20 Kbps
- ISDN-32 Kbps
- Cable/DSL or higher -96 Kbps

Do I have to be online to stream a track?

Because a stream is played directly from pressplay's central servers, you must have a working Internet connection and be signed into pressplay in order to stream a pressplay track. If you download a track, you can play it offline.

How do I play an entire album?

To play an entire album, select **BROWSE ARTIST/ALBUM** from the **FIND MUSIC** tab and browse for the desired album. Select the album, right-click, and choose **Play Album**.

What file format and bitrate are the download tracks?

For download files, pressplay currently uses the Windows Media Audio (WMA) format encoded at 128 Kbps stereo.

How does the quality of a download track compare to a streaming track or CD?

pressplay downloads are encoded at a higher bit rate than our streams and therefore are of better quality. pressplay downloads use a high-quality WMA format that comes near to CD quality.

Can I stream tracks or use other applications while I am downloading?

Yes. pressplay runs behind the scenes, allowing you to perform most other tasks while you are downloading. The pressplay service is fully functional while you are downloading, so you can search for, or stream other tracks. Depending on your computer's capabilities, however, this may impact your streaming quality.

Can I copy my downloaded tracks to another computer?

Yes, you can store and listen to each of your downloads on up to two computers (the original computer you downloaded the track on, and one additional computer). For example, if you downloaded the track at home, you can also have another copy of the download on your computer at work. To do this, you need to first install pressplay on the secondary computer, and use the **Sync/Restore** feature.

Note: Portable Downloads are not included in the Sync/Restore. You can copy or re-download a Portable Download on an additional computer, but it will be treated as a regular download that cannot be burned or transferred without using an additional Portable Download credit.

If my hard drive fails or I get a new computer, how can I regain access to my downloads?

You can use the pressplay Sync/Restore feature to restore your downloads to one additional computer at no extra charge. If you have already used up your Sync/Restore and your computer crashes, you bought another computer, or have other extenuating circumstances, then contact Customer Care and they can give you an additional Sync/Restore.

Do I have to be online to play a downloaded track?

An Internet connection is required to download the track, but once you have downloaded the track you do not need to be online to play the track.

Note: If you have not been online since the rights for that track renewed for a succeeding month, you may be prompted to connect momentarily to acquire the license renewal.

Can I make a download permanent so it never expires?

When you make a download a Portable Download, it is yours to keep even if your membership expires. In addition, you will be able to burn and transfer the Portable Download to a CD or portable music player. Any track that has the burn or transfer icon in the Options column can

be made portable.

Can I purchase my downloads outright so I can keep them after I am a *pressplay* member?

You can convert your downloads to Portable Downloads to make them permanent. Portable Downloads may be burned to CD, transferred to portable devices and kept after your membership expires. If you want to purchase more Portable Downloads than what are allotted in your membership plan, you can purchase packages of Portable Downloads for less than \$1 per download.

What is a Portable Download pack?

pressplay Portable Download packs are a convenient way to purchase additional Portable Downloads. The following Portable Download packs are available:

- 5-pack of Portable Downloads for \$5.95
- 10-pack of Portable Downloads for \$9.95
- 20-pack of Portable Downloads for \$18.95

Portable Download credits from your Portable Download pack will not expire as long as you are a *pressplay* member.

Portable Download packs can be purchased directly from the **Account Status** page. If you attempt to burn or transfer a track without enough existing credits, you will also be given the opportunity to purchase a Portable Download pack at that time.

How do I purchase a Portable Download pack?

To purchase a Portable Download pack:

1. **CLIENT ONLY**
Select **Account Status** from the **My Account** drop-down menu.
My Account
Click **OPTIONS/HELP** from the **HOME** tab, and then click on **Account Status**.

2. Click the link that says "Click here to buy more Portable Downloads!".
3. Select the number of Portable Downloads you wish to purchase.
4. Review the details of the offer and click **SUBMIT** to accept.

Portable Download credits from your 5-, 10-, or 20- packs will not expire as long as you are a *pressplay* member.

Can I burn and transfer an entire album?

Yes, you can burn and transfer as many tracks from an artist or album as you like. There is no restriction on the number of tracks per artist that you can burn and transfer, as long as you have the available Portable Downloads credits.

Which CD Burners are supported by the Roxio CD burning software?

The Roxio CD burning software supports most standard CD burners. To check if your particular CD burner is supported, go to:

http://rpp.roxio.com/drives/?page=supported_drives

If you have a new CD RW that is not on the list, check back in the near future as Roxio updates this list frequently.

Which portable music players are supported by *pressplay*?

Most flash and hard disk based portable music players that support the Windows Media format are compatible with the *pressplay* service. To see if your portable music player is compatible, go to:

http://www.pressplay.com/compatible_devices.html

CLIENT ONLY

How do I transfer Portable Downloads to a portable device using the *pressplay* application?

Note: Before you attempt to copy or transfer, verify that you have a compatible portable device installed and that it is detected by your operating system.

Note: Before you transfer a track you must first download the track or directly make the track a Portable Download. If the track has not been downloaded, it will not appear under tracks available to transfer.

1. Go to the **BURN/TRANSFER** tab.
2. Select the **TRANSFER TO PORTABLE DEVICE** sub-tab.
3. Select **Available Tracks** or locate the tracks under **Available Artists or Playlists**. If the track(s) you want to transfer are not listed, then verify that they have been downloaded and have transfer options.
4. Drag and drop the tracks you want to burn from the upper area into the lower track staging area.
5. Drag and drop tracks to the desired location within the list or use the provided arrow keys to move the tracks up and down in the order.
6. Once you have added and sorted all the tracks in the burn staging area, click **transfer to PD**.
7. Click **YES** to accept the offer.
8. Windows Media Player launches with your selected tracks ready to transfer. Verify that your portable device is connected and contains the proper media.
9. Click **Copy Music** from Windows Media Player.

A status screen displays the progress of the transfer process. See the *pressplay* User Guide for more details.

CLIENT ONLY

Which tracks can I copy to a Net MD device?
Any track that has the burn icon displayed in the **Options** column can be copied to a Net MD player, provided you have sufficient Portable Download credits left in your membership plan. Note that a track must be downloaded before it can be burned.

CLIENT ONLY

How many times can I burn or copy the same Portable Download?
You can burn or copy each Portable Download one time. You can also transfer the Portable Download to a portable device. If you want an additional burn, you can use another Portable Download credit.

If I do not use up my Portable Download credits, do they carry over into the next billing period?

The Portable Download credits allotted for your membership period do not carry over unless they are Portable Download credits purchased via a 5, 10, or 20 pack of Portable Downloads. At the beginning of each billing period, your Portable Download credits from your membership reset to the amount allotted in your membership plan regardless of whether you have unused credits left over from the prior billing period.

Can I use my player or another application to burn *pressplay* tracks?

Other software such as Easy CD Creator or Windows Media Player may be used to burn Portable Downloads, but *pressplay* can only provide support for burns initiated through the *pressplay* application or Windows Media Player 9 Series.

Which tracks am I allowed to burn to CD?

Any track that has the burn icon displayed in the **Options** column of the search results can be burned to CD, provided you have sufficient Portable Download credits left in your membership. Note that a track must be downloaded before it can be burned.

CLIENT ONLY

How do I get the Roxio Basic CD Label Creator?
Click **Update *pressplay*** from the **My Account** drop-down menu. There is a link here to install the Roxio Basic CD Label Creator. The Label Creator is offered to you free of charge.

Who can I contact if I am having issues with my portable music player?
If you have questions or concerns related to your portable music player, please contact customer support for the manufacturer of your device. **pressplay** Customer Care can only support issues related to the **pressplay** service.

For issues or additional questions related to Rio or Nike ps[play] products, please contact SONIC | blue support by visiting their customer support site:

www.sonicblue.com/support

For issues related to your **Creative NOMAD** player, see:

<http://www.americas.creative.com/support/welcome.asp?RD=faq>

For additional FAQs related to your **Compaq IPAQ™** player, see:

<http://www1.pro.compaq.com/support/home/index.asp>

COMMUNITY MESSAGE BOARD

What is the **pressplay** Message Board?

The **pressplay** Message Board is a community forum for **pressplay** members to exchange knowledge, tips, music recommendations, or any other information. You can post a question or start a discussion topic using the **pressplay** Message Board, and other **pressplay** members can post responses. See the **pressplay** User Guide for more information on how the **pressplay** Message Board works.

How do I create or edit my **Public Profile**?

To create a public profile to share you tastes and interests with other **pressplay** members:

1. **CLIENT ONLY**
Select **Public Profile** from the **My Account** menu.
- My Account*
Click **OPTIONS/HELP** from the **HOME** page, and follow the **Public Profile** link.
2. Click the **EDIT** button.
3. Edit the fields and then click **SAVE**.

The checkbox at the bottom of the **Public Profile** indicates whether you want your member name displayed when other members view **Now Streaming** or whether you want your collection to be available to other members. To share your **Public Profile** check the box in front of "I'd like to make **My Collection** and **Member Name** available...". If you do not want your member name displayed, do not check this box.

*Note: Please allow 24 hours for updates to the **Public Profile** to take effect.*

How can I see what other members are listening to?

You can check out what other members are streaming at any given time, by looking under **NOW STREAMING** on the **COMMUNITY** tab. Select a **genre** and **sub-genre**(optional) and then click **BROWSE** to get a list of the most recent songs streamed for that genre.

How do I make it so my member name does not appear under **Now Streaming**?

Only tracks streamed by members who have shared their public profile appear under **NOW STREAMING**. To opt out of this feature so your member name does not display:

- **CLIENT ONLY**
Select **Public Profile** from the **My Account** menu.
- My Account*
Click **OPTIONS/HELP** from the **HOME** page, and follow the **Public Profile** link.

<http://www.pressplay.com/faq.html>

- Toward the bottom, uncheck the box in front of "I'd like to make My Collection and Member Name available..."
- Click **SUBMIT** to save your changes.

Note: Please allow 24 hours for updates to the Public Profile to take effect.

How can I view other members' collections?

The **BROWSE MEMBERS' COLLECTION** sub-tab (under the **COMMUNITY** tab) lets you browse or search for other *pressplay* members' collections to find other members with similar musical tastes, and to discover new music.

To browse member's collections:

1. Go to the **COMMUNITY** tab.
2. Go to the **BROWSE MEMBERS' COLLECTION** sub-tab.
3. Pick a **genre** from the drop-down menu.
4. Click the **BROWSE** button.

You can also search for a specific *pressplay* member's collection from the **SEARCH FOR MEMBER** sub-tab.

Also note that when you choose a track and select **Find in Member's Collection** from the right-click menu, all the members who have bookmarked that particular track will display.

Terms and Conditions Privacy Policy
©2001-2002 *pressplay*

THIS PAGE BLANK (USPTO)

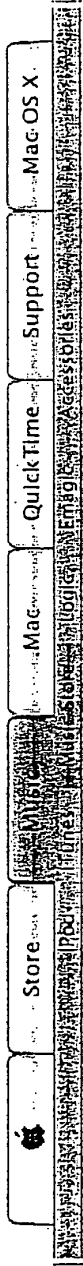

The iTunes Music Store. Downloads done right.

<p>Free 30-second, full-quality previews of any song</p>	<p>Download songs directly to your music library</p>	<p>Exclusive artists and tracks</p>	<p>Scroll through the latest releases and staff favorites</p>	<p>Browse entire store library by genre, artist and album</p>	<p>Search for any artist, song or album plus power search</p>	<p>Top song downloads</p>	<p>Top album downloads</p>
--	--	-------------------------------------	---	---	---	---------------------------	----------------------------

The revolutionary iTunes Music Store puts 200,000 songs at your fingertips. It's built right into iTunes 4 and lets you search or browse genres, new releases, exclusives and more. Preview any song for free. When you find a song you want, buy it for just 99¢.

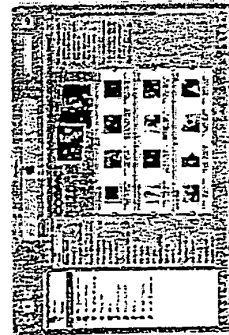

What you've been waiting for. It's what music lovers have been waiting for: a music store with Apple's legendary ease of use, offering a hassle-free way to preview, buy and download music online quickly and easily. The iTunes Music Store has virtually every category of music to choose from. And whatever your



Download iTunes 4 with the iTunes Music Store.

Start shopping. Signing in is simple.

Just use your existing Apple ID or Mac account. If you don't have an Apple ID, it's simple to create one.



The iTunes Music Store requires a Mac equipped with iTunes 4

tastes in music are: Rock, Rap, Jazz, Blues, Pop, Latin, New Age, Folk, Inspirational, R&B, Reggae, Electronic, Classical or something in between — chances are you'll find the tunes you're looking for. And the iTunes Music Store's catalog of songs is growing every week. So if you don't find a track you're looking for, come back tomorrow.

Know when new songs are available

Be sure to sign up for the free "New Music Tuesdays" email bulletin (available when you create your account) to keep current with all the new releases and newly added back catalog selections.

High-quality tracks

One of the first things you'll notice about the music is the stunning sound quality. In fact the sound was so good that audiophiles who beta tested the iTunes Music Store were astonished to learn they were listening to 128 kbps sound files. The secret? It's the new AAC format, which combines sound quality that rivals CDs with smaller files sizes (compared to MP3s). So not only do the songs take up less space on your hard disk, they can be downloaded faster, too.



Easy and free music previews

To hear what a song sounds like, simply double-click on a music track just as you would a song stored on your hard disk. You'll hear a 30-

second sample that rivals CD quality sound. The iTunes Music Store also lets you to view an artist's discography. What's more, you get the album cover art as well. As you've probably experienced, there are times when a hot new album is sold out. The great thing about buying music in the iTunes Music Store is it's open 24/7 with unlimited availability of our catalog of songs.

Instant gratification

Apple has made the music-buying experience a whole lot easier. Our agreements with the major record labels make a huge selection of music available to you. You can buy an album or only the songs you want. And once you buy the music, you own it — no complicated rules, no clubs to join, and no monthly fees. If you like a song, you buy it for just 99¢, and it downloads directly to your music library in seconds. In fact, you can buy a song or a whole album with just one click.

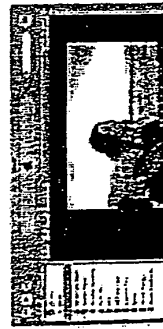

A treat in store for music lovers

If you have a broadband connection, enjoy exclusive full-length music videos that you can watch right in the iTunes Music Store. Choose from over a dozen top artists that also have exclusive tracks in the Music Store.

It's easy, it's fair and it's legal

and Mac OS X Version 10.1.5 or later.

iTunes Music Store Features

Shop till you bop

Listen to 30 second, full-quality samples of tracks before you buy, so you know you really will get into the groove when you download them. At the iTunes Music Store, you'll only pay for what you like and want: you can buy individual tracks or an entire album.



Exclusive tracks and material
Find exclusive tracks not available anywhere else. That's because all five major record labels are in play. And since it's legal, you know the artists are getting paid for their work.

Browse for something new

Browse the store broadly by genre, by artist or album. Plus you can find new music by checking out what other people who share your taste in music have been listening to.



Find music easily and quickly

Locating the songs you want out of the hundreds of thousands of songs available is a simple matter. Perform quick searches on artist, albums, composers and songs or use advanced search to filter by title, artist or album.

Shopping cart optional

Planning to download more than one song? Use the optional shopping cart to hold your selections until you're ready to buy. That way you can download as many songs as you like with just one convenient transaction.

The iTunes Music Store is fast and convenient for you, and fair to the artists and record companies. In a nutshell, you can play your music on up to three computers, enjoy unlimited syncing with your iPods, burn unlimited CDs of individual songs, and burn unchanged playlists up to 10 times each.

Getting started

The iTunes Music Store is only available in the U.S. To get running all you need is a Mac with Mac OS X (version 10.2.5 or later recommended), and an Internet connection (DSL, Cable or a LAN-based connection recommended for streaming and downloading music). Just download iTunes 4, click the Music Store icon, and you've got the world's most accessible music store, right on your screen. Feel free to browse for as long as you want. There's no pressure to buy, no annoying pop-up ads, and no confusion about what's offered.

[Home](#) > [Music](#) > iTunes Music Store

Search

[Site Map](#) | [Search Tips](#)

Visit the Apple Store online or at retail locations.
1-800-MY-APPLE

[Contact Us](#) | [Privacy Policy](#)
Copyright © 2003 Apple Computer, Inc. All rights reserved.

THIS PAGE BLANK (USPTO)



Home | About RHAPSODY | The Music | Wireless | FAQs & Help | About Listen.com

The Celestial Jukebox | Subscription Plan Details | Features & Requirements | Tools & Tips | Reviews

Subscription Plan Details

RHAPSODY offers a variety of subscription options to help you find exactly what you're looking for. Within minutes you can be listening to thousands of complete albums on-demand, relaxing to your favorite classical masterpiece, burning CDs, listening to CD-quality radio, or just getting a sneak peek with RHAPSODY Preview. The choice is yours.

Get the 7-Day FREE Trial!



RHAPSODY

All Access

Get access to everything we've got. Over 20,000 albums from more than 9,000 artists in every imaginable genre. Rock, hip-hop, R&B, country, jazz, classical...major label and indie...it's all in here. Want to listen to complete albums and create your own playlists? Want to build a library of your favorite music? Subscribing to All Access is like having a music megastore at your fingertips for less than the price of a CD.

- Play what you want, when you want, without limits
- Includes a subscription to Radio PLUS (see below)
- Burn your own CDs - just \$.99 per track

\$9.95/month
7-Day FREE Trial

RHAPSODY

Radio PLUS

The ultimate internet radio. Get access to over 50 professionally programmed radio stations in a wide variety of genres. Create custom stations based on your favorite artists. Listen in CD-quality sound. Skip the tracks you don't like. Want to listen to your favorites while we introduce you to great new music? Want to take control of your radio? Radio PLUS is for you.

\$4.95/month
7-Day FREE Trial

RHAPSODY

Preview

Get a sneak peek at what RHAPSODY is all about. Preview includes a limited number of free radio stations and access to 30-second clips of our catalog of music. Subscribe anytime to get your 7-day FREE trial of the full experience.

FREE

THIS PAGE BLANK (USPTO)



- [Home](#)
- [About RHAPSODY](#)
- [The Music](#)
- [Wireless](#)
- [FAQs & Help](#)
- [About Listen.com](#)

- [The Celestial Jukebox](#)
- [Subscription Plan Details](#)
- [Features & Requirements](#)
- [Tools & Tips](#)
- [Reviews](#)

Features & System Requirements

Get the 7-Day FREE Trial!



- Music Library**
- Add tracks and albums to a personal music library.
 - Organize music collections by artist, album, track, playlist or radio station.
 - Create, edit, save, and share custom playlists.
 - Burn your own CDs
- Player**
- Use interactive controls to play, stop and pause tracks.
 - Skip through playlist tracks in on-demand music or subscription radio modes.
 - Trigger detailed music information to accompany each track.
 - Enjoy relevant editorial notes alongside each track.
 - Link to label site or CD retailer to buy a physical copy.

- Music Discovery**
- Find music by searching or browsing.
 - Search for music by artist, album, track, or composer.
 - Listen to Samplers -- our editorially programmed playlists.
 - Choose from dozens of professionally programmed radio stations.
 - Create custom radio stations based on artists.
 - Discover more music through editorial recommendations.
 - Learn more with detailed music information and links.
- Member Services**
- Manage member account and subscription plans.
 - Find help and get answers quickly in our state-of-the-art knowledge base.

- System Requirements**
- Windows XP, Me, 2000, 98 SE or NT 4.0 Service Pack 6
 - Microsoft Internet Explorer 5.0 or later

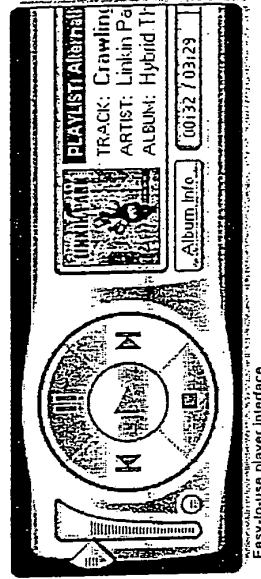
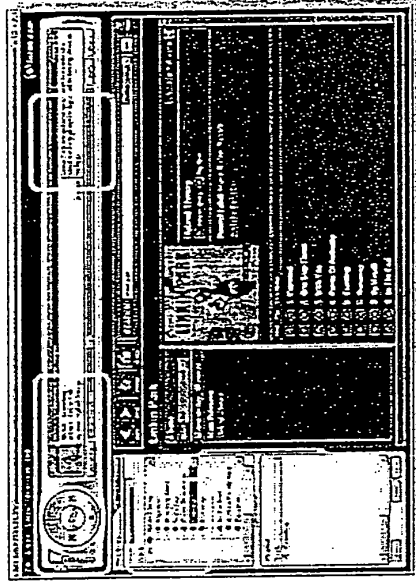

Easy-to-use player interface

http://www.listen.com/rhap_about.jsp?sect=feat

- Pentium II / 350 MHz equivalent or better
- 64 MB of RAM minimum
- 250 MB hard disk space
- 256 color display (16-bit display recommended)
- Active Internet connection (broadband/128+ kbps recommended)
- Sound card
- Speakers or headphones

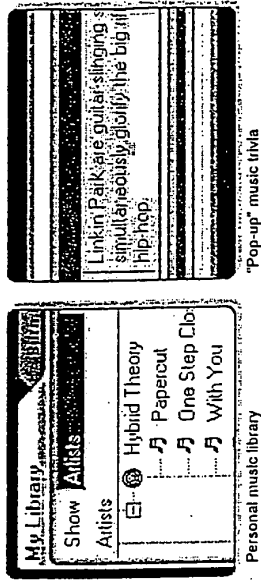

© 1999-2003 Listen.com [privacy statement](#) [terms of use](#)

IN THE UNITED STATES DISTRICT COURT
FOR THE WESTERN DISTRICT OF PENNSYLVANIA

Sightsound.com Inc.,

Plaintiff,

v.

N2K, Inc., CDnow, Inc., and
CDnow Online, Inc.,

Defendants.

CIVIL ACTION

No. 98-0118

Chief Judge Donetta W. Ambrose

FINAL ORDER AND JUDGMENT ON CONSENT

Plaintiff Sightsound.com Incorporated, ("Sightsound") filed this patent infringement action against Defendant N2K, Inc. ("N2K") on January 16, 1998, alleging infringement of U.S. Patent No. 5,191,573 ("the '573 patent"), issued March 2, 1993 and U.S. Patent No. 5,675,734 ("the '734 patent"), issued October 7, 1997. On March 31, 2000, Sightsound amended its Complaint to join Defendants CDnow, Inc., and CDnow Online Inc., (collectively "CDnow"), alleging infringement of the '573 and '734 patents, as well as infringement of U.S. Patent No. 5,966,440 ("the '440 patent"), issued October 12, 1999, (collectively "the Asserted Patents").

WHEREAS upon the representation of Defendants N2K and CDnow through their counsel that, without conceding infringement or other liability resulting from their prior activities in the music download business, neither Defendant N2K nor CDnow contests the validity or enforceability of any of the Asserted Patents;

WHEREAS, upon the representation of the parties through their respective counsel that the parties have settled this case;

AND WHEREAS, upon the representation of the parties through their respective counsel that the parties have consulted among themselves, each other, and each with the assistance of

counsel of their own choosing, and subject to the approval of the Court, the parties hereto now stipulate and consent to this Final Order and Judgment on Consent as set forth below.

NOW THEREFORE, upon consent of the parties hereto,

IT IS HEREBY ORDERED, ADJUDGED, AND DECREED, that:

- 1) The Court has jurisdiction over the entire subject matter and parties in this action as set forth in the Complaint pursuant to 28 U.S.C. §§ 1331, 1332, and 1338. Venue is proper in this district as set forth in the Complaint pursuant to 28 U.S.C. § 1391(b);
- 2) Each of the Asserted Patents shall be deemed valid and enforceable;
- 3) Plaintiff's claims are hereby dismissed with prejudice as to acts occurring prior to February 12, 2004, and without prejudice as to all future acts;
- 4) Defendants' counterclaims as to noninfringement are hereby dismissed with prejudice as to acts occurring prior to February 12, 2004, and without prejudice as to all future acts, and their counterclaims as to validity and enforceability are hereby dismissed with prejudice;
- 5) The parties hereto have waived appeal from or any other challenge to this Final Order and Judgment on Consent;
- 6) Each party shall bear its own attorneys' fees, expenses and costs that have accrued in connection with this action prior to entry of this Final Order;

- 7) This Court retains jurisdiction over the parties hereto for the purpose of any proceedings to enforce this Final Order and Judgment on Consent, and the parties' Settlement Agreement dated February 12, 2004.

SO ORDERED

Dated: 2/20/04

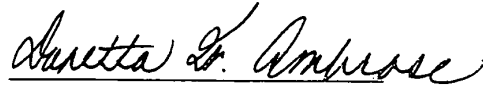
Donetta W. Ambrose
United States District Judge

CONSENT TO ENTRY

The parties through their respective counsel hereby consent to the terms and conditions of this Final Order and Judgment on Consent as set forth herein and consent to the entry hereof, and waive any right of appeal therefrom. This Consent to Entry may be executed in one or more counterparts, each of which when so executed shall, together, constitute and be one and the same instrument.

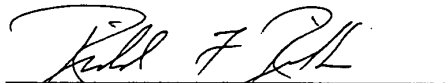
Richard F. Rinaldo (Pa. I.D. No. 33222)
MEYER, UNKOVIC & SCOTT LLP
1300 Oliver Building
Pittsburgh, PA 15222
(412) 456-2800

Of Counsel
William K. Wells, Jr.
Brian S. Mudge
Mark M. Supko
KENYON & KENYON
1500 K Street, NW, Suite 700
Washington, DC 20005
(202) 220-4200

Attorneys for Plaintiff
SIGHTSOUND.COM INC.

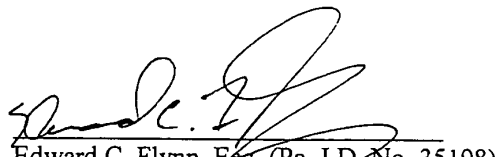
Edward C. Flynn, Esq. (Pa. I.D. No. 35198)
Law & Finance Building, Suite 1808
429 Fourth Avenue
Pittsburgh, PA 15219-1505

Of Counsel
Steven M. Hayes
Monica Youn
MANATT, PHELPS & PHILIPS, LLP
500 Fifth Avenue, 38th Floor
New York, New York 10110
(212) 382-0200

Attorneys for Defendants
N2K, INC., CDNOW, INC., and
CDNOW ONLINE, INC.

SETTLEMENT AGREEMENT

This Settlement Agreement ("Agreement"), made and entered into this 12th day of February, 2004 ("Effective Date"), is by and between SightSound Technologies, Inc. (formerly known as Sightsound.com, Inc.), a Delaware corporation having a place of business at 733 Washington Road, Suite 400, Mount Lebanon, PA 15228 ("Sightsound"), and BeMusic, Inc., a Pennsylvania corporation having a place of business at 1540 Broadway, New York, NY 10036 ("BeMusic").

WITNESSETH:

WHEREAS, Sightsound filed a patent infringement action in the United States District Court for the Western District of Pennsylvania, Civil Action No. 98-0118 ("the Lawsuit"), against Defendant N2K, Inc. ("N2K") on January 16, 1998 and, on March 31, 2000, Sightsound joined CDnow, Inc., and CDnow Online Inc., (collectively "CDnow"), as defendants in the Lawsuit;

WHEREAS, N2K and CDnow asserted counterclaims in the Lawsuit for declaratory judgment of patent noninfringement, invalidity, and unenforceability;

WHEREAS, BeMusic is the successor-in-interest to N2K and CDnow;

WHEREAS, Sightsound and BeMusic desire to amicably settle the differences that have given rise to this controversy; and

WHEREAS, the parties desire that LQ Corporation, Inc. (formerly known as Liquid Audio, Inc.), a Delaware corporation having a place of business at 888 Seventh Avenue, 17th Floor, New York, NY 10019 ("Liquid Audio"), be a third party beneficiary of the provisions as directed to Liquid Audio in Paragraphs 4(a) and 5 herein.

NOW, THEREFORE, for and in consideration of the mutual covenants, agreements and understandings contained in this Agreement, and for other good and valuable consideration, the sufficiency and receipt of which each party acknowledges, Sightsound and BeMusic agree as follows:

1. Definitions. "Patents in Suit" shall mean collectively: (a) U.S. Patent No. 5,191,573 titled "Method for Transmitting a Desired Digital Video or Audio Signal," issued March 2, 1993 to Arthur R. Hair ("the '573 Patent"); (b) U.S. Patent No. 5,675,734 titled "System for Transmitting Desired Digital Video or Audio Signals," issued October 7, 1997 to Arthur R. Hair ("the '734 Patent"); and (c) U.S. Patent No. 5,966,440 titled "System and Method for Transmitting Desired Digital Video or Digital Audio Signals," issued October 12, 1999 to Arthur R. Hair ("the '440 patent").

2. Payment. BeMusic shall make a one-time, lump-sum payment to Sightsound in the amount of Three Million and Three Hundred Thousand Dollars (\$3,300,000.⁰⁰), payable within five (5) business days of the Effective Date. This payment shall be made by wiring electronically to Kenyon & Kenyon in accordance with electronic wiring instructions provided by Kenyon, who shall hold the payment in escrow for Sightsound until the Consent Judgment, described in Paragraph 3 below, is entered by the Court. BeMusic represents that, pursuant to separate arrangements between BeMusic and Liquid Audio, Liquid Audio is contributing to BeMusic an undisclosed amount toward BeMusic's payment hereunder.

3. Stipulation to Consent Judgment. Upon execution of this Agreement, Sightsound, N2K, and CDnow shall, by and through their respective counsel, mutually execute and deliver the Final Order and Judgment on Consent in the form attached as Exhibit A hereto ("Consent Judgment"), in which CDnow and N2K acknowledge validity and enforceability of the Patents in Suit, without conceding infringement or other liability resulting from their prior activities in the music download business. Conditioned on receipt of the payment set forth in Paragraph 2 above, Sightsound shall promptly submit the Consent Judgment to the United States District Court for the Western District of Pennsylvania for entry by the Court, it being understood that the Court shall retain jurisdiction for the purposes of enforcing the Consent Judgment or this Agreement.

4. Mutual Releases. (a) Conditioned on and subject to the Court's entry of the Consent Judgment, Sightsound releases N2K, CDnow, BeMusic, and Liquid Audio, including any and all current affiliated or related entities thereof, and their respective officers, directors, employees, agents and attorneys, from any and all claims or causes of action arising from or relating in any manner whatsoever to the subject matter of the Lawsuit and accruing on or before the Effective Date that Sightsound has or may have had at any time prior to the Effective Date.

(b) Conditioned on and subject to the Court's entry of the Consent Judgment, BeMusic, for itself and for CDnow and N2K, releases Sightsound and its respective officers, directors, employees, agents and attorneys from any and all claims or causes of action arising from or relating in any manner whatsoever to the subject matter of the Lawsuit and accruing on or before the Effective Date that BeMusic, CDnow and/or N2K has or may have had at any time prior to the Effective Date.

5. Covenant Not to Sue. Conditioned on and subject to the Court's entry of the Consent Judgment, Sightsound covenants and agrees that it shall not bring any new civil action against BeMusic, CDnow, N2K or Liquid Audio, or any of their current affiliated or related entities, and their respective officers, directors, employees, agents and attorneys, for any claims or causes of action arising from or relating in any manner whatsoever to the subject matter of the Lawsuit that accrued at any time on or before the Effective Date.

6. Publicity. Sightsound may issue a press release publicizing the parties' settlement, said statement about the settlement to be substantially in the form attached as Exhibit B hereto (it being understood that any such press release may contain additional information about Sightsound and its business). Sightsound and its representatives may further discuss with the media the terms of settlement and this Agreement to the extent covered in the press release. Nothing shall prohibit Sightsound from disclosing this Agreement, or its terms, or information in the public domain about the Lawsuit to any party, including potential licensees of Sightsound or current or potential investors in Sightsound, or to any US or foreign governmental agency, including the United States Patent and Trademark Office.

7. Representations and Warranties.

(a) Sightsound ownership of patents. Sightsound represents and warrants that it is the owner of all rights, title and interest in and to the Patents in Suit, and that it currently has no other issued patents directed to methods for the electronic sale and transmission of digital music.

(b) BeMusic as successor-in-interest. BeMusic represents and warrants that it is the successor-in-interest to CDnow and N2K, and that as of the Effective Date is not actively engaged in the sale of digital music downloads.

(c) Corporate Authority. Each party represents and warrants that it has freely entered into this Agreement, fully intending to be bound by the terms and conditions contained herein; that it has full power and authority to execute, deliver, and perform this Agreement; that prior to the date of this Agreement, all actions of the party necessary for the execution, delivery, and performance of this Agreement by the party have been duly taken; and that this Agreement has been duly authorized and executed by the party, is the legal, valid, and binding obligation of the party, and is enforceable as to it in the United States.

(d) Signatory Authority. The individuals who have executed this Agreement on behalf of the parties expressly represent and warrant that they are authorized to sign on behalf of the parties for the purpose of binding the parties to this Agreement.

8. Affiliates and Successors. The rights and obligations of this Agreement shall extend to the parties hereto, their current affiliates, parents, subsidiaries and divisions and all those acting in concert or in participation with them or under their direction or control, and upon their successors and assigns.

9. Fees and Costs. As between Sightsound and BeMusic, each party shall bear its own attorneys' fees, expenses and costs incurred in connection with the Lawsuit.

10. Patent License. (a) This Agreement shall not be construed as granting a license under the Patents in Suit as of the Effective Date to CDnow, N2K or BeMusic. (b) Should BeMusic or any affiliate, parent, subsidiary or division of BeMusic (each, together with BeMusic, a "BeMusic Related Company") desire to obtain a license under the Patents in Suit at any time in the future ("Future Patent License"), Sightsound agrees to grant such BeMusic Related Company a license thereto with terms that are consistent with the most favorable terms that Sightsound will have entered into, as of the date such request is made by BeMusic, with any other existing licensee (excluding any licensee (i) that is an individual or a single performing group, (ii) receiving a grant of rights extending beyond the Patents in Suit, and/or (iii) receiving services in addition to a grant of rights to the Patents in Suit). For the avoidance of doubt, the sum paid by BeMusic to Sightsound under Paragraph 2 above shall be separate from and exclusive of any consideration to be paid by any BeMusic Related Company pursuant to the Future Patent License.

11. Dispute Notification and Discussion. A party, prior to (i) filing any new legal action against the other party hereto, or (ii) seeking to enforce the Consent Judgment, shall provide written notice to the other party of any claim or dispute arising under this Agreement or under the Consent Judgment. Within five (5) business days after delivery of such written notice, the recipient or its representatives shall respond to such written notice in an effort to resolve the claim or dispute. Once such five-day period has elapsed, the party providing notice may proceed with appropriate legal action if it believes that such dispute or claim remains unresolved.

12. Notices. Any notice, or communication provided for in this Agreement shall be deemed sufficiently given when delivered by overnight courier or certified or registered mail addressed to the

party for whom it is intended at the following addresses or such changed addresses as the parties shall have specified by written notice:

If to SIGHTSOUND:

Christopher Reese, Esq.
SightSound Technologies, Inc.
733 Washington Road, Suite 400
Mount Lebanon, PA 15228

with copies to: William K. Wells, Esq.
KENYON & KENYON
1500 K Street, N.W.
Washington, D.C. 20005

If to BEMUSIC:

Clifton B. Knight, Jr.
BeMusic, Inc.
1540 Broadway
New York, NY 10036

with copies to: Steven M. Hayes, Esq.
MANATT, PHELPS & PHILIPS, LLP
500 Fifth Avenue, 38th Floor
New York, New York 10110

13. Entire Agreement. This Agreement constitutes the entire agreement of the parties hereto and supersedes all prior negotiations, understanding and agreements, whether written or oral, with respect to the subject matter of the Lawsuit. This Agreement is entered into and executed without reliance upon any promise, warranty or representation by any party or any representative of any party hereto, other than those expressly contained herein.

14. Waiver. Any failure by either party to insist upon the performance of a provision of this Agreement shall not constitute a waiver of any other right of either party which the party may have under this Agreement. Any such waiver can only be made in writing signed by the party against whom enforcement of such waiver is sought.

15. Modification. This Agreement may not be modified, amended, altered or supplemented except by a written agreement executed by both parties hereto.

16. Governing Law. This Agreement and its enforcement shall be governed by, and construed in accordance with, the laws of the Commonwealth of Pennsylvania, without regard to conflicts-of-law principles. Any suit or enforcement proceeding arising out of this Agreement shall be brought or maintained exclusively in the courts of the Commonwealth of Pennsylvania located in Pittsburgh, Pennsylvania, or in the United States District Court for the Western District of Pennsylvania. Each party hereby irrevocably submits to the exclusive jurisdiction of such courts, and

waives any objection which it may have at any time to the laying of venue of any proceeding brought in any such court, waives any claim that such proceeding has been brought in an inconvenient forum, and waives the right to object that such court does not have any jurisdiction over such party with respect to such proceeding.

17. Counterparts. This Agreement may be executed in counterparts, each of which shall be deemed an original, and all of which shall upon execution and delivery constitute one and the same agreement; provided, however, that this Agreement shall not be effective until this Agreement is executed and delivered by both Sightsound and BeMusic by facsimile or other means.

IN WITNESS WHEREOF, the parties hereto, intending to be mutually bound, have caused this Agreement to be executed by their duly authorized officers as of the day, month and year first herein above written.

SIGHTSOUND TECHNOLOGIES, INC.

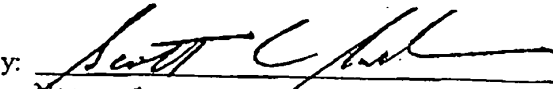
By: 
Name: SCOTT C. SANDER
Title: PRESIDENT & CEO

BEMUSIC, INC.

By: _____
Name:
Title:

IN WITNESS WHEREOF, the parties hereto, intending to be mutually bound, have caused this Agreement to be executed by their duly authorized officers as of the day, month and year first herein above written.

SIGHTSOUND TECHNOLOGIES, INC.

By: _____
Name:
Title:

BEMUSIC, INC.

By: Clifton B. Knight Jr.
Name: Clifton B. Knight, Jr.
Title: Senior Vice President, Business and Legal Affairs

Over half a billion songs have been sold and legally downloaded from the iTunes Music Store.

500,000,000

Thanks to all the music fans in 19 countries for making the iTunes Music Store the #1 music download store.

Free Download 

iTunes 4.9 for PC + Mac



Hot News Headlines "Billie Holiday: The Ultimate Collection" DVD Set Created with DVD Studio Pro.





Radio reborn.
iTunes 4.9 with Podcasting.

Get Mac OS X 10.4.2
Improve Tiger's reliability and compatibility. Run Software Update now.



Download Widgets
Over 300 to choose from.

New 20GB iPod
Up to 15-hour battery life
Podcast made easy

Copyright © 2005 Apple Computer, Inc. All rights reserved.

Powered by Mac OS X Server

**This Page is Inserted by IFW Indexing and Scanning
Operations and is not part of the Official Record**

BEST AVAILABLE IMAGES

Defective images within this document are accurate representations of the original documents submitted by the applicant.

Defects in the images include but are not limited to the items checked:

- BLACK BORDERS
- IMAGE CUT OFF AT TOP, BOTTOM OR SIDES
- FADED TEXT OR DRAWING
- BLURRED OR ILLEGIBLE TEXT OR DRAWING
- SKEWED/SLANTED IMAGES
- COLOR OR BLACK AND WHITE PHOTOGRAPHS
- GRAY SCALE DOCUMENTS
- LINES OR MARKS ON ORIGINAL DOCUMENT
- REFERENCE(S) OR EXHIBIT(S) SUBMITTED ARE POOR QUALITY
- OTHER: _____

IMAGES ARE BEST AVAILABLE COPY.

As rescanning these documents will not correct the image problems checked, please do not report these problems to the IFW Image Problem Mailbox.



UNITED STATES PATENT AND TRADEMARK OFFICE

UNITED STATES DEPARTMENT OF COMMERCE
United States Patent and Trademark Office
Address: COMMISSIONER FOR PATENTS
P.O. Box 1450
Alexandria, Virginia 22313-1450
www.uspto.gov

APPLICATION NO.	FILING DATE	FIRST NAMED INVENTOR	ATTORNEY DOCKET NO.	CONFIRMATION NO.
90/007,402	01/31/2005	5191573	NAPS001	2998
	7590	10/26/2005	EXAMINER	
Ansel M. Schwartz 425 N. Craig Street Suite 301 Pittsburgh, PA 15213			ART UNIT	PAPER NUMBER

DATE MAILED: 10/26/2005

Please find below and/or attached an Office communication concerning this application or proceeding.



UNITED STATES PATENT AND TRADEMARK OFFICE

Commissioner for Patents
United States Patent and Trademark Office
P.O. Box 1450
Alexandria, VA 22313-1450
www.uspto.gov

DO NOT USE IN PALM PRINTER

(THIRD PARTY REQUESTER'S CORRESPONDENCE ADDRESS)

Albert S. Penilla
MARTINE PENILLA & GENCARELLA, LLP
710 Lakeway Drive, Suite 200
Sunnyvale, CA 94085

EX PARTE REEXAMINATION COMMUNICATION TRANSMITTAL FORM

REEXAMINATION CONTROL NO. 90/007,402.

PATENT NO. 5191573.

ART UNIT 2132.

Enclosed is a copy of the latest communication from the United States Patent and Trademark Office in the above identified *ex parte* reexamination proceeding (37 CFR 1.550(f)).

Where this copy is supplied after the reply by requester, 37 CFR 1.535, or the time for filing a reply has passed, no submission on behalf of the *ex parte* reexamination requester will be acknowledged or considered (37 CFR 1.550(g)).

Office Action in Ex Parte Reexamination	Control No. 90/007,402	Patent Under Reexamination 5191573	
	Examiner Benjamin E. Lanier	Art Unit 2132	

-- The MAILING DATE of this communication appears on the cover sheet with the correspondence address --

- a Responsive to the communication(s) filed on 18 August 2005. b This action is made FINAL.
c A statement under 37 CFR 1.530 has not been received from the patent owner.

A shortened statutory period for response to this action is set to expire 2 month(s) from the mailing date of this letter. Failure to respond within the period for response will result in termination of the proceeding and issuance of an *ex parte* reexamination certificate in accordance with this action. 37 CFR 1.550(d). **EXTENSIONS OF TIME ARE GOVERNED BY 37 CFR 1.550(c)**. If the period for response specified above is less than thirty (30) days, a response within the statutory minimum of thirty (30) days will be considered timely.

Part I THE FOLLOWING ATTACHMENT(S) ARE PART OF THIS ACTION:

- | | |
|--|---|
| 1. <input type="checkbox"/> Notice of References Cited by Examiner, PTO-892. | 3. <input type="checkbox"/> Interview Summary, PTO-474. |
| 2. <input checked="" type="checkbox"/> Information Disclosure Statement, ^{modified} PTO-1449
(84 sheets) | 4. <input type="checkbox"/> _____ |

Part II SUMMARY OF ACTION

- 1a. Claims 1-6 are subject to reexamination.
- 1b. Claims _____ are not subject to reexamination.
2. Claims _____ have been canceled in the present reexamination proceeding.
3. Claims _____ are patentable and/or confirmed.
4. Claims 1-6 are rejected.
5. Claims _____ are objected to.
6. The drawings, filed on _____ are acceptable.
7. The proposed drawing correction, filed on _____ has been (7a) approved (7b) disapproved.
8. Acknowledgment is made of the priority claim under 35 U.S.C. § 119(a)-(d) or (f).
 - a) All b) Some* c) None of the certified copies have
 - 1 been received.
 - 2 not been received.
 - 3 been filed in Application No. _____.
 - 4 been filed in reexamination Control No. _____.
 - 5 been received by the International Bureau in PCT application No. _____.

* See the attached detailed Office action for a list of the certified copies not received.
9. Since the proceeding appears to be in condition for issuance of an *ex parte* reexamination certificate except for formal matters, prosecution as to the merits is closed in accordance with the practice under *Ex parte* Quayle, 1935 C.D. 11, 453 O.G. 213.
10. Other: _____

cc: Requester (if third party requester)

DETAILED ACTION

Response to Arguments

1. Applicant's arguments filed 18 August 2005 have been fully considered but they are not persuasive. Applicant's argument that the Freeny reference cannot be used because of a District Court decision stating that Freeny teaches away from the Applicant's claimed invention is not persuasive because that District Court decision was an analysis of Freeny as a 102 reference and not as a secondary reference.
2. Applicant's argument that none of the prior art systems survived as a consumer-oriented mass-market distribution system for digital music distribution because they lacked all of the magic ingredients present in the Hair patents is not persuasive because Applicant has not provided proof that the claimed features were responsible for the commercial success of the mentioned distribution systems (i.e. iTunes). Merely showing that there was commercial success of an article which embodied the invention is not sufficient. *Ex parte Remark*, 15 USPQ2d 1498, 1502-02 (Bd. Pat. App. & Inter. 1990). Compare *Demaco Corp. v. F. Von Langsdorff Licensing Ltd.*, 851 F.2d 1387, 7 USPQ2d 1222 (Fed. Cir. 1988). Applicant has also failed to provide proof of why previous attempts failed. Mr. Hair stated in a personal interview on 18 May 2005 that his company, Sightsound, attempted to implement the claimed invention but ultimately failed because the RIAA and MPAA would not license their music and movies for distribution on their system. In fact, only after the proliferation of illegal music downloads in the late 90's did the RIAA agree to license their artists' music for electronic distribution through systems such as Apple's iTunes, which was first launched in April of 2003. Therefore, Applicant cannot provide

any proof of why iTunes has been successful and why others have failed because the prior art systems, as discovered by Mr. Hair himself, had nothing to sell.

3. Commercial success may have been attributable to extensive advertising and position as a market leader before the introduction of the patented product, *Pentec, Inc. v. Graphic Controls Corp.*, 776 F.2d 309, 227 USPQ 766 (Fed. Cir. 1985). Apple has not only been a market leader in computer technology for over two decades but became a market leader in the digital music realm after their iPod release in October 2001. Therefore, Applicant cannot attribute the commercial success of Apple's iTunes system to the alleged use of their claimed invention when Apple was already a market leader before the system was launched.

4. Success of invention could be due to recent changes in related technology or consumer demand, *In re Fielder*, 471 F.2d 690, 176 USPQ 300 (CCPA 1973). The existence and profitability of the systems mentioned by Applicant are due to the advances in recent technology and not Applicant's claimed invention. If the latter was responsible for the success, then it stands to reason that the existence of a profitable system would have occurred earlier since Applicant's first application directed to the claimed subject matter was filed in June of 1988. At the time of Apple's iTunes launch, personal computer storage capacities were significantly larger than they were at the time of the prior art systems. Hard drives routinely come in capacities of 20 gigabytes or higher, whereas in 1988 the capacity was around 40 megabytes. Not to mention the fact that when iTunes was launched, audio file compression was advanced to the point where a file could be compressed to a third of the size with little observable quality loss. Add to that the proliferation of broadband Internet that simply did not exist at the time of prior art systems and what you have is the ability to store a significantly larger amount of music because of file size

Art Unit: 2132

and storage capacity, and the ability to acquire this music much faster. Therefore, Applicant cannot attribute the commercial success of Apple's iTunes system to the alleged use of their claimed invention when there is no reason to suggest that any of the prior art distribution system would not have been just as successful given these same advances in technology.

5. Applicant's arguments with respect to the inherency issues of Gallagher have been fully considered and are persuasive. Therefore, the rejection has been withdrawn. However, upon further consideration, a new ground(s) of rejection is made in view of Akashi.

Claim Rejections - 35 USC § 103

6. The following is a quotation of 35 U.S.C. 103(a) which forms the basis for all obviousness rejections set forth in this Office action:

(a) A patent may not be obtained though the invention is not identically disclosed or described as set forth in section 102 of this title, if the differences between the subject matter sought to be patented and the prior art are such that the subject matter as a whole would have been obvious at the time the invention was made to a person having ordinary skill in the art to which said subject matter pertains. Patentability shall not be negated by the manner in which the invention was made.

7. The factual inquiries set forth in *Graham v. John Deere Co.*, 383 U.S. 1, 148 USPQ 459 (1966), that are applied for establishing a background for determining obviousness under 35 U.S.C. 103(a) are summarized as follows:

1. Determining the scope and contents of the prior art.
2. Ascertaining the differences between the prior art and the claims at issue.
3. Resolving the level of ordinary skill in the pertinent art.
4. Considering objective evidence present in the application indicating obviousness or nonobviousness.

8. Claims 1-6 are rejected under 35 U.S.C. 103(a) as being unpatentable over Akashi, "Automated Music Purchasing System", in view of Freeny, U.S. Patent No. 4,528,643. Referring to claims 1, 3, 4, 6, Akashi discloses a system for automatically selling recorded music via telecommunication lines (Page 1 through line 1 of Page 2). This system utilizes the

Art Unit: 2132

telecommunications lines to transmit the recorded music data from a host computer that stores the recorded music data to a personal computer (Page 2 Section 4), which meets the limitation of connecting electronically via telecommunications line the first memory with the second memory such that the desired digital audio signal can pass therebetween, transmitting the desired digital audio signal from the first memory with a transmitter in control and possession of the first party to a receiver having the second memory at a location determined by the second party, said receiver in possession and control of the second party, storing the digital signal in the second memory. Akashi discloses that the digital music data is purchased automatically but does not expressly detail how the purchase is transacted. Freeny discloses a method of electronically distributing and selling audio and video data by way of having the requesting user transmit a consumer credit card number along with their request for the audio and video data (Col. 13, lines 25-29). This step allows the owner of the data to approve the sale and charge the sale to the consumer credit card number (Col. 13, lines 30-31), which meets the limitation of transferring money electronically via a telecommunications lines to the first party at a location remote from the second memory and controlling use of the first memory from the second party financially distinct from the first party, said second party controlling use and in possession of the second memory, the transferring step includes the steps of telephoning the first party controlling use of the first memory by the second party, providing a credit card number of the second party controlling the second memory to the first party controlling the first memory so the second party is charged money. It would have been obvious to one of ordinary skill in the art at the time the invention was made to have the requesting user's of Akashi transmit a consumer credit card number along with their request for the digital data so that the source unit could approve and

charge the sale of the digital data to the consumer credit card because this method of electronic sale allows the owner of the information to receive directly the compensation for sale of recording and such compensation is received before the reproduction is authorized as taught in Freeny (Col. 13, lines 36-39).

Referring to claims 2, 5, Akashi discloses that personal computer contains a CPU (Figure 1). The personal computer sends an access signal to the host computer, and the host computer returns a response signal that contains menu data displayed at the personal computer (Page 3 Paragraph 6). Using the monitor screen, the user chooses desired data using a control unit and sending the selection data to the host computer in the same way the initial transmission was sent (Page 4 Paragraph 1), which meets the limitation of the steps of searching the first memory for the desired digital audio signal and selecting the desired digital audio signal from the first memory.

Conclusion

9. A shortened statutory period for response is set for **two month** from the mailing date of this Office Action.

In order to ensure full consideration of any amendments, affidavits or declarations, or other documents as evidence of patentability, such documents must be submitted in response to this Office action. Submissions after the next Office action, which is intended to be a final action, will be governed by the requirements of 37 DFR 1.116, which will be strictly enforced.

10. The patent owner is reminded of the continuing responsibility under 37 CFR 1.565(a), to apprise the Office of any litigation activity, or other prior or concurrent proceeding, involving

Application/Control Number: 90/007,402
Art Unit: 2132

Page 7

Patent No. 5,966,440 throughout the course of this reexamination proceeding. See MPEP §§ 2207, 2282 and 2286.

11. Any inquiry concerning this communication or earlier communications from the examiner should be directed to Benjamin E. Lanier whose telephone number is 571-272-3805. The examiner can normally be reached on M-Th 7:30am-5:00pm, F 7:30am-4pm.

If attempts to reach the examiner by telephone are unsuccessful, the examiner's supervisor, Gilberto Barron can be reached on 571-272-3799. The fax phone number for the organization where this application or proceeding is assigned is 571-273-8300.

Information regarding the status of an application may be obtained from the Patent Application Information Retrieval (PAIR) system. Status information for published applications may be obtained from either Private PAIR or Public PAIR. Status information for unpublished applications is available through Private PAIR only. For more information about the PAIR system, see <http://pair-direct.uspto.gov>. Should you have questions on access to the Private PAIR system, contact the Electronic Business Center (EBC) at 866-217-9197 (toll-free).



Benjamin E. Lanier

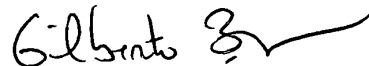

GILBERTO BARRON JR.
SUPERVISORY PATENT EXAMINER
TECHNOLOGY CENTER 2100

Modified PTO
1449

SIGHTSOUND.COM v N2K
11052/1

90/007,407
(84 sheets)

Index of Prior Art

Examiner's Initials	TAB NO.	PATENT NO.	INVENTOR	FILING DATE	DESCRIPTION
BE	1	5,428,606	Muskowitz	June 30, 1993	Invention relating to an info. network and to a digital info exchange system
BE	2	5,132,992	Yurt et al.	January 7, 1991	Audio/video transmission and receiving system
BE	3	5,130,792	Tindell et al.	February 1, 1990	Store and forward video system
BE	4	5,191,573	Hair	September 18, 1990	Method for transmitting a digital audio/video signal
BE	5	5,675,734	Hair	February 27, 1996	System for transmitting digital video/audio signals
BE	6	5,966,440	Hair	June 6, 1995 System and method for transmitting desired digital video/audio signals	
BE	7	4,999,806	Chernow et al.	September 4, 1987 Software distribution system	
BE	8	Re: 35,184	Walker	October 17, 1986 Remote transaction	

DC01 363825 v 1

Examiner's Initials	TAB NO.	PATENT NO.	INVENTOR	FILING DATE	DESCRIPTION
				system	
<i>fb</i>	9	3,244,809	Fuller et al.	February 26, 1962 Signal distribution systems	
<i>fb</i>	10	3,696,297	Otero	September 1, 1970 Broadcast communications system including a plurality of subscriber stations for selection receiving and replacing	
<i>fb</i>	11	3,718,906	Lightner	June 1, 1971 Vending system for remotely accessible store information	
<i>fb</i>	12	3,824,597	Berg	November 9, 1970 Data transmission network	
<i>fb</i>	13	3,947,882	Lightner	November 29, 1972	Vending system for remotely accessible stored information
<i>fb</i>	14	3,990,710	Hughes	March 1, 1971	Coin-operated recording machine
<i>fb</i>	15	4,028,733	Ulicki	July 7, 1973	Pictorial info retrieval system

Examiner's Initials	TAB NO.	PATENT NO.	INVENTOR	FILING DATE	DESCRIPTION
<i>BA</i>	16	4,045,776	Wheelwright et al.	April 19, 1976	Electronic phonograph selector and memory system
<i>BA</i>	17	4,108,365	Hughes	January 15, 1976	Coin-operated recording machine
<i>BA</i>	18	4,124,773	Elkins	November 26, 1976	Audio storage and distribution system
<i>BA</i>	19	4,300,040	Gould et al.	November 13, 1979	Ordering terminal
<i>BA</i>	20	4,335,809	Wain	January 29, 1980	Entertainment machines
<i>BA</i>	21	4,370,649	Fuerte	May 19, 1981	Payment responsive data network display
<i>BA</i>	22	4,422,093	Pargee	January 27, 1983	Television burst service
<i>BA</i>	23	4,499,568	Gremiller	December 13, 1982	Process for tele-distribution of recorded info and system for it
<i>BA</i>	24	4,506,387	Walter	May 25, 1983	Process for tele-distribution of recorded info and system for it
<i>BA</i>	25	4,520,404	Von Kohorn	August 23, 1982	System apparatus and method for recordings and editing broadcast transmissions
<i>BA</i>	26	4,521,806	Abraham	August 19, 1982	Recording program communication system
<i>BA</i>	27	4,521,857	Reynolds, III	May 17, 1982	Aviation weather information dissemination system
<i>BA</i>	28	4,586,430	Freeny	January 19, 1985	System for reproducing info in material objects eta paint

Examiner's Initials	TAB NO.	PATENT NO.	INVENTOR	FILING DATE	DESCRIPTION
					of sale location
<i>BR</i>	29	4,533,948	McNamara et al.	April 30, 1982	CATV Communications system
<i>BR</i>	30	4,536,856	Hiroishi	September 20, 1980	Method of and apparatus for controlling the display of video signal information
<i>BR</i>	31	4,538,176	Nakjimo et al	November 26, 1979	Buffer memory dispersion type video/audio transmission system
<i>BR</i>	32	4,567,359	Lockwood	May 24, 1984	Automatic info goods and services dispensing
<i>BR</i>	33	4,567,512	Abraham	September 28, 1983	Recorded program communication system
<i>BR</i>	34	4,605,973	Von Kohorn	March 25, 1985	System apparatus and method for recordings and editing broadcast transmission
<i>BR</i>	35	4,647,989	Geddes	March 18, 1983	Videocassette selection machine
<i>BR</i>	36	4,648,037	Valentino	March 15, 1984	Method and apparatus for benefit and financial communciation
<i>BR</i>	37	4,658,093	Hellman	July 11, 1983	Software distribution system
<i>BR</i>	38	4,667,802	Verduin et al.	October 1, 1984	Video jukebox
<i>BR</i>	39	4,672,613	Foxworthy et al.	November 1, 1985	System for transferring digital data bet. A hot device and a recording medium
<i>BR</i>	40	4,674,055	Ogaki	May 29, 1984	Software vending system

Examiner's Initials	TAB NO.	PATENT NO.	INVENTOR	FILING DATE	DESCRIPTION
<i>BR</i>	41	4,688,105	Bloch et al	May 10, 1985	Video recording system
<i>BR</i>	42	4,703,465	Parker	December 14, 1985	Method and apparatus for producing and audio magnetic tape recording from a preselected music library
<i>BR</i>	43	4,725,977	Izumi et al	February 28, 1986	Cartridge programming system and method with a central and local program library
<i>BR</i>	44	4,739,510	Jetters et al	April 2, 1982	Direct broadcast satellite signal transmission system
<i>BR</i>	45	4,754,483	Weaver	August 25, 1987	Data compression system and method for audio signals
<i>BR</i>	46	4,755,872	Bestler et al.	July 29, 1985	Impulse pay per view system and method
<i>BR</i>	47	4,759,060	Hayashi et al.	October 31, 1985	Decoder for a pay t.v. system
<i>BR</i>	48	4,761,684	Clark et al.	November 14, 1986	Telephone access display system
<i>BR</i>	49	4,763,317	Lehman et al	December 13, 1985	Digital communications network architecture for providing universal info services
<i>BR</i>	50	4,766,581	Lorn et al.	August 7, 1984	Info retrieval system an method using independent user stations
<i>BR</i>	51	4,787,050	Suzuki	November 12, 1986	Apparatus For Managing Software Bending Machine
<i>BR</i>	52	4,789,863	Bush	January 13, 1988	Pay per view entertainment system

DC01 363825 v 1

Examiner's Initials	TAB NO.	PATENT NO.	INVENTOR	FILING DATE	DESCRIPTION
RC	53	4,792,849	McCalley et al.	August 4, 1987	Digital interactive communication system
RC	54	4,797,918	Lee et al.	April 15, 1987	Subscription controller t.v. programming
RC	55	4,829,372	McCalley et al.	August 20, 1987	Presentation player
RC	56	4,894,789	Yee	February 22, 1988	TV Data capture device
RC	57	4,918,588	Barrett et al.	December 31, 1986	Office automation system w/ integrated image management
RC	58	4,949,187	Cohen	December 16, 1988	Video communication system having a remotely controlled control sources of video/audio data
RC	59	5,003,384	Durdan et al.	April 1, 1988	Set top interface transactions in an impulse pay per view t.v. system
RC	60	5,019,900	Clark et al.	August 1, 1988	Telephone access display system
RC	61	5,041,921	Schettler	December 17, 1987	System for recording custom albums from a library of pre-recorded items
RC	62	5,089,885	Clark	August 1, 1988	Telephone Access Display System With Remote Monitoring
RC	63	5,099,422	Foresman et al.	March 17, 1989	Compiling system method of producing individually customized recording media
RC	64	5,191,410	McCalley et al.	February 5, 1991	Interactive multimedia presentation and communication system

DC01 363825 v 1

Examiner's Initials	TABS	TITLE	AUTHOR	SOURCE
<i>DR</i>	65	From the newS desk	D. Needle	Info World, May 11, 1984
<i>DR</i>	66	Computer system organization: Problems of the 1980's	H. Apfelbaum, et al.	Computer Sept. 1978, Vol. II, No. 9
<i>DR</i>	67	System for capturing, storing and playing back large data bases at home	D.C. Gazis S.S. Soo	IBM Technical Disclosure Bulletin, Vol. 23, No. 2, p. 856, July 1980
<i>DR</i>	68	Jimmy Bowen: Music Row's Prophet of change	L. Chappell	Advantage, Vol.9, No. 10, p.38, October 1986
<i>DR</i>	69	Rock Around the Database	L. Dotto	Information Technal., Vol. 57, No. 9, pp. 128-135, September 1984
<i>DR</i>	70	Home (computer) terminal musical program selection	P. L. Rosenfeld	IBM Technical Disclosure Bulletin, Vol. 23, NO. 78, p 3440
<i>DR</i>	71	A Harmonious Musical Interface	S. Cunningham	Network World, Inc., September 8, 1986
<i>DR</i>	72	Electronic Orchestra in your livingroom	S. Mace	InfoWorld, March 25, 1985, p. 29
Examiner's Initials	TABS	TITLE	AUTHOR	SOURCE
<i>DR</i>	74	Cable Scan	No Author	, October 1983
<i>DR</i>	75	A review of digital audio techniques	M. Willcocks	Journal of the Audio Engineering Society, Vol. 26, No. 12, pp. 56, 58, 60, 62, 64, Jan-Feb 1978

DC01 363825 v 1

76	Digital Music Will Launch the Home Music Store	G. Gulick	Satellite News, 81-11-09, pp. 7
77	Telecommunications in the coming decades	S.B. Weinstein	IEE Spectrum, Nov 197?, p. 62
78	Electronic Banking Goes to Market	T.S. Perry	IEE Spectrum, Feb 197?, p. 46
79	Gordon Bell calls for a U.S. Research Network	G. Gordon Bell	IEEE Spectrum p. 54
80	As Patents Multiply, Web Sites Find Lawsuits Are a Click Away	S. Hansell	New York Times, Dec. 11, 1999, AI
81	The Tony Basile Home Page	The PAN NETWORK	The PAN Network, Dec 12, 1999
82	Tele computing - Direct Connections for Software Selections	E. Ferrarini	Business computer systems, Feb. 1984
83	Young Arcadians Come Home	D.N.	Info. World, Vol. 5, Number 27
84	Two way Cable System Using Residential CATV Facilities	Semir Sirazi, et al	ICCE 84, June 7, 1984, LaSalle III - Digest of Technical Papers.
85	News	D. Caruso	InfoWorld, April 16, 1984
86	Pay Per View Entertainment System	PTO	US Patent and Trademark Office, Patent Bibliographic Database, 1/26/00

DC01 363825 v 1

			Software Distribution System	PTO	US Patent and Trademark Office, patent Bibliographic Database, 1/26/00
<i>hc</i>	87				
<i>hc</i>	88		Dig-Music: An On Demand Digital Music Selection System utilizing CATV Facilities	Y. Want G.M. Campbell	IEEE Transactions on Consumer Electronics, Vol. CE 28, No. 3, August 1982, p. xvii
<i>hc</i>	89		Transmission of Musical Info. in a teletext multiplexed broadcasting system	Y. Sugimori, et al.	IEEE International Conference on Consumer Electronics, 1985 - Digest of Technical Papers.
<i>hc</i>	90		An Encrypted Digital Audio System for Conventional Cable System	K. Kitagawa, et al.	IEEE International Conference on Consumer Electronics, 1985 - Digest of Technical Papers
<i>hc</i>	91		Telephone computers - a look at the one per Desk Telecomputer	D. Pountain	BYTE U.K., June 1985
<i>hc</i>	92		Music Software for the Apple Macintosh	C. Yavelow	Computer Music Journal, Vol. 9, No. 3, Fall 1985
<i>hc</i>	93		NAPLPS Videotex Frame Creation System with Automatic Encoding of Input Images	T. Fujimori	IEEE Transactions on Consumer Electronics, Vol. CE-31, No. 3, August 1985
<i>hc</i>	94		Picture Transmission for Videotex	K. Ngan, et al.	IEEE Transactions on Consumer Electronics, Vol. CE-31, No. 3, August 1985
<i>hc</i>	95		A System for	N. Kihara, et al.	IEEE Transactions on Consumer electronics, Vol. CE-

DC01 363825 v 1

		Transmitting Electronic Photographs			28, No. 3, August 1982
96	<i>BA</i>	A Low cost High Performance Picture Display for Photovideotex	G.P. Hudson C.P. Arbuthnot		IEEE Transactions on Consumer Electronics, Vol. CE-32, August 1986
97	<i>BA</i>	The Coding of Graphics Animation in a Videotext Terminal	C. Pabouctsidis		1986 IEEE International Conference on Consumer Electronics, Digest of technical Papers, June 1986
98	<i>BA</i>	Videotext Programs Videorecorder (VPV)	U. Bensch		1984, IEEE International Conference on Consumer Electronics, Digest of technical Papers June 1984
99	<i>BA</i>	Picture Transmission for Videotex	H. Weng Cheong N. King Ngi		1988, IEEE International Conference on Consumer Electronics, Digest of technical Papers June 1988 Digital Still Picture Recorder Utilizing an Ordinary Audio Cassette Deck S. Kageyama, et al. 1985 IEEE International Conference on Consumer Electronics, Digest of technical Papers, June 1985
100	<i>BA</i>	Digital Still Picture Recorder Utilizing an Ordinary Audio Cassette Deck	S. Kageyama, et al.		1985 IEEE International Conference on Consumer Electronics, Digest of Technical Papers, June 1985
101	<i>BA</i>	A New digital Audio and Data Transmission System Using the CATV Network	Y. Kojima, et al.		IEEE Transactions on Consumer Electronics, Vol. CE-30, No. 3, August 1984
		A Simple Technique for	N.D. Jotwani		IEEE Transactions on Consumer Electronics, Vol. CE-

<i>BL</i>	102	Video Image Transmission	K.L. Mong	33, No. 1, February 1987
<i>BL</i>	103	Third Party Profile: Control Video Corporation	no author	Control Video Corp. Web Site
<i>BL</i>	104	Dial-A-Game-GameLine module links WCS With Game.Bank	D. Burns	Digital Antic, Vol. 2, No. 4, July 1983, p. 82
<i>BL</i>	105	Remembering the GameLine	D. Skelton	http://ccwf.ccutexas.edu
<i>BL</i>	106	Digitalized Voice Comes of Age Part 1 - Trade Offs	B. Occhiogrosso	Data Communications, March 1978
<i>BL</i>	107	A New Digital Audio and Data Transmission System Using the CATV Network	Y. Kojima, et al.	IEEE Transactions on Consumer Electronics, Vol. CE-30, No. 3, August 1984
<i>BL</i>	108	A Packet Video/Audio System Using the Asynchronous Transfer Mode Technique	H.J. Chao, et al	IEEE Transactions on Consumer Electronics, Vol. 35, No. 2, May 1989
<i>BL</i>	109	Digital Audio Data Transmission in a Coaxial Cable Environment	R. Scheuerer, et al	IEEE Transactions on Consumer Electronics, Vol. 35, No. 2, May 1989? (Illegible)
<i>BL</i>	110	Transmission of Musical info, in a Teletext Multiplexed Broadcasting system	Y. Sugimori, et al	IEEE Transactions on Consumer Electronics, Vol. CE-29, No. 3, August 1983









<i>BL</i>	111	4004 Futures for Teletext and Videotex in the US	R.P. Plummer, et al	IEEE Transactions on Consumer Electronics, Vol. CE-25, No. 3, July 1979
<i>BL</i>	112	Teletext/Viewdata LSI	B. Harden, et al.	IEEE Transactions on Consumer Electronics, Vol. CE-25, No. 3, July 1979
<i>BL</i>	113	Prestel - the World's First Public View data Service	R.D. Bright, et al.	IEEE Transactions on Consumer Electronics, Vol. CE-25, No. 3, July
<i>BL</i>	114	Teletext and Viewdata (costs as Applied to the US Market	G.O. Crowther	IEEE Transactions on Consumer Electronics, Vol. CE-25, No. 3, July 1979
<i>BL</i>	115	Telidon - A Review	H. Brown W. Sawchuk	IEEE Communications Magazine, Jan 1981
<i>BL</i>	116	Videotex Services: Network and Terminal Alternatives	J.M. Costa A.M. Chitnis	IEEE Transactions on Consumer Electronics, Vol. CE-25, No. 3, July 1979
<i>BL</i>	117	System and Hardware Considerations of Home Terminals With Telephone Computer Access	J. Blank	IEEE Transactions on Consumer Electronics, Vol. CE-25, No. 3, July 1979
<i>BL</i>	118	Profile - Career Update		Key board News, April 1985
<i>BL</i>	119	Telecommunications - Let Your Telephone Do the Sampling	B. Tolinski	KSC, April 1986
<i>BL</i>	120	PAN: Meeting Place for the Industry	P. Leopold	Electronic Musician, Sept. 1986

121	<i>bc</i>	A Harmonious Musical Interface - Instrument Connectivity is Music to Composer's ears.	S. Cunningham	Networld World, Sept 8, 1986 (Vol. 3, No 27)
122	<i>bc</i>	Teaching Computers to Emulate Bach	J.S. Newton	The New York Times, Sunday, March 1, 1987
123	<i>bc</i>	Getting Into PAN	S. Lloyd	Sonics (nothing else appears)
124	<i>bc</i>	MIDI By Modem: The Future in Now	P. Leopold	Conference Paper - Music and Digital Technology
125	<i>bc</i>	The Information Source of the Future is Online now: Electronic Bulletin Boards	G. Armbruster	Keyboard Magazine, Dec 1985
126	<i>bc</i>	MIDI - Musical Instrument Digital Interface	J. Aikin	Keyboard Magazine, January 1986
127	<i>bc</i>	MIND Over MIDI - Diary of a Mad MIDI Specialist	J. Cooper	Keyboard Magazine, June 1986
128	<i>bc</i>	Cover of the KEYBOARD MAGAZINE and Advertisement from Hybrid Acts, Inc.		Keyboard Magazine, July 1986
129	<i>bc</i>	What is Musical Property? - The Ethics of Sampling	S. Alvaro	Keyboard Magazine, October 1986

<i>BL</i>	130	Collection of MIDI Stereo Advertisements			Electronic Musician, Vol. 5, No. 2, Feb 1989
<i>BL</i>	131	In the Public Eye: Free Atari Software	J. Johnson		Electronic Musician, Vol. 5, No. 10, October 1989
<i>BL</i>	132	Going Online - A Guide to elec. Bulletin board System	M. Rivers		Electronic Musician, Vol. 6, No. 11, November 1990
<i>BL</i>	133	*Page of EM Classifieds			Electronic Musician, November 1989
<i>BL</i>	134	Advertisements			Electronic Musician, August 1989
<i>BL</i>	135	EM Classifieds			Electronic Musician, July 1989
<i>BL</i>	136	Advertisements			Electronic Musician, July 1989
<i>BL</i>	137	Start Me Up? - the Music Biz Meets the personal computer	B. Krepack R. Firestone		Published by Medioc Press, Copyright 1986
<i>BL</i>	138	A Harmonious Musical Interface	S. Cunningham		1986 Network world, September 8, 1986
<i>BL</i>	139	Synth - Bank	USPTO		USPTO - Trademark Text and Database
<i>BL</i>	140	Managing the Intellectual Property Lifecycle	B. Bell A. Brown, Jr.		A excerpt from an article available at Synthbank.com 1998, Synthbank, Inc.
<i>BL</i>	141	*List of E-Bulletin Boards with an attached EM page of ads			ON-line Resources/Electronic Bulletin Boards
<i>BL</i>	142	An Upbeat Way to Order; worth watching	G. Charlish		1988 The Financial Times (Lexis-Nexis)

		MUSICNET	USPTO	USPTO - Trademark
143				
144		PC Forum Attendees Call for Cooperation with Government	S. Higgins	Westlaw, Monday, March 1, 1993
145		Data Highways... Can we get there from here?	J. Burgess	The Washington Post, May 2, 1993 (Lexis-Nexis)
146		MNI Interactive to Revolutionize the Way Consumers Select and Purchase Entertainment Products		PR Newswire Association, Jan 17, 1994
147		The Interactive Age - Can The Exalted Vision Become a Reality?	M. W. Miller	The Wall Street Journal, Thursday, Oct 14, 1993
148		Music Net Let's Consumer's Fingers do the Walking	J. McCullaugh	Billboard, Saturday, October 16, 1993 (Westlaw)
149		"Rolling Stone" Takes Music to The Phone	S. Donaton A. Z. Cuneo	Advertising Age, July 11, 1994 (Lexis-Nexis)
150		Most Silicon Valley Ventures Beat the Odds	S. Herhold	Knight - Ridder Tribune Business News, Feb. 14, 1999
151		*Entire September Issue		Electronic Musician, Sept. 1986
152		Digit Download - Guidelines for the Architecture of Audio Technical		Preliminary White Paper Version 1.0 March 2, 1999 (CDN 03994-004038)

			Facilities at an Online Music Retail Site			
	153	<i>BL</i>	US Patent No. 4, 999, 806	Software distribution system	USPTO	
	154	<i>BL</i>	US Patent No. 4, 359, 223	Interactive video playback system	USPTO	
	155	<i>BL</i>	USPTO Certificate of Correction - Patent No. 4, 528, 643	System for Reproducing information in material objects at a point at sale location	USPTO	
	156	<i>BL</i>	The Telharmonium: An Early Breakthrough in Electronic Music	T. Holmes	Gyrofrog Communications Electronic and Experimental Music 1996	
	157	<i>BL</i>	Free Music Downloads	CDNow	CDNow Web Site (CDN 000078-85)	
	158	<i>BL</i>	Gameline - the Incredible New Way to Play Video Games		Gameline brochure	
	159	<i>BL</i>	Downloading and Tele-delivery of Computer Software, Music and Video		International Resource Development, Inc. (DN 021217-021432)	
	160	<i>BL</i>	Downloading and Tele-		International Resource	

			delivery of Computer Software, Music and Video		Development, Inc. July 1983 (CDN:021433-021664)
	161		The Development of a Commercial Tele software Service	A. Sweet	Tele software Cavendish Conference Center 27-28 Sept. 1984. Publication No. 60 [61] Institution of Electronic and Radio Engineers
	162		Tele software - The Computer in Your TV set	J. Hedger	New Electronics, Vol. 13, No. 245, December 9, 1980
	163		Tele Software: Adding Intelligence to Teletext	R. Eason J. Hedger	Proceedings IEEE, Vol. 126, No. 12, December 1979
	164		Receiving Tele Software With CCT	J.R. Kinghorn	Tele software Cavendish Conference Center 27-28 Sept. 1984. Publication No. 60 [61] Institution of Electronic and Radio Engineers
	165		Games Tele Software on Cable	T.J. Havelock	Tele software Cavendish Conference Center 27-28 Sept. 1984. Publication No. 60 [61] Institution of Electronic and Radio Engineers
	166		Broadcast Tele Software Experience With ORACLE	J. Hedges	View data and Videotext, 1980-1981: A Worldwide Report
	167		The UK Teletext Standard for Tele Software Transmissions	D.J. Rayer	View data and Videotext, 1980-1981: A Worldwide Report
	168		Music from the skies promised by firm serving	S. Chase	The Washington Post, October 19, 1981

DC01 363825 v 1

			cable users				
169	<i>BL</i>	Abstract -		L. Landro	The Wall Street Journal, October 14, 1981		
170	<i>BL</i>	Abstract -		No author listed	UPI - October 13, 1981		
171	<i>BL</i>	Hi-Tech <i>do-Dads</i> for the man of the house		No author listed	Trends		
172	<i>BL</i>	New Products Programmed for Consumers		No author listed	Computer Report		
173	<i>BL</i>	Electronics show had variety of new home equipment		No author listed	Hi-Fi News and Record Reviews, 1985		
174	<i>BL</i>	New Telerecording Method for Audio		No author listed	BM/E, October 1985		
175	<i>BL</i>	Cable TV Moves To The Music		A.L. Yarrow	NY Times, July 4, 1982		
176	<i>BL</i>	What is Stalling the Record Business?		No author listed	Business Week, November 30, 1981		
177	<i>BL</i>	Labels Gear Up For Home Music Store		No author listed	Billboard Magazine, April 6, 1991		
178	<i>BL</i>	The Record Shop of the Future May Be In Your Parlour		Hans Fantel	NY Times, November 22, 1981		
179	<i>BL</i>	The Latest Technology		R. Harrington	Washington Post, June 28, 1981		
180	<i>BL</i>	Thaddeus Cahill and the		No author listed	http://nicemusic4.music.niu.edu		

			Telharmonium (electric instrument)			
181	<i>BL</i>		Thaddeus Cahill's Dynamophone\Telharmonium (1897)	No author listed		http://www.obsolete.com
182	<i>BL</i>		Book Review: Magic Music From The Telharmonium	P. Hertz		http://www.obsolete.com
183	<i>BL</i>		Telharmonium	No author listed		http://www.britannica.com
184	<i>BL</i>		Keyboard and Tactile Interfaces	No author listed		In The Third Person, October 1999
185	<i>BL</i>		No Time To Shop For Software	J. Paioff		Infoworld, August 20, 1984
186	<i>BL</i>		Warner Amex QUBE Cable Communications	No author listed		http://www.electricblue.com
187	<i>BL</i>		A Blast From The Past	P. Conger		http://www.cableworld.com , March 28, 1998
188	<i>BL</i>		Where Is Everyone Now	No author listed		http://www.electricblue.com
189	<i>BL</i>		Juke Box History 1934 thru 1951	Gert Almind		http://www1.jukebox.dk
190	<i>BL</i>		The Shyvers Multiphone	No author listed		http://www.dyz.com
191	<i>BL</i>		Dead Medium: Telephonic Jukeboxes: The Shyvers Multiphone...	B. Sterling		http://www.wps.com

192	Downloading and Teledelivery of computer software, games, music, and video	Int'l. Resource Dev. Inc.	US Copyright Application, Registration I-243-407
193	Compusonics Digitizes Phone Lines	No author listed	Digital Audio, September 1985
194	AT&T Demo	No author listed	Pro Sound News, September 9, 1985
195	Videogames and Electronic Toys		Int'l Resources Dev. Inc., May 1983
196	Compusonics Eyes Options; Will Flagship Computer Make Direct CD Copies?	M. Harrington	Information Access Co., March 30, 1987
197	Direct Broadcast's Potential For Delivering Data Service	E. Holmes	Data Communications, September 1984
198	Sonus Music Products	C. Roads	Computer Music Journal, Spring 1987
199	Advertisement: Gameline package		http://www.geocities.com
200	Computer Music Networks	C. Roads	Computer Music Journal, Fall 1986
201	Announcements	C. Roads	Computer Music Journal, Summer 1986
202	CVC Gameline Master Module	No author listed	http://ccwf.cc.utexas.edu

Examiner's Initials	TAB NO.	PATENT NO.	INVENTOR	FILING DATE	DESCRIPTION
<i>HL</i>	203	Oregon Corporate Records	Re: Synth-Bank	Oregon Secretary of State	
<i>HL</i>	204	Lexis Search Manual (Entire Manual)			
<i>BL</i>	205	Affidavit of Edgar Magnin and Exhibits		US Dist Ct for the Southern Dist. Of New York	
<i>BL</i>	206	Transcript: Max Conference		02/27/93	
<i>BL</i>	207	Exhibits To Compuserve's Brief On Claim Interpretation	Jones, Day, Reavis & Pogue	Filed in US Dist. Ct. For The Southern Dist. Of New York	
<i>HL</i>	208	4,359,223	Baer et al.	November 1, 1979	Interactive Video Playback System
<i>HL</i>	209	4,636,876	Schwartz	September 17, 1984	Audio Digital Recording and Playback System
<i>HL</i>	210	4,755,889	Schwartz	August 12, 1986	Audio and Video Digital Recording and Playback System
<i>BL</i>	211	4,559,570	Schwartz	May 14, 1984	Magnetic Storage System
<i>BL</i>	212	4,758,908	James	September 12, 1986	Method and Apparatus For Substituting A Higher Quality Audio Soundtrack For A Lesser Quality Audio Soundtrack During Reproduction Of The Lesser Quality Audio Soundtrack And A Corresponding Visual Picture

Examiner's Initials	TAB NO.	PATENT NO.	INVENTOR	FILING DATE	DESCRIPTION
<i>HL</i>	213	5,307,456	Mackay	January 28, 1992	Integrated Multi-Media Production And Authoring System
<i>HL</i>	214	4,675,904	Silverman	August 11, 1983	Method For Detecting Suicidal Predisposition
<i>HL</i>	215	4,682,248	Schwartz	September 17, 1985	Audio and Video Digital Recording Playback System
<i>HL</i>	216	4,472,747	Schwartz	April 19, 1983	Audio-Digital Recording And Playback System
Examiner's Initials	TAB NO.	DESCRIPTION	AUTHOR	PUBLICATION	
<i>HL</i>	217	AES Presentations		AES Preprints	
<i>HL</i>	218	Brochure; Overview articles, etc on PAN	PAN Network		
<i>HL</i>	219	Brochure: NERAC			
<i>HL</i>	220	CompuSonics DSP-1000 World's First DARPS		CompuSonics Advertisement	
<i>HL</i>	221	We Mean Business	C.S. Kaplan	Con. Elec. Daily, May 10, 1984	
<i>HL</i>	222	Letter to Shareholders	D. Schwartz	CompuSound, Inc. January 6, 1984	
<i>HL</i>	223	Letter to Shareholders	D. Schwartz	CompuSound, Inc., April 6, 1984	
<i>HL</i>	224	Letter to Shareholders	D. Schwartz	CompuSound, Inc., July 16, 1984	
<i>HL</i>	225	Letter to Shareholders	D. Schwartz	CompuSound, Inc., May 31, 1985	

Examiner's Initials	TAB NO	DESCRIPTION	AUTHOR	PUBLICATION
BL	226	Manufacturing Update		Audio Video Inter. June 1984
BL	227	CompuSonics Fuses Computer, Audio Into "Worlds First" HDR	M. Golden	CES Trade News Daily, June 4, 1984
BL	228	Digital Sound Now on Computer Disks	S. Booth	Consumer Elec. Daily, June 3, 1984
BL	229	CompuSonics Reads Floppy disc to record.....		HFS Newspaper, June 4, 1984
BL	230	Floppy disc may be the next music Makers		Business Week, May 28, 1984
BL	231	CompuSonics: Another Digital Audio Std	N. Weinstock	MIX, August 1984
BL	232	The State of RCA		TV Digest, May 21, 1984
BL	233	CompuSonics DSP-1000....		CES Exhibition - D&E, 1984
BL	234	Optical -Disk based Digital Audio System	B. Robinson	Electronic Engineering Times, September 1, 1986
BL	235	Brochure - CompuSonics DSP-1000		CompuSonics Corp.
BL	236	Business Plan Overview		CompuSonics, Corp., June 14, 1984
BL	237	CompuSonics Corp. Corporate Profile		Audio Video International
BL	238	Toward Electronic Delivery of Music	J.P. Stautner	CompuSonics Corp.
BL	239	Company sees Future in Digital	J. Hendon	Rocky Mountain News, July 22, 1984
BL	240	Floppy-Disk Audio System	A. Mereson	Science Digest, November 1984
BL	241	Recording Music on Floppy Discs	A. Zuckerman	High Technology, May 1984

Examiner's Initials	TAB NO.	DESCRIPTION	AUTHOR	PUBLICATION
<i>DS</i>	242	Digital Recording System Uses floppy - discs		Audio Times, May 1984
<i>DS</i>	243	Brochure		Compusonics Corp.
<i>DS</i>	244	Hi-Fi Floppy	CADES	P.C. World, April 1985
<i>DS</i>	245	New Hi-Fi Horizons	D. Canada	Stereo Review, December 1984
<i>DS</i>	246	Specs. And Implem. of computer Audio console for Digital Mixing and Recording	D. Schwartz	AES 76th Convention, NYC, June 20, 1984
<i>DS</i>	247	A High Speed Telecommunications Interface for Digital Audio Transmission and Reception	H. H. Sohn	Compusonics Corp.
<i>DS</i>	248	The Audio Computer and its applications	Schwartz & Stautner	Compusonics Corp.
<i>DS</i>	249	Engineering Your Own Digital Audio Broadcast System	D. Schwartz	Compusonics Corp.
<i>DS</i>	250	Memo: To Mr. Kapp; from D. Schwartz	D. Schwartz	CompuSonics Corp., April 26, 1990
<i>DS</i>	251	CompuSonics DSP 2002 - Preliminary User Manual		CES, June 1984
<i>DS</i>	252	Digital Mark. Corp. Video Real Estate System	JPS	CompuSonics Corporation
<i>DS</i>	253	Memo: to Holmbraker et al.	D. Schwartz	CompuSonics Corporation
<i>DS</i>	254	Assembly Procedure for DS 1500		CompuSonics Corporation

Examiner's Initials	TAB NO	DESCRIPTION	AUTHOR	PUBLICATION
<i>BC</i>	255	Application Notes: CSX Digital Signaling Processing		CompuSonics Corporation
<i>BC</i>	256	DMS Lecture		CompuSonics Corporation, 1991
<i>BC</i>	257	Application Notes: DSP 1000 Digital Audio Disc Recorder		CompuSonics Corporation
<i>BC</i>	258	Automated Merchandising System for Computer Software, Patent #4,949,257	Orbach	USPTO
<i>BC</i>	259	Letter to E. Kraeutler, Esq. Re: CDNews/Liquid Audio	I. Gross	Wilson, Sonsini, Goodrich and Rosati - April 14, 2000
<i>BC</i>	260	Patent License Agreement	Schoen & Hooban	Ergon Technology Associates Corp.
<i>BC</i>	261	The Home Terminal		IRD, Inc., August 1978
<i>BC</i>	262	RoIm Plugs CBX Into		EMMS - May 2, 1983
<i>BC</i>	263	Employee Non-Competition Agreement		CDNow, Inc.
<i>BC</i>	264	Letter to D. Berl, Esq.	K.J. Choi	Lucent Technologies
<i>BC</i>	265	Video Explosion on the way for buyers	M. Galligan	US News and World Report, June 18, 1984
<i>BC</i>	266	Hi-Fi in the '80's : Not only Alive and well.....	L. Feldman	Information Access Co., July 1984
<i>BC</i>	267	The Search for the Digital Recorder	B. Dumaine	Time, Inc., November 12, 1984
<i>BC</i>	268	Ultimate Integration: Putting Software theory into.....	J. Balga	Information Access Co., February 12, 1985

Examiner's Initials	TAB NO.	DESCRIPTION	AUTHOR	PUBLICATION
<i>BL</i>	269	Technology Review	R. Welch	The American Banker, December 12, 1986
<i>BL</i>	270	Remembering the Gameline	D. Skelton	www.mindspring.com
<i>BL</i>	271	Gameline Module links with game bank	D. Burns	www.atarimagazines.com
<i>BL</i>	272	Allison 7 Video	Allison	EE 380 2/18/87
<i>BL</i>	273	Telesoftware - Value Added Teletext	J. Hedger	IEEE Transactions on Consumer Electronics; Feb 1980, Volume CE-26
<i>BL</i>	274	Telesoftware: Home Computing Via Broadcast Teletext	J. Hedger	IEEE Transactions on Consumer Electronics; July 1999, Volume CE-25, No. 3
<i>BL</i>	275	The Future of Television as The Home Communications Terminal		International Resource Development Inc., August 1981 (CDN 23101 - 23109)
<i>BL</i>	276	Videogames & Electronic Toys	<u>note</u>	International Resource Development., INC May 1983 (CDN 023054)
<i>BL</i>	277	Telepay vs. Videodisc		International Resource Development INC., September 1982 (CDN 023068)
<i>BL</i>	278	Health, Wealth & Self-Improvement Home Software		International Resource Development INC., September 1985 (CDN 023091)
<i>BL</i>	279	Telecommunications Market Opportunities		International Resource Development INC., November 1985 (CDN 023110-023138)
<i>BL</i>	280	VideoPrint (Contents)		June 22, 1983 (CDN 023139-23142)

Examiner's Initials	TAB NO.	DESCRIPTION	AUTHOR	PUBLICATION
<i>BL</i>	281	CompSonics/Carts		September 9, 1985 (CDN 023143)
<i>BL</i>	282	Current Samples (Compusonics Digitizes Phone Lines)		September 1985 (CDN 023144)
<i>BL</i>	283	(BME) Station Automation (New Telerecording Method for Audio)		October 1985 (CDN 023145-23146)
<i>BL</i>	284	High-Tech do-Dads for the man of the house (Sound Investments)		(CDN 023147-23150)
<i>BL</i>	285	New Software (Delivery over the phone)		Telephone Software Connection INC. October, 1982 (CDN023151)
<i>BL</i>	286	Communications (No time to shop for software)	Jessica Paioff	August 20, 1984 (CDN023152)
<i>BL</i>	287	Warner Amex QUBE Cable Communications	Peggy Conger	(CDN 023153-023157)
<i>BL</i>	288	Warner Amex QUBE Cable Communications (Articles)		(CDN 023158)
<i>BL</i>	289	QUBE-ists (Where is everyone now?)		(CDN 023159-23160)
<i>BL</i>	290	THE SHYVERS MULTIPHONE		(CDN023161-23162)
<i>BL</i>	291	Dead medium: Telephonic Jukeboxes: The Shyvers Multiphone (MULTIPHONE)		(CDN 023163-23166)

Examiner's Initials	TAB NO.	DESCRIPTION	AUTHOR	PUBLICATION
<i>BL</i>	292	Jukebox History 1934-1951		(CDN 023167-23173)
<i>BL</i>	293	New Music Box (Keyboard and Tactile Interfaces)		October 1999 (CDN 023174-23180)
<i>BL</i>	294	Britannica.com (telharmonium)		(CDN 023181)
<i>BL</i>	295	Book Review (Magic Music from the Telharmonium)	Paul Hertz	The Scarecrow Press. Inc.,(CDN.023182)
<i>BL</i>	296	Thaddeus Cahill (Dynamophone/Telharmonium) 1897		(CDN 023183-23186)
<i>BL</i>	297	Thaddeus Cahill and the Telharmonium (electric instrument)		(CDN 023187-23189)
<i>BL</i>	298	Style (The Latest Technology)	Richard Harrington	June 28,1981 (CDN 023190-23191)
<i>BL</i>	299	Financial		October 13,1981 (Tuesday) (CDN 023192)
<i>BL</i>	300	Labels Gear Up For "Home Music Store"	Earl Paige Ken Terry Bill Holland	April 6, 1991 (CDN 023193-23194)
<i>BL</i>	301	ABSTRACT (Home Music Store)	Laura Landro	October 14,1981 (Wednesday) (CDN 023195)
<i>BL</i>	302	Washington Business (Music From the Skies Promised By Firm Serving Cable Users)	Scott Chase	October 19,1981 (Monday) (CDN 023196)
<i>BL</i>	303	Arts and Leisure Desk (Sounds:The Record)	Hans Fantel	November 22, 1981 (Sunday) (CDN

Examiner's Initials	TAB NO.	DESCRIPTION	AUTHOR	PUBLICATION
		Shop Of The Future May In Your Parlor)		023197-23199)
HL	304	MEDIA & ADVERTISING (What is stalling the record business)		November 30, 1981. (Industrial Edition) (CDN 023200-23202)
HL	305	Financial Desk (CABLE TV MOVES TO THE MUSIC	Andrew L. Yarrow	July 4, 1982 (L. City Final Edition) (CDN 023203-23204
HL	306	TSC WRITE-UPS		(CDN 023552)
HL	307	Telephone Software Connection, Inc. (The Hayes Micromodem II)		(CDN 023553-23554
HL	308	TSC Bibliography (CALL-APPLE)		(CDN 023556-23567)
HL	309	COMPUTERS (TELEPHONE SOFTWARE CONNECTION)		(CDN 023559)
HL	310	ARTICLE REFERENCES (NOW YOUR HOME)		POPULAR MECHANICS, March 1981. (CDN 023555-23568)
HL	311	Buyers Guide (BRANCH CENTERS)		(CDN 023569-23570)
HL	312	News Link (Software delivery now at 2400 baud)		December 1985. (CDN 023571)
HL	313	TELEPHONE SOFTWARE CONNECTION		(CDN 023572-23573)
HL	314	Software (Online Tip)		(CDN 023574)
HL	315	TELECOMMUNICATING (PC-TALK.III)		(CDN 023575)
HL	316	POLL(Adults believe children know more	Lawrence	October 16, 1985. (CDN 023576)

Examiner's Initials	TAB NO	DESCRIPTION	AUTHOR	PUBLICATION
		about computers)	Kilman	
BE	317	Electronic Mail (TELEPHONE SOFTWARE CONNECTION)		(CDN 023577)
BE	318	Data Communications (PROTECTING YOUR NETWORK DATA)	Elisabeth Horwitt	(CDN 023578)
BE	319	To Catch A Thief (Microcomputer)		July 1985.(CDN 023579-23583)
BE	320	Caller Response (Services) (Shopping for software at home, by phone)		(CDN 023584)
BE	321	ON LINE CONSULTING (PLANNING, PROGRAMMING & TRAINING)		(CDN 023585)
BE	322	Entry (Entry goes on line!)		(CDN 023586)
BE	323	UNIQUE (2000 New Articles Screened Each Day)		(CDN 023587)
BE	324	Entry (Entry Magazine)		(CDN 023588)
BE	325	Satin and lace, and a message base (A board is a board)	Dru Simon	(CDN 023589)
BE	326	REFLECTIONS (on the videotex industry)	Carole Houze Gerber	(CDN 023590)
BE	327	SOFTWARE ONLINE (HELP FOR DISABLED COMPUTER USERS)		(CDN 023591)
BE	328	Telescan Analyzer & Telescan Database		December 1984. (CDN 023592)

Examiner's Initials	TAB NO.	DESCRIPTION	AUTHOR	PUBLICATION
BL	329	Reader Service (Phone secretary II)		December 1984. (CDN 023593-23595)
BL	330	Communications Software (Software Communications Inc.)		November 1984 (CDN 023596-023601)
BL	331	COMMUNICATIONS (No time to shop for software?)	Jessica Paioff	August 20, 1984 (023602)
BL	332	Link (Telephone Software)		May 1984. (CDN 023603-23621)
BL	333	Sample of Available Graphics Programs (Manufacturer)		October 1984 (CDN 023607)
BL	334	RAM Required		October 1984 (CDN 023608)
BL	335	TELECOMMUNICATING	Art Kleiner	Spring 1984 (CDN 023610-23611)
BL	336	WHOLE EARTH RECOMMENDED TELECOMMUNICATION TOOLS (TERMINAL PROGRAMS)		February 1984 (CDN 023612-23613)
BL	337	MITE (Finding MITE)		Spring 1984 (CDN 023614-23618)
BL	338	ELECTRONIC MAIL PROGRAMS (MCI Mail)		Spring 1984 (CDN 023619)
BL	339	COMPUTER CONFERENCING SYSTEMS (CompuServe Special Interest Groups (SIGs))		Spring 1984 (CDN 023620)
BL	340	UNCORRECTED PAGE PROOF (HOW RO GET FREE SOFTWARE)	Alfred Glossbrenner	(CDN 023622)
		The Treasure Trove (Comments; Diversi-		

Examiner's Initials	TAB NO	DESCRIPTION	AUTHOR	PUBLICATION
EA	341	DOS)		DSR,INC (CDN 023623-23630)
EA	342	In Search of the Consummate Time Manager (Effective Management)	Margaret P. Ezell	(CDN 023631-23632)
EA	343	Display (meet, report, sell, plan)		(CDN 023633)
EA	344	TURNING POINT (TIME IS MONEY)		(CDN 023634)
EA	345	LECTION		May 1984 (CDN 023635-23636)
EA	346	GETTING ON COMMUNI (PROVEDERS AND CONSUMERS)	Ed Magnin	Telephone Software Connection, Inc. March 1984 (CDN 023637-23638)
EA	347	Telecommunications (A Software Vending Machine)	Ed Magnin	Telephone Software Connection, Inc. March 1984 (CDN 023639)
EA	348	Telecommunications (Auto Modem)	Michael J.O'Neil	March 1984 (CDN023640)
EA	349	Micro Software Distribution (Now, Software Is Distributed By Wire	Ronald R. Cooke	November 1983 (CDN 023642)
EA	350	References :Offices and Numbers.		1984 (CDN 023643-23660)
EA	351	SOFTALK (SubLogic)		December 1983 (CDN 023661-23676)
EA	352	THE TRS CONNECTION		November 1983 9CDN 023677-023679)
EA	353	Display (THE ACCESS UNLIMITED MICRO SHOPPING CENTER)		November 1983 (CDN 023680)
EA	354	Telecommunications (Telecommunications Adviser)	Ed Magnin	Telephone Software Connection Inc. November 1983 (CDN 023681-23682)

Examiner's Initials	TAB NO.	DESCRIPTION	AUTHOR	PUBLICATION
BL	355	Communications (Special Delivery Software)	Lisa B. Stahr	October 1983 (CDN 023683-23686)
BL	356	PLUMB (EMPLOYMENT WANT ADS GO ONLINE)		June 1983 (CDN 23688-23695)
BL	357	Apple's New Image		(CDN 023696)
BL	358	Tech (Lisa And Software Writers- No Love At First Byte?)	Jessica Schwartz	(CDN 023697-23698)
BL	359	Display (DATAMOST)		(CDN 023699)
BL	360	Cider (What's New This Month)		June 1983 (CDN 023700-23701)
BL	361	Display (2ND Generation Spreadsheet)		(CDN 023702)
BL	362	Telecommunications (Telecommunications Adviser)	Ed Magnin	Telephone Software Connection Inc. June 1983 (CDN 023703-23704)
BL	363	Cider BOOK SHELF		June 1983 (CDN 023705-23706)
BL	364	Telecommunications (Telecommunications Adviser) "Acoustic"	Ed Magnin	Telephone Software Connection Inc. June 1983 (CDN 023707-23709)
BL	365	Downloader's Supermarket		June 1983 (CDN 023710)
BL	366	LETTERS (Krell Responds to review of LOGO)		(CDN 023711)
BL	367	Display (Apple Orchard) Peelings II responds.		November 2 1983 (CDN 023712-23713)

Examiner's Initials	TAB NO.	DESCRIPTION	AUTHOR	PUBLICATION
<i>BL</i>	368	Display (NIBBLE IS TERRIFIC)		(CDN 023714)
<i>BL</i>	369	TECHNOLOGY (Electronic Software Delivery Threatens Mail And Store Sales)	William M. Bulkeley	April 11, 1983 (CDN 023716-23717) THE WALL STREET JOURNAL
<i>BL</i>	370	ET PHONES OFFICE (Electronic Transfer)		April 1983 (CDN 023718-23721) The Digest
<i>BL</i>	371	Western Union's Easylink Gets Direct Telex-To-PC Connection		March 21, 1983 (CDN 023722) Information System News
<i>BL</i>	372	The Book Of Software		1983 (CDN 02723-23725)
<i>BL</i>	373	SOFTALK CLASSIFIED ADVERTISING (THE PREDICTOR)		April 1983 (CDN023726-23729) SOFTALK
<i>BL</i>	374	Programs boogie with-o-tech (Sales styles and marking strategies: A hard look at software)	Joanne Cleaver	(CDN023730-23731) HOME COMPUTER
<i>BL</i>	375	MARKETING MOVES (Information services move modems)	Deborah de Peyster	March 7 1983 (CDN 023733) ISO WORLD
<i>BL</i>	376	Computer-Based Business Files (Available file transfer software)		March/April 1983 (CDN 023734-23735)
<i>BL</i>	377	CHAPTER II USING YOUR THUNDERCLOCK PLUS (APPLICATIONS SOFTWARE PACKAGES SUPPORTING THE THUNDERCLOCK PLUS)		(CDN 023736)
<i>BL</i>	378	THUNDERCLOCK PLUS (USER'S		(CDN 023737)

Examiner's Initials	TAB NO.	DESCRIPTION	AUTHOR	PUBLICATION
		GUIDE)		
<i>DL</i>	379	Pinball wizardry's gone electronic (the home computer)	Duane Sandul	(CDN 023738)
<i>DL</i>	380	Programmed to trim that waistline (the home computer)	Duane Sandul	February 5, 1983 (CDN 023739)
<i>DL</i>	381	High adventure (the home computer)	Duane Sandul	(CDN 023740)
<i>DL</i>	382	VARIATION ON A THEME		December 1982 (CDN 023742)
<i>DL</i>	383	PROGRAMMERS LIBRARY	Paul Leighton	December 1982 (CDN 023743-23744)
<i>DL</i>	384	THE ARCADE MACHINE (INTRODUCTION)	Chris Jochumson Doug Carlston	(CDN 023745)
<i>DL</i>	385	Telephone Transfer II (INTRODUCTION)	Leifhton Paul Ed Magnin	November 1982 (CDN 023746)
<i>DL</i>	386	PRINTOGRAPHER (INTRODUCTION)	Stephen Billard	(CDN023747)
<i>DL</i>	387	CONNECTING YOUR COMPUTER TO A MODEM: WHERE TO START	Bill Chalgren	(CDN 023748-23756)
<i>DL</i>	388	L.I.S.A. (LASER SYSTEMS INTERACTIVE SYBOLIC ASSEMBLER) V. 1.5		(CDN 023757-23758)
<i>DL</i>	389	RECENT COMPUTER SCIENCE BOOKS		(CDN 023759-23763)
		MODIFYING YOUR MONITOR		

Examiner's Initials	TAB NO	DESCRIPTION	AUTHOR	PUBLICATION
<i>BL</i>	390	PROGRAM	Leighton Paul	(CDN023764-23765)
<i>BL</i>	391	Modems: Hooking your Computer to the World	Stan Miastkowski George Stewart	December 1982 (CDN 023766-23772)
<i>BL</i>	392	BUSINESS (Telephone Software Connection)		December 1982 (CDN 023774-23787)
<i>BL</i>	393	Displays (COOSOL COMPUTER PRODUCTS)		December 1982 (CDN 023788)
<i>BL</i>	394	Displays: APPLE (Amper-Magic)		December 1982 (CDN 023789)
<i>BL</i>	395	TOMORROW'S APPLES TODAY (TELEPHONE TRANSFER II)		November 1982 (CDN 023790-23792)
<i>BL</i>	396	Display: (Music Maker ETC.)		(CDN 023793)
<i>BL</i>	397	A GUIDE TO COMMUNICATION SOFTWARE PACKAGES (Cutting line cost)		October 1982 CDN 023794-23807)
<i>BL</i>	398	DATA COMMUNICATION PROFESSIONALS:(ENGINEERING DEPARTMENT MANAGER-SOFTWARE		October 1982 (CDN 023808)
<i>BL</i>	399	MODEMS AND THE MICROMODEM II	Athol H. Cohen	(CDN 023809-23818
<i>BL</i>	400	SOFTWARE (Arcade Math)		September/October 1982 (CDN 023819-23821)

Examiner's Initials	TAB NO.	DESCRIPTION	AUTHOR	PUBLICATION
SR	401	MARKETING (Makers Transform the Ways Computer Programs Are Sold)	Susan Chace	August 26, 1982 (CDN 023822)
SR	402	LETTER PERFECT DATA PERFECT EDIT 6502 (LETTER PERFECT)		(CDN023823-23826)
SR	403	PATCHING DOS THE EASY WAY	Leighton Paul	(CDN 023827)
SR	404	Display: TOGETHER, LOCKSMITH, THE INSPECTOR AND WATSON		(CDN 023828)
SR	405	ELECTRONIC MAIL SYSTEM ENHANCES DELPHI METHOD	Bernard S. Husbands	1982 (CDN 023829-23832)
SR	406	NEW PRODUCTS (Save Civilization in Your Spare Time)		May 1982 (CDN 023833-23843)
SR	407	JUST A CALL AWAY (Dial Up Software Service)		(CDN 023844)
SR	408	Display: RADIO & RECORDS		(CDN 023845)
SR	409	Display: SHE'S NO STRANGER NOW		(CDN 023846)
SR	410	Radio & Records: Letter to ED Magnin	Pam Bellamy	April 22, 1982 (CDN 023847)
SR	411	How to buy a personal computer (Here We Go Again)		(CDN 023849-23850)
SR	412	What's New? (Overlay Compiler)		March 1982 (CDN 023851-23852)
SR	413	Display: PURE POWER		February 1982 (CDN 023854)

Examiner's Initials	TAB NO:	DESCRIPTION	AUTHOR	PUBLICATION
BL	414	NEW PRODUCTS: Not Just Another Chess Game (Championship chess)		February 1982 (CDN 023855)
BL	415	NEW ELECTRONIC MAIL SERVICE ON-LINE		(CDN 023856)
BL	416	Display: Arithmetic Teacher (Problems for Solving Fractions)		(CDN 023857)
BL	417	A Guide to Personal Computers (PERSONAL-COMPUTER HARDWARE)	Steve Ditlea	December 14, 1981 (CDN 02386223870) NEW YORK
BL	418	A Line On Friendly Utilities	Theron Fuller	(CDN 023871-23874)
BL	419	Conferences Goes On-Line (Ethernet Online)		(CDN 023875-23881)
BL	420	TERMINAL DATA	Jeffrey Mazur	September 1981 (CDN 023882-23885)
BL	421	DATALOOP: Smartmodem announced at NCC '81		July 2, 1981 (CDN 023886-23893)
BL	422	RESEARCH:	George Bond	July 7, 1981 (CDN 023894-23896)
BL	423	MARKET CHARTER		June 1981 (CDN 023897-23901)
BL	424	TELEPHONE SOFTWARE CONNECTION (Phone Log)		February 1981 (CDN 023902)
BL	425	Display: FASTER THAN A SPEEDING TYPYST		(CDN 023903)
BL	426	MARKETALK NEWS (Multi-Media)		January 1981 (CDN 023904-23905)

Examiner's Initials	TAB NO.	DESCRIPTION	AUTHOR	PUBLICATION
		Video)		
BL	427	DIAL-YO DIRECTORY (Talking Terminals)	Frank J. Derfler, Jr.	January 1981 (CDN 023906-23907)
BL	428	APPLE CART (Books)	Chuck Carpenter	(CDN 023908-23910)
BL	429	Display: SPACE WAR AND INVASION		(CDN 023911)
BL	430	MARKETALK NEWS (Hardhat Software)		November 1980 (CDN 023912-23913)
BL	431	ADMIN.:HELLO CBS NEWS (Letter to Ed)		(CDN 023915-23916)
BL	432	Display: ADVANCED ELECTRONICS		(CDN 023918)
BL	433	NOVATION PREMIERES NEW EXHIBIT AT TWO LOS ANGELES SHOWS		(CDN 023919-23923)
BL	434	MICROPROCESSOR NEWSLETTER : Microprocessor Training Center		June 5, 1980 (CDN 023924-23932)
BL	435	THE TELEPHONE SOFTWARE EXPERIENCE A REVIEW (OF SORTS)	Val J. Golding	May 1980 (CDN 023933-23935)
BL	436	BIBLIOGRAPHY (hand notes)		(CDN 023917-23732)
BL	437	Display ;Our Records of Growth		May 1979 (CDN 023937)
BL	438	Display: PURCHASE AND RECEIVE SOFTWARE		(CDN 023953)
BL	439	Letter from License Department to		July 19, 1979 (CDN 023938)

Examiner's Initials	TAB NO.	DESCRIPTION	AUTHOR	PUBLICATION
		Edgar&Marilyn Magnin		
<i>BL</i>	440	COPY OF BUSINESS LICENSE (BUSINESS LICENSE APPLICATION)	Edgar & Marilyn Magnin	(CDN 023939-23940)
<i>BL</i>	441	Letter from J. Walker Owens RE: NEW BUSINESS OPERATOR (WELCOME)	J. Walker Owens	August 9, 1979 (CDN 023941-23944)
<i>BL</i>	442	Software for the Apple II (DYNAMAZE , ULTRA BLOCKADE) GAMES)		(CDN 023945-23946)
<i>BL</i>	443	Display : Telephone Software Connection (MANY THANKS FOR YOUR RECENT ORDER)		(CDN 023947)
<i>BL</i>	444	Price Log (ANSWERING MACHINES, WRITE-EDIT & SEND)		(CDN 023951-23952)
<i>BL</i>	445	Display : ADVERTISEMENT (DESK CALCULATOR II)		July 1980 (CDN 023950)
<i>BL</i>	446	Instructions: Computer with header		(CDN 023954)
<i>BL</i>	447	MICROSOFT CONSUMER PRODUCTS CONTINUING THE MICROSOFT TRADITION (ANNOUNCING MICR OSOFT CONSUMER PRODUCTS)		(CDN 023955)
<i>BL</i>	448	THE APPLE ORCHARD (COMPUTERWORLD PRINTER INIT ROUTINE)		March/April 1980 (CDN 023956)

Examiner's Initials	TAB NO	DESCRIPTION	AUTHOR	PUBLICATION
BC	449	VOLUME TABLE OF CONTENTS (\$11,0)		July/August 1980 (CDN 023957-23959)
BC	450	SUP'R TERMINAL (SPECIFICATIONS)		(CDN 023960)
BC	451	CALL-APPLE (functions, remin.)		March/April 1980 (CDN 023961)
BC	452	CALL-APPLE (STOCK MARKET DATA RETRIEVAL ONE THE SOURCE)	Hersch Pilloff	March/April 1980 (CDN 023962)
BC	453	CBS NEWS CREW FROM WALTER CRONKITE	David Dow	September 9, 1980 (CDN 023963-23965)
BC	454	Telephone Software Connection (PHONE LOG)		(CDN 023966-23969)
BC	455	Advertising for quicker shopping over computer (GO-MOKU)		(CDN 023970-23971)
BC	456	Advertising for Pet and Apple II Users (PASCAL)		November/December 1980 (CDN 023973)
BC	457	Letter from Telephone software Connection (REGARDING THE ELECTRONIC COMMUNICATION SERVICE)		March (CDN 023977)
BC	458	Letter (OFFERING INTRODUCTION)		(CDN 023979-23983)
BC	459	Letter from Ed Magnin REF: TSC/TELEMAIL USER)	Ed Magnin	February 8, 1982 (CDN 023984)
BC	460	NOW YOUR HOME COMPUTER CAN CALL OTHER COMPUTERS ONE THE	Neil Shapiro	March 1981 (CDN 023985-23987)

Examiner's Initials	TAB NO.	DESCRIPTION	AUTHOR	PUBLICATION
		TELEPHONE		
<i>BL</i>	461	Advertising (SHAPE BUILDER, TERMINAL PROGRAMS, DOUBLE DOS, MATH TUTOR)		March 1981 (CDN 023988-23990)
<i>BL</i>	462	SOFTALK (MICROMATE'S MICRONET-IT PLUGS IN THE GAME PORT)		May (CDN 023991)
<i>BL</i>	463	VOIDED BLANK CHECK #1513		May (CDN 023998)
<i>BL</i>	464	CORVUS CONTROLLING 3 APPLES (WE HAVE NEW PHONE NUMBERS)		May 18, 1981 (CDN 023999)
<i>BL</i>	465	PREDICTING THE FUTURE WITH ELECTRONIC MAIL (THE TELENET WAY)	Bernard S. Husbands	October 1981 (CDN 024000-24001)
<i>BL</i>	466	PROGRAM SHOPPING BY PHONE : SOFTWARE CO. DOWNLOADS PROGRAMS	Michael Swaine	October 19, 1981 (CDN 024002)
<i>BL</i>	467	TELEPHONE SOFTWARE CONNECTION, INC. (THE HAYES MICROMODEM II : I'VE NEVER BROUGHT A BETTER SLAVE		July 1981 (CDN 024003)
<i>BL</i>	468	ADVERTISING (SHAPE BUILDER)		CDN 024006-24008)
<i>BL</i>	469	ADVERTISING (TELEPHONE TRANSFER II)		(CDN 024009)
<i>BL</i>	<u>470??</u>			

Examiner's Initials	TAB NO.	DESCRIPTION	AUTHOR	PUBLICATION
BA	471	Display: THE FP REPORT		(CDN 024018) TELEPHONE SOFTWARE CONNECTION. INC.
BA	472	Display: ORDER VIA MODEM		(CDN 024019)
BA	473	PRICE LOG		June 2, 1982 (CDN 02492023422)
BA	474	PRICE LOG CONT.)		October 21, 1982 (CDN 024023)
BA	475	Display: TELEPHONE SOFTWARE CONNECTION (ADDRESS POSTAGE)		(CDN 024024-24025)
BA	476	TELEPHONE SOFTWARE CONNECTION (Letter to Apple Dealer)	Ed Magnin	(CDN 024026)
BA	477	Display (MR. SMARTYPANTS)		(CDN 024028-24030)
BA	478	Display (DISK-CRYPTO)		(CDN 024031-24032)
BA	479	Display (VIDEO LIBRARIAN)		(CDN 024033-24035)
BA	480	Display (WORLD CURRENCY TRADER)		(CDN 024036-24037)
BA	481	Display (WORKING MODEL OF TELEPHONE SOFTWARE)		(CDN 024038)
BA	482	TELEPHONE SOFTWARE CONNECTION (Letter to AppleCat Owner)	Ed Magnin	(CDN 024039-24040)
BA	483	TELEPHONE SOFTWARE CONNECTION : THE HAYES MICROMODEM II (I've never bought		May 1980 (CDN 024041-24042)

Examiner's Initials	TAB NO.	DESCRIPTION	AUTHOR	PUBLICATION
		better slave)		
<i>EM</i>	484	SPECIAL MEMO TO EDUCATORS	Ed Magnin	(CDN 024043-24044)
<i>EM</i>	485	TELEPHONE SOFTWARE CONNECTION (BACKGROUND PIECE)		(CDN 024045-24049)
<i>EM</i>	486	Display : VEND-O-DISK		(CDN 024050-24052)
<i>EM</i>	487	Letter to Programmer	Ed Magnin	(CDN 024053-24054)
<i>EM</i>	488	NEWS FROM T.S.C.		April 1983 (CDN 024055-24058)
<i>EM</i>	489	NEWS FROM T.S.C.		June 1983 (CDN 024059-24062)
<i>EM</i>	490	WHAT IS VOICEMAIL?		(CDN 024063-24065)
<i>EM</i>	491	TELEPHONE SOFTWARE CONNECTION (INTRODUCTION)	ED Magnin	(CDN 024066-24067)
<i>EM</i>	492	NEWS FROM T.S.C.		October 1983 (CDN 024068-24071)
<i>EM</i>	493	HOW TO ORDER : MODEM		024072-24077)
<i>EM</i>	494	Telecommunication (TELEDELIVERY)		(CDN 024084)
<i>EM</i>	495	NEWS FROM T.S.C.		June 1984 (CDN 024085-24088)
<i>EM</i>	496	PlumbLine (BASE COMPUTERS)		(CDN 024089-24090)
<i>EM</i>	497	NEWS FROM T.S.C.		December 1984 (CDN 024091-24094)
<i>EM</i>	498	NEWS FROM T.S.C.		March 1985 (CDN 024095-24098)
<i>EM</i>	499	Display: PHONE SECRETARY		(CDN 024099-24100)

DC01 363825 v 1

Examiner's Initials	TAB NO.	DESCRIPTION	AUTHOR	PUBLICATION
<i>BE</i>	500	TELEPHONE SOFTWARE CONNECTION (BACKGROUND PIECES)		(CDN 024101-24106)
<i>BE</i>	501	TELEPHONE SOFTWARE CONNECTION (TOP SECRET) Displays		(CDN 02410724113)
<i>BE</i>	502	Display (Before 1984)		(CDN 024114)
<i>BE</i>	503	Display: IF YOU HAVE AN APPLE (phone list)		(CDN 024115-24117)
<i>BE</i>	504	Display (THE FP REPORT)		(CDN 024118-24119)
<i>BE</i>	505	THE HAYE'S MICROMODEM II		CDN 024120-24121)
<i>BE</i>	506	PRICE LOG		(CDN 024122-24123)
<i>BE</i>	507	NEWS FROM T.S.C.		October 1983 (CDN 024124)
<i>BE</i>	508	Display: Instructions on Software Delevery)		(CDN 024125)
<i>BE</i>	509	PRICE LOG		(CDN 024126-24127)
<i>BE</i>	510	NEWS FROM T.S.C.		June 1983 (CDN 024128-24129)
<i>BE</i>	511	PRICE LOG		(CDN 024130-24131)
<i>BE</i>	512	NEWS FROM T.S.C.		(CDN 024132-24133)
<i>BE</i>	513	Display (PHONE SECRETARY II (54)		CDN 024134)
<i>BE</i>	514	Letter to Programmer	Ed Magnin	(CDN 024135)

Examiner's Initials	TAB NO	DESCRIPTION	AUTHOR	PUBLICATION
<i>RA</i>	515	PROGRAMMERS' PIPELINE(DESCRIPTION SLIP)		(CDN 024136-24137)
<i>RA</i>	516	Display: WORLD CURRENCY TRADER		(CDN 024138)
<i>RA</i>	517	PRICE LOG		(CDN 024139-24140)
<i>RA</i>	518	Display: ORDER VIA MODEM		(CDN 024141)
<i>RA</i>	519	Display: SIX GREAT WAYS TO ADD TO YOUR SUMMER FUN!		CDN 024142)
<i>RA</i>	520	PHONE LOG		(CDN 024143-24144)
<i>RA</i>	521	NEWS FROM T.S.C. (RECENT OFFERINGS)		March 1985 (CDN 024145)
<i>RA</i>	522	SPOTLIGHT ON GRAPHICS (SHAPE BUILDER)		CDN 024146-24148)
<i>RA</i>	523	DISK. LABELMAKER (#73)		CDN 024149)
<i>RA</i>	524	NEWS FROM T.S.C. (TERNINAL PROGRAM II)		(CDN 024150-24152)
<i>RA</i>	525	FREE UPDATE TO DESK CALENDAR II		(CDN 024153)
<i>RA</i>	526	NEWS FROM T.S.C.		June 1984 (CDN 024154-24156)
<i>RA</i>	527	Display : (DISK-CRYPTOION)		(CDN 024157-24158)
<i>RA</i>	528	Display: (PHONE SECRETARY) (#54)		(CDN 024159-24160)
<i>RA</i>	529	COMMUNICATION (TERMINAL)		(CDN 024161-24168)

Examiner's Initials	TAB NO	DESCRIPTION	AUTHOR	PUBLICATION
		PROGRAM)		
<i>EE</i>	530	DIALING INSTRUCTIONS		(CDN 024169)
<i>EE</i>	531	Telecommunications Adviser	Ed Magnin	November 1983 (CDN 024170-24171)
<i>EE</i>	532	GETTING ON COMMUNI ((PROVIDERS AND CONSUMERS)	Ed Magnin	March 1984 (CDN 021417224173)
<i>EE</i>	533	ONLINE TIPS		(CDN 024174)
<i>EE</i>	534	Display: List (SOFTWARE SALES)		April 11, 1983 (CDN 024175)
<i>EE</i>	535	A SOFTWARE VENDING MACHINE	Ed Magnin	March 1984 (CDN 024176)
<i>EE</i>	536	MARKETING (Makers Transform the Ways Computer Programs Are Sold)	Susan Chace	August 26, 1982 (CDN 024177) THE WALL STREET JOURNAL
<i>EE</i>	537	TECHNOLOGY (Electronic Software Delivery Threatens Mail and Store Sales)		May 6, 1983 (CDN 024178)
<i>EE</i>	538	Western Union: Mailgram (Letter to Microcomputer User)		(CDN 024179)
<i>EE</i>	539	Apple/c Baud Rate Problem (Dialing Instructions)		(CDN 024180)
<i>EE</i>	540	Display: Recent Offerings		March 1985 (CDN 024181-24184)
<i>EE</i>	541	Letter ti Prometheus Modem Owner	Ed Magnin	(CDN 024185)
<i>EE</i>	542	Display: PHONE SECRETARY// (54)		(CDN 024186-24187)
<i>EE</i>	543	FUTURE DEVELOPMENTS IN		(CDN 024188)

DC01 363825 v 1

Examiner's Initials	TAB NO	DESCRIPTION	AUTHOR	PUBLICATION
		TELECOMMUNICATION		
<i>BE</i>	544	RESPONSES (FUTURE DEVELOPMENTS IN TELECOMMUNICATION)		(CDN 024189)
<i>BE</i>	545	CHARTS (USES FOR TELECOMMUNICATION LINKS)		(CDN 024190-24192)
<i>BE</i>	546	PROLOGUE (THE COMMUNICATION SATELLITE)		(CDN 024193-24194)
<i>BE</i>	547	ANALOG VERSUS DIGITAL TRANSMISSION		(CDN 024195-24206)
<i>BE</i>	548	CABLE TELEVISION AND ITS POTENTIAL		(CDN 024207-24209)
<i>BE</i>	549	Display : Qube gets you into the action		(CDN 024210)
<i>BE</i>	550	TERMINALS IN THE HOME		(CDN 024211-24223)
<i>BE</i>	551	A FUTURE SCENARIO		(CDN 024224-24246)
<i>BE</i>	552	SIGNAL COMPRESSION		(CDN 024247-24261)
<i>BE</i>	553	Letter from Ed Magnin (MONTHLY RENTAL)	Ed Magnin	(CDN 024262-24264)
<i>BE</i>	554	JITTERS		July 29, 1996 (CDN 024265) Business Week
<i>BE</i>	555	E-COMMERCE: WHO OWNS THE		July 29 1996(CDN 02466-24267)

Examiner's Initials	TAB NO.	DESCRIPTION	AUTHOR	PUBLICATION
		RIGHTS?		
<i>JS</i>	556	"A pilot has to believe in his equipment. (ROLEX)		(CDN 024268)
<i>JS</i>	557	Retailers cheer end of patent challenge	Dan Goodin	April 2, 1999 (CDN 024269-24271)
<i>JS</i>	558	Patently Offensive	Shoshana Berger	(CDN 024272)
<i>JS</i>	559	Magnin & Associates (Video Game, Film & TV)		(CDN 024273-24274)
<i>JS</i>	560	Documents (Appendix F: Decimal Tokens for Keywords)		(CDN 024275-24276)
<i>JS</i>	561	Appendix F: Decimal Tokens For Key words		(CDN 024277)
<i>JS</i>	562	PRIVATE PEOPLE (Easing the way for libel suits)		(CDN 024278)
<i>JS</i>	563	MAY THE SOURCE BE WITH YOU	Christopher Byron	(CDN 024279)
<i>JS</i>	564	INFORMATION SERVICES: MODEMS		(CDN 024280)
<i>JS</i>	565	A SOURCE OF RICHES	Alfred Glossbrenner	August 1983 (CDN 024281-24284)
<i>JS</i>	566	ELECTRONIC JACKPOT	Alfred Glossbrenner	September 1983 (CDN 024285-24287)
<i>JS</i>		CONSUMER AND SPECIALIZED ON-		

Examiner's Initials	TAB NO.	DESCRIPTION	AUTHOR	PUBLICATION
<i>RL</i>	567	LINE SERVICES		(CDN 024288-24290)
<i>RL</i>	568	CALCULATION PROGRAMS		(CDN 024291-24293)
<i>RL</i>	569	WHAT IS VIEWDATA		CDN 024294-24302)
<i>RL</i>	570	PM ELECTRONICS MONITOR	Neil Shapiro	(CDN 024303)
<i>RL</i>	571	DIAL-UP SOFTWARE NETWORKS	Jules H. Gilder	May 1980 (CDN 024304-24306)
<i>RL</i>	572	SOFTWARE AND DATA VIA TELEPHONE		October 1980 (CDN 024307-24310)
<i>RL</i>	573	DIAL-UP SOFTWARE NETWORKS	Herb Friedman	October 1992 (024311-24314)
<i>RL</i>	574	Documents (Ticketmaster to Lick Competition by Buying It)		(CDN 024315-24316)
<i>RL</i>	575	TICKETMASTER (memo)	Alan Citron Michael Cieply	February 26, 1991 (CDN 024317-24318) Los Angeles Times
<i>RL</i>	576	TICKETMASTER: 20 Years (INDUSTRY'S #1 HAS A TICKET TO RULE)	Adam Sandler	(CDN 024319-24321)
<i>RL</i>	577	ELECTRONIC LIFE	Michael Crichto	1983 (CDN 024322)
<i>RL</i>	578	THE NAKED COMPUTER (Telesoftware ?)	Rochester, Gantz, William Marrow + Co.	(CDN 024323)

Examiner's Initials	TAB NO.	DESCRIPTION	AUTHOR	PUBLICATION
<i>JK</i>	579	COMPUTERS FOR EVERYBODY (Downloading Programs)	Jerry Willis	1984 (CDN 024324-24328)
<i>JK</i>	580	TELECOMMUNICATIONS IN THE INFORMATION AGE (Videotext Chapter 12)	Singleton	1983 (CDN 024329-24340)
<i>JK</i>	581	UNITED STATES PATENT (LOCKWOOD)		May 3, 1994 (CDN 024341-24343)
<i>JK</i>	582	UNITED STATES PATENT (YURIS, et. al.)		January 27, 1981 (CDN 024344)
<i>JK</i>	583	UNITED STATES PATENT (KELLY, et. al.)		May 15, 1984 (CDN 024345)
<i>JK</i>	584	UNITED STATES PATENT (HELLMAN)		April 14, 1987 (CDN 024346-24347)
<i>JK</i>	585	Documents (THE WIRED SOCIETY)	James Martin	(CDN 02434824349)
<i>JK</i>	586	NEW USE OF TELEVISION (VIEWDATA)		(CDN 024350)
<i>JK</i>	587	NEWS (DO-IT-YOURSELF NEWSPAPERS)		(CDN 024351)
<i>JK</i>	588	SPIDERWEBS (PIERRE TELHARD de CHARDIN)		(CDN 024352-24353)
<i>JK</i>	589	INSTANT MAIL (DIGITIZED MESSAGES)		(CDN 024354)
<i>JK</i>	590	INFORMATION DELUGE		(CDN 024355)

Examiner's Initials	TAB NO.	DESCRIPTION	AUTHOR	PUBLICATION
<i>ts</i>	591	SATELLITE AGE (Chapter Fourteen HOME)		CDN 024356-24366)
<i>BL</i>	592	James Martin & Co. Executive Profiles (James Martin)		October 25, 1996 (CDN 024367-24368) JM & Co.
<i>BL</i>	593	2. NEWS (Dow Jones News/ Retrieval's Free-Text Search)		1985 (CDN 024369-24383)
<i>BL</i>	594	COMPUTERS (TELESUN)		(CDN 024384-24387)
<i>BL</i>	595	16 FULL-SERVICE (THE SOURCE)		(CDN 024388-24408)
<i>BL</i>	596	Article 49 of 88 PATNEWS : Another reason why the E-Data patent is invalid	Gregory Atharonian	October 16, 1996 (CDN 024409-24410) Deja News
<i>BL</i>	597	Article 1 of 25 PATNEWS: Mor PTO gossip on Zache,Edata, Hyatt	Gregory Atharonian	October 18, 1996 (CDN 024411-24412)
<i>BL</i>	598	Display: TSC Rreview		(CDN:024413)
<i>BL</i>	599	UNITED STATES POSTAL SERVICE (Documents & Letters)		(CDN 024414-24423)
<i>BL</i>	600	THE HOME ACCOUNTANT, REVISITED (Responds to reviews)		(CDN 024424-24426)
<i>BL</i>	601	DFX (Introductions)	Graeme Scott	(CDN 024427-24442)
<i>BL</i>	602	PEELINGS REVIEW (Introductions)		November 12, 1982 (CDN 024443)
<i>BL</i>	603	PELLINGS II (Programmers Library)		NOVEMBER 10, 1982 (CDN 024444-24454)

Examiner's Initials	TAB NO.	DESCRIPTION	AUTHOR	PUBLICATION
<i>KL</i>	604	Letter (TRIAL TERMINAL)	K.F. MOSELEY	March 10, 1981 (CDN 024455)
<i>KL</i>	605	K.F. MOSELEY'S TVINTERFACE 8 EVALUATION (TIME AND MONEY METER)	Ed Magnin	(CDN 024456-24457)
<i>KL</i>	606	A.D.A.M. II NEWSLETTER (ACKNOWLEDGEMENT)		May 13, 1981 (CDN 024458-24465)
<i>KL</i>	607	PEELINGS II (Publication of Apple Software Reviews)		August 6, 1980 (CDN 024467-24500)

Examiner's Initials	TAB NO.	DESCRIPTION	AUTHOR	PUBLICATION
<i>KL</i>	608	Apple-Cart (Input From Readers)	Chuck Carpenter	(CDN 024501-24503) CREATIVE COMPUTING
<i>KL</i>	609	CALL-APPLE (THE TELEPHONE SOFTWARE EXPERIENCE A REVIEW (OF SORT))	Val Golding	(CDN 024504)
<i>KL</i>	610	SOFTALK (Peachy Writer)		September 1982 (CDN 024505)
<i>KL</i>	611	SOFTALK (Preformer Printer Format Board)		(CDN 024506)
<i>KL</i>	612	Extra Copy RE: KM		(CDN 024507-24508)
<i>KL</i>	613	MARKETING (Makers Transform Ways Computer Programs Are Sold)	Susan Chace	August 26, 1982 (CDN 024509) THE WALL STREET JOURNAL

Examiner's Initials	TAB NO.	DESCRIPTION	AUTHOR	PUBLICATION
<i>bc</i>	614	MARKETING (SOME COMPUTER JUNKIES)	Susan Chace	August 26, 1982 (CDN 024510) THE WALL STREET JOURNAL
<i>bc</i>	615	EXTRA		(CDN 024511)
<i>bc</i>	616	New Products (Save Civilization in Your Spare Time)		May 1982 (CDN 024512) POPULAR COMPUTING
<i>bc</i>	617	EXTRA		(CDN 024513)
<i>bc</i>	618	What's New? (Overlay Compiler)		March 1982 (CDN 024514)
<i>bc</i>	619	The Information Directory Says It All! (SUBJECT INDEX)		(CDN 024515)
<i>bc</i>	620	Tap New Markets! (Information Directory)		(CDN 024516)
<i>bc</i>	621	THE 21ST CENTURY LIBRARY (Information Directory)	Anne M. Helfrich	March 16, 1982 (CDN 024517-24524)
<i>bc</i>	622	ELECTRONIC MAIL (APPLICATIONS FOR MANAGEMENT)		(CDN 024525-24534)
<i>bc</i>	623	InfoWorld (AVL Eagle)		October 19, 1981
<i>bc</i>	624	TSC (MICROCOMPUTING)		October 15, 1981 (CDN 024536)
<i>bc</i>	625	ELECTRONIC DISTRIBUTION (Trial Builder)		(CDN 024537-24546)
<i>bc</i>	626	MUSIC (Honey. They're Downloading Our Song)	Patrick M. Reilly	(CDN 024547-24548)

Examiner's Initials	TAB NO.	DESCRIPTION	AUTHOR	PUBLICATION
bc	627	WHO'S NEWS (Foundation Health Names Malik Hasan As CEO and President)		May 13, 1997 (CDN 024549)
bc	628	INDUSTRY FOCUS (Middlemen Find Ways to Survive Cyberspace Shopping)	David Bank	December 12, 1996 (CDN 024550)
bc	629	Egghead Inc. Ships Software Over Internet (Ingram Micro Inc.)	David Bannk	November 8, 1996 (CDN 024551)
bc	630	Tom Clancy, Virtus Start Firm for On-Line Games		November 13, 1996 (CDN 024552)
bc	631	N2K Hires Phil Ramone to Start Up A Music Label Linked to the Internet	Patrick M. Reilly	November 18, 1996 (CDN 024553)
bc	632	BUSINESS BRIEFS (AT&T UNVEILS A SERVICES TO HELP BUSINESSES SET UP SHOP ON INTERNET)	James Sanberg	October 9, 1996 (CDN 024554)
bc	633	TECHNOLOGY & HEALTH (Industry. Net Customers to Be Offered On-Line Payment Services From PNC)	Raju Narisetti	September 25, 1996 (CDN 024555)
bc	634	Vague New World (Digital Media Business Takes Form as a Battle Of Complex Alliances)		(CDN 024556-24558)
bc	635	Music Firms Vow to Block New CD System	Meg Cox	May 14, 1993 (CDN 024559-24560)
bc	636	BUSINESS (Blockbuster plans to stock CDs electronically)		May 12, 1993 (CDN 024561)

Examiner's Initials	TAB NO.	DESCRIPTION	AUTHOR	PUBLICATION
<i>bl</i>	637	TECHNOLOGY & HEALTH (Bellcore to Demonstrate System For Delivering Movies By Phone)	Mary Lu Carnevale	November 9, 1992 (CDN 024562)
<i>bl</i>	638	TECHNOLOGY (IBM COMMITS MORE THAN \$100 MILLION ON VENTURE TO RELAY VIDEO, OTHER DATA)	Michael W, Miller	September 16, 1992 (CDN 024563-24564)
<i>bl</i>	639	IBM TO UNVEIL PLAN TO SKIP DISKS, SEND SOFTWARE BY SATELLITE (GM's Hughes Network Joins Big Blue Alliance to Serve Retailers and Corporations)	Bart Ziegler	November 1, 1994 (CDN 024565-24566)
<i>bl</i>	640	Software Industry Bulletin (SIB THIRD QUARTER 1985 SOFTWARE EMPLOYMENT SURVEY)		October 14, 1985 (CDN 024567-24568)
<i>bl</i>	641	DOWNLOAD (VENDORS KICK OFF FALL SEASON WITH TELEDELIVERY VENTURES)		September 1985 (CDN 024569-24583)
<i>bl</i>	642	SPEED>S (ELECTRONIC DELIVERY OF SOFTWARE)		(CDN 024584-24595)
<i>bl</i>	643	PHONE MEMO		April 19, 1985 (CDN 024596-24600)
<i>bl</i>	644	Letter to Nathaniel Forbes (MCI MAIL LETTER)	Ed Magnin	April 8, 1985 (CDN 024601-24607)
<i>bl</i>	645	SPEED>S (THE INSIDE STORY)		April 8, 1985 (CDN 024608-24623)
<i>bl</i>		Document: Letter to Nathaniel Forbes		

Examiner's Initials	TAB NO.	DESCRIPTION	AUTHOR	PUBLICATION
<i>EM</i>	646	(EXPRESS MAIL)	Ed Magnin	March 29, 1985 (CDN 024624-24630)
<i>EM</i>	647	GIMCRAX, INC (The leader in electronic delivery of software)		December 5, 1984 (CDN024631-24636)
<i>EM</i>	648	SPEED>S (New Edition of SPEED>S disk Now Available)		(CDN 024637)
<i>EM</i>	649	SPEED>S (Postage)		(CDN 024638)
<i>EM</i>	650	SPEED>S (Over 50 Lotus 1-2-3 templates to be available exclusively on SPEED>S!)		(CDN 024639)
<i>EM</i>	651	SPEED>S (Postage)		(CDN 024640)
<i>EM</i>	652	SPEED>S (Open An Electronic Library for Your Company Software)		(CDN 024641)
<i>EM</i>	653	SPEED>S (Postage)		January 27, 1986 (CDN 024642)
<i>EM</i>	654	GIMCRAX LAUNCHES FILE DELIVERY SERVICE		December 23, 1985 (CDN 24643)
<i>EM</i>	655	SPEED>S (WHAT MODEM SHOULD I BUY)		November 22, 1985 (CDN 024644)
<i>EM</i>	656	Display (SPEED>S)		December 2, 1985 (CDN 024645)
<i>EM</i>	657	SPEED>S (NOW! Try SPEED>S Electronic Delivery!)		October 21, 1985 (CDN 024646)
<i>EM</i>	658	SPEED>S (YOUR FIRST ISSUE ON THE SPEED>S PASSWORD!)		(CDN 024647)

Examiner's Initials	TAB NO.	DESCRIPTION	AUTHOR	PUBLICATION
<i>BL</i>	659	INTERNATIONAL VIDEOTEX TELETEXT NEWS (GIMCRAX TO DOWNLOAD)		August 1984 (CDN 024648)
<i>BL</i>	660	SPEED>S (SPEED>S MEAN BUSINESS)		(CDN 024649-24652)
<i>BL</i>	661	NEWS FROM THE SOURCE (NAT FORBES PROMOTED TO DIRECTOR OF SALES FOR STC)		(CDN 024653-24654)
<i>BL</i>	662	SPEED>S (SPEED>S MEAN BUSINESS)		(CDN 024655-24658)
<i>BL</i>	663	HANDWRITTEN NOTES		(CDN 024659-24665)
<i>BL</i>	664	HANDWRITTEN NOTES (NAT FORBES)		March 28, 1985 (CDN 24666-24668)
<i>BL</i>	665	NET TO TRANSMIT VIDEOTEX, GAMES TO 12 MILLION USER	Jim Bartimo	June 13, 1983 (CDN 024669) COMPUTER WORLD
<i>BL</i>	666	Vending machines for software: What will Japan think up next? (Games only)		June 1985 (CDN 024670) Data Communications
<i>BL</i>	667	Electronic Software Distributor To Show System to Retailers	Rory J. O'Connor	May 30, 1983 (CDN 024671)
<i>BL</i>	668	Software Industry Bulletin (ELECTRONIC SOFTWARE DISTRIBUTORS)		(CDN 024672-24675)
<i>BL</i>	669	SOFTWARE (Why try to stock software like physical goods? Why not just reproduce it as needed)		(CDN 0924676-24683)

Examiner's Initials	TAB NO.	DESCRIPTION	AUTHOR	PUBLICATION
<i>BL</i>	670	Mr. Download: An Interview with William von Meister		(CDN 024684-24693)
<i>BL</i>	671	Letter to Bob Peyser (Telephone Software Connections)	Ed Magnin	March 25, 1985 (CDN 02469424700)
<i>BL</i>	672	DIRECT -NET (Micro Marketworld Readers)	Bill James	February 1, 1985 (CDN 024701-24702)
<i>BL</i>	673	Cutting Out the Middleman (Looking to expand their customer base)	Myron Berger	(CDN 024703-24708)
<i>BL</i>	674	SHOP BY MODEM (Software Without Manuals)		(CDN 024709)
<i>BL</i>	675	Speak the Universal Lanaguage (POWERHOUSE)		(CDN 024710)
<i>BL</i>	676	Letter to Ed Magnin (SOFTWARE AUTHOR ROYALTY AGREEMENT)	Fonnie Clifton	October 17, 1983 (CDN 024711-24733)
<i>BL</i>	677	BUY SOFTWARE VIA MODEM (DEFINE THE NEED)	Elizabeth Ferrarini	(CDN 024734-24745)
<i>BL</i>	678	ABC VIDEO ENTERPRISES TELEFIRST PROJECT HAD BOOSTERS & DOUBTERS		May 1, 1984 (CDN 024746)
<i>BL</i>	679	DOWNLOAD (MICRPRO & ADAPSO SUE AMERICAN BRANDS, ALLEGE SOFTWARE PIRACY)		February 1985 (CDN 024747-24762)
<i>BL</i>	680	Coleco, AT&T Unit to Form Joint Venture	Bob Davis	(CDN 024763)

Examiner's Initials	TAB NO.	DESCRIPTION	AUTHOR	PUBLICATION
		To Distribute Video Games By Telephone		
<i>BC</i>	681	ELECTRONIC(PULLING THE PLUG ON ELECTRONIC PUBLISHING)		(CDN 024764-24766)
<i>BC</i>	682	SOFTWARE (SOFTWARE DIRECTORIES GO ON-LINE)	Joanne Gamlin	(CDN 024767-24780)
<i>BC</i>	683	SAY IT WITH REMOTE ROM SOFTWARE DELIVERY (Looking Ahead With Software News)		(CDN 024781)
<i>BC</i>	684	IT'S NOT THE SAME OLD 'HELP' ANYMORE (Buzz Word)	Mary-Beth Santarelli	(CDN 024782)
<i>BC</i>	685	ARE YOU GETTING READY FOR ELECTRONIC SOFTWARE DELIVERY?	Richard Lewis	February 1984 (CDN 024783-24788)
<i>BC</i>	686	Hammerly files suit against PC Telemart		(CDN 024789)
<i>BC</i>	687	MICRO SOFTWARE TODAY (EDUCATION: ENTERTAINMENT)		(CDN 024790)
<i>BC</i>	688	DISTRIBUTION & RETAILING (XANTE TO DISTRIBUTE SOFTWARE ELECTRONICALLY TO MASS MERCHANTISERS)		(CDN 024791)
<i>BC</i>	689	SYSTEMS : Software Engineering (Letter from Phil Klammm)	Phil Klammm	January 20, 1984 (CDN 024792)
<i>BC</i>	690	ROM-LABS (ELECTRONIC SOFTWARE DISTRIBUTION SYSTEM)		January 3, 1984 (CDN 024793-24802)

Examiner's Initials	TAB NO	DESCRIPTION	AUTHOR	PUBLICATION
<i>BB</i>	691	VAN DIVER'S (The Most Resourceful Directories for the IBM PC		(CDN 024803)
<i>BB</i>	692	SOFTWARE DISTRIBUTION: SMOOTH GOING NOW : ROCKY ROAD AHEAD	Steve Burke	(CDN 024804)
<i>BB</i>	693	Romox is hoping to have system in 3,000 stores by end of '84		(CDN 024805)
<i>BB</i>	694	Display (SOFT TOUCH)		January 12, 1984 (CDN 024806)
<i>BB</i>	695	BUGS IN ELECTRONIC SOFTWARE DISTRIBUTION NOT WORKED OUT (ELECTRONIC DISTRIBUTION)	Lisa Raleigh	(CDN 024807-24809)
<i>BB</i>	696	ANNOUNCING A NEW IN-DEPTH STUDY AND ANALYSIS OF (Downloading & Teledelivery of Computer Software, Music & Video)	Nancy L. Stocker	March 11, 1986 (CDN 024810-24824)
<i>BB</i>	697	CERTIFICATE OF COPY REGISTRATION (TIME AND MONEY METER)	Edgar J. Magnin	March 8, 1982 (CDN 024825-24840)
<i>BB</i>	698	CERTIFICATE OF COPY REGISTRATION (QUICK CLOCK ADJUST)	Edgar J. Magnin	(CDN 024841-24847)
<i>BB</i>	699	CERTIFICATE OF COPY REGISTRATION (MATH TUTOR)	Edgar J. Magnin	July 18, 1981 (CDN 024848-24864)
<i>BB</i>	700	Document: DELIVERY NOTICE ((CDN 024865)

DC01 363825 v 1

Examiner's Initials	TAB NO.	DESCRIPTION	AUTHOR	PUBLICATION
		CERTIFIED)		
<i>EM</i>	701	Document: POSTAL RECEIPT (CERTIFIED) From : Ed & Marilyn Magnin		March 27, 1981 (CDN 024866)
<i>EM</i>	702	RECEIPT FOR CERTIFIED MAIL #288727		March 6, 1981 (CDN 024867)
<i>EM</i>	703	INSTRUCTIONS :CERTIFIED MAIL FEE, OPTIONAL SERVICES		(CDN 024868)
<i>EM</i>	704	Letter from Edgar J. Magnin (COPYRIGHTS REGISTRATION: TERMINAL PROGRAMS	Edgar J. Magnin	March 5, 1981 (CDN 024869-24889)
<i>EM</i>	705	RECEIPT (REGISTER OF COPYRIGHTS)		November 4,1980 (CDN 024890-24905
<i>EM</i>	706	RECEIPT (REGISTER OF COPYRIGHTS: LIBRARY OF CONGRESS		September 3,1980 (CDN 024906-24927)
<i>EM</i>	707	CERTIFICATE OF COPYRIGHT REGISTRATION (PHONE SECRETARY)	Edgar J. Magnin	November 4,1980 (CDN 024929-24934)
<i>EM</i>	708	Letter from Edgar J. Magnin (COPYRIGHT REGISTRATION: PHONE SECRETARY)	Edgar J. Magnin	August 27, 1980 (CDN 024935-24946)
<i>EM</i>	709	Letter from Edgar J. Magnin (CALL TSC, PICTURE TRANSFER, GO-MOKU, CHESS CONNECTION	Edgar J. Magnin	May 30,1980 (CDN 024947-24951)
<i>EM</i>	710	CERTIFICATE OF COPYRIGHT REGISTRATION (GO-MOKU)	Edgar J. Magnin	June 9,1980 (CDN 024952-24960)

DC01 363825 v 1

Examiner's Initials	TAB NO.	DESCRIPTION	AUTHOR	PUBLICATION
<i>CC</i>	711	CERTIFICATE OF COPYRIGHT REGISTRATION (CHESS CONNECTION)	Craig Crossman	(CDN 024961-24971)
<i>EM</i>	712	CERTIFICATE OF COPYRIGHT REGISTRATION (GO-MOKU)	Edgar J. Magnin	(CDN 024972-24981)
<i>EM</i>	713	CERTIFICATE OF COPYRIGHT REGISTRATION (CALL TSC)	Edgar J. Magnin	(CDN 024982-24986)
<i>EM</i>	714	CERTIFICATE OF COPYRIGHT REGISTRATION (PICTURE TRANSFER PROGRAM)	Edgar J. Magnin	(CDN 024987-25002) April 1980
<i>EM</i>	715	Letter from Edgar J. Magnin : APPLICATIONS FOR COPYRIGHT (ANSWERING MACHINE, WRITE-EDIT & SEND, TELEPHONE TRANSFER PROGRAM)	Edgar J. Magnin	March 28, 1980 (CDN 025003-25007)
<i>EM</i>	716	CERTIFICATE OF COPYRIGHT REGISTRATION (WRITE-EDIT & SEND)	Edgar J. Magnin	(CDN 025008-25018)
<i>EM</i>	717	CERTIFICATE OF COPYRIGHT REGISTRATION (TELEPHONE TRANSFER PROGRAM)	Edgar J. Magnin	(CDN 025019-25033)
<i>EM</i>	718	CERTIFICATE OF COPYRIGHT REGISTRATION (ANSWERING MACHINE)	Edgar J. Magnin	(CDN 025035-25046)
<i>EM</i>	719	CERTIFIED RECEIPTS: CERTIFICATE	Leighton Paul	October (CDN 025047-25095)

DC01 363825 v 1

Examiner's Initials	TAB No	DESCRIPTION	AUTHOR	PUBLICATION
		OF COPYRIGHT REGISTRATION (TELEPHONE TRANSFER II)		
<i>AM</i>	720	CERTIFICATE OF COPYRIGHT REGISTRATION (TELEGAMMON)	Anton Dahbura, JR.	(CDN 025096-25139)
<i>AM</i>	721	Letter to Mr. Ledbetter RE: Correspondence of 3/12/82 control # 2-054-0414(M)	Edgar J. Magnin	October 4, 1982 (CDN 025140-25212)
<i>AM</i>	722	CERTIFICATE OF COPYRIGHT REGISTRATION (PHONE SECRETARY II)	Edgar J. Magnin	September 6, 1983 (CDN 025213-25253)
<i>AM</i>	723	CERTIFICATE OF COPYRIGHT REGISTRATION (FIFTEEN. PUZZLE)	Edgar J. Magnin	7, 1985 (CDN 025254-25313)
<i>AM</i>	724	Letter to Mr. Magnin: RE: FRACTION TUTOR (TX 1 384 355) sand TYPING SPEED BUILDER (CERTIFICATE OF COPYRIGHT REGISTRATION (FRACTION TUTOR)	Edgar J. Magnin · Larry M. Schultz	January 4, 1985 (CDN 025314-25344)
<i>AM</i>	725	RECEIPT FOR CERTIFIED MAIL (CERTIFICATE OF COPYRIGHT REGISTRATION (PICTURE PUZZLE PROGRAMS)	Edgar J. Magnin	(CDN 25345-25380)
<i>AM</i>	726	CERTIFICATE OF COPYRIGHT REGISTRATION (QUICK COMPARE)	Leighton Paul	(CDN 025381-25405)
<i>AM</i>	727	Telephone Software Connection, Inc. (PROGRAM LISTING)		(CDN 025406-25408)

Examiner's Initials	TAB NO.	DESCRIPTION	AUTHOR	PUBLICATION
<i>BE</i>	728	SERIAL LISTING		(CDN 025409)
<i>BE</i>	729	SERIAL LISTING (CON'T)		(CDN 025410)
<i>BE</i>	730	COPYRIGHT STATUS (PROGRAMS,COPYRIGHT NOTICE ETC.)		(CDN 02541125412731)
<i>BE</i>	731	RECEIPTS FOR CERTIFIED MAIL : Letter from Edgar J. Magnin to Register of Copyrights (INSTANT MENU) CERTIFIED OF COPYRIGHT REGISTRATION	Edgar J. Magnin	June 6/11 1985 (CDN 025413-25448)
<i>BE</i>	732	RECEIPTS FOR CERTIFIED MAIL: Letter from Edgar J. Magnin to Register of Coping (CERTIFIED OF COPYRIGHT REGISTRATION) : MORTGAGE ANALYZER	Eagar J. Magnin	(CDN 025449-25475)
<i>BE</i>	733	CompuSonics Version 1.05 (THE DRIVE EVENT CONTROL LOOP FOR THE DSP-1000)		July 17, 1987 (CDN 025476-255545)
<i>BE</i>	734	Documents (ROUTING FOR THE MACHINE, ROUTINES REQUIRED TO READ AND TO THE FRONT PANES)''		March 11, 1987 (CDN 025546-25667)
<i>BE</i>	735	CompuSonics D S P 2002 version 1.00 (PRELIMINARY USER MANUAL		August 28,1985 (CDN 025668-25707)
<i>BE</i>	736	AUDIO COMPUTER OWNERS GUIDE		(CDN 025708)

Examiner's Initials	TAB NO.	DESCRIPTION	AUTHOR	PUBLICATION
		(ADVERTISING)		
<i>BE</i>	737	QUICK REFERENCE CARD (OPERATIONS)		(CDN 025709-25767)
<i>BE</i>	738	AN ALGORITHM AND ARCHITECTURE FOR CONSTANT-Q SPECTRUM ANALYSIS (ABSTRACT)	Gary W. Schwede	April 1983 (CDN 025768-25771)
<i>BE</i>	739	AES (PRESENTED AT THE 76th CONVENTION 1984 OCTOBER 8-11 NEW YORK)		(CDN 025772-025775)
<i>BE</i>	740	COMMAND AND STATUS REGISTERS (RECEIVE DATA COUNT REGISTER)		CDN 025776-25786)
<i>BE</i>	741	Letter to David M. Schwartz (RE: THE PREPRINTS FROM THE AES 78th CONVENTION)	Patricia M. MacLonald	November 18, 1985 (CDN 25787-25817)
<i>BE</i>	742	EFFICIENT DATA REDUCTION FOR DIGITAL AUDIO USING A DIGITAL FILTER ARRAY (PURPOSE)	John P. Stautner David M. Horowitz	1986 (CDN 025818-25821)
<i>BE</i>	743	AES (PRESENTED AT THE 83rd CONVENTION 1987 OCTOBER 16-19 NEW YORK)	David M. Schwartz	(CDN 025822-25829)
<i>BE</i>	744	AES (PRESENTED AT THE 83rd CONVENTION 1987 OCTOBER 16-19 NEW YORK)	John Stautner Sriram Jayasimba	(CDN 025830-25836)

Examiner's Initials	TAB NO:	DESCRIPTION	AUTHOR	PUBLICATION
<i>JS</i>	745	AES (PRESENTED AT THE 84th CONVENTION 1988 MARCH 1-4 PARIS	J.P. Stautner	(CDN 025837-25854)
<i>JS</i>	746	THE DIGITAL AUDIO CARTRIDGE DISK RECORDER, REPRODUCER AND EDITOR FOR BROADCAST USE	David M. Schwartz	(CDN 025855-25866)
<i>JS</i>	747	TOWARDS ELECTRONIC DELIVERY OF MUSIC(1.0 INTRODUCTION	John P. Stautner	(CDN 025867-25873)
<i>JS</i>	748	ARCHITECTURE OF A REAL TIME DIGITAL FILTERBANK PROCESSOR FOR TEMPERED, AUDITORY, AND CRITICAL-BAND ANALYSIS/SYNTHESIS	Gary W. Schwede	(CDN 025874-25875)
<i>JS</i>	749	A FUNCTIONAL OVERVIEW OF THE COMPUSONICS DSP-2000 SERIES		(CDN 025876-25877)
<i>JS</i>	750	MUSICAL RECORDING, EDITING AND PRODUCTION USING THE COMPUSONICS DSP-2004	John P. Stautner	(CDN 025878-258790)
<i>JS</i>	751	STRATEGIES FOR THE REPRESENTATION AND DATA REDUCTION OF DIGITAL MUSIC SIGNALS (WORK PERFORMED AND METHODS EMPLOYED	John P. Stautner	June 20, 1984 (CDN 025880-25881)
<i>JS</i>	752	ANALYSIS AND SYNTHESIS OF MUSIC USING THE AUDITORY TRANSFORM	J. Stautner	Submitted to Dept. of Electrical Engineering and Computer Science, Massachusetts Institute of Technology

Examiner's Initials	TAB NO.	DESCRIPTION	AUTHOR	PUBLICATION
				May, 1983 CDN025895
<i>JS</i>	753	ALGORITHMS AND ARCHITECTURES FOR CONSTANT-Q FOURIER SPECTRUM ANALYSIS	G. Schwede	Dissertation submitted to University of California, Berkeley November 28, 1983 CDN026097
<i>JS</i>	754	Letter to Shareholders	D. Schwartz	CompuSonics CDN026261
<i>JS</i>	755	From the News Desk		InfoWorld Newsweekly, June 4, 1984 Volume 6, Issue 23 CDN026263
<i>JS</i>	756	Manufacturing Update		International Audio Video, June 1984 CDN026264
<i>JS</i>	757	CompuSonics Pro Equipment & Services		Cover of Billboard Newspaper CDN026265
<i>JS</i>	758	CompuSonics Fuses Computer, Audio Into "World's First" Home Digital Recorder	M. Golden	CES Trade News Daily, p. 10 June 4, 1984 CDN026266
<i>JS</i>	759	Digital Sound Now On Computer Disks	S. Booth	Consumer Electronics Show Daily June 3, 1984 CDN026267
<i>JS</i>	760	CompuSonics Reads Floppy Disk to Record and Play Back Music		HFD - The Weekly Home Furnishings Newspaper June 4, 1984

DC01 363825 v 1

68

Examiner's Initials	TAB NO.	DESCRIPTION	AUTHOR	PUBLICATION
				CDN026268
<i>BC</i>	761	Technology Awards to CompuSonics		CDN026269
<i>BC</i>	762	CompuSonics DSP 1000 Digital Audio Disk Recorder Specifications		CompuSonics Corporation CDN026270
<i>BC</i>	763	CompuSonic Bows Totally Digital		Pro Sound News, New York, NY June 8, 1984
<i>BC</i>	764	Floppy Disks May Be the Next Music Makers		Business Week May 28, 1984 CDN026272
<i>BC</i>	765	Studio Design Special		Mix - The Recording Industry Magazine August 1984
<i>BC</i>	766	CompuSonics: Another Digital Audio Standard	N. Weinstock	Mix, Vol. 8, No. 8, p. 24 CDN026274
<i>BC</i>	767	CompuSonics: Another Digital Audio Standard	N. Weinstock	Mix, Vol. 8, No. 8, p. 26 CDN026275
<i>BC</i>	768	CompuSonics Readies Floppy Disk to Record and Play Back Music		HFD, Electronics, Section 1 June 4, 1984 CDN026276
<i>BC</i>	769	The State of RCA		TV Digest, p. 14 May 21, 1984 CDN026277
<i>BC</i>	770	Display - CompuSonics Photographs		CDN026278

Examiner's Initials	TAB NO.	DESCRIPTION	AUTHOR	PUBLICATION
<i>JS</i>	771	Display - CES Exhibition Design and Engineering 1984		CDN026280
<i>JS</i>	772	Specifications - CompuSonics DSP 1000 Digital Disk Recorder/Player		CompuSonics Corporation CDN026281
<i>JS</i>	773	Article - Watch Out Digital Discs: Here Comes Floppy Audio		Unknown
<i>JS</i>	774	Specifications - CompuSonics DSP 1000 Digital Disk Recorder/Player		CompuSonics Corporation
<i>JS</i>	775	Optical-Disk-Digital Audio System Premieres	B. Robinson	Electronic Engineering Times, Issue 397 September 1, 1986 CDN026284
<i>JS</i>	776	Specifications - CompuSonics DSP 1000 Digital Disk Recorder/Player		CompuSonics Corporation
<i>JS</i>	777	CompuSonics Business Plan Overview		June 14, 1984 CDN026286
<i>JS</i>	778	Cover - Fortune Magazine		November 12, 1984 CDN026289
<i>JS</i>	779	Advertisement - CompuSonics Corporate Profile	D. Schwartz	Audio Video International CDN026290
<i>JS</i>	780	Toward Electronic Delivery of Music: Sending and Receiving High Fidelity Digital Music	J. Stautner	CompuSonics Corporation CDN026291
<i>JS</i>	781	Company Sees Future in Digital Recorders	J. Hendon	Rocky Mountain News

DC01 363825 v 1

70

Examiner's Initials	TAB NO.	DESCRIPTION	AUTHOR	PUBLICATION
				July 22, 1984
<i>AE</i>	782	Floppy-Disk Audio System	A. Mereson	Science Digest November, 1984 CDN026299
<i>AE</i>	783	Recording Music on Floppy Disks	A. Zuckerman	High Technology May 1986 CDN026300
<i>AE</i>	784	Article - Sound is Big at Consumer Show	L. Mortwaki	Seattle Washington Times June 8, 1984 CDN026301
<i>AE</i>	785	Digital Recording System Uses Floppy Disks		Audio Times, Vol. 26, No. 5 May, 1984 CDN026302
<i>AE</i>	786	CompuSonics Advertisement		CDN026304
<i>AE</i>	787	Advertisement - MicroPro's WordStar 2000		CDN026305
<i>AE</i>	788	Hi-Fi Floppy	K. Yates	PC World, Vol. 3, Issue 4 CDN026306
<i>AE</i>	789	The Digitization of Music	K. Yates	PC World, Vol. 3, Issue 4 CDN026308
<i>AE</i>	790	A Sonic Glossary	K. Yates	PC World, Vol. 3, Issue 4 CDN026311
<i>AE</i>	791	New Hi-Fi Horizons	D. Ranada	Stereo Review, December 1984 CDN026313

DC01 363825 v 1

Examiner's Initials	TAB NO.	DESCRIPTION	AUTHOR	PUBLICATION
<i>DL</i>	792	Specifications and Implementation of a Computer Audio Console for Digital Mixing and Recording	D. Schwartz	AES 76th Convention, NYC June 20, 1984 CDN026317
<i>DL</i>	793	A High Speed Telecommunications Interface for Digital Audio Transmission and Reception	H. Sohn	Abstract CDN026319
<i>DL</i>	794	The Audio Computer and Its Applications	D. Schwartz; J. Stautner	CompuSonics Corporation CDN026332
<i>DL</i>	795	Engineering Your Own Digital Audio Broadcast System	D. Schwartz	CompuSonics Corporation CDN026343
<i>DL</i>	796	Tab - Pay 2 Tape '90		CDN026362
<i>DL</i>	797	Fax Cover Sheet to Michael Kapp from D. Schwartz	D. Schwartz	April 26, 1990 CDN026363
<i>DL</i>	798	Fax Memo to Michael Kapp from D. Schwartz	D. Schwartz	April 26, 1990
<i>DL</i>	799	Pay Per Listen Cable Audio System - Notes to Viewgraph Presentation	CompuSonics	CDN026365
<i>DL</i>	800	Pay Per Listen Cable Audio System - System Payback Analysis	CompuSonics	CDN026366
<i>DL</i>	801	Pay Per Listen Cable Audio System - Provide the In-Home Music Taper with a Wide Variety of Source Material	CompuSonics	CDN026367
<i>DL</i>		Pay Per Listen Cable Audio System -		

DC01 363825 v 1

Examiner's Initials	TAB NO	DESCRIPTION	AUTHOR	PUBLICATION
<i>BS</i>	802	Provide the In-Home Music Taper with a Wide Variety of Source Material	CompuSonics	CDN026368
<i>BS</i>	803	Pay Per Listen Cable Audio System - Audio Database Format Options	CompuSonics	CDN026374
<i>BS</i>	804	Pay Per Listen Cable Audio System - Billboard Top 100 LPS Format	CompuSonics	CDN026375
<i>BS</i>	805	Pay Per Listen Cable Audio System - Program Publication Options	CompuSonics	CDN026379
<i>BS</i>	806	Letter to Shareholder from D. Schwartz	D. Schwartz	November 21, 1984 CDN026381
<i>BS</i>	807	Letter to Shareholder from D. Schwartz	D. Schwartz	October 10, 1985 CDN026382
<i>BS</i>	808	Display Photograph		CDN026384
<i>BS</i>	809	Display Photograph		CDN026385
<i>BS</i>	810	CompuSonics DSP2002 Preliminary User Manual		CDN026386
<i>BS</i>	811	Display - Hardware Spec		CDN026387
<i>BS</i>	812	Internal Data		CDN026388
<i>BS</i>	813	DSP-1000 Series		CDN026389
<i>BS</i>	814	Digital Marketing Corporation Video Real Estate System		June 7, 1986 CDN026390

Examiner's Initials	TAB NO.	DESCRIPTION	AUTHOR	PUBLICATION
<i>BE</i>	815	Agenda for June 7, 1988 Meeting		CDN026393
<i>BE</i>	816	Agenda for May 31, 1988 Meeting	CompuSonics	CDN026394
<i>BE</i>	817	Advertisement - Digilist Video Multiple Listing Service	Digital Marketing Corporation	CDN026395
<i>BE</i>	818	Advertisement - Digilist Video Multiple Listing Service	Digital Marketing Corporation	CDN026396
<i>BE</i>	819	Advertisement - Digilist Video Multiple Listing Service	Digital Marketing Corporation	CDN026398
<i>BE</i>	820	Memo to B. Holmbraker, B. Alderfer, R. Dahl, H. Fong from D. Schwartz	D. Schwartz	CompuSonics Financial/Technical Status January 12, 1987 CDN026399
<i>BE</i>	821	Manual - Assembly Procedure for the DSP1500		CDN026401
<i>BE</i>	822	Specifications - CompuSonic DSP 1000		CDN026440
<i>BE</i>	823	DSP 1000 Digital Audio Disk Recorder Application Notes		CDN026489
<i>BE</i>	824	The Home Terminal		International Resource Development, pp. 149-158 August 1978 CDN026745

Examiner's Initials	TAB NO.	DESCRIPTION	AUTHOR	PUBLICATION
<i>BL</i>	825	ROLM PLUGS CBX INTO IBM WORLD		Electronic Mail & Message Systems Vol. 7, No. 9 May 2, 1983 CDN026768
<i>BL</i>	826	CONTROL VIDEO ENTERS DOWNLINE LOADING BUSINESS		Electronic Mail & Message Systems Vol. 7, No. 11 June 1, 1983 CDN026771
<i>BL</i>	827	EMMS Article		Electronic Mail & Message Systems Vol. 7, No. 14, p. 17 July 15, 1983 CDN026775
<i>BL</i>	828	THE OTHER HALF OF THE IBM PC		Electronic Mail & Message Systems Vol. 7, No. 16 August 15, 1983 CDN026776
<i>BL</i>	829	ELECTRONIC MESSAGE SYSTEMS AND THE HOME TERMINAL		Electronic Mail & Message Systems Vol. 3, No. 12 June 15, 1979 CDN026779
<i>BL</i>	830	EMMS Article		Electronic Mail & Message Systems Vol. 3, No. 15, p. 13 August 1, 1979 CDN026784
<i>BL</i>	831	EMMS Article		Electronic Mail & Message Systems Vol. 6, No. 11, p. 20

DC01 363825 v 1

Examiner's Initials	TAB NO.	DESCRIPTION	AUTHOR	PUBLICATION
				June 1, 1982 CDN026785
<i>BE</i>	832	EMMS Article		Electronic Mail & Message Systems Vol. 6, No. 15, p. 14 August 2, 1982 CDN026786
<i>BE</i>	833	EMMS Article		Electronic Mail & Message Systems Vol. 6, No. 23 December 1, 1982 CDN026789
<i>BE</i>	834	FIBER-OPTICS WILL SHAKE THE UTILITIES		Electronic Mail & Message Systems Vol. 9, No. 20 November 1, 1985 CDN026792
<i>BE</i>	835	BRITISH TELECOM OFFERS FREE ELECTRONIC MAIL SERVICES		Electronic Mail & Message Systems Vol. 10, No. 7 April 1, 1986 CDN026797
<i>BE</i>	836	PROFIT PROTECTION - RISKY BUSINESS		Electronic Mail & Message Systems Vol. 12, No. 16 August 15, 1988 CDN026801
<i>BE</i>	837	EMMS Article		Electronic Mail & Message Systems Vol. 12, No. 21 November 1, 1988

Examiner's Initials	TAB NO.	DESCRIPTION	AUTHOR	PUBLICATION
				CDN026811
<i>BE</i>	838	CompuSonics to Bow Digital Audio Floppy Disk Player/Recorder; CD Rival?	C. Kaplan	Consumer Electronics Daily, Vol. VIII, No. 5, Issue 8 May 10, 1984 CDN026255
<i>BE</i>	839	HOME TELECOMMUNICATIONS IN THE 1980's		International Resource Development, Inc. April 1980, Report 150 CDN026812
<i>BE</i>	840	THE FUTURE OF TELEVISION		International Resource Development, Inc. August 1981, Report 176 CDN026914
<i>BE</i>	841	HEALTH, WEALTH & SELF-IMPROVEMENT HOME SOFTWARE		International Resource Development, Inc. September 1985, Report 670 CDN026935
<i>BE</i>	842	TELECOMMUNICATIONS MARKET OPPORTUNITIES		International Resource Development, Inc. November 1985, Report 676 CDN026955
<i>BE</i>	843	TELEPAY VS. VIDEODISC		International Resource Development, Inc. September 1982, Report 510 CDN027013
<i>BE</i>	844	VIDEOGAMES & ELECTRONIC TOYS		International Resource Development, Inc. May 1983, Report 550 CNDN027034
<i>BE</i>	845	DELIBERATELY LEFT BLANK		

DC01 363825 v 1

Examiner's Initials	TAB NO	DESCRIPTION	AUTHOR	PUBLICATION
<i>BL</i>	846	PAYMENTS RECEIVED FOR REPORT #558 DOWNLOADING AND TELEDELIVERY OF COMPUTER SOFTWARE, GAMES & MUSIC	Kenneth G. Bosomworth	January 9, 2001 CDN027138
<i>BL</i>	847	ARTICLE - COMPUSONICS/CARTS AT&T DEMO		Pro Sound News September 9, 1985 CDN027183
<i>BL</i>	848	INTENTIONALLY OMITTED DOCUMENTS CDN027190-CDN027734		3/13/01 Letter to N. Bigas from R. Gruwell 03/09/01 Letter M. Neblett from N. Bigas 03/05/01 Letter to M. Neblett from N. Bigas
<i>BL</i>	849	TRANSCRIPTION OF VIDEOTAPE		EE 380 - 2/18/87 - ALLISON 7 CDN027735
<i>BL</i>	850	THE DIGITAL AUDIO PROCESSING STATION: A NEW CONCEPT IN AUDIO POSTPRODUCTION	J. Mooret; C. Abbott; Peter Nye et al.	Journal of Audio Engineering Society, Vol. 34, No. 6, June, 1986, pp. 454-464 CDN027783
<i>BL</i>	851	ON DIGITAL I/O FORMAT	T. Doi	Sony Corporation Presented at AES Digital Audio Technical Committee, Hamburg, West Germany March 16, 1981 CDN027794
<i>BL</i>	852	PCM PROGRAM TRANSMISSION AND COMMUNICATION NETWORK FOR THE NORWEGIAN BROADCASTING	R. Andersen; K. Ronning	Journal of the Audio Engineering Society Volume 28, Number 4 April, 1980

Examiner's Initials	TAB NO	DESCRIPTION	AUTHOR	PUBLICATION
		CORPORATION		
<i>BL</i>	853	A FIBRE OPTIC MULTI-CHANNEL COMMUNICATION LINK DEVELOPED FOR REMOTE INTERCONNECTION IN A DIGITAL AUDIO CONSOLE	P. Lidbetter S. Douglas	Presented at the 80th Convention, Audio Engineering Society Reprint (Preprint 2330 D6) March 4-7, 1986 CDN027830
<i>BL</i>	854	BBC DIGITAL AUDIO -- A DECADE OF ON-AIR OPERATION	D. Stripp	BBC, London, United Kingdom Collected Papers from the Audio Engineering Society Premiere Conference, Rye, New York June 3-6, 1982 CDN027846
<i>BL</i>	855	PROCESSING SYSTEMS FOR THE DIGITAL AUDIO STUDIO	M. Jones	Neve Electronics International Limited, Royston, Hertfordshire, United Kingdom Collected Papers from the Audio Engineering Society Premiere Conference, Rye, New York June 3-6, 1982 CDN027852
<i>BL</i>	856	LARGE SCALE ACOUSTICS	D. Hawkins	Studio Sound and Broadcast Engineering March, 1985
<i>BL</i>	857	BBC DIGITAL CONTROL VEHICLE 12 MONTHS ON	K. Spencer-Allen	Diary-Diary, Studio Sound, p. 32-33 November, 1986
<i>BL</i>	858	WDR NEVE DSP NOW IN USE		Diary-Diary, Studio Sound, p. 18 August, 1986

Examiner's Initials	TAB NO.	DESCRIPTION	AUTHOR	PUBLICATION
<i>BL</i>	859	DIGITAL MASTERING TAPE ONE		Studio Sound, pp. 36, 38, 40 August, 1986
<i>BL</i>	860	DIGITAL SOUND SIGNALS: THE PRESENT BBC DISTRIBUTION SYSTEM AND A PROPOSAL FOR BIT-RATE REDUCTION BY DIGITAL COMPANDING	M. Croll; D. Osborne; C. Spicer	International Broadcasting Convention September 23-27, 1974
<i>BL</i>	861	AUDIO ENGINEERING HANDBOOK	K. Benson	AUDIO ENGINEERING HANDBOOK All-Digital Studio, pp. 4.37 - 4.38 Transmission Systems, pp. 4.57 Stereo with Television, p. 4.59 © 1988 CDN027884
<i>BL</i>	862	HANDBOOK OF RECORDING ENGINEERING	J. Eargle	The All-Digital Studio, pp. 373-375 © 1986 CDN027892
<i>BL</i>	863	ROUTING OF DIGITAL AUDIO SIGNALS IN A RADIO BROADCASTING CENTRE	N. Gilchrist; G. Crowe G. Legg	Eleventh International Broadcasting Convention September 19-23, 1986 CDN027897
<i>BL</i>	864	SIGNAL ROUTING IN A DIGITAL SOUND STUDIO	G. Roe; C. Caine	Eleventh International Broadcasting Convention September 19-23, 1986 CDN027902
<i>BL</i>	865	MULTI-PURPOSE RADIO LINKS	P. Marchant;	International Broadcasting Convention September 18-21, 1982

DC01 363825 v 1

Examiner's Initials	TAB NO	DESCRIPTION	AUTHOR	PUBLICATION
		SYSTEM FOR NEWS COVERAGE	I. Buffham	CDN027907
<i>BL</i>	866	DOCAT - DIGITAL, OPTICAL CATV TRUNK SYSTEM	G. Mogensen; B. Petersen; H. Steffensen	International Broadcasting Convention September 18-21, 1982 CDN027913
<i>BL</i>	867	DIGITAL TRANSMISSION SYSTEM FOR TELEVISION, SOUND AND ASSOCIATED DATA	A. Jones; D. Kitson	Tenth International Broadcasting Convention September 21-25, 1984 CDN027918
<i>BL</i>	868	DIGITAL SOUND MIXING IN THE ANALOGUE STUDIO	M. Jones; D. Langford; D. Tilsley	Tenth International Broadcasting Convention September 21-25, 1984 CDN027923
<i>BL</i>	869	DIGITAL SPEECH NETWORKS	B. Gold	Proceedings of the IEEE, Vol. 65, No. 12 December, 1977 CDN027939
<i>BL</i>	870	THE DIGITAL CODING OF HIGH-QUALITY MUSICAL SOUND	J. Moorer	Journal of the Audio Engineering Society Vol. 27, No. 9, pp. 657-666 September, 1979 CDN027962
	TAB	PATENT NO.	INVENTOR	FILING DATE
<i>BL</i>	871	Japanese Patent No. 62-284496		December 12, 1987
<i>BL</i>	872	3,602,891	Clark et al.	March 10, 1969

Examiner's Initials	TAB NO.	DESCRIPTION	AUTHOR	PUBLICATION
	TABS	TITLE	AUTHOR	SOURCE
BL	873	DIGITAL AUDIO FOR CABLE TELEVISION	C. Robbins	1986 NCTA Technical Papers, pp. 21-24 CDN028131
BL	874	SPEECH UNDERSTANDING SYSTEMS	Massachusetts Inst. of Technology, Lincoln Lab.	U.S. Department of Commerce, National Technical Information Service May 31, 1973 CDN028138
BL	875	SPEECH UNDERSTANDING SYSTEMS	Massachusetts Inst. of Technology, Lincoln Lab.	U.S. Department of Commerce, National Technical Information Service January 15, 1974 CDN028166
BL	876	INFORMATION PROCESSING TECHNIQUES PROGRAM, VOLUME I. PACKET SPEECH/ACOUSTIC CONVOLVERS	Massachusetts Inst. of Technology, Lincoln Lab.	U.S. Department of Commerce, National Technical Information Service June 30, 1976 CDN028198
	TAB	PATENT NO.	INVENTOR	FILING DATE
BL	877	Japanese Laid Open Kokai Patent Application 62-284496	Hisanobu Akashi	June 3, 1986
	TABS	TITLE	AUTHOR	SOURCE
BL	878	SPEECH ANALYSIS SYNTHESIS AND PERCEPTION	J. Flanagan	Bell Laboratories Channel Vocoders, pp. 323-405 CDN028247
BL	879	DIGITIZATION OF AUDIO: A	B. Blesser	Journal of the Audio Engineering Society

DC01 363825 v 1

Examiner's Initials	TAB NO	DESCRIPTION	AUTHOR	PUBLICATION
		COMPREHENSIVE EXAMINATION OF THEORY, IMPLEMENTATION AND CURRENT PRACTICE		Volume 26, Number 10 October, 1978 CDN028268
<i>BC</i>	880	PERSONAL COMPUTERS AND MUSIC: THE STATE OF THE ART	C. Yavelow	Journal of the Audio Engineering Society Volume 35, No. 3 March, 1987 CDN028301
<i>BC</i>	881	MIDI: MUSICAL INSTRUMENT DIGITAL INTERFACE	B. Moog	Journal of the Audio Engineering Society Volume 34, No. 5 May, 1986 CDN028325
<i>BC</i>	882	HOW DOES A COMPUTER MAKE MUSIC?	J. Moorer	Computer Music Journal, Volume II, Number 1 pp. 32-37 CDN028357
<i>BC</i>	883	LOSSLESS CODING FOR AUDIO DISCS	P. Craven M. Gerzon	Journal of the Audio Engineering Society Volume 44, No. 9 September, 1996 CDN028342
<i>BC</i>	884	AC-3: FLEXIBLE PERCEPTUAL CODING FOR AUDIO TRANSMISSION AND STORAGE	C. Todd; G. Davidson; M. Davis, et al.	Paper presented at the 96th Convention of the Audio Engineering Society, February 26-March 1, 1994 Dolby Laboratories, San Francisco CDN028365
<i>BC</i>	885	MASTERLINE SOFTWARE BY PHONE		APPLE II USER'S MANUAL

DC01 363825 v 1

Examiner's Initials	TAB NO.	DESCRIPTION	AUTHOR	PUBLICATION
				KH000015
<i>BL</i>	886	MASTERLINE SOFTWARE BY PHONE		COMMODORE 64 USER'S MANUAL KH000017
<i>BL</i>	887	MASTERLINE SOFTWARE BY PHONE		COMMODORE SOFTWARE EDITION FOR THE BELLSOUTH MASTER MODULE KH000028
<i>BL</i>	888	ELECTRONIC GAMES MAGAZINE		June 1983 KH000055
<i>BL</i>	889	GAMELINER MAGAZINE		October 1983 KH0000181
<i>BL</i>	890	MASTERLINE SOFTWARE BY PHONE, ISSUE TWO		APPLE SOFTWARE EDITION FOR THE BELLSOUTH MASTER MODULE KH000209
<i>BL</i>	891	ELECTRONIC GAMES MAGAZINE		October, 1983 KH000245
<i>BL</i>	892	APPLE II REFERENCE MANUAL		N2K04850
<i>BL</i>	893	VAX/VMS ACCOUNTING UTILITY REFERENCE MANUAL		September, 1984 N2K05242
<i>BL</i>	894			
<i>BL</i>	895	U.S. Patent 4,654,799 to Ogaki		March 31, 1987
<i>BL</i>	896	U.S. Patent 5,191,193 to Le Roux		March 2, 1993

DC01 363825 v 1

64660 U.S. PTO

AMENDMENT TRANSMITTAL LETTER (Large Entity)	Docket No. 219099/573
Applicant(s): Arthur R. Hair	

Serial No. 90/007,402	Filing Date 31 January 2005	Examiner Benjamin E. Lanier	Group Art Unit 2132
--------------------------	--------------------------------	--------------------------------	------------------------

Invention: Method for Transmitting Desired Digital Video or Audio Signals

CUSTOMER NUMBER: 23973

TO THE ASSISTANT COMMISSIONER FOR PATENTS:

Transmitted herewith is an amendment in the above-identified application.
The fee has been calculated and is transmitted as shown below.

CLAIMS AS AMENDED

	CLAIMS REMAINING AFTER AMENDMENT	HIGHEST # PREV. PAID FOR	NUMBER EXTRA CLAIMS PRESENT	RATE	ADDITIONAL FEE
TOTAL CLAIMS	43 -	20 =	23 x	\$50.00	\$1,150.00
INDEP. CLAIMS	10 -	3 =	7 x	\$200.00	\$1,400.00
Multiple Dependent Claims (check if applicable) <input type="checkbox"/>					\$0.00
TOTAL ADDITIONAL FEE FOR THIS AMENDMENT					\$2,550.00

- No additional fee is required for amendment.
- Please charge Deposit Account No. _____ in the amount of _____
A duplicate copy of this sheet is enclosed.
- A check in the amount of \$2,550.00 to cover the filing fee is enclosed.
- The Commissioner is hereby authorized to charge payment of the following fees associated with this communication or credit any overpayment to Deposit Account No. 50-0573
A duplicate copy of this sheet is enclosed.
 - Any additional filing fees required under 37 C.F.R. 1.16.
 - Any patent application processing fees under 37 CFR 1.17.

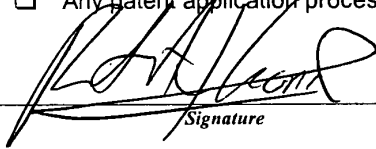
Signature

Dated: 27 December 2005

Robert A. Koons, Jr., Esq. Reg. No. 32,474
Drinker Biddle & Reath LLP
 One Logan Square
 18th & Cherry Streets
 Philadelphia, PA 19103-6996

Telephone: 215.998.3392

CUSTOMER NUMBER: 23973
cc:

01/11/2006 HCOI PAID

I certify that this document and fee is being deposited on 02 FC:1821 with the U.S. Postal Service as first class mail under 37 C.F.R. 1.8 and is addressed to the Assistant Commissioner for Patents, Washington, D.C. 20231.

Signature of Person Mailing Correspondence

Typed or Printed Name of Person Mailing Correspondence

CERTIFICATE OF MAILING BY "EXPRESS MAIL" (37 CFR 1.10)Applicant(s): **Arthur R. Hair**

Docket No.

219099/573Serial No.
90/007,402Filing Date
31 January 2005Examiner
Benjamin E. LanierGroup Art Unit
2132Invention: **Method for Transmitting Desired Digital Video or Audio Signals****CUSTOMER NUMBER: 23973**

I hereby certify that the following correspondence:

**Revocation/New POA with Statement under 3.73b with copies of assignment documents; New Assignment
Change of Entity Status; Response to Office Action with Exhibits A-D; Check for \$2550.00
Return Receipt Postcard**

(Identify type of correspondence)

is being deposited with the United States Postal Service "Express Mail Post Office to Addressee" service under
37 CFR 1.10 in an envelope addressed to: The Assistant Commissioner for Patents, Washington, D.C. 20231 on

27 December 2005*(Date)***Jane D. Roberts***(Typed or Printed Name of Person Mailing Correspondence)**(Signature of Person Mailing Correspondence)***EV 299885359 US***("Express Mail" Mailing Label Number)***Note: Each paper must have its own certificate of mailing.**

Change of Entity Status

<u>US 5,191,573</u>	<u>2998</u>	<u>2132</u>
US PATENT NUMBER	CONFIRMATION NO.	ART UNIT
<u>90/007,402</u>	<u>31 January 2005</u>	
RE-EXAM CONTROL NO.	FILING DATE	

Method for Transmitting Desired Digital Video or Audio Signals
TITLE OF INVENTION

Arthur R. Hair
INVENTOR

CERTIFICATION UNDER 37 C.F.R. § 1.10

I hereby certify that this paper, along with any documents referred to as being enclosed therewith, is being deposited with the United States Postal Service on **27 December 2005** in an envelope as "Express Mail Post Office to Addressee," Mailing Label No. **EV 299885359 US**, addressed to Mail Stop Ex Parte ReExam, Commissioner for Patents, P.O. Box 1450, Alexandria, VA 22313-1450.

JANE D. ROBERTS

Mail Stop Ex Parte ReExam
Commissioner for Patents
P.O. Box 1450
Alexandria, VA 22313-1450

Dear Sir or Madam:

We respectfully request that the Entity status for the subject patent be changed to reflect **Large Entity**. Due to a recent change of ownership, the Small Entity status under 37 C.F.R. 1.27 can no longer be claimed for the subject patent.

Please contact me if further clarification is needed.

Respectfully submitted,

Robert A. Koons, Jr., Esq.
Registration No. 32,474

Date: **December 27, 2005**
DRINKER BIDDLE & REATH LLP
One Logan Square
18th and Cherry Streets
Philadelphia, PA 19103-6996
Tel: (215) 988.3392
Fax: (215) 988.2757

IN THE UNITED STATES PATENT AND TRADEMARK OFFICE

In re Application of:)
ARTHUR R. HAIR)
Reexamination Control No. 90/007,402)
Reexamination Filed: January 31, 2005) METHOD FOR TRANSMITTING
Patent Number: 5,191,573) A DESIRED DIGITAL VIDEO OR
Examiner: Benjamin E. Lanier) AUDIO SIGNAL
)

Mail Stop *Ex Parte* Reexamination
Commissioner for Patents
P.O. Box 1450
Alexandria, VA 22313-1450

Sir:

RESPONSE

In response to the Office Action for the above-identified reexamination dated
October 26, 2005, please enter the following amendments and remarks.

Amendments to the Claims begin on page **2** of this paper.

Remarks begin on page **15** of this paper.

Listing of the Claims:

1. (Original) A method for transmitting a desired digital audio signal stored on a first memory of a first party to a second memory of a second party comprising the steps of:

transferring money electronically via a telecommunications line to the first party at a location remote from the second memory and controlling use of the first memory from the second party financially distinct from the first party, said second party controlling use and in possession of the second memory;

connecting electronically via a telecommunications line the first memory with the second memory such that the desired digital audio signal can pass therebetween;

transmitting the desired digital audio signal from the first memory with a transmitter in control and possession of the first party to a receiver having the second memory at a location determined by the second party, said receiver in possession and control of the second party; and

storing the digital signal in the second memory.

2. (Original) A method as described in Claim 1 including after the transferring step, the steps of searching the first memory for the desired digital audio signal; and selecting the desired digital audio signal from the first memory.

3. (Original) A method as described in Claim 2 wherein the transferring step includes the steps of telephoning the first party controlling use of the first memory by the second

party; providing a credit card number of the second party controlling the second memory to the first party controlling the first memory so the second party is charged money.

4. (Original) A method for transmitting a desired digital video signal stored on a first memory of a first party to a second memory of a second party comprising the steps of:

transferring money electronically via a telecommunications line to the first party location remote from the second memory and controlling use of the first memory, from a second party financially distinct from the first party, said second party in control and in possession of the second memory;

connecting electronically via a telecommunications line the first memory with the second memory such that the desired digital video signal can pass therebetween;

transmitting the desired digital video signal from the first memory with a transmitter in control and possession of the first party to a receiver having the second memory at a location determined by the second party, said receiver in possession and control of the second party; and

storing the digital signal in the second memory.

5. (Original) A method as described in Claim 4 including after the transferring money step, the step of searching the first memory for the desired digital signal and selecting the desired digital signal from the first memory.

6. (Original) A method as described in Claim 5 wherein the transferring step includes the steps of telephoning the first party controlling use of the first memory by the second

party controlling the second memory; providing a credit card number of the second party controlling the second memory to the first party controlling the first memory so the second party controlling the second memory is charged money.

7. (New) A method for transmitting a desired digital audio signal stored on a first memory of a first party to a second memory of a second party comprising the steps of:

transferring money electronically via a telecommunications line to the first party at a location remote from the second memory and controlling use of the first memory from the second party financially distinct from the first party, said second party controlling use and in possession of the second memory;

connecting electronically via a telecommunications line the first memory with the second memory such that the desired digital audio signal can pass therebetween;

transmitting the desired digital audio signal from the first memory with a transmitter in control and possession of the first party to a receiver having the second memory at a location determined by the second party, said receiver in possession and control of the second party;

storing the digital audio signal in the second memory; and

listing/scrolling digital audio signals from the second memory.

8. (New) A method as described in Claim 7 wherein the transferring step comprises the steps of telephoning the first party controlling use of the first memory by the second party; providing a credit card number of the second party controlling the second memory to the first party controlling the first memory so the second party is charged money.

9. (New) A method as described in Claim 7 further comprising the step of displaying a name of a digital audio signal from the second memory.

10. (New) A method as described in Claim 7 further comprising the step of displaying a duration of the digital audio signal from the second memory.

11. (New) A method as described in Claim 7 further comprising the step of displaying a name of an artist of the digital audio signal from the second memory.

12. (New) A method as described in Claim 7 further comprising the step of displaying a name of an album associated with the digital audio signal from the second memory.

13. (New) A method as described in Claim 7 further comprising the step of randomly selecting digital audio signals from the second memory by a second party integrated circuit of a second party control unit.

14. (New) A method for transmitting a desired digital video signal stored on a first memory of a first party to a second memory of a second party comprising the steps of:

transferring money electronically via a telecommunications line to the first party location remote from the second memory and controlling use of the first memory, from a second party financially distinct from the first party, said second party in control and in possession of the second memory;

connecting electronically via a telecommunications line the first memory with the second memory such that the desired digital video signal can pass therebetween;

transmitting the desired digital video signal from the first memory with a transmitter in control and possession of the first party to a receiver having the second memory at a location determined by the second party, said receiver in possession and control of the second party;

storing the digital signal in the second memory; and

listing/scrolling digital video signals from the second memory.

15. (New) A method as described in Claim 14 wherein the transferring step comprises the steps of telephoning the first party controlling use of the first memory by the second party controlling the second memory; providing a credit card number of the second party controlling the second memory to the first party controlling the first memory so the second party controlling the second memory is charged money.

16. (New) A method as described in Claim 14 further comprising the step of displaying a name of a digital video signal from the second memory.

17. (New) A method as described in Claim 14 further comprising the step of listing/scrolling queued digital video signals stored in the second memory.

18. (New) A method as described in Claim 14 further comprising the step of displaying a duration of the digital video signal from the second memory.

19. (New) A method as described in Claim 14 further comprising the step of displaying a name of an artist of the digital video signal from the second memory.

20. (New) A method as described in Claim 14 further comprising the step of displaying a name of an album associated with the digital video signal from the second memory.

21. (New) A method as described in Claim 14 further comprising the step of randomly selecting digital video signals from the second memory by a second party integrated circuit of a second party control unit.

22. (New) A method for transmitting a desired digital audio signal stored on a first memory of a first party to a second memory of a second party comprising the steps of:

transferring money electronically via a telecommunications line to the first party at a location remote from the second memory and controlling use of the first memory from the second party financially distinct from the first party, said second party controlling use and in possession of the second memory;

connecting electronically via a telecommunications line the first memory with the second memory such that the desired digital audio signal can pass therebetween;

transmitting the desired digital audio signal from the first memory with a transmitter in control and possession of the first party to a receiver having the second memory at a location determined by the second party, said receiver in possession and control of the second party;

storing the digital audio signal in the second memory; and

randomly selecting digital audio signals from the second memory by a second party integrated circuit of a second party control unit.

23. (New) A method as described in Claim 22 wherein the transferring step further comprises the step of providing a credit card number of the second party controlling the second memory to the first party controlling the first memory so the second party is charged money.

24. (New) A method as described in Claim 22 further comprising the step of listing/scrolling queued digital audio signals stored in the second memory.

25. (New) A method as described in Claim 22 further comprising the step of displaying a name of a digital audio signal from the second memory.

26. (New) A method for transmitting a desired digital audio signal stored on a first memory of a first party to a second memory of a second party comprising the steps of:

transferring money electronically via a telecommunications line to the first party at a location remote from the second memory and controlling use of the first memory from the second party financially distinct from the first party, said second party controlling use and in possession of the second memory;

connecting electronically via a telecommunications line the first memory with the second memory such that the desired digital audio signal can pass therebetween;

transmitting the desired digital audio signal from the first memory with a transmitter in control and possession of the first party to a receiver having the second memory at a location determined by the second party, said receiver in possession and control of the second party;

storing the digital audio signal in the second memory; and

displaying a name of an artist of the digital audio signal from the second memory.

27. (New) A method as described in Claim 26 wherein the transferring step further comprises the step of providing a credit card number of the second party controlling the second memory to the first party controlling the first memory so the second party is charged money.

28. (New) A method as described in Claim 26 further comprising the step of listing/scrolling queued digital audio signals stored in the second memory.

29. (New) A method for transmitting a desired digital audio signal stored on a first memory of a first party to a second memory of a second party comprising the steps of:

transferring money electronically via a telecommunications line to the first party at a location remote from the second memory and controlling use of the first memory from the second party financially distinct from the first party, said second party controlling use and in possession of the second memory;

connecting electronically via a telecommunications line the first memory with the second memory such that the desired digital audio signal can pass therebetween;

transmitting the desired digital audio signal from the first memory with a transmitter in control and possession of the first party to a receiver having the second memory at a location determined by the second party, said receiver in possession and control of the second party;

storing the digital audio signal in the second memory; and

displaying a duration of the digital audio signal from the second memory.

30. (New) A method as described in Claim 29 wherein the transferring step further comprises the step of providing a credit card number of the second party controlling the second memory to the first party controlling the first memory so the second party is charged money.

31. (New) A method as described in Claim 29 including the step of listing/scrolling queued digital audio signals stored in the second memory.

32. (New) A method as described in Claim 29 including the step of displaying a name of a digital audio signal from the second memory.

33. (New) A method for transmitting a desired digital video signal stored on a first memory of a first party to a second memory of a second party comprising the steps of:
transferring money electronically via a telecommunications line to the first party at a location remote from the second memory and controlling use of the first memory from the

second party financially distinct from the first party, said second party controlling use and in possession of the second memory;

connecting electronically via a telecommunications line the first memory with the second memory such that the desired digital video signal can pass therebetween;

transmitting the desired digital video signal from the first memory with a transmitter in control and possession of the first party to a receiver having the second memory at a location determined by the second party, said receiver in possession and control of the second party;

storing the digital video signal in the second memory; and

randomly selecting digital video signals from the second memory by a second party integrated circuit of a second party control unit.

34. (New) A method as described in Claim 33 wherein the transferring step further comprises the step of providing a credit card number of the second party controlling the second memory to the first party controlling the first memory so the second party is charged money.

35. (New) A method as described in Claim 33 further comprising the step of listing/scrolling queued digital video signals stored in the second memory.

36. (New) A method as described in Claim 33 including the step of displaying a name of a digital video signal from the second memory.

37. (New) A method for transmitting a desired digital video signal stored on a first memory of a first party to a second memory of a second party comprising the steps of:

transferring money electronically via a telecommunications line to the first party at a location remote from the second memory and controlling use of the first memory from the second party financially distinct from the first party, said second party controlling use and in possession of the second memory;

connecting electronically via a telecommunications line the first memory with the second memory such that the desired digital video signal can pass therebetween;

transmitting the desired digital video signal from the first memory with a transmitter in control and possession of the first party to a receiver having the second memory at a location determined by the second party, said receiver in possession and control of the second party;

storing the digital video signal in the second memory; and

displaying a name of an artist of the digital video signal from the second memory.

38. (New) A method as described in Claim 37 wherein the transferring step further comprises the step of providing a credit card number of the second party controlling the second memory to the first party controlling the first memory so the second party is charged money.

39. (New) A method as described in Claim 37 including the step of listing/scrolling queued digital video signals stored in the second memory.

40. (New) A method for transmitting a desired digital video signal stored on a first memory of a first party to a second memory of a second party comprising the steps of:

transferring money electronically via a telecommunications line to the first party at a location remote from the second memory and controlling use of the first memory from the second party financially distinct from the first party, said second party controlling use and in possession of the second memory;

connecting electronically via a telecommunications line the first memory with the second memory such that the desired digital video signal can pass therebetween;

transmitting the desired digital video signal from the first memory with a transmitter in control and possession of the first party to a receiver having the second memory at a location determined by the second party, said receiver in possession and control of the second party;

storing the digital video signal in the second memory; and

displaying a duration of the digital video signal from the second memory.

41. (New) A method as described in Claim 40 wherein the transferring step further comprises the step of providing a credit card number of the second party controlling the second memory to the first party controlling the first memory so the second party is charged money.

42. (New) A method as described in Claim 40 further comprising the step of listing/scrolling queued digital video signals stored in the second memory.

43. (New) A method as described in Claim 40 further comprising the step of displaying a name of a digital video signal from the second memory.

REMARKS

Claims 1-43 are currently active¹.

There have been no amendments to the previously pending claims, Claims 1 through 6, with this response. Claims 7-43 have been added. The newly added claims are fully supported by the specification. Support for new Claims 7-43 can be found in column 5, lines 5-25 of the specification.

In addition, all newly added claims contain at least the same limitations as set forth in pending Claims 1 and 4. As a result, all of the newly added claims are presumed to be allowable for at least the same reasons as set forth below with respect to pending independent Claims 1 and 4.

Rejections Under 35 U.S.C. § 103(a)

The Examiner has cited the combination of Akashi and Freeny in an effort to make out a *prima facie* case of obviousness of Claims 1-6 under 35 U.S.C. § 103(a). Applicant respectfully submits that the combination of Akashi and Freeny is inadequate to make out a *prima facie* case of obviousness of Claims 1-6.

¹ In considering these claims, Applicant wishes to direct the Examiner's attention to the reference identified as Number 849 in the Information Disclosure Statement filed July 21, 2005, which may not have been considered by the Examiner in the pending Office Action. Applicant does not believe this reference constitutes prior art that anticipates or renders obvious any of the original or newly added claims. Nonetheless, in view of the large number of references disclosed, Applicant wants to ensure that the Examiner has considered this reference.

Comments On Examiner's Response To Arguments

In the Office Action dated October 26, 2005, the Examiner states in his *Response to Arguments* that the "District Court decision was an analysis of Freeny as a Section 102 reference and not as a secondary reference." Applicant respectfully disagrees with this characterization of the District Court's opinion. Applicant maintains that a thorough review of the Opinion and Order of Court dated October 23, 2003 (the "Opinion") in the Sightsound v. N2K et al. litigation demonstrates that the District Court analyzed Freeny as a Section 103 reference. Applicant respectfully directs the Examiner to section 2 of the Opinion and Order beginning on page 45, titled "*Defendants' Examples of Prior Art giving Rise to Obviousness*" (emphasis added), attached hereto as Exhibit A. The District Court Judge goes on to analyze the Section 103 references cited by the defendants, including specifically "The Freeny Patent" at page 52 of the Opinion. Accordingly, Applicant respectfully disagrees with the Examiner's position that Freeny was not analyzed as a secondary reference in an obviousness context. Moreover, Applicant submits that, not only did the District Court consider Freeny as a secondary reference, but the Court also reasoned that Freeny teaches away from Applicant's claimed invention. See Opinion, page 52-53.

Applicant also respectfully points out that the District Court specifically considered the Examiner's primary reference, Akashi, in regard to obviousness in its Opinion. See Opinion, page 50. Although not binding on the Examiner in this proceeding, Applicant respectfully submits that a reasoned analysis by a competent Court should be regarded by the Examiner as strongly persuasive against the suggested combination of Freeny with Akashi and other references in the present Section 103(a) rejections.

A Prima Facie Case Of Obviousness Under 35 U.S.C. § 103(a) Over The Cited References Has Not Been Established In The Instant Office Action

MPEP 2144 explicitly requires the presentation of a rationale found “expressly or impliedly in the prior art or drawn from a convincing line of reasoning based on established scientific principles or legal precedent” in order to combine references under Section 103. Further, MPEP 2142 states that, “[t]o reach a proper determination under 35 U.S.C. 103, the examiner must step backward in time and into the shoes worn by the hypothetical ‘person of ordinary skill in the art’ when the invention was unknown and just before it was made.” These dual requirements ensure that an examiner does not fall into the trap of using hindsight based on his own knowledge of the Applicant’s disclosure to reconstruct the claimed invention from the prior art.

To avoid such hindsight reconstruction, the CAFC requires “a rigorous application of the requirement for a showing of the teaching or motivation to combine prior art references.” *In re Beasley* 117 Fed.Appx. 739, 742 (Fed. Cir. 2004). “This is consonant with the obligation of the Board [of Patent Appeals and Interferences] to develop an evidentiary basis for its factual findings to allow for judicial review under the substantial evidence standard that is both deferential and meaningful.” *Id.* at 742-43. Neither an examiner nor the Board is entitled rely only on their own knowledge as skilled artisans. *Id.* at 743.

Applicant respectfully submits that, even assuming each and every element of Claims 1-6 has been located in the combination of Akashi and Freeny, there nonetheless has been no showing that one having ordinary skill in the art at the time of Applicant’s invention, over 17 years ago, would have found the requisite motivation and reasonable expectation of success in

combining these references.² Because a rigorous showing of teaching or motivation to combine the cited references has not been provided as required by the CAFC, a *prima facie* case of obviousness has not been established.

Applicant will demonstrate that the cited combination of references does not establish a *prima facie* case of obviousness.

Akashi discloses an automated sales system for music on record albums. Akashi teaches a recording reproducing apparatus with a built-in computer communication means which is connected by a telephone line to a host computer storing data representing music on record albums or similar information such as the composers, list of music stores, musicians and the like. The data representing music on record albums is sent from the aforesaid host computer to the recording reproducing apparatus when the host computer is accessed by the aforesaid recording reproducing apparatus. See Akashi para. 4. The recording reproducing apparatus may be either a digital audio tape recorder or a compact disk deck that employs a write-once, read-many times recordable optical disk that allows data to be read immediately after the data is written. See Akashi para. 6.

As recognized by the Examiner, Akashi discloses no means or method whatsoever of effecting payment. As also recognized by the Examiner, Akashi does not teach or suggest a hard disk used by the purchaser to store the data.

Further, as set forth in the Declaration of Kenneth Pohlmann, attached as Exhibit B, Akashi does not teach any playback capability. Akashi is a simple inexpensive digital audio tape recorder or compact disk device that has the ability to communicate with a host computer to

² The '573 Patent has a priority date of June 13, 1988. Thus, Applicant's invention was made at least as early as that date.

download music from the host computer onto an audio tape or an optical disk. It is submitted that once the music is stored on the tape or the optical disk, the tape or optical disk is then removed and carried away by the purchaser to be listened to on a completely distinct playback device separate and remote from the tape recorder or compact disk device. See Pohlmann Dec. para. 14.

The Examiner cites Freeny for the provision of video data and the element of making a payment by electronic means. Applicant submits that Freeny is non-analogous to, and plainly teaches away from, Akashi. Freeny discloses a material object offered for sale and purchasable at a point-of-sale location. As disclosed in Freeny, the information used to manufacture a material object is stored locally at the point of sale, such as a kiosk. Only the authorization to make a copy is obtained from a remote location by a communication link at the time of the sale. Freeny, col. 5, ln. 32 to col. 6, ln. 11. This is directly contrary to Akashi which teaches acquiring a recording from a remote location at the time of the sale. It is well established that, “[i]f the proposed modification or combination of the prior art would change the principle of operation of the prior art invention being modified, then the teachings of the reference are insufficient to render the claims *prima facie* obvious.” *In re Ratti*, 270 F.2d 810, 123 USPQ 349 (CCPA 1959). Thus, on this basis alone, the teachings of Freeny cannot be combined with Akashi because Freeny teaches a system that operates in a fundamentally different way than Akashi.

Moreover, Applicant submits that the rationale provided for combining selected elements of Freeny with Akashi is inadequate to make out a *prima facie* case of obviousness. As held by the CAFC in *Beasley*, “*conclusory* statements of generalized advantages and convenient *assumptions* about skilled artisans...are *inadequate* to support a finding of motivation, which is a factual question that cannot be resolved on subjective belief and unknown authority.” *Id.* at

744. (emphasis added) In the first instance, Applicant respectfully submits that the motivation asserted by the Examiner in Freeny to modify Akashi for the sale of video information is precisely the type of conclusory and generalized statements of advantage that the CAFC has determined are inadequate to show obviousness. The portion of Freeny cited by the Examiner is notably from the Background section of the patent, which states, unsurprisingly, that manufacturing facilities and distribution systems are expensive. From this general statement in Freeny, the Examiner concludes it would have been obvious to one of ordinary skill in the art at the time of Applicant's invention to modify Akashi to provide video in addition to audio information to take advantage of cost savings from eliminating manufacturing facilities and distribution systems. Applicant submits this is not the necessary motivation to combine that must be found in the prior art or knowledge of one of ordinary skill in the art, as required by *In re Vaeck*, 947 F.2d 488, 493, 20 USPQ2d 1438, 1442 (Fed. Cir. 1991). Applicant respectfully submits that, instead, this is the type of hindsight reconstruction, based on the Applicant's disclosure, that the CAFC has repeatedly held to be improper. See *Teleflex, Inc. v. KSR International Co.*, 119 Fed.Appx. 282, 285-86 (Fed. Cir. 2005) ("Combining prior art references without evidence of...a suggestion, teaching, or motivation simply takes the inventor's disclosure as a blueprint for piecing together the prior art to defeat patentability--the essence of hindsight.")

What has not been shown is some teaching in either Akashi or Freeny, or the knowledge generally available to one of ordinary skill in the art at the time of Applicant's invention, which would lead a person without knowledge of the claimed invention, to modify Akashi to provide video rather than audio information from a remote system via communication lines. Further, the

Examiner has provided no showing of the required reasonable expectation of success in thus modifying Akashi.

With respect to the teaching in Freeny of an electronic payment, the cited section of Freeny refers to a process whereby an authorization to manufacture a material object is received from a remote location. The information from which the material object is manufactured is stored locally at the point of sale. There is no suggestion in Freeny or Akashi that transmission of audio or video information from a remote location can be triggered by providing credit card account information at the point of sale. Again, no prior art or knowledge generally available to one of skill in the art has been pointed to that would lead a person of skill in the art at the time of Applicant's invention to that conclusion. Applicant therefore respectfully requests that Akashi and Freeny be withdrawn as references in the present case.

For the reasons set for the above regarding the improper combination of Akashi and Freeny, Applicant submits that a *prima facie* case of obviousness has not been established with respect to any of Claims 1-6. Rather, it appears that the references were surveyed to find individual elements that the Examiner believes correspond to the elements recited in the claims, without regard to demonstrating some rational line of reasoning as to why it would have been obvious to one of ordinary skill in the art at the time of Applicant's invention to combine the references' divergent teachings. Indeed, the Examiner has apparently overlooked teachings of the references that demonstrate their incompatibility with each other and thus militate *against* their combination.

Applicant respectfully submits this is precisely the type of hindsight reconstruction that the CAFC has proscribed. See *In re Fritch; Teleflex, supra*. To avoid hindsight reconstruction, Examiners are required to apply a rigorous "showing of the teaching or motivation to combine

prior art references.” *In re Beasley*. Applicant does not believe the Examiner has met the foregoing burden in the current case. Applicant therefore respectfully requests reconsideration and withdrawal of the rejections of Claims 1-6 under 35 U.S.C. § 103(a).

Secondary Considerations Of Non-Obviousness

In the Office Action response filed on July 21, 2005, Applicant provided evidence of secondary considerations of non-obviousness, including evidence of commercial success of distribution systems employing the claimed invention. The Examiner has indicated that he did not find the secondary evidence provided by Applicant persuasive. In support of his conclusion, the Examiner stated that “Applicant has not provided proof that the claimed features were responsible for the commercial success of the mentioned distribution systems (i.e., iTunes).” See Office Action, para. 3. The Examiner cites to *Ex parte Remark*, 15 USPQ2d 1498, 1502 for the proposition that merely showing that there was commercial success of an article which embodied the invention is not sufficient to provide a secondary consideration of non-obviousness.³

In view of Applicant’s arguments refuting the Examiner’s rejection of Claims 1-6 under 35 U.S.C. § 103(a), presented above, Applicant respectfully submits that a showing of secondary considerations is not strictly necessary to establish the non-obviousness of Applicant’s invention. However, further in view of the fact that such secondary considerations in fact do exist, Applicant feels compelled to at least set forth below a summary of such indicia.

³ Additionally, the Examiner cites to certain comments the Examiner believes were made by the Inventor during an Examiner’s Interview concerning the unavailability of content for sale via his invention. Applicant believes the Examiner misunderstood the comments made by the Inventor during the Interview and respectfully disagrees with the Examiner’s recollection of those comments. Nonetheless, in view of the additional ample evidence of secondary indicia submitted with the current response, including the Declaration of Arthur R. Hair attached hereto as Exhibit C, Applicant believes it unnecessary to pursue this issue here.

The CAFC has explicitly set forth the factors, such as commercial success, long felt but unresolved needs, skepticism by experts, and copying by competitors that can be used to establish non-obviousness. *Brown & Williamson Tobacco Corp. v. Philip Morris Inc.*, 229 F.3d 1120, 1129 (Fed. Cir. 2000).

The CAFC has held that a nexus must be established between the merits of a claimed invention and the evidence of non-obviousness offered if that evidence is to be given substantial weight enroute to a conclusion of non-obviousness. *Remark* at 1502. The CAFC has also held, however, that copying of a patented feature or features of an invention, while other unpatented features are not copied, gives rise to an inference that there is a nexus between the patented feature and the commercial success. *Hughes Tool Company v. Dresser Industries, Inc.* 816 F.2d 1549, 1556 (Fed. Cir. 1987). Moreover, it is well established that copying of a patented invention, rather than one within the public domain, is by itself indicative of non-obviousness. See *Windsurfing International Inc., v. AMF, Inc.*, 782 F.2d 995, 1000 (Fed. Cir. 1986).

The Present Invention Has Been Copied By Others With Commercial Success

The invention recited in Claims 1-6 generally comprises transferring “for pay” digital video or digital audio signals between a first memory controlled by a seller and a second memory at a remote location controlled by a buyer over a telecommunication line. As set forth in the Declaration of Arthur R. Hair attached hereto as Exhibit C, the invention has in the past achieved significant commercial success.

Moreover, the invention continues to achieve commercial success in that it has been copied by a major participant in the field. The features of the invention generally included in Claims 1-6 have been copied by at least one commercially successful system available today: Napster Light. The Napster Light system (“Napster”) for purchasing digital music files online at

www.napster.com is a commercially successful system that embodies the features of the claimed invention. Applicant's assertion that Napster is commercially successful and has copied the claimed invention is supported by the Declaration of Justin Douglas Tygar, Ph.D., is attached to this response as Exhibit D. Dr. Tygar is a professor at the University of California, Berkley with a joint appointment in the Department of Electrical Engineering and Computer Science and the School of Information Management and Systems. See Tygar Dec., para. 1. Dr. Tygar is an expert in the field of computer science with significant experience in the field of electronic commerce. See Tygar Dec., paras. 2-4.

Dr. Tygar has determined that Napster has achieved a level of commercial success. See Tygar Dec., para. 6. Further, Dr. Tygar compared Napster to the invention recited in Claims 1-6 and determined Napster copied the invention. Specifically, Dr. Tygar found that Napster operates a music download system incorporating servers having hard disks and memory, through which it sells digital music files to a buyer for download over the internet. See Tygar Dec., para. 10. The buyer using Napster has a computer at a home, office, or other location remote from Napster. See Tygar Dec., para. 11. The buyer forms a connection between his or her computer and Napster via the Internet, selects digital music file(s) he or she wishes to purchase, provides a credit card number, and receives the music file via a download process where the file is transferred from Napster's server to the buyer's computer and stored on the hard drive. The buyer can then play the file using his or her computer system. See Tygar Dec., paras. 12-16. In view of this comparison, Dr. Tygar properly concludes that Napster has copied the features taught by the present invention. See Tygar Dec., para. 19.

Additionally, Applicant respectfully points out that Napster *does not* copy the closest prior art cited by the Examiner, i.e., Freeny and Akashi. Freeny teaches a point-of-sale device

(e.g., a kiosk) that dispenses a material object (e.g., tape) containing the music purchased. See Freeny, col. 1, line 64 to col. 2, line 12. These features of Freeny are plainly not found in Napster Light. See Tygar Dec., para. 16. Akashi teaches writing data to a digital audio tape recorder or a compact disk deck that employs a write-once, read-many times recordable optical disk which allows data to be read immediately after the data is written. The user downloads data to a RAM and then the data is written directly from the RAM to a recordable optical disk. See Akashi para. 6. This process of Akashi is not how Napster Light operates. See Tygar Dec. para. 18.

Therefore, it is apparent that Napster chose to copy the system taught by the '573 patent. See Tygar Dec. para. 19. It is also apparent that Napster choose *not* to copy the prior art systems of Freeny and Akashi. See Tygar Dec. para. 20 and 21. Applicant submits this selective copying by Napster of the invention recited in Claims 1-6, while Napster ignored the systems of Freeny and Akashi, provides a sound basis upon which the required nexus between commercial success and Applicant's claimed invention can be found. See *Hughes Tool*, 816 F.2d at 1556. Additionally, Napster's selective copying of Applicant's invention, coupled with Napster's disregard of the Freeny and Akashi systems, is itself substantive evidence of a recognized secondary indication of non-obviousness. See *Windsurfing International Inc.*, 782 F.2d 995.

Applicant therefore respectfully submits that the foregoing remarks and the attached Declaration of Dr. Tygar have established the requisite nexus between the commercial success of Napster and Applicant's claimed invention. Applicant also respectfully submits that these remarks and the attached Declaration of Dr. Tygar similarly have established copying by Napster as a secondary indicia of non-obviousness.

Newly Added Claims Are Not Taught by the Prior Art

It is well established that, in order to establish a *prima facie* case of obviousness of a claimed invention, all limitations must be taught or suggested by the prior art. *In re Royka*, 490 F.2d 981, 180 USPQ 580 (CCPA 1974), MPEP §2143.03. The elements added via newly presented Claims 7-43 are not taught or suggested in the cited prior art, i.e., Akashi and Freeny, or in any other art cited in the related co-pending reexaminations for U.S. Patent No. 5,675,734 and U.S. Patent No. 5,966,440. The newly added claims comprise various combinations of the following limitations, as applied to both digital audio signals and digital video signals:

- a) listing/scrolling the digital signals from the second memory (Claims 7-21, 24, 28, 31, 35, 39);
- b) displaying a name of a digital signal from the second memory (Claims 9, 16, 25, 32, 36)
- c) displaying a duration of the digital signal from the second memory (Claims 10, 18, 29-34);
- d) displaying a name of an artist of the digital signal from the second memory (Claims 11, 19, 26-28, 37-39);
- e) displaying a name of an album associated with the digital signal from the second memory (Claims 12 and 20); and
- f) randomly selecting digital signals from the second memory by a second party integrated circuit of a second party control unit (Claims 13, 22-25, 33-36).

All of the limitations set forth above involve features surrounding playback from the second memory. None of these limitations are taught in Akashi or Freeny.

More specifically, limitation (a) set forth above is listing/scrolling the digital signals from the second memory. Akashi teaches a recording reproducing apparatus that either may be a digital audio tape recorder or a compact disk deck which employs a write-once, read-many times recordable optical disk. Akashi does not teach any listing/scrolling feature of a second memory. Freeny teaches using information stored locally at the point of sale (e.g., kiosk) to manufacture a material object. There is no teaching of listing/scrolling digital signals from the second memory in Freeny.

Limitations (b), (c), (d) and (e) set forth above all provide for displaying information from the second memory regarding the digital audio or digital video signal. Specifically, a name, duration, name of an artist, and name of an album are displayed. Neither Akashi nor Freeny teaches or suggests any display features concerning information in the second memory.

Limitation (f) set forth above is randomly selecting digital signals from the second memory by a second party integrated circuit of a second party control unit. Neither Akashi or Freeny teaches or suggests a second party integrated circuit of a second party control unit that allows for random selection of the digital signal. No random selection of signals by any means is taught or suggested in either reference.

As a result, in addition to being allowable for the reasons previously set forth concerning Claims 1 through 6, Applicant respectfully submits that the newly added claims are allowable for the further reason that the limitations found in the newly added claims are not taught or suggested by the prior art.

CONCLUSION

Applicant believes the foregoing remarks have overcome or rendered moot all grounds for rejection of original Claims 1-6 and any potential grounds for rejection of newly added Claims 7-43. Applicant therefore believes that all such claims are patentable over the art cited by the Examiner. There being no other rejections or objections of record, Applicant believes that the application is in condition for allowance.

Applicant understands, however, that the Examiner may have additional questions or concerns prior to allowing Applicant's claims. Applicant therefore respectfully requests that the Examiner contact Applicant's undersigned attorney directly to schedule an Interview before the Examiner takes any further action in this case.

Respectfully submitted,

DRINKER BIDDLE & REATH LLP



Robert A. Keons, Jr.
Registration No. 32,474

DRINKER BIDDLE & REATH LLP
One Logan Square
18th & Cherry Streets
Philadelphia, PA 19103-6996
Telephone: (215) 988-3392
Facsimile: (215) 988-2757

CERTIFICATE OF SERVICE

The undersigned hereby certifies that a true and correct copy of the foregoing Response in Reexamination No. 90/007,402 was served via First Class United States Mail, postage prepaid, this 27th day of December, 2005, on the following:

Mr. Albert S. Penilla
Martine, Penilla, & Gencarella, LLP
710 Lakeway Drive, Suite 200
Sunnyvale, CA 94085
Attorney for Third Party Reexamination Requester

By: 
Robert A. Koons, Jr.
Attorney for Patentee

IN THE UNITED STATES PATENT AND TRADEMARK OFFICE

In re Application of:)
ARTHUR R. HAIR)
Reexamination Control No. 90/007,402)
Reexamination Filed: January 31, 2005) A SYSTEM FOR TRANSMITTING
Patent Number: 5,191,573) DESIRED DIGITAL VIDEO OR
Examiner: Benjamin E. Lanier) AUDIO SIGNALS
)

December 23, 2005

Mail Stop *Ex Parte* Reexamination
Commissioner for Patents
P.O. Box 1450
Alexandria, VA 22313-1450

DECLARATION UNDER 37 C.F.R. §1.132

I, Justin Douglas Tygar, hereby declare that:

1. I am a tenured, full Professor at the University of California, Berkeley with a joint appointment in the Department of Electrical Engineering and Computer Science (Computer Science Division) and the School of Information Management and Systems.
2. I earned an A.B. degree in Math/Computer Science from the University of California, Berkeley, in 1982 and I earned a Ph.D. in Computer Science from Harvard University in 1986.
3. I am an expert in software engineering, computer security, and cryptography. I have taught courses in software engineering and computer security at the

undergraduate, master's, and doctorate level at both the University of California, Berkeley and Carnegie Mellon University.

4. I serve in a number of capacities on government, academic, and industrial committees that give advice or set standards in security and electronic commerce. In addition, I have authored numerous publications in the fields of computer science and security in electronic commerce. I have attached a copy of a recent curriculum vita to this declaration as Exhibit A.

5. At the request of counsel, I have compared a currently available system for purchasing digital audio files, namely the online music service offered at www.napster.com known as Napster Light¹ (hereinafter "Napster Light"), with the teachings of U.S. Patent 5,191,573 (the "'573 patent").

6. Napster Light is a currently operating service with an apparently wide user base. It is therefore apparent that Napster Light, which uses the teachings of the '734 Patent, has been commercially successful.

7. The '573 Patent generally discloses a method pertaining to the electronic sale and transfer of digital audio or video signals, which are signals containing recorded sound or

¹ It should be noted that the Napster Light service offered by the entity known currently as Napster, Inc. at www.napster.com is separate and distinct from a previous file sharing on-line service offered by an earlier entity entitled Napster. It is my understanding that this prior entity went out of business in 2002, at which time Roxio, Inc. acquired the Napster name and trademark rights. Subsequently, Roxio, Inc. changed their name to Napster, Inc., thus creating the current entity referred to herein as "the new Napster, Inc."

video, such as a musical or video recording, converted into binary form. The steps of the method pertain to the following:

- A first party who is a seller of digital audio or video signals through telecommunication lines. Telecommunication lines can include the Internet. The seller must have control over a computer memory, which includes a hard disk and RAM. The hard disk includes copies of encoded digital audio or video signals, which are the digital audio or video signals configured in a form that would prevent unauthorized copying.

- A second party who is a buyer of the digital audio or video signals. The buyer must possess and control his or her own computer memory. The buyer's memory must be located at a location remote from the location of the memory controlled by the seller.

8. The invention of the '573 patent comprises a number of steps, though not in any particular order except as indicated below. The steps are:

- Forming an end-to-end electronic connection over the telecommunications lines between the computer memory controlled by the seller and the buyer's computer memory, which is controlled by the buyer;

- Transmitting the desired digital audio signal from the first memory to the second memory; and

- Storing the transferred copy of the digital audio or video signals in the buyer's memory.

9. I have accessed Napster Light for the purpose of comparing it to the '734 patent. Based on my review, I have determined the following facts set forth in paragraphs 10 through 20 of this declaration.

10. The operator of Napster Light (i.e., the new Napster, Inc.), the "first party" for the purposes of this comparison, operates a music download system through which digital music files are sold to buyers for download over the internet. The digital music files contain digital representations of sound recordings. I have concluded from viewing information on www.napster.com that Napster Light uses a system that includes servers, which have memory that includes hard disks that store digital music for sale over the internet. The new Napster, Inc. appears to control the servers that contain the digital music files for sale.

11. The typical online buyer using Napster Light, the "second party" for the purposes of this comparison, controls a personal computer. For instance, the buyer controls which software to install and run on the computer, what data to store in the computer, and when to operate the computer. The buyer has the computer at a home, office, or other location remote from Napster Light.

12. Using a software application downloaded from a website associated with Napster Light, the online buyer may connect to Napster Light's online music library over the Internet and browse online music catalogs. The buyer forms a connection between his or her computer and the Internet through an Internet Service Provider (ISP) that may be accessed via a dial-up connection using a modem and a telephone line.

13. Using the downloaded software application, the online buyer browses Napster Light's online music catalogs. The online buyer can select a particular digital music file he or she desires.

14. The digital music file is delivered to the online buyer via a download operation that is automatically initiated between Napster Light's servers and the online buyer's computer.

15. The download process occurs by transmitting a copy of the digital music file over the Internet to the online buyer's computer. The transmitted copy is stored in the online buyer's computer hard drive. Throughout this downloading process, the online buyer is in control of his or her computer's memory.

16. The downloaded copy of the digital music is stored to the hard drive of the buyer's computer, from which it can be written to other media such as an optical disk or memory of a portable device.

17. Napster Light does not include a point-of-sale device such as a kiosk, as used in United States Patent No. 4,528,643 to Freeny (the "Freeny Patent").

18. Napster Light does not writing a digital signal from memory directly to an optical disk or digital tape, as taught in Japanese Patent Publication 62-284496 to Akashi (the "Akashi Patent").

19. In view of the foregoing, I have determined that Napster Light embodies the elements taught in the '573 Patent. As a result, it can be concluded that Napster Light has copied the teachings of the '573 Patent.

20. Also in view of the foregoing, I have determined that the Napster system does not embody essential elements of the Freeny patent. As a result, it can be concluded that Napster Light has not copied the Freeny patent.

21. Also in view of the foregoing, I have determined that the Napster system does not embody essential elements of the Akashi patent. As a result, it can be concluded that Napster Light has not copied the Akashi patent.

I further declare that all statements made herein of my own knowledge are true and that all statements made on information and belief are believed to be true; and further, that these statements are made with the knowledge that willful false statements and the like so made are punishable by fine or imprisonment, or both, under Section 1001 of Title 18 of the United States Code, and that such willful false statements may jeopardize the validity of the application or any patent issuing thereon.

26 Dec 05
Date

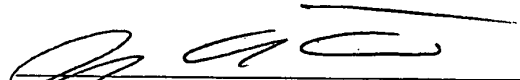
Justin Douglas Tygar, Ph.D.

IN THE UNITED STATES PATENT AND TRADEMARK OFFICE

In re Application of:)
)
ARTHUR R. HAIR)
)
Reexamination Control No. 90/007,402)
)
Reexamination Filed: January 31, 2005) METHOD FOR TRANSMITTING A
) DESIRED DIGITAL VIDEO OR
Patent Number: 5,191,573) AUDIO SIGNALS
)
Examiner: Benjamin E. Lanier	

Pittsburgh, Pennsylvania 15213

December 23, 2005

Mail Stop *Ex Parte* Reexamination
 Commissioner for Patents
 P.O. Box 1450
 Alexandria, VA 22313-1450

DECLARATION UNDER 37 C.F.R. §1.132

I, Arthur R. Hair, hereby declare that:

1. I am the sole inventor of United States Patent Nos. 5,191,573; 5,675,734; and 5,966,440.
2. I am Chairman of the Board and Chief Technology Officer of SightSound Technologies, Inc.
3. I assigned my rights in United States Patent Nos. 5,191,573; 5,675,734; and 5,966,440 to the company that ultimately became SightSound Technologies, Inc (“SightSound”).
 These patents served SightSound Technologies well and were essential in raising the

capital necessary to launch a company that would build eCommerce systems protected by the patents.

4. With the foregoing three patents in hand, SightSound Technologies achieved many notable firsts, including:
 - first to electronically sell a music download via the Internet;
 - first to electronically sell a movie download via the Internet;
 - first to produce a motion picture specifically for simultaneous electronic distribution worldwide via the Internet;
 - first to electronically sell encrypted movies legally through the Gnutella file-sharing networks, without being in violation of copyrights;
 - first to develop a legal system to sell encrypted music legally through the Napster file-sharing networks, without being in violation of copyrights;
 - first to electronically sell a movie into a movie theater projection booth via the Internet for digital exhibition from a windows workstation; and
 - first to electronically sell a movie into a handheld unit, a Compaq iPac Pocket PC.

5. SightSound built five Media eCommerce Systems. Over time, these systems grew from a single server located in Pittsburgh to a geographically distributed system with a central core in Pittsburgh that controlled remote servers located in New York, Los Angeles, Santa Clara, Seattle, Chicago, Washington D.C. and Boston. Version 1 was built in 1995

and Version 2 was built in 1998, both of these versions only sold music. Version 3.1, 3.2 and 3.3 were built between 1999 and 2001 and sold both music and movies. The fifth system built at SightSound Technologies (which we called Version 3.3) was a fully automated, database driven secure Media eCommerce System that had the hardware capacity to rent and/or sell 380,000 movies a day.

6. The foregoing Media eCommerce Systems were covered by one or more claims in each of United States Patent Nos. 5,141,573, 5,675,734 and 5,966,440.

7. The Media eCommerce Systems were designed to support:
 - official movie websites;
 - banner ads that automatically invoke a download;
 - digital cinema (download to the projection booth);
 - portable audio/video devices
 - database driven websites; and
 - peer-to-peer file-sharing networks.

8. Using its Media eCommerce Systems, SightSound Technologies provided client services releasing motion pictures and music for Internet download sale for more than 40 filmmakers, special interest video production companies and recording artists. SightSound Technologies first offered music for sale via the Internet in download fashion in September 1995. At that time, SightSound Technologies offered music from the band

“The Gathering Field.” Individual songs were priced at 99 cents and the entire album was available for \$6.00. SightSound Technologies went on to build a respectable client roster that included over 65 companies and individuals, including:

- Miramax Films (a subsidiary of the Walt Disney Company)
- Showtime Networks (the Tyson –vs– Norris boxing match)
- Comedy Central (half owned by Fox and half owned by Warner Brothers)
- Lyric Studios (the children’s television program “Barney”)
- WQED TV

9. I have attached as part of this Declaration several announcements and media coverage illustrating the many accomplishments that United States Patent Nos. 5,191,573; 5,675,734; and 5,966,440 assisted SightSound Technologies to achieve.

I further declare that all statements made herein of my own knowledge are true and that all statements made on information and belief are believed to be true; and further, that these statements are made with the knowledge that willful false statements and the like so made are punishable by fine or imprisonment, or both, under Section 1001 of Title 18 of the United States Code, and that such willful false statements may jeopardize the validity of the application or any patent issuing thereon.

23 DECEMBER 2005
Date

Arthur R. Hair
Arthur R. Hair

IN THE UNITED STATES PATENT AND TRADEMARK OFFICE

In re Application of:)
)
ARTHUR R. HAIR)
)
Reexamination Control No. 90/007,402)
)
Reexamination Filed: January 31, 2005) METHOD FOR TRANSMITTING
) A DESIRED DIGITAL VIDEO OR
Patent Number: 5,191,573) AUDIO SIGNAL
)
Examiner: Benjamin E. Lanier

Mail Stop *Ex Parte* Reexamination
Commissioner for Patents
P.O. Box 1450
Alexandria, VA 22313-1450

Sir:

DECLARATION UNDER 37 C.F.R. § 1.132

I, Kenneth C. Pohlmann declare that,

1. I am a tenured Professor at the University of Miami in Coral Gables, Florida, and the director of the Music Engineering Technology program at the University's Frost School of Music. I have been a faculty member at the University of Miami since 1977.

2. I hold Bachelor of Science and Master of Science degrees in Electrical Engineering from the University of Illinois in Urbana-Champaign. My master's thesis was completed in 1976 and described the use of a digital computer to enter, store and play back digitally synthesized music. I have been continuously involved in digital audio

technology since that time, and have a good personal knowledge of the progress of the state of the art over the intervening years.

3. In 1986 I founded the first Masters degree program in Music Engineering Technology in the United States. I have initiated new undergraduate and graduate courses in digital audio, advanced digital audio, Internet audio, acoustics and psychoacoustics, and studio production.

4. I have written or co-authored several books, including "Principles of Digital Audio" (McGraw-Hill), "The Compact Disc Handbook" (A-R Editions), and "Advanced Digital Audio" (Howard W. Sams). My books have been translated into Dutch, German, Spanish, and Chinese.

5. Since 1982, I have written numerous articles for publications including Audio magazine, dB magazine, Handbook for Sound Engineers, IEEE Spectrum, Journal of the Audio Engineering Society, National Association of Broadcasters Handbook, PC magazine, Scientific American, and World Book Encyclopedia. Additionally, I am a contributing technical editor and columnist for Sound & Vision magazine.

6. I chaired the Audio Engineering Society's International Conference on Digital Audio in Toronto in 1989 and co-chaired the Society's International Conference on Internet Audio in Seattle in 1997. I was presented two AES Board of Governor's Awards (1989 and 1998) and an AES Fellowship Award (1990) by the Audio Engineering Society for my work as an educator and author in the field of audio engineering. In 1991, I was elected to serve on the AES Board of Governors, and in 1993 to serve as the AES Vice President of the Eastern U.S. and Canada Region.

7. I serve as a consultant in the design of digital audio systems, the development of sound systems for automobile manufacturers, and as a consultant and expert witness in music technology and related patent litigation. I have attached a copy of a recent *curriculum vitae* to this declaration as Exhibit A.

8. Sightsound's counsel requested that I evaluate Great Britain Patent App. No. 2-178-275-A, filed by Bernard Gallagher ("Gallagher"), U.S. Patent 4,528,643 ("Freeny"), Japanese Patent No. 62-284496 ("Akashi"), U.S. Patent 4,896,2327 ("Ohta"), U.S. Patent 4,920,432 ("Eggers"), U.S. Patent 4,792,974 ("Chace"), and U.S. Patent 4,739,398 ("Thomas") separately and in combination in the context of whether their respective disclosures are compatible, and whether there is some teaching in their disclosures that would suggest combining them.

9. In the context of my work on this matter, I have drawn on my experience and knowledge as a researcher and professor of music engineering, digital audio and studio production. As an electrical engineer, for many years I have kept abreast of developments in electronics and audio, including reading technical magazines, journals, and research papers on the topics of recorded music and audio systems.

10. In preparation for my evaluation regarding the Gallagher, Freeny, Akashi, Thomas, Eggers, Chace, and Ohta documents, I familiarized myself with the following materials: Preliminary and Supplemental Amendments of the Hair application (serial no. 09/286,892) and the Patent Office Detailed Action dated April 5, 2005 for that application; U.K. patent application 2-178-275-A ("Gallagher"); U.S. Patent 4,528,643 ("Freeny"); Japanese Patent No. 62-284496 ("Akashi"); U.S. Patent 4,896,2327 ("Ohta"), U.S. Patent

4,920,432 (“Eggers”); U.S. Patent 4,792,974 (“Chace”); U.S. Patent 4,739,398 (“Thomas”); as well as U.S. Patent No. 5,191,573 (“the ‘573 Patent”), U.S. Patent No. 5,675,734 (“the ‘734 Patent”) and U.S. Patent No. 5,966,440 (“the ‘440 Patent”) (collectively, the “Hair Patents”); and the Patent Office Detailed Action October 26, 2005 for the Reexamination of the ‘440 Patent, the Patent Office Detailed Action October 26, 2005 for the Reexamination of the ‘734 Patent, and the Patent Office Detailed Action October 26, 2005 for the Reexamination of the ‘573 Patent.

11. The following discussions present the results of my review of the Gallagher, Akashi, Eggers, Thomas, Chace, Ohta, and Freeny references in the context described above. This discussion also draws upon my general knowledge, information and belief as an expert in music engineering, digital audio and studio production.

EVALUATION OF THE REFERENCES

12. I have reviewed the reference referred to as Akashi. In Akashi, there is disclosed an automated sales system for music on record albums. Akashi teaches a recording reproducing apparatus with a built-in computer communication means connected by a telephone line to a host computer storing data representing music on record albums and other information on the record albums such as the composers, list of music stores, musicians and the like. The data representing the music on record albums is sent from the host computer to the recording reproducing apparatus when the host computer is accessed by the recording reproducing apparatus. See paragraph 4 of Akashi. The recording reproducing apparatus may be either a digital audio tape recorder or a compact disk deck that employs a write-once, read-many recordable optical disk that allows data to be read immediately after the data is written. See paragraph 6 of Akashi.

13. On reviewing Akashi, I find that Akashi reveals no means or method whatsoever of effecting payment. Further, I find that Akashi does not discuss any method or structure for playback of the downloaded music. Akashi also does not teach or suggest a hard disk used by the purchaser to store the digital signals. Akashi further does not teach or suggest digital video signals.

14. Akashi is an inexpensive digital audio tape recorder or compact disk device that has the ability to communicate with a host computer to download music from the host computer onto an audio tape or an optical disk. It is further apparent from the disclosure of Akashi that once the music is stored on the tape or the optical disk, the tape or optical disk is then removed and carried away by the purchaser to be listened to on a completely distinct playback device separate and remote from the tape recorder or compact disk device.

15. I have reviewed the reference referred to as Freeny. Freeny discloses sale of a material object, purchasable at a point-of-sale location. This is contrary to the teaching of Akashi, which discloses sending data representing music on record albums from a host computer to a recording reproducing apparatus when the host computer is accessed by the recording reproducing apparatus.

16. Freeny contains no disclosure that would lead one to believe that its method of credit card payment would be applicable to any other system than the one disclosed in Freeny. The system disclosed by Freeny simply requires obtaining a credit card authorization from a remote location. Once the authorization is obtained, all copying of audio and video is from information stored locally at the point of sale.

17. I have reviewed the reference referred to as Gallagher. Gallagher discloses a recorded data transfer system. The system taught by Gallagher comprises a data base, user units and a source unit. The data is transferred from the source unit to the data base where it is processed for storage in library form whereby selected data can be transmitted to any user and/or source unit in national or foreign territories. See column 1, lines 39-43 of Gallagher. The source unit could belong to a recording artist, the main unit to a major record company and user units to the general public. The artist would transfer the master mix to the record company who would store it, having processed it if necessary, and recall it, when necessary for sale to the general public via their user units. See lines 39-50 of page 1 of Gallagher.

18. Gallagher teaches the user unit comprises a parallel receiver/transmitter 30, a serial/parallel and parallel/serial converter 31, a storage medium 32 such as videotape or optical disk, a decoder 33 and suitable conversion apparatus 34 for audio and/or visual reproduction, means for storing/recalling and/or processing data received from the data banks. See lines 19-23 and 87-92 of page 1 of Gallagher. A playback apparatus is also taught to be part of the user unit. See the abstract of Gallagher.

19. Similar to Akashi, Gallagher does not teach a hard disk associated with the user unit, digital video signals, any way of effecting payment, or an integrated circuit with the user unit. Gallagher also does not teach a video display.

20. Gallagher is a data transfer system with a simple inexpensive user unit that can receive encrypted recorded music and store it on a videotape or optical disk. The user unit can then listen to the music that has been downloaded from the data base with means

for storing/recalling the received data of a playback apparatus, but because of the concerns regarding piracy which dictate the encryption of the music, the user unit may only receive the recorded material.

21. In order to combine the teachings of Gallagher with Akashi would dictate a wholesale conversion and redesign of the recording reproducing apparatus of Akashi to a single unit recording reproducing apparatus and audio playback device as taught by Gallagher. It requires that Akashi be somehow or other redesigned to include audio playback components. This would not be obvious to one skilled in the art.

22. This encryption teaching also dictates the further teaching in the context of Gallagher that the user unit may only receive recorded material, (page 1, lines 95 and 96 of Gallagher- in contrast the source unit and the database can both also send recorded material) and for the teaching of eliminating the possibility of material being used to be borrowed or copied (page 1, lines 98 and 99 of Gallagher). The teaching of encryption and the specific teachings to eliminate material being borrowed or copied, completely precludes the commercial operability of the recording reproducing apparatus of Akashi if the teachings of Gallagher were applied to Akashi. This is because Akashi does not teach or suggest the play back to occur in the recording reproducing apparatus itself, but the optical disk or the tape be carried away from the recording reproducing apparatus and played somewhere else. For the optical disk or the tape to be carried away from the recording reproducing apparatus, as found in Akashi, directly conflicts with the teachings of Gallagher that the user unit may only receive information and play it at the user unit, and that the possibility of the received material being usefully borrowed or copied is eliminated. Carrying the optical disk or tape away from the recording reproducing

apparatus to be played someplace else means that the tape or disk can be copied or is being borrowed and that the received information is not just being received and played at the user unit. Thus, the teachings of Gallagher cannot be combined with the teachings of Akashi because the recording reproducing apparatus taught by Akashi would be commercially unusable since the purchaser could then not carry the tape or optical disk away from the recording reproducing apparatus and play it someplace else so it could be listened to.

23. Similar to my analysis of Akashi, there is no indication in either of Gallagher or Freeny that the credit card payment method of Freeny would be applicable to the system of Gallagher.

24. There is no teaching or suggestion in Akashi, Freeny or Gallagher to combine their teachings. Akashi and Gallagher both teach specifically designed simple devices for their respective purpose. Nowhere does Akashi teach or suggest the need, or the desire to be modified to include playback capabilities. In fact, this would add substantial relative cost to the device taught by Akashi which would be a deterrent to add or redesign the recording reproducing apparatus taught by Akashi. Similarly, there is no teaching or suggestion anywhere in Gallagher that the user units be simply a receiver. To redesign the recording reproducing apparatus of Akashi into a player would also be contrary to the operation of the apparatus taught by Akashi, which is to take the audio tape or optical disk to a separate device for playback. Also, as noted above, the acquisition of audio information from a separate remote database in Akashi and Gallagher is fundamentally different from the copying of information stored at a point of sale location as in Freeny. There is no indication that the credit card payment method in Freeny could be modified to work with either Akashi or Gallagher.

25. I have reviewed the reference referred to as Chace. Chace discloses an automated stereo synthesizer for audiovisual programs. Chace teaches a method and apparatus for converting the monaural audio tracks of audiovisual programs into surround stereo signal which are mono-compatible and storable and which are synchronized with the video portion of the program. See column 1, lines 5-12. Chace teaches a conventional television monitor 12 receives the video signals from a VCR 10 and displays the video program on the monitor display screen. A video time code is also displayed in a code display region 14 of the monitor's screen. The working cassette is played by the VCR 10 in order to program the sound cues. The sound cues are a series of commands which are selected and programmed into a system computer 16 by an operator who watches the video program being displayed on the monitor 12. These sound cues are used during a play back mode of operation to alter the signals which are produced by a monaural sound track and thus create stereo sound signals. See column 5, lines 50-69.

26. Chace teaches a system that does not address distribution of audio and/or video information as in Akashi, Freeny and Gallagher. There is no teaching or suggestion whatsoever regarding the transfer of audio or video digital signals between a first party and a second party. The architecture that is involved with the method and apparatus taught by Chace is basically a television, a VCR connected to the television and a computer 16 for programming the sound cues. It is therefore apparent that Chace has nothing at all to do with the systems disclosed by Akashi, Freeny and Gallagher.

27. There is no reason to combine the teachings of Chace with the teachings of the other references for the reason stated above. Further, neither Akashi nor Freeny teach or suggest play back of the recording produced. Thus, Akashi and Freeny not only do

not teach or suggest combining their teachings with Chace, but have no need or desire for being able to play stereo from a monaural sound track.

28. I have reviewed the reference referred to as Eggers. Eggers discloses a system for random access to an audio/video data library with independent selection and display at each of a plurality of remote locations. Eggers teaches a modified vendor model. A second party is given the privilege of using the audio/video data library when the second party views or listens to the video or audio data in the hotel room or in the hospital room in which the second party resides.

29. Eggers teaches there is a need for selective access to pre-recorded audio-video data from a common library in which selection and display may be at any of a plurality of remote locations for providing information and entertainment to occupants of hotels, hospitals, and the like. See column 1, lines 35-42. Eggers teaches that in a hotel that devices such as message monitors 7 may inform room service that a guest has placed a food order. See column 4, lines 51 and 52.

30. Eggers teaches that the common library of audio and video titles is stored as a collection of video tape cartridges. See abstract and column 3, line 38. The collection is accessed using a mechanical retrieval filer that transports the discrete tape cartridges to playback devices. See column 3, lines 36-40. The audio and video information itself is not distributed remotely or stored remotely. Further, Eggers does not discuss the production of copies of the audio or video information. In both of these respects, Eggers is in contrast to Akashi and Gallagher which distribute copies audio information from a remote location.

Eggers is also contrary to Freeny, which leaves a purchaser in possession of a material object embodying the audio and/or video information.

31. On reviewing Eggers, it is apparent that its primary purpose is to provide access to a library of recorded audio or video information, which can be accessed for viewing, but not copying. There is no indication in Eggers of the desirability of allowing a user to produce a copy of the audio or video information. In contrast, the main purpose of Akashi, Freeny and Gallagher is to allow a user to make a copy of desired audio and/or video information.

32. I have reviewed the reference referred to as Thomas. Thomas discloses a method, apparatus and a system for recognizing broadcast segments. Thomas teaches that the method, apparatus and system relate to the automatic recognition of broadcast segments, particularly commercial advertisements broadcast by television stations. Thomas teaches that it is an object to provide an automated method, apparatus and system for logging commercial broadcast data which does not rely for recognition on the insertion of special codes or run cues occurring in the signal. Real time continuous pattern recognition of broadcast segment is accomplished by constructing a digital signature from a known specimen of a segment which is to be recognized. See column 1, lines 6-9 and 27-43.

33. Thomas uses a workstation to construct a digital signal from a known specimen of a segment which is to be recognized, which is the key to achieving the object of the method, apparatus and system taught by Thomas. Thomas is totally silent in regard

to the commercial distribution of audio or video information. The disclosure of Thomas is simply unrelated to any of Akashi, Freeny, Gallagher, Eggers or Chace.

34. I have reviewed the reference referred to by the examiner as Ohta. Ohta, discloses a magnetic tape cartridge compatible with a disk drive and tape drive mechanism therefore. On reviewing Ohta, it is completely silent regarding the download of audio or video digital signals between a first party and a second party. Ohta is drawn solely to a particular design for a removable magnetic tape cartridge. There is no indication in Ohta that its teaching that some computers have hard drives would be particularly valuable to one having knowledge of any of Akashi, Freeny, Gallagher, Eggers, Thomas or Chace.

35. I further declare that all statements made herein of my own knowledge are true and that all statements made on information and belief are believed to be true; and further, that these statements are made with the knowledge that willful false statements in the like so made are punishable by fine or imprisonment, or both, under Section 1001 of Title 18 of the United States Code, and that such willful false statements may jeopardize the validity of the application or any patent issuing thereon.

Dated:

12/23/2005

By:

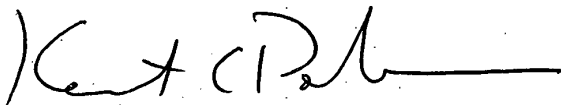

Kenneth C. Pohlmann

EXHIBIT A

KENNETH C. POHLMANN
University of Miami
Frost School of Music
1314 Miller Drive
Coral Gables, FL 33124
(305) 284-5995
(305) 284-4448 fax
pohlmann@miami.edu

HIGHER EDUCATION

Master of Science in Electrical Engineering, 1976

University of Illinois in Urbana-Champaign, Illinois

Bachelor of Science in Electrical Engineering, 1974

University of Illinois in Urbana-Champaign, Illinois

ACADEMIC EMPLOYMENT

Professor of Music (tenured), University of Miami, School of Music, 1987 -

Director of Music Engineering, University of Miami, School of Music, 1983 -

Department Chairman, Music Media and Industry, University of Miami, School of Music, 1993-1998

Assistant Director of Music Engineering, University of Miami, School of Music, 1977-83

PUBLICATIONS

BOOKS

Principles of Digital Audio, McGraw-Hill, Inc., 5th edition, March, 2005

Principles of Digital Audio, McGraw-Hill, Inc., 4th edition, 2002 (Chinese translation)

Principles of Digital Audio, McGraw-Hill, Inc., 4th edition, 2002 (Spanish translation)

Principles of Digital Audio, McGraw-Hill, Inc., 4th edition, 2000

Writing for New Media: The Essential Guide to Writing for Interactive Media, CD-ROMs, and the Web, John Wiley & Sons, Inc., 1998 (co-author)

Compact Disc Handbuch, International Thompson Publishing, 1994 (German translation)

The Compact Disc Handbook, A-R Editions, Inc., Oxford University Press, 1989, 2nd edition, 1992

Advanced Digital Audio, Howard W. Sams & Co., Inc., 1991 (editor, co-author)

Digitale Audio Principes, Registratie En Opslag, Kluwer Technische Boeken, 1988. (Dutch translation)

ARTICLES/PAPERS

"Audio Compression using Repetitive Structures," co-inventor, Patent application filed USPTO, February 3, 2005

"High Frequency Effects on Localization and Sound Perception in a Small Acoustic Space," presented to the Society of Automotive Engineers. 2002 (co-author)

"Compact Discs, SACD and DVD," Handbook for Sound Engineers, Focal Press,, 3rd edition, 2002

"Music Wars," Scientific American, November, 2000

"Compact Disk," McGraw-Hill Encyclopedia of Science & Technology, 9th edition, 2000

"Compact Disk," McGraw-Hill Yearbook of Science & Technology, 1999

<http://www.music.miami.edu>, 1995 (co-author)

"Digital Audio Technology," National Association of Broadcasters Handbook, 8th Edition, 1992

"Compact Discs," Handbook for Sound Engineers, Howard W. Sams & Co., Inc., 2nd edition, 1991

"Residue Method for the Objective Evaluation of Digital Program

Degradation," AES Convention, October, 1991 (co-author)

"The Compact Disc," NARAS Journal, 1990

"Compact Disc Recording Technologies: State of the Art," The CD-ROM Yearbook, 1989

"Preface and Conference Opening Remarks," Proceedings of the AES 7th International Conference - Audio in Digital Times, May 14-17, 1989

"The Compact Disc Formats: Technology and Applications," Journal of the Audio Engineering Society, April, 1988

"Technical Overview of the CD-I Format," The Proceedings of the AES 5th International Conference, May 1-3, 1987

OTHER PUBLICATIONS

Author of more than 2,200 published articles for periodicals including:

Audio, Billboard, Car Stereo Review, dB, Digital Audio and Compact Disc

Review, Digital Recording Report, Electronics Australia, IEEE Spectrum,

Journal of the Audio Engineering Society, Laserdisk Professional, Mix,

Mobile Entertainment, PC Magazine, Scientific American, Sound and Image, Sound and Vision, Spektrum der Wissenschaft, Stereo Review, and Video Magazine, World Book Encyclopedia

Editorial responsibilities include:

Contributing technical editor, regular columnist for Sound and Vision Magazine

Contributing technical editor, regular columnist for Mobile Entertainment Magazine

ENGINEERING EXPERIENCE

Vice President, Infotainment Ltd., 1991-95

Vice President, U.S. Digital Disc Corporation, 1986-88

Independent audio engineering consultant, 1983 -

partial client list: Alpine Electronics, Analog Devices, Blockbuster Entertainment, DaimlerChrysler, Eclipse, Ford Motor Company, Fujitsu Ten, Harman International, Hughes Electronics, Hyundai Motors, IBM, Kia Motors, Lexus Division, Lucent Technologies, Microsoft Corporation, Mitsubishi Electronics, Motorola, Onkyo, Philips, RealNetworks, Samsung, Sensormatic, Sony Classical, Sony Corporation, TDK, Time Warner, Toyota Motors, United Technologies, Urocket

Research and development engineer, International Business

Information Systems, Inc., Miami, 1980-83

Research and development engineer, Microcomputer Arts, Inc., Miami, 1979-81

Chief Audio Engineer, Greater Miami Opera, 1979-89

Circuit designer, Sal Mar Construction, Urbana, 1976-78

Design engineer, minicomputer music system, Master's thesis project,

Experimental Music Studios, University of Illinois, Urbana, 1974-76

TEACHING EXPERIENCE

Founded Bachelor of Science degree in Electrical Engineering with Audio Emphasis, 1992

Founded Master of Science degree in Music Engineering, 1986

Master of Science Research Project Thesis Advisor 1988 -

partial list: Kirk Lampert, Robert Dunn, Matt Fellers, Thomas Zudock, John Anthony, Ricardo Garcia, Ted Tanner, William Johnson, Marc Bavay, Frank Filipanits, Michael Ballman, Jayant Datta, Aurika Hays, Brent Karley, Glenn Josefiak, Timothy Onders, Luis Martinez, Ali Habashi, Eduardo Trama, Vishweshwara Rao, Jonathon Boley, Robert Burke, Chhabra Vaibhav.

Lecturer on audio topics for educational and corporate institutions, 1978 -

partial client list: Canadian Broadcasting Corporation, Conde Nast, Hogskolan I Lulea, Recording Industry Association of America, Times Mirror, Tweeter, Inc., U.S. Justice Department Anti-Trust Division, Yamaha Corporation.

Initiated new undergraduate and graduate courses in acoustics, digital audio, recording techniques, studio production, Internet audio 1977 -

BUSINESS EXPERIENCE

Co-Founder of Infotainment, Ltd., CD-I publishing company, New York, 1991 -

Consultant or Expert Witness on copyright, patent infringement and other issues, 1989 - partial client list: Arnold & Porter (Recording Industry Association of America); Baker & McKenzie (Microsoft); Christie Parker & Hale (Kawai); Cushman Darby & Cushman (MCA Discovision); Dewey Ballantine (Apple Computer), Fish & Richardson (Microsoft), Greenberg, Glusker, Fields, Claman, Machtinger & Kinsella (Pueblo Films); Darby & Darby (Nice Systems); Firmstone & Feil (K-Mart Australia); Fish & Neave (Time Warner et al); Herman Roof Borgognoni & Moore (Elk Industries); Hunton & Williams (Sonopress); Paul, Weiss, Rifkind, Wharton & Garrison (Time-Warner); Barnes & Thornburg (Sanyo Laser Products, Inc.); Young & Thompson (Nippon Columbia).

Co-Founder of U.S. Digital Disc Corporation, Compact Disc consulting,

New York, 1986-88

Director of Gusman Concert Hall recording services, University of Miami, 1980-82

Co-Founder and Vice President of International Business Information Systems, computer wholesalers, Miami, 1980-83

Co-Founder and Vice President of Microcomputer Arts, audio synthesis design and development, Miami, 1979-81

Independent consultant for acoustics, audio engineering, 1976 -

HONORS, GRANTS AND SERVICE

Member of the Board of Directors of the New World Symphony, 2000 -

Non-Board Member of the National Public Radio Distribution/Interconnection Committee, 2000 - 03

Audio Engineering Society Board of Governors Award, 1998

Co-Chairman, AES 14th International Conference, Internet Audio, 1997

Audio Engineering Society Vice President Eastern Region U.S and Canada, 1993

Audio Engineering Society Convention Papers Co-Chairman 1993

Phillip Frost Award for Excellence in Teaching and Scholarship 1991-92

Audio Engineering Society Fellowship Award 1991

Audio Engineering Society Board of Governors 1991

Chairman, AES 7th International Conference, Digital Audio, 1989

Audio Engineering Society Board of Governors Award 1989

Audio Engineering Society Convention Seminars Chairman 1985

Audio Engineering Society Convention Papers Chairman 1984

University of Miami Research Grant 1984

School of Music Most Meritorious Faculty Member 1983-84

University of Miami Honors Lecturer 1980

University of Miami Academic Computing Grant 1979

Thomas Organ Company Financial Fellowship 1976

Eta Kappa Nu Electrical Engineering Award 1974

James Scholar Award 1974

parameters of the patented invention, [rather] there must be a teaching or suggestion within the prior art, within the nature of the problem to be solved, or within the general knowledge of a person of ordinary skill in the field of the invention, to look to particular sources, to select particular elements, and to combine them as combined by the inventor." Crown Operations, 289 F.3d at 1376. What the prior art teaches and whether it teaches away from the claimed invention are questions of fact. In re Bell, 991 F.2d 781, 784 (Fed. Cir. 1993).

At the summary judgment stage, the party claiming obviousness must come forward with clear and convincing evidence to satisfy the first three prongs of the test set out in Graham, i.e., (1) the scope and content of the prior art, (2) differences between the prior art and the allegedly infringed claims, and (3) the level of ordinary skill in the pertinent art. Id., 383 U.S. at 17; see also Winner Int'l Royalty Corp. v. Wang, 202 F.3d 1340, 1350 (Fed. Cir. 2000). If the defendant satisfies the *prima facie* showing of obviousness, the burden shifts to the patent owner to come forward with objective evidence demonstrating secondary considerations of non-obviousness, i.e., the fourth Graham factor. Winner Int'l, id.

2. Defendants' Examples of Prior Art Giving Rise to Obviousness:

Defendants argue that the Asserted Claims would have been obvious to a person of ordinary skill in the art because the subject matter of those claims consists "of an utterly conventional implementation of two technologies: the absolute basics of the download of digital audio and the absolute basics of electronic sales." (Def.' Brief at 37.) They claim that "there are so many routes to demonstrating the

obviousness of the enabled Asserted Claims that it would be extremely redundant to go through a detailed analysis for all prior art references." (Id. at 38.) They concentrate on four single references – Akashi and PAN (discussed above), a non-technical article published in 1986, and descriptions of technology developed in the mid-1980s by Compusonics Corporation. The arguments with regard to Akashi and PAN are parallel, i.e., that each discloses the identical subject matter as the Sightsound Patents and that any differences in implementation of particular functions between Akashi or PAN and the Sightsound Patents are so insignificant that someone with a working knowledge of Akashi or PAN would find everything in the Sightsound Patents to be obvious and would learn nothing new from reading them. (Id. at 39-41.) Rather than review the arguments with regard to Akashi and PAN in detail, I will concentrate on the other prior art references²⁴ which Defendants argue would have allowed one skilled in the art to find the Sightsound Patents obvious.

Defendants argue that the essence of the entire Hair invention is encapsulated in an interview with Jimmy Bowen, president of the Nashville Division of MCA Records, published in October 1986.²⁵ In that interview, Bowen stated:

²⁴ Defendants also summarize two other instances of alleged prior art, specifically a company called Telephone Software Connection, founded in 1979, by which consumers could purchase and download software via telephone connections, and a patent issued in 1978 to Robin Elkins for an "Audio Storage and Distribution System" which allowed selection and transmission of digital signals over a telecommunications line. (Def.'s Brief at 11-12.) These are not used by Defendants as examples of prior art references in either the anticipation or obviousness arguments and thus I do not consider them herein.

²⁵ Plaintiff points out that the Bowen Article was considered by the Patent and Trademark Office during prosecution of the '440 Patent. (Plf.'s Brief in Opp. at 19, n.12.) When the prior art was before the PTO examiner during prosecution, the burden of the party alleging invalidity is

I see the time down the road, probably 10 years, when you'll be able to dial a series of numbers on your telephone and get a digital album over the phone line into your incoder (sic) in your home. In five minutes, you can have a new album. It's on your telephone bill or it's on your credit card or whatever.

(Exhibits to the Declaration of Michael I. Shamos, Docket No. 165, Exh. 1, "the Bowen Article.")

Defendants contend that this description by Bowen "includes all of the aspects of the asserted claims except for the copy prevention feature. . . . A straightforward and completely conventional implementation of the method described in the Bowen Article by one of ordinary skill in the art would yield the same invention that the Hair patents assert." (Defs.' Brief at 38.)

Defendants offer another indication of obviousness arising from the fact that by 1984, Compusonics Corporation had developed a system that incorporated all the necessary hardware components for transmission and downloading of digital audio signals over telecommunications lines between two computers for storage and playback. (Defs.' Brief at 41-42; see also Hayes Decl. Exh. 18.) Compusonics publicly demonstrated its system in 1985 and "expressly contemplated the application of their system to the sale and teledelivery of digital audio music into the consumer's home." (Hayes Decl. Exhs. 19-21; 35.) According to Defendants, the Compusonics system exactly corresponded to the claims of Sightsound Patents, and any differences in implementation between the two were "so trivial" that one of ordinary skill in the art who was familiar with the Compusonics system would find

"especially difficult." Hewlett-Packard Co. v. Bausch & Lomb, 909 F.2d 1464, 1467 (Fed. Cir. 1990).

the Sightsound Patents obvious. (Defs.' Brief at 41-42.)

Finally, Defendants argue that someone familiar with the art of digital audio transmission in 1988 would also be familiar with the concept of copy prevention as applied to the arts of digital download and electronic sales. (Defs.' Brief at 43-44.) Therefore, any elements of copy protection derived from the Sightsound Patents would have been obvious from prior art suggested by (1) a patent issued to Charles Freeny in 1985 ("the Freeny Patent"), (2) reports published in 1983 and 1986 ("the IRD Reports"); and (3) a patent issued to Martin Hellman in 1987. When the prior art of copy protection suggested by these references is combined with Akashi, PAN, Compusonics or Bowen, the invention claimed in the Sightsound Patents would have been obvious to a person of ordinary skill in the art in June 1988. (*id.* at 44.)

3. Plaintiff's Arguments in Opposition to the Obviousness Claims:

In response, Plaintiff makes three arguments. First, Sightsound argues that Defendants have not presented "a rigorous comparison" of the claims to the prior art references, but offer "little more than the unsupported accusation that Mr. Hair's claimed invention is so simple that it does not deserve a patent." (Plf.'s Brief in Opp. at 16-18.) Sightsound contends that summary judgment must be denied because Defendants have failed to establish the scope and content of the prior art, the level of ordinary skill in the art, and differences between the Hair invention and the prior art. Second, Defendants have also failed to show that there was "a suggestion or motivation to modify the prior art teaching to obtain the claimed invention." (*id.* at 17, quoting Beckson Marine, supra, 292 F.3d at 727.) Particularly, with regard to

the copy protection elements, Plaintiff contends that it has presented evidence contradicting the contention that one skilled in the art would have combined the cited references to arrive at the Sightsound Patents and that references cannot be combined when a reference teaches away²⁶ from the combination. Finally, Plaintiff points out that Defendants have entirely omitted any discussion of secondary considerations of non-obviousness. (Plf.'s Brief in Opp. at 31-36.)

4. Analysis:

I agree with Plaintiff that there are questions of material fact with regard to the obviousness claims sufficient to preclude summary judgment. Although Defendants have outlined numerous ways in which they argue one or more of the prior art references would render the Sightsound Patents obvious, those arguments are rebutted by Plaintiff. I mention only a few examples.

a. The Bowen Article:

As Plaintiff's expert, Dr. Tygar, points out, the Bowen reference provides no indication of how dialing a series of numbers on a telephone in order to get a digital album via a telephone line into an "incoder" in the purchaser's home would actually be accomplished. (Tygar Rebuttal at 55.) He then lists six points which are not addressed in the Bowen Article and notes as well that nothing in this reference

²⁶ "Teaching away" describes a situation in which a person of ordinary skill who read the reference would be discouraged from following the reference, would be led in a direction different from that taken by the patentee, or would believe that the result of following the reference's disclosure would not be likely to produce the result sought by the patentee. Furthermore, if combining references would produce a seemingly inoperative device, they teach away from their combination. Tec Air, Inc. v. Denso Mfg. Mich., Inc., 192 F.3d 1353, 1360-61 (Fed. Cir. 1999) (internal quotations and citations omitted).

addresses in any way the electronic sales aspect of the Sightsound Patents. His conclusion is that because the Bowen Article not only fails to supply answers to the questions, but also fails to suggest any means by which the questions would be answered, nothing in this prior reference would make the Asserted Claims obvious. (Id. at 56.)

b. The Akashi Patent:

As discussed above, this prior art reference incorporates no means for electronic sale of the desired digital signals; playback capacity, integrated speakers, or copy protection. There is also, at a minimum, a question of fact whether it teaches removable media or hard disk storage of the downloaded signals. (Plf.'s Brief in Opp. at 32.)

c. PAN:

As Dr. Tygar points out, one skilled in the art would not be motivated to augment the PAN system with a means to prevent unauthorized reproduction of the downloaded signals because the purpose of PAN was to provide "access to a free and unrestrained exchange of information." (Tygar Rebuttal at 78.) When coupled with the fact that the PAN system provided only incidentally for the electronic sale of digital signals (as discussed above), PAN thus teaches away from the Hair invention. (Plf.'s Brief in Opp. at 22;32.)

d. Compusonics:

Plaintiff points out that Dr. Moorner, one of Defendants' experts, admitted at his deposition that although developers of the Compusonics system "had the intent

and desire to offer music in the form of digital audio for pay," the system did not incorporate certain elements that would make obvious the Asserted Claims regarding electronic sales using the control units of the buyer's and seller's computers. That is, Dr. Moorer admitted that the Compusonics system was not configured to accept credit card information and transmit it to the seller's mainframe as a preliminary step to downloading the signals. (Plf.'s Brief in Opp. at 23, citing Moorer Depo. at 146-149.) Moreover, the Compusonics system could be expected to teach away from integrating a means of copy protection since its entire purpose was to allow the consumer to edit the signals he received.

e. The IRD Reports:

These reports, published by International Resource Development between 1982 and 1986, addressed such topics as downloading and teledelivery of music, video and software over telecommunications lines, generally on a pay-per-use basis. At least two IRD Reports, numbers 588 and 684, discuss the problem of illegal copying. (Defs.' Brief at 12-13.) Plaintiff's expert offers numerous reasons why none of the IRD Reports renders the Sightsound Patents obvious. (Tygar Rebuttal at 61-67.) For example, IRD 684 is silent regarding the fee aspect of downloading digital music files. While IRD 588 discusses the problem of illegal copying of music, there is no corresponding discussion of potential or actual solutions, and it concentrates on legal rather than technological means to prevent such copying. IRD 510 describes a music service similar to current cable television services with some pre-programmed channels and others available on a pay-per-view basis, a system which

is entirely inconsistent with the Hair invention. On the other hand, Dr. Tygar considered IRD 684 valuable because it reflects the perception among those skilled in the art that the companies which dominated the music distribution business in 1986 had no incentive to support teledelivery systems of digital music and were in fact actively refusing to cooperate with companies which attempted to do so. (Tygar Rebuttal at 62-63.) In his opinion, "IRD 684 makes it clear that one of ordinary skill in the art in 1986 would not be encouraged to develop music teledelivery systems and might very well be led away from that goal." (*Id.* at 63.)

f. The Freeny Patent:

Charles Freeny, Jr., received a patent in July 1985 for a "System for Reproducing Information in Material Objects at a Point of Sale Location." (Hayes Decl. Exh. 22, U.S. Patent No. 4,528,643.) Briefly stated, the Freeny Patent describes a "point-of-sale kiosk" that delivers information on demand. A consumer selects the desired information from a catalog, enters a computer code, and, when the sale is approved, the part of the kiosk known as the information manufacturing machine ("IMM") copies the information onto a "material object," i.e., a portable medium which is delivered to the consumer. (Tygar Rebuttal at 73-76; Defs.' Brief at 10.) In Dr. Tygar's opinion, the Freeny Patent teaches away from the Hair invention, primarily because the device to which the information is downloaded is not the device on which the consumer plays back the recording, an element which is critical to the Asserted Claims of the Sightsound Patents. Dr. Tygar also concluded from the Freeny Patent that the "point of sale kiosk" was located in a public place such as a

store, where the consumer would not have "possession and control" over the device, as required by the Hair Invention. (Tygar Rebuttal at 75-76.)

Defendants correctly point out that in Interactive Gift Express, Inc. v. Compuserve, Inc., 256 F.3d 1323, 1334 (Fed. Cir. 2001), the Court construed "point of sale kiosk" to include a location in a consumer's home, contrary to Dr. Tygar's conclusion that it was limited to a business location. However, the Court in Interactive Gift Express affirmed the lower court's construction of the term "material object" in the Freeny Patent to be (a) separate and distinct from the IMM, (b) removed from the IMM after purchase, and (c) intended for use away from the point-of-sale location. Id. at 1336. The Federal Circuit Court stated, "These three conditions. . . are fundamental to the meaning of a material object as clearly and consistently specified in the patent description." Id. at 1337. The Court explicitly noted that the "material object" on which the information is recorded "does not encompass the hard disk component of a home personal computer" and the material object "must be offered for sale, and be purchasable, at [the] point of sale location[.]" Id. at 1338. Since one using the Hair Invention purchases only the signals, not the material object on which they are stored, and since the Sightsound Patents specifically reference the consumer's system as incorporating a hard disk, the Freeny Patent, as construed by the Federal Circuit Court in Interactive Gift Express, arguably teaches away from the Hair invention in at least two ways. (See, e.g., Claims 13 and 14 of the '440 Patent as discussed in the Magistrate's Report at 65.)

g. The Hellman Patent:

This patent was issued in April 1987 and describes a "software distribution system." (Hayes Decl. Exh. 24, U.S. Patent No. 4,658,093, "the Hellman Patent.") The patent description concentrates on a mechanical means of preventing unauthorized copying. That is, the digital signal downloaded to the customer is never encrypted, per se; instead, the consumer must purchase a specially manufactured base unit which has a built-in decoder key. (Hellman Patent, col. 4, lines 37-63.) In order to playback the software, music or movie the consumer has purchased and downloaded, he initiates another contact to the seller who sends a signal to "unlock" the playback mechanism. In this sense, the Hellman Patent envisions a system more like "pay per view" television in that the copyright holder controls playback, not the consumer. (Defs.' Brief at 12.) As Dr. Tygar points out, the need for a special base unit (as compared to a personal computer) and the lack of control by the consumer both teach away from the Hair invention. (Tygar Rebuttal at 79.)

In sum, Dr. Tygar offers precise reasons why the prior art referenced by Defendants both fails to disclose the elements of the Sightsound Patents and fails to render the Asserted Claims obvious. Some prior art – for instance, the IRD Reports and the Hellman Patent – actually teach away from the Sightsound Patents and would thus discourage one skilled in the art in 1988 from attempting to develop a system or methodology comparable to the Hair invention.

There is another question to be considered, however, and that is whether one skilled in the art would be motivated to combine the teachings of Akashi, PAN, Compusonics and/or other prior art to arrive at the Hair invention. The Federal

Circuit has stated:

Evidence of a suggestion, teaching, or motivation to combine prior art references may flow, inter alia, from the references themselves, the knowledge of one of ordinary skill in the art, or from the nature of the problem to be solved. Although a reference need not expressly teach that the disclosure contained therein should be combined with another, the showing of combinability, in whatever form, must nevertheless be clear and particular.

Winner Int'l, 202 F.3d at 1348-49 (citations omitted).

As noted above, the purpose of the "motivation to combine" requirement is to prevent the use of hindsight based on the invention to defeat its patentability. "In other words, the [party opposing the patent] must show reasons that the skilled artisan, confronted with the same problems as the inventor and with no knowledge of the claimed invention, would select the elements from the cited prior art references for combination in the manner claimed." In re Rouffet, 149 F.3d 1350, 1357 (Fed. Cir. 1998).

Dr. Tygar has offered his views as to why none of the prior art references, read in combination with other prior art, would render the Asserted Claims obvious. Moreover, he has put forth several arguments to support the conclusion that some prior art references actually teach away from certain Sightsound elements such as copy protection or a single unit to control all aspects of the consumer's use of the invention. (See, e.g., Tygar Rebuttal at 54-55 (Bowen Article); 64, 66, 67 (IRD Reports); 75-76 (Freeny Patent); 76-78 (Akashi Patent); 78 (PAN); 78 (Compusonics); and 79 (Hellman).) These reasons are sufficiently cogent and well-reasoned that a factfinder could conclude the Sightsound Patents were not obvious.

Furthermore, I find that summary judgment must be denied because there are underlying unresolved questions of fact with regard to evidence of secondary considerations of non-obviousness. Secondary considerations can "provide objective evidence of how the patented device is viewed in the marketplace, by those directly interested in the product." Demaco Corp. v. F. Von Langsdorff Licensing Ltd., 851 F.2d 1387, 1391 (Fed. Cir. 1988). Secondary considerations include (1) long-felt but unsolved need; (2) commercial success of the invention; (3) failed efforts of others; (4) copying by others; (5) praise for the invention; (7) unexpected results; (8) disbelief of experts; (9) general skepticism of those in the art; (10) commercial acquiescence; and (11) simultaneous development. See Nat'l Steel Car, Ltd. v. Canadian Pac. Ry. Co., 254 F. Supp.2d 527, 570 (E.D. Pa. 2003), and cases cited therein. "Evidence of secondary considerations may often be the most probative and cogent evidence in the record. It may often establish that an invention appearing to have been obvious in light of the prior art was not. It is to be considered as part of all the evidence, not just when the decisionmaker remains in doubt after reviewing the art." Stratoflex, Inc. v. Aeroquip Corp., 713 F.2d 1530, 1538-39 (Fed. Cir. 1983). However, "there must be a nexus between the claimed invention and the secondary considerations before the evidence is relevant to the question of obviousness." Nat'l Steel Car, Id., citing SIBIA Neurosciences, 225 F.3d at 1358-59.

Plaintiff has presented evidence showing that not later than 1987, Compusonics had abandoned its efforts to commercialize the music downloading

Industry²⁷ and, in fact, Dr. Tygar opined that none of the systems incorporating prior art survived as a consumer oriented mass market distribution system for digital music distribution. (Tygar Rebuttal at 80.) As he also noted, the IRD Reports reflected a general skepticism in 1986 for the viability of a teledelivery system for digital audio signals. At the same time, numerous articles dating from the 1990s show an ongoing interest in such services, establishing the fact that there was a long-felt need for the invention. (Plf.'s Ex. C, Rebuttal Report of Frederic R. Miller, "Miller Rebuttal," at 5.) We also know from the history of this case that while the '440 Patent application was still pending, Sightsound accused N2K of illegally copying technology covered by its earlier Patents.

On the other hand, Defendants essentially omit any discussion of secondary considerations from their Brief in Support of the Motion for Summary Judgment. In their Reply Brief, their argument on this point is limited to a conclusory statement: "Sightsound has not presented relevant evidence of secondary considerations because it failed to establish a nexus between the merits of the claimed invention and the evidence offered." (Defs.' Reply Brief at 6, citing Cable Electric Prods., Inc., v. Genmark, Inc., 770 F.2d 1015, 1027 (Fed. Cir. 1985);²⁸ Sjolund v Musland, 847 F.2d 1573 (Fed. Cir. 1988); Windsurfing Int'l Inc., supra.) I have reviewed

²⁷ A former principal in Compusonics, David Schwartz, testified at his deposition that sometime in 1986 or 1987, his company "gave up on trying to commercialize" telerecording (which he defined as buying, selling and databasing music libraries for sale on demand.) (Plf.'s Ex. M, Deposition of David Schwartz, at 97.) He explained that record companies in the United States, Europe and Japan "were not receptive to the concept in any way, shape, or form." (Id. at 142.)

²⁸ Overruled on other grounds by Midwest Indus., Inc. v. Karavan Trailers, Inc., 175 F.3d 1356, 1358 (Fed. Cir. 1999).

the cited cases, despite not having a clear idea of how Defendants' single-sentence argument relates to them, and find that all three concentrate on commercial success, only one of many secondary considerations which may be offered by a patentee. See Cable Electric, id. at 1027, holding that for commercial success to have "true relevance" to the question of nonobviousness, that success must be shown to be due to the nature of the patented subject matter, rather than to economic and commercial factors unrelated to the technical quality of the patented subject matter; Sjolund, id. at 1582, concluding that evidence of commercial success was irrelevant because the aspect of the invention to which its success was attributed was not part of the claimed invention. Windsurfing Int'l, which also discusses commercial success, focuses on the weight a district court may properly give to secondary considerations, concluding that the weight should correlate to the objective evidence provided to support them. 782 F.2d at 1000.

Here, I have noted Plaintiff's arguments that at the time the Sightsound Patents were issued, there were numerous examples of secondary considerations: copying, skepticism on the part of those skilled in the art as to the viability of such a system, long-felt but unsatisfied needs, and unsuccessful attempts by others to solve the problem underlying the claimed invention. Given nothing substantive from Defendants in their Reply Brief to refute these claims, I accept them as presented by Plaintiff for purposes of deciding this summary judgment motion.

5. Conclusion

Conflicts in the evidence on factual issues are not to be resolved on summary

**RECORDATION FORM COVER SHEET
PATENTS ONLY**

To the Director of the U.S. Patent and Trademark Office: Please record the attached documents or the new address(es) below.

1. Name of conveying party(ies)/Execution Date(s):

SightSound Technologies, Inc. (Delaware Corp)

Execution Date(s) 10 November 2005

Additional name(s) of conveying party(ies) attached? Yes No

2. Name and address of receiving party(ies)

Name: DMT Licensing, LLC (Delaware LLC)

Internal Address: _____

Street Address: One Independence Way

City: Princeton

State: New Jersey

Country: US Zip: 08540

Additional name(s) & address(es) attached? Yes No

3. Nature of conveyance:

- Assignment Merger
 Security Agreement Change of Name
 Government Interest Assignment
 Executive Order 9424, Confirmatory License
 Other _____

4. Application or patent number(s):

This document is being filed together with a new application.

A. Patent Application No.(s)

09/286,892
10/820,995
10/632,166

B. Patent No.(s)

5,191,573 6,721,491
5,675,734 6,615,349
5,966,440 6,014,491

Additional numbers attached? Yes No

5. Name and address to whom correspondence concerning document should be mailed:

Name: Matthew P. McWilliams

Internal Address: Drinker Biddle & Reath LLP

Street Address: One Logan Square
18th and Cherry Streets

City: Philadelphia

State: Pennsylvania Zip: 19103-6996

Phone Number: 215.988.3381

Fax Number: 215.988.2757

Email Address: matthew.mcwilliams@dbr.com

6. Total number of applications and patents involved:

7. Total fee (37 CFR 1.21(h) & 3.41) \$ 360.00

- Authorized to be charged by credit card
 Authorized to be charged to deposit account
 Enclosed
 None required (government interest not affecting title)

8. Payment Information

a. Credit Card Last 4 Numbers _____
Expiration Date _____

b. Deposit Account Number _____

Authorized User Name _____

9. Signature:

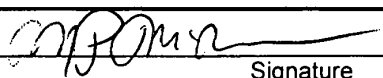
Signature

December 26, 2005
Date

Matthew P. McWilliams, Reg. No. 46,922

Name of Person Signing

Total number of pages including cover sheet, attachments, and documents:

PATENT ASSIGNMENT AGREEMENT

THIS PATENT ASSIGNMENT AGREEMENT (this "Agreement"), is made as of this 10th day of November, 2005 by and between SightSound Technologies, Inc., a Delaware corporation ("Assignor"), and DMT Licensing, LLC, a Delaware limited liability company ("Assignee"). Assignor and Assignee are sometimes referred to herein as a "Party" or collectively as the "Parties."

WITNESSETH:

WHEREAS, Assignor is the owner of the entire right, title and interest in and to all of the patents and patent applications (including any and all inventions and improvements disclosed and described therein) set forth on Exhibit A hereto (the "Patents"); and

WHEREAS, Assignee desires to obtain all of Assignor's right, title and interest in, to and under the Patents.

NOW THEREFORE, in consideration of the premises and mutual covenants contained in this Agreement and in the Asset Purchase Agreement between Assignor and Assignee, the receipt and sufficiency of which are hereby acknowledged, the Parties agree as follows:

1. Assignor hereby conveys, assigns, sells, transfers and delivers to Assignee, its successors and assigns, all of its right, title and interest throughout the world in, to and under the Patents, including the underlying inventions described therein and any and all United States or foreign reissues, divisions, renewals, extensions, provisionals, continuations and continuations-in-part thereof and substitutes therefor, all letters patent of the United States which have been or may be granted thereof and all foreign counterparts thereof, including any reissues or extensions of letters patent granted thereon and any and all rights corresponding to any of the foregoing throughout the world, all priority rights under the International Convention for the Protection of Industrial Property for every member country (and any other international convention or treaty), any and all accounts, contract rights, warranties, litigation claims and rights, including the right to sue for and collect upon all claims for profits and damages as a result of future or past infringement, and other general intangibles of Assignor related to any of the foregoing, in each case whether now existing or hereafter acquired or created, whether owned, leased or licensed beneficially or of record and whether owned, leased or licensed individually, jointly or otherwise, together with the products and proceeds thereof (including license royalties and the proceeds of infringement suits from the date of this Agreement forward), all payments and other distributions with respect thereto from the date of this Agreement forward, and the right to fully and entirely stand in the place of Assignor in all matters related thereto.

2. Assignor hereby conveys, assigns, transfers and delivers to Assignee, its successors and assigns, all of its right, title and interest throughout the world in and to any and all lab notes, prototypes, draft patent applications, correspondence with the United States Patent and Trademark Office or any foreign patent office, nondisclosure agreements, invention agreements and noncompete agreements, to the extent such materials relate to the Patents.

3. Assignor hereby requests the Commissioner for Patents (the "Commissioner") to record this assignment of the Patents to Assignee. Assignor hereby further requests the

Commissioner to issue any and all letters patent of the United States resulting from applications among the Patents or derived therefrom to Assignee as assignee of the entire interest. Assignor hereby covenants that the Commissioner has full right to convey the entire interest herein assigned, and that Assignor has not executed, and will not execute, any agreements inconsistent herewith.

4. Assignor further agrees that it shall on the date hereof and from time to time thereafter, at the request of Assignee, perform or cause to be performed such acts and execute, acknowledge and deliver at the request of Assignee, such documents as may reasonably be required to evidence or effectuate the sale, conveyance, assignment, transfer and delivery to Assignee of the Patents or for the performance by Assignor of any of its obligations hereunder.

5. This Agreement will be binding upon and will inure to the benefit of the parties hereto and their successors and assigns, and no person other than Assignor, Assignee or their respective successors and assigns shall have any rights under this Agreement or the provisions contained herein.

6. An executed copy of this Agreement may be filed with the proper governmental or regulatory authority or public body by Assignee at any time.

7. This Agreement shall be governed by and construed in accordance with the laws of the State of New York without regard for the conflicts of laws principles thereof, except that if it is necessary in any other jurisdiction to have the law of such other jurisdiction govern this Agreement in order for this Agreement to be effective in any respect, then the laws of such other jurisdiction shall govern this Agreement but only to such extent.

[SIGNATURE PAGE FOLLOWS]

IN WITNESS WHEREOF, the Parties have caused this Agreement to be duly executed,
as of the date first above written.

ASSIGNEE

By: 
Name: Peter Moller
Title: Vice President
Date: November 10, 2005

ASSIGNOR

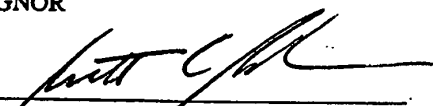
By: 
Name: Scott C. Sander
Title: President and Chief Executive Officer
Date: November 10, 2005

Commonwealth of Pennsylvania

County of Allegheny ss.:

On the 10th day of November, 2005, before me personally came Scott C. Sander, to me known (or satisfactorily proven), who being by me duly sworn, did depose and say that he is the President and CEO of Assignor, the corporation described in, and which executed the foregoing instrument, and that he was fully authorized to execute this Patent Assignment Agreement on behalf of said corporation.

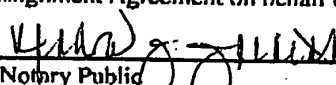
Notary Public

COMMONWEALTH OF PENNSYLVANIA
Notarial Seal
Kendra J. Jenkins, Notary Public
City Of Pittsburgh, Allegheny County
My Commission Expires Jan. 12, 2008
Member, Pennsylvania Association Of Notaries

EXHIBIT A

PATENTS AND PATENT APPLICATIONS

A/V eCommerce Patents:

	<u>Country</u>	<u>Number</u>	<u>Issued</u>
01]	United States	5,191,573	Issued
02]	United States	5,675,734	Issued
03]	United States	5,966,440	Issued
04]	United States	09/286,892	Application In Process

A/V Compression Patents:

01]	United States	6,014,491	Issued
02]	Singapore	67158	Issued
03]	New Zealand	337344	Issued
04]	Australia	752057	Issued
05]	China	1252917	Issued
06]	United States	6,721,491	Issued
07]	Hong Kong	1025208	Issued
08]	Australia	6341198	Application In Process
09]	Brazil	9811455	Application In Process
10]	Canada	2279853	Application In Process
11]	China	1121124C	Application In Process
12]	European Patent Office	0965128	Application In Process
13]	Japan	2002508850T	Application In Process
14]	United States	2005038535	Application In Process
15]	World Intellectual Property Organization	9843405	Application In Process

Applied Encryption Patents:

01]	New Zealand	502871	Issued
02]	United States	6,615,349	Issued
03]	Taiwan	574641	Issued
04]	Singapore	93860	Issued
05]	Australia	776005	Issued
06]	Austria	EP2000300727	Pending
07]	Belgium	EP2000300727	Pending
08]	Cyprus	EP2000300727	Pending
09]	Denmark	EP2000300727	Pending
10]	Finland	EP2000300727	Pending
11]	France	EP2000300727	Pending
12]	Germany	EP2000300727	Pending
13]	Greece	EP2000300727	Pending
14]	Ireland	EP2000300727	Pending
15]	Italy	EP2000300727	Pending
16]	Lichtenstein	EP2000300727	Pending
17]	Luxembourg	EP2000300727	Pending
18]	Monaco	EP2000300727	Pending

19]	Netherlands	EP2000300727	Pending
20]	Portugal	EP2000300727	Pending
21]	Sweden	EP2000300727	Pending
22]	Spain	EP2000300727	Pending
23]	Switzerland	EP2000300727	Pending
24]	United Kingdom	EP2000300727	Pending
25]	China	CN1269549	Pending
26]	Hong Kong	HK1028466	Pending
27]	Australia	1481000	Application In Process
28]	Brazil	0000702	Application In Process
29]	Canada	2299056	Application In Process
30]	Japan	2000259478	Application In Process
31]	United States	2004025037	Application In Process

Peer-to-Peer Patents:

01]	European Patent Office	1332428	Application In Process
02]	Japan	JP2004513453T	Application In Process
03]	World Intellectual Property Organization	239253	Application In Process

All Intellectual Property to be free of any liens or encumbrances.

PJRM PTO-1595
(Rev. 8-93)

OMB No. 0851-0011 (exp. 4/94)

RECORDATIC
PAT

10-20-1995

U.S. DEPARTMENT OF COMMERCE
Patent and Trademark Office

Tab settings



To the Honorable Commissioner of Patents and Trade

100079959

Documents or copy thereof.

1. Name of conveying party(ies):

Arthur R. Hair

*MRcl
10-2-95*

Additional name(s) of conveying party(ies) attached? Yes No

2. Name and address of receiving party(ies)

Name: Parsec Sight/Sound, Inc.

Internal Address: _____

Street Address: 1518 Allison Drive

City: Upper St. Clair State: PA ZIP: 15241

Additional name(s) & address(es) attached? Yes No

3. Nature of conveyance:

Assignment

Merger

Security Agreement

Change of Name

Other _____

Execution Date: September 20, 1995

4. Application number(s) or patent number(s):

If this document is being filed together with a new application, the execution date of the application is: _____

A. Patent Application No.(s)

B. Patent No.(s)

5,191,573

Additional numbers attached? Yes No

5. Name and address of party to whom correspondence concerning document should be mailed:

Name: Ansel M. Schwartz

Internal Address: _____

Street Address: 425 N. Craig Street,

Suite 301

City: Pittsburgh State: PA ZIP: 15213

6. Total number of applications and patents involved:

7. Total fee (37 CFR 3.41).....\$ 40.00

Enclosed

Authorized to be charged to deposit account

8. Deposit account number: _____

(Attach duplicate copy of this page if paying by deposit account)

050 MH 10/16/95 5191573

DO NOT USE THIS SPACE

9. Statement and signature.

To the best of my knowledge and belief, the foregoing information is true and correct and any attached copy is a true copy of the original document.

Ansel M. Schwartz

Name of Person Signing

Ansel Schwartz
Signature

9/21/95
Date

Total number of pages including cover sheet, attachments, and document:

Mail documents to be recorded with required cover sheet information to:
Commissioner of Patents & Trademarks, Box Assignments
Washington, D.C. 20231 PATENT

REEL: 7656 FRAME: 0701

Attorney's Docket No. HAIR

PATENT

For: U.S. and/or Foreign Rights
For: U.S. Application or
 U.S. Provisional Application
For: U.S. Patent
For: PCT Application
By: Inventor(s) or Present Owner

ASSIGNMENT OF INVENTION

In consideration of the payment by ASSIGNEE to ASSIGNOR of the sum of One Dollar (\$1.00), the receipt of which is hereby acknowledged, and for other good and valuable consideration,

ASSIGNOR:

(inventor(s) or person(s) or entity(ies) who own the invention)

Arthur R. Hair
(type or print name(s) of ASSIGNOR(S))
1518 Allison Drive
Address
Upper St. Clair, PA 15241

Nationality

(if assignment is by person or entity to whom invention was previously assigned and this was recorded in PTO, add the following)

Recorded on _____ **Reel** _____
Frame _____

hereby sells, assigns and transfers to

ASSIGNEE:

Parsec Sight/Sound, Inc.
(type or print name(s) of ASSIGNEE(S))
1518 Allison Drive
Address
Upper St. Clair, PA 15241

Nationality

and the successors, assigns and legal representatives of the ASSIGNEE

(Assignment of Invention [16-3]—page 1 of 3)

PATENT
REEL: 7656 FRAME: 0702

(complete one of the following)

- the entire right, title and interest
 an undivided _____ percent (_____%) interest
for the United States and its territorial possessions

(check the following box, if foreign rights are also to be assigned)

- and in all foreign countries, including all rights to claim priority,
in and to any and all improvements which are disclosed in the invention entitled:
METHOD FOR TRANSMITTING A DESIRED DIGITAL VIDEO OR AUDIO SIGNAL

Name of inventor(s) Arthur R. Hair

(check and complete (a), (b), (c), (d), (e), (f) or (g))

and which is found in

- (a) U.S. patent application executed on even date herewith
(b) U.S. patent application executed on _____
(c) U.S. provisional application naming the above inventor(s) for the above-entitled invention.
 Express mail label no.: _____
Mailed: _____
 To comply with 37 CFR 3.21 for recordal of this assignment, I, an ASSIGNOR signing below, hereby authorize and request my attorney to insert below the filing date and application number when they become known.
(d) U.S. application no. _____ / _____
filed on _____
(e) International application no. PCT/ _____ / _____
(f) U.S. patent no. 5,191,573 issued March 2, 1993
 A change of address to which correspondence is to be sent regarding patent maintenance fees is being sent separately.

(also check (g), if foreign application(s) is also being assigned)

- (g) and any legal equivalent thereof in a foreign country, including the right to claim priority.

and, in and to, all Letters Patent to be obtained for said invention by the above application or any continuation, division, renewal, or substitute thereof, and as to letters patent any reissue or re-examination thereof

ASSIGNOR hereby covenants that no assignment, sale, agreement or encumbrance has been or will be made or entered into which would conflict with this assignment;

(Assignment of Invention [16-3]—page 2 of 3)

PATENT
REEL: 7656 FRAME: 0703

ASSIGNOR further covenants that ASSIGNEE will, upon its request, be provided promptly with all pertinent facts and documents relating to said invention and said Letters Patent and legal equivalents as may be known and accessible to ASSIGNOR and will testify as to the same in any interference, litigation or proceeding related thereto and will promptly execute and deliver to ASSIGNEE or its legal representatives any and all papers, instruments or affidavits required to apply for, obtain, maintain, issue and enforce said application, said invention and said Letters Patent and said equivalents thereof which may be necessary or desirable to carry out the purposes thereof.

IN WITNESS WHEREOF, I/We have hereunto set hand and seal this

20th day of Sept. 1995 (Date of signing).

WARNING: The date of signing must be the same as the date of execution of the application, if item (a) was checked above.

Date: 9/20/1995

Allen R. Hill
Signature of ASSIGNOR(S)

Date:

Date:

Date:

(if ASSIGNOR is a legal entity, complete the following information)

(type or print the name of the above person
authorized to sign on behalf of ASSIGNOR)

Title

NOTE: No witnessing, notarization or legalization is necessary. If the assignment is notarized or legalized, then it will only be prima facie evidence of execution. 35 USC 261. Use next page if notarization is desired.

Notarization or Legalization Page Added.

(Assignment of Invention [16-3]—page 3 of 3)

RECORDED: 10/02/1995

PATENT
REF: 7656 FRAME: 0704

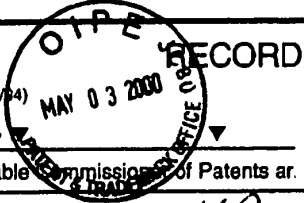

05-16-2000

Tab settings □ □ □

To the Honorable Commissioner of Patents and Trademarks

101357242

original documents or copy thereof.

1. Name of conveying party(ies): Parsec Sight/Sound, Inc. *MLO 53.00*

Additional name(s) of conveying party(ies) attached? Yes No

3. Nature of conveyance:

- Assignment Merger
- Security Agreement Change of Name
- Other _____

Execution Date: _____

2. Name and address of receiving party(ies)

Name: SightSound.com Incorporated

Internal Address: _____

Street Address: 733 Washington Road,

Suite 400

City: Mt. Lebanon State: PA ZIP: 15228

Additional name(s) & address(es) attached? Yes No

4. Application number(s) or patent number(s):

If this document is being filed together with a new application, the execution date of the application is: _____

A. Patent Application No.(s)

08/023,398 09/469,802
09/286,892 09/256,432

B. Patent No.(s)

5,191,573 5,966,440
5,675,734 6,014,491

Additional numbers attached? Yes No

5. Name and address of party to whom correspondence concerning document should be mailed:

Name: Ansel M. Schwartz

Internal Address: _____

Street Address: One Sterling Plaza,

201 N. Craig Street, Suite 304

City: Pittsburgh State: PA ZIP: 15213

6. Total number of applications and patents involved: 8

7. Total fee (37 CFR 3.41).....\$ 320.00

Enclosed

Authorized to be charged to deposit account

8. Deposit account number: _____

(Attach duplicate copy of this page if paying by deposit account)

05/16/2000 DNGUYEN 0000005A 0A02339A

DO NOT USE THIS SPACE

01 FC:581

320.00 DP

9. Statement and signature.

To the best of my knowledge and belief, the foregoing information is true and correct and any attached copy is a true copy of the original document.

Ansel M. Schwartz

Name of Person Signing

Ansel Schwartz
Signature

4/28/00
Date

Total number of pages including cover sheet, attachments, and document: 18

Mail documents to be recorded with required cover sheet information to:

Commissioner of Patents & Trademarks, Box Assignments **PATENT**
Washington, D.C. 20231

REEL: 010776 FRAME: 0703



IN THE UNITED STATES PATENT AND TRADEMARK OFFICE

CHANGE OF NAME IN RECORDED ASSIGNMENTS

1. Particulars of assignments

A list of assignments recorded against patent applications and/or patents is set forth on the attached page.

2. Old name of assignee

The old name for the assignee as shown for the assignments on the attached page is:

Parsec Sight/Sound, Inc.

(type or print old name of Assignee)

3. New name of assignee

The new name of the assignee is

SightSound.com Incorporated

(type or print new name of Assignee)

4. Proof of name change

Proof of assignee's change of name is established by the attached

certificate of the Secretary of State of Pennsylvania,
showing the name change. *(type name of state)*

certificate of name change from: _____
(type or print name of authority)

(check, if applicable)

Because the certificate or the certified copy of the name change is not in the English language, it is accompanied by a verified translation signed by the translator.

5. Change of address for patent maintenance fees

(complete, if applicable)

A change of address to which correspondence is to be sent regarding patent maintenance fees for each patent listed is being sent separately.

(Change of Name in Recorded Assignments [16-12]—page 1 of 3)



COMMONWEALTH OF PENNSYLVANIA
DEPARTMENT OF STATE

APRIL 26, 2000

TO ALL WHOM THESE PRESENTS SHALL COME, GREETING:

SIGHTSOUND.COM INCORPORATED

I, Kim Pizzingrilli, Secretary of the Commonwealth of Pennsylvania do hereby certify that the foregoing and annexed is a true and correct photocopy of Articles of Incorporation and all Amendments which appear of record in this department

IN TESTIMONY WHEREOF, I have hereunto set my hand and caused the Seal of the Secretary's Office to be affixed, the day and year above written.

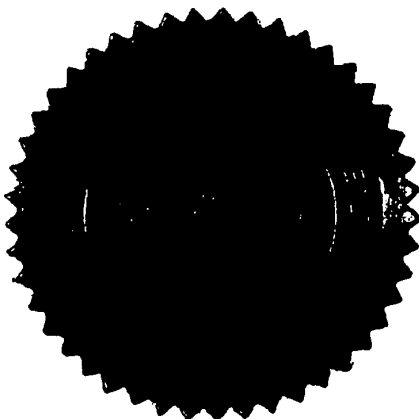

Kim Pizzingrilli
Secretary of the Commonwealth

JSOW

PATENT
REEL: 010776 FRAME: 0705 ..

198:198166

Microfilm Number _____

File: with the Department of State
on AUG 01 1995

Entity Number 2649623

[Signature]
Secretary of the Commonwealth

ARTICLES OF INCORPORATION-FOR PROFIT
DSCB:15-1306/2102/2303/2702/2903/7102A (Rev 90)

Indicate type of domestic corporation (check one):

- Business-stock (15 Pa.C.S. § 1306) Management (15 Pa.C.S. § 2702)
- Business-nonstock (15 Pa.C.S. § 2102) Professional (15 Pa.C.S. § 2803)
- Business-statutory close (15 Pa.C.S. § 2303) Cooperative (15 Pa.C.S. § 7102A)

In compliance with the requirements of the applicable provisions of 15 Pa.C.S. (relating to corporations and unincorporated associations) the undersigned, desiring to incorporate a corporation for profit hereby state(s) that:

1. The name of the corporation is: Parsec Sight/Sound, Inc.

2. The (a) address of this corporation's initial registered office in this Commonwealth or (b) name of its commercial registered office provider and the county of venue is:

(a)	<u>1518 Allison Drive</u>	<u>Upper St. Clair</u>	<u>PA</u>	<u>15241</u>	<u>Allegheny</u>
	Number and Street	City	State	Zipcode	County

(b)	<u>c/o: N/A</u>	
	Name of Commercial Registered Office Provider	County

For a corporation represented by a commercial registered office provider, the county in (b) shall be deemed the county in which the corporation is located for venue and official publication purposes.

3. The corporation is incorporated under the provisions of the Business Corporation Law of 1988.

4. The aggregate number of shares authorized is: 100,000 (other provisions, if any, attach 8 1/2 x 11 sheet)

5. The name and address, including street and number, if any, of each incorporator is:

Name	Address
<u>John E. Marshall</u>	<u>1300 Oliver Building</u>
	<u>Pittsburgh, PA 15222</u>

NS-1 68

1000

PA Dept. of State

REVERSE SIDE

FORM 801 2112

1990 68-10

198 19

6. The specified effective date, if any, is:

N/A
month day year hour, if any

7. Any additional provisions of the articles, if any, attach an 8 1/2 x 11 sheet.

8. Statutory close corporation only: Neither the corporation nor any shareholder shall make an offering of any of its shares of any class that would constitute a "Public Offering" within the meaning of the Securities Act of 1933 (15 U.S.C. § 77A et seq.).

9. Cooperative corporations only: (Complete and strike out inapplicable term) The common bond of membership among its members/shareholders is: N/A

IN TESTIMONY WHEREOF, the incorporator has signed these Articles of Incorporation this 1st day of August, 1995.

John E. Marshall
John E. Marshall

162160A.

Microfilm Number _____

Filed with the Department of State
on APR 03 1996

Entity Number 2649623

[Signature]
Secretary of the Commonwealth

ARTICLES OF AMENDMENT-DOMESTIC BUSINESS CORPORATION
DSCB:15-1910 (Rev 90)

In compliance with the requirements of 15 Pa.C.S. § 1910 (relating to articles of amendment), the undersigned business corporation, desiring to amend its Articles, hereby states that:

- The name of the corporation is: PARSEC SIGHT/SOUND, INC.
- The address of this corporation's current (a) registered office in this Commonwealth or (b) name of its commercial registered office provider and the county of venue is (the Department is hereby authorized to correct the following address to conform to the records of the Department):

(a) 1518 Allison Drive Upper PA 15241 Allegheny
 Number and Street City State Zip County

(b) c/o: N/A
 Name of Commercial Registered Office Provider County

For a corporation represented by a commercial registered office provider, the county in (b) shall be deemed the county in which the corporation is located for venue and official publication purposes.

- The statute by or under which it was incorporated is: Business Corporation Law of 1988, Act of December 21, 1988, P.L. 1444, as amended
- The date of its incorporation is: August 1, 1995

- (Check, and if appropriate complete, one of the following):
 The amendment shall be effective upon filing these Articles of Amendment in the Department of State.

_____ The amendment shall be effective on: _____
 at _____ Date

 _____ Hour

- (Check one of the following):
 The amendment was adopted by the shareholders pursuant to 15 Pa.C.S. §1914(n) and (b).

MR-010
PA Dept. of State

____ The amendment was adopted by the board of directors pursuant to 15 Pa.C.S. §1914 (c).

7. (Check, and if appropriate complete, one of the following):

The amendment adopted by the corporation, set forth in full, is as follows:

Paragraph 4 of the Articles of Incorporation shall be amended to read as follows:

4. The aggregate number of shares authorized is 1,000,000, each share having a par value of .1¢ per share.

A new Paragraph 10 shall be added to the Articles of Incorporation which shall read as follows:

10. The shareholders of the Corporation shall not be entitled to cumulate their votes for the election of directors or for any other purpose.

____ The amendment adopted by the corporation is set forth in full in Exhibit A, attached hereto and made a part hereof.

8. (Check if the amendment restates the Articles):

____ The restated Articles of Incorporation supersede the original Articles and all amendments thereto.

IN TESTIMONY WHEREOF, the undersigned corporation has caused these Articles of Amendment to be signed by a duly authorized officer thereof this 2ND day of APRIL, 1996.



Arthur R. Hair

FD0009: 73331 9764-1192

Microfilm Number _____
Entity Number 2649623
Filed with the Department of State
on AUG 25 1997
[Signature]
Secretary of the Commonwealth

ARTICLES OF AMENDMENT-DOMESTIC BUSINESS CORPORATION
DSCB:15-1915 (Rev 90)

In compliance with the requirements of 15 Pa.C.S. § 1915 (relating to articles of amendment), the undersigned business corporation, desiring to amend its Articles, hereby states that:

1. The name of the corporation is: PARSEC SIGHT/SOUND, INC.
2. The address of this corporation's current (a) registered office in this Commonwealth or (b) name of its commercial registered office provider and the county of venue is (the Department is hereby authorized to correct the following address to conform to the records of the Department):

(a) <u>1518 Allison Drive</u>	<u>Upper St. Clair</u>	<u>PA</u>	<u>15241</u>	<u>Allegheny</u>
Number and Street	City	State	Zip	County

 (b) c/o: N/A
 Name of Commercial Registered Office Provider _____ County _____

For a corporation represented by a commercial registered office provider, the county in (b) shall be deemed the county in which the corporation is located for venue and official publication purposes.

3. The statute by or under which it was incorporated is: Pennsylvania Business Corporation Law of 1988, Act of December 21, 1988, P.L. 1444, as amended
4. The date of its incorporation is: August 1, 1995
5. (Check, and if appropriate complete, one of the following):

The amendment shall be effective upon filing these Articles of Amendment in the Department of State.

The amendment shall be effective on: _____ Date
at _____ Hour

AUG 25 97
PA Dept. of State

6. (Check one of the following):

- The amendment was adopted by the shareholders pursuant to 15 Pa.C.S. §1914(a) and (b).
- The amendment was adopted by the board of directors pursuant to 15 Pa.C.S. §1914 (c).

7. (Check, and if appropriate complete, one of the following):

- The amendment adopted by the corporation, set forth in full, is as follows:

Paragraph 4 of the Articles of Incorporation shall be amended to read as follows:

4. The aggregate number of shares authorized is 100,000,000, each share having a par value of .001¢

- The amendment adopted by the corporation is set forth in full in Exhibit A, attached hereto and made a part hereof.

8. (Check if the amendment restates the Articles):

- The restated Articles of Incorporation supersede the original Articles and all amendments thereto.

IN TESTIMONY WHEREOF, the undersigned corporation has caused these Articles of Amendment to be signed by a duly authorized officer thereof this 15th day of August 1997.

PARSEC SIGHT/SOUND, INC.

BY:



Arthur R. Hair

TITLE:

Authorized Officer

Microfilm Number _____

Filed with the Department of State
on FEB 05 1998

Entity Number 2649623

[Signature]
Secretary of the Commonwealth

STATEMENT OF CHANGE OF REGISTERED OFFICE
DSCB:15-1507/4144/5507/6144/8506 (Rev 90)

Indicate type of entity (check one):

- Domestic Business Corporation (15 Pa.C.S. § 1507)
- Foreign Business Corporation (15 Pa.C.S. § 4144)
- Domestic Nonprofit Corporation (15 Pa.C.S. § 5507)
- Foreign Nonprofit Corporation (15 Pa.C.S. § 6144)
- Domestic Limited Partnership (15 Pa.C.S. § 8506)

In compliance with the requirements of the applicable provisions of 15 Pa.C.S. (relating to corporations and unincorporated associations) the undersigned corporation or limited partnership, desiring to effect a change of registered office, hereby states that:

1. The name of the corporation or limited partnership is: Parsec Sight/Sound, Inc.
2. The (a) address of this corporation's or limited partnership's current registered office in this Commonwealth or (b) name of its commercial registered office provider and the county of venue is: (the Department is hereby authorized to correct the following address to conform to the records of the Department):

<u>1518 Allison Drive</u>	<u>Upper St. Clair</u>	<u>PA</u>	<u>15241</u>	<u>Allegheny</u>
Number and Street	City	State	Zip	County
- (b) c/o: N/A
Name of Commercial Registered Office Provider _____ County _____

For a corporation or a limited partnership represented by a commercial registered office provider, the county in (b) shall be deemed the county in which the corporation or limited partnership is located for venue and official publication purposes.

3. (Complete part (a) or (b)):

PA DEPT. OF STATE
FEB 05 1998

9008-046

- (a) The address to which the registered office of the corporation or limited partnership in this Commonwealth is to be changed is:

733 Washington Road Mt. Lebanon PA 15228 Allegheny
 Number and Street City State Zip County

- (b) The registered office of the corporation or limited partnership shall be provided by:

c/o: N/A
 Name of Commercial Registered Office Provider County

For a corporation or a limited partnership represented by a commercial registered office provider, the county in (b) shall be deemed the county in which the corporation or limited partnership is located for venue and official publication purposes.

- 4. ~~(Strike out if a limited partnership):~~ Such change was authorized by the Board of Directors of the corporation.

IN TESTIMONY WHEREOF, the undersigned corporation or limited partnership has caused this statement to be signed by a duly authorized officer this 19th day of January, 1998.

Parsec Sight/Sound, Inc.

BY: Arthur R. Hair
 Arthur R. Hair, Chairman

PCDOCS# 139018

Filed with the Department of State

Microfilm Number _____ on _____

Entity Number 71449/p.23 _____

ACTING Secretary of the Commonwealth *JK*

ARTICLES OF MERGER-DOMESTIC BUSINESS CORPORATION
DSCB:15-1926 (Rev 90)

In compliance with the requirements of 15 Pa. C.S. §1926 (relating to articles of merger or consolidation), the undersigned business corporations, desiring to effect a merger, hereby state that:

1. The name of the corporation surviving the merger is: Parsec Sight/Sound, Inc.

2. (Check and complete one of the following):

The surviving corporation is a domestic business corporation and the (a) address of its current registered office in this Commonwealth or (b) name of its commercial registered office provider and the county of venue is (the Department is hereby authorized to correct the following address to conform to the records of the Department):

(a) 733 Washington Road Mt. Lebanon PA 15228 Allegheny
Number and Street City State ZipCode County

(b) c/o: N/A
Name of Commercial Registered Office Provider County

For a corporation represented by a commercial registered office provider, the county in (b) shall be deemed the county in which the corporation is located for venue and official publication purposes.

The surviving corporation is a qualified foreign business corporation incorporated under the laws of, and the (a) address of its current registered office in this Commonwealth or (b) name of its commercial registered office provider and the county of venue is (the Department is hereby authorized to correct the following address to conform to the records of the Department):

(a) N/A
Number and Street City State Zip County

PDFDOCS: 139856

4. Upon said merger becoming effective, each share of common capital stock of Digital shall be converted into one share of common capital stock of the Surviving Corporation. A Certificate for the appropriate number of shares of the common capital stock of the Surviving Corporation shall be delivered by the Surviving Corporation to each shareholder of Digital on or after the Effective Date, upon such shareholder's delivery to the Surviving Corporation of the certificates representing all of such shareholder's shares of common capital stock of Digital. The shares of common capital stock of the Surviving Corporation presently outstanding shall remain outstanding.

5. Each share of common capital stock of Digital outstanding prior to the Effective Date shall after the Effective Date represent only the right to receive one validly issued, fully paid and non-assessable share of common capital stock of the Surviving Corporation. As of the Effective Date, the equity interest of each shareholder of Digital as a shareholder of Digital shall be extinguished.

6. This Agreement and Plan of Merger shall be submitted to the shareholders of each of the Corporations for approval by unanimous written consent and agreement pursuant to and in accordance with §1924(a) of the Business Corporation Law of 1988.

7. At any time prior to the Effective Date, this Agreement and Plan of Merger may be terminated by the board of directors of either of the Corporations.

IN WITNESS WHEREOF, the parties hereto, with the intent to be legally bound hereby, have entered into this Agreement and Plan of Merger and have duly authorized their respective officers to execute the same in their respective corporate names, the day and year first above written.

PARSEC SIGHT/SOUND, INC.

By:

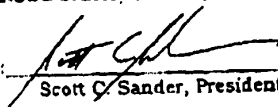
Scott C. Sander, President

DIGITAL SIGHT/SOUND, INC.

By:

Scott C. Sander, President

Exhibit "A"**AGREEMENT AND PLAN OF MERGER**

THIS AGREEMENT AND PLAN OF MERGER (this "Agreement and Plan of Merger") made this 22nd day of September, 1998, by and between **PARSEC SIGHT/SOUND, INC.** ("Parsec"), a Pennsylvania corporation with its registered office located at 733 Washington Road, Suite 212, Mt. Lebanon, Pennsylvania 15228, and **DIGITAL SIGHT/SOUND, INC.** ("Digital"), a Pennsylvania corporation with its registered office located at 733 Washington Road, Suite 212, Mt. Lebanon, Pennsylvania 15228. Parsec and Digital are also herein referred to collectively as the "Corporations".

WHEREAS, Parsec and Digital are corporations duly organized and validly existing under the laws of the Commonwealth of Pennsylvania, having both been incorporated on August 1, 1995, under and in accordance with the provisions of the Pennsylvania Business Corporation Law of 1988, Act of December 21, 1988, P.L. 1144, as amended (the "Business Corporation Law of 1988"); and

WHEREAS, the Corporations desire to merge Digital into Parsec under and in accordance with the provisions of the Business Corporation Law of 1988.

NOW, THEREFORE, in consideration of the premises and of the terms and conditions hereinafter set forth, the parties hereto, with the intent to be legally bound hereby, mutually agree to merge the Corporations upon the following terms and conditions:

1. Upon compliance with the applicable provisions of the Business Corporation Law of 1988, on the Effective Date (as defined herein), Digital shall be merged with and into Parsec and thereupon the separate existence of Digital shall cease. Parsec, as it shall exist after the Effective Date, is hereinafter referred to as the "Surviving Corporation".

2. Articles of Merger shall be filed with the Department of State of the Commonwealth of Pennsylvania, and the merger shall be effective as of the date of filing of said Articles of Merger (the "Effective Date").

3. The Articles of Incorporation and By-laws of Parsec, as amended through the Effective Date, shall continue to be the Articles of Incorporation and By-laws of the Surviving Corporation and shall not be amended or otherwise affected by the merger provided for herein except as follows:

a. Article 1 of the Articles of Incorporation and Section 1.1 of the By-laws shall both read as follows: The name of the Corporation is SIGHTSOUND.COM INCORPORATED.

b. Article 2 of the Articles of Incorporation shall read as follows: The address of this corporation's registered office in this Commonwealth and the county of venue is 733 Washington Road, Suite 405, Mt. Lebanon, Pennsylvania 15228, Allegheny.

PCDOCS #: 139018

Digital Sight/Sound, Inc.

Adopted by the directors and shareholders pursuant to 15 Pa.C.S. § 1924(a)

6. (Strike out this paragraph if no foreign corporation is a party to the merger). ~~The plan was authorized, adopted or approved, as the case may be, by the foreign business corporation (or each of the foreign business corporations) party to the plan in accordance with the laws of the jurisdiction in which it is incorporated.~~

7. (Check, and if appropriate complete, one of the following):

The plan of merger is set forth in full in Exhibit A attached hereto and made a part hereof.

Pursuant to 15 Pa.C.S. §1901 (relating to omission of certain provisions from filed plans) the provisions of the plan of merger that amend or constitute the operative Articles of Incorporation of the surviving corporation as in effect subsequent to the effective date of the plan are set forth in full in Exhibit A, attached hereto and made a part hereof. The full text of the plan of merger is on file at the principal place of business of the surviving corporation, the address of which is:

N/A
Number and Street City State Zip County

IN TESTIMONY WHEREOF, each undersigned corporation has caused these Articles of Merger to be signed by a duly authorized officer thereof this 31st day of March, 1999.

PARSEC SIGHT/SOUND, INC.

BY: [Signature]
Scott C. Sander, President

DIGITAL SIGHT/SOUND, INC.

BY: [Signature]
Scott C. Sander, President

PCDOCS-139018

(b) c/o _____
Name of Commercial Registered Office Provider County

For a corporation represented by a commercial registered office provider, the county in (b) shall be deemed the county in which the corporation is located for venue and official publication purposes.

N/A The surviving corporation is a nonqualified foreign business corporation incorporated under the laws of and the address of its principal office under the laws of such domiciliary jurisdiction is:

N/A _____
Number and Street City State Zip County

3. The name and the address of the registered office in this Commonwealth or name of its commercial registered office provider and the county of venue of each other domestic business corporation and qualified foreign business corporation which is a party to the plan of merger are as follows:

<u>Name of Corporation</u>	<u>Address of Registered Office or Name of Commercial Registered Office Provider</u>	<u>County</u>
Digital Sight/Sound, Inc.	733 Washington Road Mt. Lebanon, PA 15228	Allegheny

4. (Check, and if appropriate complete, one of the following):

The plan of merger shall be effective upon filing these Articles of Merger in the Department of State.

The plan of merger shall be effective on:

_____ at _____
Date Hour

5. The manner in which the plan of merger was adopted by each domestic corporation is as follows:

<u>Name of Corporation</u>	<u>Manner of adoption</u>
Parsec Sight/Sound, Inc.	Adopted by the directors and shareholders pursuant to 15 Pa.C.S. § 1924(a)

This Page is Inserted by IFW Indexing and Scanning Operations and is not part of the Official Record

BEST AVAILABLE IMAGES

Defective images within this document are accurate representations of the original documents submitted by the applicant.

Defects in the images include but are not limited to the items checked:

- BLACK BORDERS
- IMAGE CUT OFF AT TOP, BOTTOM OR SIDES
- ✓ FADED TEXT OR DRAWING
- BLURRED OR ILLEGIBLE TEXT OR DRAWING
- SKEWED/SLANTED IMAGES
- COLOR OR BLACK AND WHITE PHOTOGRAPHS
- GRAY SCALE DOCUMENTS
- LINES OR MARKS ON ORIGINAL DOCUMENT
- REFERENCE (S) OR EXHIBIT (S) SUBMITTED ARE POOR QUALITY
- OTHER: _____

IMAGES ARE BEST AVAILABLE COPY.

As rescanning these documents will not correct the image problems checked, please do not report these problems to the IFW Image problem Mailbox.

01-30-2002

Form PTO-1595

(Rev. 03/01)

OMB NO. 0651-0027 (exp. 5/31/2002)

Tab settings => => □ □



101964848

U.S. DEPARTMENT OF COMMERCE
U.S. Patent and Trademark Office

To the Honorable Commissioner of Patents and Trademarks: Please record the attached original documents or copy thereof.

1. Name of conveying party(ies):

SightSound Technologies, Inc.

10-27-01

Additional name(s) of conveying party(ies) attached? Yes No

3. Nature of conveyance:

- Assignment
- Merger
- Security Agreement
- Change of Name
- Other Notice of Grant of Security Interest

Execution Date: October 1, 2001

2. Name and address of receiving party(ies)

Name: Kenyon & Kenyon

Internal Address: _____

Street Address: One Broadway

City: New York State: N.Y. Zip: 10004

Additional name(s) & address(es) attached? Yes No

4. Application number(s) or patent number(s):

If this document is being filed together with a new application, the execution date of the application is: _____

A. Patent Application No.(s) 09/286,892

09/469,802 09/256,432 09/706,048

09/710,380

Additional numbers attached? Yes No

B. Patent No.(s) 5,191,573 5,675,734

5,966,440 6,014,491

5. Name and address of party to whom correspondence concerning document should be mailed:

Name: Deborah Hartnett, Esq.

Paul, Weiss, Rifkind, Wharton &

Internal Address: Garrison

Street Address: 1285 Avenue of the Americas

City: New York State: NY Zip: 10019

6. Total number of applications and patents involved: 9

7. Total fee (37 CFR 3.41) \$ 360.00

- Enclosed
- Authorized to be charged to deposit account

8. Deposit account number:

(Attach duplicate copy of this page if paying by deposit account)

DO NOT USE THIS SPACE

9. Statement and signature

To the best of my knowledge and belief, the foregoing information is true and correct and any attached copy is a true copy of the original document.

Minter Krotzer

Name of Person Signing

Signature

10/24/01

Date

Total number of pages including cover sheet, attachments, and documents: 6

01/19/01 10:58:31 00000291 09286892 360.00

Mail documents to be recorded with required cover sheet information to:
Commissioner of Patents & Trademarks, Box Assignments
Washington, D.C. 20231

Doc#: NY6: 61198.1

PATENT
REEL: 012506 FRAME: 0415

Additional Receiving Parties

1. Ansel M. Schwartz
One Sterling Plaza
201 N. Craig Street, Suite 304
Pittsburgh, PA 15213
2. Waterview Partners, LLP
152 West 57th Street, 46th Floor
New York, NY 10019
3. D&DF Waterview Partners, L.P.
152 West 57th Street, 46th Floor
New York, NY 10019

Notice of Grant of Security Interest in Patents

NOTICE OF GRANT OF SECURITY INTEREST IN PATENTS (the "Notice"), dated as of October 1, 2001, made by SIGHTSOUND TECHNOLOGIES, INC., a Delaware corporation ("Pledgor"), in favor of KENYON & KENYON ("KK"), Ansel M. Schwartz ("Schwartz"), Waterview Partners, LLP ("WPL") and D&DF Waterview Partners, L.P. ("DWPL"), (each, a "Secured Parties" and collectively, the "Secured Parties").

WHEREAS, Pledgor is the owner of certain patents and patent applications as set forth in Schedule 1 attached hereto (collectively, the "Patents"); and

WHEREAS, pursuant to the Security Agreement, dated as of the date hereof, between Pledgor and Secured Parties (the "Security Agreement"), Pledgor granted to Secured Parties a security interest in, and lien on, certain intellectual property of Pledgor, including (a) all letters patent of the United States or any other country and all reissues and extensions thereof, including, without limitation, the Patents, and the inventions and improvements described and claimed therein, if any, and patentable inventions, (b) the reissues, divisions, continuations, renewals, extensions, reexaminations and continuations-in-part of any of the foregoing, (c) all applications for any of the foregoing in the United States or any other country and (d) all agreements, whether written or oral, providing for the grant by or to Pledgor of any right to manufacture, use or sell any invention covered by a Patent, including, without limitation, any thereof referred to in Schedule 1 ("Patent Licenses"), in each case, now owned or hereafter acquired or in which Pledgor now has or at any time in the future may acquire any right, title or interest (collectively, the "Patent Collateral").

WHEREAS, pursuant to the Security Agreement, Pledgor agreed to execute and deliver to Secured Parties this Notice for purposes of filing the same with the United States Patent and Trademark Office (the "PTO") to confirm, evidence and perfect the security interest in the Patent Collateral granted pursuant to the Security Agreement;

NOW, THEREFORE, for good and valuable consideration, the receipt and sufficiency of which are hereby acknowledged, and subject to the terms and conditions of the Security Agreement (as the same may be from time to time amended, restated or supplemented), the terms of which are incorporated by reference herein, Pledgor hereby grants to Secured Parties a security interest in, and lien, on the Patent Collateral.

Pledgor hereby acknowledges the sufficiency and completeness of this Notice to create the security interest in the Patent Collateral and to grant the same to Secured Parties, and Pledgor hereby requests the PTO to file and record the same together with the annexed Schedule 1.

Pledgor and Secured Parties hereby acknowledge and agree that the security interest in the Patent Collateral may only be terminated, and Secured Parties

rights as secured parties may only be exercised, in accordance with the terms of the Security Agreement.

IN WITNESS WHEREOF, the undersigned has caused this Notice to be duly executed and delivered as of the date first above written.

SIGHTSOUND TECHNOLOGIES, INC.

By: 
Name: SCOTT C. SANDER
Title: PRESIDENT & CEO

STATE OF Pennsylvania
: ss.:
COUNTY OF Allegheny)

On the 15 day of October, 2001, before me the undersigned, personally appeared Scott C. Sander, personally known to me or proved to me on the basis of satisfactory evidence to be the individual whose name is subscribed to the within instrument and acknowledged to me that he executed the same in his capacity, and that by his signature on the instrument, the individual, or the person upon behalf of which the individual acted, executed the instrument.

Eleanor A. Carpenter
Notary Public

Notarial Seal
Eleanor A. Carpenter, Notary Public
Mt. Lebanon Twp., Allegheny County
My Commission Expires May 2, 2005
Member, Pennsylvania Association of Notaries

Patents

A. Issued Patents

<u>Description</u>	<u>Patent No.</u>
Title: Method for Transmitting a Desired Digital Video or Audio Signal	5,191,573
Title: System for Transmitting Desired Digital Video or Audio Signals	5,675,734
Title: System and Method for Transmitting Desired Digital Video or Audio Signals	5,966,440
Title: Method and System for Manipulation of Audio or Video Signals	6,014,491

B. Patent Applications

<u>Patent No.</u>	<u>Application No.</u>
	09/286,892
	09/469,802
	09/256,432
	09/706,048
	09/710,380

Patent Licenses

There was a license with Henry R. Moore, an individual doing business as Moore Multimedia Publishing, dated March 25, 1999. Under the terms of the license, it has expired. However, Mr. Moore and SightSound have expressed an interest in renewing the license.

Doc#: NY6: 44648.1

RECORDED: 10/24/2001

PATENT
REEL: 012506 FRAME: 0420

Doc Code: 70053 U.S. PTO

PTO/SB/82 (04-05)
 Approved for use through 11/30/2005. OMB 0651-0035
 Patent and Trademark Office: U.S. DEPARTMENT OF COMMERCE

Under the Paperwork Reduction Act of 1995, no persons are required to respond to a collection of information unless it displays a valid OMB control



12/27/05

REVOCATION OF POWER OF ATTORNEY WITH NEW POWER OF ATTORNEY AND CHANGE OF CORRESPONDENCE ADDRESS

Application Number	5,191,573 901607402
Filing Date	03/02/1993
First Named Inventor	Arthur R. Hair
Art Unit	2132
Examiner Name	Benjamin E. Lanier
Attorney Docket Number	47274-219099-1

I hereby revoke all previous powers of attorney given in the above-identified application:

A Power of Attorney is submitted herewith.

OR

I hereby appoint the practitioners associated with the Customer Number:

Please change the correspondence address for the above-identified application to:

The address associated with Customer Number:

OR

<input checked="" type="checkbox"/> Firm or Individual Name	Robert A. Koons, Jr.				
Address	Drinker Biddle & Reath LLP One Logan Square 18th & Cherry Streets				
City	Philadelphia	State	PA	ZIP	19103-6996
Country	United States of America				
Telephone	(215) 988-3392	Email	robert.koons@dbr.com		

I am the:

Applicant/Inventor.....

Assignee of record of the entire interest. See 37 CFR 3.71
 Statement under 37CFR 3.73(b) is enclosed. (Form PTO/SB/96)

SIGNATURE of Applicant or Assignee of Record

Signature					
Name	Kenneth Clark, Assistant Secretary DMT Licensing, LLC				
Date	12/22/2005	Telephone	609-734-9562		

NOTE: Signatures of all the inventors or assignees of record of the entire interest or their representative(s) are required. Submit multiple forms if more than one signature is required, see below*.

*Total of _____ forms are submitted.

This collection of information is required by 37 CFR 1.36. The information is required to obtain or retain a benefit by the public which is to file (and by the USPTO to process) an application. Confidentiality is governed by 35 U.S.C. 122 and 37 CFR 1.11 and 1.14. This collection is estimated to take 3 minutes to complete, including gathering, preparing, and submitting the completed application form to the USPTO. Time will vary depending on the individual case. Any comments on the amount of time you require to complete this form and/or suggestions for reducing this burden should be sent to the Chief Information Officer, U.S. Patent and Trademark Office, U.S. Department of Commerce, P.O. Box 1450, Alexandria, VA 22313-1450. DO NOT SEND FEES OR COMPLETED FORMS TO THIS ADDRESS. SEND TO: Commissioner for Patents, P.O. Box 1450, Alexandria, VA 22313-1450.

If you need assistance in completing the form, call 1-800-PTO-9199 and select option 2.

Doc Code:

Approved for use through 07/31/2006. OMB 0651-0031
U.S. Patent and Trademark Office; U.S. DEPARTMENT OF COMMERCE

Under the Paperwork Reduction Act of 1995, no persons are required to respond to a collection of information unless it displays a valid OMB control number.

STATEMENT UNDER 37 CFR 3.73(b)

Applicant/Patent Owner: DMT Licensing, LLC

Application No./Patent No.: 5,191,573 Filed/Issue Date: 03/02/1993

Entitled: **Method for Transmitting a Desired Digital Video or Audio Signal**

DMT Licensing, LLC

, a Delaware Limited Liability Company

(Name of Assignee)

(Type of Assignee, e.g., corporation, partnership, university, government agency, etc.)

states that it is:

- 1. the assignee of the entire right, title, and interest; or
- 2. an assignee of less than the entire right, title and interest.
The extent (by percentage) of its ownership interest is _____ %

in the patent application/patent identified above by virtue of either:

A. An assignment from the inventor(s) of the patent application/patent identified above. The assignment was recorded in the United States Patent and Trademark Office at Reel _____, Frame _____, or for which a copy thereof is attached.

OR

B. A chain of title from the inventor(s), of the patent application/patent identified above, to the current assignee as shown below:

- 1. From: _____ To: _____
The document was recorded in the United States Patent and Trademark Office at Reel _____, Frame _____, or for which a copy thereof is attached.
- 2. From: _____ To: _____
The document was recorded in the United States Patent and Trademark Office at Reel _____, Frame _____, or for which a copy thereof is attached.
- 3. From: _____ To: _____
The document was recorded in the United States Patent and Trademark Office at Reel _____, Frame _____, or for which a copy thereof is attached.

Additional documents in the chain of title are listed on a supplemental sheet.

Copies of assignments or other documents in the chain of title are attached.

[NOTE: A separate copy (i.e., a true copy of the original assignment document (s)) must be submitted to Assignment Division in accordance with 37 CFR Part 3, if the assignment is to be recorded in the records of the USPTO. See MPEP 302.08]

The undersigned (whose title is supplied below) is authorized to act on behalf of the assignee.

Signature

Kenneth Glick

Printed or Typed Name

Assistant Secretary, DMT Licensing, LLC

Title

12/22/2005

Date

609-734-9562

Telephone number

This collection of information is required by 37 CFR 3.73(b). The information is required to obtain or retain a benefit by the public which is to file (and by the USPTO to process) an application. Confidentiality is governed by 35 U.S.C. 122 and 37 CFR 1.11 and 1.14. This collection is estimated to take 12 minutes to complete, including gathering, preparing, and submitting the completed application form to the USPTO. Time will vary depending upon the individual case. Any comments on the amount of time you require to complete this form and/or suggestions for reducing this burden, should be sent to the Chief Information Officer, U.S. Patent and Trademark Office, U.S. Department of Commerce, P.O. Box 1450, Alexandria, VA 22313-1450. DO NOT SEND FEES OR COMPLETE D FORMS TO THIS ADDRESS. SEND TO: Commissioner for Patents, P.O. Box 1450, Alexandria, VA 22313-1450.

If you need assistance in completing the form, call 1-800-PTO-9199 and select option 2.



UNITED STATES PATENT AND TRADEMARK OFFICE

UNITED STATES DEPARTMENT OF COMMERCE
United States Patent and Trademark Office
Address: COMMISSIONER FOR PATENTS
P.O. Box 1450
Alexandria, Virginia 22313-1450
www.uspto.gov

APPLICATION NO.	FILING DATE	FIRST NAMED INVENTOR	ATTORNEY DOCKET NO.	CONFIRMATION NO.
90/007,402	01/31/2005	5191573	NAPS001	2998

7590 01/19/2006
Ansel M. Schwartz
425 N. Craig Street Suite 301
Pittsburgh, PA 15213

EXAMINER

ART UNIT PAPER NUMBER

DATE MAILED: 01/19/2006

Please find below and/or attached an Office communication concerning this application or proceeding.



UNITED STATES PATENT AND TRADEMARK OFFICE

Commissioner for Patents
United States Patent and Trademark Office
P.O. Box 1450
Alexandria, VA 22313-1450
www.uspto.gov

DO NOT USE IN PALM PRINTER

(THIRD PARTY REQUESTER'S CORRESPONDENCE ADDRESS)

Albert S. Penilla
MARTINE PENILLA & GENCARELLA, LLP
710 Lakeview Drive, Suite 200
Sunnyvale, CA 94085

EX PARTE REEXAMINATION COMMUNICATION TRANSMITTAL FORM

REEXAMINATION CONTROL NO. 801007.402

PATENT NO. 5191573

ART UNIT 2132

Enclosed is a copy of the latest communication from the United States Patent and Trademark Office in the above identified *ex parte* reexamination proceeding (37 CFR 1.550(f)).

Where this copy is supplied after the reply by requester, 37 CFR 1.535, or the time for filing a reply has passed, no submission on behalf of the *ex parte* reexamination requester will be acknowledged or considered (37 CFR 1.550(g)).

PTOL-465 (Rev. 07-04)

**Notice Of Defective Paper In
Ex Parte Reexamination**

Control Number

90/007,402

Patent Under Reexamination

5191573

Examiner

Benjamin E. Lanier

Art Unit

2132

--The MAILING DATE of this communication appears on the cover sheet with the correspondence address--

1. Since no proof of service was included with the paper filed on _____, it fails to comply with 37 CFR 1.248 and 1.540. Proof of service is required within ONE (1) MONTH or THIRTY (30) DAYS from the mailing date of this letter, whichever is longer. Failure to provide proof of service may result in a refusal to consider the paper. If the failure to comply with this requirement results in a patent owner failure to file a timely and appropriate response to any Office action or any written statement of an interview required under 37 CFR 1.560(b), the prosecution of the reexamination proceeding will be terminated under 37 CFR 1.550(d).
2. The paper filed on _____ is unsigned. A duplicate paper or ratification, properly signed, is required within ONE (1) MONTH or THIRTY (30) DAYS from the mailing date of this letter, whichever is longer. Failure to comply with this requirement will result in the paper not being considered. If the failure to comply results in a patent owner failure to file a timely and appropriate response to any Office action or any written statement of an interview required under 37 CFR 1.560(b), the prosecution of the reexamination proceeding will be terminated under 37 CFR 1.550(d).
3. The paper filed on _____ is signed by _____, who is not of record. A duplicate paper or ratification signed by a person of record, a person made of record by way of a new power of attorney, is required within ONE (1) MONTH or THIRTY (30) DAYS from the mailing date of this letter, whichever is longer. Failure to comply with this requirement will result in the paper not being considered. If the failure to comply results in a patent owner failure to file a timely and appropriate response to any Office action or any written statement of an interview required under § 1.560(b), the prosecution of the reexamination proceeding will be terminated under 37 CFR 1.550(d).
4. The Amendment filed on 27 December 2005 does not comply with 37 CFR 1.530(d)-(j). Patent owner is given ONE (1) MONTH or THIRTY (30) DAYS from the mailing date of this letter, whichever is longer to correct this informality; otherwise, the prosecution of the the reexamination proceeding will be terminated under (37 CFR 1.550(d)).
5. The amendment filed by patent owner on _____, does not comply with 37 CFR 1.20(c)(3) and/or 1.20(c)(4), as to excess claim fees. Patent owner is given a time period of ONE (1) MONTH or THIRTY (30) DAYS from the mailing date of this letter, whichever is longer, to correct this fee deficiency, or the prosecution of the reexamination proceeding will be terminated under 37 CFR 1.550(d), to effect the "abandonment" set forth in 37 CFR 1.20(c)(5).
6. Other :

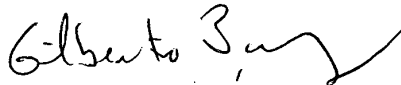
GILBERTO BARRON JR
SUPERVISORY PATENT EXAMINER
TECHNOLOGY CENTER 2100

NOTE: EXTENSION OF TIME ARE GOVERNED BY 37 CFR 1.550(c). If the period for response specified above is less than thirty (30) days, a response within the statutory minimum of thirty (30) days will be considered timely.

cc: Requester (if third party requester)

CERTIFICATE UNDER 37 C.F.R. 1.10

In Re: Arthur R. Hair

Docket No.: 219099/573

Patent No.: 5,191,573

Re-Examination Control No.: 90/007,402

Re-Examination Filing Date: January 31, 2005

Examiner: Benjamin E. Lanier

70181 U.S. PTO



01/20/06

EXPRESS MAIL: EV 299886460 US

DATE OF DEPOSIT: January 20, 2006

I hereby certify that the following correspondence

**Letter notifying Office of real party interest, and
Return receipt postcard**

are being deposited with the United States Postal Service "Express Mail Post Office to Addressee" service under 37 CFR 1.10 on the date indicated above and is addressed to Mail Stop Ex Parte Re-Examination, Commissioner for Patents, PO Box 1450, Alexandria, VA 22313-1450.

Jane D. Roberts

(Typed or printed name of person mailing paper)

(Signature of person mailing paper or fee)

Drinker Biddle & Reath LLP
One Logan Square
18th and Cherry Streets
Philadelphia, PA 19103-6996

Customer No. 23973

EV299886460US

IN THE UNITED STATES PATENT AND TRADEMARK OFFICE

In re Application of:)
)
ARTHUR R. HAIR)
)
Reexamination Control No.: 90/007,402)
)
Reexamination Filed: January 31, 2005) METHOD FOR
) TRANSMITTING A DESIRED
Patent Number: 5,191,573) DIGITAL VIDEO OR AUDIO
) SIGNAL
Examiner: Benjamin E. Lanier)

Mail Stop Ex parte Reexamination
 Commissioner for Patents
 P.O. Box 1450
 Alexandria, VA 22313-1450



Sir:

In compliance with the duty of candor and good faith to the Office, Applicant wishes to notify the Office of the recent assignment of the subject Patent No. 5,191,573, in Reexamination Control Number 90/007,402 to DMT Licensing, LLC, whose owner, and therefore the real party in interest is the General Electric Company. Further, Applicant wishes to notify the Office that DMT Licensing, LLC and the real party in interest, the General Electric Company, have also received by assignment the ownership of U.S. Patent Nos. 5,675,734 and 5,966,440, which are currently the subject of Reexamination Control Nos. 90/007,403; and 90/007,407 respectively, and Patent Application Control No. 09/286,892.

Respectfully submitted

DRINKER, BIDDLE & REATH LLP

Robert A. Kohns, Jr.
 Reg. No. 32,474
 Attorney for Patentee

DRINKER, BIDDLE & REATH LLP
 One Logan Square
 18th and Cherry Streets
 Philadelphia, PA 19103

CERTIFICATE OF SERVICE

The undersigned hereby certifies that a true and correct copy of the foregoing document was served via First Class United States Mail, postage prepaid, this 20th day of January, 2006, on the following:

Mr. Albert S. Penilla
Martine, Penilla, & Gencarella, LLP
710 Lakeway Drive, Suite 200
Sunnyvale, CA 94085
Attorney for Third Party Reexamination Requester

By: _____

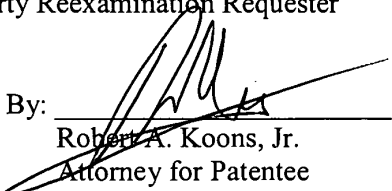
Robert A. Koons, Jr.
Attorney for Patentee



UNITED STATES PATENT AND TRADEMARK OFFICE

UNITED STATES DEPARTMENT OF COMMERCE
 United States Patent and Trademark Office
 Address: COMMISSIONER FOR PATENTS
 P.O. Box 1450
 Alexandria, Virginia 22313-1450
 www.uspto.gov

APPLICATION NUMBER	FILING OR 371 (c) DATE	FIRST NAMED APPLICANT	ATTY. DOCKET NO./TITLE
90/007,402	01/31/2005	5191573	NAPS001

CONFIRMATION NO. 2998

23973
 DRINKER BIDDLE & REATH
 ATTN: INTELLECTUAL PROPERTY GROUP
 ONE LOGAN SQUARE
 18TH AND CHERRY STREETS
 PHILADELPHIA, PA 19103-6996



Date Mailed: 01/24/2006

NOTICE OF ACCEPTANCE OF POWER OF ATTORNEY

This is in response to the Power of Attorney filed 12/27/2005.

The Power of Attorney in this application is accepted. Correspondence in this application will be mailed to the above address as provided by 37 CFR 1.33.



Michelle R. Eason

 MICHELLE R EASON
 3921 (571) 272-4231

OFFICE COPY



UNITED STATES PATENT AND TRADEMARK OFFICE

UNITED STATES DEPARTMENT OF COMMERCE
 United States Patent and Trademark Office
 Address: COMMISSIONER FOR PATENTS
 P.O. Box 1450
 Alexandria, Virginia 22313-1450
 www.uspto.gov

APPLICATION NUMBER	FILING OR 371 (c) DATE	FIRST NAMED APPLICANT	ATTY. DOCKET NO./TITLE
90/007,402	01/31/2005	5191573	NAPS001

CONFIRMATION NO. 2998

Ansel M. Schwartz
 425 N. Craig Street Suite 301
 Pittsburgh, PA 15213



Date Mailed: 01/24/2006

NOTICE REGARDING CHANGE OF POWER OF ATTORNEY

This is in response to the Power of Attorney filed 12/27/2005.

- The Power of Attorney to you in this application has been revoked by the assignee who has intervened as provided by 37 CFR 3.71. Future correspondence will be mailed to the new address of record(37 CFR 1.33).

 MICHELLE R EASON
 3921 (571) 272-4231

OFFICE COPY



UNITED STATES PATENT AND TRADEMARK OFFICE

UNITED STATES DEPARTMENT OF COMMERCE
United States Patent and Trademark Office
Address: COMMISSIONER FOR PATENTS
P.O. Box 1450
Alexandria, Virginia 22313-1450
www.uspto.gov

APPLICATION NO.	FILING DATE	FIRST NAMED INVENTOR	ATTORNEY DOCKET NO.	CONFIRMATION NO.
90/007,402	01/31/2005	5191573	NAPS001	2998
23973	7590	01/27/2006	EXAMINER	
DRINKER BIDDLE & REATH ATTN: INTELLECTUAL PROPERTY GROUP ONE LOGAN SQUARE 18TH AND CHERRY STREETS PHILADELPHIA, PA 19103-6996			ART UNIT	PAPER NUMBER

DATE MAILED: 01/27/2006

Please find below and/or attached an Office communication concerning this application or proceeding.



UNITED STATES PATENT AND TRADEMARK OFFICE

Commissioner for Patents
United States Patent and Trademark Office
P.O. Box 1450
Alexandria, VA 22313-1450
www.uspto.gov

DO NOT USE IN PALM PRINTER

(THIRD PARTY REQUESTER'S CORRESPONDENCE ADDRESS)

Albert S. Penilla
MARTINE PENILLA & GENCARELLA, LLP
710 Lakeway Drive, Suite 200
Sunnyvale, CA 94085

EX PARTE REEXAMINATION COMMUNICATION TRANSMITTAL FORM

REEXAMINATION CONTROL NO. 90/007,402.

PATENT NO. 5191573.

ART UNIT 2132.

Enclosed is a copy of the latest communication from the United States Patent and Trademark Office in the above identified *ex parte* reexamination proceeding (37 CFR 1.550(f)).

Where this copy is supplied after the reply by requester, 37 CFR 1.535, or the time for filing a reply has passed, no submission on behalf of the *ex parte* reexamination requester will be acknowledged or considered (37 CFR 1.550(g)).

**Notice Of Defective Paper In
Ex Parte Reexamination**

Control Number

90/007,402

Patent Under Reexamination

5191573

Examiner

Benjamin E. Lanier

Art Unit

2132

--The MAILING DATE of this communication appears on the cover sheet with the correspondence address--

1. Since no proof of service was included with the paper filed on _____, it fails to comply with 37 CFR 1.248 and 1.540. Proof of service is required within ONE (1) MONTH or THIRTY (30) DAYS from the mailing date of this letter, whichever is longer. Failure to provide proof of service may result in a refusal to consider the paper. If the failure to comply with this requirement results in a patent owner failure to file a timely and appropriate response to any Office action or any written statement of an interview required under 37 CFR 1.560(b), the prosecution of the reexamination proceeding will be terminated under 37 CFR 1.550(d).
2. The paper filed on _____ is unsigned. A duplicate paper or ratification, properly signed, is required within ONE (1) MONTH or THIRTY (30) DAYS from the mailing date of this letter, whichever is longer. Failure to comply with this requirement will result in the paper not being considered. If the failure to comply results in a patent owner failure to file a timely and appropriate response to any Office action or any written statement of an interview required under 37 CFR 1.560(b), the prosecution of the reexamination proceeding will be terminated under 37 CFR 1.550(d).
3. The paper filed on _____ is signed by _____, who is not of record. A duplicate paper or ratification signed by a person of record, a person made of record by way of a new power of attorney, is required within ONE (1) MONTH or THIRTY (30) DAYS from the mailing date of this letter, whichever is longer. Failure to comply with this requirement will result in the paper not being considered. If the failure to comply results in a patent owner failure to file a timely and appropriate response to any Office action or any written statement of an interview required under § 1.560(b), the prosecution of the reexamination proceeding will be terminated under 37 CFR 1.550(d).
4. The Amendment filed on 27 December 2005 does not comply with 37 CFR 1.530(d)-(j). Patent owner is given ONE (1) MONTH or THIRTY (30) DAYS from the mailing date of this letter, whichever is longer to correct this informality; otherwise, the prosecution of the the reexamination proceeding will be terminated under (37 CFR 1.550(d)).
5. The amendment filed by patent owner on _____, does not comply with 37 CFR 1.20(c)(3) and/or 1.20(c)(4), as to excess claim fees. Patent owner is given a time period of ONE (1) MONTH or THIRTY (30) DAYS from the mailing date of this letter, whichever is longer, to correct this fee deficiency, or the prosecution of the reexamination proceeding will be terminated under 37 CFR 1.550(d), to effect the "abandonment" set forth in 37 CFR 1.20(c)(5).
6. Other :

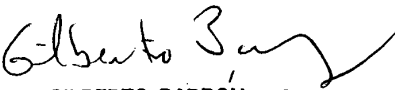
GILBERTO BARRON JR.
SUPERVISORY PATENT EXAMINER
TECHNOLOGY CENTER 2100

NOTE: EXTENSION OF TIME ARE GOVERNED BY 37 CFR 1.550(c). If the period for response specified above is less than thirty (30) days, a response within the statutory minimum of thirty (30) days will be considered timely.

cc: Requester (if third party requester)

IN THE UNITED STATES PATENT AND TRADEMARK OFFICE

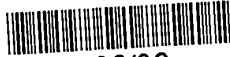
In re Application of:)
ARTHUR R. HAIR) 70181 U.S. PTO
Reexamination Control No. 90/007,402) 
Reexamination Filed: January 31, 2005) 02/06/06
Patent Number: 5,191,573) METHOD FOR TRANSMITTING
Examiner: Benjamin E. Lanier) A DESIRED DIGITAL VIDEO OR
AUDIO SIGNAL
)

Mail Stop *Ex Parte* Reexamination
Commissioner for Patents
P.O. Box 1450
Alexandria, VA 22313-1450

RESPONSE TO NOTICE OF DEFECTIVE PAPER
IN EX PARTE REEXAMINATION

Sir:

In response to the Notice of Defective Paper in *Ex Parte* Reexamination mailed January 27, 2006, Applicant respectfully submits herewith a corrected Response under 37 C.F.R. § 1.530 in *Ex Parte* Reexamination.

1. Pursuant to 37 C.F.R. § 1.530(d)(2), Applicant has listed the entire text of all claims proposed to be changed or added by the instant amendment. Applicant respectfully points out that the instant amendment only proposes to add claims 7 to 43. No changes to existing claims 1 to 6 are proposed in the instant amendment.

2. Pursuant to 37 C.F.R. § 1.530(e), Applicant has provided on a separate sheet from the amendments a listing of the status of each claim in the reexamination as of the date of the instant amendment, as either pending or canceled.

3. Pursuant to 37 C.F.R. § 1.530(f)(2), Applicant has underlined the new text of the claims being added by amendment.

4. Pursuant to 37 C.F.R. § 1.530(g), Applicant has preserved the numbering of the claims in the instant amendment.

5. The terms used in the newly added claims correspond to terms appearing in the specification of U.S. Patent Serial Number 5,191,573 as issued. Applicant therefore believes that no amendment of the disclosure pursuant to 37 C.F.R. § 1.530(h) is necessary.

6. Pursuant to 37 C.F.R. § 1.530(i), all amendments have been made relative to the patent specification, including claims and drawings in effect as of the date of filing the request for reexamination.

7. Pursuant to 37 C.F.R. § 1.530(j), the scope of the claims has not been enlarged by the instant amendments, as noted at page 13 of the response.

Applicant respectfully submits that the amended response filed herewith complies with all of the requirements of 37 C.F.R. § 1.530(d)-(j). If the Office believes that any portion of the response does not comply with the requirements of 37 C.F.R. § 1.530(d)-(j), the Office is hereby requested to contact the Applicant's undersigned attorney directly.

Respectfully submitted,

DRINKER BIDDLE & REATH LLP

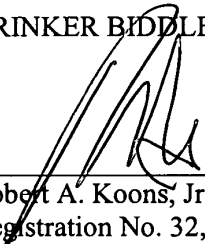

Robert A. Koons, Jr.
Registration No. 32,474
Attorney for Patentee

DRINKER BIDDLE & REATH LLP
One Logan Square
18th & Cherry Streets
Philadelphia, PA 19103-6996
Telephone: (215) 988-3392
Facsimile: (215) 988-2757
Customer No. 023973

February 6, 2006

CERTIFICATE OF SERVICE

The undersigned hereby certifies that a true and correct copy of the foregoing document was served via First Class United States Mail, postage prepaid, this 6th day of February, 2006, on the following:

Mr. Albert S. Penilla
Martine, Penilla, & Gencarella, LLP
710 Lakeway Drive, Suite 200
Sunnyvale, CA 94085
Attorney for Third Party Reexamination Requester

By: _____

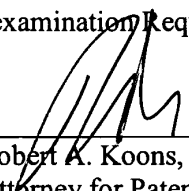
Robert A. Koons, Jr.
Attorney for Patentee

IN THE UNITED STATES PATENT AND TRADEMARK OFFICE

In re Application of:)
ARTHUR R. HAIR)
Reexamination Control No. 90/007,402)
Reexamination Filed: January 31, 2005) METHOD FOR TRANSMITTING
Patent Number: 5,191,573) A DESIRED DIGITAL VIDEO OR
Examiner: Benjamin E. Lanier) AUDIO SIGNAL
)

Mail Stop *Ex Parte* Reexamination
Commissioner for Patents
P.O. Box 1450
Alexandria, VA 22313-1450

Sir:

RESPONSE

In response to the Office Action for the above-identified reexamination dated October 26, 2005, please enter the following amendments and remarks.

Amendments to the Claims begin on page 2 of this paper.

Remarks begin on page 13 of this paper.

Claim Amendments

Please add new Claims 7 to 43 as follows:

7. (New) A method for transmitting a desired digital audio signal stored on a first memory of a first party to a second memory of a second party comprising the steps of:
transferring money electronically via a telecommunications line to the first party at a location remote from the second memory and controlling use of the first memory from the second party financially distinct from the first party, said second party controlling use and in possession of the second memory;
connecting electronically via a telecommunications line the first memory with the second memory such that the desired digital audio signal can pass therebetween;
transmitting the desired digital audio signal from the first memory with a transmitter in control and possession of the first party to a receiver having the second memory at a location determined by the second party, said receiver in possession and control of the second party;
storing the digital audio signal in the second memory; and
listing/scrolling digital audio signals from the second memory.

8. (New) A method as described in Claim 7 wherein the transferring step comprises the steps of telephoning the first party controlling use of the first memory by the second party; providing a credit card number of the second party controlling the second memory to the first party controlling the first memory so the second party is charged money.

9. (New) A method as described in Claim 7 further comprising the step of displaying a name of a digital audio signal from the second memory.

10. (New) A method as described in Claim 7 further comprising the step of displaying a duration of the digital audio signal from the second memory.

11. (New) A method as described in Claim 7 further comprising the step of displaying a name of an artist of the digital audio signal from the second memory.

12. (New) A method as described in Claim 7 further comprising the step of displaying a name of an album associated with the digital audio signal from the second memory.

13. (New) A method as described in Claim 7 further comprising the step of randomly selecting digital audio signals from the second memory by a second party integrated circuit of a second party control unit.

14. (New) A method for transmitting a desired digital video signal stored on a first memory of a first party to a second memory of a second party comprising the steps of: transferring money electronically via a telecommunications line to the first party location remote from the second memory and controlling use of the first memory, from a second party financially distinct from the first party, said second party in control and in possession of the second memory;

connecting electronically via a telecommunications line the first memory with the second memory such that the desired digital video signal can pass therebetween;

transmitting the desired digital video signal from the first memory with a transmitter in control and possession of the first party to a receiver having the second memory at a location determined by the second party, said receiver in possession and control of the second party;

storing the digital signal in the second memory; and

listing/scrolling digital video signals from the second memory.

15. (New) A method as described in Claim 14 wherein the transferring step comprises the steps of telephoning the first party controlling use of the first memory by the second party controlling the second memory; providing a credit card number of the second party controlling the second memory to the first party controlling the first memory so the second party controlling the second memory is charged money.

16. (New) A method as described in Claim 14 further comprising the step of displaying a name of a digital video signal from the second memory.

17. (New) A method as described in Claim 14 further comprising the step of listing/scrolling queued digital video signals stored in the second memory.

18. (New) A method as described in Claim 14 further comprising the step of displaying a duration of the digital video signal from the second memory.

19. (New) A method as described in Claim 14 further comprising the step of displaying a name of an artist of the digital video signal from the second memory.

20. (New) A method as described in Claim 14 further comprising the step of displaying a name of an album associated with the digital video signal from the second memory.

21. (New) A method as described in Claim 14 further comprising the step of randomly selecting digital video signals from the second memory by a second party integrated circuit of a second party control unit.

22. (New) A method for transmitting a desired digital audio signal stored on a first memory of a first party to a second memory of a second party comprising the steps of:

transferring money electronically via a telecommunications line to the first party at a location remote from the second memory and controlling use of the first memory from the second party financially distinct from the first party, said second party controlling use and in possession of the second memory;

connecting electronically via a telecommunications line the first memory with the second memory such that the desired digital audio signal can pass therebetween;

transmitting the desired digital audio signal from the first memory with a transmitter in control and possession of the first party to a receiver having the second memory at a location determined by the second party, said receiver in possession and control of the second party;

storing the digital audio signal in the second memory; and
randomly selecting digital audio signals from the second memory by a second
party integrated circuit of a second party control unit.

23. (New) A method as described in Claim 22 wherein the transferring step
further comprises the step of providing a credit card number of the second party controlling the
second memory to the first party controlling the first memory so the second party is charged
money.

24. (New) A method as described in Claim 22 further comprising the step of
listing/scrolling queued digital audio signals stored in the second memory.

25. (New) A method as described in Claim 22 further comprising the step of
displaying a name of a digital audio signal from the second memory.

26. (New) A method for transmitting a desired digital audio signal stored on a
first memory of a first party to a second memory of a second party comprising the steps of:
transferring money electronically via a telecommunications line to the first party
at a location remote from the second memory and controlling use of the first memory from the
second party financially distinct from the first party, said second party controlling use and in
possession of the second memory;

connecting electronically via a telecommunications line the first memory with the
second memory such that the desired digital audio signal can pass therebetween;

transmitting the desired digital audio signal from the first memory with a transmitter in control and possession of the first party to a receiver having the second memory at a location determined by the second party, said receiver in possession and control of the second party;

storing the digital audio signal in the second memory; and

displaying a name of an artist of the digital audio signal from the second memory.

27. (New) A method as described in Claim 26 wherein the transferring step further comprises the step of providing a credit card number of the second party controlling the second memory to the first party controlling the first memory so the second party is charged money.

28. (New) A method as described in Claim 26 further comprising the step of listing/scrolling queued digital audio signals stored in the second memory.

29. (New) A method for transmitting a desired digital audio signal stored on a first memory of a first party to a second memory of a second party comprising the steps of: transferring money electronically via a telecommunications line to the first party at a location remote from the second memory and controlling use of the first memory from the second party financially distinct from the first party, said second party controlling use and in possession of the second memory;

connecting electronically via a telecommunications line the first memory with the second memory such that the desired digital audio signal can pass therebetween;

transmitting the desired digital audio signal from the first memory with a transmitter in control and possession of the first party to a receiver having the second memory at a location determined by the second party, said receiver in possession and control of the second party;

storing the digital audio signal in the second memory; and

displaying a duration of the digital audio signal from the second memory.

30. (New) A method as described in Claim 29 wherein the transferring step further comprises the step of providing a credit card number of the second party controlling the second memory to the first party controlling the first memory so the second party is charged money.

31. (New) A method as described in Claim 29 including the step of listing/scrolling queued digital audio signals stored in the second memory.

32. (New) A method as described in Claim 29 including the step of displaying a name of a digital audio signal from the second memory.

33. (New) A method for transmitting a desired digital video signal stored on a first memory of a first party to a second memory of a second party comprising the steps of: transferring money electronically via a telecommunications line to the first party at a location remote from the second memory and controlling use of the first memory from the

second party financially distinct from the first party, said second party controlling use and in possession of the second memory;

connecting electronically via a telecommunications line the first memory with the second memory such that the desired digital video signal can pass therebetween;

transmitting the desired digital video signal from the first memory with a transmitter in control and possession of the first party to a receiver having the second memory at a location determined by the second party, said receiver in possession and control of the second party;

storing the digital video signal in the second memory; and

randomly selecting digital video signals from the second memory by a second party integrated circuit of a second party control unit.

34. (New) A method as described in Claim 33 wherein the transferring step further comprises the step of providing a credit card number of the second party controlling the second memory to the first party controlling the first memory so the second party is charged money.

35. (New) A method as described in Claim 33 further comprising the step of listing/scrolling queued digital video signals stored in the second memory.

36. (New) A method as described in Claim 33 including the step of displaying a name of a digital video signal from the second memory.

37. (New) A method for transmitting a desired digital video signal stored on a first memory of a first party to a second memory of a second party comprising the steps of:
transferring money electronically via a telecommunications line to the first party at a location remote from the second memory and controlling use of the first memory from the second party financially distinct from the first party, said second party controlling use and in possession of the second memory;
connecting electronically via a telecommunications line the first memory with the second memory such that the desired digital video signal can pass therebetween;
transmitting the desired digital video signal from the first memory with a transmitter in control and possession of the first party to a receiver having the second memory at a location determined by the second party, said receiver in possession and control of the second party;
storing the digital video signal in the second memory; and
displaying a name of an artist of the digital video signal from the second memory.

38. (New) A method as described in Claim 37 wherein the transferring step further comprises the step of providing a credit card number of the second party controlling the second memory to the first party controlling the first memory so the second party is charged money.

39. (New) A method as described in Claim 37 including the step of listing/scrolling queued digital video signals stored in the second memory.

40. (New) A method for transmitting a desired digital video signal stored on a first memory of a first party to a second memory of a second party comprising the steps of:
transferring money electronically via a telecommunications line to the first party at a location remote from the second memory and controlling use of the first memory from the second party financially distinct from the first party, said second party controlling use and in possession of the second memory;
connecting electronically via a telecommunications line the first memory with the second memory such that the desired digital video signal can pass therebetween;
transmitting the desired digital video signal from the first memory with a transmitter in control and possession of the first party to a receiver having the second memory at a location determined by the second party, said receiver in possession and control of the second party;
storing the digital video signal in the second memory; and
displaying a duration of the digital video signal from the second memory.

41. (New) A method as described in Claim 40 wherein the transferring step further comprises the step of providing a credit card number of the second party controlling the second memory to the first party controlling the first memory so the second party is charged money.

42. (New) A method as described in Claim 40 further comprising the step of listing/scrolling queued digital video signals stored in the second memory.

43. (New) A method as described in Claim 40 further comprising the step of displaying a name of a digital video signal from the second memory.

REMARKS

Status of the Claims

Claims 1-43 are currently pending¹.

Amendments to the Claims

There have been no amendments to the previously pending claims, Claims 1 through 6, with this response. Claims 7-43 have been added. The newly added claims are fully supported by the specification. Support for new Claims 7-43 can be found in column 5, lines 5-25 of U.S. Patent 5,191,573 Patent as issued.

In addition, all newly added claims contain at least the same limitations as set forth in pending Claims 1 and 4. As a result, all of the newly added claims are presumed to be allowable for at least the same reasons as set forth below with respect to pending independent Claims 1 and 4. Further, Applicant respectfully submits that because the newly presented claims place additional limitations on existing claim elements, the scope of the claims has not been enlarged.

Rejections Under 35 U.S.C. § 103(a)

The Examiner has cited the combination of Akashi and Freeny in an effort to make out a *prima facie* case of obviousness of Claims 1-6 under 35 U.S.C. § 103(a). Applicant respectfully submits that the combination of Akashi and Freeny is inadequate to make out a *prima facie* case of obviousness of Claims 1-6.

¹ In considering these claims, Applicant wishes to direct the Examiner's attention to the reference identified as Number 849 in the Information Disclosure Statement filed July 21, 2005, which may not have been considered by the Examiner in the pending Office Action. Applicant does not believe this reference constitutes prior art that anticipates or renders obvious any of the original or newly added claims. Nonetheless, in view of the large number of references disclosed, Applicant wants to ensure that the

Comments On Examiner's Response To Arguments

In the Office Action dated October 26, 2005, the Examiner states in his *Response to Arguments* that the "District Court decision was an analysis of Freeny as a Section 102 reference and not as a secondary reference." Applicant respectfully disagrees with this characterization of the District Court's opinion. Applicant maintains that a thorough review of the Opinion and Order of Court dated October 23, 2003 (the "Opinion") in the Sightsound v. N2K et al. litigation demonstrates that the District Court analyzed Freeny as a Section 103 reference. Applicant respectfully directs the Examiner to section 2 of the Opinion and Order beginning on page 45, titled "*Defendants' Examples of Prior Art giving Rise to Obviousness*" (emphasis added), attached hereto as Exhibit A. The District Court Judge goes on to analyze the Section 103 references cited by the defendants, including specifically "The Freeny Patent" at page 52 of the Opinion. Accordingly, Applicant respectfully disagrees with the Examiner's position that Freeny was not analyzed as a secondary reference in an obviousness context. Moreover, Applicant submits that, not only did the District Court consider Freeny as a secondary reference, but the Court also reasoned that Freeny teaches away from Applicant's claimed invention. See Opinion, page 52-53.

Applicant also respectfully points out that the District Court specifically considered the Examiner's primary reference, Akashi, in regard to obviousness in its Opinion. See Opinion, page 50. Although not binding on the Examiner in this proceeding, Applicant respectfully submits that a reasoned analysis by a competent Court should be regarded by the Examiner as strongly persuasive against the suggested combination of Freeny with Akashi and other references in the present Section 103(a) rejections.

Examiner has considered this reference.

A Prima Facie Case Of Obviousness Under 35 U.S.C. § 103(a) Over The Cited References Has Not Been Established In The Instant Office Action

MPEP 2144 explicitly requires the presentation of a rationale found “expressly or impliedly in the prior art or drawn from a convincing line of reasoning based on established scientific principles or legal precedent” in order to combine references under Section 103. Further, MPEP 2142 states that, “[t]o reach a proper determination under 35 U.S.C. 103, the examiner must step backward in time and into the shoes worn by the hypothetical ‘person of ordinary skill in the art’ when the invention was unknown and just before it was made.” These dual requirements ensure that an examiner does not fall into the trap of using hindsight based on his own knowledge of the Applicant’s disclosure to reconstruct the claimed invention from the prior art.

To avoid such hindsight reconstruction, the CAFC requires “a rigorous application of the requirement for a showing of the teaching or motivation to combine prior art references.” *In re Beasley* 117 Fed.Appx. 739, 742 (Fed. Cir. 2004). “This is consonant with the obligation of the Board [of Patent Appeals and Interferences] to develop an evidentiary basis for its factual findings to allow for judicial review under the substantial evidence standard that is both deferential and meaningful.” *Id.* at 742-43. Neither an examiner nor the Board is entitled rely only on their own knowledge as skilled artisans. *Id.* at 743.

Applicant respectfully submits that, even assuming each and every element of Claims 1-6 has been located in the combination of Akashi and Freeny, there nonetheless has been no showing that one having ordinary skill in the art at the time of Applicant’s invention, over 17 years ago, would have found the requisite motivation and reasonable expectation of success in

combining these references.² Because a rigorous showing of teaching or motivation to combine the cited references has not been provided as required by the CAFC, a *prima facie* case of obviousness has not been established.

Applicant will demonstrate that the cited combination of references does not establish a *prima facie* case of obviousness.

Akashi discloses an automated sales system for music on record albums. Akashi teaches a recording reproducing apparatus with a built-in computer communication means which is connected by a telephone line to a host computer storing data representing music on record albums or similar information such as the composers, list of music stores, musicians and the like. The data representing music on record albums is sent from the aforesaid host computer to the recording reproducing apparatus when the host computer is accessed by the aforesaid recording reproducing apparatus. See Akashi para. 4. The recording reproducing apparatus may be either a digital audio tape recorder or a compact disk deck that employs a write-once, read-many times recordable optical disk that allows data to be read immediately after the data is written. See Akashi para. 6.

As recognized by the Examiner, Akashi discloses no means or method whatsoever of effecting payment. As also recognized by the Examiner, Akashi does not teach or suggest a hard disk used by the purchaser to store the data.

Further, as set forth in the Declaration of Kenneth Pohlmann, attached as Exhibit B, Akashi does not teach any playback capability. Akashi is a simple inexpensive digital audio tape recorder or compact disk device that has the ability to communicate with a host computer to

² The '573 Patent has a priority date of June 13, 1988. Thus, Applicant's invention was made at least as early as that date.

download music from the host computer onto an audio tape or an optical disk. It is submitted that once the music is stored on the tape or the optical disk, the tape or optical disk is then removed and carried away by the purchaser to be listened to on a completely distinct playback device separate and remote from the tape recorder or compact disk device. See Pohlmann Dec. para. 14.

The Examiner cites Freeny for the provision of video data and the element of making a payment by electronic means. Applicant submits that Freeny is non-analogous to, and plainly teaches away from, Akashi. Freeny discloses a material object offered for sale and purchasable at a point-of-sale location. As disclosed in Freeny, the information used to manufacture a material object is stored locally at the point of sale, such as a kiosk. Only the authorization to make a copy is obtained from a remote location by a communication link at the time of the sale. Freeny, col. 5, ln. 32 to col. 6, ln. 11. This is directly contrary to Akashi which teaches acquiring a recording from a remote location at the time of the sale. It is well established that, “[i]f the proposed modification or combination of the prior art would change the principle of operation of the prior art invention being modified, then the teachings of the reference are insufficient to render the claims *prima facie* obvious.” *In re Ratti*, 270 F.2d 810, 123 USPQ 349 (CCPA 1959). Thus, on this basis alone, the teachings of Freeny cannot be combined with Akashi because Freeny teaches a system that operates in a fundamentally different way than Akashi.

Moreover, Applicant submits that the rationale provided for combining selected elements of Freeny with Akashi is inadequate to make out a *prima facie* case of obviousness. As held by the CAFC in *Beasley*, “*conclusory* statements of generalized advantages and convenient *assumptions* about skilled artisans...are *inadequate* to support a finding of motivation, which is a factual question that cannot be resolved on subjective belief and unknown authority.” *Id.* at

744. (emphasis added) In the first instance, Applicant respectfully submits that the motivation asserted by the Examiner in Freeny to modify Akashi for the sale of video information is precisely the type of conclusory and generalized statements of advantage that the CAFC has determined are inadequate to show obviousness. The portion of Freeny cited by the Examiner is notably from the Background section of the patent, which states, unsurprisingly, that manufacturing facilities and distribution systems are expensive. From this general statement in Freeny, the Examiner concludes it would have been obvious to one of ordinary skill in the art at the time of Applicant's invention to modify Akashi to provide video in addition to audio information to take advantage of cost savings from eliminating manufacturing facilities and distribution systems. Applicant submits this is not the necessary motivation to combine that must be found in the prior art or knowledge of one of ordinary skill in the art, as required by *In re Vaeck*, 947 F.2d 488, 493, 20 USPQ2d 1438, 1442 (Fed. Cir. 1991). Applicant respectfully submits that, instead, this is the type of hindsight reconstruction, based on the Applicant's disclosure, that the CAFC has repeatedly held to be improper. See *Teleflex, Inc. v. KSR International Co.*, 119 Fed.Appx. 282, 285-86 (Fed. Cir. 2005) ("Combining prior art references without evidence of...a suggestion, teaching, or motivation simply takes the inventor's disclosure as a blueprint for piecing together the prior art to defeat patentability--the essence of hindsight.")

What has not been shown is some teaching in either Akashi or Freeny, or the knowledge generally available to one of ordinary skill in the art at the time of Applicant's invention, which would lead a person without knowledge of the claimed invention, to modify Akashi to provide video rather than audio information from a remote system via communication lines. Further, the

Examiner has provided no showing of the required reasonable expectation of success in thus modifying Akashi.

With respect to the teaching in Freeny of an electronic payment, the cited section of Freeny refers to a process whereby an authorization to manufacture a material object is received from a remote location. The information from which the material object is manufactured is stored locally at the point of sale. There is no suggestion in Freeny or Akashi that transmission of audio or video information from a remote location can be triggered by providing credit card account information at the point of sale. Again, no prior art or knowledge generally available to one of skill in the art has been pointed to that would lead a person of skill in the art at the time of Applicant's invention to that conclusion. Applicant therefore respectfully requests that Akashi and Freeny be withdrawn as references in the present case.

For the reasons set for the above regarding the improper combination of Akashi and Freeny, Applicant submits that a *prima facie* case of obviousness has not been established with respect to any of Claims 1-6. Rather, it appears that the references were surveyed to find individual elements that the Examiner believes correspond to the elements recited in the claims, without regard to demonstrating some rational line of reasoning as to why it would have been obvious to one of ordinary skill in the art at the time of Applicant's invention to combine the references' divergent teachings. Indeed, the Examiner has apparently overlooked teachings of the references that demonstrate their incompatibility with each other and thus militate *against* their combination.

Applicant respectfully submits this is precisely the type of hindsight reconstruction that the CAFC has proscribed. See *In re Fritch; Teleflex, supra*. To avoid hindsight reconstruction, Examiners are required to apply a rigorous "showing of the teaching or motivation to combine

prior art references.” *In re Beasley*. Applicant does not believe the Examiner has met the foregoing burden in the current case. Applicant therefore respectfully requests reconsideration and withdrawal of the rejections of Claims 1-6 under 35 U.S.C. § 103(a).

Secondary Considerations Of Non-Obviousness

In the Office Action response filed on July 21, 2005, Applicant provided evidence of secondary considerations of non-obviousness, including evidence of commercial success of distribution systems employing the claimed invention. The Examiner has indicated that he did not find the secondary evidence provided by Applicant persuasive. In support of his conclusion, the Examiner stated that “Applicant has not provided proof that the claimed features were responsible for the commercial success of the mentioned distribution systems (i.e., iTunes).” See Office Action, para. 3. The Examiner cites to *Ex parte Remark*, 15 USPQ2d 1498, 1502 for the proposition that merely showing that there was commercial success of an article which embodied the invention is not sufficient to provide a secondary consideration of non-obviousness.³

In view of Applicant’s arguments refuting the Examiner’s rejection of Claims 1-6 under 35 U.S.C. § 103(a), presented above, Applicant respectfully submits that a showing of secondary considerations is not strictly necessary to establish the non-obviousness of Applicant’s invention. However, further in view of the fact that such secondary considerations in fact do exist, Applicant feels compelled to at least set forth below a summary of such indicia.

³ Additionally, the Examiner cites to certain comments the Examiner believes were made by the Inventor during an Examiner’s Interview concerning the unavailability of content for sale via his invention. Applicant believes the Examiner misunderstood the comments made by the Inventor during the Interview and respectfully disagrees with the Examiner’s recollection of those comments. Nonetheless, in view of the additional ample evidence of secondary indicia submitted with the current response, including the Declaration of Arthur R. Hair attached hereto as Exhibit C, Applicant believes it unnecessary to pursue this issue here.

The CAFC has explicitly set forth the factors, such as commercial success, long felt but unresolved needs, skepticism by experts, and copying by competitors that can be used to establish non-obviousness. *Brown & Williamson Tobacco Corp. v. Philip Morris Inc.*, 229 F. 3d 1120, 1129 (Fed. Cir. 2000).

The CAFC has held that a nexus must be established between the merits of a claimed invention and the evidence of non-obviousness offered if that evidence is to be given substantial weight enroute to a conclusion of non-obviousness. *Remark* at 1502. The CAFC has also held, however, that copying of a patented feature or features of an invention, while other unpatented features are not copied, gives rise to an inference that there is a nexus between the patented feature and the commercial success. *Hughes Tool Company v. Dresser Industries, Inc.* 816 F.2d 1549, 1556 (Fed. Cir. 1987). Moreover, it is well established that copying of a patented invention, rather than one within the public domain, is by itself indicative of non-obviousness. See *Windsurfing International Inc., v. AMF, Inc.*, 782 F.2d 995, 1000 (Fed. Cir. 1986).

The Present Invention Has Been Copied By Others With Commercial Success

The invention recited in Claims 1-6 generally comprises transferring “for pay” digital video or digital audio signals between a first memory controlled by a seller and a second memory at a remote location controlled by a buyer over a telecommunication line. As set forth in the Declaration of Arthur R. Hair attached hereto as Exhibit C, the invention has in the past achieved significant commercial success.

Moreover, the invention continues to achieve commercial success in that it has been copied by a major participant in the field. The features of the invention generally included in Claims 1-6 have been copied by at least one commercially successful system available today: Napster Light. The Napster Light system (“Napster”) for purchasing digital music files online at

www.napster.com is a commercially successful system that embodies the features of the claimed invention. Applicant's assertion that Napster is commercially successful and has copied the claimed invention is supported by the Declaration of Justin Douglas Tygar, Ph.D., is attached to this response as Exhibit D. Dr. Tygar is a professor at the University of California, Berkley with a joint appointment in the Department of Electrical Engineering and Computer Science and the School of Information Management and Systems. See Tygar Dec., para. 1. Dr. Tygar is an expert in the field of computer science with significant experience in the field of electronic commerce. See Tygar Dec., paras. 2-4.

Dr. Tygar has determined that Napster has achieved a level of commercial success. See Tygar Dec., para. 6. Further, Dr. Tygar compared Napster to the invention recited in Claims 1-6 and determined Napster copied the invention. Specifically, Dr. Tygar found that Napster operates a music download system incorporating servers having hard disks and memory, through which it sells digital music files to a buyer for download over the internet. See Tygar Dec., para. 10. The buyer using Napster has a computer at a home, office, or other location remote from Napster. See Tygar Dec., para. 11. The buyer forms a connection between his or her computer and Napster via the Internet, selects digital music file(s) he or she wishes to purchase, provides a credit card number, and receives the music file via a download process where the file is transferred from Napster's server to the buyer's computer and stored on the hard drive. The buyer can then play the file using his or her computer system. See Tygar Dec., paras. 12-16. In view of this comparison, Dr. Tygar properly concludes that Napster has copied the features taught by the present invention. See Tygar Dec., para. 19.

Additionally, Applicant respectfully points out that Napster *does not* copy the closest prior art cited by the Examiner, i.e., Freeny and Akashi. Freeny teaches a point-of-sale device

(e.g., a kiosk) that dispenses a material object (e.g., tape) containing the music purchased. See Freeny, col. 1, line 64 to col. 2, line 12. These features of Freeny are plainly not found in Napster Light. See Tygar Dec., para. 16. Akashi teaches writing data to a digital audio tape recorder or a compact disk deck that employs a write-once, read-many-times recordable optical disk which allows data to be read immediately after the data is written. The user downloads data to a RAM and then the data is written directly from the RAM to a recordable optical disk. See Akashi para. 6. This process of Akashi is not how Napster Light operates. See Tygar Dec. para. 18.

Therefore, it is apparent that Napster chose to copy the system taught by the '573 patent. See Tygar Dec. para. 19. It is also apparent that Napster choose *not* to copy the prior art systems of Freeny and Akashi. See Tygar Dec. para. 20 and 21. Applicant submits this selective copying by Napster of the invention recited in Claims 1-6, while Napster ignored the systems of Freeny and Akashi, provides a sound basis upon which the required nexus between commercial success and Applicant's claimed invention can be found. See *Hughes Tool*, 816 F.2d at 1556. Additionally, Napster's selective copying of Applicant's invention, coupled with Napster's disregard of the Freeny and Akashi systems, is itself substantive evidence of a recognized secondary indication of non-obviousness. See *Windsurfing International Inc.*, 782 F.2d 995.

Applicant therefore respectfully submits that the foregoing remarks and the attached Declaration of Dr. Tygar have established the requisite nexus between the commercial success of Napster and Applicant's claimed invention. Applicant also respectfully submits that these remarks and the attached Declaration of Dr. Tygar similarly have established copying by Napster as a secondary indicia of non-obviousness.

Newly Added Claims Are Not Taught by the Prior Art

It is well established that, in order to establish a *prima facie* case of obviousness of a claimed invention, all limitations must be taught or suggested by the prior art. *In re Royka*, 490 F.2d 981, 180 USPQ 580 (CCPA 1974), MPEP §2143.03. The elements added via newly presented Claims 7-43 are not taught or suggested in the cited prior art, i.e., Akashi and Freeny, or in any other art cited in the related co-pending reexaminations for U.S. Patent No. 5,675,734 and U.S. Patent No. 5,966,440. The newly added claims comprise various combinations of the following limitations, as applied to both digital audio signals and digital video signals:

- a) listing/scrolling the digital signals from the second memory (Claims 7-21, 24, 28, 31, 35, 39);
- b) displaying a name of a digital signal from the second memory (Claims 9, 16, 25, 32, 36)
- c) displaying a duration of the digital signal from the second memory (Claims 10, 18, 29-34);
- d) displaying a name of an artist of the digital signal from the second memory (Claims 11, 19, 26-28, 37-39);
- e) displaying a name of an album associated with the digital signal from the second memory (Claims 12 and 20); and
- f) randomly selecting digital signals from the second memory by a second party integrated circuit of a second party control unit (Claims 13, 22-25, 33-36).

All of the limitations set forth above involve features surrounding playback from the second memory. None of these limitations are taught in Akashi or Freeny.

More specifically, limitation (a) set forth above is listing/scrolling the digital signals from the second memory. Akashi teaches a recording reproducing apparatus that either may be a digital audio tape recorder or a compact disk deck which employs a write-once, read-many times recordable optical disk. Akashi does not teach any listing/scrolling feature of a second memory. Freeny teaches using information stored locally at the point of sale (e.g., kiosk) to manufacture a material object. There is no teaching of listing/scrolling digital signals from the second memory in Freeny.

Limitations (b), (c), (d) and (e) set forth above all provide for displaying information from the second memory regarding the digital audio or digital video signal. Specifically, a name, duration, name of an artist, and name of an album are displayed. Neither Akashi nor Freeny teaches or suggests any display features concerning information in the second memory.

Limitation (f) set forth above is randomly selecting digital signals from the second memory by a second party integrated circuit of a second party control unit. Neither Akashi or Freeny teaches or suggests a second party integrated circuit of a second party control unit that allows for random selection of the digital signal. No random selection of signals by any means is taught or suggested in either reference.

As a result, in addition to being allowable for the reasons previously set forth concerning Claims 1 through 6, Applicant respectfully submits that the newly added claims are allowable for the further reason that the limitations found in the newly added claims are not taught or suggested by the prior art.

CONCLUSION

Applicant believes the foregoing remarks have overcome or rendered moot all grounds for rejection of original Claims 1-6 and any potential grounds for rejection of newly added Claims 7-43. Applicant therefore believes that all such claims are patentable over the art cited by the Examiner. There being no other rejections or objections of record, Applicant believes that the application is in condition for allowance.

Applicant understands, however, that the Examiner may have additional questions or concerns prior to allowing Applicant's claims. Applicant therefore respectfully requests that the Examiner contact Applicant's undersigned attorney directly to schedule an Interview before the Examiner takes any further action in this case.

Respectfully submitted,

DRINKER BIDDLE & REATH LLP

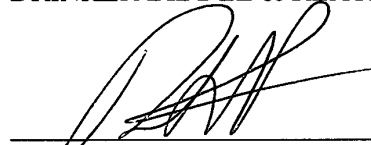

Robert A. Koons, Jr.
Registration No. 32,474

DRINKER BIDDLE & REATH LLP
One Logan Square
18th & Cherry Streets
Philadelphia, PA 19103-6996
Telephone: (215) 988-3392
Facsimile: (215) 988-2757

70181 U.S. PTO
02/06/06

CERTIFICATE UNDER 37 C.F.R. 1.10

In Re: Patent Application of Arthur R. Hair)
)
Docket No.: NAPS001)
Reexamination Control No. 90/007,402) **METHOD FOR**
Reexamination Filed: January 31, 2005) **TRANSMITTING A DESIRED**
Patent Number: 5,191,573) **DIGITAL VIDEO OR**
Examiner: Benjamin E. Lanier) **AUDIO SIGNAL**

EXPRESS MAIL – EV 547110617 US

Date of Deposit: February 6, 2006

I hereby certify that the following correspondence

Response to Notice of Defective Paper in Ex Parte Reexamination; Response; Transmittal; return postcard

is being deposited with the United States Postal Service "Express Mail Post Office to Addressee" service under 37 CFR 1.10 on the date indicated above and is addressed to Mail Stop *Ex Parte* Reexamination, Commissioner for Patents, PO Box 1450, Alexandria, VA 22313-1450.

Katherine V. Hilbert
(Typed or printed name of person mailing paper)

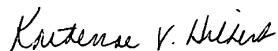
(Signature of person mailing paper or fee)

RECEIVED

7 FEB 2006

Drinker Biddle & Reath LLP
One Logan Square
18th and Cherry Streets
Philadelphia, PA 19103

**Legal Staff
International Division**

Customer No. 041068

Under the Paperwork Reduction Act of 1995, no persons are required to respond to a collection of information unless it displays a valid OMB control number.

<h1>TRANSMITTAL FORM</h1> <p><i>(to be used for all correspondence after initial filing)</i></p>	Application Number	5,191,573
	Filing Date	January 31, 2005
	First Named Inventor	Arthur R. Hair
	Art Unit	
	Examiner Name	Benjamin E. Lanier
Total Number of Pages in This Submission	Attorney Docket Number	NAPS001

ENCLOSURES <i>(Check all that apply)</i>		
<input type="checkbox"/> Fee Transmittal Form	<input type="checkbox"/> Drawing(s)	<input type="checkbox"/> After Allowance Communication to TC
<input type="checkbox"/> Fee Attached	<input type="checkbox"/> Licensing-related Papers	<input type="checkbox"/> Appeal Communication to Board of Appeals and Interferences
<input checked="" type="checkbox"/> Amendment / Reply	<input type="checkbox"/> Petition	<input type="checkbox"/> Appeal Communication to TC (Appeal Notice, Brief, Reply Brief)
<input type="checkbox"/> After Final	<input type="checkbox"/> Petition to Convert to a Provisional Application	<input type="checkbox"/> Proprietary Information
<input type="checkbox"/> Affidavits/declaration(s)	<input type="checkbox"/> Power of Attorney, Revocation Change of Correspondence Address	<input type="checkbox"/> Status Letter
<input type="checkbox"/> Extension of Time Request	<input type="checkbox"/> Terminal Disclaimer	<input checked="" type="checkbox"/> Other Enclosure(s) (please identify below):
<input type="checkbox"/> Express Abandonment Request	<input type="checkbox"/> Request for Refund	
<input type="checkbox"/> Information Disclosure Statement	<input type="checkbox"/> CD, Number of CD(s) _____	
<input type="checkbox"/> Certified Copy of Priority Document(s)	<input type="checkbox"/> Landscape Table on CD	
<input type="checkbox"/> Response to Missing Parts/ Incomplete Application	Remarks	
<input type="checkbox"/> Reply to Missing Parts under 37 CFR 1.52 or 1.53	Reexamination Control No. 90/007,402 Response to Notice of Defective Paper in Ex Parte Reexamination Response Post Card	

SIGNATURE OF APPLICANT, ATTORNEY, OR AGENT			
Firm Name	Drinker Biddle & Reath LLP		
Signature			
Printed name	Robert A. Koons, Jr.		
Date	February 6, 2006	Reg. No.	32,474

CERTIFICATE OF TRANSMISSION/MAILING			
I hereby certify that this correspondence is being facsimile transmitted to the USPTO or deposited with the United States Postal Service with sufficient postage as first class mail in an envelope addressed to: Commissioner for Patents, P.O. Box 1450, Alexandria, VA 22313-1450 on the			
Signature			
Typed or printed name		Date	

This collection of information is required by 37 CFR 1.5. The information is required to obtain or retain a benefit by the public which is to file (and by the USPTO to process) an application. Confidentiality is governed by 35 U.S.C. 122 and 37 CFR 1.11 and 1.14. This collection is estimated to 2 hours to complete, including gathering, preparing, and submitting the completed application form to the USPTO. Time will vary depending upon the individual case. Any comments on the amount of time you require to complete this form and/or suggestions for reducing this burden, should be sent to the Chief Information Officer, U.S. Patent and Trademark Office, U.S. Department of Commerce, P.O. Box 1450, Alexandria, VA 22313-1450. DO NOT SEND FEES OR COMPLETED FORMS TO THIS ADDRESS. SEND TO: Commissioner for Patents, P.O. Box 1450, Alexandria, VA 22313-1450.

If you need assistance in completing the form, call 1-800-PTO-9199 and select option 2.



UNITED STATES PATENT AND TRADEMARK OFFICE

UNITED STATES DEPARTMENT OF COMMERCE
United States Patent and Trademark Office
Address: COMMISSIONER FOR PATENTS
P.O. Box 1450
Alexandria, Virginia 22313-1450
www.uspto.gov

APPLICATION NO.	FILING DATE	FIRST NAMED INVENTOR	ATTORNEY DOCKET NO.	CONFIRMATION NO.
90/007,402	01/31/2005	5191573	NAPS001	2998

23973 7590 03/20/2006

DRINKER BIDDLE & REATH
ATTN: INTELLECTUAL PROPERTY GROUP
ONE LOGAN SQUARE
18TH AND CHERRY STREETS
PHILADELPHIA, PA 19103-6996

EXAMINER

ART UNIT PAPER NUMBER

DATE MAILED: 03/20/2006

Please find below and/or attached an Office communication concerning this application or proceeding.



UNITED STATES PATENT AND TRADEMARK OFFICE

Commissioner for Patents
United States Patent and Trademark Office
P.O. Box 1450
Alexandria, VA 22313-1450
www.uspto.gov

DO NOT USE IN PALM PRINTER

(THIRD PARTY REQUESTER'S CORRESPONDENCE ADDRESS)

Albert S. Penilla
MARTINE PENILLA & GENCARELLA, LLP
710 Lakeway Drive, Suite 200
Sunnyvale, CA 94085

EX PARTE REEXAMINATION COMMUNICATION TRANSMITTAL FORM

REEXAMINATION CONTROL NO. 90007.402

PATENT NO. 5191573

ART UNIT 2132

Enclosed is a copy of the latest communication from the United States Patent and Trademark Office in the above identified *ex parte* reexamination proceeding (37 CFR 1.550(f)).

Where this copy is supplied after the reply by requester, 37 CFR 1.535, or the time for filing a reply has passed, no submission on behalf of the *ex parte* reexamination requester will be acknowledged or considered (37 CFR 1.550(g)).

PTOL-465 (Rev.07-04)

Office Action in Ex Parte Reexamination	Control No. 90/007,402	Patent Under Reexamination 5191573	
	Examiner Benjamin E. Lanier	Art Unit 2132	

-- The MAILING DATE of this communication appears on the cover sheet with the correspondence address --

- a Responsive to the communication(s) filed on 06 February 2006. b This action is made FINAL.
c A statement under 37 CFR 1.530 has not been received from the patent owner.

A shortened statutory period for response to this action is set to expire 2 month(s) from the mailing date of this letter. Failure to respond within the period for response will result in termination of the proceeding and issuance of an *ex parte* reexamination certificate in accordance with this action. 37 CFR 1.550(d). **EXTENSIONS OF TIME ARE GOVERNED BY 37 CFR 1.550(c)**. If the period for response specified above is less than thirty (30) days, a response within the statutory minimum of thirty (30) days will be considered timely.

Part I THE FOLLOWING ATTACHMENT(S) ARE PART OF THIS ACTION:

- | | |
|---|---|
| 1. <input checked="" type="checkbox"/> Notice of References Cited by Examiner, PTO-892. | 3. <input type="checkbox"/> Interview Summary, PTO-474. |
| 2. <input type="checkbox"/> Information Disclosure Statement, PTO-1449. | 4. <input type="checkbox"/> _____. |

Part II SUMMARY OF ACTION

- 1a. Claims 1-43 are subject to reexamination.
- 1b. Claims _____ are not subject to reexamination.
2. Claims _____ have been canceled in the present reexamination proceeding.
3. Claims _____ are patentable and/or confirmed.
4. Claims 1-43 are rejected.
5. Claims _____ are objected to.
6. The drawings, filed on _____ are acceptable.
7. The proposed drawing correction, filed on _____ has been (7a) approved (7b) disapproved.
8. Acknowledgment is made of the priority claim under 35 U.S.C. § 119(a)-(d) or (f).
 - a) All b) Some* c) None of the certified copies have
 - 1 been received.
 - 2 not been received.
 - 3 been filed in Application No. _____.
 - 4 been filed in reexamination Control No. _____.
 - 5 been received by the International Bureau in PCT application No. _____.
- * See the attached detailed Office action for a list of the certified copies not received.
9. Since the proceeding appears to be in condition for issuance of an *ex parte* reexamination certificate except for formal matters, prosecution as to the merits is closed in accordance with the practice under *Ex parte* Quayle, 1935 C.D. 11, 453 O.G. 213.
10. Other: _____

cc: Requester (if third party requester)

DETAILED ACTION

Response to Amendment

1. Applicant's amendment filed 06 February 2006 adds claims 7-43. Applicant's amendment has been fully considered and is entered.

Response to Arguments

2. Applicant's arguments filed 06 February 2006 have been fully considered but they are not persuasive. In response to Applicant's arguments with respect to the Freeny reference, the District Court considered the Freeny reference, in the analysis on pages 52-53, with respect to anticipation and obviousness in view of only the teachings within the Freeny reference. Nowhere does the court decision discuss a combination of Akashi and Freeny, as applied in this reexamination proceeding, as being non-obvious.

3. The Examiner disagrees with Applicant's assessment of Akashi as a simple inexpensive digital audio tape recorder because Akashi clearly shows that the user device that communicates with the host computer is a personal computer (paragraph 4). The recording device that Applicant is referring to is a device/module of the personal computer; much the same as a hard drive or a CD-ROM drive is a device/module of a personal computer.

4. In response to applicant's argument that Freeny is nonanalogous art, it has been held that a prior art reference must either be in the field of applicant's endeavor or, if not, then be reasonably pertinent to the particular problem with which the applicant was concerned, in order to be relied upon as a basis for rejection of the claimed invention. See *In re Oetiker*, 977 F.2d 1443, 24 USPQ2d 1443 (Fed. Cir. 1992). In this case, Akashi and Freeny both deal with

music purchasing over telecommunication lines that enable users access to requested music (See Akashi page 1 and Freeny Col. 5, line 1 – Col. 6, line 23 & Col. 13, lines 27-31).

5. Applicant argues that the proposed modification of Akashi, in view of Freeny, would change the principle operation of the Akashi is not persuasive because the test for obviousness is not whether the features of a secondary reference may be bodily incorporated into the structure of the primary reference; nor is it that the claimed invention must be expressly suggested in any one or all of the references. Rather, the test is what the combined teachings of the references would have suggested to those of ordinary skill in the art. See *In re Keller*, 642 F.2d 413, 208 USPQ 871 (CCPA 1981). The proposed modification to the automated purchasing component of Akashi, which isn't even described in the Akashi reference, would not change the principle operation of the Akashi reference. Akashi discloses that the digital music data is purchased automatically but does not expressly detail how the purchase is transacted. Freeny discloses a method of electronically distributing and selling audio and video data by way of having the requesting user transmit a consumer credit card number along with their request for the audio and video data (Col. 13, lines 25-29). This step allows the owner of the data to approve the sale and charge the sale to the consumer credit card number (Col. 13, lines 30-31). It would have been obvious to one of ordinary skill in the art at the time the invention was made to have the requesting user's of Akashi transmit a consumer credit card number along with their request for the digital data so that the source unit could approve and charge the sale of the digital data to the consumer credit card because this method of electronic sale allows the owner of the information to receive directly the compensation for sale of recording and such compensation is received before the reproduction is authorized as taught in Freeny (Col. 13, lines 36-39). The subsequent

Art Unit: 2132

transmission of data in Akashi has not been modified, and therefore, suggesting that the modification of the purchasing component of Akashi would change the principle operation of Akashi is simply not true.

6. Applicant's argument that the motivation for the proposed modification of the purchasing component of Akashi with the electronic sales procedure of Freeny is not persuasive because the motivation is not a conclusory statement but instead is teaching directly from the Freeny reference. See motivation below:

It would have been obvious to one of ordinary skill in the art at the time the invention was made to have the requesting user's of Akashi transmit a consumer credit card number along with their request for the digital data so that the source unit could approve and charge the sale of the digital data to the consumer credit card because this method of electronic sale allows the owner of the information to receive directly the compensation for sale of recording and such compensation is received before the reproduction is authorized as taught in Freeny (Col. 13, lines 36-39).

This teaching in Freeny would lead one of ordinary skill in the art at the time the invention was made to perform an electronic sale using credit card information so that the seller could receive direct compensation.

7. In response to Applicant's argument that no showing of a reasonable expectation of success has been made, the incorporation of the electronic payment steps of Freeny into the automated purchasing system of Akashi allow for a seller to receive direct compensation for the data that the automated purchasing system of Akashi allows to be sold.

8. Applicant's argument that the combination of Akashi and Freeny do not suggest that transmission of audio or video information from a remote location can be triggered by providing credit card account information is not persuasive because taking into account the above-mentioned modification of Akashi using the electronic payment steps of Freeny, the user's request for the data from the host computer of Akashi would be accompanied with the user's credit card information. At the remote cite, access to the data would be allowed once the credit card information is authorized (See Freeny Col. 13, lines 27-39). In Akashi the access provided to the user is done through telecommunication lines (i.e. data being transmitted from the host computer to the user's personal computer over telecommunication lines)(See Akashi Page 1 through line 1 of Page 2 & Page 4 paragraph 1).

9. All of the Applicant's arguments with the respect to the 103 rejections represent attacks on the references individually where the rejections are based on combinations of references and they represent allegations that various features of the secondary references cannot be bodily incorporated into the structure of the primary reference. These arguments cannot be relied upon to show nonobviousness. See *In re Keller*, 642 F.2d 413, 208 USPQ 871 (CCPA 1981); *In re Merck & Co.*, 800 F.2d 1091, 231 USPQ 375 (Fed. Cir. 1986).

10. Therefore, the cited prior art references were considered as a whole when making the claim rejections and would have suggested to those of ordinary skill in the art the above-mentioned combinations.

11. Applicant's arguments with respect to commercial success are not persuasive because commercial success may have been attributable to extensive advertising and position as a market leader before the introduction of the patented product, *Pentec, Inc. v. Graphic Controls Corp.*,

776 F.2d 309, 227 USPQ 766 (Fed. Cir. 1985). The Napster name gained worldwide notoriety in the late 1990's because of their software which allowed users to illegally download music. At its height, Napster had 70 million unique users who were estimated to have traded over 3 billion files a month (See Wired News "Napster is Alive, Alive", Page 3). This would have given Napster's legitimate online music store a starting base of 70 million users who were familiar with Napster products prior to their online music store's launch. Therefore, Applicant has failed to show that the commercial success of the Napster Light software is due to the alleged use of Applicant's claimed invention instead of being a direct result of Napster's prominent name with respect to music downloading.

12. Success of invention could be due to recent changes in related technology or consumer demand, *In re Fielder*, 471 F.2d 690, 176 USPQ 300 (CCPA 1973). The existence and profitability of the systems mentioned by Applicant are due to the advances in recent technology and not Applicant's claimed invention. If the latter was responsible for the success, then it stands to reason that the existence of a profitable system would have occurred earlier since Applicant's first application directed to the claimed subject matter was filed in June of 1988. At the time of Napster Light's ("Napster") launch, personal computer storage capacities were significantly larger than they were at the time of the prior art systems. Hard drives routinely come in capacities of 20 gigabytes or higher, whereas in 1988 the capacity was around 40 megabytes. Not to mention the fact that when Napster was launched, audio file compression was advanced to the point where a file could be compressed to a third of the size with little observable quality loss. Add to that the proliferation of broadband Internet that simply did not exist at the time of prior art systems and what you have is the ability to store a significantly larger amount of music

Art Unit: 2132

because of file size and storage capacity, and the ability to acquire this music much faster.

Therefore, Applicant cannot attribute the commercial success of Napster's system to the alleged use of their claimed invention when there is no reason to suggest that any of the prior art distribution system would not have been just as successful given these same advances in technology.

13. Applicant's arguments with respect to the newly added claims and the Akashi and Freeny references have been persuasive, however, upon search and consideration of the newly added claims, grounds of rejection are made in view of the previously cited Akashi and Freeny references and in further view of Stokes and Kimura. Applicant's amendment necessitated the new ground(s) of rejection presented in this Office action. Accordingly, **THIS ACTION IS MADE FINAL.**

Claim Rejections - 35 USC § 103

14. The following is a quotation of 35 U.S.C. 103(a) which forms the basis for all obviousness rejections set forth in this Office action:

(a) A patent may not be obtained though the invention is not identically disclosed or described as set forth in section 102 of this title, if the differences between the subject matter sought to be patented and the prior art are such that the subject matter as a whole would have been obvious at the time the invention was made to a person having ordinary skill in the art to which said subject matter pertains. Patentability shall not be negated by the manner in which the invention was made.

15. The factual inquiries set forth in *Graham v. John Deere Co.*, 383 U.S. 1, 148 USPQ 459 (1966), that are applied for establishing a background for determining obviousness under 35 U.S.C. 103(a) are summarized as follows:

1. Determining the scope and contents of the prior art.
2. Ascertaining the differences between the prior art and the claims at issue.
3. Resolving the level of ordinary skill in the pertinent art.
4. Considering objective evidence present in the application indicating obviousness or nonobviousness.

16. Claims 1-6 are rejected under 35 U.S.C. 103(a) as being unpatentable over Akashi, "Automated Music Purchasing System", in view of Freeny, U.S. Patent No. 4,528,643. Referring to claims 1, 3, 4, 6, Akashi discloses a system for automatically selling recorded music via telecommunication lines (Page 1 through line 1 of Page 2). This system utilizes the telecommunications lines to transmit the recorded music data from a host computer that stores the recorded music data to a personal computer (Page 2 Section 4), which meets the limitation of connecting electronically via telecommunications line the first memory with the second memory such that the desired digital audio signal can pass therebetween, transmitting the desired digital audio signal from the first memory with a transmitter in control and possession of the first party to a receiver having the second memory at a location determined by the second party, said receiver in possession and control of the second party, storing the digital signal in the second memory. Akashi discloses that the digital music data is purchased automatically but does not expressly detail how the purchase is transacted. Freeny discloses a method of electronically distributing and selling audio and video data by way of having the requesting user transmit a consumer credit card number along with their request for the audio and video data (Col. 13, lines 25-29). This step allows the owner of the data to approve the sale and charge the sale to the consumer credit card number (Col. 13, lines 30-31), which meets the limitation of transferring money electronically via a telecommunications lines to the first party at a location remote from the second memory and controlling use of the first memory from the second party financially distinct from the first party, said second party controlling use and in possession of the second memory, the transferring step includes the steps of telephoning the first party controlling use of the first memory by the second party, providing a credit card number of the second party

controlling the second memory to the first party controlling the first memory so the second party is charged money. It would have been obvious to one of ordinary skill in the art at the time the invention was made to have the requesting user's of Akashi transmit a consumer credit card number along with their request for the digital data so that the source unit could approve and charge the sale of the digital data to the consumer credit card because this method of electronic sale allows the owner of the information to receive directly the compensation for sale of recording and such compensation is received before the reproduction is authorized as taught in Freeny (Col. 13, lines 36-39).

Referring to claims 2, 5, Akashi discloses that personal computer contains a CPU (Figure 1). The personal computer sends an access signal to the host computer, and the host computer returns a response signal that contains menu data displayed at the personal computer (Page 3 Paragraph 6). Using the monitor screen, the user chooses desired data using a control unit and sending the selection data to the host computer in the same way the initial transmission was sent (Page 4 Paragraph 1), which meets the limitation of the steps of searching the first memory for the desired digital audio signal and selecting the desired digital audio signal from the first memory.

17. Claims 7-12, 14-20, 26-32, 37-43 are rejected under 35 U.S.C. 103(a) as being unpatentable over Akashi, "Automated Music Purchasing System", in view of Freeny, U.S. Patent No. 4,528,643, and further in view of Stokes, U.S. Patent No. 4,870,515. Referring to claims 7, 8, Akashi discloses a system for automatically selling recorded music via telecommunication lines (Page 1 through line 1 of Page 2 & Page 3, lines 3-5). This system utilizes the telecommunications lines to transmit the recorded music data from a host computer

Art Unit: 2132

that stores the recorded music data to a personal computer (Page 2 Section 4), which meets the limitation of connecting electronically via telecommunications line the first memory with the second memory such that the desired digital audio signal can pass therebetween, transmitting the desired digital audio signal from the first memory with a transmitter in control and possession of the first party to a receiver having the second memory at a location determined by the second party, said receiver in possession and control of the second party, storing the digital audio signal in the second memory. Akashi discloses that the digital music data is purchased automatically but does not expressly detail how the purchase is transacted. Freeny discloses a method of electronically distributing and selling audio and video data by way of having the requesting user transmit a consumer credit card number along with their request for the audio and video data (Col. 13, lines 25-29). This step allows the owner of the data to approve the sale and charge the sale to the consumer credit card number (Col. 13, lines 30-31), which meets the limitation of transferring money electronically via a telecommunications lines to the first party at a location remote from the second memory and controlling use of the first memory from the second party financially distinct from the first party, said second party controlling use and in possession of the second memory, the transferring step includes the steps of telephoning the first party controlling use of the first memory from the second party, providing a credit card number of the second party controlling the second memory to the first party controlling the first memory so the second party is charged money. It would have been obvious to one of ordinary skill in the art at the time the invention was made to have the requesting user's of Akashi transmit a consumer credit card number along with their request for the digital data so that the source unit could approve and charge the sale of the digital data to the consumer credit card because this method of electronic

sale allows the owner of the information to receive directly the compensation for sale of recording and such compensation is received before the reproduction is authorized as taught in Freeny (Col. 13, lines 36-39). Akashi discloses that the music data is immediately readable after it has been downloaded to the user computer and stored on the storage medium (Page 2, "Operation" section through Page 3, line 1), but does not disclose how the stored music data is read. Stokes discloses a music memory data recording, storage and playback system wherein a computer data terminal (Figure 2, element 42), which has input devices and a monitor (Figure 2), is used along with storage devices and speakers to access storage audio data (Col. 5, lines 11-48). The audio data is stored such that it can be displayed to the user (Col. 2, lines 30-38) on the user's computer data terminal (Col. 5, lines 44-48), which meets the limitation of listing/scrolling digital audio signals from the second memory. For the purposes of examination "listing/scrolling" will be treated as its grammatical equivalent, which is "listing or scrolling". The cited portions of Stokes are meant to read on listing, however, Stokes also includes several teaches of scrolling capabilities to enable selection of audio data (Col. 6, lines 17-18 & Col. 8, lines 57-62). It would have been obvious to one of ordinary skill in the art at the time the invention was made to provide access/playback system of Stokes in the user personal computer of Akashi in order for the user of the personal computer of Akashi to be choose which musical selections are to be played, and in what order as taught in Stokes (Col. 1, lines 56-59).

Referring to claims 14, 15, 37-43, Akashi discloses a system for automatically selling recorded music via telecommunication lines (Page 1 through line 1 of Page 2 & Page 3, lines 3-5). This system utilizes the telecommunications lines to transmit the recorded music data from a host computer that stores the recorded music data to a personal computer (Page 2 Section 4),

Art Unit: 2132

which meets the limitation of connecting electronically via telecommunications line the first memory with the second memory such that the desired digital audio signal can pass therebetween, transmitting the desired digital audio signal from the first memory with a transmitter in control and possession of the first party to a receiver having the second memory at a location determined by the second party, said receiver in possession and control of the second party, storing the digital audio signal in the second memory. Akashi does not disclose that the digital data is video data. Freeny discloses a method of electronically distributing and selling audio and video data by way of having the requesting user transmit a consumer credit card number along with their request for the audio and video data (Col. 13, lines 25-29). It would have been obvious to one of ordinary skill in the art at the time the invention was made to distribute video data using the system of Akashi because distributors of video data would benefit from the cost reduction that would occur when eliminating manufacturing facilities for reproducing the information in material objects and a distribution network for distributing the material objects to the various points of sale locations for sale to the consumer as taught in Freeny (Col. 1, lines 10-26). Akashi discloses that the digital music data is purchased automatically but does not expressly detail how the purchase is transacted. Freeny discloses a method of electronically distributing and selling audio and video data by way of having the requesting user transmit a consumer credit card number along with their request for the audio and video data (Col. 13, lines 25-29). This step allows the owner of the data to approve the sale and charge the sale to the consumer credit card number (Col. 13, lines 30-31), which meets the limitation of transferring money electronically via a telecommunications lines to the first party at a location remote from the second memory and controlling use of the first memory from the

second party financially distinct from the first party, said second party controlling use and in possession of the second memory, the transferring step includes the steps of telephoning the first party controlling use of the first memory by the second party, providing a credit card number of the second party controlling the second memory to the first party controlling the first memory so the second party is charged money. It would have been obvious to one of ordinary skill in the art at the time the invention was made to have the requesting user's of Akashi transmit a consumer credit card number along with their request for the digital data so that the source unit could approve and charge the sale of the digital data to the consumer credit card because this method of electronic sale allows the owner of the information to receive directly the compensation for sale of recording and such compensation is received before the reproduction is authorized as taught in Freeny (Col. 13, lines 36-39). Akashi discloses that the music data is immediately readable after it has been downloaded to the user computer and stored on the storage medium (Page 2, "Operation" section through Page 3, line 1), but does not disclose how the stored music data is read. Stokes discloses a music memory data recording, storage and playback system wherein a computer data terminal (Figure 2, element 42), which has input devices and a monitor (Figure 2), is used along with storage devices and speakers to access storage audio data (Col. 5, lines 11-48). The audio data is stored such that it can be displayed to the user (Col. 2, lines 30-38) on the user's computer data terminal (Col. 5, lines 44-48), which meets the limitation of listing/scrolling digital audio signals from the second memory. For the purposes of examination "listing/scrolling" will be treated as its grammatical equivalent, which is "listing or scrolling". The cited portions of Stokes are meant to read on listing, however, Stokes also includes several teaches of scrolling capabilities to enable selection of audio data (Col. 6, lines 17-18 & Col. 8,

lines 57-62). Stokes discloses that when the audio data is stored in the system, it is stored with information that includes the artists name, title, album, playing time, track (song), and location of the audio data (Col. 1, lines 8-14 & Col. 2, lines 27-20). This information is displayed when the list of audio data is presented to the user for selection (Col. 2, lines 30-38 & Col. 4, line 65 – Col. 5, line 10, 44-48), which meets the limitation of displaying a duration, and a name of an artist of the digital signal from the second memory. It would have been obvious to one of ordinary skill in the art at the time the invention was made to provide access/playback system of Stokes in the user personal computer of Akashi in order for the user of the personal computer of Akashi to be choose which musical selections are to be played, and in what order as taught in Stokes (Col. 1, lines 56-59).

Referring to claims 26-32, Akashi discloses a system for automatically selling recorded music via telecommunication lines (Page 1 through line 1 of Page 2 & Page 3, lines 3-5). This system utilizes the telecommunications lines to transmit the recorded music data from a host computer that stores the recorded music data to a personal computer (Page 2 Section 4), which meets the limitation of connecting electronically via telecommunications line the first memory with the second memory such that the desired digital audio signal can pass therebetween, transmitting the desired digital audio signal from the first memory with a transmitter in control and possession of the first party to a receiver having the second memory at a location determined by the second party, said receiver in possession and control of the second party, storing the digital audio signal in the second memory. Akashi discloses that the digital music data is purchased automatically but does not expressly detail how the purchase is transacted. Freeny discloses a method of electronically distributing and selling audio and video data by way of

having the requesting user transmit a consumer credit card number along with their request for the audio and video data (Col. 13, lines 25-29). This step allows the owner of the data to approve the sale and charge the sale to the consumer credit card number (Col. 13, lines 30-31), which meets the limitation of transferring money electronically via a telecommunications lines to the first party at a location remote from the second memory and controlling use of the first memory from the second party financially distinct from the first party, said second party controlling use and in possession of the second memory, the transferring step includes the steps of telephoning the first party controlling use of the first memory by the second party, providing a credit card number of the second party controlling the second memory to the first party controlling the first memory so the second party is charged money. It would have been obvious to one of ordinary skill in the art at the time the invention was made to have the requesting user's of Akashi transmit a consumer credit card number along with their request for the digital data so that the source unit could approve and charge the sale of the digital data to the consumer credit card because this method of electronic sale allows the owner of the information to receive directly the compensation for sale of recording and such compensation is received before the reproduction is authorized as taught in Freeny (Col. 13, lines 36-39). Akashi discloses that the music data is immediately readable after it has been downloaded to the user computer and stored on the storage medium (Page 2, "Operation" section through Page 3, line 1), but does not disclose how the stored music data is read. Stokes discloses a music memory data recording, storage and playback system wherein a computer data terminal (Figure 2, element 42), which has input devices and a monitor (Figure 2), is used along with storage devices and speakers to access storage audio data (Col. 5, lines 11-48). The audio data is stored such that it can be displayed to

Art Unit: 2132

the user (Col. 2, lines 30-38) on the user's computer data terminal (Col. 5, lines 44-48), which meets the limitation of listing/scrolling digital audio signals from the second memory. For the purposes of examination "listing/scrolling" will be treated as its grammatical equivalent, which is "listing or scrolling". The cited portions of Stokes are meant to read on listing, however, Stokes also includes several teaches of scrolling capabilities to enable selection of audio data (Col. 6, lines 17-18 & Col. 8, lines 57-62). Stokes discloses that when the audio data is stored in the system, it is stored with information that includes the artists name, title, album, playing time, track (song), and location of the audio data (Col. 1, lines 8-14 & Col. 2, lines 27-20). This information is displayed when the list of audio data is presented to the user for selection (Col. 2, lines 30-38 & Col. 4, line 65 – Col. 5, line 10, 44-48), which meets the limitation of displaying a name of an artist, a duration, and a name of the digital audio signal from the second memory. It would have been obvious to one of ordinary skill in the art at the time the invention was made to provide access/playback system of Stokes in the user personal computer of Akashi in order for the user of the personal computer of Akashi to be choose which musical selections are to be played, and in what order as taught in Stokes (Col. 1, lines 56-59).

Referring to claims 9-12, 16-20, Stokes discloses that when the audio data is stored in the system, it is stored with information that includes the artists name, title, album, playing time, track (song), and location of the audio data (Col. 1, lines 8-14 & Col. 2, lines 27-20). This information is displayed when the list of audio data is presented to the user for selection (Col. 2, lines 30-38 & Col. 4, line 65 – Col. 5, line 10, 44-48), which meets the limitation of displaying a name, duration, name of an artist, and name of an album associated with the digital audio signal from the second memory. It would have been obvious to one of ordinary skill in the art at the

Art Unit: 2132

time the invention was made to provide access/playback system of Stokes in the user personal computer of Akashi in order for the user of the personal computer of Akashi to be choose which musical selections are to be played, and in what order as taught in Stokes (Col. 1, lines 56-59).

18. Claims 13, 21 are rejected under 35 U.S.C. 103(a) as being unpatentable over Akashi, "Automated Music Purchasing System", in view of Freeny, U.S. Patent No. 4,528,643, and further in view of Stokes, U.S. Patent No. 4,870,515 as applied to claims 7, 14 above, and further in view of Kimura, U.S. Patent No. 4,855,979. Referring to claim 13, 21, Akashi discloses that the music data is immediately readable after it has been downloaded to the user computer and stored on the storage medium (Page 2, "Operation" section through Page 3, line 1), but does not disclose how the stored music data is read. Stokes discloses a music memory data recording, storage and playback system wherein a computer data terminal (Figure 2, element 42), which has input devices and a monitor (Figure 2), is used along with storage devices and speakers to access storage audio data (Col. 5, lines 11-48). The audio data is stored such that it can be displayed to the user (Col. 2, lines 30-38) on the user's computer data terminal (Col. 5, lines 44-48). Stokes does not disclose that audio data can be played back randomly. Kimura discloses a playback method for digital audio wherein the playback device sorts the audio files and plays them back randomly (Col. 1, lines 31-58). It would have been obvious to one of ordinary skill in the art at the time the invention was made to sort the retrieved digital audio and play the files back randomly in order to avoid repeating the same file with respect to the number of files in the collection as taught in Kimura (Col. 2, lines 53-58).

19. Claims 22, 23, 33, 34 are rejected under 35 U.S.C. 103(a) as being unpatentable over Akashi, "Automated Music Purchasing System", in view of Freeny, U.S. Patent No. 4,528,643,

Art Unit: 2132

in view of Kimura, U.S. Patent No. 4,855,979. Referring to claims 22, 23, Akashi discloses a system for automatically selling recorded music via telecommunication lines (Page 1 through line 1 of Page 2 & Page 3, lines 3-5). This system utilizes the telecommunications lines to transmit the recorded music data from a host computer that stores the recorded music data to a personal computer (Page 2 Section 4), which meets the limitation of connecting electronically via telecommunications line the first memory with the second memory such that the desired digital audio signal can pass therebetween, transmitting the desired digital audio signal from the first memory with a transmitter in control and possession of the first party to a receiver having the second memory at a location determined by the second party, said receiver in possession and control of the second party, storing the digital audio signal in the second memory. Akashi discloses that the digital music data is purchased automatically but does not expressly detail how the purchase is transacted. Freeny discloses a method of electronically distributing and selling audio and video data by way of having the requesting user transmit a consumer credit card number along with their request for the audio and video data (Col. 13, lines 25-29). This step allows the owner of the data to approve the sale and charge the sale to the consumer credit card number (Col. 13, lines 30-31), which meets the limitation of transferring money electronically via a telecommunications lines to the first party at a location remote from the second memory and controlling use of the first memory from the second party financially distinct from the first party, said second party controlling use and in possession of the second memory, the transferring step includes the steps of telephoning the first party controlling use of the first memory by the second party, providing a credit card number of the second party controlling the second memory to the first party controlling the first memory so the second party is charged money. It would

Art Unit: 2132

have been obvious to one of ordinary skill in the art at the time the invention was made to have the requesting user's of Akashi transmit a consumer credit card number along with their request for the digital data so that the source unit could approve and charge the sale of the digital data to the consumer credit card because this method of electronic sale allows the owner of the information to receive directly the compensation for sale of recording and such compensation is received before the reproduction is authorized as taught in Freeny (Col. 13, lines 36-39).

Referring to claims 33, 34, Akashi discloses a system for automatically selling recorded music via telecommunication lines (Page 1 through line 1 of Page 2 & Page 3, lines 3-5). This system utilizes the telecommunications lines to transmit the recorded music data from a host computer that stores the recorded music data to a personal computer (Page 2 Section 4), which meets the limitation of connecting electronically via telecommunications line the first memory with the second memory such that the desired digital audio signal can pass therebetween, transmitting the desired digital audio signal from the first memory with a transmitter in control and possession of the first party to a receiver having the second memory at a location determined by the second party, said receiver in possession and control of the second party, storing the digital audio signal in the second memory. Akashi does not disclose that the digital data is video data. Freeny discloses a method of electronically distributing and selling audio and video data by way of having the requesting user transmit a consumer credit card number along with their request for the audio and video data (Col. 13, lines 25-29). It would have been obvious to one of ordinary skill in the art at the time the invention was made to distribute video data using the system of Akashi because distributors of video data would benefit from the cost reduction that would occur when eliminating manufacturing facilities for reproducing the information in

Art Unit: 2132

material objects and a distribution network for distributing the material objects to the various points of sale locations for sale to the consumer as taught in Freeny (Col. 1, lines 10-26). Akashi discloses that the digital music data is purchased automatically but does not expressly detail how the purchase is transacted. Freeny discloses a method of electronically distributing and selling audio and video data by way of having the requesting user transmit a consumer credit card number along with their request for the audio and video data (Col. 13, lines 25-29). This step allows the owner of the data to approve the sale and charge the sale to the consumer credit card number (Col. 13, lines 30-31), which meets the limitation of transferring money electronically via a telecommunications lines to the first party at a location remote from the second memory and controlling use of the first memory from the second party financially distinct from the first party, said second party controlling use and in possession of the second memory, the transferring step includes the steps of telephoning the first party controlling use of the first memory by the second party, providing a credit card number of the second party controlling the second memory to the first party controlling the first memory so the second party is charged money. It would have been obvious to one of ordinary skill in the art at the time the invention was made to have the requesting user's of Akashi transmit a consumer credit card number along with their request for the digital data so that the source unit could approve and charge the sale of the digital data to the consumer credit card because this method of electronic sale allows the owner of the information to receive directly the compensation for sale of recording and such compensation is received before the reproduction is authorized as taught in Freeny (Col. 13, lines 36-39).

20. Claims 24, 25, 35, 36 are rejected under 35 U.S.C. 103(a) as being unpatentable over Akashi, "Automated Music Purchasing System", in view of Freeny, U.S. Patent No. 4,528,643,

Art Unit: 2132

in view of Kimura, U.S. Patent No. 4,855,979 as applied to claims 22, 33 above, and further in view of Stokes, U.S. Patent No. 4,870,515. Referring to claims 24, 25, 35, 36, Akashi discloses that the music data is immediately readable after it has been downloaded to the user computer and stored on the storage medium (Page 2, "Operation" section through Page 3, line 1), but does not disclose how the stored music data is read. Stokes discloses a music memory data recording, storage and playback system wherein a computer data terminal (Figure 2, element 42), which has input devices and a monitor (Figure 2), is used along with storage devices and speakers to access storage audio data (Col. 5, lines 11-48). The audio data is stored such that it can be displayed to the user (Col. 2, lines 30-38) on the user's computer data terminal (Col. 5, lines 44-48), which meets the limitation of listing/scrolling digital audio signals from the second memory. For the purposes of examination "listing/scrolling" will be treated as its grammatical equivalent, which is "listing or scrolling". The cited portions of Stokes are meant to read on listing, however, Stokes also includes several teaches of scrolling capabilities to enable selection of audio data (Col. 6, lines 17-18 & Col. 8, lines 57-62). Stokes discloses that when the audio data is stored in the system, it is stored with information that includes the artists name, title, album, playing time, track (song), and location of the audio data (Col. 1, lines 8-14 & Col. 2, lines 27-20). This information is displayed when the list of audio data is presented to the user for selection (Col. 2, lines 30-38 & Col. 4, line 65 – Col. 5, line 10, 44-48), which meets the limitation of displaying a name of a digital signal from the second memory. It would have been obvious to one of ordinary skill in the art at the time the invention was made to provide access/playback system of Stokes in the user personal computer of Akashi in order for the user of the personal computer of Akashi to

be choose which musical selections are to be played, and in what order as taught in Stokes (Col. 1, lines 56-59).

Conclusion

21. Patent owner's amendment filed 06 February 2006 necessitated the new grounds of rejection presented in this Office action. Accordingly, **THIS ACTION IS MADE FINAL**. See MPEP § 706.07(a).

A shortened statutory period for response to this action is set to expire **two months** from the mailing date of this action.

Extensions of time under 37 CFR 1.136(a) do not apply in reexamination proceedings. The provisions of 37 CFR 1.136 apply only to "an applicant" and not to parties in a reexamination proceeding. Further, in 35 U.S.C. 305 and in 37 CFR 1.550(a), it is required that reexamination proceedings "will be conducted with special dispatch within the Office."

Extensions of time in reexamination proceedings are provided for in 37 CFR 1.550(c). A request for extension of time must be filed on or before the day on which a response to this action is due, and it must be accompanied by the petition fee set forth in 37 CFR 1.17(g). The mere filing of a request will not effect any extension of time. An extension of time will be granted only for sufficient cause, and for a reasonable time specified.

The filing of a timely first response to this final rejection will be construed as including a request to extend the shortened statutory period for an additional month, which will be granted even if previous extensions have been granted. In no event, however, will the statutory period for response expire later than **SIX MONTHS** from the mailing date of the final action. See MPEP § 2265.

22. The patent owner is reminded of the continuing responsibility under 37 CFR 1.565(a) to apprise the Office of any litigation activity, or other prior or concurrent proceeding, involving Patent No. 5,191,573 throughout the course of this reexamination proceeding. The third party requester is also reminded of the ability to similarly apprise the Office of any such activity or proceeding throughout the course of this reexamination proceeding. See MPEP §§ 2207, 2282 and 2286.

23. Any inquiry concerning this communication or earlier communications from the examiner should be directed to Benjamin E. Lanier whose telephone number is 571-272-3805. The examiner can normally be reached on M-Th 7:30am-5:00pm, F 7:30am-4pm.

If attempts to reach the examiner by telephone are unsuccessful, the examiner's supervisor, Gilberto Barron can be reached on 571-272-3799. The fax phone number for the organization where this application or proceeding is assigned is 571-273-8300.

Information regarding the status of an application may be obtained from the Patent Application Information Retrieval (PAIR) system. Status information for published applications may be obtained from either Private PAIR or Public PAIR. Status information for unpublished applications is available through Private PAIR only. For more information about the PAIR system, see <http://pair-direct.uspto.gov>. Should you have questions on access to the Private PAIR system, contact the Electronic Business Center (EBC) at 866-217-9197 (toll-free).

Benjamin E. Lanier

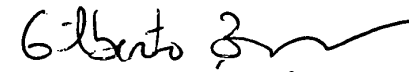
GILBERTO BARRON JR.
SUPERVISORY PATENT EXAMINER
TECHNOLOGY CENTER 2100

Klu
Patentability
Conference
Kim Vu
Gilberto Barron

PINCHUS M. LAUFER, PH.D., J.P.
SPECIAL PROGRAM EXAMINER
TECHNOLOGY CENTER 2100

PROCEDURAL MATTERS
only

Notice of References Cited	Application/Control No. 90/007,402	Applicant(s)/Patent Under Reexamination 5191573	
	Examiner Benjamin E. Lanier	Art Unit 2132	Page 1 of 1

U.S. PATENT DOCUMENTS

*	Document Number Country Code-Number-Kind Code	Date MM-YYYY	Name	Classification
*	A US-4,870,515	09-1989	Stokes, Richard A.	360/72.2
*	B US-4,855,979	08-1989	Kimura et al.	369/98
	C US-			
	D US-			
	E US-			
	F US-			
	G US-			
	H US-			
	I US-			
	J US-			
	K US-			
	L US-			
	M US-			

FOREIGN PATENT DOCUMENTS

*	Document Number Country Code-Number-Kind Code	Date MM-YYYY	Country	Name	Classification
	N				
	O				
	P				
	Q				
	R				
	S				
	T				

NON-PATENT DOCUMENTS

*	Include as applicable: Author, Title Date, Publisher, Edition or Volume, Pertinent Pages)
	U
	V
	W
	X

*A copy of this reference is not being furnished with this Office action. (See MPEP § 707.05(a).)
Dates in MM-YYYY format are publication dates. Classifications may be US or foreign.

Litigation Search Report CRU 3999

Reexam Control No 90/007,402

TO: Mark Reinhart
Location: CRU
Art Unit : 3992
Date: 04/15/06

From: James R. Matthews
Location: CRU 3999
RND 1C79
Phone: (571) 272-4233

Case Serial Number: 90/007,402 **JamesR.Matthews@uspto.gov**

Search Notes

U.S. Patent No- 5,191,573

- 1) I performed a KeyCite Search in Westlaw, which retrieves all history on the patent including any litigation.
- 2) I performed a search on the patent in Lexis CourtLink for any open dockets or closed cases.
- 3) I performed a search in Lexis in the Federal Courts and Administrative Materials databases for any cases found.
- 4) I performed a search in Lexis in the IP Journal and Periodicals database for any articles on the patent.
- 5) I performed a search in Lexis in the news databases for any articles about the patent or any articles about litigation on this patent.

Litigation was found



Date of Printing: APR 13,2006

KEYCITE**HUS PAT 5191573 METHOD FOR TRANSMITTING A DESIRED DIGITAL VIDEO OR AUDIO SIGNAL, (Mar 02, 1993)****History
Direct History**

- => 1 **METHOD FOR TRANSMITTING A DESIRED DIGITAL VIDEO OR AUDIO SIGNAL**, US PAT 5191573, 1993 WL 1138260 (U.S. PTO Utility Mar 02, 1993) (NO. 586391)
Construed by
- H** 2 SightSound.Com Inc. v. N2K, Inc., 185 F.Supp.2d 445 (W.D.Pa. Feb 08, 2002) (NO. CIV.A.98-CV-118)
- H** 3 SYSTEM FOR TRANSMITTING DESIRED DIGITAL VIDEO OR AUDIO SIGNALS, US PAT 5675734, 1997 WL 1488819 (U.S. PTO Utility Oct 07, 1997) (NO. 607648)
Construed by
- H** 4 SightSound.Com Inc. v. N2K, Inc., 185 F.Supp.2d 445 (W.D.Pa. Feb 08, 2002) (NO. CIV.A.98-CV-118)
- H** 5 SYSTEM AND METHOD FOR TRANSMITTING DESIRED DIGITAL VIDEO OR DIGITAL AUDIO SIGNALS, US PAT 5966440, 1999 WL 1731614 (U.S. PTO Utility Oct 12, 1999) (NO. 471964)
Construed by
- H** 6 SightSound.Com Inc. v. N2K, Inc., 185 F.Supp.2d 445 (W.D.Pa. Feb 08, 2002) (NO. CIV.A.98-CV-118)
- Related References (U.S.A.)**
- H** 7 Sightsound.com Inc. v. N2K, Inc., 391 F.Supp.2d 321 (W.D.Pa. Oct 24, 2003) (NO. CIV.A. 98-CV-118)

**Court Documents
Trial Court Documents (U.S.A.)****W.D.Pa. Expert Testimony**

- 8 SIGHTSOUND.COM INCORPORATED, a Pennsylvania corporation, Plaintiff, v. N2K, INC., a Delaware corporation, Cdnw, Inc., a Pennsylvania corporation, and Cdnw Online, Inc., a Pennsylvania corporation, Defendants., 1998 WL 34373758 (Expert Report and Affidavit) (W.D.Pa. 1998) **Opening Expert Report of James A. Moorer** (NO. 98-0118)
- 9 SIGHTSOUND. COM INCORPORATED, A Pennsylvania corporation, Plaintiff, v. N2K, INC., a Delaware corporation CDNOW, Inc., A Pennsylvania corporation, and CDNOW Online, Inc., a Pennsylvania corporation, Defendants., 2001 WL 34891529 (Expert Deposition) (W.D.Pa. Apr. 19, 2001) **Proceedings** (NO. 98-118)

© Copyright 2006 West, Carswell, Sweet & Maxwell Asia and Thomson Legal & Regulatory Limited, ABN 64 058 914 668, or their Licensors. All rights reserved.

- 10 SIGHTSOUND.COM INCORPORATED, a Pennsylvania corporation, Plaintiff, v. N2K, INC., a Delaware Corporation, CDNOW, INC., a CDNOW Online, Inc., a Pennsylvania corporation, Defendants., 2002 WL 32994569 (Expert Report and Affidavit) (W.D.Pa. Dec. 24, 2002) **Expert Report of Michael Ian Shamos, Ph.D., J.D.** (NO. 98-118)
- 11 SIGHTSOUND.COM INCORPORATED, Plaintiff, v. N2K, INC., CDNow, Inc., and CDNow Online, Inc., Defendants., 2003 WL 24288805 (Expert Report and Affidavit) (W.D.Pa. Jan. 21, 2003) **Expert Report of Justin Douglas Tygar, Ph.D.** (NO. 98-0118)
- 12 SIGHTSOUND.COM INCORPORATED, a Pennsylvania corporation, Plaintiff, v. N2K, INC., a Delaware corporation, Cdnw, Inc., a Pennsylvania corporation, and Cdnw Online, Inc., a Pennsylvania corporation, Defendants., 2003 WL 24288806 (Expert Report and Affidavit) (W.D.Pa. Feb. 19, 2003) **Rebuttal Expert Report of James A. Moorer to Opening Report of Professor Tygar** (NO. 98-0118)
- 13 SIGHTSOUND.COM INCORPORATED a Pennsylvania corporation, Plaintiff, v. N2K, INC., a Delaware Corporation, Cdnw, Inc., a Pennsylvania corporation, and Cdnw Online, Inc., a Pennsylvania corporation, Defendants., 2003 WL 24288804 (Expert Report and Affidavit) (W.D.Pa. Feb. 20, 2003) **Rebuttal Report of Michael Ian Shamos, Ph.D., J.D.** (NO. 98-118)
- 14 SIGHTSOUND.COM INCORPORATED, Plaintiff, v. N2K, INC., CDnow, Inc., and CDnow Online, Inc., Defendants., 2003 WL 24289706 (Expert Report and Affidavit) (W.D.Pa. Feb. 20, 2003) **Rebuttal Expert Report of Justin Douglas Tygar, Ph.D.** (NO. 98-0118)
- 15 SIGHTSOUND.COM, INC., a Pennsylvania corporation, Plaintiff, v. N2K, INC., a Delaware corporation, Cdnw, Inc., a Pennsylvania corporation, and Cdnw Online, Inc., a Pennsylvania corporation, Defendants., 2003 WL 24288807 (Expert Report and Affidavit) (W.D.Pa. Apr. 23, 2003) **Declaration by James A. Moorer in Support of Defendants' Motion for Summary Judgment** (NO. 98-0118)
- 16 SIGHTSOUND.COM, INC., a Pennsylvania corporation, Plaintiff and, Counterdefendants, v. N2K, INC., a Delaware corporation, CDNOW, Inc., a Pennsylvania corporation, and Cdnw Online, INC., a Pennsylvania corporation, Defendants and Counterclaimants., 2004 WL 3735168 (Expert Report and Affidavit) (W.D.Pa. Jan. 27, 2004) **Declaration of Michael Ian Shamos in Support of Defendants' Motion for Summary Judgment** (NO. 98-0118)

Assignments

- 17 Assignee(s): KENYON & KENYON ONE BROADWAY NEW YORK NEW YORK 10004
Assignee(s): SCHWARTZ, ANSEL M. ONE STERLING PLAZA 201 N. CRAIG STREET, SUITE 304 PITTSBURGH PENNSYLVANIA 15213, DATE RECORDED: Oct 24, 2001
- 18 ASSIGNEE(S): SIGHTSOUND.COM INCORPORATED 733 WASHINGTON ROAD, SUITE 400 MT. LEBANON PENNSYLVANIA 15228, DATE RECORDED: May 03, 2000
- 19 , DATE RECORDED: Oct 02, 1995

Patent Status Files

- .. Request for Re-Examination, (OG date: Mar 29, 2005)
- .. Patent Suit(See LitAlert Entries),
- .. Certificate of Correction, (OG date: Dec 21, 1993)

Litigation Alert

- 23 LitAlert P1998-06-59, (1999) Action Taken: A complaint was filed.

Prior Art

- ▶ 24 US PAT 4567359 AUTOMATIC INFORMATION, GOODS AND SERVICES DISPENSING SYSTEM, (U.S. PTO Utility 1986)
- ◐ 25 US PAT 3990710 COIN-OPERATED RECORDING MACHINE, (U.S. PTO Utility 1976)
- ◐ 26 US PAT 4654799 SOFTWARE VENDING SYSTEM, Assignee: Brother Kogyo Kabushiki Kaisha, (U.S. PTO Utility 1987)
- ◐ 27 US PAT 3718906 VENDING SYSTEM FOR REMOTELY ACCESSIBLE STORED INFORMATION, Assignee: Lightner R, (U.S. PTO Utility 1973)
- ◐ 28 US PAT 4647989 VIDEO CASSETTE SELECTION MACHINE, (U.S. PTO Utility 1987)

© Copyright 2006 West, Carswell, Sweet & Maxwell Asia and Thomson Legal & Regulatory Limited, ABN 64 058 914 668, or their Licensors. All rights reserved.

[Order Documents](#) | [Available Courts](#) | [Total Litigator](#) | [Lexis.com](#) | [Sign Out](#) | [Learning Center](#)

LexisNexis® CourtLink®

Welcome James Matthews!

[My CourtLink](#) [Search](#) [Dockets & Documents](#) [Track](#) [Alert](#) [Strategic Profiles](#) [My Account](#)

 [Search](#) > [Patent Search](#) > [Patent Search 5191573 4/13/2006](#) > [Docket View](#)

Docket Tools

[Get Updated Docket](#)

This docket was retrieved from the court on 4/3/2006

[Track Docket Activity](#)

CourtLink can alert you when there is new activity in this case

[Search for Similar](#)

Start a new search based on the characteristics of this case

[Set Alert for Similar Dockets](#)

CourtLink alerts you when there are new cases that match characteristics of this case [Email](#) [Print](#)

[View patents concerning this case.](#)

Docket

US District Court Civil Docket

U.S. District - Pennsylvania Western
(Pittsburgh)

2:04cv1549

Sightsound Tech v. Roxio, Inc, et al

This case was retrieved from the court on Monday, April 03, 2006

Date Filed: **10/08/2004** Class Code:
Assigned To: **Chief Judge Donetta W Ambrose** Closed: **no**
Referred To: Statute: **35:271**
Nature of suit: **Patent (830)** Jury Demand: **Both**
Cause: **Patent Infringement** Demand Amount: **\$0**
Lead Docket: **None** NOS Description: **Patent**
Other Docket: **Related, 2:98-cv-118**
Jurisdiction: **Federal Question**

Litigants

Sightsound Technologies, Inc A Delaware Corporation
Plaintiff

Attorneys

[Brian S Mudge](#)
[COR LD NTC]
[Kenyon & Kenyon](#)
1500 K Street, NW
Suite 700
Washington , DC 20005-1257
USA
(202) 220-4200
Firm: (202) 220-4201
Email: Bmudge@kenyon.com

[Clyde E Findley](#)
[COR LD NTC]
[Kenyon & Kenyon](#)

1500 K Street, NW
Suite 700
Washington , DC 20005-1257
USA
(202) 220-4200

Duncan L. Williams
[COR LD NTC]
Kenyon & Kenyon
1500 K Street, NW
Suite 700
Washington , DC 20005-1257
USA
(202) 220-4200
Email: Dllwilliams@kenyon.com

Richard F. Rinaldo
[COR LD NTC]
Meyer, Unkovic & Scott
1300 Oliver Building
Pittsburgh , PA 15222
USA
(412) 456-2876
Email: Rfr@muslaw.com

William K. Wells
[COR LD NTC]
Kenyon & Kenyon
1500 K Street, NW
Suite 700
Washington , DC 20005-1257
USA
(202) 220-4200
Email: Wwells@kenyon.com

Roxio, Inc A Delaware Corporation
Defendant

Charles K. Verhoeven
[COR LD NTC]
Quinn, Emanuel, Urquhart, Oliver & Hedges
50 California Street
22ND Floor
San Francisco , CA 94111
USA
(415) 875-6600
Email: Charlesverhoeven@quinnemanuel.com

Kathryn M. Kenyon
[COR LD NTC]
Pepper Hamilton
500 Grant Street
50TH Floor, One Mellon Bank Center
Pittsburgh , PA 15219
USA
(412) 454-5000
Email: Kenyonk@pepperlaw.com

Kevin P. Allen
[COR LD NTC]
[Term: 01/11/2005]
Thorp, Reed & Armstrong
301 Grant Street
One Oxford Centre, 14TH Floor
Pittsburgh , PA 15219-1425
USA
(412) 394-2366
Email: Kallen@thorpreed.com

Laurence Z. Shiekman
[COR LD NTC]
Pepper Hamilton Eighteenth & Arch Streets

3000 Two Logan Square
Philadelphia , PA 19103-2799
USA
(215) 981-4000
Email: Shiekman@pepperlaw.com

Michael E Williams
[COR LD NTC]
Quinn, Emanuel, Urquhart, Oliver & Hedges
865 South Figueroa Street
10TH Floor
Los Angeles , CA 90017
USA
(213) 443-3000
Email: Michaelwilliams@quinnemanuel.com

Tigran Guledjian
[COR LD NTC]
Quinn, Emanuel, Urquhart, Oliver & Hedges
865 South Figueroa Street
10TH Floor
Los Angeles , CA 90017
USA
(213) 443-3000
Email: Tigranguledjian@quinnemanuel.com

William M Wycoff
[COR LD NTC]
[Term: 01/11/2005]
Thorp, Reed & Armstrong
301 Grant Street
One Oxford Centre, 14TH Floor
Pittsburgh , PA 15222-4895
USA
394-7782
Email: Wwycoff@thorpreed.com

Napster, Llc A Delaware Limited Liability Company
Defendant

Charles K Verhoeven
[COR LD NTC]
Quinn, Emanuel, Urquhart, Oliver & Hedges
50 California Street
22ND Floor
San Francisco , CA 94111
USA
(415) 875-6600
Email: Charlesverhoeven@quinnemanuel.com

Kathryn M Kenyon
[COR LD NTC]
Pepper Hamilton
500 Grant Street
50TH Floor, One Mellon Bank Center
Pittsburgh , PA 15219
USA
(412) 454-5000
Email: Kenyonk@pepperlaw.com

Kevin P Allen
[COR LD NTC]
[Term: 01/11/2005]
Thorp, Reed & Armstrong
301 Grant Street
One Oxford Centre, 14TH Floor
Pittsburgh , PA 15219-1425
USA
(412) 394-2366
Email: Kallen@thorpreed.com

Laurence Z Shiekman

[COR LD NTC]
Pepper Hamilton Eighteenth & Arch Streets
3000 Two Logan Square
Philadelphia , PA 19103-2799
USA
(215) 981-4000
Email: Shiekmanl@pepperlaw.com

Michael E Williams
[COR LD NTC]
Quinn, Emanuel, Urquhart, Oliver & Hedges
865 South Figueroa Street
10TH Floor
Los Angeles , CA 90017
USA
(213) 443-3000
Email: Michaelwilliams@quinnemanuel.com

Michael T Zeller
[COR LD NTC]
Quinn Emanuel Urquhart Oliver & Hedges
865 S Figueroa Street, 10TH Floor
Los Angeles , CA 90017
USA
(213) 443-3000
Email: Michaelzeller@quinnemanuel.com

Tigran Guledjian
[COR LD NTC]
Quinn, Emanuel, Urquhart, Oliver & Hedges
865 South Figueroa Street
10TH Floor
Los Angeles , CA 90017
USA
(213) 443-3000
Email: Tigranguledjian@quinnemanuel.com

William M Wycoff
[COR LD NTC]
[Term: 01/11/2005]
Thorp, Reed & Armstrong
301 Grant Street
One Oxford Centre, 14TH Floor
Pittsburgh , PA 15222-4895
USA
394-7782
Email: Wwycoff@thorpreed.com

Scott Sander
Counter Defendant

Brian S Mudge
[COR LD NTC]
Kenyon & Kenyon
1500 K Street, NW
Suite 700
Washington , DC 20005-1257
USA
(202) 220-4200
Firm: (202) 220-4201
Email: Bmudge@kenyon.com

Richard F Rinaldo
[COR LD NTC]
Meyer, Unkovic & Scott
1300 Oliver Building
Pittsburgh , PA 15222
USA
(412) 456-2876
Email: Rfr@muslaw.com

William K Wells

[COR LD NTC]
 Kenyon & Kenyon
 1500 K Street, NW
 Suite 700
 Washington , DC 20005-1257
 USA
 (202) 220-4200
 Email: Wwells@kenyon.com

Documents

Retrieve Document(s)

				Proceeding Text
<input type="checkbox"/>	Availability	Date	No.	<input type="text"/> Filter
<input type="checkbox"/>	Runner	10/08/2004	1	COMPLAINT with summons issued; jury demand Filing Fee \$ 150.00 Receipt # 05010/08/2004)
<input type="checkbox"/>	Runner	10/08/2004	2	DISCLOSURE statement by SIGHTSOUND TECH (tt) (Entered: 10/08/2004)
<input type="checkbox"/>	Runner	10/08/2004	--	COPY of Complaint and Docket Entries mailed to the Commissioner of Patents and Trademarks (Entered: 10/08/2004)
<input type="checkbox"/>	Runner	11/08/2004	3	RETURN OF SERVICE executed as to ROXIO, INC. 11/5/04 Answer due on 11/26/04 (tt) (Entered: 11/09/2004)
<input type="checkbox"/>	Runner	11/08/2004	4	RETURN OF SERVICE executed as to NAPSTER, L.L.C. 11/5/04 Answer due on 11/26/04 (tt) (Entered: 11/09/2004)
<input type="checkbox"/>	Runner	11/24/2004	5	ANSWER to Complaint; jury demand and COUNTERCLAIM by ROXIO, INC., NAPSTER, L.L.C., William M. Wycoff, Kevin P. Allen, Charles K. Verhoeven, Michael E. Williams) against SIGHTSOUND TECH (tt) Modified on 03/11/2005 (Entered: 11/24/2004)
<input type="checkbox"/>	Runner	11/24/2004	6	DISCLOSURE statement by ROXIO, INC., NAPSTER, L.L.C. (tt) (Entered: 11/24/2004)
<input type="checkbox"/>	Runner	11/24/2004	7	NOTICE Opting Out of Arbitration by ROXIO, INC., NAPSTER, L.L.C. (tt) (Entered: 11/24/2004)
<input type="checkbox"/>	Runner	12/15/2004	8	ANSWER by SIGHTSOUND TECH to [5-2] counterclaims by NAPSTER, L.L.C., ROXIO, INC. (tt) (Entered: 12/16/2004)
<input type="checkbox"/>	Runner	12/17/2004	9	Case Management Conference set for 9:15 1/11/05 (tt) (Entered: 12/17/2004)
<input type="checkbox"/>	Runner	01/10/2005	10	INITIAL Case Scheduling Conference Statement by ROXIO, INC., NAPSTER, L.L.C. (tt) (Entered: 01/10/2005)
<input type="checkbox"/>	Runner	01/10/2005	11	MOTION by SIGHTSOUND TECH for Preliminary Injunction , with Proposed Order. (tt) (Entered: 01/11/2005)
<input type="checkbox"/>	Runner	01/10/2005	12	EXHIBITS by SIGHTSOUND TECH to [11-1] motion for Preliminary Injunction (tt) (Entered: 01/11/2005)
<input type="checkbox"/>	Runner	01/10/2005	13	BRIEF by SIGHTSOUND TECH in support of [11-1] motion for Preliminary Injunction (tt) (Entered: 01/11/2005)
<input type="checkbox"/>	Runner	01/10/2005	14	DECLARATION of Justin Douglas Tygar, Ph.D. concerning the Operation of Roxio/NAPSTER motion for Preliminary Injunction by SIGHTSOUND TECH (tt) (Entered: 01/11/2005)
<input type="checkbox"/>	Runner	01/11/2005	15	MOTION by ROXIO, INC., NAPSTER, L.L.C. to Substitute Attorney , with Proposed Order. (tt) (Entered: 01/11/2005)
<input type="checkbox"/>	Runner	01/11/2005	16	MOTION by ROXIO, INC., NAPSTER, L.L.C. for Charles K. Verhoeven to Appear Pro Hac Vice \$ 40.00 Receipt # 05001581 , with Proposed Order. (tt) (Entered: 01/11/2005)
<input type="checkbox"/>	Runner	01/11/2005	17	MOTION by ROXIO, INC., NAPSTER, L.L.C. for Tigran Guledjian to Appear Pro Hac Vice \$ 40.00 Receipt # 05001581 , with Proposed Order. (tt) (Entered: 01/11/2005)
<input type="checkbox"/>	Runner	01/11/2005	18	MOTION by ROXIO, INC., NAPSTER, L.L.C. for Michael E. Williams to Appear Pro Hac Vice \$ 40.00 Receipt # 05001581 , with Proposed Order. (tt) (Entered: 01/11/2005)
<input type="checkbox"/>	Runner	01/11/2005	19	Status Conference held 1/11/05 before Chief Judge Donetta W. Ambrose [Reported] (Entered: 01/11/2005)
<input type="checkbox"/>	Runner	01/11/2005	--	Deadline updated; Response to Motion set to 2/11/05 for [11-1] motion for Preliminary Injunction Reply to Response to Motion set to 2/21/05 for [11-1] motion for Preliminary Injunction Hearing set for 1:30 3/3/05 for [11-1] motion for Preliminary Injunction (tt) (Entered: 01/11/2005)
<input type="checkbox"/>	Runner	01/11/2005	20	RESPONSE by SIGHTSOUND TECH to defts' [10-1] Initial Case Scheduling Conference (Entered: 01/11/2005)
				ORDER upon motion granting [15-1] motion to Substitute Attorney ; terminated at the request of William M. Wycoff for ROXIO, INC., attorney Kevin P. Allen for ROXIO, INC., attorney William M. Wycoff

<input type="checkbox"/>	Runner	01/11/2005	--	NAPSTER, L.L.C., attorney Kevin P. Allen for NAPSTER, L.L.C. and added Laurence Kathryn M. Kenyon for defts. (signed by Chief Judge Donetta W. Ambrose on 1/11/05) CM all parties of record. (tt) (Entered: 01/12/2005)
<input type="checkbox"/>	Runner	01/11/2005	--	ORDER upon motion granting [16-1] motion for Charles K. Verhoeven to Appear Pro Hac Vice for defts. (signed by Chief Judge Donetta W. Ambrose on 1/11/05) CM all parties of record. (tt) (Entered: 01/12/2005)
<input type="checkbox"/>	Runner	01/11/2005	--	ORDER upon motion granting [17-1] motion for Tigran Guledjian to Appear Pro Hac Vice for defts. (signed by Chief Judge Donetta W. Ambrose on 1/11/05) CM all parties of record. (tt) (Entered: 01/12/2005)
<input type="checkbox"/>	Runner	01/11/2005	--	ORDER upon motion granting [18-1] motion for Michael E. Williams to Appear Pro Hac Vice for defts. (signed by Chief Judge Donetta W. Ambrose on 1/11/05) CM all parties of record. (tt) (Entered: 01/12/2005)
<input type="checkbox"/>	Runner	01/18/2005	21	Status Conference via phone held 1/18/05 before Chief Judge Donetta W. Ambrose. Deft wants leave to amend counterclaims related to press release. Pltf doesn't object to leave to amend. Leave granted orally by the Court; Amended counterclaim due 1/26/05. Motion to Stay Case pending outcome of application to Patent & Trademark Office, 10 days. (tt) (Entered: 01/19/2005)
<input type="checkbox"/>	Runner	01/21/2005	22	MOTION by ROXIO, INC., NAPSTER, L.L.C. to Stay Pending Reexamination of Patents Pending Proposed Order. (jsp) (Entered: 01/24/2005)
<input type="checkbox"/>	Runner	01/21/2005	23	BRIEF by ROXIO, INC., NAPSTER, L.L.C. in support of [22-1] motion to Stay Pending Reexamination of Patents in Suit by NAPSTER, L.L.C., ROXIO, INC. (jsp) (Entered: 01/24/2005)
<input type="checkbox"/>	Runner	01/25/2005	24	FIRST AMENDED ANSWER to Complaint by ROXIO, INC., NAPSTER, L.L.C. amends ANSWER to Complaint by ROXIO, INC., NAPSTER, L.L.C. and COUNTERCLAIMS against SIGHTSOUND TECH (tt) (Entered: 01/26/2005)
<input type="checkbox"/>	Runner	01/27/2005	25	MOTION by SIGHTSOUND TECH to Extend Time w/in which to respond to defts' motion to stay pending receipt of defts' request for re-examination of patents and prior art which defts intend to file with Patent and Trademark Office, with Proposed Order. (tt) (Entered: 01/28/2005)
<input type="checkbox"/>	Runner	01/28/2005	26	RESPONSE by ROXIO, INC., NAPSTER, L.L.C. to pltf's [25-1] motion to Extend Time w/in which to respond to defts' motion to stay (tt) (Entered: 01/28/2005)
<input type="checkbox"/>	Runner	01/28/2005	27	ACCEPTANCE OF SERVICE of First Amended Answer and Counterclaim as to Scott: 01/26/05 (tt) (Entered: 01/28/2005)
<input type="checkbox"/>	Runner	01/28/2005	28	BRIEF by SIGHTSOUND TECH in support of [25-1] motion to Extend Time w/in which to respond to defts' motion to stay (tt) (Entered: 01/31/2005)
<input type="checkbox"/>	Runner	02/02/2005	29	Status Conference via phone held 1/31/05 before Chief Judge Donetta W. Ambrose. Pltf's response to motion to stay due 2/11/05 ; Defts' reply due 2/16/05 ; Preliminary injunction will be scheduled via order on motion to stay ; Defts do not have to file answer to motion to stay by March. (tt) (Entered: 02/02/2005)
<input type="checkbox"/>	Runner	02/02/2005	--	ORDER upon motion granting [25-1] motion to Extend Time w/in which to respond to defts' motion to stay pending receipt of defts' request for re-examination of patents and prior art which defts intend to file with the Patent and Trademark Office. Defts shall serve on counsel for pltf by 2/11/05 a response to motion to stay no later than 2/11/05 any request for re-examination of the patents in suit which defts intend to file with the PTO, including all prior art on which defts plan to rely in such request for re-examination. Response to Motion set to 2/11/05 for defts' [22-1] motion to Stay Pending Reexamination of Patents in Suit ; Defts' Reply Brief due 2/16/05 ; Defts are not required to file an answer to pltf's preliminary injunction until further order of court. (signed by Chief Judge Donetta W. Ambrose on 1/31/05) CM all parties of record. (tt) (Entered: 02/02/2005)
<input type="checkbox"/>	Runner	02/03/2005	30	MOTION by SIGHTSOUND TECH for Brian S. Mudge to Appear Pro Hac Vice ; Filing # 05001943, with Proposed Order. (tt) (Entered: 02/04/2005)
<input type="checkbox"/>	Runner	02/03/2005	31	MOTION by SIGHTSOUND TECH for William K. Wells to Appear Pro Hac Vice ; Filing # 05001943, with Proposed Order. (tt) (Entered: 02/04/2005)
<input type="checkbox"/>	Runner	02/03/2005	32	MOTION by SIGHTSOUND TECH for Duncan L. Williams to Appear Pro Hac Vice ; Filing # 05001943, with Proposed Order. (tt) (Entered: 02/04/2005)
<input type="checkbox"/>	Runner	02/03/2005	33	MOTION by SIGHTSOUND TECH for Clyde E. Findley to Appear Pro Hac Vice ; Filing # 05001943, with Proposed Order. (tt) (Entered: 02/04/2005)
<input type="checkbox"/>	Runner	02/04/2005	34	NOTICE of Lodging of Pending Requests for Reexamination by ROXIO, INC., NAPSTER, L.L.C. (Entered: 02/04/2005)
<input type="checkbox"/>	Runner	02/04/2005	35	EXHIBITS (VOLUME I) by ROXIO, INC., NAPSTER, L.L.C. to [34-1] notice of lodging of requests for reexamination. (tt) (Entered: 02/04/2005)
<input type="checkbox"/>	Runner	02/04/2005	36	EXHIBITS (VOLUME II) by ROXIO, INC., NAPSTER, L.L.C. to [34-1] notice of lodging of requests for reexamination. (tt) (Entered: 02/04/2005)
<input type="checkbox"/>	Runner	02/04/2005	37	EXHIBITS (VOLUME III) by ROXIO, INC., NAPSTER, L.L.C. to [34-1] notice of lodging of requests for reexamination. (tt) (Entered: 02/04/2005)
<input type="checkbox"/>	Runner	02/07/2005	--	ORDER upon motion granting [30-1] motion for Brian S. Mudge to Appear Pro Hac Vice (signed by Chief Judge Donetta W. Ambrose on 2/4/05) CM all parties of record. (tt) (Entered: 02/07/2005)
<input type="checkbox"/>	Runner	02/07/2005	--	ORDER upon motion granting [31-1] motion for William K. Wells to Appear Pro Hac Vice (signed by Chief Judge Donetta W. Ambrose on 2/4/05) CM all parties of record. (tt) (Entered: 02/07/2005)

			02/07/2005)
<input type="checkbox"/>	Runner	02/07/2005	-- ORDER upon motion granting [32-1] motion for Duncan L. Williams to Appear Pro pltf. (signed by Chief Judge Donetta W. Ambrose on 2/4/05) CM all parties of rec 02/07/2005)
<input type="checkbox"/>	Runner	02/07/2005	-- ORDER upon motion granting [33-1] motion for Clyde E. Findley to Appear Pro Ha pltf. (signed by Chief Judge Donetta W. Ambrose on 2/4/05) CM all parties of rec 02/07/2005)
<input type="checkbox"/>	Runner	02/11/2005	38 REPLY by SIGHTSOUND TECH to [24-2] First Amended Counterclaims by NAPSTER (tt) (Entered: 02/14/2005)
<input type="checkbox"/>	Runner	02/11/2005	39 BRIEF by SIGHTSOUND TECH in opposition to Napster's [22-1] motion to Stay Pen of Patents in Suit (tt) (Entered: 02/14/2005)
<input type="checkbox"/>	Runner	02/11/2005	40 MOTION by SIGHTSOUND TECH, SCOTT SANDER to Dismiss defts' Amended Couni (Entered: 02/14/2005)
<input type="checkbox"/>	Runner	02/11/2005	41 BRIEF by SIGHTSOUND TECH, SCOTT SANDER in support of their [40-1] motion to Amended Counterclaims 4-9 (tt) (Entered: 02/14/2005)
<input type="checkbox"/>	Runner	02/16/2005	42 REPLY by ROXIO, INC., NAPSTER, L.L.C. in support of their Motion to Stay pending the Patents-In-Suit (tt) (Entered: 02/17/2005)
<input type="checkbox"/>	Runner	02/16/2005	43 DECLARATION of William E. Growney (tt) Modified on 02/18/2005 (Entered: 02/17/2005)
<input type="checkbox"/>	Runner	02/16/2005	44 MOTION by ROXIO, INC., NAPSTER, L.L.C. to Seal [43-1] Declarion , with Propo: (Entered: 02/17/2005)
<input type="checkbox"/>	Runner	02/17/2005	45 OPPOSITION by SIGHTSOUND TECH to defts' [44-1] motion to Seal [43-1] Declar: 02/18/2005)
<input type="checkbox"/>	Runner	02/17/2005	46 NOTICE OF FILING: Supplemental Declaration of Christopher Reese by SIGHTSOUN UNDER SEAL) (tt) Modified on 02/28/2005 (Entered: 02/18/2005)
<input type="checkbox"/>	Runner	02/17/2005	47 REQUEST by SIGHTSOUND TECH for Oral Argument on Motion to Stay . (tt) (Enter
<input type="checkbox"/>	Runner	02/18/2005	-- ORDER upon motion denying [44-1] motion to Seal [43-1] Declaration. The declar. vague, unsuccessful attempts & no dollar values are set forth. I see no risk of conf being disclosed. (signed by Chief Judge Donetta W. Ambrose on 2/18/05) CM all (Entered: 02/18/2005)
<input type="checkbox"/>	Runner	02/18/2005	-- ORDER upon motion denying [47-1] motion for Oral Argument on Motion to Stay. clearly represented their respective positions in the briefs and declarations filed. (Donetta W. Ambrose on 2/18/05) CM all parties of record. (tt) (Entered: 02/18/2005)
<input type="checkbox"/>	Runner	02/23/2005	48 MOTION by ROXIO, INC., NAPSTER, L.L.C. to Seal Supplemental Declaration of Ch Proposed Order. (tt) (Entered: 02/23/2005)
<input type="checkbox"/>	Runner	02/23/2005	49 OPPOSITION by SIGHTSOUND TECH to defts' [48-1] motion to Seal Supplemental Christopher Reese (tt) (Entered: 02/24/2005)
<input type="checkbox"/>	Runner	02/28/2005	-- ORDER upon motion granting [48-1] motion to Seal Supplemental Declaration of C The Supplemental Declaration of Christopher Reese filed 2/17/05 shall be placed u Chief Judge Donetta W. Ambrose on 2/28/05) CM all parties of record. (tt) (Enter
<input type="checkbox"/>	Runner	02/28/2005	50 MEMORANDUM OPINION & ORDER granting defts' [22-1] motion to Stay. The defts: Court immediately upon receiving any notification from the PTO regarding the outc for Reexamination. The preliminary injunction hearing scheduled for 3/3/05 is can motion for Preliminary Injunction is denied without prejudice to reassert once the : by Chief Judge Donetta W. Ambrose on 2/28/05) CM all parties of record. (tt) (En
<input type="checkbox"/>	Runner	03/03/2005	51 NOTICE OF APPEAL by SIGHTSOUND TECH from [50-1] memorandum opinion date FEE \$ 255 RECEIPT # 2394 TPO issued. (lck) (Entered: 03/07/2005)
<input type="checkbox"/>	Runner	03/03/2005	-- Certified copy of Notice of Appeal [51-1] appeal by SIGHTSOUND TECH , certified & certified copy of order dated 2/28/05 mailed to USCA; copy of Notice of Appeal an: ROXIO, INC., NAPSTER, L.L.C. and judge. Copy of information sheet to appellant. (03/07/2005)
<input type="checkbox"/>	Runner	03/11/2005	52 Transcript Purchase order re: [51-1] appeal by SIGHTSOUND TECH indicating that ordered. (tt) (Entered: 03/11/2005)
<input type="checkbox"/>	Runner	03/21/2005	-- Text not available. (Entered: 03/21/2005)
<input type="checkbox"/>	Runner	04/04/2005	53 NOTICE of PTO's Order granting ex parte Reexamination by ROXIO, INC., NAPSTEI (Entered: 04/04/2005)
<input type="checkbox"/>	Online	07/21/2005	54 MOTION for Relief from Stay with Respect to Defamation Counterclaims by SIGHTS TECHNOLOGIES, INC., SCOTT SANDER. (Attachments: # 1 Proposed Order)(jsp) (07/21/2005)
<input type="checkbox"/>	Online	07/21/2005	55 BRIEF in Support re 54 MOTION for Relief from Stay with Respect to Defamation C SIGHTSOUND TECHNOLOGIES, INC., SCOTT SANDER. (Attachments: # 1 Part 2 of 07/21/2005)
<input type="checkbox"/>	Online	07/22/2005	56 NOTICE: re 54 MOTION for Relief from Stay with Respect to Defamation Countercl. on or before 8/4/05. (jih) (Entered: 07/22/2005)
<input type="checkbox"/>	Online	08/04/2005	57 NOTICE by ROXIO, INC., NAPSTER, L.L.C. of PTO's Issuance of Office Actions in Ex

				(Attachments: # 1 # 2 # 3)(Heimsen, Joseph) (Entered: 08/04/2005)
<input type="checkbox"/>	Online	08/04/2005	58	MOTION for attorney Michael T. Zeller to Appear Pro Hac Vice by ROXIO, INC., NAI (Attachments: # 1 Proposed Order)(Kenyon, Kathryn) (Entered: 08/04/2005)
<input type="checkbox"/>	Online	08/04/2005	59	NOTICE by ROXIO, INC., NAPSTER, L.L.C. re 57 Notice (Other) Letter Notice of Pri Kathryn) (Entered: 08/04/2005)
<input type="checkbox"/>	Online	08/04/2005	60	BRIEF in Opposition re 54 MOTION for Relief from Stay with Respect to Defamation by ROXIO, INC., NAPSTER, L.L.C.. (Attachments: # 1 Exhibit A# 2 Exhibit B# 3 Ex 5 Exhibit E# 6 Exhibit F# 7 Exhibit G# 8 Exhibit H)(Kenyon, Kathryn) (Entered: 08/04/2005)
<input type="checkbox"/>	Runner	08/04/2005	--	Pro Hac Vice Fees received in the amount of \$ 40 receipt # 4877 re 58 Motion to A (ept) (Entered: 08/05/2005)
<input type="checkbox"/>	Online	08/08/2005	61	ORDER granting 58 Motion to Appear Pro Hac Vice . Signed by Judge Donetta W. A (jlh) (Entered: 08/08/2005)
<input type="checkbox"/>	Online	09/01/2005	62	ORDER denying 54 Motion for Relief from Stay . Signed by Judge Donetta W. Amb (jlh) (Entered: 09/01/2005)
<input type="checkbox"/>	Online	09/06/2005	63	NOTICE by SIGHTSOUND TECHNOLOGIES, INC., SCOTT SANDER NOTICE OF FILIN RECORD (Kerr, Benjamin) (Entered: 09/06/2005)
<input type="checkbox"/>	Online	09/07/2005	64	Minute Entry for proceedings held before Judge Donetta W. Ambrose : Status Conf 9/7/2005. Parties to keep Court informed of PTO Action. (jlh) (Entered: 09/07/2005)
<input type="checkbox"/>	Online	11/02/2005	65	NOTICE by ROXIO, INC., NAPSTER, L.L.C. of PTO's Issuance of Second Office Actio Reexamination (Attachments: # 1 Exhibit A# 2 Exhibit B# 3 Exhibit C)(Kenyon, K (11/02/2005)
<input type="checkbox"/>	Online	11/14/2005	66	MANDATE of USCA for the Federal Circuit as to [51] Notice of Appeal filed by SIGH TECHNOLOGIES, INC., that the appeal is dismissed, with each party to bear its ow (Entered: 11/15/2005)
<input type="checkbox"/>	Online	03/02/2006	67	MOTION by Clyde E. Findley to Withdraw as Attorney by SIGHTSOUND TECHNOLO (Entered: 03/02/2006)

[Retrieve Document\(s\)](#)

Source: [Command Searching](#) > **Utility, Design and Plant Patents** 
Terms: **patno=5191573** ([Edit Search](#) | [Suggest Terms for My Search](#))

586391 (07) 5191573 March 2, 1993

UNITED STATES PATENT AND TRADEMARK OFFICE GRANTED PATENT

5191573

◆ [GET 1st DRAWING SHEET OF 2](#)

[Access PDF of Official Patent *](#)

[Check for Patent Family Report PDF availability *](#)

* Note: A transactional charge will be incurred for downloading an Official Patent or Patent Family Report. Your acceptance of this charge occurs in a later step in your session. The transactional charge for downloading is outside of customer subscriptions; it is not included in any flat rate packages.

[Order Patent File History / Wrapper from REEDFAX®](#)

[Link to Claims Section](#)

March 2, 1993

Method for transmitting a desired digital video or audio signal

REEXAM-LITIGATE: January 31, 2005 - Reexamination requested by Napster, Inc.; c/o Albert S. Penilla, Martine, Penilla & Gencarella, LLP, Reexamination No. 90/007,402 (O.G. March 29, 2005) Ex. Gp: 2655

NOTICE OF LITIGATION

Sightsound Technologies, Inc., a Delaware corporation v. Roxio, Inc., a Delaware corporation, et al, Filed October 8, 2004, D.C. W.D. Pennsylvania (Pittsburgh), Doc. No. 04-CV-1549

INVENTOR: Hair, Arthur R. - 301 Oaklawn Dr., Pittsburgh, Pennsylvania, United States (US), 15241

CERT-CORRECTION: December 21, 1993 - a Certificate of Correction was issued for this Patent

APPL-NO: 586391 (07)

FILED-DATE: September 18, 1990

GRANTED-DATE: March 2, 1993

ASSIGNEE-AFTER-ISSUE: October 2, 1995 - ASSIGNMENT OF ASSIGNORS INTEREST (SEE DOCUMENT FOR DETAILS)., PARSEC SIGHT/SOUND, INC. 1518 ALLISON DRIVE UPPER ST. CLAIR PENNSYLVANIA 15241, Reel and Frame Number: 07656/0701
May 3, 2000 - CHANGE OF NAME (SEE DOCUMENT FOR DETAILS)., SIGHTSOUND.COM INCORPORATED 733 WASHINGTON ROAD, SUITE 400 MT. LEBANON PENNSYLVANIA 15228, Reel and Frame Number: 10776/0703
October 24, 2001 - NOTICE OF GRANT OF SECURITY INTEREST, D&DF WATERVIEW PARTNERS, L.P. ONE STERLING PLAZA 152 WEST 57TH STREET, 46TH FLOOR NEW YORK NEW YORK 10019; KENYON & KENYON ONE BROADWAY NEW YORK NEW YORK 10004; SCHWARTZ, ANSEL M. ONE STERLING PLAZA 201 N. CRAIG STREET, SUITE 304 PITTSBURGH PENNSYLVANIA 15213; WATERVIEW PARTNERS, LLP ONE STERLING PLAZA 152 WEST 57TH STREET, 46TH FLOOR NEW YORK NEW YORK 10019, Reel and Frame Number: 12506/0415

LEGAL-REP: Schwartz, Ansel M.

PUB-TYPE: March 2, 1993 - Utility Patent having no previously published pre-grant publication (A)

PUB-COUNTRY: United States (US)

REL-DATA:

Continuation of Ser. No. 07/206497, June 13, 1988, ABANDONED

US-MAIN-CL: 369#84

US-ADDL-CL: 235#380, 235#381, 369#15, 369#85

CL: 369, 235, 369

SEARCH-FLD: 369#33, 369#34, 369#13, 369#15, 369#84, 369#85, 235#380, 235#381, 235#375, 364#479, 364#410

IPC-MAIN-CL: 5G 11B005#86

IPC-ADDL-CL: G 11B007#0, G 11B011#0

PRIM-EXMR: Nguyen, Hoa

REF-CITED:

03718906, February, 1973, Lightner, United States (US), 235381

03990710, November, 1976, Hughes, United States (US), 369034

04567359, January, 1986, Lockwood, United States (US), 235381

04647989, March, 1987, Geddes, United States (US), 235381

04654799, March, 1987, Ogaki et al., United States (US), 364479

CORE TERMS: user, song, music, memory, electronically, stored, digital, hardware, hard disk, electronic ...

ENGLISH-ABST:

The present invention is a method for transmitting a desired digital video or audio signal stored on a first memory of a first party to a second memory of a second party. The method comprises the steps of transferring money via a telecommunications line to the first party from the second party. Additionally, the method comprises the step of then connecting electronically via a telecommunications line the first memory with the second memory such that the desired signal can pass therebetween. Next, there is the step of transmitting the desired digital signal from the first memory with a transmitter in control and in possession of the first party to a receiver having the second memory at a location determined by the second party. The receiver is in possession and in control of the second party. There is also the step of then storing the digital signal in the second memory.

NO-OF-CLAIMS: 6

EXMPL-CLAIM: 1

NO-OF-FIGURES: 2

NO-DRWNG-PP: 2

SUMMARY:

FIELD OF THE INVENTION

The present invention is related to a method for the electronic sales and distribution of digital audio or video signals, and more particularly, to a method which a user may purchase and receive digital audio or video signal from any location which the user has access to a telecommunications line.

BACKGROUND OF THE INVENTION

The three basic mediums (hardware units) of music: records, tapes, and compact discs, greatly restricts the transferability of music and results in a variety of inefficiencies.

CAPACITY: The individual hardware units as cited above are limited as to the amount of music that can be stored on each.

MATERIALS: The materials used to manufacture the hardware units are subject to damage and deterioration during normal operations, handling, and exposure to the elements.

SIZE: The physical size of the hardware units imposes constraints on the quantity of hardware units which can be housed for playback in confined areas such as in automobiles, boats, planes, etc.

RETRIEVAL: Hardware units limit the ability to play, in a sequence selected by the user, songs from different albums. For example, if the user wants to play one song from ten different albums, the user would spend an inordinate amount of time handling, sorting, and cueing the ten different hardware units.

SALES AND DISTRIBUTION: Prior to final purchase, hardware units need to be physically transferred from the manufacturing facility to the wholesale warehouse to the retail warehouse to the retail outlet, resulting in lengthy, lag time between music creation and music marketing, as well as incurring unnecessary and inefficient transfer and handling costs. Additionally, tooling costs required for mass production of the hardware units and the material cost of the hardware units themselves, further drives up the cost of music to the end user.

QUALITY: Until the recent invention of Digital Audio Music, as used on Compact Discs, distortion free transfer from the hardware units to the stereo system was virtually impossible. Digital Audio Music is simply music converted into a very basic computer language known as binary. A series of commands known as zeros or ones encode the music for future playback. Use of laser retrieval of the binary commands results in distortion free transfer of the music from the compact disc to the stereo system. Quality Digital Audio Music is defined as the binary structure of the Digital Audio Music. Conventional analog tape recording of Digital Audio Music is not to be considered quality inasmuch as the binary structure itself is not recorded. While Digital Audio Music on compact discs is a technological breakthrough in audio quality, the method by which the music is sold, distributed, stored, manipulated, retrieved, played and protected from copyright infringements remains as inefficient as with records and tapes.

COPYRIGHT PROTECTION: Since the invention of tape recording devices, strict control and enforcement of copyright laws have proved difficult and impossible with home recorders. Additionally, the recent invention of Digital Audio Tape Recorders now jeopardizes the electronic copyright protection of quality Digital Audio Music on Compact Discs or Digital Audio Tapes. If music exists on hardware units, it can be copied.

Accordingly, it is an objective of this invention is to provide a new and improved methodology/system to electronically sell and distribute Digital Audio Music.

A further objective of this invention to provide a new and improved methodology/system to electronically store and retrieve Digital Audio Music.

Another objective of this invention is to provide a new and improved methodology/system to electronically manipulate, i.e., sort, cue, and select, Digital Audio Music for playback.

Still another objective of this invention is to offer a new and improved methodology/system which can prevent unauthorized electronic copying of quality Digital Audio Music.

SUMMARY OF THE INVENTION

Briefly, this invention accomplishes the above cited objectives by providing a new and improved methodology/system of electronic sales, distribution, storage, manipulation, retrieval, playback, and copyright protection of Digital Audio Music. The high speed transfer of Digital Audio Music as prescribed by this invention is stored onto one piece of hardware, a hard disk, thus eliminating the need to unnecessarily handle records, tapes, or compact discs on a regular basis. This invention recalls stored music for playback as selected/programmed by the user. This invention can easily and electronically sort stored music based on many different criteria such as, but not limited to, music category, artist, album, user's favorite songs, etc. An additional feature of this invention is the random playback of songs, also based on the user's selection. For example, the user could have this invention randomly play all jazz songs stored on the user's hard disk, or randomly play all songs by a certain artist, or randomly play all of the user's favorite songs which the user previously electronically "tagged" as favorites. Further, being more specific, the user can electronically select a series of individual songs from different albums for sequential playback.

This invention can be configured to either accept direct input of Digital Audio Music from the digital output of a Compact Disc, such transfer would be performed by the private user, or this invention can be configured to accept Digital Audio Music from a source authorized by the copyright holder to sell and distribute the copyrighted materials, thus guaranteeing the protection of such copyrighted materials. Either method of electronically transferring Digital Audio Music by means of this invention is intended to comply with all copyright laws and restrictions and any such transfer is subject to the appropriate authorization by the copyright holder. Inasmuch as Digital Audio Music is software in this invention electronically transfers and stores such music, electronic sales and distribution of the music can take place via telephone lines onto a hard disk. This new methodology/system of music sales and distribution will greatly reduce the cost of goods sold and will reduce the lag time between music creation and music marketing from weeks down to hours.

The present invention is a method for transmitting a desired digital video or audio signal stored on a first memory of a first party to a second memory of a second party. The method comprises the steps of transferring money via a telecommunications line to the first party from the second party. Additionally, the method comprises the step of then connecting electronically via a telecommunications line the first memory with the second memory such that the desired digital signal can pass therebetween. Next, there is the step of transmitting the desired digital signal from the first memory with a transmitter in control and in possession of the first party to a receiver having the second memory at a location determined by the second party. The receiver is in possession and in control of the second party. There is also the step of then storing the digital signal in the second memory.

Further objectives and advantages of this invention will become apparent as the following description proceeds and the particular features of novelty which characterize this invention will be pointed out in the claims annexed to and forming a part of this declaration.

DRWDESC:

BRIEF DESCRIPTION OF THE SEVERAL VIEWS OF DRAWINGS

For a better understanding of this invention, reference should be made to the following detailed description, taken in conjunction with the accompanying drawings, in which:

FIG. 1 is a pictorial flow chart which may be used in carrying out the teachings of this invention for the purposes of electronic sales, distribution, storage, manipulation, retrieval, playback, and copyright protection of Digital Audio Music; and

FIG. 2 is a pictorial flow chart which may be used in carrying out the teachings of this invention for the purposes of electronic storage, manipulation, retrieval, and playback of Digital Audio Music.

DETDESC:

DESCRIPTION OF THE PREFERRED EMBODIMENT

Referring now to the FIG. 1, this invention is comprised of the following:

10 Hard Disk of the copyright holder

20 Control Unit of the copyright holder

20a Control Panel

20b Control Integrated Circuit

20c Sales Random Access Memory Chip

30 Telephone Lines/Input Transfer

50 Control Unit of the user

50a Control Panel

50b Control Integrated circuit

50c Incoming Random Access Memory Chip

50d Play Back Random Access Memory Chip

60 Hard Disk of the user

70 Video Display Unit

80 Stereo Speakers

The Hard Disk 10 of the agent authorized to electronically sell and distribute the copyrighted Digital Audio Music is the originating source of music in the configuration as outlined in FIG. 1. The Control Unit 20 of the authorized agent is the means by which the electronic transfer of the Digital Audio Music from the agent's Hard Disk 10 via the Telephone Lines 30 to the user's Control Unit 50 is possible. The user's Control Unit would be comprised of a Control Panel 50a, a Control Integrated Circuit 50b, an Incoming Random Access Memory Chip 50c, and a Play Back Random Access Memory Chip 50d. Similarly, the authorized agent's Control Unit 20 would have a control panel and control integrated circuit similar to that of the user's Control Unit 50. The authorized agent's Control Unit 20, however, would only require the Sales Random Access Memory Chip 20c. The other components in FIG. 1 include a Hard Disk 60, a Video (display Unit 70, and a set of Stereo Speakers 80.

Referring now to FIG. 2, with the exception of a substitution of a Compact Disc Player 40 (as the initial source of Digital Audio Music) for the agent's Hard Disk 10, the agent's Control Unit 20, and the Telephone Lines 30 in FIG. 1, FIG. 2 is the same as FIG. 1.

In FIG. 1 and FIG. 2, the following components are already commercially available: the agent's Hard Disk 10, the Telephone Lines 30, the Compact Disc Player 40, the user's Hard Disk 60, the Video Display Unit 70, and the Stereo Speakers 80. The Control Units 20 and 50, however, would be designed specifically to meet the teachings of this invention. The design of the control units would incorporate the following functional features:

- 1) the Control Panels 20a and 50a would be designed to permit the agent and user to program the respective Control Integrated Circuits 20b and 50b,
- 2) the Control Integrated Circuits 20b and 50b would be designed to control and execute the respective commands of the agent and user and regulate the electronic transfer of Digital Audio Music throughout the system, additionally, the sales Control Integrated Circuit 20b could electronically code the Digital Audio Music in a configuration which would prevent unauthorized reproductions of the copyrighted material,
- 3) the Sales Random Access Memory Chip 20c would be designed to temporarily store user purchased Digital Audio Music for subsequent electronic transfer via telephone lines to the user's Control Unit 50,
- 4) the Incoming Random Access Memory Chip 50c would be designed to temporarily store Digital Audio Music for subsequent electronic storage to the user's Hard Disk 60,
- 5) the Play Back Random Access Memory Chip 50d would be designed to temporarily store Digital Audio Music for sequential playback.

The foregoing description of the Control Units 20 and 50 is intended as an example only and thereby is not restrictive with respect to the exact number of components and/or its actual design.

Once the Digital Audio Music has been electronically stored onto the user's Hard Disk 60, having the potential to store literally thousands of songs, the user is free to perform the many functions of this invention. To play a stored song, the user types in the appropriate commands on the Control Panel 50a, and those commands are relayed to the Control Integrated Circuit 50b which retrieves the selected song from the Hard Disk 60. When a song is retrieved from the Hard Disk 60 only a replica of the permanently stored song is retrieved. The permanently stored song remains intact on the Hard Disk 60, thus allowing repeated playback. The Control Integrated Circuit 50b stores the replica onto the Play Back Random Access Memory Chip 50d at a high transfer rate. The Control Integrated Circuit 50b then sends the electronic output to the Stereo Speakers 80 at a controlled rate using the Play Back Random Access Memory Chip 50d as a temporary staging point for the Digital Audio Music.

Unique to this invention is that the Control Unit 50 also serves as the user's personal disk jockey. The user may request specific songs to be electronically cued for playback, or may request the Control Unit 50 to randomly select songs based on the user's criteria. All of these commands are electronically stored in random access memory enabling the control unit to remember prior commands while simultaneously performing other tasks requested by the user and, at the same time, continuing to play songs previously cued.

Offering a convenient visual display of the user's library of songs is but one more new and improved aspect of this invention. As the Control Unit 50 is executing the user's commands to electronically sort, select, randomly play, etc., the Video Display Screen 70 is continually providing feedback to the user. The Video Display Screen 70 can list/scroll all songs stored on the Hard Disk 60, list/scroll all cued songs, display the current command function selected by the user, etc. Further expanding upon the improvements

this invention has to offer, the Video Display Screen 70 can display the lyrics of the song being played, as well as the name of the song, album, artist, recording company, date of recording, duration of song, etc. This is possible if the lyrics and other incidental information are electronically stored to the Hard Disk 60 with the Digital Audio Music.

The present invention is a method for transmitting a desired digital video or audio signal stored on a first memory of a first party to a second memory of a second party. The method comprises the steps of transferring money via a telecommunications line to the first party from the second party. Additionally, the method comprises the step of then connecting electronically via a telecommunications line the first memory with the second memory such that the desired digital signal can pass therebetween. Next, there is the step of transmitting the desired digital signal from the first memory with a transmitter in control and in possession of the first party to a receiver having the second memory at a location determined by the second party. The receiver is in possession and in control of the second party. There is also the step of then storing the digital signal in the second memory.

In summary, there has been disclosed a new and improved methodology/system by which Digital Audio Music can be electronically sold, distributed, transferred, and stored. Further, there has been disclosed a new and improved methodology/system by which Digital Audio Music can be electronically manipulated, i.e., sorted, cued, and selected for playback. Further still, there has been disclosed a new and improved methodology/system by which the electronic manipulation of Digital Audio Music can be visually displayed for the convenience of the user. Additionally, there has been disclosed a new and improved methodology/system by which electronic copyright protection of quality Digital Audio Music is possible through use of this invention.

Since numerous changes may be made in the above described process and apparatus and different embodiments of the invention may be made without departing from the spirit thereof, it is intended that all matter contained in the foregoing description or shown in the accompanying drawings shall be interpreted as illustrative, and not in a limiting sense. Further, it is intended that this invention is not to be limited to Digital Audio Music and can include Digital Video, Digital Commercials, and other applications of digital information.

ENGLISH-CLAIMS:

[Return to Top of Patent](#)

I claim:

1. A method for transmitting a desired digital audio signal stored on a first memory of a first party to a second memory of a second party comprising the steps of:

transferring money electronically via a telecommunication lien to the first party at a location remote from the second memory and controlling use of the first memory from the second party financially distinct from the first party, said second party controlling use and in possession of the second memory;

connecting electronically via a telecommunications line the first memory with the second memory such that the desired digital audio signal can pass therebetween;

transmitting the desired digital audio signal from the first memory with a transmitter in control and possession of the first party to a receiver having the second memory at a location determined by the second party, said receiver in possession and control of the second party; and

storing the digital signal in the second memory.

2. A method as described in claim 1 including after the transferring step, the steps of

searching the first memory for the desired digital audio signal; and selecting the desired digital audio signal from the first memory.

3. A method as described in claim 2 wherein the transferring step includes the steps of telephoning the first party controlling use of the first memory by the second party; providing a credit card number of the second party controlling the second memory to the first party controlling the first memory so the second party is charged money.

4. A method for transmitting a desired digital video signal stored on a first memory of a first party to a second memory of a second party comprising the steps of:

transferring money electronically via a telecommunications line to the first party at a location remote from the second memory and controlling use of the first memory, from a second party financially distinct from the first party, said second party in control and in possession of the second memory;

connecting electronically via a telecommunications line the first memory with the second memory such that the desired digital video signal can pass therebetween;

transmitting the desired digital video signal from the first memory with a transmitter in control and possession of the first party to a receiver having the second memory at a location determined by the second party, said receiver in possession and control of the second party; and

storing the digital signal in the second memory.

5. A method as described in claim 4 including after the transferring money step, the step of searching the first memory for the desired digital signal and selecting the desired digital signal from the first memory.

6. A method as described in claim 5 wherein the transferring step includes the steps of telephoning the first party controlling use of the first memory by the second party controlling the second memory; providing a credit card number of the second party controlling the second memory to the first party controlling the first memory so the second party controlling the second memory is charged money.

Source: [Command Searching](#) > [Utility, Design and Plant Patents](#)

Terms: **patno=5191573** ([Edit Search](#) | [Suggest Terms for My Search](#))

View: **Custom**

Segments: Abst, Appl-no, Applicants-ref, Assign-type, Assignee, Assignee-iiid, Assigneeaftissue, Assigneeatissue, Assigneepreissue, Asst-exmr, Cert-correction, Cl, Claims, Date, Desig-ext-states, Desig-states, Detdesc, Disclaimer-date, Drwdesc, English-abst, English-claims, English-title, Epo-bul-issue, Exmpl-claim, Exmpl-figure, Exmr, Expir-comment, Expiration, Expiration-date, Filed, Filed-date, Filing-lang, First-pub-date, First-publish, French-abst, French-claims, French-title, German-abst, German-claims, German-title, Govt-interest, Granted-date, Hist-pub, Int-cl, Inv-country, Inv-postal-code, Inv-state, Inventor, Ipc-addl-cl, Ipc-addl-info, Ipc-main-cl, Language, Lapse, Lapse-country, Legal-rep, Legal-status, Lit-reex, No-drwng-pp, No-of-claims, No-of-figures, Non-obl-supp-cl, Nonpatliterature, Number, Opposition, Other-rights, Parent-pat-info, Patno, Pct-appl-no, Pct-filed-date, Pct-pub-date, Pct-pub-pat-no, Prim-exmr, Priority, Priority-country, Priority-number, Proc-lang, Pub-country, Pub-lang, Pub-type, Publication, Reexam-cert, Reexam-litigate, Ref-cited, Ref-cl, Ref-country, Ref-date, Ref-name, Ref-patno, Reissue, Reissue-comment, Rel-appl-date, Rel-data, Rel-grant-date, Rel-patno, Rep-iiid, Search-fld, Search-pub-date, Search-publish, Second-pub-date, Second-publish, Sect-102-e-date, Sect-371-date, Spanish-abst, Spanish-claims, Spanish-title, Spec, Summary, Third-pub-date, Third-publish, Title, Us-addl-cl, Us-main-cl

Date/Time: Friday, April 14, 2006 - 1:49 PM EDT



LexisNexis

[About LexisNexis](#) | [Terms & Conditions](#)

Copyright © 2006 LexisNexis, a division of Reed Elsevier Inc. All rights reserved.

LexisNexis® Total Research System

[Switch Client](#) | [Preferences](#) | [Feedback](#) | [Sign Off](#) | [Help](#)

[My Lexis™](#) | [Search](#) | [Research Tasks](#) | [Search Advisor](#) | [Get a Document](#) | [Shepard's®](#) | [Alerts](#) | [History](#) | [Sources](#) | [Guided Search Forms](#) | [Command Searching](#)

[Command Searching](#) > Patent Cases from Federal Courts and Administrative Materials

Enter Search Terms

[Search](#)

Terms and Connectors Natural Language Easy Search

5191573 or 5,191,573

[Suggest Terms for My Search](#)

[Search](#)

[Check Spelling](#)

Use conn between : connector connector

Syntax
and
or
w/N
not w/N
pre./N
w/p
not w/p
w/seg
not w/seg
w/s
not w/s
and not

Restrict by Segment:

Select a segment, enter search terms for the segment, then click Add.

Select a Segment [Add](#)

Note: Segment availability differs between sources. Segments may not be applied consistently across sources.

Restrict by Date:

No Date Restrictions From To [Date Formats...](#)

[My Lexis™](#) | [Search](#) | [Research Tasks](#) | [Search Advisor](#) | [Get a Document](#) | [Shepard's®](#) | [Alerts](#) | [History](#) | [Delivery Manager](#) | [Switch Client](#) | [Preferences](#) | [Feedback](#) | [Sign Off](#) | [Help](#)

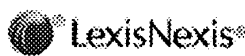



[About LexisNexis](#) | [Terms & Conditions](#)

Copyright © 2006 LexisNexis, a division of Reed Elsevier Inc. All rights reserved.

Source: [Command Searching](#) > **Patent Cases from Federal Courts and Administrative Materials** 
 Terms: **5191573 or 5,191,573** ([Edit Search](#) | [Suggest Terms for My Search](#))

 Select for FOCUS™ or Delivery

-   1. [Sightsound.com, Inc. v. N2K, Inc.](#), Civil Action No. 98-0118 , UNITED STATES DISTRICT COURT FOR THE WESTERN DISTRICT OF PENNSYLVANIA , 391 F. Supp. 2d 321; 2003 U.S. Dist. LEXIS 25503, October 23, 2003, Decided

OVERVIEW: Defendant was denied summary judgment on claims of patent invalidity; earlier patent described only "possibility" of use of unit in way that anticipated use of patent-in-suit, not the required "necessity," and fact question existed as to obviousness.

CORE TERMS: patent, digital, signal, invention, music, summary judgment, license, audio, sightsound, consumer ...

... United States Patent No. **5,191,573** ("the '573 Patent") to Mr. ...

-   2. [Sightsound.com Inc. v. N2k, Inc.](#), Civil Action No. 98-118 , UNITED STATES DISTRICT COURT FOR THE WESTERN DISTRICT OF PENNSYLVANIA , 185 F. Supp. 2d 445; 2002 U.S. Dist. LEXIS 6828, February 8, 2002, Decided

OVERVIEW: In an action involving patents which were directed to commercially-acceptable systems and methods for selling music and video in digital form over telecommunications lines, the judge made several recommendations regarding claim construction.







CORE TERMS: digital, patent, memory, signal, telecommunication, audio, electronically, specification, desired, telephone ...

... S. Patent Nos. **5,191,573** ("the '573 Patent"), 5,675,734 ("the ' ...

Source: [Command Searching](#) > **Patent Cases from Federal Courts and Administrative Materials** 
 Terms: **5191573 or 5,191,573** ([Edit Search](#) | [Suggest Terms for My Search](#))
 View: Cite

Date/Time: Friday, April 14, 2006 - 2:13 PM EDT

* Signal Legend:

-  - Warning: Negative treatment is indicated
-  - Questioned: Validity questioned by citing refs
-  - Caution: Possible negative treatment
-  - Positive treatment is indicated
-  - Citing Refs. With Analysis Available
-  - Citation information available

* Click on any *Shepard's* signal to *Shepardize*® that case.

LexisNexis® Total Research System

[Switch Client](#) | [Preferences](#) | [Feedback](#) | [Sign Off](#) | [Help](#)

[My Lexis™](#) | [Search](#) | [Research Tasks](#) | [Search Advisor](#) | [Get a Document](#) | [Shepard's®](#) | [Alerts](#) | [History](#) | [Sources](#) | [Guided Search Forms](#) | [Command Searching](#)

Command Searching > Patent, Trademark & Copyright Periodicals, Combined

Enter Search Terms

Terms and Connectors Natural Language Easy Search

5191573 or 5,191,573

[Suggest Terms for My Search](#)

[Search](#)

[Check Spelling](#)

Search

Use conn between : connector connector

Syntax
and
or
w/N
not w/N
pre./N
w/p
not w/p
w/seg
not w/seg
w/s
not w/s
and not

Restrict by Segment:

Select a segment, enter search terms for the segment, then click Add.

Select a Segment [v] [] [Add](#) [↑]

Note: Segment availability differs between sources. Segments may not be applied consistently across sources.

Restrict by Date:

No Date Restrictions [v] From [] To [] [Date Formats...](#)

[My Lexis™](#) | [Search](#) | [Research Tasks](#) | [Search Advisor](#) | [Get a Document](#) | [Shepard's®](#) | [Alerts](#) | [History](#) | [Delivery Manager](#) | [Switch Client](#) | [Preferences](#) | [Feedback](#) | [Sign Off](#) | [Help](#)



LexisNexis®

[About LexisNexis](#) | [Terms & Conditions](#)

Copyright © 2006 LexisNexis, a division of Reed Elsevier Inc. All rights reserved.

No Documents Found!

No documents were found for your search terms
"5191573 or 5,191,573"

Click "Save this search as an Alert" to schedule your search to run in the future.

- OR -

Click "Edit Search" to return to the search form and modify your search.

Suggestions:

- Check for spelling errors.
- Remove some search terms.
- Use more common search terms, such as those listed in "Suggested Words and Concepts"
- Use a less restrictive date range.

Save this Search as an Alert

Edit Search



[About LexisNexis](#) | [Terms & Conditions](#)

Copyright © 2006 LexisNexis, a division of Reed Elsevier Inc. All rights reserved.

LexisNexis® Total Research System

[Switch Client](#) | [Preferences](#) | [Feedback](#) | [Sign Off](#) | [Help](#)

[My Lexis™](#) | [Search](#) | [Research Tasks](#) | [Search Advisor](#) | [Get a Document](#) | [Shepard's®](#) | [Alerts](#) | [History](#) | [Sources](#) | [Guided Search Forms](#) | [Command Searching](#)

[Command Searching > News, All \(English, Full Text\)](#)

Enter Search Terms

Terms and Connectors Natural Language Easy Search

5191573 or 5,191,573 [Suggest Terms for My Search](#) [Search](#) [Check Spelling](#)

Search

Use conn between : connector connector

Syntax
and
or
w/N
not w/N
pre./N
w/p
not w/p
w/seg
not w/seg
w/s
not w/s
and not

Restrict by Segment:

Select a segment, enter search terms for the segment, then click Add.

Select a Segment [Add](#)

Note: Segment availability differs between sources. Segments may not be applied consistently across sources.

Restrict by Date:

No Date Restrictions From To [Date Formats...](#)

[My Lexis™](#) | [Search](#) | [Research Tasks](#) | [Search Advisor](#) | [Get a Document](#) | [Shepard's®](#) | [Alerts](#) | [History](#) | [Delivery Manager](#) | [Switch Client](#) | [Preferences](#) | [Feedback](#) | [Sign Off](#) | [Help](#)



LexisNexis®

[About LexisNexis](#) | [Terms & Conditions](#)

Copyright © 2006 LexisNexis, a division of Reed Elsevier Inc. All rights reserved.

Source: [Command Searching > News, All \(English, Full Text\)](#) 
 Terms: **5191573** or **5,191,573** ([Edit Search](#) | [Suggest Terms for My Search](#))

 Select for FOCUS™ or Delivery

- 1. [Intellectual Property Today](#), April, 2004, INTERNETINFO.COLUMN; Pg. 49, 718 words, Will the Price of Music Downloads Include Patent License Fees?, BY W. SCOTT PETTY; Scott Petty, a Patent Attorney with King & Spalding, focuses on intellectual property issues for computer software, telecommunications and e-commerce companies. Scott can be contacted by telephone at 404.572.2888 or via e-mail at spetty@kslaw.com.
... U.S. Patent Nos. **5,191,573** and 5,675,734, which date back to ...
- 2. [Rutgers Computer & Technology Law Journal](#), March 22, 2002, No. 1, Vol. 28; Pg. 61; ISSN: 0735-8938, 24588 words, The multiple unconstitutionality of business method patents: common sense, congressional consideration, and constitutional history., Pollack, Malla
... U.S. Patent No. **5,191,573** (issued Mar. 2 ...
- 3. [Canadian Press Newswire](#), September 4, 2001, S 4'01, 5191573, 81 words, Trio of alleged drug-smugglers from Montreal elect trial by judge alone
- 4. [Canadian Press Newswire](#), September 4, 2001, S 4'01, 5191573, 81 words, Trio of alleged drug-smugglers from Montreal elect trial by judge alone (Record in progress)
- 5. [The Toronto Sun](#), May 19, 2000, Friday,, Final EDITION, NEWS,, Pg. 32, 174 words, KILLER INSULTS VICTIM'S KIN, ALAN CAIRNS, TORONTO SUN, BARRIE
- 6. [The National Law Journal](#), November 22, 1999, Monday, PATENT LAW; Pg. B9, 2106 words, Business methods, Bradley C. Wright; Mr. Wright is a shareholder and registered patent attorney at Washington, D.C.'s Banner & Witcoff Ltd. He can be reached at wright@bannerwitcoff.com.
... method (Patent No. **5,191,573**, titled "Method for ...
- 7. [Mondaq Business Briefing - Hale and Dorr LLP, US](#), November 3, 1999, 02275027, 2096 words, US: Business Methods Patents - The Effects Of State Street On Electronic Commerce And The Internet, Alter, Scott M
... 7. Patent number **5,191,573** and 5,675,734 ...
- 8. [The National Law Journal](#), October 25, 1999, Monday, INTELLECTUAL PROPERTY; Focus on Patent; Pg. C8, 2014 words, 'State Street' sets stage for new patents, battles, BY SCOTT M. ALTER, SPECIAL TO THE NATIONAL LAW JOURNAL; Mr. Alter is a partner in the Washington, D.C., office of Boston's Hale and Dorr L.L.P.
... n6 Patent nos. **5,191,573** and 5,675,734. Sightsound.com has been ...
- 9. [The Computer Lawyer](#), October, 1999, PATENT; Vol. 16, No. 10; Pg. 3, 11742 words, What the General Intellectual Property Practitioner Should Know about Patenting Business Methods, by David L. Hayes; David L. Hayes is a partner and is Chairman of the Intellectual Property Practice Group at Fenwick & West in Palo Alto. CA. Copyright © 1999 Fenwick & West LLP.
... terms of the matched coupons. **5,191,573** Title: "Method for ...
... US Pat. No. **5,191,573** described above. Enforcement: ...
... Sightsound.com asserted this and the **5,191,573** patent above against ...

- 10. [Salon.com](#), March 9, 1999 Tuesday, Feature, 2469 words, How can they patent that?, By Peter Wayner
... eyes. Or consider patents **5191573** and 5675734, created by ...
... N2K, is evaluating what patents **5191573** and 5675734 mean to his company's ...

Source: [Command Searching > News, All \(English, Full Text\)](#)

Terms: **5191573** or **5,191,573** ([Edit Search](#) | [Suggest Terms for My Search](#))

View: [Cite](#)

Date/Time: Friday, April 14, 2006 - 2:16 PM EDT



[About LexisNexis](#) | [Terms & Conditions](#)

[Copyright ©](#) 2006 LexisNexis, a division of Reed Elsevier Inc. All rights reserved.

PTOL-413A (09-04)
 Approved for use through 07/31/2008. OMB 0651-0031
 U.S. Patent and Trademark Office: U.S. DEPARTMENT OF COMMERCE

Applicant Initiated Interview Request Form

Application No.: 90,007,402; 90/007,403; 90/007,407
 First Named Applicant: Arthur Hair
 Examiner: Benjamin Lanier Art Unit: _____ Status of Application: Reexamination

Tentative Participants:
 (1) Kenneth Glick (2) James DiGiorgio Michael R. Casey
 (3) Robert Koons (4) Examiner Lanier

Proposed Date of Interview: April 19, 2006 Proposed Time: 2:00PM (AM/PM)

Type of Interview Requested:
 (1) Telephonic (2) Personal (3) Video Conference

Exhibit To Be Shown or Demonstrated: YES NO
 If yes, provide brief description: _____

Issues To Be Discussed

Issues (Rej., Obj., etc)	Claims/ Fig. #s	Prior Art	Discussed	Agreed	Not Agreed
(1) <u>Allowed</u>	<u>69-71</u> <u>77-79</u> <u>65-68</u>	<u>N/A</u>	<input type="checkbox"/>	<input type="checkbox"/>	<input type="checkbox"/>
(2) <u>Obj.</u>	<u>73-76</u>	<u>N/A</u>	<input type="checkbox"/>	<input type="checkbox"/>	<input type="checkbox"/>
(3) <u>Rej.</u>	<u>All</u> <u>New</u>	<u>All</u>	<input type="checkbox"/>	<input type="checkbox"/>	<input type="checkbox"/>
(4) <u>Proposed</u> <input type="checkbox"/> Continuation Sheet Attached	<u>Claims</u>	_____	<input type="checkbox"/>	<input type="checkbox"/>	<input type="checkbox"/>

Brief Description of Arguments to be Presented:
See attached

An interview was conducted on the above-identified application on 4/19/06.
NOTE: This form should be completed by applicant and submitted to the examiner in advance of the interview (see MPEP § 713.01).
 This application will not be delayed from issue because of applicant's failure to submit a written record of this interview. Therefore, applicant is advised to file a statement of the substance of this interview (37 CFR 1.133(b)) as soon as possible.

 Applicant's Representative Signature
Robert A. Koons, Jr.
 Typed/Printed Name of Applicant or Representative

 Examiner/SPE Signature

 32,474
 Registration Number, if applicable

This collection of information is required by 37 CFR 1.133. The information is required to obtain or retain a benefit by the public which is to file (and by the USPTO to process) an application. Confidentiality is governed by 35 U.S.C. 122 and 37 CFR 1.11 and 1.14. This collection is estimated to take 21 minutes to complete, including gathering, preparing, and submitting the completed application form to the USPTO. Time will vary depending upon the individual case. Any comments on the amount of time you require to complete this form and/or suggestions for reducing this burden, should be sent to the Chief Information Officer, U.S. Patent and Trademark Office, U.S. Department of Commerce, P.O. Box 1450, Alexandria, VA 22313-1450. DO NOT SEND FEES OR COMPLETED FORMS TO THIS ADDRESS. SEND TO: Commissioner for Patents, P.O. Box 1450, Alexandria, VA 22313-1450.

If you need assistance in completing the form, call 1-800-PTO-9199 and select option 2.



UNITED STATES PATENT AND TRADEMARK OFFICE

UNITED STATES DEPARTMENT OF COMMERCE
United States Patent and Trademark Office
Address: COMMISSIONER FOR PATENTS
P.O. Box 1450
Alexandria, Virginia 22313-1450
www.uspto.gov

APPLICATION NO.	FILING DATE	FIRST NAMED INVENTOR	ATTORNEY DOCKET NO.	CONFIRMATION NO.
-----------------	-------------	----------------------	---------------------	------------------

90/007,407	01/31/2005	5966440	NAPSP003	4782
------------	------------	---------	----------	------

23973 7590 04/21/2006

DRINKER BIDDLE & REATH
ATTN: INTELLECTUAL PROPERTY GROUP
ONE LOGAN SQUARE
18TH AND CHERRY STREETS
PHILADELPHIA, PA 19103-6996

EXAMINER

ART UNIT	PAPER NUMBER
----------	--------------

DATE MAILED: 04/21/2006

Please find below and/or attached an Office communication concerning this application or proceeding.



UNITED STATES PATENT AND TRADEMARK OFFICE

Commissioner for Patents
United States Patent and Trademark Office
P.O. Box 1450
Alexandria, VA 22313-1450
www.uspto.gov

DO NOT USE IN PALM PRINTER

(THIRD PARTY REQUESTER'S CORRESPONDENCE ADDRESS)

Albert S. Penilla
MARTINE PENILLA & GENCARELLA, LLP
710 Lakeway Drive, Suite 200
Sunnyvale, CA 94085

EX PARTE REEXAMINATION COMMUNICATION TRANSMITTAL FORM

REEXAMINATION CONTROL NO. 90/007,407.

PATENT NO. 5966440.

ART UNIT 2132.

Enclosed is a copy of the latest communication from the United States Patent and Trademark Office in the above identified *ex parte* reexamination proceeding (37 CFR 1.550(f)).

Where this copy is supplied after the reply by requester, 37 CFR 1.535, or the time for filing a reply has passed, no submission on behalf of the *ex parte* reexamination requester will be acknowledged or considered (37 CFR 1.550(g)).

PTOL-465 (Rev. 07-04)

Copied from 90007407 on 05/24/2006

Ex Parte Reexamination Interview Summary	Control No.	Patent Under Reexamination	
	90/007,407	5966440	
	Examiner	Art Unit	
	Benjamin E. Lanier	2132	

All participants (USPTO personnel, patent owner, patent owner's representative):

- (1) Benjamin E. Lanier (3) Robert Koons
(2) Kenneth Glick (4) Michael R. Casey

Date of Interview: 19 April 2006

Type: a) Telephonic b) Video Conference
c) Personal (copy given to: 1) patent owner 2) patent owner's representative)

Exhibit shown or demonstration conducted: d) Yes e) No.
If Yes, brief description: _____

Agreement with respect to the claims f) was reached. g) was not reached. h) N/A.
Any other agreement(s) are set forth below under "Description of the general nature of what was agreed to..."

Claim(s) discussed: 1, 64, 65 and 69.

Identification of prior art discussed: Mr. Koons discussed the claim limitations that were previously indicated as allowable and asked Examiner to explain the rationale behind the indication of allowability. Examiner provided rationale for the indication and Mr. Koons discusses possible amending the claims to include the allowable subject matter.

Description of the general nature of what was agreed to if an agreement was reached, or any other comments:

(A fuller description, if necessary, and a copy of the amendments which the examiner agreed would render the claims patentable, if available, must be attached. Also, where no copy of the amendments that would render the claims patentable is available, a summary thereof must be attached.)

A FORMAL WRITTEN RESPONSE TO THE LAST OFFICE ACTION MUST INCLUDE PATENT OWNER'S STATEMENT OF THE SUBSTANCE OF THE INTERVIEW. (See MPEP § 2281). IF A RESPONSE TO THE LAST OFFICE ACTION HAS ALREADY BEEN FILED, THEN PATENT OWNER IS GIVEN **ONE MONTH** FROM THIS INTERVIEW DATE TO PROVIDE THE MANDATORY STATEMENT OF THE SUBSTANCE OF THE INTERVIEW (37 CFR 1.560(b)). THE REQUIREMENT FOR PATENT OWNER'S STATEMENT CAN NOT BE WAIVED. **EXTENSIONS OF TIME ARE GOVERNED BY 37 CFR 1.550(c).**

cc: Requester (if third party requester)

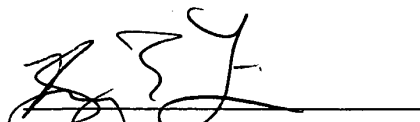
Examiner's signature, if required



UNITED STATES PATENT AND TRADEMARK OFFICE

Commissioner for Patents
United States Patent and Trademark Office
P.O. Box 1450
Alexandria, VA 22313-1450
www.uspto.gov

DRINKER BIDDLE & REATH :
Attn: INTELLECTUAL PROPERTY GROUP : (For Patent Owner)
One Logan Square :
18th and Cherry Streets :
Philadelphia, PA 19103-6996 :

MAILED

MAY 15 2006

REEXAM UNIT

Albert S. Panilla :
MARTINE PENILLA & GENCARELLA, LLP : (For Requester)
710 Lakeway Drive, Suite 200 :
Sunnyvale, CA 94085 :

: DECISION, *SUA SPONTE*,
: TO VACATE
: REEXAMINATION OFFICE
: ACTION

In re Arthur R. Hair :
Ex Parte Reexamination Proceeding :
Control No. 90/007,402 :
Filed: January 31, 2005 :
For: US Patent No. 5,191,573 :

The above captioned reexamination is before the Central Reexamination Unit for Consideration, *sua sponte*, whether to vacate the Office action made Final dated March 20, 2006.

REVIEW OF FACTS

1. U. S. Patent No. 5,191,573 issued on March 2, 1993.
2. A request was filed by a third party requester for reexamination of US Patent No. 5,191,573 on January 31, 2005.
3. The Order granting reexamination is dated March 18, 2005.

4. Non-final Office actions were mailed on June 21, 2005 and October 26, 2005 respectively.
6. A final Office action was mailed on March 20, 2006.

DISCUSSION REGARDING VACATING THE FINAL ACTION

MPEP 2271 is directed to final Office actions in *ex parte* reexamination proceedings and states as follows:

Before a final action is in order, a clear issue should be developed between the examiner and the patent owner. To bring the prosecution to a speedy conclusion and at the same time deal justly with the patent owner and the public, the examiner will twice provide the patent owner with such information and references as may be useful in defining the position of the Office as to unpatentability before the action is made final. Initially, the decision ordering reexamination of the patent will contain an identification of the new questions of patentability that the examiner considers to be raised by the prior art considered. In addition, the first Office action will reflect the consideration of any arguments and/or amendments contained in the request, the owner's statement filed pursuant to 37 CFR 1.530, and any reply thereto by the requester, and should fully apply all relevant grounds of rejection to the claims.

...

In making the final rejection, all outstanding grounds of rejection of record should be carefully reviewed and any grounds or rejection relied on should be reiterated. The grounds of rejection must (in the final rejection) be clearly developed to such an extent that the patent owner may readily judge the advisability of an appeal. However, where a single previous Office action contains a complete statement of a ground of rejection, the final rejection may refer to such a statement and also should include a rebuttal of any arguments raised in the patent owner's response.

DECISION TO VACATE THE FINAL OFFICE ACTION

All pending reexamination proceedings which remained assigned to the USPTO Technology Centers were transferred from the USPTO Technology Centers into the Central Reexamination Unit (CRU) by May 2006.

As a result of the reassignment of the present proceeding to the CRU, and the facts specific to this proceeding, the Office is vacating the final Office action mailed on March 20, 2006 to permit a CRU panel review and further analysis of the issues. The newly assigned CRU examiner in charge will, in conjunction with a panel review, issue a new Office action.

The patent owner is relieved of the requirement to respond to the final Office action mailed on March 20, 2006, in view of that Office action being vacated.

CONCLUSION

1. By way of instant decision, the Office action mailed in reexamination proceeding 90/007,402 mailed March 20, 2006 is hereby *sua sponte* **vacated**.
2. Jurisdiction over the present proceeding is now forwarded to the newly assigned CRU examiner who is directed to issue a new Office action in due course.
3. No response is required on the part of the Patent Owner, either to the decision or the final Office action mailed on March 20, 2006, which has now been vacated.
4. Correspondence may be submitted as follows:

By Mail to: Mail Stop *Ex Parte* Reexam
Central Reexamination Unit
Commissioner for Patents
United States Patent & Trademark Office
P. O. Box 1450
Alexandria, VA 22313-1450

By Fax to: (571) 273-9900
Central Reexamination Unit

By Hand: Customer Service Window
Randolph Building
401 Dulany Street
Alexandria, VA 22314

5. Telephone inquiries with regard to this decision should be directed to Mark Reinhart, Special Program Examiner in the Central Reexamination Unit, Art Unit 3992, at (571) 272-1611

M. Reinhart SPRF-CRU-3992 for
Lissi M. Marquis,
Director,
Central Reexamination Unit

5/9/06



05/16/06

IN THE UNITED STATES PATENT AND TRADEMARK OFFICE

In re Application of:)	
)	
ARTHUR R. HAIR)	
)	
Reexamination Control No. 90/007,402)	
)	
Reexamination Filed: January 31, 2005)	METHOD FOR TRANSMITTING
)	A DESIRED DIGITAL VIDEO OR
Patent Number: 5,191,573)	AUDIO SIGNAL
)	
Examiner: Roland G. Foster)	

Mail Stop *Ex Parte* Reexamination
 Commissioner for Patents
 P.O. Box 1450
 Alexandria, VA 22313-1450

Sir:

STATEMENT UNDER 37 C.F.R. §1.560(b)

At the Interview with Examiner Lanier on April 19, 2006, in Reexamination Control Nos. 90/007,402, 90/007,403 and 90/007,407, Applicant’s counsel presented the following reasons as warranting favorable action in the pending Reexamination applications:

1. The rejections of the pending claims in all three Reexaminations under Section 103 are improper and should be withdrawn because the multiple references cited against those claims are not properly combinable, for all the reasons set forth in Applicant’s response to the second office actions filed on December 27, 2005. For the same reasons, the objections to claims in Reexamination Control No. 90/007,407 also are improper.

2. In Reexamination Control No. 90/007,407, if Applicant were to add claims having limitations directed to specific types of tagging, those claims should be allowable to the extent such types of tagging are not shown or suggested by the prior art; and
3. Further in Reexamination Control No. 90/007,407, if Applicant were to add claims having a limitation directed to executing a command on audio or video signals stored in the second memory of Applicant's invention, those claims should be allowable to the extent the execution of such a command is not shown or suggested by the prior art.

Respectfully submitted,

DRINKER BIDDLE & REATH LLP

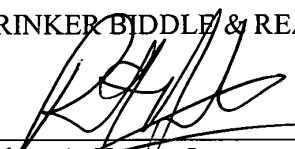

Robert A. Koons, Jr.
Registration No. 32,474

DRINKER BIDDLE & REATH LLP
One Logan Square
18th & Cherry Streets
Philadelphia, PA 19103-6996
Telephone: (215) 988-3392
Facsimile: (215) 988-2757

CERTIFICATE OF MAILING BY "EXPRESS MAIL" (37 CFR 1.10)		Docket No.	
Applicant(s): Arthur R. Hair		NAPS001	

Application No. 90/007,402	Filing Date January 31, 2005	Examiner Roland G. Foster	Customer No. 023973	Group Art Unit
--------------------------------------	--	-------------------------------------	-------------------------------	----------------

Invention: **METHOD FOR TRANSMITTING A DESIRED DIGITAL VIDEO OR AUDIO SIGNAL**

I hereby certify that the following correspondence:

Statement Under 37 C.F.R. Section 1.560(b); Post Card

(Identify type of correspondence)

is being deposited with the United States Postal Service "Express Mail Post Office to Addressee" service under 37 CFR 1.10 in an envelope addressed to: Commissioner for Patents, P.O. Box 1450, Alexandria, VA 22313-1450 on

May 16, 2006

(Date)

Lisa Richardson

(Typed or Printed Name of Person Mailing Correspondence)

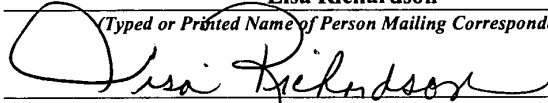

(Signature of Person Mailing Correspondence)

EV299884565US

("Express Mail" Mailing Label Number)

Note: Each paper must have its own certificate of mailing.

Drinker Biddle & Reath LLP
One Logan Square
18th & Cherry Streets
Philadelphia, PA 19103

CERTIFICATE OF SERVICE

The undersigned hereby certifies that a true and correct copy of the foregoing document was served via First Class United States Mail, postage prepaid, this 16th day of May, 2006, on the following:

Mr. Albert S. Penilla
Martine, Penilla, & Gencarella, LLP
710 Lakeway Drive, Suite 200
Sunnyvale, CA 94085
Attorney for Third Party Reexamination Requester

By: _____

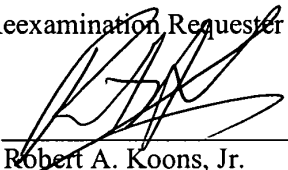
Robert A. Koons, Jr.
Attorney for Patentee

05-25-06

ReExam
F

M2



IN THE UNITED STATES PATENT AND TRADEMARK OFFICE

In re Application of:)
)
ARTHUR R. HAIR)
)
Reexamination Control No. 90/007,402)
)
Reexamination Filed: January 31, 2005) METHOD FOR TRANSMITTING
) A DESIRED DIGITAL VIDEO OR
Patent Number: 5,191,573) DIGITAL AUDIO SIGNALS
)
Examiner: Roland G. Foster)

Mail Stop Petitions
Commissioner for Patents
P.O. Box 1450
Alexandria, VA 22313-1450

Sir:

PETITION UNDER 37 C.F.R. §1.137(b)

On July 13, 2005, then counsel of record for Patentee, Ansel M. Schwartz, conducted an in person Interview with the then examiner of record, Examiner Benjamin Lanier, in Reexamination Control Nos. 90/007,402, 90/007,403 and 90/007,407. Following the Interview, Mr. Schwartz did not file a formal Summary of Interview pursuant to 37 C.F.R. § 1.560(b). Current counsel of record for Patentee now submits the Summary of Interview along with the required fee under 37 C.F.R. § 1.137(b), and hereby respectfully petitions, as provided by 37 C.F.R. § 1.550(e)(2), to have the Office accept the Summary of Interview as having been unintentionally delayed after the period provided under 37 C.F.R. § 1.560(b).

In support of the instant Petition, current counsel of record for Patentee, after having made reasonable inquiry, hereby states that the entire delay in filing the Summary of Interview was unintentional.

Respectfully submitted,

DRINKER, BIDDLE & REATH LLP



Robert A. Koons, Jr.

Registration No. 32,474

DRINKER BIDDLE & REATH LLP

One Logan Square

18th & Cherry Streets

Philadelphia, PA 19103-6996

Telephone: (215) 988-3392

Facsimile: (215) 988-2757



IN THE UNITED STATES PATENT AND TRADEMARK OFFICE

In re Application of:)
)
 ARTHUR R. HAIR)
)
 Reexamination Control No. 90/007,402)
)
 Reexamination Filed: January 31, 2005) METHOD FOR TRANSMITTING
) A DESIRED DIGITAL VIDEO OR
 Patent Number: 5,191,573) DIGITAL AUDIO SIGNALS
)
 Examiner: Roland G. Foster)

Mail Stop *Ex Parte* Reexamination
 Commissioner for Patents
 P.O. Box 1450
 Alexandria, VA 22313-1450

Sir:

STATEMENT UNDER 37 C.F.R. §1.560(b)

On July 13, 2005, then counsel of record for Patentee, Ansel M. Schwartz, conducted an in person Interview with the then examiner of record, Examiner Benjamin Lanier, in Reexamination Control Nos. 90/007,402, 90/007,403 and 90/007,407. Following the Interview, Mr. Schwartz did not file a formal Summary of Interview pursuant to 37 C.F.R. § 1.560(b), which summary is now submitted herewith. Mr. Schwartz, as former counsel of record for Patentee, hereby declares that the entire delay in filing the current Summary of Interview was unintentional, and submits the following statement concerning the reasons presented to Examiner Lanier as warranting favorable action in the pending Reexaminations.

1. Patentee stated that favorable action to Claim 11 of Reexam 90/007407, as well as all the active claims in Reexam 90/007407, Reexam 90/007403 and 90/007402 was warranted.

This is because neither of the references Freeny or Gallagher anticipated any of the claims, and in view of the secondary evidence of patentability presented, the claims were allowable.

Respectfully submitted,

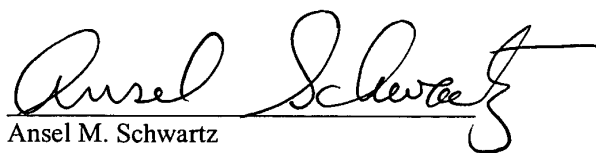
A handwritten signature in cursive script, reading "Ansel M. Schwartz". The signature is written in black ink and is positioned above a horizontal line.

Ansel M. Schwartz
Registration No. 30,587

**TRANSMITTAL LETTER
(General - Patent Pending)**

Docket No.
NAPSP001

In Re Application Of:

**Arthur R. Hair
Patent No. 5,191,573**

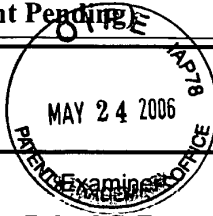

Application No.
90/007,402

Filing Date
01/31/2005

Roland G. Foster

Customer No.
23973

Group Art Unit

Confirmation No.
2998

Title: **Method for Transmitting a Desired Digital Video or Digital Audio Signals**

COMMISSIONER FOR PATENTS:

Transmitted herewith is:

**Petition Under 37 C.F.R. 1.137(b)
Statement Under 37 C.F.R. 1.560(b)
Check for \$1,500.00 (Petition Fee)
Post Card**

in the above identified application.

- No additional fee is required.
- A check in the amount of **\$1,500.00** is attached.
- The Director is hereby authorized to charge and credit Deposit Account No. **50-0573** as described below.
 - Charge the amount of
 - Credit any overpayment.
 - Charge any additional fee required.
- Payment by credit card. Form PTO-2038 is attached.

WARNING: Information on this form may become public. Credit card information should not be included on this form. Provide credit card information and authorization on PTO-2038.

Signature

**Robert A. Koons, Jr., Reg. No. 32,474
DRINKER BIDDLE & REATH LLP
One Logan Square
18th & Cherry Streets
Philadelphia, PA 19103-6996
Telephone (215) 988-3392
Facimile: (215) 988-2757**

Dated:

5/24/06

I hereby certify that this correspondence is being deposited with the United States Postal Service with sufficient postage as first class mail in an envelope addressed to the "Commissioner for Patents, P.O. Box 1450, Alexandria, VA 22313-1450" [37 CFR 1.8(a)] on

(Date)

Signature of Person Mailing Correspondence

Typed or Printed Name of Person Mailing Correspondence

CC:

CERTIFICATE OF MAILING BY "EXPRESS MAIL" (37 CFR 1.10)		Docket No.	
Applicant(s): Arthur R. Hair		NAPSP001	

Application No. 90/007,402	Filing Date 01/31/2005	Examiner Roland G. Foster	Customer No. 23973	Group Art Unit
--------------------------------------	----------------------------------	-------------------------------------	------------------------------	----------------

Invention: **Method for Transmitting a Desired Digital Video or Digital Audio Signals**

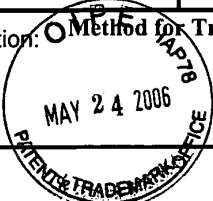

I hereby certify that the following correspondence:

Petition Under 37 C.F.R. 1.137(b), Statement Under 37 C.F.R. 1.560(b), Transmittal Letter, Check for \$1,500.00, Post Card.

(Identify type of correspondence)

is being deposited with the United States Postal Service "Express Mail Post Office to Addressee" service under 37 CFR 1.10 in an envelope addressed to: Commissioner for Patents, P.O. Box 1450, Alexandria, VA 22313-1450 on

May 24, 2006
(Date)

Lorraine T. Lewis
(Typed or Printed Name of Person Mailing Correspondence)
Lorraine T. Lewis
(Signature of Person Mailing Correspondence)

EV547110458US
("Express Mail" Mailing Label Number)

Note: Each paper must have its own certificate of mailing.

DRINKER BIDDLE & REATH LLP
One Logan Square
18th & Cherry Streets
Philadelphia, PA 19103-6996
Telephone (215) 988-3392
Facsimile: (215) 988-2757



CERTIFICATE OF SERVICE

The undersigned hereby certifies that a true and correct copy of the foregoing
Petition Under 37 C.F.R. § 1.137(b) with the attached Statement Under 37 C.F.R.
§ 1.560(b) was served, via First Class United States Mail, postage prepaid, this 24th day
of May, 2006, on the following:

Mr. Albert S. Penilla
Martine, Penilla, & Gencarella, LLP
710 Lakeway Drive, Suite 200
Sunnyvale, CA 94085
Attorney for Third Party Reexamination Requester

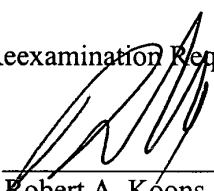
By: 
Robert A. Koons, Jr.
Attorney for Patentee



UNITED STATES PATENT AND TRADEMARK OFFICE

Commissioner for Patents
United States Patent and Trademark Office
P.O. Box 1450
Alexandria, VA 22313-1450
www.uspto.gov

THIRD PARTY REQUESTER'S CORRESPONDENCE ADDRESS

6/19/06

ALBERT S. PENILA
MARTINE PENILLA & GENCARELLA LLP
710 LAKEWAY DRIVE, SUITE 200
SUNNYVALE, CA 94085

***EX PARTE* REEXAMINATION COMMUNICATION TRANSMITTAL FORM**

REEXAMINATION CONTROL NO 90/007402
PATENT NO. 5,191,573
ART UNI 3993

Enclosed is a copy of the latest communication from the United States Patent and Trademark Office in the above identified ex parte reexamination proceeding (37 CFR 1.550(f)).

Where this copy is supplied after the reply by requester, 37 CFR 1.535, or the time for filing a reply has passed, no submission on behalf of the ex parte reexamination requester will be acknowledged or considered (37 CFR 1.550(g)).



UNITED STATES PATENT AND TRADEMARK OFFICE

UNITED STATES DEPARTMENT OF COMMERCE
United States Patent and Trademark Office
Address: COMMISSIONER FOR PATENTS
P.O. Box 1450
Alexandria, Virginia 22313-1450
www.uspto.gov

APPLICATION NO.	FILING DATE	FIRST NAMED INVENTOR	ATTORNEY DOCKET NO.	CONFIRMATION NO.
90/007,402	01/31/2005	5191573	NAPS001	2998

23973 7590 06/19/2006

DRINKER BIDDLE & REATH
ATTN: INTELLECTUAL PROPERTY GROUP
ONE LOGAN SQUARE
18TH AND CHERRY STREETS
PHILADELPHIA, PA 19103-6996

EXAMINER

ART UNIT PAPER NUMBER

DATE MAILED: 06/19/2006

Please find below and/or attached an Office communication concerning this application or proceeding.



DRINKER, BIDDLE & REATH, LLP (For Patent Owner)
Attn: Intellectual Property Group
One Logan Square
18th and Cherry Streets
Philadelphia Pa 19103-6996

Albert S. Penilla (For Third Party Requester)
Martine, Penilla & Gencarcella, LLP
710 Lakeway Drive, Suite 200
Sunnyvale, CA 94085

MAILED
JUN 19 2006
CENTRAL REEXAMINATION UNIT

In re Reexamination Proceeding :
Arthur R. Hair :
Control No. 90/007,402 : DECISION GRANTING PETITION
Filed: January 31, 2005 :
U.S. Patent No. 5,191,573 :
Attorney Docket No. NAPSP001 :

This is a decision on the petition under 37 CFR 1.137(b) filed by the patent owner on May 24, 2006, for entry of late papers based upon unintentional delay.

The petition is before the Office of Patent Legal Administration (OPLA) for decision.

37 CFR 1.137(b) states:

“Unintentional. If the delay in reply by applicant or patent owner was unintentional, a petition may be filed pursuant to this paragraph to revive an abandoned application, a reexamination proceeding terminated under §§ 1.550(d) or 1.957(b) or (c), or a lapsed patent. A grantable petition pursuant to this paragraph must be accompanied by: (1) The reply required to the outstanding Office action or notice, unless previously filed; (2) The petition fee as set forth in § 1.17(m); (3) A statement that the entire delay in filing the required reply from the due date for the reply until the filing of a grantable petition pursuant to this paragraph was unintentional. The Director may require additional information where there is a question whether the delay was unintentional; and (4) Any terminal disclaimer (and fee as set forth in § 1.20(d)) required pursuant to paragraph (d) of this section.”

§ 1.560 Interviews in ex parte reexamination proceedings.

(a) Interviews in ex parte reexamination proceedings pending before the Office between examiners and the owners of such patents or their attorneys or agents of record must be conducted in the Office at such times, within Office hours, as the respective examiners may designate. Interviews will not be permitted at any other time or place without the authority of the Director. Interviews for the discussion of the patentability of claims in patents involved in ex parte reexamination proceedings will not be conducted prior to the first official



action. Interviews should be arranged in advance. Requests that reexamination requesters participate in interviews with examiners will not be granted.

(b) In every instance of an interview with an examiner in an ex parte reexamination proceeding, a complete written statement of the reasons presented at the interview as warranting favorable action must be filed by the patent owner. An interview does not remove the necessity for response to Office actions as specified in § 1.111. Patent owner's response to an outstanding Office action after the interview does not remove the necessity for filing the written statement. The written statement must be filed as a separate part of a response to an Office action outstanding at the time of the interview, or as a separate paper within one month from the date of the interview, whichever is later.

The present petition under 37 CFR 1.137(b) includes the requisite response (written statement)(item 1), a \$1500.00 petition fee under 37 CFR 1.17(m) (item 2) and the requisite statement (item 3).

The petition for entry of the late papers is granted.

Jurisdiction over the reexamination proceeding is being returned to Technology Center Art Unit 3992 for further examination and consideration of the written statement filed May 24, 2006, along with the present petition, in due course.

Any further communications as to the merits of the reexamination proceeding should be directed to the primary examiner, Roland Foster, in Technology Center Art Unit 3992, who can be reached at 571-272-7538.

Telephone inquiries related to this decision should be directed to Fred A. Silverberg at 571-272-7719.



Fred A. Silverberg

Senior Legal Advisor

Office of Patent Legal Administration

Office of the Deputy Commissioner for Patent Examination Policy



Conferee: Kenneth M. Schor



UNITED STATES PATENT AND TRADEMARK OFFICE

UNITED STATES DEPARTMENT OF COMMERCE
United States Patent and Trademark Office
Address: COMMISSIONER FOR PATENTS
P.O. Box 1450
Alexandria, Virginia 22313-1450
www.uspto.gov

APPLICATION NO.	FILING DATE	FIRST NAMED INVENTOR	ATTORNEY DOCKET NO.	CONFIRMATION NO.
90/007,402	01/31/2005	5191573	NAPS001	2998

23973 7590 09/29/2006

DRINKER BIDDLE & REATH
ATTN: INTELLECTUAL PROPERTY GROUP
ONE LOGAN SQUARE
18TH AND CHERRY STREETS
PHILADELPHIA, PA 19103-6996

EXAMINER

ART UNIT PAPER NUMBER

DATE MAILED: 09/29/2006

Please find below and/or attached an Office communication concerning this application or proceeding.



9/29/06

THIRD PARTY REQUESTER'S CORRESPONDENCE ADDRESS

ALBERT S. PENILA
MARTINE PENILLA & GENCARELLA LLP
710 LAKEWAY DRIVE, SUITE 200
SUNNYVALE, CA 94085

EX PARTE REEXAMINATION COMMUNICATION TRANSMITTAL FORM

REEXAMINATION CONTROL NO 90/007402
PATENT NO. 5,191,573
ART UNI 3992

Enclosed is a copy of the latest communication from the United States Patent and Trademark Office in the above identified ex parte reexamination proceeding (37 CFR 1.550(f)).

Where this copy is supplied after the reply by requester, 37 CFR 1.535, or the time for filing a reply has passed, no submission on behalf of the ex parte reexamination requester will be acknowledged or considered (37 CFR 1.550(g)).

Office Action in Ex Parte Reexamination	Control No. 90/007,402	Patent Under Reexamination 5191573	
	Examiner Roland G. Foster	Art Unit 3992	

-- The MAILING DATE of this communication appears on the cover sheet with the correspondence address --

- a Responsive to the communication(s) filed on 06 February 2006 . b This action is made FINAL.
c A statement under 37 CFR 1.530 has not been received from the patent owner.

A shortened statutory period for response to this action is set to expire 2 month(s) from the mailing date of this letter. Failure to respond within the period for response will result in termination of the proceeding and issuance of an *ex parte* reexamination certificate in accordance with this action. 37 CFR 1.550(d). **EXTENSIONS OF TIME ARE GOVERNED BY 37 CFR 1.550(c)**. If the period for response specified above is less than thirty (30) days, a response within the statutory minimum of thirty (30) days will be considered timely.

Part I THE FOLLOWING ATTACHMENT(S) ARE PART OF THIS ACTION:

1. Notice of References Cited by Examiner, PTO-892. 3. Interview Summary, PTO-474.
2. Information Disclosure Statement, PTO-1449. 4. _____.

Part II SUMMARY OF ACTION

- 1a. Claims 1-43 are subject to reexamination.
1b. Claims _____ are not subject to reexamination.
2. Claims _____ have been canceled in the present reexamination proceeding.
3. Claims _____ are patentable and/or confirmed.
4. Claims 1-43 are rejected.
5. Claims _____ are objected to.
6. The drawings, filed on _____ are acceptable.
7. The proposed drawing correction, filed on _____ has been (7a) approved (7b) disapproved.
8. Acknowledgment is made of the priority claim under 35 U.S.C. § 119(a)-(d) or (f).
a) All b) Some* c) None of the certified copies have
1 been received.
2 not been received.
3 been filed in Application No. _____.
4 been filed in reexamination Control No. _____.
5 been received by the International Bureau in PCT application No. _____.
* See the attached detailed Office action for a list of the certified copies not received.
9. Since the proceeding appears to be in condition for issuance of an *ex parte* reexamination certificate except for formal matters, prosecution as to the merits is closed in accordance with the practice under *Ex parte* Quayle, 1935 C.D. 11, 453 O.G. 213.
10. Other: _____

cc: Requester (if third party requester)

DETAILED ACTION

Response to Arguments

The Patent Owner submitted various responses to the Final Rejection, mailed on March 20, 2006, rejecting all claims of the instant U.S. Patent No. 5,191,573 patent under reexamination (the "'573 Patent").

Patent Owner arguments were considered, but deemed moot in view new issues concerning the earliest effective filing date of the '573 Patent, which as discussed below is September 18, 1990 (at the earliest) with respect to the original claims, and concerning 35 U.S.C. 112 issues with respect to the new claims. Thus, new grounds of rejection are set forth below.

Benefit of Earlier Filing Date Regarding Original Claims

As an initial matter, the instant '573 Patent and the earlier filed application are related as follows. The '573 Patent under reexamination issued from U.S. Application No. 07/586,391 (hereinafter the "Child Application"), which was filed on September 18, 1990. The parent (earlier filed) application to the Child Application is U.S. Application No. 07/206,497, filed on June 13, 1988 (hereinafter the "Parent Application"). All of the above applications are alleged to be related as "continuation" applications (i.e., no new matter was introduced, thus the applications allegedly share a common specification, see MPEP § 201.06(c).III).¹ However, the specification of the Child Application (issuing as the '573 Patent under reexamination) and the specification of the original Parent application are not common, as discussed below.

¹ Note that all the applications above were filed under the old "file wrapper continuation" procedures under 37 CFR 1.62, see MPEP § 201.06(a).

The prosecution history of the Child Application (issuing as the '573 Patent under reexamination) does not show that the examiner had reason to consider the propriety of the benefit (continuation) claim set forth in the patent. In addition, the prosecution history of the Child patent does not contain any substantive, written discussion between the applicant and the examiner regarding such a claim.

Intervening Patents and Printed Publications Are Available as Prior Art In a Reexamination Proceeding According to 35 U.S.C. 120

A rejection may be made in an *ex-parte* reexamination proceeding based on an intervening patent when the patent claims under reexamination, under 35 U.S.C. 120, are entitled only to the filing date of the patent under reexamination. Specifically:

Rejections may be made in reexamination proceedings based on intervening patents or printed publications where the patent claims under reexamination are entitled only to the filing date of the patent and are not supported by an earlier foreign or United States patent application whose filing date is claimed. For example, under 35 U.S.C. 120, the effective date of these claims would be the filing date of the application which resulted in the patent. Intervening patents or printed publications are available as prior art under *In re Ruscetta*, 255 F.2d 687, 118 USPQ 101 (CCPA 1958), and *In re van Langenhoven*, 458 F.2d 132, 173 USPQ 426 (CCPA 1972). See also MPEP § 201.11

MPEP § 2258.I.C, Scope of Reexamination (emphasis added).

As discussed above, 35 U.S.C. 120 applies to *ex-parte* reexamination procedure. To be entitled to benefit of an earlier filing date under 35 U.S.C. 120, the previously filed specification of the Parent Application must support the invention claimed in the Child Application. See 35 U.S.C. 120.

The Original Claims of the Child Patent Under Reexamination Lack Benefit to the Filing Date of the Original Parent Application Under 35 U.S.C. 120 Because the Original Parent Application Fails to Support Several Features Claimed in the Child Patent Under Reexamination

A review of the prosecution history reveals that a significant amount of new text (directed to various features) added in a series of amendments is not found in the original Parent Application. Consider the following Table I:

Art Unit: 3992

Table I. New Matter Chart

	Parent Appln. 07/206,497, filed 6/13/88 (Abandoned)		Child Appln. 07/586,391, filed 9/18/90 (5,191,573)	
Feature	Date First Appearing in Claims of Parent Appln.	Date First Appearing in Spec. of Parent Appln.	Date First Appearing in Claims of Child Appln.	Date First Appearing in Spec. of Child Appln.
Hard Disk/Control Unit of Seller/User	Filing Date of the Original Application – 6/13/88	Filing Date of the Original Application – 6/13/88		Filing Date of the Child Application – 9/18/90
Electronic sales and distribution of the music				
Broad Statement at end of spec. regarding Video Applicability, Note *		Filing Date of the Original Application – 6/13/88		Filing Date of the Child Application – 9/18/90
Transferring Money from Second Party to a First Party (Charging a Fee)	12/22/88 (2/28/90)		Filing Date of the Child Application – 9/18/90	12/11/91
Providing a Credit Card Number	12/22/88		Filing Date of the Child Application – 9/18/90	
Controlling Use of First/Second Memory	12/22/88		Filing Date of the Child Application – 9/18/90	12/11/91
Transmitting to a Location Determined by Second Party	2/28/90		Filing Date of the Child Application – 9/18/90	12/11/91
Specific Video Download Procedures	2/28/90		Filing Date of the Child Application – 9/18/90	12/11/91 Note **
First Party in Possession of Transmitter	8/24/90, but not entered		Filing Date of the Child Application – 9/18/90	12/11/91
Second Party in Possession of Receiver and Second Memory	8/24/90, but not entered		Filing Date of the Child Application – 9/18/90	12/11/91

Key: Clear row means original matter present in the original Parent Application. Shaded row means new matter introduced by amendment into both the Parent and Child Applications subsequent to the date of the original Parent Application.

Note * - The original specification also describes using a "convenient visual display of the user's library of songs" (page 5), however this section appears to relate to displaying category/lyrical information to the user regarding downloaded audio content, and not directed to the actual download, processing, and display of video content.

Note ** - Even more detailed video download procedures are added to the specification of subsequent child applications, see the 90/007,403 and 90/007,407 reexaminations.

Applicant failed to provide adequate support for all the new text added by amendment (as identified in Table I above) to the Parent and Child applications. Applicant should specifically point out the support for any amendments made to the original disclosure. MPEP § 714.02, 2163.II.A.2(b), and 2163.06. Consider the following:

I. Parent Application No. 07/206,497 (filed June 13, 1988)

a. Amendment of Dec. 22, 1988

New Matter in Claims

New Independent Claim 11 – "transferring money to a party controlling use of the first memory"

New Dependent Claim 13 - "providing a credit card number of the party controlling use of the first memory by the party controlling the second memory"

New Matter in Spec.

No new matter added to specification.

Support for New Matter

Applicant made a statement in the amendment that "support for these new claims is found in the figures." This statement however is very broad. Applicant does not specifically point out where in the figures the added features are found and the examiner cannot find support for such features.

b. Amendment of Feb. 28, 1990

New Matter in Claims

New Dependent Claim 14 - "transmitting the digital signal from the first memory to the second memory at a location determined by the second party..."

New Independent Claim 15 –

* "transmitting a desired digital, a video or audio music signal...."

[detailed recitation of a method for transmitting follows]

* "charging a fee to the first party controlling use of the second memory"

New Dependent Claim 18 – "charging a fee to a party controlling the use and the location of the second memory."

New Matter in Spec.

Abstract briefly mentions storing video signals onto a hard disk.

Support for New Matter

Applicant made a statement in the amendment that "antecedent support for these claims is found in Figure 1." This statement is very broad. Applicant does not specifically point out where in the figures the added features are found and the examiner cannot find support for such features.

c. Proposed After-final Amendment of August 24, 1990 (Not Entered)

New Matter in Claims

Independent Claim 11 –

*"second party controlling use and in possession of the second memory"

* "with a transmitter in control and possession of the first party to a receiver having a second memory at a location determined by the second party, said receiver in possession and control of the second party"

Independent Claim 15 –

- * "charging a fee by a first party controlling use of the first memory
- * new limitations similar to claim 11 above

New Matter in Spec.

Title amended to state "Method for Transmitting a Desired Video or Audio Signal"

Support for New Matter

No support was provided.

II. Child Application No. 07/586,391 (filed September 18, 1990) (FWC) (Issued as 5,191,573)

a. *Preliminary Amendment of September 18, 1990*

New Matter in Claims

Independent Claims 11 and 15 – Same limitations as set forth in the proposed, after-final amendments of 8/24/1990 (not entered) as discussed above in parent application.

New Matter in Specification

No amendment to the specification.

Support for New Matter

No support was provided.

b. *Amendment of December 11, 1991*

New Matter in Claims

New Dependent Claim 22 – providing a credit card number of the party controlling the second memory to the party controlling the first memory so the party controlling the second memory is charged money

New Matter in Specification

Introduces large amount of new text into the specification directed to earlier claim amendments, such as the Sept. 18, 1990 Amendment, and directed to adding specific video download details.

Support for New Matter

No support was provided.

c. Amendment of June 25, 1992

New Matter in Claims

Dependent Claim 13 – further detailed limitation regarding providing a credit card number.

New Independent Claim 23 – contains various limitations set forth in the above amendments.

New Matter in Specification

New abstract related to limitations set forth in the above amendment.

Support for New Matter

Applicant made a statement in the amendment that "antecedent support for the amendments to the claims [including new claim 23] is found in the figures and page 6, line 1."

This statement is very broad. Applicant does not specifically point out where in the figures the added features are found and the examiner cannot find support for such features.

d. Amendment of October 5, 1992

New Matter in Claims

No issues of new matter

New Matter in Spec.

No issues of new matter

Support for New Matter

N/A

Thus, as discussed above, the Applicant failed to point out support in the original Parent Application for all of the new text added by the series of amendments. Applicant should specifically point out the support for any amendments made to the original disclosure. MPEP § 714.02, 2163.II.A.2(b), and 2163.06.

Furthermore, the new text added by the amendments identified above is in the nature of additional, narrowing limitations and elements undisclosed by the generic statements in the original disclosure of the Parent Application. When an explicit limitation in a claim “is not present in the written description whose benefit is sought it must be shown that a person of ordinary skill would have understood, at the time the patent application was filed, that the description requires that limitation.” Hyatt v. Boone, 146 F.3d 1348, 1353, 47 USPQ2d 1128, 1131 (Fed. Cir. 1998) (emphasis added) (Certiorari Denied). “To establish inherency, the extrinsic evidence must make clear that the missing descriptive matter is necessarily present in the thing described in the reference.... Inherency, however, may not be established by probabilities or possibilities.” In re Robertson, 169 F.3d 743, 745, 49 USPQ2d 1949, 1950-51

(Fed. Cir. 1999) (citations omitted, emphasis added). As for speculation about undisclosed uses of the originally disclosed elements, it is not sufficient that the written description, when "combined with the knowledge in the art, would lead one to speculate as to modifications that the inventor might have envisioned, but failed to disclose." Lockwood v. American Airlines, Inc., 107 F.3d 1565, 1571, 41 USPQ2d 1961, 1965-66 (Fed. Cir. 1997). See also MPEP § 2163.II.A.2(b) and § 2163.05.II.

In the instant case, it is clear that the explicit limitations added by amendment but missing from the original written description are not required by or necessarily present in the original written description. The recited details as to how money is transferred from a second party to the first party, a fee is charged, or how a credit card number is provided are not disclosed or required by the original, generic statement "electronic sales and distribution of the music..." For example, during the originally disclosed electronic sale, money could instead be transferred from a third party buyer (e.g., advertiser, local network provider, local retail store, friend, etc.) and/or transferred to a third party seller (e.g., remote wholesale music provider, local network provider, local retail store, etc.). Furthermore, a fee would not necessarily be charged upfront during a sale (e.g., a free preview or trial period). Finally, digital content would not necessarily be purchased using a credit card (e.g., person downloading the content could receive the bill in the mail).

Similarly, the ability to control and possess a transmitter, receiver, and memory and to determine the location to which data is transmitted is not disclosed or required by the original, generic statements such as "control unit of the user." For example, the originally disclosed

control unit of the seller or user could instead mean that seller and/or buyer instead rent or lease the equipment as is commonplace in the computer network industry rather than possess the equipment. Neither is the seller or user required to exercise control over their equipment, for example, the downloading services could be provided by a third party offering a turn-key solution.

The specific video download features added to the original specification and claims by the above amendments are not disclosed nor required by the one sentence, generic statement at the end of the original specification that "this invention is not to be limited to Digital Audio Music and can include Digital Video...."² Undisclosed digital video features (assuming enablement) could be implemented into the broadly termed "invention" in an almost unlimited number of specific, possible (but not required) ways, such as at various levels of integration with the originally disclosed audio system and at various levels of detail. By introducing new text directed to specific video download features in the subsequent amendments, the applicant simply chose one possible (but not required) way to integrate video features into the originally disclosed audio system.³ Indeed, the applicant continued to add specific, video download and transmission procedures not found in the original specification (i.e., chose other possible ways to integrate video features) during the prosecution of subsequent, allegedly "continuation" applications, see the 90/007,403 and 90/007,407 reexaminations.⁴ Thus, the original, one sentence generic

² The original specification also describes using a "convenient visual display of the user's library of songs" (page 5), however this section appears to relate to displaying category/lyrical information to the user regarding downloaded audio content, and not directed to the actual download, processing, and display of video content.

³ See the amendments of February 28, 1990, December 11, 1991, and June 25, 1992.

⁴ Although adding text that replaces all appearances of "audio" with "video" would be one possible (but not required) way to integrate undisclosed video features into the originally disclosed audio system, this is not what the applicant has done here, probably because such a rote replacement would create a dysfunctional system. For example, those originally disclosed audio features directed to listening to the audio during cannot be simply replaced with the word video. For example, applicant waited

Art Unit: 3992

statement does not require all the many instances of undisclosed, specific details later added by the applicant.

Furthermore, transmission and storage of digital video content significantly differs in technology from the transmission and storage of digital audio content, thus the originally disclosed audio transmission features fail to imply or require any video transmission features. For example, the decoding of digital video data is much more processor intensive than the decoding of digital audio data due to the increased information content and bandwidth of a typical video signal. In the mid 1980(s), at the time of the filing date of the original Parent specification, only compact audio disks players were routinely available.⁵ Personal user devices with the processing power capable of playing back much larger and more complex digital video files, such as DVD players, were not routinely available until the late 1990(s), and even these devices initially only read video data from read-only DVD disks capable of storing large digital video files, not from video data downloaded (recorded) from a remote server via a communications network.⁶ Thus, undisclosed devices capable of decoding and playing back digital video files would not have been required nor necessarily present based on the original disclosure of an integrated circuit 50 of the user, which was also originally disclosed to process and store audio information. For the same reasons, it is also not clear how the originally

until the child application to add new text directed toward displaying downloaded video, see page 10 of the amendment, filed January 3, 1994, in child application 08/023,398.

⁵ See "The History of Recordings", Recording Industry of Association, retrieved from <http://www.riaa.com/issues/audio/hisotry.asp> on September 19, 2006. See also the "History of CD Technology", citing as a source "The compact Disc Handbook, 2nd Edition," by Ken C. Pohlmann, retrieved from <http://www.oneoffcd.com/info/hisotrycd.cfm> on September 19, 2006.

⁶ See the "History of MPEG", University of California, Berkeley, School of Information Management and Systems, retrieved from <http://www2.sims.berkeley.edu/courses/is224/s99/GroupG/report1.html> on September 19, 2006. See also the "History of CD Technology", citing as a source "The compact Disc Handbook, 2nd Edition," by Ken C. Pohlmann, retrieved from <http://www.oneoffcd.com/info/hisotrycd.cfm> on September 19, 2006.

disclosed, incoming RAM 50c and playback RAM 50d could have supported storage of downloaded video and playback.

Further regarding the original equipment of the user (consumer), in 1988 a large capacity drive for a user (e.g., 3.5 inch form factor) was around 30 megabytes⁷, yet the digital bandwidth required to transmit a video signal at even VHS quality was 1.5 megabits per second (approximately 30 megabytes in 3 minutes) and this even using a Moving Picture Coding Experts Group Standard "1" ("MPEG-1") video compression technology not even available in 1988.⁸ Thus, undisclosed devices capable of downloading and storing digital video files would not have been required or necessarily present based on the original disclosure of hard disk 60, which was also originally disclosed to process and store audio information.

Regarding video equipment used at the library (server) end, even large mainframe computers (e.g., IBM mainframe computers) typically only provided hard drives with capacity well below 10 gigabytes.⁹ Thus, undisclosed devices capable of supporting even a small-sized video library, with its steep storage requirements as discussed above, would not have been required or necessarily present based on the original disclosure of the library (server) hard disk 10 of the copyright holder, which was originally disclosed as storing audio information.

Regarding the transfer of these large video files over a network, the proliferation of broadband communication network capable of delivering these large files to consumers, such as

⁷ See "IBM HDD Evolution" chart, by Ed Grochowski at Almaden, retrieved from http://www.soragereview.com/guideImages/z_ibm_sorageevolution.gif on September 19, 2006.

⁸ See the "History of MPEG", University of California, Berkeley, School of Information Management and Systems, retrieved from <http://www2.sims.berkeley.edu/courses/is224/s99/GroupG/report1.html> on September 19, 2006.

the Internet, simply did not exist or were not well known in 1988. Furthermore, it is not clear how the digital video would have been coded and decoded during transmission, as digital video coding standards for purposes of transmission and file downloading were not settled in 1988. As an example of the above points, the MPEG-1 standard, which was designed to code/decode digital video information and to transmit the video via a telephone (telecommunications) network in NTSC (broadcast) quality for archiving, was only established in 1992.¹⁰ Thus, undisclosed devices capable of coding, transmitting, and decoding video digital data would not have been required or necessarily present based on the original disclosure of telephone line 30 (transmission line) and control IC(s) 20b and 50b (coding/decoding devices), which were originally disclosed as processing audio information.

In view of the above, all of the new text introduced by amendment into the Child Application (as identified in Table I above) is considered new matter to the original Parent Application for the purposes of this reexamination. Thus, the previously filed specification of the Parent Application fails to support the invention claimed in the Child Application and thus is not entitled to priority under 35 U.S.C. 120, See 35 U.S.C. 120. Thus, the effective filing date (priority) of the instant '573 Patent under reexamination is latest date at which time the priority chain was broken, namely September 18, 1990 (at the earliest), which is also the filing date of the Child Application (which issued as the '573 Patent under reexamination).

⁹ IBM HDD Evolution chart, *supra*.

¹⁰ History of MPEG, *supra*.

Claim Rejections - 35 USC § 112

The following is a quotation of the first paragraph of 35 U.S.C. 112:

The specification shall contain a written description of the invention, and of the manner and process of making and using it, in such full, clear, concise, and exact terms as to enable any person skilled in the art to which it pertains, or with which it is most nearly connected, to make and use the same and shall set forth the best mode contemplated by the inventor of carrying out his invention.

Claims 7-43 are rejected under 35 U.S.C. 112, first paragraph, as failing to comply with the written description requirement. The claim(s) contains subject matter, which was not described in the specification in such a way as to reasonably convey to one skilled in the relevant art that the inventor(s), at the time the application was filed, had possession of the claimed invention.

35 U.S.C. 112 issues can be addressed in a reexamination proceeding with respect to new claims or amendatory subject matter. MPEP § 2258.

"Most typically, the [112] issue will arise in the context of determining whether new or amended claims are supported by the description of the invention in the application as filed... whether a claimed invention is entitled to the benefit of an earlier priority date or effective filing date under 35 U.S.C. 119, 120, or 365(c)." MPEP § 2163.I. Here, the '573 Patent under reexamination claims benefit under 35 U.S.C. 120 to the earlier filing date of the Parent Application.

The new claim(s) contain subject matter, which was not described in the specification in such a way as to reasonably convey to one skilled in the relevant art that the inventor(s), at the

time the original Parent Application was filed, had possession of the claimed invention. Indeed, the new claims contain extensive new text that is not found in the written description of the original Parent Application (see Table I in the priority section above).

To comply with the written description requirement of 35 U.S.C. 112, para. 1, or to be entitled to an earlier priority date or filing date under 35 U.S.C. 119, 120, or 365(c), each claim limitation must be expressly, implicitly, or inherently supported in the originally filed disclosure. When an explicit limitation in a claim "is not present in the written description whose benefit is sought it must be shown that a person of ordinary skill would have understood, at the time the patent application was filed, that the description requires that limitation." Hyatt v. Boone, 146 F.3d 1348, 1353, 47 USPQ2d 1128, 1131 (Fed. Cir. 1998). See also In re Wright, 866 F.2d 422, 425, 9 USPQ2d 1649, 1651 (Fed. Cir. 1989).

MPEP § 2163.II.A.2.(b), emphasis added.

Here, the Patent Owner, on page 13 in the amendment of February 06, 2005, points to col. 5, ll. 5-25 of the '573 Patent. However, this section fails to provide support for the extensive set of limitations introduced by thirty-six new claims, such as those limitations directed to a first party controlling use of the first memory, a second party controlling use and in possession of the second memory, transmitting the desired signal to a second memory at a location determined by the second party, a transmitter in control and possession of the first party, and a receiver in possession and control of the second party. Neither are these limitations implicit or inherent to the originally filed disclosure in the Parent Application, as extensively discussed in the "Benefit of Earlier Filing Date Regarding the Original Claims" section above.

Claims 14-21 and 33-43 are rejected under 35 U.S.C. 112, first paragraph, as failing to comply with the enablement requirement. The claim(s) contains subject matter, which was not

described in the specification in such a way as to enable one skilled in the art to which it pertains, or with which it is most nearly connected, to make and/or use the invention.

35 U.S.C. 112 issues can be addressed in a reexamination proceeding with respect to new claims or amendatory subject matter. MPEP § 2258.

The new claim(s) contain subject matter, which was not described in the specification in such a way as to reasonably convey to one skilled in the relevant art that the inventor(s), at the time both original Parent Application was filed, that the specification would have taught one skilled in the art how to make and/or use the full scope of the claimed invention without undue experimentation. In re Wright, 999 F.2d 1557, 1562, 27 USPQ2d 1510, 1513 (Fed. Cir. 1993). See also MPEP § 2164.01 and 2164.05(a).

Undue Experimentation Factors

There are many factors to be considered when determining whether there is sufficient evidence to support a determination that a disclosure does not satisfy the enablement requirement and whether any necessary experimentation is “undue.” These factors include, but are not limited to whether the scope and breadth of the claims are reasonably related to the scope of enablement within the original specification, the level of ordinary skill in the art, and the quantity of undue experimentation. See MPEP 2164.01(a).

Here, the subject claims recite extensive new text directed to specific and detailed video download and processing procedures that is not found in original specification of the Parent

Application. The original specification does contain a general statement at the end of the specification stating "[f]urther, it is intended that this invention is not to be limited to Digital Audio Music and can include Digital Video....", however this broad, generic statement fails to enable specifically claimed video download and processing procedures.¹¹

The detailed and extensive claim limitations directed to video download and processing stand in contrast to the brief, generic one sentence disclosure in the original specification, as discussed above. Thus, the scope and breadth of the claims are not reasonably correlated to the scope of enablement in the original specification. The scope of enablement must at least bear a "reasonable correlation" to the scope of the claims. See, e.g., *In re Fisher*, 427 F.2d 833, 839, 166 USPQ 18, 24 (CCPA 1970). See also MPEP § 2164.08.

The original specification would not have been enabling to one of ordinary skill in the art and furthermore an undue quantity of experimentation would have been required to make or use the scope of the claimed invention (video download and processing features) based on the original specification. The specification must be enabling as of the filing date of the specification. MPEP § 2164.05(a). Here, the filing date of the Parent Application was June 13, 1988. In the mid 1980(s) however, only compact audio disks players were just becoming popular.¹² Personal user devices with the processing power capable of playing back much larger and more complex digital video files, such as DVD players, were not routinely available until the

¹¹ The original specification also describes using a "convenient visual display of the user's library of songs" (page 5), however this section appears to relate to displaying category/lyrical information to the user regarding downloaded audio content, and not directed to the actual download of video content.

¹² See "The History of Recordings", Recording Industry of Association, retrieved from <http://www.riaa.com/issues/audio/hisotry.asp> on September 19, 2006. See also the "History of CD Technology", citing as a

late 1990(s), and even these devices initially only read video data from read-only DVD disks capable of storing large digital video files, not from video data downloaded (recorded) from a remote server via a communications network.¹³ Thus, it is not clear how the originally disclosed, integrated circuit 50 of the user would have had the processing power to decode and playback downloaded, digital video signals. For the same reasons, it is also not clear how the originally disclosed, incoming RAM 50c and playback RAM 50d could have supported storage of downloaded video and playback.

Further regarding the equipment of the user (consumer), in 1988 a large capacity drive for a user (e.g., 3.5 inch form factor) was around 30 megabytes¹⁴, yet the digital bandwidth required to transmit a video signal at even VHS quality was 1.5 megabits per second (approximately 30 megabytes in 3 minutes) and this even using a Moving Picture Coding Experts Group Standard "1" ("MPEG-1") video compression technology not even available in 1988.¹⁵ Thus, it is not clear how a how downloaded video files of any appreciable or viable size would have been downloaded and stored on originally disclosed hard disk 60 of the user in the original specification.

Regarding the equipment used at the library (server), even large mainframe computers (e.g., IBM mainframe computers) typically only provided hard drives with capacity well below

source "The compact Disc Handbook, 2nd Edition," by Ken C. Pohlmann, retrieved from <http://www.oneoffcd.com/info/hisotrycd.cfm> on September 19, 2006.

¹³ See the "History of MPEG", University of California, Berkeley, School of Information Management and Systems, retrieved from <http://www2.sims.berkeley.edu/courses/is224/s99/GroupG/report1.html> on September 19, 2006. See also the "History of CD Technology", citing as a source "The compact Disc Handbook, 2nd Edition," by Ken C. Pohlmann, retrieved from <http://www.oneoffcd.com/info/hisotrycd.cfm> on September 19, 2006.

¹⁴ See "IBM HDD Evolution" chart, by Ed Grochowski at Almaden, retrieved from http://www.soragereview.com/guideImages/z_ibm_sorageevolution.gif on September 19, 2006.

10 gigabytes.¹⁶ Thus, it is not clear how even a small-sized video library, with its steep bandwidth (storage) requirements (as discussed above), would have been stored in the hard disk 10 of the copyright holder in the original specification, without requiring details directed toward a complex mainframe operating environment.

Regarding the transfer of these large video files over a network, the proliferation of broadband communication network capable of delivering these large files to consumers, such as the Internet, simply did not exist or were not well known in 1988. Furthermore, it is not clear how the digital video would have been coded and decoded during transmission, as digital video coding standards for purposes of transmission and file downloading were not settled in 1988. As an example of the above points, the MPEG-1 standard, which was designed to code/decode digital video information and to transmit the video via a telephone (telecommunications) network in NTSC (broadcast) quality for archiving, was only established in 1992.¹⁷

Thus, based on the evidence regarding each of the above factors, the specification, at the time the Parent application was filed, would not have taught one skilled in the art how to make and/or use the full scope of the claimed invention without undue experimentation.

¹⁵ See the "History of MPEG", University of California, Berkeley, School of Information Management and Systems, retrieved from <http://www2.sims.berkeley.edu/courses/is224/s99/GroupG/report1.html> on September 19, 2006.

¹⁶ IBM HDD Evolution chart, *supra*.

Claim Rejections Based on Bush

Claim Rejections - 35 USC § 102

The following is a quotation of the appropriate paragraphs of 35 U.S.C. 102 that form the basis for the rejections under this section made in this Office action:

A person shall be entitled to a patent unless –

(b) the invention was patented or described in a printed publication in this or a foreign country or in public use or on sale in this country, more than one year prior to the date of application for patent in the United States.

Claims 1-6 are rejected under 35 U.S.C. 102(b) as being anticipated by Bush.

Regarding **claim 1**,

A method for transmitting a desired digital audio signal stored on a first memory of a first party to a second memory of a second party comprising the steps of:

Bush teaches transmitting a desired digital, audio or video signal (col. 2, ll. 18-29 and col. 3, ll. 26 - 35). The digital audio or video signals are stored on compact disc machines 41-46 (first memory) of a pay per view entertainment system provider associated with source 10 (first party) (Figs. 1, 4 and col. 2, ll. 19-47). The digital signals are transmitted via a network to the consumer's receiver 14 (Fig. 1) (also illustrated as receiver 100 in Fig. 5, see also col. 3, ll. 14-17). The signals are stored on cassette recording unit and an associated cassette tape (second memory) (Fig. 5 and col. 4, ll. 1-11). Note that the second memory is also a compact disc recorder (col. 10, claim 14) and thus the second memory is also a CD.

transferring money electronically via a telecommunication line to the first

¹⁷ History of MPEG, *supra*.

party at a location remote from the second memory and controlling use of the first memory from the second party financially distinct from the first party, said second party controlling use and in possession of the second memory;

Bush teaches that money is electronically transferred via a telephone line (telecommunications line) and clearing house 200 to the source 10 (first party) by way of a credit card transaction (Fig. 3 and col. 2, ll. 58-63, col. 4, ll. 44-47, col. 5, ll. 1-3, col. 6, ll. 25-28, and ll. 45-48). The first party's location (source 10) is remote via a network from the consumer (Fig. 1). The second party (consumer) commands the download of audio/video from the memories of the first party (source 10) (Fig. 7, col. 1, ll. 59-64, and col. 6, ll. 11-48). Thus, the first memory is controlled from the second party. Clearly, the second party (consumer) is financially distinct from the first party (source 10). The second party (consumer) also controls the use and also possesses the second memory, such as by the ability to determine what contents are stored in the second memory (col. 6, ll. 11-48)

connecting electronically via a telecommunications line the first memory with the second memory such that the desired digital audio signal can pass therebetween;

The limitation broadly recites "a telecommunications line," which lacks antecedent basis to the previous recitation of a telecommunications line. The examiner interprets a "telecommunications line" to mean a electronic medium of communicating between computers, which requires end-to-end connectivity, which is an interpretation consistent with an interpretation advanced by the Patent Owner and adopted by the district court. Sightsound.com Inc. v. NSK, Inc. Cdnow, Inc., and Cdnow Online, Inc., Civil Action No. 98-118, pp. 50 and 57

(District Court for the Western District of Pennsylvania, Feb. 2002). Here, Bush teaches of a cable system (electronic medium) that provides end-to-end communications between computer at the central cable system associated with source 10 and the consumer's computer (Figs. 1, 2 and 5). The audio and video files are downloaded via the telecommunications line and thus connect the first and second memories, as discussed above.

transmitting the desired digital audio signal from the first memory with a transmitter in control and possession of the first party to a receiver having the second memory at a location determined by the second party, said receiver in possession and control of the second party; and

The desired digital audio or video signal is transmitted from the first memory as discussed above using a transmitter (Fig. 4, CADA transceiver 40) in control (col. 2, ll. 18-21) and possession of the first party, such as when the first party (source 10) determines what contents are stored in the first memory (col. 2, ll. 30-42). The second party (consumer) determines the location to which the audio/video data is transmitted as broadly recited by the claims, such as the consumer operates the invention by turning on the television and interacts with the pay per view channel at a location (e.g., consumer's home) determined by the consumer. The receiver 14 includes a cassette tape (or CD) (as discussed above) that is in possession and control of the second party (col. 1, ll. 59-64).

storing the digital signal in the second memory.

The received audio/video digital signal is stored in the second memory (cassette tape or CD) associated with the second party (consumer) as discussed above. See also col. 5, ll. 24-52.

Claim 4 differs substantively from claim 1 in that claim 4 recites that digital "video" signal is transmitted (downloaded) as opposed to the audio signal in claim 1. However, the claim 1 rejection clearly explained how Bush teaches that both audio and video digital signals are downloaded. Therefore, see the claim 1 rejection for additional details.

Regarding **claims 2 and 5**, after the money transfer step, the recording system searches for a recording signal from the remote library (e.g., forward and reverse roll commands) and then for a subsequent video/audio file from the remote library for the purposes of recording, where the video/audio file is stored in the first memory, as discussed above (col. 5, ll. 35-44 and col. 6, ll. 23-48).

Regarding **claims 3 and 6**, Bush teaches (similarly to Yurt) of a system for downloading audio and video files from a central library to a user, where the user pays for the audio files and stores the audio files (abstract and Figs. 1 and 6). Bush also teaches that the user provides a credit card number to the second party (library) (col. 4, ll. 44-47, col. 5, ll. 1-3, col. 6, ll. 25-28, and ll. 45-48).

Claim Rejections - 35 USC § 103

The following is a quotation of 35 U.S.C. 103(a) which forms the basis for all obviousness rejections set forth in this Office action:

(a) A patent may not be obtained though the invention is not identically disclosed or described as set forth in section 102 of this title, if the differences between the subject matter sought to be patented and the prior art are such that the subject matter as a whole would have been obvious at the time the invention was made to a person having ordinary skill in the art to which said subject matter pertains. Patentability shall not be negated by the manner in which the invention was made.

Claims 7-43 are rejected under 35 U.S.C. 103(a) as being unpatentable over Bush in view of U.S. Patent No. 4,870,515 ("Stokes"), of record.

Claim 7 differs substantively from claim 1 in that claim 7 recites the additional limitation "listing/scrolling digital audio signals from the second memory." For the purposes of examination "listing/scrolling" will be interpreted as "listing or scrolling."

Although Bush teaches of limited scrolling capability via a keypad interface and date/PIN display (Fig. 6), Bush does not clearly teach listing or scrolling from the second memory associated with the second party (consumer).

Stokes however (similarly to Bush) teaches of a tape or CD playback device (abstract and Figs. 3 and 3a) that provides extensive listing or scrolling capability regarding the available selections (including the name of the digital audio signal, such as title of the track, duration of the digital audio signal, and name of the artist, and name of the album) (abstract, col. 2, ll. 3-38, ll. 57-61, and col. 3, ll. 4-35). Note also that Stokes (similarly to Bush) teaches of supporting a compact disc (col. 3, ll. 49-56).

The suggestion/motivation for adding the teachings of Stokes would have been to increase the user friendliness and operational efficiency of the playback device by adding the ability to "display to the user a wide variety of data about musical selections recorded on the magnetic tape or other medium," "display[] identifying information concerning the musical

Art Unit: 3992

selections, for example, artist, title, track, playing time, album name," "enable the user to choose which tracks or musical selections are to be played," and store the track data in a library memory, "so that a user can quickly locate a given selection of music" (Stokes, col. 1, l. 43 – col. 2, l. 2 and col. 3, ll. 4-13).

Therefore, it would have been obvious to a person of ordinary skill in the art at the time the invention was made to add the listing or scrolling teachings (including the name of the digital audio signal, such as title of the track, duration of the digital audio signal, and name of the artist, and name of the album) as taught by the tape or CD playback device of Stokes to the tape or CD playback device of Bush.

Claim 14 does not substantively differ from claims 4 and 7 above.

Claim 22 differs substantively from claims 1 and 7 in that claim 22 recites the additional limitation "randomly selecting digital audio signals from the second memory by a second party integrated circuit of a second party control unit." Stokes teaches that the second memory in the receiver also includes an interchangeable, random access memory ("RAM) 48 (Fig. 13, col. 5, ll. 20-34 and col. 9, l. 58 – col. 1, 2). More generally, the user can retrieve data using random access commands, such as play, fast forward, rewind, stop, pause, and play slow commands (col. 5, ll. 64-66). The circuits used to randomly select the digital audio or video are integrated circuits, such as 8-bit CPU 10. Thus, Bush teaches the literal language of the claims ("randomly selecting digital audio signals from the second memory by a second party"), namely that the second party (user) randomly accesses the second memory for media content, such as when

randomly entering media playback commands (e.g., forward, rewind, stop, pause, etc.) by a integrated circuit of the second party.

Claim 26 differs substantively from claims 1 and 7 in that claim 26 recites the additional limitation "displaying a name of an artist of the digital audio signal from the second memory." This limitation was addressed in the details of the claim 7 rejection above.

Claim 29 differs substantively from claims 1 and 7 in that claim 29 recites the additional limitation "displaying a duration of the digital audio signal from the second memory." This limitation was addressed in the details of the claim 7 rejection above.

Claim 33 does not substantively differ from claims 7 and 22 above.

Claim 37 does not substantively differ from claims 7 and 26 above.

Claim 40 does not substantively differ from claims 7 and 29 above.

Regarding **claims 8, 15, 23, 27, 30, 34, 38, and 41**, see the claim 3 rejection above for additional details.

Regarding **claims 9, 25, and 32**, see the claim 26 rejection and col. 12, ll. 61-65 regarding the "name of a digital audio signal."

Regarding **claim 10**, see the claim 29 rejection for additional details regarding "duration of digital audio signal"

Regarding **claim 11**, see the claim 26 rejection regarding the "name of an artist of the digital audio signal."

Regarding **claim 12**, see the claim 26 rejection and col. 12, ll. 61-65 regarding the "name of an album with the digital audio signal."

Regarding **claim 13**, see the claim 22 rejection for additional details regarding "randomly selecting digital audio signals."

Regarding **claims 16, 36, and 43**, see the claims 9 and 26 rejections for additional details regarding "name of a digital video."

Regarding **claims 17, 35, 39, and 42**, see the claim 14 rejection for additional details regarding "listing/scrolling queued digital video signals."

Regarding **claim 18**, see the claim 40 rejection for additional details regarding "duration of the digital video signal."

Regarding **claim 19**, see the claim 37 rejection for additional details regarding "name of artist of the digital video signal."

Regarding **claim 20**, see the claim 12 regarding the "name of an album", where this name also refers to a video signal, as discussed in the claim 4 rejection above.

Regarding **claim 21**, see the claim 33 rejection for additional details regarding "randomly selecting digital video signals."

Regarding **claims 24, 28 and 31**, see the claim 7 rejection for additional details regarding "listing/scrolling."

Regarding **claim 35**, see the claim 17 rejection for additional details.

Claims 22, 24, 25 and 33, 35, and 36 are rejected under 35 U.S.C. 103(a) as being unpatentable over Bush in view of Stokes as applied above, and further in view of U.S. Patent No. 4,787,073 ("Masaki"), newly cited.

Claims 22 and 33 differ substantively from claim 7 in that claim 22 recites the additional limitation "randomly selecting digital audio signals from the second memory by a second party integrated circuit of a second party control unit."

Bush teaches that the second memory in the receiver also includes an interchangeable, random access memory ("RAM) 48 (Fig. 13, col. 5, ll. 20-34 and col. 9, l. 58 – col. 1, 2). More generally, the user can retrieve data using random access commands, such as play, fast forward,

Art Unit: 3992

rewind, stop, pause, and play slow commands (col. 5, ll. 64-66). The circuits used to randomly select the digital audio or video are integrated circuits, such as 8-bit CPU 10. Thus, Bush could be said to impliedly teach the literal language of the claims ("randomly selecting digital audio signals from the second memory by a second party"), namely that the second party (user) randomly accesses the second memory for media content, such as when randomly entering media playback commands (e.g., forward, rewind, stop, pause, etc.) by a integrated circuit of the second party.

Bush however fails to explicitly teach randomly selecting the digital audio by the second party (user).

Masaki (similarly to Bush) teaches of a digital playback system (col. 1, ll. 5-12) that randomly plays back audio files from a storage system (col. 3, ll. 40-67).

The suggestion/motivation for combining the random playback teachings of Masaki with Bush would have been to increase user-friendliness and the effectiveness and enjoyment of the stored content by avoiding the situation where "order of playing back the musical pieces [is]...known beforehand, which spoils the enjoyment" (Masaki, col. 1, ll. 25-27).

Therefore, to one of ordinary skill in the art at the time the invention was made, it would have been obvious to add the random playback from digital storage as taught by Masaki to the playback device using digital storage as taught by Bush.

Regarding **claims 23 and 34**, see the claim 8 rejection above for further details.

Regarding **claim 24**, see the claim 7 rejection above for additional details.

Regarding **claim 25**, see the claim 9 rejection above for additional details.

Regarding **claim 35**, see the claim 17 rejection above for additional details.

Regarding **claim 36**, see the claim 16 rejection above for additional details.

Claim 21 is rejected under 35 U.S.C. 103(a) as being unpatentable over Bush as applied above, and further in view of Masaki. See the claim 22 rejection above for additional details.

Claim Rejections Based on Cohen

Claim Rejections - 35 USC § 102

Claims 1, 2, 4, and 5 are rejected under 35 U.S.C. 102(e) as being anticipated by U.S. Patent No. 4,949,187 ("Cohen"), of record.

The filing date of the Cohen patent is December 16, 1988. The earliest priority date of the '573 Patent under reexamination however is September 18, 1990, as discussed extensively above in the Priority section. Thus, Cohen is available as 102(e) type prior art.

With respect to **claim 1**, Cohen clearly teaches a method for transmitting a desired digital movie signal (abstract) comprising video and audio components (col. 1, ll. 7-12 and ll. 46-50) of a first party (central source of audio and video data, Fig. 4) to a second memory (disk storage system 114) of a second party (home viewer) (abstract). Money is electronically transferred via a telephone (telecommunication) line, where the first (central source) and second party (home viewer) are clearly financially distinct (abstract and Fig. 4, telephone line 60). The desired digital movie (video and audio) is in the first memory (principal on line movie storage 12-26, Fig. 4) is connected to and transferred via the telephone (telecommunications) line 60 to the second memory (disk storage system 114), where it is stored (col. 4, ll. 1-68).

Claim 4 differs substantively from claim 1 in that claim 4 recites that digital "video" signal is transmitted (downloaded) as opposed to the audio signal in claim 1. However, the claim 1 rejection clearly explained how Cohen teaches that both audio and video digital signals are downloaded. Therefore, see the claim 1 rejection for additional details.

Regarding **claims 2 and 5**, see col. 4, ll. 19-29 and ll. 47-63, where after the money transfer (accounting) step, the system searches for the desired selection by the home viewer and commences downloading.

Claim Rejections - 35 USC § 103

Claims 3 and 6 are rejected under 35 U.S.C. 103(a) as being unpatentable over Cohen as applied to claims 1, 2, 4, and 5 above, and further in view of Bush.

Cohen teaches of telephoning the first party controlling use of the first memory and transferring money (as discussed above in the claim 1 rejection). Cohen however fails to teach providing a credit card number of the second party.

Bush teaches (similarly to Cohen) of a system for downloading audio and video files from a central library to a user, where the user pays for the audio files and stores the audio files (abstract and Figs. 1 and 6). See also the Bush, claim 1 rejection above. Bush also teaches that the user provides a credit card number to the second party (library) (col. 4, ll. 44-47, col. 5, ll. 1-3, col. 6, ll. 25-28, and ll. 45-48).

The suggestion/motivation for providing a credit card number to the second party would be to reduce the expenses involved in operating a download service, because financial service organizations, such as credit card organizations, "enable the source 10 to [be] paid by a service fee for the subscriber's use of the system." Bush, col. 2, ll. 58-63. Obviously, providing a credit card number would have been required to use the services of a credit card organization.

Therefore, it would have been obvious to one of ordinary skill in the art at the time the invention was made to add the step of the user providing a credit number to the second party as taught by the audio/video download system of Bush to the audio/video download of Cohen, which teaches that the user pays for the download.

Claim Rejections Based on Akashi

Claims 1-6 are rejected under 35 U.S.C. 103(a) as being unpatentable over Japanese Patent Application No. 62-284496 ("Akashi") using the English translation of record, in view of U.S. Patent No. 4,528,643 ("Freeny").

Regarding **claims 1, 3, 4, 6**, Akashi discloses a system for automatically selling recorded music via telecommunication lines (Page 1 through line 1 of Page 2). This system utilizes the telecommunications lines to transmit the recorded music data from a host computer that stores the recorded music data to a personal computer (Page 2 Section 4), which meets the limitation of connecting electronically via telecommunications line the first memory with the second memory such that the desired digital audio signal can pass therebetween, transmitting the desired digital audio signal from the first memory with a transmitter in control and possession of the first party to a receiver having the second memory at a location determined by the second party, said receiver in possession and control of the second party, storing the digital signal in the second memory.

Akashi discloses that the digital music data is purchased automatically but does not expressly detail how the purchase is transacted.

Freeny discloses a method of electronically distributing and selling audio and video data by way of having the requesting user transmit a consumer credit card number along with their request for the audio and video data (Col. 13, lines 25-29). This step allows the owner of the data

to approve the sale and charge the sale to the consumer credit card number (Col. 13, lines 30-31), which meets the limitation of transferring money electronically via a telecommunications lines to the first party at a location remote from the second memory and controlling use of the first memory from the second party financially distinct from the first party, said second party controlling use and in possession of the second memory, the transferring step includes the steps of telephoning the first party controlling use of the first memory by the second party, providing a credit card number of the second party controlling the second memory to the first party controlling the first memory so the second party is charged money.

The suggestion/motivation for combining Akashi with Freeny would have been because this method of electronic sale allows the owner of the information to receive directly the compensation for sale of recording and such compensation is received before the reproduction is authorized as taught in Freeny (Col. 13, lines 36-39).

Therefore, it would have been obvious to one of ordinary skill in the art at the time the invention was made to have the requesting user's of Akashi transmit a consumer credit card number along with their request for the digital data so that the source unit could approve and charge the sale of the digital data to the consumer credit card

Regarding **claims 2 and 5**, Akashi discloses that personal computer contains a CPU (Figure 1). The personal computer sends an access signal to the host computer, and the host computer returns a response signal that contains menu data displayed at the personal computer (Page 3 Paragraph 6). Using the monitor screen, the user chooses desired data using a control

Art Unit: 3992

unit and sending the selection data to the host computer in the same way the initial transmission was sent (Page 4 Paragraph 1), which meets the limitation of the steps of searching the first memory for the desired digital audio signal and selecting the desired digital audio signal from the first memory.

Conclusion

Extensions of time under 37 CFR 1.136(a) do not apply in reexamination proceedings. The provisions of 37 CFR 1.136 apply only to "an applicant" and not to parties in a reexamination proceeding. Further, in 35 U.S.C. 305 and in 37 CFR 1.550(a), it is required that reexamination proceedings "will be conducted with special dispatch within the Office."

Extensions of time in reexamination proceedings are provided for in 37 CFR 1.550(c). A request for extension of time must be filed on or before the day on which a response to this action is due, and it must be accompanied by the petition fee set forth in 37 CFR 1.17(g). The mere filing of a request will not effect any extension of time. An extension of time will be granted only for sufficient cause, and for a reasonable time specified.

The Patent Owner is reminded of the continuing responsibility under 37 CFR 1.565(a) to apprise the Office of any litigation activity, or other prior or concurrent proceeding, involving U.S. Patent No. 5,191,573 throughout the course of this reexamination proceeding. The third party requester is also reminded of the ability to similarly apprise the Office of such activity or proceeding throughout the course of this reexamination proceeding. See MPEP §§ 2207, 2282, and 2286.

A complete response should be made in response to this Office Action since the next Office Action is expected to be a Final Action. Thus, in order to ensure full consideration of any amendments, affidavits or declarations, or other documents as evidence of patentability, such documents must be submitted in response to this Office Action. Submissions after the next

Office Action, which is intended to be a Final Action, will be governed by the requirements of 37 C.F.R. 1.116(b), which will be strictly enforced. Any amendment after a Final Action must include "a showing of good and sufficient reasons why the amendment is necessary and was not earlier presented" in order to be considered. See MPEP § 2260.

Art Unit: 3992

All correspondence relating to this ex parte reexamination proceeding should be directed as follows:

By U.S. Postal Service Mail to:

Mail Stop "Ex Parte Reexam"
ATTN: Central Reexamination Unit
Commissioner for Patents
P. O. Box 1450
Alexandria VA 22313-1450

By FAX to:

(571) 273-9900
Central Reexamination Unit

By hand to:

Customer Service Window
Central Reexamination Unit
Randolph Building, Lobby Level
401 Dulany Street
Alexandria, VA 22314

Any inquiry concerning this communication or earlier communications from the Reexamination Legal Advisor or Examiner, or as to the status of this proceeding, should be directed to the Central Reexamination Unit at telephone number (571) 272-7705.

Signed:



Roland G. Foster
Central Reexamination Unit, Primary Examiner
Electrical Art Unit 3992
(571) 272-7538

Conferree:



SCOTT L. WEAVER
CRU EXAMINER-AU 3992



MARK J. REINHART
SPRE-AU 3992
CENTRAL REEXAMINATION UNIT

Search Notes



Application/Control No.

90/007,402

Examiner

Roland G. Foster

Applicant(s)/Patent under Reexamination

5191573

Art Unit

3992

SEARCHED

Class	Subclass	Date	Examiner

INTERFERENCE SEARCHED

Class	Subclass	Date	Examiner

**SEARCH NOTES
(INCLUDING SEARCH STRATEGY)**

	DATE	EXMR
<u>EAST</u> - SEE SEARCH HISTORY PRINTOUT	8/15/06	R.G.F.
- 707/10.4.1 709/217, 219	↓	↓
<u>STIC</u> - SEE SEARCH HISTORY PRINTOUT	↓	↓

Index of Claims



Application/Control No.

90/007,402

Examiner

Roland G. Foster

Applicant(s)/Patent under Reexamination

5191573

Art Unit

3992

✓	Rejected
=	Allowed

-	(Through numeral) Cancelled
+	Restricted

N	Non-Elected
I	Interference

A	Appeal
O	Objected

Claim		Date			
Final	Original				
	1				
	2				
	3				
	4				
	5				
	6				
	7				
	8				
	9				
	10				
	11				
	12				
	13				
	14				
	15				
	16				
	17				
	18				
	19				
	20				
	21				
	22				
	23				
	24				
	25				
	26				
	27				
	28				
	29				
	30				
	31				
	32				
	33				
	34				
	35				
	36				
	37				
	38				
	39				
	40				
	41				
	42				
	43				
	44				
	45				
	46				
	47				
	48				
	49				
	50				

Claim		Date			
Final	Original				
	51				
	52				
	53				
	54				
	55				
	56				
	57				
	58				
	59				
	60				
	61				
	62				
	63				
	64				
	65				
	66				
	67				
	68				
	69				
	70				
	71				
	72				
	73				
	74				
	75				
	76				
	77				
	78				
	79				
	80				
	81				
	82				
	83				
	84				
	85				
	86				
	87				
	88				
	89				
	90				
	91				
	92				
	93				
	94				
	95				
	96				
	97				
	98				
	99				
	100				

Claim		Date			
Final	Original				
	101				
	102				
	103				
	104				
	105				
	106				
	107				
	108				
	109				
	110				
	111				
	112				
	113				
	114				
	115				
	116				
	117				
	118				
	119				
	120				
	121				
	122				
	123				
	124				
	125				
	126				
	127				
	128				
	129				
	130				
	131				
	132				
	133				
	134				
	135				
	136				
	137				
	138				
	139				
	140				
	141				
	142				
	143				
	144				
	145				
	146				
	147				
	148				
	149				
	150				

File 9:Business & Industry(R) Jul/1994-2006/Aug 10
(c) 2006 The Gale Group

File 15:ABI/Inform(R) 1971-2006/Aug 11
(c) 2006 ProQuest Info&Learning

File 16:Gale Group PROMT(R) 1990-2006/Aug 10
(c) 2006 The Gale Group

File 20:Dialog Global Reporter 1997-2006/Aug 11
(c) 2006 Dialog

File 47:Gale Group Magazine DB(TM) 1959-2006/Aug 10
(c) 2006 The Gale group

File 75:TGG Management Contents(R) 86-2006/Jul W5
(c) 2006 The Gale Group

File 80:TGG Aerospace/Def.Mkts(R) 1982-2006/Aug 10
(c) 2006 The Gale Group

File 88:Gale Group Business A.R.T.S. 1976-2006/Aug 01
(c) 2006 The Gale Group

File 98:General Sci Abs 1984-2005/Jan
(c) 2006 The HW Wilson Co.

File 112:UBM Industry News 1998-2004/Jan 27
(c) 2004 United Business Media

File 141:Readers Guide 1983-2006/Jun
(c) 2006 The HW Wilson Co

File 148:Gale Group Trade & Industry DB 1976-2006/Aug 10
(c)2006 The Gale Group

File 160:Gale Group PROMT(R) 1972-1989
(c) 1999 The Gale Group

File 275:Gale Group Computer DB(TM) 1983-2006/Aug 10
(c) 2006 The Gale Group

File 264:DIALOG Defense Newsletters 1989-2006/Aug 09
(c) 2006 Dialog

File 369:New Scientist 1994-2006/Jul W2
(c) 2006 Reed Business Information Ltd.

File 370:Science 1996-1999/Jul W3
(c) 1999 AAAS

File 484:Periodical Abs Plustext 1986-2006/Aug W1
(c) 2006 ProQuest

File 553:Wilson Bus. Abs. 1982-2006/Jul
(c) 2006 The HW Wilson Co

File 570:Gale Group MARS(R) 1984-2006/Aug 10
(c) 2006 The Gale Group

File 608:KR/T Bus.News. 1992-2006/Aug 11
(c)2006 Knight Ridder/Tribune Bus News

File 620:EIU:Viewswire 2006/Aug 10
(c) 2006 Economist Intelligence Unit

File 613:PR Newswire 1999-2006/Aug 11
(c) 2006 PR Newswire Association Inc

File 621:Gale Group New Prod. Annou. (R) 1985-2006/Aug 10
(c) 2006 The Gale Group

File 623:Business Week 1985-2006/Aug 11
(c) 2006 The McGraw-Hill Companies Inc

File 624:McGraw-Hill Publications 1985-2006/Aug 11
(c) 2006 McGraw-Hill Co. Inc

File 634:San Jose Mercury Jun 1985-2006/Aug 10
(c) 2006 San Jose Mercury News

File 635:Business Dateline(R) 1985-2006/Aug 11
(c) 2006 ProQuest Info&Learning

File 636:Gale Group Newsletter DB(TM) 1987-2006/Aug 10
(c) 2006 The Gale Group

File 647:CMP Computer Fulltext 1988-2006/Sep W3
(c) 2006 CMP Media, LLC

File 696:DIALOG Telecom. Newsletters 1995-2006/Aug 10

(c) 2006 Dialog
 File 674:Computer News Fulltext 1989-2006/Jul W5
 (c) 2006 IDG Communications
 File 810:Business Wire 1986-1999/Feb 28
 (c) 1999 Business Wire
 File 813:PR Newswire 1987-1999/Apr 30
 (c) 1999 PR Newswire Association Inc
 File 587:Jane`s Defense&Aerospace 2006/Aug W1
 (c) 2006 Jane`s Information Group

Set	Items	Description
S1	11113135	AUDIO? ? OR VIDEO?? OR MUSIC?? OR SONG?? OR MOVIE?? OR FILM? ?
S2	325971	(DOWNLOAD??? OR DOWN()LOAD???) (7N)S1
S3	1080058	(INTERNET??? OR ONLINE OR ON()LINE OR WEBSITE?? OR WWW OR -WEB()SITE??) (7N)S1
S4	727799	(NETWORK? ? OR WAN? ? OR LAN? ? OR NET()WORK?? OR INTRANET-??) (7N)S1
S5	911794	(BUY??? OR PUCHAS??? OR RENT??? OR PAY???? OR SELL??? OR SALE??? OR BOUGHT?? OR SOLD?? OR SHOPP????) (7N)S1
S6	101248	(CREDIT???? OR CHARG????) (5N)S1
S7	1988516	(STOR??? OR SAV???? OR RECORD???? OR TAP???) (5N)S1
S8	10223577	LIBRARY?? OR SERVER?? OR MEMORY?? OR STORAGE?? OR DATA() (BASE?? OR BANK??) OR DATABASE?? OR DATABANK?? OR BULLETIN()BOARD?? OR BBS
S9	1079207	AOL? ? OR COMPUSERV? ? OR COMPU()SERV? ? OR GENIE? ? OR PRODIGY? ? OR AMERICAN()ONLINE? ? OR EARTHLINK? ? OR EARTH()LINK?? OR DELPHI??
S10	2	AU=(HAIR A? OR HAIR, A?)
S11	1177	(S2 OR S3 OR S4) (S) (S5 OR S6) (S) (S7 OR S8) (S) S9
S12	667	RD (unique items)
S13	1	S12 NOT PY>1991
S14	40858	(S2 OR S3 OR S4) (S) (S5 OR S6) (S) (S7 OR S8)
S15	22672	RD (unique items)
S16	506	S15 NOT PY>1991
S17	29	S16(20N) (S2 OR S3)
S18	467	S16(20N)S5
S19	327	S18(20N)S7
S20	313	S19 NOT S17
S21	1	S20(S) (S2 OR S3)
S22	108579	(S2 OR S3) (30N)S5
S23	126	S22 NOT PY>1991
S24	102	RD (unique items)
S25	82	S24 NOT (S17 OR S13 OR S21)
S26	5	S25(S) (S7 OR S8)
S27	77	S25 NOT S26
	?	

File 348:EUROPEAN PATENTS 1978-2006/ 200632
(c) 2006 European Patent Office
File 349: PCT FULLTEXT 1979-2006/UB=20060803,UT=20060727
(c) 2006 WIPO/Univentio

Set	Items	Description
S1	578215	AUDIO? ? OR VIDEO?? OR MUSIC?? OR SONG?? OR MOVIE?? OR FILM? ?
S2	5048	(DOWNLOAD??? OR DOWN()LOAD???) (7N)S1
S3	13432	(INTERNET??? OR ONLINE OR ON()LINE OR WEBSITE?? OR WWW OR -WEB()SITE??) (7N)S1
S4	21562	(NETWORK? ? OR WAN? ? OR LAN? ? OR NET()WORK?? OR INTRANET-??) (7N)S1
S5	12242	(BUY??? OR PUCHAS??? OR RENT??? OR PAY???? OR SELL??? OR SALE??? OR BOUGHT?? OR SOLD?? OR SHOPP????) (7N)S1
S6	9341	(CREDIT???? OR CHARG????) (5N)S1
S7	87874	(STOR??? OR SAV???? OR RECORD???? OR TAP???) (5N)S1
S8	699969	LIBRARY?? OR SERVER?? OR MEMORY?? OR STORAGE?? OR DATA() (BASE?? OR BANK??) OR DATABASE?? OR DATABANK?? OR BULLETIN()BOARD?? OR BBS
S9	14228	AOL? ? OR COMPUSERV? ? OR COMPU()SERV? ? OR GENIE? ? OR PRODIGY? ? OR AMERICAN()ONLINE? ? OR EARTHLINK? ? OR EARTH()LINK?? OR DELPHI??
S10	7	AU=(HAIR A? OR HAIR, A?)
S11	12	(S2 OR S3 OR S4) (S) (S5 OR S6) (S) (S7 OR S8) (S) S9
S12	11	S11 NOT AD=19911211:19940811/PR
S13	8	S12 NOT AD=19940811:19970811/PR
S14	1	S13 NOT AD=19970811:20000811/PR
S15	842	(S2 OR S3 OR S4) (S) (S5 OR S6) (S) (S7 OR S8)
S16	811	S15 NOT AD=19911211:19940811/PR
S17	731	S16 NOT AD=19940811:19970811/PR
S18	439	S17 NOT AD=19970811:20000811/PR
S19	162	S18 NOT AD=20000811:20030811/PR
S20	32	S19 NOT AD=20030811:20060811/PR
S21	1499	(S2 OR S3 OR S4) (35N) (S5 OR S6)
S22	791	S21 NOT S15
S23	670	S22 NOT AD=20030811:20060811/PR
S24	405	S23 NOT AD=20000811:20030811/PR
S25	138	S24 NOT AD=19970811:20000811/PR
S26	51	S25 NOT AD=19940811:19970811/PR
S27	51	S26 NOT (S13 OR S20)
S28	28	S27 NOT AD=19911211:19940811/PR
S29	3	S10 AND (S2 OR S3 OR S4) AND (S5 OR S6)
S30	3	S29 NOT (S13 OR S14 OR S20 OR S26)

File 344:Chinese Patents Abs Jan 1985-2006/Jan
(c) 2006 European Patent Office
File 347:JAPIO Dec 1976-2005/Dec(Updated, 060404)
(c) 2006 JPO & JAPIO
File 350:Derwent WPIX 1963-2006/UD=200651
(c) 2006 The Thomson Corporation

Set	Items	Description
S1	2263545	AUDIO? ? OR VIDEO?? OR MUSIC?? OR SONG?? OR MOVIE?? OR FILM? ?
S2	2436	(DOWNLOAD??? OR DOWN()LOAD???) (7N)S1
S3	9494	(INTERNET??? OR ONLINE OR ON()LINE OR WEBSITE?? OR WWW OR -WEB()SITE??) (7N)S1
S4	16744	(NETWORK? ? OR WAN? ? OR LAN? ? OR NET()WORK?? OR INTRANET-??) (7N)S1
S5	11278	(BUY??? OR PUCHAS??? OR RENT??? OR PAY???? OR SELL??? OR SALE??? OR BOUGHT?? OR SOLD?? OR SHOPP????) (7N)S1
S6	14071	(CREDIT???? OR CHARG????) (5N)S1
S7	334872	(STOR??? OR SAV???? OR RECORD???? OR TAP???) (5N)S1
S8	2286571	LIBRARY?? OR SERVER?? OR MEMORY?? OR STORAGE?? OR DATA() (B-ASE?? OR BANK??) OR DATABASE?? OR DATABANK?? OR BULLETIN()BOA-RD?? OR BBS
S9	1256	AOL? ? OR COMPUSERV? ? OR COMPU()SERV? ? OR GENIE? ? OR PR-ODIGY? ? OR AMERICAN()ONLINE? ? OR EARTHLINK? ? OR EARTH()LIN-K?? OR DELPHI??
S10	9	AU=(HAIR A? OR HAIR, A?)
S11	724	(S2 OR S3) AND S5
S12	714	S11 NOT AD=19911211:19940811/PR
S13	680	S12 NOT AD=19940811:19970811/PR
S14	442	S13 NOT AD=19970811:20000811/PR
S15	120	S14 NOT AD=20000811:20030811/PR
S16	0	S15 NOT AD=20030811:20060811/PR
S17	240	(S2 OR S3 OR S4) AND S6
S18	234	S17 NOT AD=19911211:19940811/PR
S19	205	S18 NOT AD=19940811:19970811/PR
S20	156	S19 NOT AD=19970811:20000811/PR
S21	156	S20 NOT AD=19970811:20000811/PR
S22	39	S21 NOT AD=20000811:20030811/PR
S23	39	S22 NOT AD=20000811:20030811/PR
S24	13	S23 NOT AD=20030811:20060811/PR
S25	4	S10 AND (S5 OR S6)
S26	4	S25 AND (S1 OR S2 OR S3)
S27	474	S4 AND S5
S28	449	S27 NOT AD=19911211:19940811/PR
S29	395	S28 NOT AD=19940811:19970811/PR
S30	255	S29 NOT AD=19970811:20000811/PR
S31	85	S30 NOT AD=20000811:20030811/PR
S32	27	S31 NOT AD=20030811:20060811/PR
S33	25	S32 NOT (S24 OR S25)

File 344:Chinese Patents Abs Jan 1985-2006/Jan
(c) 2006 European Patent Office
File 347:JAPIO Dec 1976-2005/Dec(Updated 060404)
(c) 2006 JPO & JAPIO
File 350:Derwent WPIX 1963-2006/UD=20065d
(c) 2006 The Thomson Corporation

Set	Items	Description
S1	2263545	AUDIO? ? OR VIDEO?? OR MUSIC?? OR SONG?? OR MOVIE?? OR FILM? ?
S2	2436	(DOWNLOAD??? OR DOWN()LOAD???) (7N)S1
S3	9494	(INTERNET??? OR ONLINE OR ON()LINE OR WEBSITE?? OR WWW OR -WEB()SITE??) (7N)S1
S4	16744	(NETWORK? ? OR WAN? ? OR LAN? ? OR NET()WORK?? OR INTRANET-??) (7N)S1
S5	11278	(BUY??? OR PUCHAS??? OR RENT??? OR PAY???? OR SELL??? OR SALE??? OR BOUGHT?? OR SOLD?? OR SHOPP????) (7N)S1
S6	14071	(CREDIT???? OR CHARG????) (5N)S1
S7	334872	(STOR??? OR SAV???? OR RECORD???? OR TAP???) (5N)S1
S8	2286571	LIBRARY?? OR SERVER?? OR MEMORY?? OR STORAGE?? OR DATA() (B-ASE?? OR BANK??) OR DATABASE?? OR DATABANK?? OR BULLETIN()BOA-RD?? OR BBS
S9	1256	AOL? ? OR COMPUSERV? ? OR COMPU()SERV? ? OR GENIE? ? OR PR-ODIGY? ? OR AMERICAN()ONLINE? ? OR EARTHLINK? ? OR EARTH()LIN-K?? OR DELPHI??
S10	9	AU=(HAIR A? OR HAIR, A?)'
S11	1	(S2 OR S3 OR S4) AND (S5 OR S6) AND (S7 OR S8) AND S9
S12	837	(S2 OR S3 OR S4) AND (S5 OR S6) AND (S7 OR S8)
S13	819	S12 NOT AD=19911211:19940811/PR
S14	747	S13 NOT AD=19940811:19970811/PR
S15	515	S14 NOT AD=19970811:20000811/PR
S16	124	S15 NOT AD=20000811:20030811/PR
S17	10	S16 NOT AD=20030811:20060811/PR
S18	1	S10 AND (S2 OR S3 OR S4)
S19	1	S18 NOT (S11 OR S17)

File 2:INSPEC 1898-2006/Jul W5
(c) 2006 Institution of Electrical Engineers
File 6:NTIS 1964-2006/Jul W5
(c) 2006 NTIS, Intl Cpyrght All Rights Res
File 8:EI Compendex(R) 1970-2006/Jul W5
(c) 2006 Elsevier Eng. Info. Inc.
File 34:SciSearch(R) Cited Ref Sci 1990-2006/Aug W1
(c) 2006 The Thomson Corp
File 35:Dissertation Abs Online 1861-2006/Jun
(c) 2006 ProQuest Info&Learning
File 56:Computer and Information Systems Abstracts 1966-2006/Jul
(c) 2006 CSA.
File 57:Electronics & Communications Abstracts 1966-2006/Jul
(c) 2006 CSA.
File 65:Inside Conferences 1993-2006/Aug 11
(c) 2006 BLDSC all rts. reserv.
File 94:JICST-EPlus 1985-2006/Apr W5
(c)2006 Japan Science and Tech Corp(JST)
File 95:TEME-Technology & Management 1989-2006/Aug W1
(c) 2006 FIZ TECHNIK
File 99:Wilson Appl. Sci & Tech Abs 1983-2006/Jul
(c) 2006 The HW Wilson Co.
File 144:Pascal 1973-2006/Jul W3
(c) 2006 INIST/CNRS
File 239:Mathsci 1940-2006/Sep
(c) 2006 American Mathematical Society
File 434:SciSearch(R) Cited Ref Sci 1974-1989/Dec
(c) 2006 The Thomson Corp
File 583:Gale Group Globalbase(TM) 1986-2002/Dec 13
(c) 2002 The Gale Group
File 603:Newspaper Abstracts 1984-1988
(c)2001 ProQuest Info&Learning
File 483:Newspaper Abs Daily 1986-2006/Aug 09
(c) 2006 ProQuest Info&Learning
File 248:PIRA 1975-2006/Jul W4
(c) 2006 Pira International

Set	Items	Description
S1	3886257	AUDIO? ? OR VIDEO?? OR MUSIC?? OR SONG?? OR MOVIE?? OR FILM? ?
S2	3697	(DOWNLOAD??? OR DOWN()LOAD???) (7N)S1
S3	25646	(INTERNET??? OR ONLINE OR ON()LINE OR WEBSITE?? OR WWW OR -WEB()SITE??) (7N)S1
S4	48990	(NETWORK? ? OR WAN? ? OR LAN? ? OR NET()WORK?? OR INTRANET-??) (7N)S1
S5	32572	(BUY??? OR PUCHAS??? OR RENT??? OR PAY???? OR SELL??? OR S-ALE??? OR BOUGHT?? OR SOLD?? OR SHOPP????) (7N)S1
S6	34810	(CREDIT???? OR CHARG????) (5N)S1
S7	255889	(STOR??? OR SAV???? OR RECORD???? OR TAP???) (5N)S1
S8	2985962	LIBRARY?? OR SERVER?? OR MEMORY?? OR STORAGE?? OR DATA() (B-ASE?? OR BANK??) OR DATABASE?? OR DATABANK?? OR BULLETIN()BOA-RD?? OR BBS
S9	222805	AOL? ? OR COMPUSERV? ? OR COMPU()SERV? ? OR GENIE? ? OR PR-ODIGY? ? OR AMERICAN()ONLINE? ? OR EARTHLINK? ? OR EARTH()LIN-K?? OR DELPHI??
S10	40	AU=(HAIR A? OR HAIR, A?)
S11	67	(S2 OR S3 OR S4) AND (S5 OR S6) AND (S7 OR S8) AND S9
S12	67	RD (unique items)
S13	1	S12 NOT PY>1991
S14	1506	(S2 OR S3 OR S4) AND (S5 OR S6) AND (S7 OR S8)
S15	1449	RD (unique items)

S16	37	S15 NOT PY>1991
S17	36	S16 NOT S13
S18	2643	(S2 OR S3) AND S5
S19	2575	RD (unique items)
S20	7	S19 NOT PY>1991
S21	3	S20 NOT (S17 OR S13)
S22	0	S10 AND (S5 OR S6)

EAST Search History

Ref #	Hits	Search Query	DBs	Default Operator	Plurals	Time Stamp
L1	0	(704/104.1).CCLS.	US-PGPUB; USPAT	OR	OFF	2006/08/15 13:01
L2	5335	(707/104.1).CCLS.	US-PGPUB; USPAT	OR	OFF	2006/08/15 13:01
L3	107	2 and @ad<="19920101"	US-PGPUB; USPAT	OR	ON	2006/08/15 13:02
L4	991	2 and @ad<="19980101"	US-PGPUB; USPAT	OR	ON	2006/08/15 13:50
L5	378	4 and (voice or audio or movies or music)	US-PGPUB; USPAT	OR	ON	2006/08/15 13:51
L6	7290	(709/217,219).CCLS.	US-PGPUB; USPAT	OR	OFF	2006/08/15 13:50
L7	1038	6 and @ad<="19980101"	US-PGPUB; USPAT	OR	ON	2006/08/15 13:50
L8	530	7 and (voice or audio or movies or music)	US-PGPUB; USPAT	OR	ON	2006/08/15 13:51
L9	254	8 and (download\$ or (down adj load))	US-PGPUB; USPAT	OR	ON	2006/08/15 13:51
S1	1	("5191573").PN.	US-PGPUB; USPAT	OR	OFF	2006/04/24 08:02
S2	1	("4528643").PN.	US-PGPUB; USPAT	OR	OFF	2006/04/20 11:59
S3	2	((("5675734") or ("5996440")).PN.	US-PGPUB; USPAT	OR	OFF	2006/04/20 12:00
S4	2	((("5675734") or ("5966440")).PN.	US-PGPUB; USPAT	OR	OFF	2006/04/20 12:00
S5	1	("4499568").PN.	US-PGPUB; USPAT	OR	OFF	2006/04/20 14:50
S19	54273	"379"/\$.ccls.	US-PGPUB; USPAT	OR	ON	2006/04/24 08:17
S20	12829	S19 and (audio or (voice adj message))	US-PGPUB; USPAT	OR	ON	2006/04/24 08:17
S21	2884	S20 and (subscribe or subscription or buy or (credit adj card))	US-PGPUB; USPAT	OR	ON	2006/04/24 09:30
S22	267	S21 and @pn < "5300000"	US-PGPUB; USPAT	OR	ON	2006/04/24 08:44
S23	3895	"pay-per-view" or (pay adj3 view) and "379"/\$.ccls.	US-PGPUB; USPAT	OR	ON	2006/04/24 09:08
S24	164	S23 and @pn < "5300000"	US-PGPUB; USPAT	OR	ON	2006/04/24 09:08
S25	4008	"pay-per-view" or (pay adj3 view) and isdn	US-PGPUB; USPAT	OR	ON	2006/04/24 09:08

EAST Search History

S26	705	("pay-per-view" or (pay adj3 view)) and isdn	US-PGPUB; USPAT	OR	ON	2006/04/24 09:09
S27	707	("pay-per-view" or (pay adj3 view)) and (isdn or idsn)	US-PGPUB; USPAT	OR	ON	2006/04/24 09:11
S28	6	S27 and @pn < "5300000"	US-PGPUB; USPAT	OR	ON	2006/04/24 09:09
S29	2964	music and (isdn or idsn)	US-PGPUB; USPAT	OR	ON	2006/04/24 09:11
S30	34	S29 and @pn < "5300000"	US-PGPUB; USPAT	OR	ON	2006/04/24 09:11
S31	23	("3766324" "4332980" "4381522" "4506387" "4654866" "4755872" "4761684" "4763191" "4792849" "4797913" "4807023" "4829372" "4849811" "4852154" "4890320" "4897867" "4949187" "4995078" "5010399" "5014125" "5130792" "5132992" "5133079").PN.	US-PGPUB; USPAT; USOCR	OR	ON	2006/04/24 09:21
S32	572	(videotex or videotext or (video adj tex) or (video adj text)) and isdn	US-PGPUB; USPAT; USOCR	OR	ON	2006/04/24 09:22
S33	23	S32 and @pn < "5300000"	US-PGPUB; USPAT; USOCR	OR	ON	2006/04/24 09:24
S34	652	((bulletin or Bulletin) adj board) and modem and music and (buy or order or credit)	US-PGPUB; USPAT; USOCR	OR	ON	2006/04/24 09:26
S35	1	S34 and @pn < "5300000"	US-PGPUB; USPAT; USOCR	OR	ON	2006/04/24 09:25
S36	1973	((bulletin or Bulletin) adj board) and modem and video and (buy or order or credit)	US-PGPUB; USPAT; USOCR	OR	ON	2006/04/24 09:27
S39	12	S36 and @pn < "5300000"	US-PGPUB; USPAT; USOCR	OR	ON	2006/04/24 09:28
S40	2126	((bulletin or Bulletin) adj board) and modem and video	US-PGPUB; USPAT; USOCR	OR	ON	2006/04/24 09:27
S41	14	S40 and @pn < "5300000"	US-PGPUB; USPAT; USOCR	OR	ON	2006/04/24 09:29
S42	16087	isdn and video	US-PGPUB; USPAT; USOCR	OR	ON	2006/04/24 09:30

EAST Search History

S43	329	S42 and @pn < "5300000"	US-PGPUB; USPAT; USOCR	OR	ON	2006/04/24 09:30
S44	42	S43 and (subscribe or subscription or buy or (credit adj card))	US-PGPUB; USPAT	OR	ON	2006/04/24 09:30
S45	18	(US-3718906-\$ or US-4071697-\$ or US-4500751-\$ or US-4567359-\$ or US-4649533-\$ or US-4694490-\$ or US-4789863-\$ or US-4792849-\$ or US-4837797-\$ or US-4852154-\$ or US-4665516-\$ or US-4710955-\$ or US-4829569-\$ or US-4890319-\$ or US-4893248-\$ or US-5130792-\$ or US-4849811-\$ or US-4924492-\$).did.	USPAT	OR	ON	2006/04/24 10:59
S46	1	("4789868").PN.	US-PGPUB; USPAT	OR	OFF	2006/04/24 11:00
S47	18	(US-4694490-\$ or US-4649533-\$ or US-4567359-\$ or US-4500751-\$ or US-4893248-\$ or US-4890319-\$ or US-4789863-\$ or US-4852154-\$ or US-4837797-\$ or US-4792849-\$ or US-4071697-\$ or US-3718906-\$ or US-4710955-\$ or US-4665516-\$ or US-4829569-\$ or US-4849811-\$ or US-4924492-\$ or US-5130792-\$).did.	USPAT	OR	ON	2006/04/24 12:39
S48	15	("3718906" "4163254" "4272791" "4300040" "4359631" "4433207" "4471379" "4506387" "4513315" "4538176" "4567512" "4590516" "4685131" "4700386" "Re31639").PN.	US-PGPUB; USPAT; USOCR	OR	ON	2006/04/24 12:50
S49	45	("4789863").URPN.	USPAT	OR	ON	2006/04/24 13:43
S50	3	((("5191573") or ("5966440") or ("5675734")).PN.	US-PGPUB; USPAT	OR	OFF	2006/04/24 13:44
S51	14	("3718906" "3990710" "4124773" "4506387" "4521806" "4528643" "4538176" "4567359" "4647989" "4654799" "4789863" "4789868" "5191193" "5191573").PN.	US-PGPUB; USPAT; USOCR	OR	ON	2006/04/24 13:44
S52	44	("4124773").URPN.	USPAT	OR	ON	2006/04/24 13:50
S53	1070	(455/412.1).CCLS.	US-PGPUB; USPAT	OR	OFF	2006/04/24 13:50
S54	0	("7and@pn<5200000").PN.	US-PGPUB; USPAT	OR	OFF	2006/04/24 13:51
S55	11	S53 and (@pn < "5200000")	US-PGPUB; USPAT	OR	ON	2006/04/24 13:53
S56	593	(379/88.13).CCLS.	US-PGPUB; USPAT	OR	OFF	2006/04/24 14:03

EAST Search History

S57	27	S56 and (@pn < "5200000")	US-PGPUB; USPAT	OR	ON	2006/04/24 14:04
S58	740	(379/88.17).CCLS.	US-PGPUB; USPAT	OR	OFF	2006/04/24 14:03
S59	6	S58 and (@pn < "5200000")	US-PGPUB; USPAT	OR	ON	2006/04/24 14:04
S60	10567	(video and (charge or buy or credit)) and (@pn < "5200000")	US-PGPUB; USPAT	OR	ON	2006/04/24 14:05
S61	430	(video and (credit adj card)) and (@pn < "5200000")	US-PGPUB; USPAT	OR	ON	2006/04/24 15:36
S62	181	S61 and network	US-PGPUB; USPAT	OR	ON	2006/04/24 14:06
S63	243	(video and audio and (download\$ or (down adj load\$))) and (@pn < "5200000")	US-PGPUB; USPAT	OR	ON	2006/04/24 14:13
S64	157	S63 and network	US-PGPUB; USPAT	OR	ON	2006/04/24 14:13
S65	209	S63 and (network or communication)	US-PGPUB; USPAT	OR	ON	2006/04/24 14:14
S66	38	("3599178" "3746780" "4009344" "4009346" "4028733" "4062043" "4071697" "4122299" "4381522" "4400717" "4450477" "4506387" "4518989" "4521806" "4533936" "4538176" "4567512" "4590516" "4679079" "4688246" "4734765" "4755872" "4763191" "4785349" "4807023" "4833710" "4847677" "4868653" "4890320" "4907081" "4914508" "4920432" "4937821" "4947244" "4949169" "4949187" "4963995" "5032927").PN.	US-PGPUB; USPAT; USOCR	OR	ON	2006/04/24 15:30
S67	4	((("4963995") or ("5995705") or ("5057932") or ("5164839")).PN.	US-PGPUB; USPAT	OR	OFF	2006/04/24 15:32
S68	9	("4179709" "4400717" "4516156" "4698664" "4709418" "4724491" "4768110" "4774574" "4851931"). PN.	US-PGPUB; USPAT; USOCR	OR	ON	2006/04/24 15:35
S69	29448	audio and video and (hard adj (drive or disk)) and network	US-PGPUB; USPAT; USOCR	OR	ON	2006/04/24 15:36
S70	104	S69 and (@pn < "5200000")	US-PGPUB; USPAT	OR	ON	2006/04/24 16:28
S71	4959	music same download\$	US-PGPUB; USPAT	OR	ON	2006/04/24 16:28
S72	7	S71 and (@pn < "5200000")	US-PGPUB; USPAT	OR	ON	2006/04/24 16:32

EAST Search History

S73	1	("4949187").PN.	US-PGPUB; USPAT	OR	OFF	2006/04/24 16:30
S74	7	("3718906" "3990710" "4232295" "4597058" "4597098" "4769833" "4789961").PN.	US-PGPUB; USPAT; USOCR	OR	ON	2006/04/24 16:30
S75	261	("4949187").URPN.	USPAT	OR	ON	2006/04/24 16:32
S76	1372	music and isdn	USPAT	OR	ON	2006/04/24 16:32
S77	27	S76 and (@pn < "5200000")	US-PGPUB; USPAT	OR	ON	2006/04/24 16:45
S78	394	audio and music and (download\$ or (down adj load\$))	EPO; JPO; DERWENT; IBM_TDB	OR	ON	2006/04/24 16:40
S79	24	audio and music and isdn	EPO; JPO; DERWENT; IBM_TDB	OR	ON	2006/04/24 16:41
S80	341	audio and video and isdn	EPO; JPO; DERWENT; IBM_TDB	OR	ON	2006/04/24 16:42
S81	690	audio and video and (charge or buy or (credit adj card))	EPO; JPO; DERWENT; IBM_TDB	OR	ON	2006/04/24 16:43
S82	192	audio and video and (charge or buy or (credit adj card)) and (communications or network)	EPO; JPO; DERWENT; IBM_TDB	OR	ON	2006/04/24 16:44
S83	56788	(digital adj3 (audio or video)) and (network or communication)	US-PGPUB; USPAT	OR	ON	2006/04/24 16:45
S84	2209	S83 and (@pn < "5200000")	US-PGPUB; USPAT	OR	ON	2006/04/24 16:45
S85	12261	(digital adj3 (audio or video)) and (network or communication) and (buy or charge or (credit adj card))	US-PGPUB; USPAT	OR	ON	2006/04/24 17:06
S86	448	S85 and (@pn < "5200000")	US-PGPUB; USPAT	OR	ON	2006/04/24 17:06
S87	5130	(digital adj3 (audio or video)) and (network or communication) and (buy or (credit adj card))	US-PGPUB; USPAT	OR	ON	2006/04/24 17:06
S88	9207	(digital adj3 (audio or video)) and (network or communication) and (buy or purchase or (credit adj card))	US-PGPUB; USPAT	OR	ON	2006/04/24 17:06
S89	105	S88 and (@pn < "5200000")	US-PGPUB; USPAT	OR	ON	2006/04/24 17:40
S90	41	(real adj audio) and (bulletin adj board)	US-PGPUB; USPAT	OR	ON	2006/04/24 17:40
S91	41	(real adj audio) and (bulletin adj board)	US-PGPUB; USPAT	OR	ON	2006/04/24 17:40

EAST Search History

S92	41	(real adj audio) and (bull\$1tin adj board)	US-PGPUB; USPAT	OR	ON	2006/04/24 17:41
S94	104	(bull\$1tin adj board) and (download\$ near3 audio)	US-PGPUB; USPAT	OR	ON	2006/04/24 17:42
S95	13	(bull\$1tin adj board) and kermit	US-PGPUB; USPAT	OR	ON	2006/04/24 17:44
S96	3548	(bull\$1tin adj board) and (audio or video)	US-PGPUB; USPAT	OR	ON	2006/04/24 17:43
S97	204	(computer adj bull\$1tin adj board)	US-PGPUB; USPAT	OR	ON	2006/04/24 17:44
S98	116	(computer adj bull\$1tin adj board) and (audio and video)	US-PGPUB; USPAT	OR	ON	2006/04/25 13:12
S99	101	zmodem	US-PGPUB; USPAT	OR	ON	2006/04/25 13:12
S10 0	33	zmodem and audio	US-PGPUB; USPAT	OR	ON	2006/04/25 13:13
S10 1	41	zmodem and video	US-PGPUB; USPAT	OR	ON	2006/04/25 13:14
S10 2	46	ymodem	US-PGPUB; USPAT	OR	ON	2006/04/25 13:14
S10 3	33	S102 and (audio or video)	US-PGPUB; USPAT	OR	ON	2006/04/25 13:15
S10 4	159	xmodem	US-PGPUB; USPAT	OR	ON	2006/04/25 13:15
S10 5	82	S104 and (audio or video)	US-PGPUB; USPAT	OR	ON	2006/04/25 13:17
S10 6	4094	download\$ adj5 (audio or video)	US-PGPUB; USPAT	OR	ON	2006/04/25 13:17
S10 7	39	S106 and @pn < "5300000"	US-PGPUB; USPAT	OR	ON	2006/04/25 13:17
S10 8	32	("3263158" "4529870" "4658093" "4924378" "4932054" "4937863" "4953209" "4961142" "4977594" "5010571" "5014234" "5023907" "5047928" "5050213" "5058164" "5103476" "5113519" "5146499" "5159182" "5191193" "5204897" "5235642" "5247575" "5260999" "5263157" "5291596" "5339091" "5432849" "5438508" "5504814" "5530235").PN.	US-PGPUB; USPAT; USOCR	OR	ON	2006/04/25 14:11
S10 9	1	("4636876").PN.	US-PGPUB; USPAT	OR	OFF	2006/04/25 14:44
S11 0	5	((("5428606") or ("5132992") or ("5130792") or ("4999806") or ("re35184")).PN.	US-PGPUB; USPAT	OR	OFF	2006/04/25 14:49

EAST Search History

S11 1	7	((("3244809") or ("3696297") or ("3718906") or ("3824597") or ("3947882") or ("3990710") or ("4028733")).PN.	US-PGPUB; USPAT	OR	OFF	2006/04/25 14:51
S11 2	11	((("4124773") or ("4300040") or ("4335809") or ("4370649") or ("4422093") or ("4499568") or ("4506387") or ("4520404") or ("4521806") or ("4521857") or ("4586430")).PN.	US-PGPUB; USPAT	OR	OFF	2006/04/25 15:04
S11 3	12	((("4533948") or ("4536856") or ("4538176") or ("4567359") or ("4567512") or ("4605973") or ("4647989") or ("4648037") or ("4658093") or ("4667802") or ("4672613") or ("4674055")).PN.	US-PGPUB; USPAT	OR	OFF	2006/04/25 15:05
S11 4	12	((("4688105") or ("4703465") or ("4725977") or ("4739510") or ("4754483") or ("4755872") or ("4759060") or ("4761684") or ("4763317") or ("4766581") or ("4787050") or ("4789863")).PN.	US-PGPUB; USPAT	OR	OFF	2006/04/25 15:27
S11 5	12	((("4792849") or ("4797918") or ("4829372") or ("4894789") or ("4918588") or ("4949187") or ("5003384") or ("5019900") or ("5041921") or ("5089885") or ("5099422") or ("5191410")).PN.	US-PGPUB; USPAT	OR	OFF	2006/04/25 16:20
S11 6	7	compusonic	US-PGPUB; USPAT	OR	ON	2006/04/25 16:22
S11 7	5322	bbs and (audio or video)	US-PGPUB; USPAT	OR	ON	2006/04/25 16:33
S11 8	739	S117 and @pn < "5300000"	US-PGPUB; USPAT	OR	ON	2006/04/25 16:33
S11 9	1661	bbs and (audio and video)	US-PGPUB; USPAT	OR	ON	2006/04/25 16:33
S12 0	95	S119 and @pn < "5300000"	US-PGPUB; USPAT	OR	ON	2006/04/25 17:05
S12 1	2	((("4870515") or ("4528643")).PN.	US-PGPUB; USPAT	OR	OFF	2006/04/25 17:05

EAST Search History

S12 2	40	(US-4694490-\$ or US-4649533-\$ or US-4567359-\$ or US-4500751-\$ or US-4893248-\$ or US-4890319-\$ or US-4789863-\$ or US-4852154-\$ or US-4837797-\$ or US-4792849-\$ or US-4071697-\$ or US-3718906-\$ or US-4710955-\$ or US-4665516-\$ or US-4829569-\$ or US-4849811-\$ or US-4924492-\$ or US-5130792-\$ or US-4538176-\$ or US-4300040-\$ or US-4521806-\$ or US-4124773-\$ or US-4829372-\$ or US-4916737-\$ or US-4623920-\$ or US-4866770-\$).did. or (US-4956768-\$ or US-4949187-\$ or US-4920432-\$ or US-4894789-\$ or US-4839745-\$ or US-5113518-\$ or US-4872151-\$ or US-4724521-\$ or US-5083271-\$ or US-4658093-\$ or US-4499568-\$ or US-4422093-\$ or US-5003384-\$ or US-4935870-\$).did.	USPAT	OR	ON	2006/04/26 08:38
S12 3	56	("3347988" "3444324" "3444550" "3448216" "3471648" "3590381" "3969680").PN. OR ("4124773").URPN.	US-PGPUB; USPAT; USOCR	OR	ON	2006/04/26 09:02
S12 4	14870	music and (hard adj (drive or disk))	US-PGPUB; USPAT; USOCR	OR	ON	2006/04/26 09:28
S12 5	165	S124 and @pn < "5300000"	US-PGPUB; USPAT; USOCR	OR	ON	2006/04/26 09:29
S12 6	36749	audio and video and (hard adj (drive or disk))	US-PGPUB; USPAT; USOCR	OR	ON	2006/04/26 10:09
S12 7	373	S126 and @pn < "5300000"	US-PGPUB; USPAT; USOCR	OR	ON	2006/04/26 09:29
S12 8	7619	audio same video same (hard adj (drive or disk))	US-PGPUB; USPAT; USOCR	OR	ON	2006/04/26 09:54
S12 9	82	S128 and @pn < "5300000"	US-PGPUB; USPAT; USOCR	OR	ON	2006/04/26 09:55
S13 0	1863	((audio or video) near5 (stored or store or storing)) near5 (hard adj (drive or disk))	US-PGPUB; USPAT; USOCR	OR	ON	2006/04/26 10:09
S13 1	11	S130 and @pn < "5300000"	US-PGPUB; USPAT; USOCR	OR	ON	2006/04/26 10:10
S13 2	34	(disk adj streamer)	US-PGPUB; USPAT; USOCR	OR	ON	2006/04/26 09:58

EAST Search History

S13 3	109	(audio and video and (hard adj (drive or disk))).ab.	US-PGPUB; USPAT; USOCR	OR	ON	2006/04/26 10:10
S13 4	440	((hard adj (drive or disk)) and (audio or video)).ab.	US-PGPUB; USPAT; USOCR	OR	ON	2006/04/26 10:11
S13 5	8	S134 and @pn < "5300000"	US-PGPUB; USPAT; USOCR	OR	ON	2006/04/26 10:21
S13 6	6078	((hard adj (drive or disk)) and (audio or video)).ab.	EPO; JPO; DERWENT	OR	ON	2006/04/26 10:12
S13 7	1784	((hard adj (drive or disk)) and (audio and video)).ab.	EPO; JPO; DERWENT	OR	ON	2006/04/26 10:20
S13 8	327	((hard adj (drive or disk)) near5 (audio and video)).ab.	EPO; JPO; DERWENT	OR	ON	2006/04/26 10:12
S13 9	2956	media near5 (hard adj (drive or disk))	EPO; JPO; DERWENT	OR	ON	2006/04/26 10:21
S14 0	2442	media near5 (hard adj (drive or disk)).ab.	EPO; JPO; DERWENT	OR	ON	2006/04/26 10:21
S14 1	19496	media near5 (hard adj (drive or disk))	USPAT	OR	ON	2006/04/26 10:21
S14 2	434	S141 and @pn < "5300000"	US-PGPUB; USPAT; USOCR	OR	ON	2006/04/26 10:53
S14 3	163	S142 and (video or audio)	US-PGPUB; USPAT; USOCR	OR	ON	2006/04/26 10:50
S14 4	70	adlib	US-PGPUB; USPAT; USOCR	OR	ON	2006/04/26 10:51
S14 5	90	jukebox and (sound adj card)	US-PGPUB; USPAT; USOCR	OR	ON	2006/04/26 10:53
S14 6	1431	library and (sound adj card)	US-PGPUB; USPAT; USOCR	OR	ON	2006/04/26 10:53
S14 7	0	S146 and @pn < "5300000"	US-PGPUB; USPAT; USOCR	OR	ON	2006/04/26 10:53
S14 8	0	".wav" and (sound adj card)	US-PGPUB; USPAT; USOCR	OR	ON	2006/04/26 10:53
S14 9	534	".wav" and (sound adj card)	US-PGPUB; USPAT; USOCR	OR	ON	2006/04/26 10:53

EAST Search History

S15 0	0	S149 and @pn < "5300000"	US-PGPUB; USPAT; USOCR	OR	ON	2006/04/26 10:57
S15 1	1269	(digital adj audio) same (hard adj (drive or disk))	US-PGPUB; USPAT; USOCR	OR	ON	2006/04/26 10:56
S15 2	27	S151 and @pn < "5300000"	US-PGPUB; USPAT; USOCR	OR	ON	2006/04/26 11:16
S15 3	934	(compact adj disc adj player) and (hard adj (drive or disk))	US-PGPUB; USPAT; USOCR	OR	ON	2006/04/26 11:18
S15 4	41	S153 and @pn < "5300000"	US-PGPUB; USPAT; USOCR	OR	ON	2006/04/26 11:21
S15 5	517	(compact adj disc adj player) and menu	US-PGPUB; USPAT; USOCR	OR	ON	2006/04/26 11:21
S15 6	30	S155 and @pn < "5300000"	US-PGPUB; USPAT; USOCR	OR	ON	2006/04/26 14:10
S15 7	2921	(compact adj disc) and (artist or composer)	US-PGPUB; USPAT; USOCR	OR	ON	2006/04/26 11:21
S15 8	192	(compact adj disc) and (search near5 (artist or composer))	US-PGPUB; USPAT; USOCR	OR	ON	2006/04/26 11:21
S15 9	1	S158 and @pn < "5300000"	US-PGPUB; USPAT; USOCR	OR	ON	2006/04/26 11:39
S16 0	8	("3999050" "4279022" "4628193" "4634845" "4912640" "4961158" "5047614" "Re32655").PN.	US-PGPUB; USPAT; USOCR	OR	ON	2006/04/26 11:39
S16 1	12167	mpeg and (hard adj (disk or drive))	US-PGPUB; USPAT; USOCR	OR	ON	2006/04/26 11:39
S16 2	1	S159 and @pn < "5300000"	US-PGPUB; USPAT; USOCR	OR	ON	2006/04/26 12:25
S16 3	22	"4870515"	US-PGPUB; USPAT; USOCR	OR	ON	2006/04/26 12:25

EAST Search History

S16 4	52	(US-4694490-\$ or US-4649533-\$ or US-4567359-\$ or US-4500751-\$ or US-4893248-\$ or US-4890319-\$ or US-4789863-\$ or US-4852154-\$ or US-4837797-\$ or US-4792849-\$ or US-4071697-\$ or US-3718906-\$ or US-4710955-\$ or US-4665516-\$ or US-4829569-\$ or US-4849811-\$ or US-4924492-\$ or US-5130792-\$ or US-4538176-\$ or US-4300040-\$ or US-4521806-\$ or US-4124773-\$ or US-4829372-\$ or US-4916737-\$ or US-4623920-\$ or US-4866770-\$).did. or (US-4956768-\$ or US-4949187-\$ or US-4920432-\$ or US-4894789-\$ or US-4839745-\$ or US-5113518-\$ or US-4872151-\$ or US-4724521-\$ or US-5083271-\$ or US-4658093-\$ or US-4499568-\$ or US-4422093-\$ or US-5003384-\$ or US-4935870-\$ or US-4864301-\$ or US-4905003-\$ or US-5065345-\$ or US-5041921-\$ or US-5040110-\$ or US-5034980-\$ or US-5012334-\$ or US-4974178-\$ or US-4851931-\$ or US-4763207-\$ or US-4527262-\$ or US-4873589-\$).did.	USPAT	OR	ON	2006/04/26 14:09
S16 6	8	S164 and record.ab.	USPAT	OR	ON	2006/04/26 12:48
S16 7	2799	video adj clips	USPAT	OR	ON	2006/04/26 14:09
S16 8	19	S167 and @pn < "5300000"	US-PGPUB; USPAT; USOCR	OR	ON	2006/04/26 14:14
S16 9	7	((download or downloading) adj3 video) and @pn < "5300000"	US-PGPUB; USPAT; USOCR	OR	ON	2006/04/26 14:13
S17 0	343	videotext	US-PGPUB; USPAT; USOCR	OR	ON	2006/04/26 14:13
S17 1	118	S170 and @pn < "5300000"	US-PGPUB; USPAT; USOCR	OR	ON	2006/04/26 14:14
S17 2	1	("5191573").PN.	US-PGPUB; USPAT	OR	OFF	2006/08/11 11:44

EAST Search History

S17 3	53	(US-4916737-\$ or US-4789863-\$ or US-4665516-\$ or US-4694490-\$ or US-5003384-\$ or US-4890319-\$ or US-4071697-\$ or US-4567359-\$ or US-4893248-\$ or US-4724521-\$ or US-4837797-\$ or US-4710955-\$ or US-4500751-\$ or US-3718906-\$ or US-4866770-\$ or US-4792849-\$ or US-4829569-\$ or US-4852154-\$ or US-4849811-\$ or US-4829372-\$ or US-4924492-\$ or US-4920432-\$ or US-4949187-\$ or US-5130792-\$ or US-4300040-\$ or US-4521806-\$).did. or (US-4124773-\$ or US-4538176-\$ or US-5083271-\$ or US-4864301-\$ or US-4905003-\$ or US-4935870-\$ or US-4623920-\$ or US-4450477-\$ or US-5012334-\$ or US-4956768-\$ or US-4839745-\$ or US-4851931-\$ or US-4894789-\$ or US-4499568-\$ or US-4872151-\$ or US-5113518-\$ or US-4422093-\$ or US-4658093-\$ or US-5041921-\$ or US-5065345-\$ or US-5034980-\$ or US-4763207-\$ or US-4527262-\$ or US-5040110-\$ or US-4974178-\$ or US-4873589-\$ or US-4649533-\$).did.	USPAT	OR	ON	2006/08/11 12:35
S17 4	35	S173 and (buy or pay or credit or purchase)	USPAT	OR	ON	2006/08/11 12:36
S17 5	22	S173 and (credit)	USPAT	OR	ON	2006/08/11 16:32
S17 6	1	("4789863").PN.	US-PGPUB; USPAT	OR	OFF	2006/08/11 16:34
S17 7	1	("4870515").PN.	US-PGPUB; USPAT	OR	OFF	2006/08/11 16:55
S17 8	1	("4789863").PN.	US-PGPUB; USPAT	OR	OFF	2006/08/14 11:39
S17 9	1	("4870515").PN.	US-PGPUB; USPAT	OR	OFF	2006/08/14 11:39
S18 0	1	("4870515").PN.	US-PGPUB; USPAT	OR	OFF	2006/08/15 11:37
S18 1	1	burks\$.in. and boska\$.in.	US-PGPUB; USPAT	OR	ON	2006/08/15 12:15
S18 2	1	("5191573").PN.	US-PGPUB; USPAT	OR	OFF	2006/08/15 12:25
S18 3	142	itunes	US-PGPUB; USPAT	OR	ON	2006/08/15 12:25

EAST Search History

Ref #	Hits	Search Query	DBs	Default Operator	Plurals	Time Stamp
S1	5	((("5130792") or ("4949187") or ("4920432") or ("4829372") or ("4789863")).PN.	US-PGPUB; USPAT	OR	OFF	2006/08/01 14:09
S2	200	("5130792").URPN.	USPAT	OR	ON	2006/08/01 15:25
S3	1	("4949187").PN.	US-PGPUB; USPAT	OR	OFF	2006/08/01 15:25
S4	278	("4949187").URPN.	USPAT	OR	ON	2006/08/01 15:27
S6	194	S4 not S2	USPAT	OR	ON	2006/08/01 15:27
S7	8	("4506387" "4709418" "4949187" "5144661" "5172413" "5216515" "5218454" "5229850").PN.	US-PGPUB; USPAT; USOCR	OR	ON	2006/08/01 17:09
S8	200	("5130792").URPN.	USPAT	OR	ON	2006/08/01 17:40
S9	1	("4920432").PN.	US-PGPUB; USPAT	OR	OFF	2006/08/01 17:40
S10	123	("4920432").URPN.	USPAT	OR	ON	2006/08/03 11:58
S11	1	("4829372").PN.	US-PGPUB; USPAT	OR	OFF	2006/08/03 11:59
S12	112	("4829372").URPN.	USPAT	OR	ON	2006/08/03 12:41
S13	1	("4789863").PN.	US-PGPUB; USPAT	OR	OFF	2006/08/03 13:14
S14	45	("4789863").URPN.	USPAT	OR	ON	2006/08/03 12:44
S15	1	("5721827").PN.	US-PGPUB; USPAT	OR	OFF	2006/08/03 12:44
S16	25	("5966440").URPN.	USPAT	OR	ON	2006/08/03 12:58
S17	1	("5133079").PN.	US-PGPUB; USPAT	OR	OFF	2006/08/03 13:14
S18	204	("5133079").URPN.	USPAT	OR	ON	2006/08/03 13:35
S19	1	("5172413").PN.	US-PGPUB; USPAT	OR	OFF	2006/08/03 13:35
S20	190	("5172413").URPN.	USPAT	OR	ON	2006/08/03 13:40
S21	3	((("5191573") or ("5966440") or ("5675734")).PN.	US-PGPUB; USPAT	OR	OFF	2006/08/03 13:41
S22	76	("5191573").URPN.	USPAT	OR	ON	2006/08/03 13:41
S23	74	("5675734").URPN.	USPAT	OR	ON	2006/08/03 13:43

EAST Search History

S24	31	(US-7017178-\$ or US-6463207-\$ or US-5717814-\$ or US-5544228-\$ or US-5528281-\$ or US-5253275-\$ or US-5132992-\$ or US-5133079-\$ or US-5172413-\$ or US-5696869-\$ or US-5550863-\$ or US-5790174-\$ or US-5594490-\$ or US-5247347-\$ or US-5220420-\$ or US-5181107-\$ or US-5119188-\$ or US-5014125-\$ or US-6609105-\$ or US-6496802-\$ or US-6072982-\$ or US-5966440-\$ or US-5745678-\$ or US-5636276-\$ or US-5555441-\$ or US-5390172-\$).did. or (US-5497502-\$ or US-5410343-\$ or US-5394182-\$ or US-5371532-\$ or US-6002720-\$).did.	USPAT	OR	ON	2006/08/03 13:47
S25	93	("20010033659" "3990710" "4054911" "4300040" "4355338" "4449198" "4468751" "4481412" "4506387" "4521806" "4703456" "4725977" "4789863" "4792849" "4811325" "4851931" "4924303" "4937807" "5021893" "5041921" "5051822" "5084768" "5099422" "5168481" "5208665" "5233477" "5237157" "5260778" "5267351" "5319707" "5319774" "5355302" "5365381" "5400401" "5418654" "5440637" "5481296" "5502601" "5532920" "5541638" "5557541" "5563665" "5572442" "5585866" "5592511" "5600573" "5627867" "5629733" "5629867" "5629980" "5633839" "5638443" "5646992" "5661787" "5675734" "5689648" "5703795" "5715403" "5721827" "5726909" "5734961" "5758257" "5794217" "5806068" "5809246" "5815471" "5845262" "5877755" "5894119" "5900830" "5913204" "5915090" "5918213" "5931901" "5949411" "5949476" "5956491" "5959944" "5959945" "5960411" "5963916" "5974004" "5987525" "6005597" "6006251" "6011758" "6014184" "6044403" "6061680" "6088455" "6088710" "6092105" "6092197").PN.	US-PGPUB; USPAT; USOCR	OR	ON	2006/08/03 14:44
S26	45	("4789863").URPN.	USPAT	OR	ON	2006/08/03 14:46
S27	100	("4710921" "4789863" "4790010" "4991207" "5191611" "5208665").PN. OR ("5636276").URPN.	US-PGPUB; USPAT; USOCR	OR	ON	2006/08/03 16:28

EAST Search History

S28	19	("4956768" "5113496" "5191410" "5195092" "5418713" "5423003" "5550577" "5555441" "5560038" "5583763" "5590282" "5619247" "5636276" "5729281" "5756280" "5781889" "5790423" "5867155" "5870553").PN.	US-PGPUB; USPAT; USOCR	OR	ON	2006/08/03 16:44
-----	----	---	------------------------------	----	----	------------------

EAST Search History

S29	264	("20010002852" "20010003846" "20010005906" "20010010045" "20010010095" "20010013037" "20010013120" "20010014882" "20010016836" "20010017920" "20010018742" "20010018858" "20010023416" "20010023417" "20010023428" "20010024425" "20010024566" "20010025259" "20010025269" "20010025316" "20010027561" "20010027563" "20010029491" "20010029538" "20010029583" "20010030660" "20010031066" "20010032131" "20010032132" "20010032133" "20010032187" "20010032312" "20010034635" "20010034714" "20010034883" "20020057799" "20020062261" "20020066025" "20020073038" "3373517" "3376465" "3848193" "3941926" "3983317" "3993955" "4094010" "4155042" "4332022" "4368485" "4476488" "4536791" "4559480" "4575750" "4595950" "4654482" "4716410" "4734779" "4734858" "4761641" "4789863" "4797913" "4809325" "4812843" "4829569" "4847825" "4862268" "4908713" "4949187" "5046090" "5051822" "5073925" "5107107" "5121430" "5123046" "5133079" "5182669" "5191573" "5214793" "5233423" "5235587" "5251193" "5257017" "5260778" "5274762" "5283731" "5297204" "5311423" "5319735" "5355302" "5365282" "5373330" "5414756" "5418713" "5420647" "5420923" "5428606" "5438355" "5465291" "5469020" "5469206" "5473584" "5486819" "5495283" "5497186" "5497479" "5508815" "5512935" "5513260" "5530751" "5532920" "5543856" "5557541"). PN. OR ("5559549" "5565909" "5568272" "5592511" "5592551" "5592626" "5600839" "5610653" "5612741" "5619247" "5621840" "5621863" "5627895" "5628050" "5630067" "5638113" "5640453" "5644859" "5646603" "5646997" "5654747" "5659366" "5659613" "5661516" "5664018" "5675734" "5684918" "5686954" "5689799" "5692214" "5701161" "5701383" "5701397" "5710869" "5717814" "5717832" "5721827" "5721951" "5724062" "5724091" "5724525" "5729714" "5734413" "5740326"	US-PGPUB; USPAT; USOCR	OR	ON	2006/08/04 12:42
8/15/06 1:59:05 PM	C:\Documents and Settings\roster1\MY Documents\EAST\Workspaces\900074022.wsp				Page 4	

EAST Search History

S30	46	(US-7017178-\$ or US-6463207-\$ or US-5717814-\$ or US-5544228-\$ or US-5528281-\$ or US-5253275-\$ or US-5132992-\$ or US-5133079-\$ or US-5172413-\$ or US-5696869-\$ or US-5550863-\$ or US-5790174-\$ or US-5594490-\$ or US-5247347-\$ or US-5220420-\$ or US-5181107-\$ or US-5119188-\$ or US-5014125-\$ or US-6609105-\$ or US-6496802-\$ or US-6072982-\$ or US-5966440-\$ or US-5745678-\$ or US-5636276-\$ or US-5555441-\$ or US-5390172-\$).did. or (US-5497502-\$ or US-5410343-\$ or US-5394182-\$ or US-5371532-\$ or US-6002720-\$ or US-5041921-\$ or US-5267351-\$ or US-5418654-\$ or US-5638443-\$ or US-5734961-\$ or US-4789863-\$ or US-6182128-\$ or US-4956768-\$ or US-5191410-\$ or US-5195092-\$ or US-5418713-\$ or US-5550577-\$ or US-5619247-\$ or US-5781889-\$ or US-5790423-\$).did.	USPAT	OR	ON	2006/08/07 15:23
S31	1	("5191573").PN.	US-PGPUB; USPAT	OR	OFF	2006/08/08 11:53
S32	1	("5436960").PN.	US-PGPUB; USPAT	OR	OFF	2006/08/08 11:53

EAST Search History

Ref #	Hits	Search Query	DBs	Default Operator	Plurals	Time Stamp
S1	5	((("5130792") or ("4949187") or ("4920432") or ("4829372") or ("4789863")).PN.	US-PGPUB; USPAT	OR	OFF	2006/08/01 14:09
S2	200	("5130792").URPN.	USPAT	OR	ON	2006/08/01 15:25
S3	1	("4949187").PN.	US-PGPUB; USPAT	OR	OFF	2006/08/01 15:25
S4	278	("4949187").URPN.	USPAT	OR	ON	2006/08/01 15:27
S6	194	S4 not S2	USPAT	OR	ON	2006/08/01 15:27
S7	8	("4506387" "4709418" "4949187" "5144661" "5172413" "5216515" "5218454" "5229850").PN.	US-PGPUB; USPAT; USOCR	OR	ON	2006/08/01 17:09
S8	200	("5130792").URPN.	USPAT	OR	ON	2006/08/01 17:40
S9	1	("4920432").PN.	US-PGPUB; USPAT	OR	OFF	2006/08/01 17:40
S10	123	("4920432").URPN.	USPAT	OR	ON	2006/08/03 11:58
S11	1	("4829372").PN.	US-PGPUB; USPAT	OR	OFF	2006/08/03 11:59
S12	112	("4829372").URPN.	USPAT	OR	ON	2006/08/03 12:41
S13	1	("4789863").PN.	US-PGPUB; USPAT	OR	OFF	2006/08/03 13:14
S14	45	("4789863").URPN.	USPAT	OR	ON	2006/08/03 12:44
S15	1	("5721827").PN.	US-PGPUB; USPAT	OR	OFF	2006/08/03 12:44
S16	25	("5966440").URPN.	USPAT	OR	ON	2006/08/03 12:58
S17	1	("5133079").PN.	US-PGPUB; USPAT	OR	OFF	2006/08/03 13:14
S18	204	("5133079").URPN.	USPAT	OR	ON	2006/08/03 13:35
S19	1	("5172413").PN.	US-PGPUB; USPAT	OR	OFF	2006/08/03 13:35
S20	190	("5172413").URPN.	USPAT	OR	ON	2006/08/03 13:40
S21	3	((("5191573") or ("5966440") or ("5675734")).PN.	US-PGPUB; USPAT	OR	OFF	2006/08/03 13:41
S22	76	("5191573").URPN.	USPAT	OR	ON	2006/08/03 13:41
S23	74	("5675734").URPN.	USPAT	OR	ON	2006/08/03 13:43

EAST Search History

S24	31	(US-7017178-\$ or US-6463207-\$ or US-5717814-\$ or US-5544228-\$ or US-5528281-\$ or US-5253275-\$ or US-5132992-\$ or US-5133079-\$ or US-5172413-\$ or US-5696869-\$ or US-5550863-\$ or US-5790174-\$ or US-5594490-\$ or US-5247347-\$ or US-5220420-\$ or US-5181107-\$ or US-5119188-\$ or US-5014125-\$ or US-6609105-\$ or US-6496802-\$ or US-6072982-\$ or US-5966440-\$ or US-5745678-\$ or US-5636276-\$ or US-5555441-\$ or US-5390172-\$). did. or (US-5497502-\$ or US-5410343-\$ or US-5394182-\$ or US-5371532-\$ or US-6002720-\$). did.	USPAT	OR	ON	2006/08/03 13:47
-----	----	---	-------	----	----	------------------

EAST Search History

S25	93	("20010033659" "3990710" "4054911" "4300040" "4355338" "4449198" "4468751" "4481412" "4506387" "4521806" "4703456" "4725977" "4789863" "4792849" "4811325" "4851931" "4924303" "4937807" "5021893" "5041921" "5051822" "5084768" "5099422" "5168481" "5208665" "5233477" "5237157" "5260778" "5267351" "5319707" "5319774" "5355302" "5365381" "5400401" "5418654" "5440637" "5481296" "5502601" "5532920" "5541638" "5557541" "5563665" "5572442" "5585866" "5592511" "5600573" "5627867" "5629733" "5629867" "5629980" "5633839" "5638443" "5646992" "5661787" "5675734" "5689648" "5703795" "5715403" "5721827" "5726909" "5734961" "5758257" "5794217" "5806068" "5809246" "5815471" "5845262" "5877755" "5894119" "5900830" "5913204" "5915090" "5918213" "5931901" "5949411" "5949476" "5956491" "5959944" "5959945" "5960411" "5963916" "5974004" "5987525" "6005597" "6006251" "6011758" "6014184" "6044403" "6061680" "6088455" "6088710" "6092105" "6092197").PN.	US-PGPUB; USPAT; USOCR	OR	ON	2006/08/03 14:44
S26	45	("4789863").URPN.	USPAT	OR	ON	2006/08/03 14:46
S27	100	("4710921" "4789863" "4790010" "4991207" "5191611" "5208665").PN. OR ("5636276").URPN.	US-PGPUB; USPAT; USOCR	OR	ON	2006/08/03 16:28
S28	19	("4956768" "5113496" "5191410" "5195092" "5418713" "5423003" "5550577" "5555441" "5560038" "5583763" "5590282" "5619247" "5636276" "5729281" "5756280" "5781889" "5790423" "5867155" "5870553").PN.	US-PGPUB; USPAT; USOCR	OR	ON	2006/08/03 16:44

EAST Search History

S29	264	("20010002852" "20010003846" "20010005906" "20010010045" "20010010095" "20010013037" "20010013120" "20010014882" "20010016836" "20010017920" "20010018742" "20010018858" "20010023416" "20010023417" "20010023428" "20010024425" "20010024566" "20010025259" "20010025269" "20010025316" "20010027561" "20010027563" "20010029491" "20010029538" "20010029583" "20010030660" "20010031066" "20010032131" "20010032132" "20010032133" "20010032187" "20010032312" "20010034635" "20010034714" "20010034883" "20020057799" "20020062261" "20020066025" "20020073038" "3373517" "3376465" "3848193" "3941926" "3983317" "3993955" "4094010" "4155042" "4332022" "4368485" "4476488" "4536791" "4559480" "4575750" "4595950" "4654482" "4716410" "4734779" "4734858" "4761641" "4789863" "4797913" "4809325" "4812843" "4829569" "4847825" "4862268" "4908713" "4949187" "5046090" "5051822" "5073925" "5107107" "5121430" "5123046" "5133079" "5182669" "5191573" "5214793" "5233423" "5235587" "5251193" "5257017" "5260778" "5274762" "5283731" "5297204" "5311423" "5319735" "5355302" "5365282" "5373330" "5414756" "5418713" "5420647" "5420923" "5428606" "5438355" "5465291" "5469020" "5469206" "5473584" "5486819" "5495283" "5497186" "5497479" "5508815" "5512935" "5513260" "5530751" "5532920" "5543856" "5557541").PN. OR ("5559549" "5565909" "5568272" "5592511" "5592551" "5592626" "5600839" "5610653" "5612741" "5619247" "5621840" "5621863" "5627895" "5628050" "5630067" "5638113" "5640453" "5644859" "5646603" "5646997" "5654747" "5659366" "5659613" "5661516" "5664018"	US-PGPUB; USPAT; USOCR	OR	ON	2006/08/04 12:42
8/15/06 1:59:30 PM		("5644859" "5646603" "5646997" "5654747" "5659366" "5659613" "5661516" "5664018"	C:\Documents and Settings\Hoster1\My Documents\EAST\Workspaces\900074021.wsp			Page 4

EAST Search History

Ref #	Hits	Search Query	DBs	Default Operator	Plurals	Time Stamp
S1	1	("5191573").PN.	US-PGPUB; USPAT	OR	OFF	2006/04/24 08:02
S2	1	("4528643").PN.	US-PGPUB; USPAT	OR	OFF	2006/04/20 11:59
S3	2	((("5675734") or ("5996440")).PN.	US-PGPUB; USPAT	OR	OFF	2006/04/20 12:00
S4	2	((("5675734") or ("5966440")).PN.	US-PGPUB; USPAT	OR	OFF	2006/04/20 12:00
S5	1	("4499568").PN.	US-PGPUB; USPAT	OR	OFF	2006/04/20 14:50
S19	54273	"379"/\$.ccls.	US-PGPUB; USPAT	OR	ON	2006/04/24 08:17
S20	12829	S19 and (audio or (voice adj message))	US-PGPUB; USPAT	OR	ON	2006/04/24 08:17
S21	2884	S20 and (subscribe or subscription or buy or (credit adj card))	US-PGPUB; USPAT	OR	ON	2006/04/24 09:30
S22	267	S21 and @pn < "5300000"	US-PGPUB; USPAT	OR	ON	2006/04/24 08:44
S23	3895	"pay-per-view" or (pay adj3 view) and "379"/\$.ccls.	US-PGPUB; USPAT	OR	ON	2006/04/24 09:08
S24	164	S23 and @pn < "5300000"	US-PGPUB; USPAT	OR	ON	2006/04/24 09:08
S25	4008	"pay-per-view" or (pay adj3 view) and isdn	US-PGPUB; USPAT	OR	ON	2006/04/24 09:08
S26	705	("pay-per-view" or (pay adj3 view)) and isdn	US-PGPUB; USPAT	OR	ON	2006/04/24 09:09
S27	707	("pay-per-view" or (pay adj3 view)) and (isdn or idsn)	US-PGPUB; USPAT	OR	ON	2006/04/24 09:11
S28	6	S27 and @pn < "5300000"	US-PGPUB; USPAT	OR	ON	2006/04/24 09:09
S29	2964	music and (isdn or idsn)	US-PGPUB; USPAT	OR	ON	2006/04/24 09:11
S30	34	S29 and @pn < "5300000"	US-PGPUB; USPAT	OR	ON	2006/04/24 09:11
S31	23	("3766324" "4332980" "4381522" "4506387" "4654866" "4755872" "4761684" "4763191" "4792849" "4797913" "4807023" "4829372" "4849811" "4852154" "4890320" "4897867" "4949187" "4995078" "5010399" "5014125" "5130792" "5132992" "5133079").PN.	US-PGPUB; USPAT; USOCR	OR	ON	2006/04/24 09:21

EAST Search History

S32	572	(videotex or videotext or (video adj tex) or (video adj text)) and isdn	US-PGPUB; USPAT; USOCR	OR	ON	2006/04/24 09:22
S33	23	S32 and @pn < "5300000"	US-PGPUB; USPAT; USOCR	OR	ON	2006/04/24 09:24
S34	652	((bulletin or Bulletin) adj board) and modem and music and (buy or order or credit)	US-PGPUB; USPAT; USOCR	OR	ON	2006/04/24 09:26
S35	1	S34 and @pn < "5300000"	US-PGPUB; USPAT; USOCR	OR	ON	2006/04/24 09:25
S36	1973	((bulletin or Bulletin) adj board) and modem and video and (buy or order or credit)	US-PGPUB; USPAT; USOCR	OR	ON	2006/04/24 09:27
S39	12	S36 and @pn < "5300000"	US-PGPUB; USPAT; USOCR	OR	ON	2006/04/24 09:28
S40	2126	((bulletin or Bulletin) adj board) and modem and video	US-PGPUB; USPAT; USOCR	OR	ON	2006/04/24 09:27
S41	14	S40 and @pn < "5300000"	US-PGPUB; USPAT; USOCR	OR	ON	2006/04/24 09:29
S42	16087	isdn and video	US-PGPUB; USPAT; USOCR	OR	ON	2006/04/24 09:30
S43	329	S42 and @pn < "5300000"	US-PGPUB; USPAT; USOCR	OR	ON	2006/04/24 09:30
S44	42	S43 and (subscribe or subscription or buy or (credit adj card))	US-PGPUB; USPAT	OR	ON	2006/04/24 09:30
S45	18	(US-3718906-\$ or US-4071697-\$ or US-4500751-\$ or US-4567359-\$ or US-4649533-\$ or US-4694490-\$ or US-4789863-\$ or US-4792849-\$ or US-4837797-\$ or US-4852154-\$ or US-4665516-\$ or US-4710955-\$ or US-4829569-\$ or US-4890319-\$ or US-4893248-\$ or US-5130792-\$ or US-4849811-\$ or US-4924492-\$).did.	USPAT	OR	ON	2006/04/24 10:59
S46	1	("4789868").PN.	US-PGPUB; USPAT	OR	OFF	2006/04/24 11:00

EAST Search History

S47	18	(US-4694490-\$ or US-4649533-\$ or US-4567359-\$ or US-4500751-\$ or US-4893248-\$ or US-4890319-\$ or US-4789863-\$ or US-4852154-\$ or US-4837797-\$ or US-4792849-\$ or US-4071697-\$ or US-3718906-\$ or US-4710955-\$ or US-4665516-\$ or US-4829569-\$ or US-4849811-\$ or US-4924492-\$ or US-5130792-\$).did.	USPAT	OR	ON	2006/04/24 12:39
S48	15	("3718906" "4163254" "4272791" "4300040" "4359631" "4433207" "4471379" "4506387" "4513315" "4538176" "4567512" "4590516" "4685131" "4700386" "Re31639").PN.	US-PGPUB; USPAT; USOCR	OR	ON	2006/04/24 12:50
S49	45	("4789863").URPN.	USPAT	OR	ON	2006/04/24 13:43
S50	3	((("5191573") or ("5966440") or ("5675734")).PN.	US-PGPUB; USPAT	OR	OFF	2006/04/24 13:44
S51	14	("3718906" "3990710" "4124773" "4506387" "4521806" "4528643" "4538176" "4567359" "4647989" "4654799" "4789863" "4789868" "5191193" "5191573").PN.	US-PGPUB; USPAT; USOCR	OR	ON	2006/04/24 13:44
S52	44	("4124773").URPN.	USPAT	OR	ON	2006/04/24 13:50
S53	1070	(455/412.1).CCLS.	US-PGPUB; USPAT	OR	OFF	2006/04/24 13:50
S54	0	("7and@pn<5200000").PN.	US-PGPUB; USPAT	OR	OFF	2006/04/24 13:51
S55	11	S53 and (@pn < "5200000")	US-PGPUB; USPAT	OR	ON	2006/04/24 13:53
S56	593	(379/88.13).CCLS.	US-PGPUB; USPAT	OR	OFF	2006/04/24 14:03
S57	27	S56 and (@pn < "5200000")	US-PGPUB; USPAT	OR	ON	2006/04/24 14:04
S58	740	(379/88.17).CCLS.	US-PGPUB; USPAT	OR	OFF	2006/04/24 14:03
S59	6	S58 and (@pn < "5200000")	US-PGPUB; USPAT	OR	ON	2006/04/24 14:04
S60	10567	(video and (charge or buy or credit)) and (@pn < "5200000")	US-PGPUB; USPAT	OR	ON	2006/04/24 14:05
S61	430	(video and (credit adj card)) and (@pn < "5200000")	US-PGPUB; USPAT	OR	ON	2006/04/24 15:36
S62	181	S61 and network	US-PGPUB; USPAT	OR	ON	2006/04/24 14:06
S63	243	(video and audio and (download\$ or (down adj load\$))) and (@pn < "5200000")	US-PGPUB; USPAT	OR	ON	2006/04/24 14:13

EAST Search History

S64	157	S63 and network	US-PGPUB; USPAT	OR	ON	2006/04/24 14:13
S65	209	S63 and (network or communication)	US-PGPUB; USPAT	OR	ON	2006/04/24 14:14
S66	38	("3599178" "3746780" "4009344" "4009346" "4028733" "4062043" "4071697" "4122299" "4381522" "4400717" "4450477" "4506387" "4518989" "4521806" "4533936" "4538176" "4567512" "4590516" "4679079" "4688246" "4734765" "4755872" "4763191" "4785349" "4807023" "4833710" "4847677" "4868653" "4890320" "4907081" "4914508" "4920432" "4937821" "4947244" "4949169" "4949187" "4963995" "5032927").PN.	US-PGPUB; USPAT; USOCR	OR	ON	2006/04/24 15:30
S67	4	((("4963995" or ("5995705") or ("5057932") or ("5164839"))).PN.	US-PGPUB; USPAT	OR	OFF	2006/04/24 15:32
S68	9	("4179709" "4400717" "4516156" "4698664" "4709418" "4724491" "4768110" "4774574" "4851931"). PN.	US-PGPUB; USPAT; USOCR	OR	ON	2006/04/24 15:35
S69	29448	audio and video and (hard adj (drive or disk)) and network	US-PGPUB; USPAT; USOCR	OR	ON	2006/04/24 15:36
S70	104	S69 and (@pn < "5200000")	US-PGPUB; USPAT	OR	ON	2006/04/24 16:28
S71	4959	music same download\$	US-PGPUB; USPAT	OR	ON	2006/04/24 16:28
S72	7	S71 and (@pn < "5200000")	US-PGPUB; USPAT	OR	ON	2006/04/24 16:32
S73	1	("4949187").PN.	US-PGPUB; USPAT	OR	OFF	2006/04/24 16:30
S74	7	("3718906" "3990710" "4232295" "4597058" "4597098" "4769833" "4789961").PN.	US-PGPUB; USPAT; USOCR	OR	ON	2006/04/24 16:30
S75	261	("4949187").URPN.	USPAT	OR	ON	2006/04/24 16:32
S76	1372	music and isdn	USPAT	OR	ON	2006/04/24 16:32
S77	27	S76 and (@pn < "5200000")	US-PGPUB; USPAT	OR	ON	2006/04/24 16:45
S78	394	audio and music and (download\$ or (down adj load\$))	EPO; JPO; DERWENT; IBM_TDB	OR	ON	2006/04/24 16:40
S79	24	audio and music and isdn	EPO; JPO; DERWENT; IBM_TDB	OR	ON	2006/04/24 16:41

EAST Search History

S80	341	audio and video and isdn	EPO; JPO; DERWENT; IBM_TDB	OR	ON	2006/04/24 16:42
S81	690	audio and video and (charge or buy or (credit adj card))	EPO; JPO; DERWENT; IBM_TDB	OR	ON	2006/04/24 16:43
S82	192	audio and video and (charge or buy or (credit adj card)) and (communications or network)	EPO; JPO; DERWENT; IBM_TDB	OR	ON	2006/04/24 16:44
S83	56788	(digital adj3 (audio or video)) and (network or communication)	US-PGPUB; USPAT	OR	ON	2006/04/24 16:45
S84	2209	S83 and (@pn < "5200000")	US-PGPUB; USPAT	OR	ON	2006/04/24 16:45
S85	12261	(digital adj3 (audio or video)) and (network or communication) and (buy or charge or (credit adj card))	US-PGPUB; USPAT	OR	ON	2006/04/24 17:06
S86	448	S85 and (@pn < "5200000")	US-PGPUB; USPAT	OR	ON	2006/04/24 17:06
S87	5130	(digital adj3 (audio or video)) and (network or communication) and (buy or (credit adj card))	US-PGPUB; USPAT	OR	ON	2006/04/24 17:06
S88	9207	(digital adj3 (audio or video)) and (network or communication) and (buy or purchase or (credit adj card))	US-PGPUB; USPAT	OR	ON	2006/04/24 17:06
S89	105	S88 and (@pn < "5200000")	US-PGPUB; USPAT	OR	ON	2006/04/24 17:40
S90	41	(real adj audio) and (bulletin adj board)	US-PGPUB; USPAT	OR	ON	2006/04/24 17:40
S91	41	(real adj audio) and (bullet\$1n adj board)	US-PGPUB; USPAT	OR	ON	2006/04/24 17:40
S92	41	(real adj audio) and (bull\$1tin adj board)	US-PGPUB; USPAT	OR	ON	2006/04/24 17:41
S94	104	(bull\$1tin adj board) and (download\$ near3 audio)	US-PGPUB; USPAT	OR	ON	2006/04/24 17:42
S95	13	(bull\$1tin adj board) and kermit	US-PGPUB; USPAT	OR	ON	2006/04/24 17:44
S96	3548	(bull\$1tin adj board) and (audio or video)	US-PGPUB; USPAT	OR	ON	2006/04/24 17:43
S97	204	(computer adj bull\$1tin adj board)	US-PGPUB; USPAT	OR	ON	2006/04/24 17:44
S98	116	(computer adj bull\$1tin adj board) and (audio and video)	US-PGPUB; USPAT	OR	ON	2006/04/25 13:12
S99	101	zmodem	US-PGPUB; USPAT	OR	ON	2006/04/25 13:12

EAST Search History

S10 0	33	zmodem and audio	US-PGPUB; USPAT	OR	ON	2006/04/25 13:13
S10 1	41	zmodem and video	US-PGPUB; USPAT	OR	ON	2006/04/25 13:14
S10 2	46	ymodem	US-PGPUB; USPAT	OR	ON	2006/04/25 13:14
S10 3	33	S102 and (audio or video)	US-PGPUB; USPAT	OR	ON	2006/04/25 13:15
S10 4	159	xmodem	US-PGPUB; USPAT	OR	ON	2006/04/25 13:15
S10 5	82	S104 and (audio or video)	US-PGPUB; USPAT	OR	ON	2006/04/25 13:17
S10 6	4094	download\$ adj5 (audio or video)	US-PGPUB; USPAT	OR	ON	2006/04/25 13:17
S10 7	39	S106 and @pn < "5300000"	US-PGPUB; USPAT	OR	ON	2006/04/25 13:17
S10 8	32	("3263158" "4529870" "4658093" "4924378" "4932054" "4937863" "4953209" "4961142" "4977594" "5010571" "5014234" "5023907" "5047928" "5050213" "5058164" "5103476" "5113519" "5146499" "5159182" "5191193" "5204897" "5235642" "5247575" "5260999" "5263157" "5291596" "5339091" "5432849" "5438508" "5504814" "5530235").PN.	US-PGPUB; USPAT; USOCR	OR	ON	2006/04/25 14:11
S10 9	1	("4636876").PN.	US-PGPUB; USPAT	OR	OFF	2006/04/25 14:44
S11 0	5	((("5428606") or ("5132992") or ("5130792") or ("4999806") or ("re35184"))).PN.	US-PGPUB; USPAT	OR	OFF	2006/04/25 14:49
S11 1	7	((("3244809") or ("3696297") or ("3718906") or ("3824597") or ("3947882") or ("3990710") or ("4028733"))).PN.	US-PGPUB; USPAT	OR	OFF	2006/04/25 14:51
S11 2	11	((("4124773") or ("4300040") or ("4335809") or ("4370649") or ("4422093") or ("4499568") or ("4506387") or ("4520404") or ("4521806") or ("4521857") or ("4586430"))).PN.	US-PGPUB; USPAT	OR	OFF	2006/04/25 15:04
S11 3	12	((("4533948") or ("4536856") or ("4538176") or ("4567359") or ("4567512") or ("4605973") or ("4647989") or ("4648037") or ("4658093") or ("4667802") or ("4672613") or ("4674055"))).PN.	US-PGPUB; USPAT	OR	OFF	2006/04/25 15:05

EAST Search History

S11 4	12	((("4688105") or ("4703465") or ("4725977") or ("4739510") or ("4754483") or ("4755872") or ("4759060") or ("4761684") or ("4763317") or ("4766581") or ("4787050") or ("4789863")).PN.	US-PGPUB; USPAT	OR	OFF	2006/04/25 15:27
S11 5	12	((("4792849") or ("4797918") or ("4829372") or ("4894789") or ("4918588") or ("4949187") or ("5003384") or ("5019900") or ("5041921") or ("5089885") or ("5099422") or ("5191410")).PN.	US-PGPUB; USPAT	OR	OFF	2006/04/25 16:20
S11 6	7	compusonic	US-PGPUB; USPAT	OR	ON	2006/04/25 16:22
S11 7	5322	bbs and (audio or video)	US-PGPUB; USPAT	OR	ON	2006/04/25 16:33
S11 8	739	S117 and @pn < "5300000"	US-PGPUB; USPAT	OR	ON	2006/04/25 16:33
S11 9	1661	bbs and (audio and video)	US-PGPUB; USPAT	OR	ON	2006/04/25 16:33
S12 0	95	S119 and @pn < "5300000"	US-PGPUB; USPAT	OR	ON	2006/04/25 17:05
S12 1	2	((("4870515") or ("4528643")).PN.	US-PGPUB; USPAT	OR	OFF	2006/04/25 17:05
S12 2	40	(US-4694490-\$ or US-4649533-\$ or US-4567359-\$ or US-4500751-\$ or US-4893248-\$ or US-4890319-\$ or US-4789863-\$ or US-4852154-\$ or US-4837797-\$ or US-4792849-\$ or US-4071697-\$ or US-3718906-\$ or US-4710955-\$ or US-4665516-\$ or US-4829569-\$ or US-4849811-\$ or US-4924492-\$ or US-5130792-\$ or US-4538176-\$ or US-4300040-\$ or US-4521806-\$ or US-4124773-\$ or US-4829372-\$ or US-4916737-\$ or US-4623920-\$ or US-4866770-\$).did. or (US-4956768-\$ or US-4949187-\$ or US-4920432-\$ or US-4894789-\$ or US-4839745-\$ or US-5113518-\$ or US-4872151-\$ or US-4724521-\$ or US-5083271-\$ or US-4658093-\$ or US-4499568-\$ or US-4422093-\$ or US-5003384-\$ or US-4935870-\$).did.	USPAT	OR	ON	2006/04/26 08:38
S12 3	56	("3347988" "3444324" "3444550" "3448216" "3471648" "3590381" "3969680").PN. OR ("4124773").URPN.	US-PGPUB; USPAT; USOCR	OR	ON	2006/04/26 09:02
S12 4	14870	music and (hard adj (drive or disk))	US-PGPUB; USPAT; USOCR	OR	ON	2006/04/26 09:28

EAST Search History

S12 5	165	S124 and @pn < "5300000"	US-PGPUB; USPAT; USOCR	OR	ON	2006/04/26 09:29
S12 6	36749	audio and video and (hard adj (drive or disk))	US-PGPUB; USPAT; USOCR	OR	ON	2006/04/26 10:09
S12 7	373	S126 and @pn < "5300000"	US-PGPUB; USPAT; USOCR	OR	ON	2006/04/26 09:29
S12 8	7619	audio same video same (hard adj (drive or disk))	US-PGPUB; USPAT; USOCR	OR	ON	2006/04/26 09:54
S12 9	82	S128 and @pn < "5300000"	US-PGPUB; USPAT; USOCR	OR	ON	2006/04/26 09:55
S13 0	1863	((audio or video) near5 (stored or store or storing)) near5 (hard adj (drive or disk))	US-PGPUB; USPAT; USOCR	OR	ON	2006/04/26 10:09
S13 1	11	S130 and @pn < "5300000"	US-PGPUB; USPAT; USOCR	OR	ON	2006/04/26 10:10
S13 2	34	(disk adj streamer)	US-PGPUB; USPAT; USOCR	OR	ON	2006/04/26 09:58
S13 3	109	(audio and video and (hard adj (drive or disk))).ab.	US-PGPUB; USPAT; USOCR	OR	ON	2006/04/26 10:10
S13 4	440	((hard adj (drive or disk)) and (audio or video)).ab.	US-PGPUB; USPAT; USOCR	OR	ON	2006/04/26 10:11
S13 5	8	S134 and @pn < "5300000"	US-PGPUB; USPAT; USOCR	OR	ON	2006/04/26 10:21
S13 6	6078	((hard adj (drive or disk)) and (audio or video)).ab.	EPO; JPO; DERWENT	OR	ON	2006/04/26 10:12
S13 7	1784	((hard adj (drive or disk)) and (audio and video)).ab.	EPO; JPO; DERWENT	OR	ON	2006/04/26 10:20
S13 8	327	((hard adj (drive or disk)) near5 (audio and video)).ab.	EPO; JPO; DERWENT	OR	ON	2006/04/26 10:12
S13 9	2956	media near5 (hard adj (drive or disk))	EPO; JPO; DERWENT	OR	ON	2006/04/26 10:21
S14 0	2442	media near5 (hard adj (drive or disk)).ab.	EPO; JPO; DERWENT	OR	ON	2006/04/26 10:21
S14 1	19496	media near5 (hard adj (drive or disk))	USPAT	OR	ON	2006/04/26 10:21

EAST Search History

S14 2	434	S141 and @pn < "5300000"	US-PGPUB; USPAT; USOCR	OR	ON	2006/04/26 10:53
S14 3	163	S142 and (video or audio)	US-PGPUB; USPAT; USOCR	OR	ON	2006/04/26 10:50
S14 4	70	adlib	US-PGPUB; USPAT; USOCR	OR	ON	2006/04/26 10:51
S14 5	90	jukebox and (sound adj card)	US-PGPUB; USPAT; USOCR	OR	ON	2006/04/26 10:53
S14 6	1431	library and (sound adj card)	US-PGPUB; USPAT; USOCR	OR	ON	2006/04/26 10:53
S14 7	0	S146 and @pn < "5300000"	US-PGPUB; USPAT; USOCR	OR	ON	2006/04/26 10:53
S14 8	0	".wav" and (sound adj card)	US-PGPUB; USPAT; USOCR	OR	ON	2006/04/26 10:53
S14 9	534	"wav" and (sound adj card)	US-PGPUB; USPAT; USOCR	OR	ON	2006/04/26 10:53
S15 0	0	S149 and @pn < "5300000"	US-PGPUB; USPAT; USOCR	OR	ON	2006/04/26 10:57
S15 1	1269	(digital adj audio) same (hard adj (drive or disk))	US-PGPUB; USPAT; USOCR	OR	ON	2006/04/26 10:56
S15 2	27	S151 and @pn < "5300000"	US-PGPUB; USPAT; USOCR	OR	ON	2006/04/26 11:16
S15 3	934	(compact adj disc adj player) and (hard adj (drive or disk))	US-PGPUB; USPAT; USOCR	OR	ON	2006/04/26 11:18
S15 4	41	S153 and @pn < "5300000"	US-PGPUB; USPAT; USOCR	OR	ON	2006/04/26 11:21
S15 5	517	(compact adj disc adj player) and menu	US-PGPUB; USPAT; USOCR	OR	ON	2006/04/26 11:21
S15 6	30	S155 and @pn < "5300000"	US-PGPUB; USPAT; USOCR	OR	ON	2006/04/26 14:10

EAST Search History

S15 7	2921	(compact adj disc) and (artist or composer)	US-PGPUB; USPAT; USOCR	OR	ON	2006/04/26 11:21
S15 8	192	(compact adj disc) and (search near5 (artist or composer))	US-PGPUB; USPAT; USOCR	OR	ON	2006/04/26 11:21
S15 9	1	S158 and @pn < "5300000"	US-PGPUB; USPAT; USOCR	OR	ON	2006/04/26 11:39
S16 0	8	("3999050" "4279022" "4628193" "4634845" "4912640" "4961158" "5047614" "Re32655").PN.	US-PGPUB; USPAT; USOCR	OR	ON	2006/04/26 11:39
S16 1	12167	mpeg and (hard adj (disk or drive))	US-PGPUB; USPAT; USOCR	OR	ON	2006/04/26 11:39
S16 2	1	S159 and @pn < "5300000"	US-PGPUB; USPAT; USOCR	OR	ON	2006/04/26 12:25
S16 3	22	"4870515"	US-PGPUB; USPAT; USOCR	OR	ON	2006/04/26 12:25
S16 4	52	(US-4694490-\$ or US-4649533-\$ or US-4567359-\$ or US-4500751-\$ or US-4893248-\$ or US-4890319-\$ or US-4789863-\$ or US-4852154-\$ or US-4837797-\$ or US-4792849-\$ or US-4071697-\$ or US-3718906-\$ or US-4710955-\$ or US-4665516-\$ or US-4829569-\$ or US-4849811-\$ or US-4924492-\$ or US-5130792-\$ or US-4538176-\$ or US-4300040-\$ or US-4521806-\$ or US-4124773-\$ or US-4829372-\$ or US-4916737-\$ or US-4623920-\$ or US-4866770-\$).did. or (US-4956768-\$ or US-4949187-\$ or US-4920432-\$ or US-4894789-\$ or US-4839745-\$ or US-5113518-\$ or US-4872151-\$ or US-4724521-\$ or US-5083271-\$ or US-4658093-\$ or US-4499568-\$ or US-4422093-\$ or US-5003384-\$ or US-4935870-\$ or US-4864301-\$ or US-4905003-\$ or US-5065345-\$ or US-5041921-\$ or US-5040110-\$ or US-5034980-\$ or US-5012334-\$ or US-4974178-\$ or US-4851931-\$ or US-4763207-\$ or US-4527262-\$ or US-4873589-\$).did.	USPAT	OR	ON	2006/04/26 14:09
S16 6	8	S164 and record.ab.	USPAT	OR	ON	2006/04/26 12:48

EAST Search History

S16 7	2799	video adj clips	USPAT	OR	ON	2006/04/26 14:09
S16 8	19	S167 and @pn < "5300000"	US-PGPUB; USPAT; USOCR	OR	ON	2006/04/26 14:14
S16 9	7	((download or downloading) adj3 video) and @pn < "5300000"	US-PGPUB; USPAT; USOCR	OR	ON	2006/04/26 14:13
S17 0	343	videotext	US-PGPUB; USPAT; USOCR	OR	ON	2006/04/26 14:13
S17 1	118	S170 and @pn < "5300000"	US-PGPUB; USPAT; USOCR	OR	ON	2006/04/26 14:14

Reexamination 	Application/Control No. 90/007,402	Applicant(s)/Patent Under Reexamination 5191573
	Certificate Date	Certificate Number

Requester Correspondence Address: <input type="checkbox"/> Patent Owner <input checked="" type="checkbox"/> Third Party
Albert S. Penilla MARTINE PENILLA & GENCARELLA, LLP 710 Lakeway Drive, Suite 200 Sunnyvale, CA 94085

LITIGATION REVIEW <input checked="" type="checkbox"/>	r.g.f. <small>(examiner initials)</small>	9/5/06 <small>(date)</small>
Case Name		Director Initials
See the litigation searches conducted on 4/15/06 and 3/8/05.		<i>MPe</i> <i>for Lissi Mojica Margu's</i>

COPENDING OFFICE PROCEEDINGS	
TYPE OF PROCEEDING	NUMBER
1.	
2.	
3.	
4.	

Notice of References Cited	Application/Control No. 90/007,402	Applicant(s)/Patent Under Reexamination 5191573	
	Examiner Roland G. Foster	Art Unit 3992	Page 1 of 1

U.S. PATENT DOCUMENTS

*	Document Number Country Code-Number-Kind Code	Date MM-YYYY	Name	Classification
*	A US-4,787,073	11-1988	Masaki, Naoki	369/178.01
*	B US-5,535,137	07-1996	Rossmere et al.	358/537
*	C US-5,241,428	08-1993	Goldwasser et al.	386/109
	D US-			
	E US-			
	F US-			
	G US-			
	H US-			
	I US-			
	J US-			
	K US-			
	L US-			
	M US-			

FOREIGN PATENT DOCUMENTS

*	Document Number Country Code-Number-Kind Code	Date MM-YYYY	Country	Name	Classification
	N				
	O				
	P				
	Q				
	R				
	S				
	T				

NON-PATENT DOCUMENTS

*	Include as applicable: Author, Title Date, Publisher, Edition or Volume, Pertinent Pages)			
U	"The History of Recordings", Recording Industry of Association, retrieved from http://www.riaa.com/issues/audio/hisotry.asp on September 19, 2006.			
V	"History of CD Technology", citing as a source "The compact Disc Handbook, 2nd Edition," by Ken C. Pohlmann, retrieved from http://www.oneoffcd.com/info/hisotrycd.cfm on September 19, 2006.			
W	"History of MPEG", University of California, Berkeley, School of Information Management and Systems, retrieved from http://www2.sims.berkeley.edu/courses/is224/s99/GroupG/report1.html on September 19, 2006.			
X	"IBM HDD Evolution" chart, by Ed Grochowski at Almaden, retrieved from http://www.soragereview.com/guidelimages/z_ibm_sorageevolution.gif on September 19, 2006.			

*A copy of this reference is not being furnished with this Office action. (See MPEP § 707.05(a).)
Dates in MM-YYYY format are publication dates. Classifications may be US or foreign.



DRINKER BIDDLE & REATH LLP

One Logan Square
18th and Cherry Streets
Philadelphia, PA 19103
215-988-2700

FACSIMILE INFORMATION SHEET

FROM: Matthew P. McWilliams (215) 988-3381

TO: Examiner Roland Foster

FAX NO: (571) 273-9900

DATE: November 15, 2006

DOCUMENT NAME: Request for
Interview

NUMBER OF PAGES (INCLUDING COVER): 3

OUR FILE: 219099

IF YOU DO NOT RECEIVE THIS FAX DOCUMENT IN ITS
ENTIRETY, PLEASE CALL THE OPERATOR AT (215-988-2987)
DB&R FACSIMILE MACHINE
215-988-2757 or 2762

MESSAGE:

Dear Examiner Foster

Please find attached a formal Request for Interview for November 16, 2006. If you have any questions whatsoever, please feel free to contact Bob Koons, (215) 988-3392 or myself (215) 988-3381.

Regards, Matthew McWilliams

ORIGINAL WILL: FOLLOW NOT FOLLOW

The pages that follow are confidential and/or privileged. They are intended solely for the person to whom this cover sheet is addressed. Any review, reproduction or retransmission of such material by any person other than such addressee is unauthorized. If this cover sheet and the pages which follow have been received at your location in error, please notify the operator by telephone (collect) at the number set forth above and return the material by U.S. First Class Mail without inspection. We will reimburse your postage. Thank you for your cooperation.

PHIP2955244

PTOL-413A (09-04)
 Approved for use through 07/31/2006. OMB 0851-0031
 U.S. Patent and Trademark Office: U.S. DEPARTMENT OF COMMERCE

Applicant Initiated Interview Request Form

~~90/007,402~~; 90/007,403
 Application No. 90/007,407 First Named Applicant: Arthur Hair
 Examiner: Roland Foster Art Unit: _____ Status of Application: Reexamination

Tentative Participants:
 (1) Robert A. Koons (2) Michael R. Casey
 (3) _____ (4) _____

Proposed Date of Interview: 11/16/06 Proposed Time: 1:00 (AM/PM)

Type of Interview Requested:
 (1) Telephonic (2) Personal (3) Video Conference

Exhibit To Be Shown or Demonstrated: YES NO
 If yes, provide brief description: See attached

Issues To Be Discussed

Issues (Rej., Obj., etc)	Claims/ Fig. #s	Prior Art	Discussed	Agreed	Not Agreed
(1) <u>Rej.</u>	<u>All</u>	<u>All</u>	<input type="checkbox"/>	<input type="checkbox"/>	<input type="checkbox"/>
(2) _____	_____	_____	<input type="checkbox"/>	<input type="checkbox"/>	<input type="checkbox"/>
(3) _____	_____	_____	<input type="checkbox"/>	<input type="checkbox"/>	<input type="checkbox"/>
(4) _____	_____	_____	<input type="checkbox"/>	<input type="checkbox"/>	<input type="checkbox"/>

Continuation Sheet Attached

Brief Description of Arguments to be Presented:
All claims are entitled to June 13, 1988 filing date. References that are appropriate prior art do not disclose novel features of invention.

An interview was conducted on the above-identified application on _____.
NOTE: This form should be completed by applicant and submitted to the examiner in advance of the interview (see MPEP § 713.01).
 This application will not be delayed from issue because of applicant's failure to submit a written record of this interview. Therefore, applicant is advised to file a statement of the substance of this interview (37 CFR 1.133(b)) as soon as possible.

 Applicant/Applicant's Representative Signature

 Examiner/SPE Signature

Robert A. Koons
 Typed/Printed Name of Applicant or Representative

32,474
 Registration Number, if applicable

This collection of information is required by 37 CFR 1.133. The information is required to obtain or retain a benefit by the public which is to file (and by the USPTO to process) an application. Confidentiality is governed by 35 U.S.C. 122 and 37 CFR 1.11 and 1.14. This collection is estimated to take 21 minutes to complete, including gathering, preparing, and submitting the completed application form to the USPTO. Time will vary depending upon the individual case. Any comments on the amount of time you require to complete this form and/or suggestions for reducing this burden, should be sent to the Chief Information Officer, U.S. Patent and Trademark Office, U.S. Department of Commerce, P.O. Box 1450, Alexandria, VA 22313-1450. DO NOT SEND FEES OR COMPLETED FORMS TO THIS ADDRESS. SEND TO: Commissioner for Patents, P.O. Box 1450, Alexandria, VA 22313-1450.

If you need assistance in completing the form, call 1-800-PTO-9199 and select option 2.

Attachment to Request for Interview

Summary of Exhibits to be Presented

- Claim charts demonstrating that the issue of alleged new matter was considered by and passed on by Examiner in original examination of patents in reexamination.
- Claim charts showing that each and every limitation of claims currently in reexamination has support in the specification filed on June 13, 1988.



UNITED STATES PATENT AND TRADEMARK OFFICE

UNITED STATES DEPARTMENT OF COMMERCE
United States Patent and Trademark Office
Address: COMMISSIONER FOR PATENTS
P.O. Box 1450
Alexandria, Virginia 22313-1450
www.uspto.gov

APPLICATION NO.	FILING DATE	FIRST NAMED INVENTOR	ATTORNEY DOCKET NO.	CONFIRMATION NO.
90/007,402	01/31/2005	5191573	NAPS001	2998

23973 7590 11/16/2006

DRINKER BIDDLE & REATH
ATTN: INTELLECTUAL PROPERTY GROUP
ONE LOGAN SQUARE
18TH AND CHERRY STREETS
PHILADELPHIA, PA 19103-6996

EXAMINER

ART UNIT PAPER NUMBER

DATE MAILED: 11/16/2006

Please find below and/or attached an Office communication concerning this application or proceeding.



UNITED STATES PATENT AND TRADEMARK OFFICE

Commissioner for Patents
United States Patent and Trademark Office
P.O. Box 1450
Alexandria, VA 22313-1450
www.uspto.gov

11/21/06

THIRD PARTY REQUESTER'S CORRESPONDENCE ADDRESS

ALBERT S. PENILA
MARTINE PENILLA & GENCARELLA LLP
710 LAKEWAY DRIVE, SUITE 200
SUNNYVALE, CA 94085

EX PARTE REEXAMINATION COMMUNICATION TRANSMITTAL FORM

REEXAMINATION CONTROL NO 90/007402
PATENT NO. 5,191,573
ART UNI 3992

Enclosed is a copy of the latest communication from the United States Patent and Trademark Office in the above identified ex parte reexamination proceeding (37 CFR 1.550(f)).

Where this copy is supplied after the reply by requester, 37 CFR 1.535, or the time for filing a reply has passed, no submission on behalf of the ex parte reexamination requester will be acknowledged or considered (37 CFR 1.550(g)).

Ex Parte Reexamination Interview Summary	Control No. <u>90/007,403</u>	Patent Under Reexamination
	90/007,402 ; 90/007,403	5191573 5675731 5966440
	Examiner	Art Unit
Roland G. Foster	3992	R.C.F. 11/16/06

All participants (USPTO personnel, patent owner, patent owner's representative):

(1) Roland G. Foster

(3) ROBERT A. KOONS

(2) TODD OICKINSON

(4) MICHAEL R. CASEY, PH.D.

Date of Interview: 11/16/06

ANDREW KASHIKOW
CLAYTON LABALLE

Type: a) Telephonic b) Video Conference
c) Personal (copy given to: 1) patent owner

2) patent owner's representative

Exhibit shown or demonstration conducted: d) Yes e) No.
If Yes, brief description: _____

Agreement with respect to the claims f) was reached. g) was not reached. h) N/A.
Any other agreement(s) are set forth below under "Description of the general nature of what was agreed to..."

Claim(s) discussed: N/A

Identification of prior art discussed: N/A

Description of the general nature of what was agreed to if an agreement was reached, or any other comments:
PATENT OWNER'S REPRESENTATIVES DISCUSSED PRIORITY AND I12 ISSUES AND STRATEGIES TO OVERCOME THEM. IN ADDITION, POSSIBLE AMENDMENTS WERE DISCUSSED.
(A fuller description, if necessary, and a copy of the amendments which the examiner agreed would render the claims patentable, if available, must be attached. Also, where no copy of the amendments that would render the claims patentable is available, a summary thereof must be attached.)

SEE THE ATTACHED CHARTS FOR ADDITIONAL DETAILS.

A FORMAL WRITTEN RESPONSE TO THE LAST OFFICE ACTION MUST INCLUDE PATENT OWNER'S STATEMENT OF THE SUBSTANCE OF THE INTERVIEW. (See MPEP § 2281). IF A RESPONSE TO THE LAST OFFICE ACTION HAS ALREADY BEEN FILED, THEN PATENT OWNER IS GIVEN ONE MONTH FROM THIS INTERVIEW DATE TO PROVIDE THE MANDATORY STATEMENT OF THE SUBSTANCE OF THE INTERVIEW (37 CFR 1.560(b)). THE REQUIREMENT FOR PATENT OWNER'S STATEMENT CAN NOT BE WAIVED. EXTENSIONS OF TIME ARE GOVERNED BY 37 CFR 1.550(c).

cc: Requester (if third party requester)

Examiner's signature, if required

	Parent Application 07/206,497 filed June 13, 1988		Child Application 07/586,391 filed September 18, 1990		Office Action in Application 07/586,391 and response		Issuance of '573 Patent
Feature	Date First Appearing in Claims of Parent Application	Date First Appearing in Specification of Parent Application	Date First Appearing in Claims of Child Application	Date First Appearing in Specification of Child Application	Consideration by Examiner Nguyen	Response by Applicant	Subsequent Action by Examiner Nguyen
Transferring Money from Second Party to a First Party (Charging a Fee)	December 22, 1988 February 28, 1990			September 18, 1990	Considered in Office Action February 24, 1992	Objection specifically responded to in June 25, 1992 response	Claims allowed in September 21, 1992 Office Action
Providing a Credit Card Number	December 22, 1988			September 18, 1990	Considered in Office Action February 24, 1992	Objection specifically responded to in June 25, 1992 response	Claims allowed in September 21, 1992 Office Action
Controlling Use of First/Second Memory	December 22, 1988			September 18, 1990	Considered in Office Action February 24, 1992	Objections responded to in June 25, 1992 response	Claims allowed in September 21, 1992 Office Action
Transmitting to a Location Determined by Second Party	February 28, 1990			September 18, 1990	Considered in Office Action February 24, 1992	Objection responded to June 25, 1992	Claims allowed in September 21, 1992 Office Action
Specific Video Download Procedures	February 28, 1990			September 18, 1990	No new matter issues were ever raised	No response was ever necessary since no issue was ever raised	Claims allowed in September 21, 1992 Office Action
First Party in Possession of Transmitter	August 24, 1990 (not entered)			September 18, 1990	Considered in Office Action February 24, 1992	Objections responded to in June 25, 1992 response	Claims allowed in September 21, 1992 Office Action

ATTACHMENT TO 90/007,402
36 PAGES

Second Party in Possession of Receiver and Second Memory	August 24, 1990 (not entered)			September 18, 1990	Considered in Office Action February 24, 1992	Objection specifically responded to in June 25, 1992 response	Claims allowed in September 21, 1992 Office Action
--	-------------------------------	--	--	--------------------	---	---	--

Claim Features of '440 Patent

Feature	Claims Reciting Feature	Written Description of Feature in Original Specification	Comments
A method/system for transferring desired digital video or digital audio signals	1-63	p. 1, lns. 13-15 p. 2, lns. 8-10, 20-26 (video) p. 5, lns. 36-43	<i>ipsis verbis</i>
forming a connection through telecommunications lines between a first memory of a first party and a second memory of a second party control unit of a second party	1-22, 25-28, 36-46, 58-63	p. 3, lns. 35-40	<i>ipsis verbis</i>
first memory having desired digital video or digital audio signals	1-21, 25-28, 42-57, 62, 63	p. 3, lns. 35-37	<i>ipsis verbis</i>
selling electronically by the first party to the second party through telecommunications lines	1-22, 25-28, 40, 42-45	p. 2, lns. 47-52 p. 3, lns. 35-40	<i>ipsis verbis</i>
transferring the desired digital video or digital audio signals from the first memory of the first party to the second memory of the second party control unit of the second party through telecommunications lines	1-21, 25-28, 36-40, 42-46, 62-63	p. 2, ln. 47-52 p. 3, lns. 35-40 Fig. 1	<i>ipsis verbis</i>

<p>the second party control unit with the second memory is in possession and control of the second party</p>	<p>1-41, 46-52, 62</p>	<p>p. 3, Ins. 26-33, 40-43</p>	<p>The as filed original specification includes <i>ipsis verbis</i> support for a second party control unit, where the user is the second party. A skilled artisan would readily recognize that the second memory is in possession and control of the second party, since the specification as originally filed states throughout that the user can store, sort and play thousands of songs from the user unit. A skilled artisan would clearly understand that this means the second party controls and possesses the second party control unit. This was previously pointed out in the declaration of Arthur Hair submitted May 5, 1992.</p>
<p>playing through speakers of the second party control unit the digital video or digital audio signals in the second memory</p>	<p>1-10, 11, 22, 36-46, 63</p>	<p>p. 2, Ins. 26-32</p>	<p><i>ipsis verbis</i></p>
<p>speakers of the second party control unit connected with the second memory of the second party control unit</p>	<p>1-10, 28, 35, 62</p>	<p>p. 3, Ins. 25-32 p. 4, Ins. 47-50 Fig. 1</p>	<p><i>ipsis verbis</i></p>

<p>first control unit in possession and control of first party</p>	<p>24, 31-35</p>	<p>p. 2, Ins. 38-43 p. 3, Ins. 35-49</p>	<p>The as filed original specification includes <i>ipsis verbis</i> support for a first party control unit, where the authorized agent is the first party. A skilled artisan would readily recognize that the first party control unit is in possession and control of the first party because as an "agent authorized to electronically sell and distribute" digital audio or digital video, the first party would necessarily have to possess and control the source of the digital audio and digital video. This was previously pointed out in the declaration of Arthur Hair submitted May 5, 1992.</p>
<p>second party location remote from the first party location, determined by the second party</p>	<p>2-63</p>	<p>p. 2, Ins. 47-50 p. 3, Ins. 20-40 Fig. 1 p. 4, Ins. 21-23</p>	<p>The original as filed specification states throughout that digital audio or digital video signals are sold and transferred via telephone lines. A skilled artisan would readily understand this to comprehend transfers between two remote locations. Since the second party possesses the second memory the second party can determine its location. This was previously pointed out in the declaration of Arthur Hair submitted May 5, 1992.</p>

<p>charging a fee via telecommunications lines by the first party to the second party</p>	<p>2-10, 19-21, 36-40, 43-45, 47-63</p>	<p>p. 1, Ins. 13-15 p. 2, Ins. 8-10, 20-23, 47-50 p. 3, Ins. 20-33 Fig. 1</p>	<p>The specification discloses electronic sales via telephone lines. Because the agent is authorized to sell and to transfer via telephone lines, there is implicitly support for selling and thereby charging a fee. This was previously pointed out in the declaration of Arthur Hair submitted December 30, 1993.</p>
<p>second party has an account, charging the account of the second party</p> <p>Possibly Amend to: "Charging the second party"</p>	<p>3-10, 20-21, 38-40, 44-45, 56-57, 60-61</p>	<p>p. 1, Ins. 13-15 p. 2, Ins. 8-10, 20-23, 47-50 p. 3, Ins. 20-33 Fig. 1</p>	<p>The specification discloses electronic sales via telephone lines. A skilled artisan would readily recognize that charging a fee via telecommunications lines would include the second party having an account that can be charged. This was previously pointed out in the declaration of Arthur Hair submitted December 30, 1993.</p>
<p>telephoning the first party controlling use of the first memory by the second party</p> <p>Possibly Amend to: "establishing telephone communications between the first memory and the second memory"</p>	<p>4-10, 39-40, 45, 57, 61</p>	<p>p. 2, Ins. 47-50 p. 3, Ins. 20-40 Fig. 1 p. 4, Ins. 21-23</p>	<p>The original as filed specification states throughout that digital audio or digital video signals are sold and transferred via telephone lines. A skilled artisan would readily recognize this as comprehending the telephoning of the first party by the second party to initiate a transaction. This was addressed previously in the declaration of Arthur Hair submitted May 5, 1992.</p>

providing a credit card number of the second party controlling the second memory to the first party controlling the first memory so the second party is charged money	4-10, 21, 39-40, 45, 61	p. 1, lns. 13-15 p. 2, lns. 8-10, 20-23, 38-52 p. 3, lns. 12-15, 35-37	The original as filed specification states throughout that the invention provides for electronic sales of digital audio or digital video signals. A skilled artisan would readily recognize credit card sales as being comprehended within electronic sales. This was addressed previously in the affidavit of Arthur Hair dated May 5, 1992.
storing the desired digital video or digital audio signals in the second memory	5-10, 22, 36-41	p. 2, lns. 23-27	<i>ipsis verbis</i>
electronically coding the desired digital video or digital audio signals into a configuration which would prevent unauthorized reproduction of the desired digital audio signals	6-8	p. 2, lns. 17-19 p. 4, lns. 15-20	<i>ipsis verbis</i>
first memory includes first party hard disk	7-8, 13, 14, 27-28, 34-35, 49-54	p. 4, lns. 5-6 p. 3, ln. 19 Fig. 1	<i>ipsis verbis</i>
second party can view desired digital video signals	58-61	p. 5, lns. 36-43 p. 3, lns. 26-33	The as filed original specification has <i>ipsis verbis</i> support for a video display. Since the specification explicitly says that the invention is applicable to video, a skilled artisan would recognize that a user could view the desired video signals on the video display.

second party can listen to the desired digital audio signals	63	p. 4, lns. 27-28, 36-50	<i>ipsis verbis</i>
first memory includes a sales random access memory chip	7-8, 13-18, 25-28, 49-54	p. 3, lns. 19-24 Fig. 1	<i>ipsis verbis</i>
second party control unit includes second memory	48-54	p. 3, lns. 26-30 Fig. 1	The as filed original specification has <i>ipsis verbis</i> support for a second party control unit. A skilled artisan would readily understand that the second party hard disk corresponds to a second memory.
second party control unit has a second party control panel	8, 12-21, 25-28, 32-35, 47-57	p. 3, lns. 26-27 Fig. 1	<i>ipsis verbis</i>
second party control panel connected to the second party integrated circuit	8, 16-18, 25-28, 32-35, 52-54	p. 3, lns. 26-28 Fig. 1	<i>ipsis verbis</i>
second memory of the second party control unit includes an incoming random access memory chip	9-10, 17-18, 25-28, 32-35, 53-54	p. 3, ln. 26-29 Fig. 1	<i>ipsis verbis</i>
second memory of the second party control unit includes a second party hard disk for storing the desired digital video or digital audio signals	9-10, 12-21, 25-28, 34-35, 50-54	p. 3, lns. 26-31 Fig. 1	<i>ipsis verbis</i>

second memory of the second party control unit includes a playback random access memory chip for temporarily storing the desired digital video or digital audio signals for sequential playback	9-10, 25-28, 32-35, 50-54	p. 3, Ins. 26-30 p. 4, Ins. 39-50 Fig. 1	<i>ipsis verbis</i>
a first party control unit having a first memory	12-21, 25-28	p. 3, Ins. 20-24 Fig. 1	<i>ipsis verbis</i>
second party control unit having means or a mechanism for playing the desired digital video or digital audio signals connected to the second memory and the second party control panel	12-35	p. 3, Ins. 26-33 Fig. 1	The as filed original specification has <i>ipsis verbis</i> support for speakers and video display which are means for playing.
first party control integrated circuit connected to the first party hard disk, the first party sales random access memory, and the second party control integrated circuit through the telecommunications lines	15-18, 25-28, 32-35, 51-54	p. 3, Ins. 20-33 Fig. 1	<i>ipsis verbis</i>

second party control integrated circuit connected to the second party hard disk, the playback random access memory, and the first party control integrated circuit through the telecommunications lines	16-18, 25-28, 52-54	p. 3, Ins. 20-33 Fig. 1	<i>ipsis verbis</i>
first party control integrated circuit and second party control integrated circuit regulate the transfer of the desired digital video or digital audio signals	13-18, 25-28	p. 4, Ins. 15-20	<i>ipsis verbis</i>
first party control panel connected to the first party control integrated circuit	15-18, 25-28, 51-54	p. 3, Ins. 20-24 Fig. 1	<i>ipsis verbis</i>
incoming random access memory chip connected to the second party hard drive and the second party control integrated circuit, and the first party control unit through the telecommunications lines	17-18, 25-28, 53-54	p. 3, Ins. 20-33 Fig. 1	<i>ipsis verbis</i>
second party control unit includes a video display unit and/or speakers	18, 25-28, 35, 47-61	p. 3, Ins. 26-33 Fig. 1	<i>ipsis verbis</i>

second party control unit having a receiver, second memory connected to the receiver	22, 41, 47-56, 58-60	p. 2, Ins. 47-49 p. 3, Ins. 35-38 p. 4, Ins. 24-26	A skilled artisan would readily recognize in order to receive digital audio or digital video signals over telecommunications lines as disclosed throughout the specification, part of the second party control unit would act as a receiver. This was addressed previously in the affidavit of Arthur Hair dated May 5, 1992.
second party financially distinct from the first party	22, 41	p. 2, Ins. 8-16, 20-27, 38-52 p. 35-49	Throughout the specification discloses electronic sales of digital video or digital audio signals. A skilled artisan would readily recognize that the first and second parties would be financially distinct since this is required in order to have a sale. This issue was previously addressed in the affidavit of Arthur Hair filed on May 5, 1992.
first memory with a transmitter in control and possession of the first party	22-24, 29-35, 41, 58-61, 63	p. 1, Ins. 10-12 p. 2, Ins. 8-10, 20-26, 47-52 p. 3, Ins. 20-25 p. 4, Ins. 21-23	The as filed original specification has <i>ipsis verbis</i> support for electronic distribution via telecommunications lines. A skilled artisan would readily recognize that this requires transmission of those signals, where the telecommunications lines act as the transmitter.

<p>receiver is in possession and control of the second party</p>	<p>22-24, 29-35, 41, 58-61, 63</p>	<p>p. 2, Ins. 47-49 p. 3, Ins. 35-38 p. 4, Ins. 24-26</p>	<p>A skilled artisan would readily recognize in order to receive digital audio or digital video signals over telecommunications lines as disclosed throughout the specification, part of the second party control unit would act as a receiver. This was addressed previously in the affidavit of Arthur Hair dated May 5, 1992. A skilled artisan would readily recognize that the receiver is in possession and control of the second party, since the specification as originally filed states throughout that the user can store, sort and play thousands of songs from the user unit. A skilled artisan would clearly understand that this means the second party controls and possesses the second party control unit. This was previously pointed out in the declaration of Arthur Hair submitted December 30, 1993.</p>
<p>means or mechanism for transferring money electronically via telecommunications lines from the second party to the first party controlling use of the first memory</p>	<p>23-24, 30-35</p>	<p>p. 1, Ins. 10-12 p. 2, Ins. 8-10, 20-26, 47-52 p. 3, Ins. 20-25 p. 4, Ins. 21-23</p>	<p>The as filed original specification has <i>ipsis verbis</i> support for electronic sales via telecommunications lines. A skilled artisan would readily recognize that electronic sales via telecommunications lines would include the transfer of money via telecommunications lines. This was addressed previously in the affidavit of Arthur Hair dated May 5, 1992.</p>

<p>second party choosing desired digital video or digital audio from first memory with second party control panel</p>	<p>47-63</p>	<p>p. 2, Ins. 8-16, 20-27, 38-52 p. 35-49</p>	<p>Throughout the specification discloses electronic sales of digital video or digital audio signals. A skilled artisan would readily recognize that this includes the selection of individual desired signals by the purchaser.</p>
<p>means or mechanism for connecting electronically via telecommunications lines the first memory with the second memory</p>	<p>23-24, 29-35</p>	<p>p. 4, Ins. 15-20 Fig. 1</p>	<p>A skilled artisan would readily recognize from the specification that the first memory would include a means for connecting to the second memory via the disclosed telephone lines.</p>
<p>means or a mechanism for transmitting the desired digital video or digital audio signals from the first memory to a receiver having the second memory</p>	<p>23-24, 29-35</p>	<p>p. 1, Ins. 10-12 p. 2, Ins. 8-10, 20-26, 47-52 p. 3, Ins. 20-25 p. 4, Ins. 21-23</p>	<p>The as filed original specification has <i>ipsis verbis</i> support for electronic distribution via telecommunications lines. A skilled artisan would readily recognize that this requires transmission of those signals, where the telecommunications lines act as the transmitter. A skilled artisan would also readily recognize in order to receive digital audio or digital video signals over telecommunications lines, part of the second party control unit would act as a receiver. This was addressed previously in the affidavit of Arthur Hair dated May 5, 1992.</p>

means or a mechanism for storing the digital video or digital audio signals in the second memory	23-24, 29-35	p. 3, Ins. 26-31 p. 4, Ins. 15-20 Fig. 1	The second party control unit includes a second party control integrated circuit which regulates the transfer of the digital audio and digital video signals. A skilled artisan would readily recognize that the second party integrated circuit regulates storage of the digital audio or digital video signals.
playing means or mechanism connected to the second memory	23-24, 29-35	p. 3, Ins. 26-33 p. 4, Ins. 39-50 Fig. 1	<i>ipsis verbis</i>
second memory connected to receiver and video display	48-54, 58-61	p. 3, Ins. 26-33 p. 4, Ins. 39-50 Fig. 1	The as filed original specification has <i>ipsis verbis</i> support for a video display connected to the second memory. A skilled artisan would also readily recognize in order to receive digital audio or digital video signals over telecommunications lines, part of the second party control unit would act as a receiver. This was addressed previously in the affidavit of Arthur Hair dated May 5, 1992.
telecommunications lines include telephone lines	26-28, 33-35	p. 3, ln. 25 Fig. 1	<i>ipsis verbis</i>
incurring a fee by second party to first party for use of telecommunication lines, the desired digital video or audio signal in first memory	46		(CANCEL)

Claim Features of '573 Patent

Feature	Claims Reciting Feature	Written Description of Feature in Original Specification	Comments
A method for transmitting a desired digital audio signal	1	p. 1, Ins. 7-9 p. 2, Ins. 8-10, 20-26	<i>ipsis verbis</i>
stored on a first memory of a first party to a second memory of a second party	1, 4	p. 3, Ins. 35-40 p. 4, Ins. 12-26	The specification states <i>ipsis verbis</i> that the hard disk in the control unit of the authorized agent is the source of the digital signal. Further, the specification states that the digital signal is transferred to the hard disk in the control unit of the user. A skilled artisan would understand this as transferring signals stored on a first memory to a second memory.
transferring money via a telecommunications line to a first party location remote from the second memory	1, 4	p. 1, Ins. 13-15 p. 2, Ins. 8-10, 20-23, 47-50 p. 3, Ins. 20-33 Fig. 1	The specification discloses electronic sales via telephone lines. Because the agent is authorized to sell and to transfer via telephone lines, there is implicitly support for selling and thereby transferring money. This was previously pointed out in the declaration of Arthur Hair submitted May 5, 1992. A skilled artisan would readily understand this to comprehend transfers between two remote locations.

second party financially distinct from the first party	1, 4	p. 1, Ins. 13-15 p. 2, Ins. 8-10, 20-23, 47-50 p. 3, Ins. 20-33	A skilled artisan would readily recognize that a sale requires the parties to be financially distinct. This was previously pointed out in the declaration of Arthur Hair submitted May 5, 1992.
second party controlling use and in possession of the second memory	1, 3	p. 3, Ins. 26-33, 40-43	The as filed original specification includes <i>ipsis verbis</i> support for a second party control unit, where the user is the second party. A skilled artisan would readily recognize that the second memory is in possession and control of the second party, since the specification as originally filed states throughout that the user can store, sort and play thousands of songs from the user unit. A skilled artisan would clearly understand that this means the second party controls and possesses the second party control unit. This was previously pointed out in the declaration of Arthur Hair submitted May 5, 1992.
connecting electronically via a telecommunications line the first memory with the second memory	1, 4	p. 3, Ins. 35-40	<i>ipsis verbis</i>

<p>transmitting the desired digital audio signal from the first memory with a transmitter in control and possession of the first party</p>	<p>1</p>	<p>p. 2, ln. 47-52 p. 3, lns. 35-40 Fig. 1</p>	<p>The as filed original specification has <i>ipsis verbis</i> support transmitting a desired digital audio signal and that the hard disk in the control unit of the authorized agent is the source. A skilled artisan would recognize that in order to regulate distribution of the signals the authorized agent would have to possess and control the transmitter. This was previously pointed out in the declaration of Arthur Hair submitted May 5, 1992.</p>
<p>to a receiver having the second memory at a location determined by the second party; said receiver in possession and control of the second party</p>	<p>1, 4</p>	<p>p. 2, lns. 47-50 p. 3, lns. 20-40 Fig. 1 p. 4, lns. 21-23</p>	<p>A skilled artisan would readily recognize in order to receive digital signals over telecommunications lines as disclosed throughout the specification, part of the second party control unit would act as a receiver. This was addressed previously in the affidavit of Arthur Hair dated May 5, 1992. A skilled artisan would also readily understand this to comprehend transfers between two remote locations. Since the second party possesses the second memory the second party can determine its location. This was addressed previously in the declaration of Arthur Hair submitted May 5, 1992.</p>

storing the digital audio signal in the second memory	1	p. 2, Ins. 23-27	<i>ipsis verbis</i>
searching the first memory for the desired digital audio signal	2	p. 3, Ins. 35-40 p. 4, Ins. 12-28	The as filed original specification has <i>ipsis verbis</i> support for electronic sales and electronic transfer of digital signals from a control unit of an authorized agent to a control unit of a user. A skilled artisan would readily recognize that this would include searching the hard disk of the first party to locate desired digital signals for purchase.
selecting the desired digital audio signal from the first memory	2	p. 3, Ins. 35-40 p. 4, Ins. 12-28	The as filed original specification has <i>ipsis verbis</i> support for electronic sales and electronic transfer of digital signals from a control unit of an authorized agent to a control unit of a user. A skilled artisan would readily recognize that this would include selecting desired digital signals from the hard disk of the first party for purchase.

<p>telephoning the first party controlling use of the first memory by the second party</p>	<p>3, 6</p>	<p>p. 2, Ins. 47-50 p. 3, Ins. 20-40 Fig. 1 p. 4, Ins. 21-23</p>	<p>The original as filed specification states throughout that digital audio or digital video signals are sold and transferred via telephone lines. A skilled artisan would readily recognize this as comprehending the telephoning of the first party by the second party to initiate a transaction. This was addressed previously in the declaration of Arthur Hair submitted May 5, 1992.</p>
<p>providing a credit card number of the second party to the first party so that the second party is charged money</p>	<p>3, 6</p>	<p>p. 1, Ins. 13-15 p. 2, Ins. 8-10, 20-23, 38-52 p. 3, Ins. 12-15, 35-37</p>	<p>The original as filed specification states throughout that the invention provides for electronic sales of digital audio or digital video signals. A skilled artisan would readily recognize credit card sales as being comprehended within electronic sales. This was addressed previously in the affidavit of Arthur Hair dated May 5, 1992.</p>

first party controlling the first memory	3, 6	p. 2, Ins. 38-43 p. 3, Ins. 35-49	The as filed original specification includes <i>ipsis verbis</i> support for a first party control unit, where the authorized agent is the first party. A skilled artisan would readily recognize that the first party control unit is in possession and control of the first party because as an "agent authorized to electronically sell and distribute" digital audio or digital video, the first party would necessarily have to possess and control the source of the digital audio and digital video. This was previously pointed out in the declaration of Arthur Hair submitted May 5, 1992.
A method for transmitting a desired digital video signal	4	p. 5, Ins. 36-43	<i>ipsis verbis</i>

<p>transmitting the desired digital video signal from the first memory with a transmitter in control and possession of the first party</p>	<p>4</p>	<p>p. 5, Ins. 36-43 p. 2, In. 47-52 p. 3, Ins. 35-40 Fig. 1</p>	<p>The as filed original specification has <i>ipsis verbis</i> support transmitting a desired digital audio signal and that the hard disk in the control unit of the authorized agent is the source. A skilled artisan would recognize that in order to regulate distribution of the signals the authorized agent would have to possess and control the transmitter. This was previously pointed out in the declaration of Arthur Hair submitted May 5, 1992. A skilled artisan would recognize based on the disclosure at the end of the specification that this procedure could also be used for digital video.</p>
<p>storing the digital video signal in the second memory</p>	<p>4</p>	<p>p. 5, Ins. 36-43 p. 2, Ins. 23-27</p>	<p>The as filed original specification has <i>ipsis verbis</i> support for storing digital signals on the hard disk of the user control unit. A skilled artisan would recognize based on the disclosure at the end of the specification that this procedure could also be used for digital video.</p>

<p>searching the first memory for the desired digital video signal</p>	<p>5</p>	<p>p. 3, Ins. 35-40 p. 4, Ins. 12-28 p. 5, Ins. 36-43</p>	<p>The as filed original specification has <i>ipsis verbis</i> support for electronic sales and electronic transfer of digital signals from a control unit of an authorized agent to a control unit of a user. A skilled artisan would readily recognize that this would include searching the hard disk of the first party to locate desired digital signals for purchase. A skilled artisan would recognize based on the disclosure at the end of the specification that this procedure could also be used for digital video.</p>
<p>selecting the desired digital video signal from the first memory</p>	<p>5</p>	<p>p. 3, Ins. 35-40 p. 4, Ins. 12-28 p. 5, Ins. 36-43</p>	<p>The as filed original specification has <i>ipsis verbis</i> support for electronic sales and electronic transfer of digital signals from a control unit of an authorized agent to a control unit of a user. A skilled artisan would readily recognize that this would include selecting desired digital signals from the hard disk of the first party for purchase. A skilled artisan would recognize based on the disclosure at the end of the specification that this procedure could also be used for digital video.</p>

Claim Features of '734 Patent

Feature	Claims Reciting Feature	Written Description of Feature in Original Specification	Comments
A method/system for transferring desired digital video or digital audio signals	1-34	p. 1, Ins. 7-9 p. 2, Ins. 8-10, 20-26 (video) p. 5, Ins. 36-43	<i>ipsis verbis</i>
forming a connection through telecommunications lines between a first memory of a first party and a second memory of a second party	1	p. 3, Ins. 35-40	<i>ipsis verbis</i>
first party location and second party location remote from the first party location, the second party location determined by the second party	1, 4, 11, 16, 19, 26	p. 2, Ins. 47-50 p. 3, Ins. 20-40 Fig. 1 p. 4, Ins. 21-23	The original as filed specification states throughout that digital audio or digital video signals are sold and transferred via telephone lines. A skilled artisan would readily understand this to comprehend transfers between two remote locations. Since the digital audio or digital video signals are transferred to the user's (second party's) control unit, a skilled artisan would readily understand that the second party can determine the second location.
the first party memory having a first party hard disk having a plurality of digital video or digital audio signals, including coded digital video or digital audio signals	1, 4, 16	p. 3, Ins. 35-37	<i>ipsis verbis</i>

the first memory having a sales random access memory chip	1	p. 3, Ins. 19-24 Fig. 1	<i>ipsis verbis</i>
telephoning the first party controlling the first memory by the second party Possibly Amend to: "establishing telephone communications between the first memory and the second memory"	1	p. 2, Ins. 47-50 p. 3, Ins. 20-40 Fig. 1 p. 4, Ins. 21-23	The original as filed specification states throughout that digital audio or digital video signals are sold and transferred via telephone lines. A skilled artisan would readily recognize this as comprehending the telephoning of the first party by the second party to initiate a transaction. This was addressed previously in the declaration of Arthur Hair submitted May 5, 1992.
providing a credit card number of the second party to the first party so that the second party is charged money	1	p. 1, Ins. 13-15 p. 2, Ins. 8-10, 20-23, 38-52 p. 3, Ins. 12-15, 35-37	The original as filed specification states throughout that the invention provides for electronic sales of digital audio or digital video signals. A skilled artisan would readily recognize credit card sales as being comprehended within electronic sales. This was addressed previously in the affidavit of Arthur Hair dated May 5, 1992.
electronically coding the digital video or digital audio signals to form coded digital audio signals into a configuration that would prevent unauthorized reproduction	1	p. 2, Ins. 17-19 p. 4, Ins. 15-20	<i>ipsis verbis</i>

storing a replica of the coded desired digital video or digital audio signals from the hard disk to the sales random access memory chip	1	p. 4, Ins. 15-23	<i>ipsis verbis</i>
transferring the stored replica of the coded desired digital video or digital audio signal from the sales random access memory chip of the first party to the second memory of the second party through telecommunications lines while the second memory is in possession and control of the second party	1, 4	p. 4, Ins. 15-23 p. 4, ln. 35 to p. 5, ln. 21	The original as filed specification includes <i>ipsis verbis</i> support for storing a replica of the coded desired digital audio or digital video signal to the first party sales random access memory, then transferring it to the memory of the second party. A skilled artisan would readily recognize that the second memory is in possession and control of the second party, since the specification as originally filed states throughout that the user can store, sort and play thousands of songs from the user unit. A skilled artisan would clearly understand that this means the second party controls and possesses the second memory. This was previously addressed in the declaration of Arthur Hair filed May 5, 1992.
storing the transferred digital video or digital audio signals in the second memory	1	p. 2, Ins. 23-27	<i>ipsis verbis</i>

a second party integrated circuit which controls and executes commands of the second party connected to a second party control panel	2	p. 3, Ins. 26-28 p. 4, Ins. 15-20 Fig. 1	<i>ipsis verbis</i>
commanding the second party integrated circuit with the second party control panel to initiate the purchase of the desired digital video or digital audio signals from the first party hard disk	2	p. 4, Ins. 12-20	(CANCEL)
the second memory includes a second party hard disk and an incoming random access memory chip	3, 5, 8, 13, 16, 21, 30	p. 3, Ins. 26-31 Fig. 1	<i>ipsis verbis</i>
the second memory includes a playback random access memory chip	3, 5, 16, 21, 30	p. 3, Ins. 26-30 p. 4, Ins. 39-50 Fig. 1	<i>ipsis verbis</i>
playing the desired digital video or digital audio signal from the second party hard disk	3	p. 2, Ins. 26-32	<i>ipsis verbis</i>

<p>a first party control unit (in possession and control of the first party)</p>	<p>4, 11, 16, 19, 26, 28</p>	<p>p. 2, Ins. 38-43 p. 3, Ins. 35-49</p>	<p>The as filed original specification includes <i>ipsis verbis</i> support for a first party control unit, where the authorized agent is the first party. A skilled artisan would readily recognize that the first party control unit is in possession and control of the first party because as an "agent authorized to electronically sell and distribute" digital audio or digital video, the first party would necessarily have to possess and control the source of the digital audio and digital video.</p>
--	------------------------------	--	--

<p>a second party control unit (in possession and control of the second party)</p>	<p>4, 11, 16, 19, 26, 28</p>	<p>p. 2, lns. 38-43 p. 3, lns. 35-49</p>	<p>The as filed original specification includes <i>ipsis verbis</i> support for a second party control unit, where the user is the second party. A skilled artisan would readily recognize that the second memory is in possession and control of the second party, since the specification as originally filed states throughout that the user can store, sort and play thousands of songs from the user unit. A skilled artisan would clearly understand that this means the second party controls and possesses the second party control unit. This was previously addressed in the declaration of Arthur Hair filed May 5, 1992.</p>
--	------------------------------	--	--

the first party control unit has a first party hard disk, a sales random access memory chip, and means or mechanism for electronically selling desired digital video or digital audio signals	4, 11, 19, 26, 28	p. 2, Ins. 8-10 p. 3, Ins. 20-40 Fig. 1	The as filed original specification has <i>ipsis verbis</i> support for a first party control unit with a hard disk, and sales random access memory chip. A skilled artisan would readily recognize that the first party control unit would include a means or mechanism for executing an electronic sale because the electronic sale is described in the original specification as separate from electronic transfer and electronic distribution.
the second party control unit has a second memory connected to the second party control panel	4, 19, 21, 26, 28	p. 3, Ins. 26-31 Fig. 1	The as filed original specification has <i>ipsis verbis</i> support for a control panel connected to the second party control unit. A skilled artisan would readily understand that the second party hard disk corresponds to a second memory.
the second party control unit has means for playing desired digital video or digital audio signals connected to and controlled by the second party control panel	4, 28	p. 3, Ins. 26-33 Fig. 1	<i>ipsis verbis</i>
selling digital video or digital audio signals through telecommunications lines	4	p. 2, Ins. 8-10, Ins. 47-50	<i>ipsis verbis</i>

the first party control unit includes a first party control integrated circuit connected to the first party hard disk, the sales random access memory and the second party control panel through telecommunications lines	4, 6, 11, 16, 19, 22, 26, 28, 31,	p. 3, Ins. 20-33 Fig. 1	<i>ipsis verbis</i>
the first party control unit includes a first party control panel connected to and through which the first party control integrated circuit is programmed	6, 11, 16, 22, 31	p. 3, Ins. 20-24 p. 4, Ins. 12-14 Fig. 1	<i>ipsis verbis</i>
the second party control unit includes a second party control integrated circuit connected to the second party hard disk, the playback random access memory and the first party control integrated circuit	7, 11, 16, 23, 32	p. 3, Ins. 20-33 p. 4, Ins 15-20 Fig. 1	<i>ipsis verbis</i>
the second party control integrated circuit and the first party control integrated circuit regulate the transfer of desired digital video or digital audio signals	7, 22, 23, 31, 32	p. 4, Ins. 15-20	<i>ipsis verbis</i>
the second party control unit includes a second party control panel connected to and through which the second party control integrated circuit is programmed	7, 16, 19, 23, 26, 28, 32	p. 3, Ins. 26-28 p. 4, Ins. 12-14 Fig. 1	<i>ipsis verbis</i>

the playing means of the second party control unit includes a video display	9, 14, 18, 19, 25, 34	p. 3, lns. 26-33 p. 5, lns. 9-21 Fig. 1	<i>ipsis verbis</i>
the telecommunications lines include telephone lines	10, 11, 12, 15, 17, 20, 27, 29	p. 3, ln. 25 Fig. 1	<i>ipsis verbis</i>
means or mechanism for transferring money electronically via telecommunications lines from the second party to the first party	11, 16, 19	p. 1, lns. 10-12 p. 2, lns. 8-10, 20-26, 47-52 p. 3, lns. 20-25 p. 4, lns. 21-23	The as filed original specification has <i>ipsis verbis</i> support for electronic sales via telecommunications lines. A skilled artisan would readily recognize that electronic sales via telecommunications lines would include the transfer of money via telecommunications lines. This was addressed previously in the affidavit of Arthur Hair dated May 5, 1992.
means or mechanism for the first party to charge a fee to the second party and granting access to desired digital video or digital audio signals	16, 19, 26	p. 1, lns. 13-15 p. 2, lns. 8-10, 20-23, 47-50 p. 3, lns. 20-33 Fig. 1	The specification discloses electronic sales via telephone lines. Because the agent is authorized to sell and to transfer via telephone lines, there is implicitly support for selling and thereby charging a fee. This was previously pointed out in the declaration of Arthur Hair submitted December 30, 1993.

means or mechanism for connecting electronically via telecommunications lines the first memory with the second memory	11, 16,	p. 4, Ins. 15-20 Fig. 1	A skilled artisan would readily recognize from the specification that the first memory would include a means for connecting to the second memory via the disclosed telephone lines.
the second party control unit includes an incoming random access memory	11, 16, 24, 33	p. 3, Ins. 26-29 Fig. 1	<i>ipsis verbis</i>
means or mechanism for transmitting desired digital video or digital audio signals	11, 16, 26, 28	p. 1, Ins. 10-12 p. 2, Ins. 8-10, 20-26, 47-52 p. 3, Ins. 20-25 p. 4, Ins. 21-23	The as filed original specification has <i>ipsis verbis</i> support for electronic distribution via telecommunications lines. A skilled artisan would readily recognize that this requires transmission of those signals, where the telecommunications lines act as the transmitter. A skilled artisan would also readily recognize in order to receive digital audio or digital video signals over telecommunications lines, part of the second party control unit would act as a receiver. This was addressed previously in the affidavit of Arthur Hair dated May 5, 1992.

<p>a transmitter connected to the first memory and the telecommunications lines, the first party in possession and control of the transmitter</p>	<p>11, 16</p>	<p>p. 1, Ins. 10-12 p. 2, Ins. 8-10, 20-26, 47-52 p. 3, Ins. 20-25 p. 4, Ins. 21-23</p>	<p>The as filed original specification has <i>ipsis verbis</i> support for electronic distribution via telecommunications lines. A skilled artisan would readily recognize that this requires transmission of those signals, where the telecommunications lines act as the transmitter.</p>
---	---------------	--	---

<p>a receiver connected to the second memory and the telecommunications lines, the second party in possession and control of the receiver</p>	<p>11, 16, 19, 26</p>	<p>p. 2, Ins. 47-49 p. 3, Ins. 35-38 p. 4, Ins. 24-26</p>	<p>A skilled artisan would readily recognize in order to receive digital audio or digital video signals over telecommunications lines as disclosed throughout the specification, part of the second party control unit would act as a receiver. This was addressed previously in the affidavit of Arthur Hair dated May 5, 1992.</p> <p>A skilled artisan would readily recognize that the receiver is in possession and control of the second party, since the specification as originally filed states throughout that the user can store, sort and play thousands of songs from the user unit. A skilled artisan would clearly understand that this means the second party controls and possesses the second party control unit. This was previously pointed out in the declaration of Arthur Hair submitted December 30, 1993.</p>
---	-----------------------	---	--

<p>the transmitter remote from the receiver, the receiver at a location determined by the second party in electrical communication with the connecting means or mechanism</p>	<p>11</p>	<p>p. 2, Ins. 47-50 p. 3, Ins. 20-40 Fig. 1 p. 4, Ins. 21-23</p>	<p>The original as filed specification states throughout that digital audio or digital video signals are sold and transferred via telephone lines. A skilled artisan would readily understand this to comprehend transfers between two remote locations. A skilled artisan would further recognize that in order for transmission of the digital audio or video signals to occur the transmitter and receiver have to be in electrical communication with the connecting means.</p>
<p>means or mechanism for storing desired digital video or digital audio signals with the receiver</p>	<p>11, 16</p>	<p>p. 3, Ins. 26-31 p. 4, Ins. 15-20 Fig. 1</p>	<p>The second party control unit includes a second party control integrated circuit which regulates the transfer of the digital audio and digital video signals. A skilled artisan would readily recognize that the second party integrated circuit regulates storage of the digital audio or digital video signals.</p>

speakers in possession and control of the second party	14, 18, 26	p. 3, ln. 33, 47-49	The as filed original specification has <i>ipsis verbis</i> support for speakers. A skilled artisan would readily recognize that the speakers would be in possession and control of the second party since the specification throughout states that the second party may repeatedly listen to stored songs through the speakers.
the second party choosing desired digital audio signals from the first party's hard disk	26	p. 2, lns. 8-16, 20-27, 38-52 p. 35-49	Throughout the specification discloses electronic sales of digital video or digital audio signals. A skilled artisan would readily recognize that this includes the selection of individual desired signals by the purchaser.

Application Number 	Application/Center 90/007,402	Applicant(s)/Patent under Re examination 5191573	
	Examiner Roland G. Foster	Art Unit 3992	

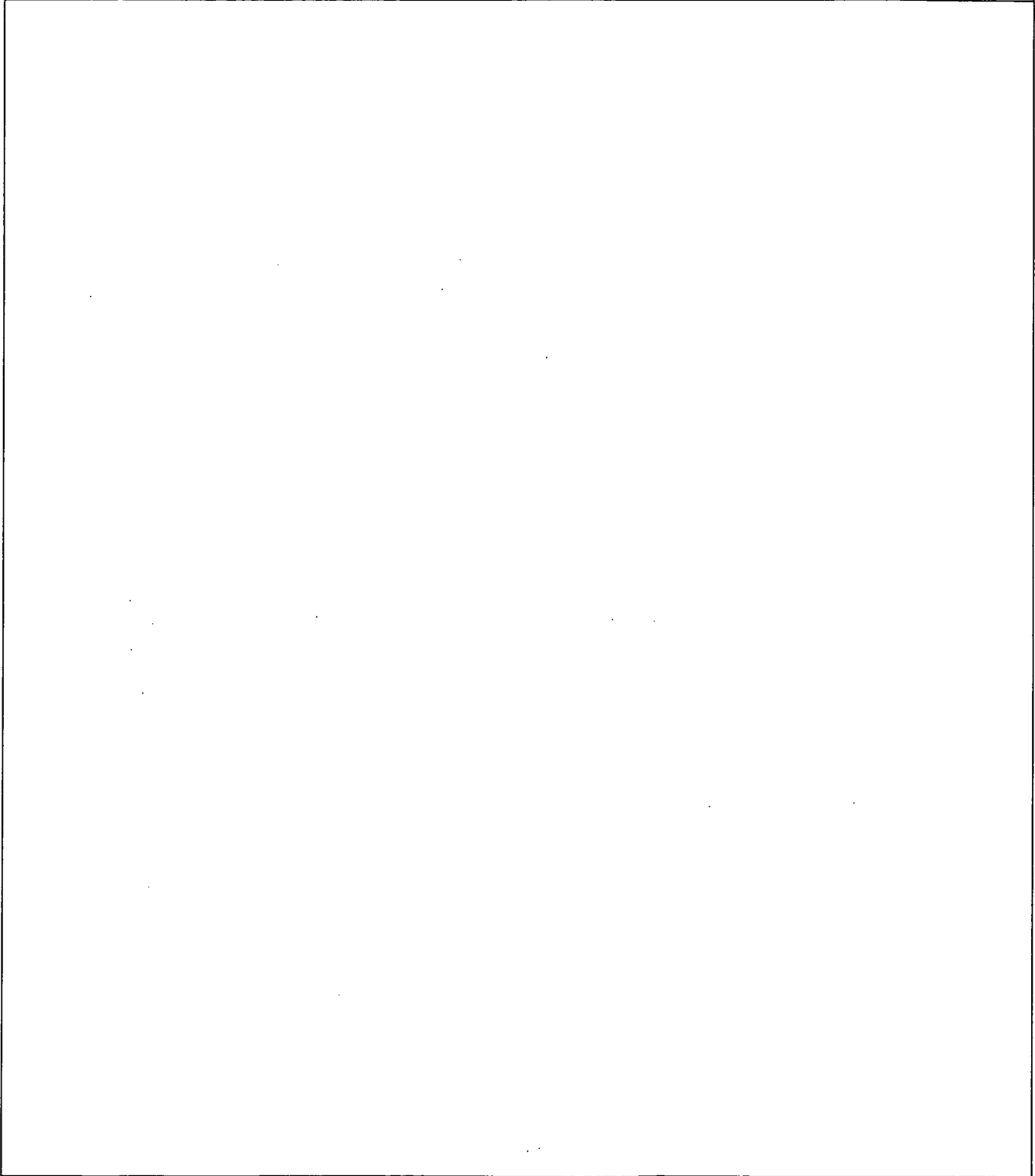

TRANSMITTAL FORM <i>(to be used for all correspondence after initial filing)</i>		Patent Number	5,191,573
		Issue Date	2 March 1993
		First Named Inventor	Arthur R. Hair
		Control Number	90/007402
		Examiner Name	Roland Foster
		Customer Number	23973
Total Number of Pages in This Submission		Attorney Docket Number	219099/573

ENCLOSURES (check all that apply)		
<input type="checkbox"/> Fee Transmittal Form <input type="checkbox"/> Fee Attached <input checked="" type="checkbox"/> Amendment/Reply <input type="checkbox"/> Restriction Requirement <input checked="" type="checkbox"/> Response/Amendment to non-final Office Action <input type="checkbox"/> After Final <input type="checkbox"/> Affidavits/declaration(s) <input type="checkbox"/> Extension of Time Request <input type="checkbox"/> Express Abandonment Request <input type="checkbox"/> Information Disclosure Statement <input type="checkbox"/> Certified Copy of Priority Document(s) <input type="checkbox"/> Response to Missing Parts/ Incomplete Application <input type="checkbox"/> Response to Missing Parts under 37 CFR 1.52 or 1.53	<input type="checkbox"/> Assignment Papers (for an Application) <input type="checkbox"/> Drawing(s) – Figs. <input type="checkbox"/> Licensing-related Papers <input type="checkbox"/> Petition <input type="checkbox"/> Petition to Convert to a Provisional Application <input type="checkbox"/> Power of Attorney, Revocation Change of Correspondence Address <input type="checkbox"/> Terminal Disclaimer <input type="checkbox"/> Request for Refund <input type="checkbox"/> CD, Number of CD(s) <input type="checkbox"/> Landscape Table on CD	<input type="checkbox"/> After Allowance Communication to TC <input type="checkbox"/> Appeal Communication to Board of Appeals and Interferences <input type="checkbox"/> Appeal Communication to TC (Appeal Notice, Brief, Reply Brief) <input type="checkbox"/> Proprietary Information <input type="checkbox"/> Status Letter <input checked="" type="checkbox"/> Other Enclosure(s) (please identify below): <input checked="" type="checkbox"/> Return Receipt Postcard <input checked="" type="checkbox"/> Check <input checked="" type="checkbox"/> Authorization and Petition <input checked="" type="checkbox"/> Certificate of Service

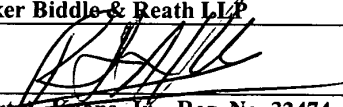
SIGNATURE OF APPLICANT, ATTORNEY, OR AGENT	
Firm Name	Drinker Biddle & Reath LLP
Signature	
Printed Name	Robert A. Koons, Jr., Reg. No. 32474
Date	29 November 2006

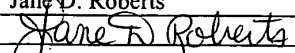
CERTIFICATE OF MAILING UNDER 37 CFR 1.10		
I hereby certify that this paper, along with any documents referred to as being enclosed therewith, is being deposited with the United States Postal Service in an Express Mail envelope addressed to Mail Stop Ex Parte ReExam, Commissioner for Patents, P.O. Box 1450, Alexandria, VA 22313-1450 on:		
Typed or printed name	Jane D. Roberts	Express Mail No.: EV 502958270 US
Signature		Date: 29 November 2006

CERTIFICATE UNDER 37 C.F.R. 1.10

70181 U.S. PTO
11/29/06

In Re: Arthur R. Hair

Docket No.: 219099/573

Patent No.: 5,191,573

Re-Examination Control No.: 90/007,402

Re-Examination Filing Date: January 31, 2005

Examiner: Roland Foster

3992

EXPRESS MAIL: EV 502958270 US

DATE OF DEPOSIT: November 29, 2006

I hereby certify that the following correspondence

**Transmittal Letter and Fee Sheet
Response/Amendment
Authorization
Certificate of Service
Return Receipt Postcard**

are being deposited with the United States Postal Service "Express Mail Post Office to Addressee" service under 37 CFR 1.10 on the date indicated above and is addressed to Mail Stop Ex Parte Re-Examination, Commissioner for Patents, PO Box 1450, Alexandria, VA 22313-1450.

Jane D. Roberts

(Typed or printed name of person mailing paper)

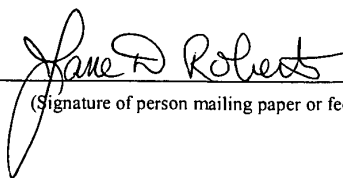
(Signature of person mailing paper or fee)

Drinker Biddle & Reath LLP
One Logan Square
18th and Cherry Streets
Philadelphia, PA 19103-6996

Customer No. 23973

CERTIFICATE OF SERVICE

The undersigned hereby certifies that a true and correct copy of the foregoing Response in Reexamination No. 90/007,402 was served via First Class United States Mail, postage prepaid, this 29th day of November, 2006, on the following:

Mr. Albert S. Penilla
Martine, Penilla, & Gencarella, LLP
710 Lakeway Drive, Suite 200
Sunnyvale, CA 94085
Attorney for Third Party Reexamination Requester

By: _____

Robert A. Koons, Jr.
Attorney for Patentee

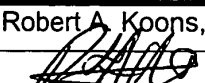
FEE TRANSMITTAL for FY 2006		<i>Complete if known</i>																																																																																																																																																																																	
<i>Patent fees are subject to annual revision.</i>		Patent Number	5,191,573																																																																																																																																																																																
		Issue Date	2 March 1993																																																																																																																																																																																
		First Named Inventor	Arthur R. Hair																																																																																																																																																																																
		Examiner Name	Roland Foster																																																																																																																																																																																
<input type="checkbox"/> Applicant claims small entity status. See 37 CFR 1.27		Control Number	90/007402																																																																																																																																																																																
TOTAL AMOUNT OF PAYMENT (\$00)		Attorney Docket No.	219099/573																																																																																																																																																																																
METHOD OF PAYMENT (check all that apply)		FEE CALCULATION (continued)																																																																																																																																																																																	
<input type="checkbox"/> Check <input type="checkbox"/> Credit Card <input type="checkbox"/> Money Order <input type="checkbox"/> Other <input type="checkbox"/> None <input checked="" type="checkbox"/> Deposit Account: Deposit Account Number <u>50-0573</u> Deposit Account Name <u>Drinker Biddle & Reath LLP</u> The Director is authorized to: (check all that apply) <input type="checkbox"/> Charge fee(s) indicated below <input checked="" type="checkbox"/> Credit any overpayments <input checked="" type="checkbox"/> Charge any additional fee required under 37 CFR 1.16 and 1.17 <input type="checkbox"/> Charge fee(s) indicated below, except for the filing fee to the above-identified deposit account.		ADDITIONAL FEES <table border="1" style="width:100%; border-collapse: collapse;"> <thead> <tr> <th>Fee Code</th> <th>Large Entity Fee (\$)</th> <th>Fee Code</th> <th>Small Entity Fee (\$)</th> <th>Fee Description</th> <th>Fee Paid</th> </tr> </thead> <tbody> <tr><td>1051</td><td>130</td><td>2051</td><td>65</td><td>Surcharge - late filing fee or oath</td><td></td></tr> <tr><td>1052</td><td>50</td><td>2052</td><td>25</td><td>Surcharge - late provisional filing fee or cover sheet</td><td></td></tr> <tr><td>1053</td><td>130</td><td>1053</td><td>130</td><td>Non-English specification</td><td></td></tr> <tr><td>1812</td><td>2,520</td><td>1812</td><td>2,520</td><td>For filing a request for <i>ex parte</i> reexamination</td><td></td></tr> <tr><td>1804</td><td>920*</td><td>1804</td><td>920*</td><td>Requesting publication of SIR prior to Examiner action</td><td></td></tr> <tr><td>1805</td><td>1,840*</td><td>1805</td><td>1,840*</td><td>Requesting publication of SIR after Examiner action</td><td></td></tr> <tr><td>1251</td><td>120</td><td>2251</td><td>60</td><td>Extension for reply within first month</td><td></td></tr> <tr><td>1252</td><td>450</td><td>2252</td><td>225</td><td>Extension for reply within second month</td><td></td></tr> <tr><td>1253</td><td>1,020</td><td>2253</td><td>510</td><td>Extension for reply within third month</td><td></td></tr> <tr><td>1254</td><td>1,590</td><td>2254</td><td>795</td><td>Extension for reply within fourth month</td><td></td></tr> <tr><td>1255</td><td>2,160</td><td>2255</td><td>1,080</td><td>Extension for reply within fifth month</td><td></td></tr> <tr><td>1401</td><td>500</td><td>2401</td><td>250</td><td>Notice of Appeal</td><td></td></tr> <tr><td>1402</td><td>500</td><td>2402</td><td>250</td><td>Filing a brief in support of an appeal</td><td></td></tr> <tr><td>1403</td><td>1,000</td><td>2403</td><td>500</td><td>Request for oral hearing</td><td></td></tr> <tr><td>1451</td><td>1,510</td><td>1451</td><td>1,510</td><td>Petition to institute a public use proceeding</td><td></td></tr> <tr><td>1452</td><td>500</td><td>2452</td><td>250</td><td>Petition to revive - unavoidable</td><td></td></tr> <tr><td>1453</td><td>1,500</td><td>2453</td><td>750</td><td>Petition to revive - unintentional</td><td></td></tr> <tr><td>1501</td><td>1,400</td><td>2501</td><td>700</td><td>Utility issue fee (or reissue)</td><td></td></tr> <tr><td>1503</td><td>1,100</td><td>2503</td><td>550</td><td>Plant issue fee</td><td></td></tr> <tr><td>1462</td><td>400</td><td>1462</td><td>400</td><td>Petition to the Commissioner - Group I</td><td></td></tr> <tr><td>1463</td><td>200</td><td>1463</td><td>200</td><td>Petition to the Commissioner - Group II</td><td></td></tr> <tr><td>1464</td><td>130</td><td>1464</td><td>130</td><td>Petition to the Commissioner - Group III</td><td></td></tr> <tr><td>1807</td><td>50</td><td>1807</td><td>50</td><td>Processing fee under 37 CFR 1.17(q)</td><td></td></tr> <tr><td>1806</td><td>180</td><td>1806</td><td>180</td><td>Submission of Information Disclosure Stmt</td><td></td></tr> <tr><td>1810</td><td>790</td><td>2810</td><td>395</td><td>For each additional invention to be examined (37 CFR § 1.129(b))</td><td></td></tr> <tr><td>1801</td><td>790</td><td>2801</td><td>395</td><td>Request for Continued Examination (RCE)</td><td></td></tr> <tr><td>1802</td><td>900</td><td>1802</td><td>900</td><td>Request for expedited examination of a design application</td><td></td></tr> <tr><td colspan="6">Other fee (specify)</td></tr> </tbody> </table>				Fee Code	Large Entity Fee (\$)	Fee Code	Small Entity Fee (\$)	Fee Description	Fee Paid	1051	130	2051	65	Surcharge - late filing fee or oath		1052	50	2052	25	Surcharge - late provisional filing fee or cover sheet		1053	130	1053	130	Non-English specification		1812	2,520	1812	2,520	For filing a request for <i>ex parte</i> reexamination		1804	920*	1804	920*	Requesting publication of SIR prior to Examiner action		1805	1,840*	1805	1,840*	Requesting publication of SIR after Examiner action		1251	120	2251	60	Extension for reply within first month		1252	450	2252	225	Extension for reply within second month		1253	1,020	2253	510	Extension for reply within third month		1254	1,590	2254	795	Extension for reply within fourth month		1255	2,160	2255	1,080	Extension for reply within fifth month		1401	500	2401	250	Notice of Appeal		1402	500	2402	250	Filing a brief in support of an appeal		1403	1,000	2403	500	Request for oral hearing		1451	1,510	1451	1,510	Petition to institute a public use proceeding		1452	500	2452	250	Petition to revive - unavoidable		1453	1,500	2453	750	Petition to revive - unintentional		1501	1,400	2501	700	Utility issue fee (or reissue)		1503	1,100	2503	550	Plant issue fee		1462	400	1462	400	Petition to the Commissioner - Group I		1463	200	1463	200	Petition to the Commissioner - Group II		1464	130	1464	130	Petition to the Commissioner - Group III		1807	50	1807	50	Processing fee under 37 CFR 1.17(q)		1806	180	1806	180	Submission of Information Disclosure Stmt		1810	790	2810	395	For each additional invention to be examined (37 CFR § 1.129(b))		1801	790	2801	395	Request for Continued Examination (RCE)		1802	900	1802	900	Request for expedited examination of a design application		Other fee (specify)					
Fee Code	Large Entity Fee (\$)	Fee Code	Small Entity Fee (\$)	Fee Description	Fee Paid																																																																																																																																																																														
1051	130	2051	65	Surcharge - late filing fee or oath																																																																																																																																																																															
1052	50	2052	25	Surcharge - late provisional filing fee or cover sheet																																																																																																																																																																															
1053	130	1053	130	Non-English specification																																																																																																																																																																															
1812	2,520	1812	2,520	For filing a request for <i>ex parte</i> reexamination																																																																																																																																																																															
1804	920*	1804	920*	Requesting publication of SIR prior to Examiner action																																																																																																																																																																															
1805	1,840*	1805	1,840*	Requesting publication of SIR after Examiner action																																																																																																																																																																															
1251	120	2251	60	Extension for reply within first month																																																																																																																																																																															
1252	450	2252	225	Extension for reply within second month																																																																																																																																																																															
1253	1,020	2253	510	Extension for reply within third month																																																																																																																																																																															
1254	1,590	2254	795	Extension for reply within fourth month																																																																																																																																																																															
1255	2,160	2255	1,080	Extension for reply within fifth month																																																																																																																																																																															
1401	500	2401	250	Notice of Appeal																																																																																																																																																																															
1402	500	2402	250	Filing a brief in support of an appeal																																																																																																																																																																															
1403	1,000	2403	500	Request for oral hearing																																																																																																																																																																															
1451	1,510	1451	1,510	Petition to institute a public use proceeding																																																																																																																																																																															
1452	500	2452	250	Petition to revive - unavoidable																																																																																																																																																																															
1453	1,500	2453	750	Petition to revive - unintentional																																																																																																																																																																															
1501	1,400	2501	700	Utility issue fee (or reissue)																																																																																																																																																																															
1503	1,100	2503	550	Plant issue fee																																																																																																																																																																															
1462	400	1462	400	Petition to the Commissioner - Group I																																																																																																																																																																															
1463	200	1463	200	Petition to the Commissioner - Group II																																																																																																																																																																															
1464	130	1464	130	Petition to the Commissioner - Group III																																																																																																																																																																															
1807	50	1807	50	Processing fee under 37 CFR 1.17(q)																																																																																																																																																																															
1806	180	1806	180	Submission of Information Disclosure Stmt																																																																																																																																																																															
1810	790	2810	395	For each additional invention to be examined (37 CFR § 1.129(b))																																																																																																																																																																															
1801	790	2801	395	Request for Continued Examination (RCE)																																																																																																																																																																															
1802	900	1802	900	Request for expedited examination of a design application																																																																																																																																																																															
Other fee (specify)																																																																																																																																																																																			
FEE CALCULATION																																																																																																																																																																																			
Total Claims Remaining After Amendment: 12 Highest # Total Claims Previously Paid For: 43 Total Claims Unpaid For: 0 Independent Claims After Amendment: 4 Highest # Independent Claims Prev. Paid For: 10 Total Independent Claims Unpaid For: 0 Number of Multiple Dependent Claims: 0 Additional Fee Owed: 0																																																																																																																																																																																			
<table border="1" style="width:100%; border-collapse: collapse;"> <thead> <tr> <th>Large Fee Code</th> <th>Entity Fee (\$)</th> <th>Small Fee Code</th> <th>Entity Fee</th> <th>Fee Description</th> </tr> </thead> <tbody> <tr><td>1202</td><td>50</td><td>2202</td><td>25</td><td>Claims in excess of 20</td></tr> <tr><td>1201</td><td>200</td><td>2201</td><td>100</td><td>Independent claims in excess of 3</td></tr> <tr><td>1203</td><td>360</td><td>2203</td><td>180</td><td>Multiple dependent claim, if not paid</td></tr> <tr><td>1204</td><td>200</td><td>2204</td><td>100</td><td>**Reissue independent claims over original patent</td></tr> <tr><td>1205</td><td>50</td><td>2205</td><td>25</td><td>**Reissue claims in excess of 20 and over original patent</td></tr> </tbody> </table>		Large Fee Code	Entity Fee (\$)	Small Fee Code	Entity Fee	Fee Description	1202	50	2202	25	Claims in excess of 20	1201	200	2201	100	Independent claims in excess of 3	1203	360	2203	180	Multiple dependent claim, if not paid	1204	200	2204	100	**Reissue independent claims over original patent	1205	50	2205	25	**Reissue claims in excess of 20 and over original patent																																																																																																																																																				
Large Fee Code	Entity Fee (\$)	Small Fee Code	Entity Fee	Fee Description																																																																																																																																																																															
1202	50	2202	25	Claims in excess of 20																																																																																																																																																																															
1201	200	2201	100	Independent claims in excess of 3																																																																																																																																																																															
1203	360	2203	180	Multiple dependent claim, if not paid																																																																																																																																																																															
1204	200	2204	100	**Reissue independent claims over original patent																																																																																																																																																																															
1205	50	2205	25	**Reissue claims in excess of 20 and over original patent																																																																																																																																																																															
**or number previously paid, if greater; For Reissue, see above																																																																																																																																																																																			
SUBMITTED BY CUSTOMER NO. 23973		<i>Complete (if applicable)</i>																																																																																																																																																																																	
Name (Print/Type)	Robert A. Koons, Jr.	Registration No. (Attorney/Agent)	32474	Telephone	(215) 988.3392																																																																																																																																																																														
Signature				Date	29 November 2006																																																																																																																																																																														

IN THE UNITED STATES PATENT AND TRADEMARK OFFICE

In re Application of:)
ARTHUR R. HAIR)
Reexamination Control No. 90/007,402)
Reexamination Filed: January 31, 2005) METHOD FOR TRANSMITTING
Patent Number: 5,191,573) A DESIRED DIGITAL VIDEO OR
Examiner: Roland Foster) AUDIO SIGNAL



Mail Stop *Ex Parte* Reexamination
Commissioner for Patents
P.O. Box 1450
Alexandria, VA 22313-1450

Sir:

RESPONSE

In response to the Office Action for the above-identified reexamination dated September 29, 2006, please enter the following amendments and remarks.

Amendments to the Claims begin on page **2** of this paper.

Remarks begin on page **6** of this paper.

In the Claims

1.(Amended) A method for transmitting a desired digital audio signal stored on a first memory of a first party to a second memory of a second party comprising the steps of:

transferring money electronically via a telecommunications line to the first party at a location remote from the second memory and controlling use of the first memory from the second party financially distinct from the first party, said second party controlling use and in possession of the second memory;

connecting electronically via a telecommunications line the first memory with the second memory such that the desired digital audio signal can pass therebetween;

transmitting the desired digital audio signal from the first memory with a transmitter in control and possession of the first party to a receiver having the second memory at a location determined by the second party, said receiver in possession and control of the second party;

and storing the digital signal in a non-volatile storage portion of the second memory, wherein the non-volatile storage portion is not a tape or a CD.

4.(Amended) A method for transmitting a desired digital video signal stored on a first memory of a first party to a second memory of a second party comprising the steps of:

transferring money electronically via a telecommunications line to the first party at a location remote from the second memory and controlling use of the first memory from the second party financially distinct from the first party, said second party controlling use and in possession of the second memory;

connecting electronically via a telecommunications line the first memory with the second memory such that the desired digital video signal can pass therebetween;

transmitting the desired digital video signal from the first memory with a transmitter in control and possession of the first party to a receiver having the second memory at a location determined by the second party, said receiver in possession and control of the second party; and storing the digital signal in a non-volatile storage portion of the second memory, wherein the non-volatile storage portion is not a tape or a CD.

7 - 43. (Canceled)

44. (New) A method for transmitting a desired digital audio signal stored on a first memory of a first party to a second memory of a second party comprising the steps of:

transferring money electronically via a telecommunications line to the first party at a location remote from the second memory and controlling use of the first memory from the second party financially distinct from the first party, said second party controlling use and in possession of the second memory;

the second memory including a second party hard disk;

connecting electronically via a telecommunications line the first memory with the second memory such that the desired digital audio signal can pass therebetween;

transmitting the desired digital audio signal from the first memory with a transmitter in control and possession of the first party to a receiver having the second memory at a location determined by the second party, said receiver in possession and control of the second party; and storing the digital signal in the second party hard disk.

45.(New) A method as described in claim 44 including after the transferring step, the steps of searching the first memory for the desired digital audio signal; and selecting the desired digital audio signal from the first memory.

46. (New) A method as described in claim 45 wherein the transferring step includes the steps of telephoning the first party controlling use of the first memory by the second party; providing a credit card number of the second party controlling the second memory to the first party controlling the first memory so the second party is charged money.

47. (New) A method for transmitting a desired digital video signal stored on a first memory of a first party to a second memory of a second party comprising the steps of:

transferring money electronically via a telecommunications line to the first party at a location remote from the second memory and controlling use of the first memory from the second party financially distinct from the first party, said second party controlling use and in possession of the second memory;

the second memory including a second party hard disk;

connecting electronically via a telecommunications line the first memory with the second memory such that the desired digital video signal can pass therebetween;

transmitting the desired digital video signal from the first memory with a transmitter in control and possession of the first party to a receiver having the second memory at a location determined by the second party, said receiver in possession and control of the second party;

and storing the digital signal in the second party hard disk.

48.(New) A method as described in claim 47 including after the transferring step, the steps of searching the first memory for the desired digital signal; and selecting the desired digital signal from the first memory.

49. (New) A method as described in claim 47 wherein the transferring step includes the steps of telephoning the first party controlling use of the first memory by the second party; providing a credit card number of the second party controlling the second memory to the first party controlling the first memory so the second party is charged money.

REMARKS

Claims 1 through 6, which originally issued in the patent under reexamination, and new Claims 44 through 49, are currently pending in the reexamination. Patentee has amended Claims 1 and 4. Patentee has canceled Claims 7 through 43 without prejudice. Patentee has added new Claims 44 through 49.

I. SUMMARY

Patentee first wishes to thank the Examiner and the Office for taking time to conduct the Interview held on November 16, 2006 to discuss the instant reexamination and the two copending reexaminations.

In the most recent Office Action, the Office has raised new rejections based on prior art and alleged failure of the patents in reexamination to comply with the written description and enablement requirements of 35 U.S.C. § 112, first paragraph. Related to the alleged failure of the claims to be supported properly or enabled by the originally filed specification, the Office has further alleged that the claims in the instant reexamination are not entitled to the priority date corresponding to the filing date of the original specification.

To establish either *prima facie* anticipation or obviousness of the claims, the Office has cited patent references that do not qualify as prior art based on the June 13, 1988 priority date, to which the Patentee believes the claims in reexamination are entitled. As a predicate for citing this post 1988 art, the Office has asserted that the claims of U.S. Patent No. 5,191,573 (the “573 Patent”) are not entitled to the June 13, 1988 filing date due to an alleged failure of the originally filed specification to provide an adequate written description and/or properly enable the claimed invention. For the reasons set forth below, Patentee respectfully submits that it is improper for the Office to reconsider the priority date awarded to the claims as issued in the original

examination. In addition, notwithstanding the impropriety of considering the issue, Patentee respectfully submits for the reasons set forth below that the claims as issued in the '573 Patent both are described adequately and enabled by the original specification as filed. As a result, the claims as issued are entitled to the June 13, 1988 priority date and the post 1988 references cited by the Office, i.e., U.S. Patent No. 4,949,187 to *Cohen (Cohen)*; U.S. Patent No. 5,132,992 to *Yurt (Yurt)*; and U.S. Patent No. 5,241,428 to *Goldwasser et al (Goldwasser)*, cannot be considered for the purposes of 35 U.S.C. §§ 102 and 103.

The Office also has cited several references that antedate the June 13, 1988 priority date. However, all of these references relate to reproducing copies of audio or video signals on tapes and/or CDs. As set forth below, the claimed invention obviates the need for tapes and CDs as a storage medium for audio and video signals. As a result, none of the applicable prior art of record, either alone or in combination, shows suggests, or teaches each and every limitation of the claimed invention.

Further, the rejections of Claims 7 through 43 under 35 U.S.C. § 112, first paragraph have been mooted by the cancellation of those claims. As recognized by the Office, it is inappropriate to apply rejections under 35 U.S.C. § 112 to unamended claims, as is the case with originally issued Claims 1 through 6. Specifically, under 37 C.F.R. § 1.552, it is only appropriate to consider 35 U.S.C. § 112 "with respect to subject matter added or deleted in the reexamination proceeding."

Patentee has introduced amendments to originally issued Claims 1, and 4 that are fully supported by the specification filed on June 13, 1988, as set forth below. Patentee respectfully submits that, because the claims as issued in the '573 Patent are entitled to the June 13, 1988 priority date, and because the amendatory subject matter added by the instant amendments is

supported fully by the originally filed specification, the claims as amended also are entitled to the June 13, 1988 priority date, and further are allowable over the applicable prior art of record for the reasons set forth below.

II. CLAIM AMENDMENTS

Patentee has amended Claims 1 and 4 to recite that the digital audio or digital video signals are stored in a non-volatile storage portion of the second memory, wherein the non-volatile storage is not a tape or CD. Support for this feature is found in the originally filed specification for example at page 4, lines 35 to 49, *et seq.*, which recites specifically a hard disk for storing digital audio or digital video signals. A hard disk is a form of non-volatile storage. *See e.g.* http://en.wikipedia.org/wiki/Non-volatile_storage (“Non-volatile memory, or non-volatile storage, is computer memory that can retain the stored information even when not powered.”) Examples of non-volatile storage include computer hard disks. *See Id.* This definition is consistent with the usage of the term “non-volatile storage” at the time the original specification was filed. *See e.g.* U.S. Patent No. 4,458,109 at column 10, lines 60 to 62 (“The message MSG is stored on a non-volatile mass storage subsystem 43, for instance a hard disk.”); U.S. Patent 4,872,064 at column 8, lines 15 to 17 (“More generally, Remote Storage 3 can be any non-volatile storage device including hard disk.”) Thus it is clear that at the time of filing, June 13, 1988, a skilled artisan would have understood that a hard disk is a non-volatile storage and therefore supports the limitation. Therefore, no new matter has been added by the amendments.

Patentee has canceled Claims 7 through 43 without prejudice. Claims 7 through 43 were added during reexamination in response to rejections presented by the previous examiner, Examiner Lanier. Since the previous rejections have been vacated, *sua sponte*, by the Office,

Patentee respectfully submits that the reasons for the addition of Claims 7 through 43 have been mooted. Therefore, in order to expedite the instant reexamination, Patentee has canceled those claims.

Patentee has added new Independent Claims 44 and 47 which mirror Claims 1 and 4 except that Claims 44 and 47 recite specifically that the second memory includes a second party hard disk and that the digital audio or digital video signals are stored on the second party “hard disk”, whereas Claims 1 and 4 recite that the digital audio or digital video signals are stored in a non-volatile storage portion of the second memory that is not a tape or CD. The “hard disk” is explicitly supported throughout the originally filed specification as, for example at page 4, lines 35 to 49, *et seq.* Patentee has also added new dependent Claims 45 and 46, which mirror original Claims 2 and 3, and new dependent Claims 48 and 49, which mirror original Claims 5 and 6. No new matter has been added.

III. THE CLAIMS OF THE ‘573 PATENT ARE ENTITLED TO THE JUNE 13, 1988 PRIORITY DATE AWARDED DURING THE INITIAL EXAMINATION

The Office asserts that the claims of the ‘573 Patent are not entitled to the June 13, 1988 priority date awarded during the original examination of the patent. As a basis for depriving the claims of the original priority date, the Office has asserted that the claims are not supported by an adequate written description and/or not enabled by the originally filed specification. The Office has used this assertion as a predicate to assign a later priority date to the claims and thereby introduce new references, i.e., *Yurt*, *Cohen* and *Goldwasser*, that do not qualify as prior art based on the proper June 13, 1988 priority date.

Patentee wishes to point out that the ‘573 Patent issued from an application that was a continuation of the parent application originally filed on June 13, 1988. The application was accorded the priority date of June 13, 1988 by the original Examiner (“Examiner Nguyen”)

based on a thorough examination, including amendments to the claims and specification during prosecution of the application. For the reasons set forth below, Patentee respectfully submits that the Office lacks authority in reexamination to revisit the issue of priority decided in an initial examination, especially where the facts, as in the present case, clearly show that the issue was dealt with in detail by the original examiner. Moreover, Patentee further respectfully submits that the claims, in fact, are adequately supported and enabled by the originally filed specification. As a result, the claims are entitled to the June 13, 1988 priority date, and *Yurt, Cohen* and *Goldwasser* are not available as prior art.

A. As a Matter of Law, the Office Lacks Jurisdiction in Reexaminations to Reassign Priority Dates for Originally Issued Claims in the Absence of a Previous Continuation-in-Part Application

Patentee respectfully submits that the Office lacks jurisdiction in reexamination proceedings, as a matter of law, to reassign priority dates to originally issued claims, where there is no continuation-in-part (“CIP”) application in the chain of prior applications.

1. Jurisdiction to Reassign Priority Dates Is Limited to Claim Limitations Added or Deleted in Reexamination and to Claims Relying on a Continuation-in-Part Application

Patentee respectfully submits that it is impermissible, in the context of a reexamination, to apply 35 U.S.C. § 120 to reassign priority dates for originally issued claims. It is well established that the primary determination under Section 120 is whether priority is claimed to an earlier application that “fulfills the requirements of Section 112, first paragraph.” *Callicrate v. Wadsworth Mfg.*, 427 F.3d 1361, 1373 (Fed. Cir. 2005) (citation omitted). It equally is well established, however, that the scope of a reexamination proceeding is limited to whether claims are patentable under 35 U.S.C. §§ 102 and 103 “on the basis of patents and printed publications.” 37 C.F.R. § 1.552. The reexamination rules explicitly preclude consideration of issues arising

under 35 U.S.C. § 112, except “with respect to subject matter added or deleted in the reexamination proceeding.” *Id.*; see *In also re Etter*, 756 F.2d 852, 856 (Fed. Cir. 1985) (en banc) (“only new or amended claims are also examined under 35 U.S.C. §§ 112 and 132”). Moreover, the inquiry under Section 120 as to whether the language of a particular claim, as filed or amended during an original prosecution, was supported or unsupported by sufficient disclosure is, by definition, not a *new* question. Rather, it is an issue that necessarily arises at the time of original filing or amendment, and one that necessarily is before the original examiner. It cannot, therefore, raise a “substantial new question of patentability in reexamination,” 35 U.S.C. § 303, because it is never a “new question” at all. Accordingly, Patentee respectfully submits that Section 120 cannot be used as a back door through which a reexamination proceeding may reach Section 112 issues for originally issued unamended claims.

The Office apparently relies on MPEP §§ 2258(I)(C) and 2217 for an implicit grant of authority to cite intervening art based upon a newly determined effective filing date for claims. Patentee respectfully submits, however, that a close reading of these MPEP Sections requires they properly be limited to situations where there was a continuation-in-part (“CIP”) application in the chain of applications leading to the patent under reexamination. In fact, both of the cases cited for support of MPEP §§ 2217 and 2258(I)(C), *In re Ruscetta*, 255 F.2d 687 (CCPA 1958) and *In re van Langenhoven*, 458 F.2d 132 (CCPA 1972), are cases involving CIPs. These cases thus should be read as limited to CIP applications, and their holdings are inapplicable to situations involving pure continuation or divisional applications. Moreover, since both cases predate the enactment by Congress of the reexamination statute, 35 U.S.C. §§ 301 et seq., the cases cannot be read to justify, in the special context of reexamination, something that would plainly be impermissible by an examiner in the context of an original examination.

2. The Jurisdiction of a Reexamination Examiner Cannot Exceed the Authority of an Original Examiner to Reassign Priority Dates

During an original examination, if disclosure has been added to a specification and an examiner believes claims in an application are unsupported by the specification as originally filed, the proper procedure is to object under 35 U.S.C. § 132 to any alleged new matter appearing in the specification, and reject the claims as unsupported under Section 112. *See* MPEP § 706.03(o). Thereafter, if the applicant does not overcome the objection and rejection, the applicant has the option of refiling the application as a CIP including a new oath or declaration in support of the new matter, with the rejected claims being relegated to the actual filing date of the CIP for prior art purposes. However, in the absence of a CIP an original examiner cannot simply elect to assign a later effective priority date to claims the examiner believes are unsupported by an original specification, and then proceed to cite intervening art based upon the newly determined date. Such a procedure would amount to creation of a “*de facto* CIP” by the original examiner, an undertaking plainly unsupported by statute, regulation, case law, or MPEP provision, or any other authority or precedent.

During reexamination, it is well established that the scope of the proceeding is limited, and is considerably narrower than the scope of the original examination. *See* 37 C.F.R. 1.552. Accordingly, it is undisputed that a reexamination examiner can have no greater authority than an original examiner. As a result, because an original examiner cannot create a “*de facto* CIP,” reassign priority dates, and reject claims over intervening prior art, it is clear that a reexamination examiner cannot do that either.

In the present case, no CIP was ever required by the original examiner or filed by the Applicant, and the original examiner therefore could not -- and did not -- reassign priority dates to the original claims. Patentee therefore respectfully submits that the present Examiner likewise

lacks authority -- and therefore jurisdiction -- to reassign priority dates to the pending unamended claims in reexamination that originally issued in the '573 Patent.

B. The Issue of Compliance with 35 U.S.C. § 112 was Considered and Passed on During the Original Examination Resulting in the '573 Patent and the Office Therefore Lacks Jurisdiction to Revisit the Same Issue in this Proceeding

Patentee respectfully submits that the Office further lacks jurisdiction under the facts in this proceeding to challenge the priority date of the unamended originally issued claims in reexamination, because the issue of those claims' entitlement to the filing date of the original application previously was considered and decided during the original examination of the '573 Patent.

1. The Issue of Compliance With 35 U.S.C. § 112 Was Considered and Passed On By the Original Examiner

The Office has asserted in the present Office Action that additional unsupported disclosure was added to the specification of the '573 Patent during its original prosecution. The Office has asserted further that the original examiner, Examiner Nguyen, did not consider or have reason to consider the issue of whether the additions to the specification constituted new matter. In support of these assertions, Examiner Foster has provided a helpful chart in the Office Action, showing when and under what circumstances additions to the specification and resulting claim amendments were made in the '573 Patent and its predecessor applications.

In order to demonstrate that Examiner Nguyen did in fact consider the various additions to the specification and concluded those additions did not constitute new matter and the subject claims therefore were supported under Section 112, Patentee has reproduced Examiner Foster's chart in amended form. The chart has been amended by adding three columns, subtitled

respectively “Consideration by Examiner Nguyen,” “Response by Applicant,” and “Subsequent Action by Examiner Nguyen.” That chart is set forth immediately below:

	Parent Application 07/206,497 filed June 13, 1988		Child Application 07/586,391 filed September 18, 1990		Office Action in Application 07/586,391 and response		Issuance of '573 Patent
Feature	Date First Appearing in Claims of Parent Application	Date First Appearing in Specification of Parent Application	Date First Appearing in Claims of Child Application	Date First Appearing in Specification of Child Application	Consideration by Examiner Nguyen	Response by Applicant	Subsequent Action by Examiner Nguyen
Transferring Money from Second Party to a First Party (Charging a Fee)	December 22, 1988 February 28, 1990			September 18, 1990	Considered in Office Action February 24, 1992	Objection/rejections specifically responded to in June 25, 1992 response	Claims allowed in September 21, 1992 Office Action
Providing a Credit Card Number	December 22, 1988			September 18, 1990	Considered in Office Action February 24, 1992	Objection/rejections specifically responded to in June 25, 1992 response	Claims allowed in September 21, 1992 Office Action
Controlling Use of First/Second Memory	December 22, 1988			September 18, 1990	Considered in Office Action February 24, 1992	Objection/rejections responded to in June 25, 1992 response	Claims allowed in September 21, 1992 Office Action
Transmitting to a Location Determined by Second Party	February 28, 1990			September 18, 1990	Considered in Office Action February 24, 1992	Objection/rejections responded to June 25, 1992	Claims allowed in September 21, 1992 Office Action
Specific Video Download Procedures	February 28, 1990			September 18, 1990	No new matter issues were ever raised	No response was ever necessary since no issue was ever raised	Claims allowed in September 21, 1992 Office Action
First Party in Possession of Transmitter	August 24, 1990 (not entered)			September 18, 1990	Considered in Office Action February 24, 1992	Objection/rejections responded to in June 25, 1992 response	Claims allowed in September 21, 1992 Office Action

Second Party in Possession of Receiver and Second Memory	August 24, 1990 (not entered)			September 18, 1990	Considered in Office Action February 24, 1992	Objection/rejections specifically responded to in June 25, 1992 response	Claims allowed in September 21, 1992 Office Action
--	-------------------------------	--	--	--------------------	---	--	--

The foregoing chart shows that, following submission of the subject additions to the specification and corresponding amendments to the claims, Examiner Nguyen considered those additions and amendments in the Office Action of February 24, 1992. That consideration included an objection to the specification as containing new matter under Section 132, and corresponding rejections of the relevant claims under Section 112. The Applicant responded to, and overcame, that objection and those rejections in the Response of June 25, 1992. In that Response, the Applicant included arguments and a Declaration under 37 CFR 1.132 establishing that the additions to the specification had ample antecedent support in the originally filed specification because the subject matter of the additions was implicitly disclosed and understood by those skilled in the art. After considering this Response by the Applicant, Examiner Nguyen withdrew the objection to the specification and the Section 112 rejections of the claims, and thereby determined the claims were allowable.

Patentee respectfully submits that the amended chart set forth above demonstrates indisputably that Examiner Nguyen did consider, or at least had every reason and opportunity to consider, the very same new matter and Section 112 rejections the Office has made in the present Office Action. Moreover, even though no objection or rejections were made by Examiner Nguyen concerning the additional “video feature” disclosure and claim elements, it is clear from the Examiner Nguyen’s overall thorough analysis of the other Section 132 and Section 112 issues that she similarly had every reason and opportunity to object to the “video feature” disclosure and reject those claims as well. She did not, however, do that. As a result, it is clear

Examiner Nguyen at least implicitly considered and passed on the “video feature” specification additions and claims as well, thereby allowing all of the pending claims to issue in the September 21, 1992 Office Action.

2. The Office Lacks Jurisdiction to Review Again the Same Section 112 Issues Determined by the Original Examiner

As established above, the question of Section 112 support, and hence the appropriate priority date for the claims in the issued ‘573 Patent, were considered and passed on by Examiner Nguyen in the original examination. The Patentee therefore respectfully submits that, as a matter of established law, the Office lacks jurisdiction under the facts in this proceeding to challenge again the Section 112 support and the 1988 priority date of the same claims in reexamination.

In *Patlex v. Quiqq*, 680 F.Supp. 33, (D.D.C. 1988), the United States District Court for the District of Columbia addressed a situation substantially identical to the circumstances of the present reexamination. In that case, the District Court reversed, on summary judgment, a decision by the BPAI upholding the final rejection of three claims in a reexamination proceeding. The claims in question had issued in a patent that resulted from a string of continuation and divisional applications relating back to an original priority application. The reexamination examiner took the position that the three claims were not entitled to the original priority date, and instead reassigned a later effective priority date, based on the reexamination examiner’s determination that the specification had not enabled the three claims under Section 112 as of the original filing date.

The District Court determined, however, that the issue of whether the three claims were enabled under Section 112 previously had been considered and decided by the original examiner,

and the Court therefore explicitly held that the reexamination examiner lacked jurisdiction to consider that issue again:

Entitlement to the ... [original priority] filing date was decided in the ... [original] examination. Plaintiffs contended then they were entitled to the [original priority] filing date, and the first Examiner considered then whether the [original] disclosure was enabling. Consequently, in order to reexamine ... [the patent] on the basis of whether the claims were anticipated by ... [later prior art], the reexamination examiner had to “reexamine” the question of whether the specification of the ... [original application] contained an enabling disclosure of the subject matter claimed in the ... [patent]. As noted above, however, the reexamination statute does not contemplate a “reexamination” of the sufficiency of a disclosure. Rather it is limited to reexamination of patentability based on prior art patents and publications. Hence, the Court concludes that the Examiner and the Board lack jurisdiction in this case to “reexamine” the sufficiency of the specification of the ... [original application].” Id. at 36. (Emphasis added)

The holding of the *Patlex* case, therefore, is clear. Where, as in the present case, an original examiner already has considered and determined the sufficiency of a specification’s disclosure under Section 112 and the resulting entitlement of claims to an original priority date, there is no “substantial new” question of patentability for reexamination, as required by 35 U.S.C. §§ 301, *et seq.* As a result, the Office lacks jurisdiction to “reexamine” that same issue for those same claims in a subsequent reexamination proceeding.

Patentee therefore respectfully requests that, for this reason as well, the Office withdraw the current Section 112 rejections and reassignment of later priority dates for the originally issued unamended claims.

C. In Any Event, the Claims as Issued in the ‘573 Patent Plainly Were Supported by the Originally Filed Specification

As previously described, the Office has asserted in the present Office Action, *inter-alia*, that the claims as originally issued in the ‘573 Patent rely for written description support on certain alleged new matter added to the specification during the original prosecution of the ‘573 Patent. The Office also has asserted that the claims directed to the video embodiment of the

invention are not supported by disclosure that was enabling as of the original June 13, 1988 filing date claimed by Patentee. As set forth above in Sections III(A) and (B) above, Patentee's position is that the Office lacks jurisdiction to review issues of adequate written description and enablement, especially where the particular issue was dealt with explicitly in the original prosecution of the patent in reexamination. Nonetheless, Patentee further respectfully traverses these rejections because, in any event, it is clear the originally filed specification in fact does provide both adequate written description for all of the issued claims and an enabling disclosure for those claims directed to the "video feature" of the invention.

1. The Claims as Issued in the '573 Patent are Supported by Adequate Written Description in the Originally Filed Specification

In the current Office Action, Examiner Foster provided a helpful chart showing alleged new matter added to the specification of the '573 Patent during prosecution. Patentee reproduced an amended version of the examiner's chart above in Section III(B)(1), thereby demonstrating that the alleged new matter was considered by Examiner Nguyen and was determined, in fact, not to be new matter. However, for the sake of thoroughness and to reinforce that Examiner Nguyen correctly determined the issues, Patentee provides below an analysis demonstrating that each element in Claims 1 through 6 as issued in the '573 Patent in fact was supported, either explicitly or implicitly, by the original specification filed on June 13, 1988.

i) The Proper Standard for Determining if the Claims are Adequately Supported by the Specification as Filed

As a preliminary matter, Patentee wishes to point out that the standard for written support in the absence of *ipsis verbis* recitation of a claim limitation is not strictly the inherency or required interpretation standard urged by the Office. Rather, the proper standard generally is

whether the written description reasonably conveys to the skilled artisan that the inventor was in possession of the claimed subject matter.

The issue of whether the written description requirement has been met is a question of fact, to be determined on a case-by-case basis. *Vas-Cath, Inc. v. Mahurkar*, 935 F.2d 1555, 1562 (Fed. Cir. 1991). The legal standard for determining whether the facts of a particular case meet the written description requirement is not in dispute, however. In *Vas-Cath*, the CAFC held that “[t]he test for sufficiency of support in a patent application is whether the disclosure of the application relied on ‘*reasonably conveys* to the skilled artisan that the inventor had possession at that time of the later claimed subject matter.’” *Vas-Cath* 935 F.2d at 1563 (emphasis added). As further held by the CAFC in *Union Oil Co. of Cal. v. Atlantic Richfield Co.*, 208 F.3d 989 (Fed. Cir. 2000), “[t]he written description does not require the applicant ‘to describe exactly the subject matter claimed, [instead] the description must clearly allow persons of ordinary skill in the art to recognize that [the inventor] invented what is claimed.’” *Union Oil*, 208 F.3d at 997.

Because the written description requirement is fact-based, various decision makers have at times appeared to drift from the “reasonably conveys” standard mandated by the CAFC. The CAFC, however, has never wavered from this standard. For example, in *Hyatt v. Boone*, 146 F.3d 1348 (Fed. Cir. 1998) the court reviewed a BPAI decision holding that one party to an interference (Hyatt) lacked the necessary written description in his originally filed application to support a later claim drawn to a count of the interference. The phraseology used by the BPAI in setting forth the standard for compliance with the written description requirement was that “the written description must be sufficient, when the entire specification is read that the ‘necessary and only reasonable construction’ that would be given it by a person of ordinary skill in the art is one that clearly supports each positive limitation in the count.” *Hyatt*, 146 F.3d at 1353. The

appellant argued that the “necessary and only reasonable construction” standard applied by the BPAI was different from and more rigorous than the “reasonably conveys standard” set forth in *Vas-Cath*.

The CAFC determined, however, that the different phraseology used by the BPAI in fact did not a set different standard for meeting the written description requirement. Rather, the standard remains that “the written description must include all of the limitations...or the applicant must show that any absent text is *necessarily comprehended* in the description provided and would have been so understood at the time the patent application was filed.” *Hyatt*, at 1354-55 (emphasis added). Moreover, the CAFC has on subsequent occasions repeatedly reinforced that the standard of *Vas-Cath* remains in effect. *See, e.g. Pandrol USA, LP v. Airboss Ry. Products, Inc.*, 424 F.3d 1161 (Fed. Cir. 2005)(“[t]he applicant must...convey with reasonable clarity to those skilled in the art that, as of the filing date sought, he or she was in possession of the invention.”). In contrast, the general standard does not require that the “only reasonable interpretation” of the general features in the specification be the more specific features in the claims. *Vas-Cath* at 1566 (“[t]he [district] court further erred in applying a legal standard that essentially required the drawings of the ‘081 design application to *necessarily exclude* all diameters other than those within the claimed range.”)(emphasis in original).

In addition to *Hyatt*, the Office has cited *In re Robertson*, 169 F.3d 734 (Fed. Cir. 1999) and *Lockwood v. American Airlines, Inc.*, 107 F.3d 1565 (Fed. Cir. 1997) as establishing a strict inherency standard for finding written support for a claim element not having *ipsis verbis* support in the specification. In the first instance, Patentee respectfully submits that the citation of *In Re Robertson* is inapposite. In *Robertson*, the CAFC reiterated the well known standard for determining anticipation or obviousness of a claim by prior art where the prior art does not

include literal disclosure of one or more elements of the claim. As such, *Robertson* was a case directed solely to Section 102/103 issues, and does not even mention Section 112. Moreover, nowhere in *Hyatt* or *Lockwood* does either court even allude to an inherency standard for showing support for claim limitations not described *ipsis verbis* in the specification. Rather, the CAFC simply held in *Lockwood* that “exact terms need not be used *in haec verba*..., the specification must contain an equivalent description of the claimed subject matter.” *Lockwood*, 107 F.3d at 1572 (citations omitted).

Patentee therefore respectfully submits that the requirement of an inherency standard under Section 112 is unsupported by *Hyatt*, *Robertson*, or *Lockwood*. Rather the proper standard to be applied by the Examiner in determining compliance with the written description requirement remains “whether the disclosure of the application as originally filed reasonably conveys to the artisan that the inventor had possession at that time of the later claimed subject matter, rather than the presence or absence of literal support in the specification for the claim language.” *In re Kaslow*, 707 F.2d 1366 (Fed. Cir. 1983).

ii) All Features of Claims 1 Through 6 in the ‘573 Patent Find Written Support in the Originally filed Specification

Applying the proper standard for compliance with the written description requirement under Section 112, Patentee respectfully submits that all of the limitations in Claims 1 through 6 of the ‘573 Patent were supported by the originally filed specification. To illustrate this point, Patentee has prepared a detailed chart showing each feature of the invention, the claims in which those features are recited, and where support in the originally filed specification is found for each feature. That chart is set forth immediately below:

Feature	Claims Reciting Feature	Written Description of Feature in Original Specification	Comments

A method for transmitting a desired digital audio signal	1	p. 1, lns. 7-9 p. 2, lns. 8-10, 20-26	<i>ipsis verbis</i> support
stored on a first memory of a first party to a second memory of a second party	1, 4	p. 3, lns. 35-40 p. 4, lns. 12-26	The specification states <i>ipsis verbis</i> that the hard disk in the control unit of the authorized agent is the source of the digital signal. Further, the specification states that the digital signal is transferred to the hard disk in the control unit of the user. A skilled artisan would understand this as transferring signals stored on a first memory to a second memory.
transferring money via a telecommunications line to a first party location remote from the second memory	1, 4	p. 1, lns. 13-15 p. 2, lns. 8-10, 20-23, 47-50 p. 3, lns. 20-33 Fig. 1	The specification discloses electronic sales via telephone lines. Because the agent is authorized to sell and to transfer via telephone lines, there is implicitly support for selling and thereby transferring money. This was previously pointed out in the declaration of Arthur Hair submitted May 5, 1992. A skilled artisan would readily understand this to comprehend transfers between two remote locations.
second party financially distinct from the first party	1, 4	p. 1, lns. 13-15 p. 2, lns. 8-10, 20-23, 47-50 p. 3, lns. 20-33	A skilled artisan would readily recognize that a sale requires the parties to be financially distinct. This was previously pointed out in the declaration of Arthur Hair submitted May 5, 1992.
second party controlling use and in possession of the second memory	1, 3	p. 3, lns. 26-33, 40-43	The as filed original specification includes <i>ipsis verbis</i> support for a second party control unit, where the user is the second party. A skilled artisan would readily recognize that the second memory is in possession and control of the second party, since the specification as originally filed states throughout that the user can store, sort and

			play thousands of songs from the user unit. A skilled artisan would clearly understand that this means the second party controls and possesses the second party control unit. This was previously pointed out in the declaration of Arthur Hair submitted May 5, 1992.
connecting electronically via a telecommunications line the first memory with the second memory	1, 4	p. 3, lns. 35-40	<i>ipsis verbis</i> support
transmitting the desired digital audio signal from the first memory with a transmitter in control and possession of the first party	1	p. 2, ln. 47-52 p. 3, lns. 35-40 Fig. 1	The as filed original specification has <i>ipsis verbis</i> support transmitting a desired digital audio signal and that the hard disk in the control unit of the authorized agent is the source. A skilled artisan would recognize that in order to regulate distribution of the signals the authorized agent would have to possess and control the transmitter. This was previously pointed out in the declaration of Arthur Hair submitted May 5, 1992.
to a receiver having the second memory at a location determined by the second party; said receiver in possession and control of the second party	1, 4	p. 2, lns. 47-50 p. 3, lns. 20-40 Fig. 1 p. 4, lns. 21-23	A skilled artisan would readily recognize in order to receive digital signals over telecommunications lines as disclosed throughout the specification, part of the second party control unit would act as a receiver. This was addressed previously in the affidavit of Arthur Hair dated May 5, 1992. A skilled artisan would also readily understand this to comprehend transfers between two remote locations. Since the second party possesses the second memory the second party can determine its location. This was addressed previously in the declaration

			of Arthur Hair submitted May 5, 1992.
storing the digital audio signal in the second memory	1	p. 2, lns. 23-27	<i>ipsis verbis</i> support
searching the first memory for the desired digital audio signal	2	p. 3, lns. 35-40 p. 4, lns. 12-28	The as filed original specification has <i>ipsis verbis</i> support for electronic sales and electronic transfer of digital signals from a control unit of an authorized agent to a control unit of a user. A skilled artisan would readily recognize that this would include searching the hard disk of the first party to locate desired digital signals for purchase.
selecting the desired digital audio signal from the first memory	2	p. 3, lns. 35-40 p. 4, lns. 12-28	The as filed original specification has <i>ipsis verbis</i> support for electronic sales and electronic transfer of digital signals from a control unit of an authorized agent to a control unit of a user. A skilled artisan would readily recognize that this would include selecting desired digital signals from the hard disk of the first party for purchase.
telephoning the first party controlling use of the first memory by the second party	3, 6	p. 2, lns. 47-50 p. 3, lns. 20-40 Fig. 1 p. 4, lns. 21-23	The original as filed specification states throughout that digital audio or digital video signals are sold and transferred via telephone lines. A skilled artisan would readily recognize this as comprehending the telephoning of the first party by the second party to initiate a transaction. This was addressed previously in the declaration of Arthur Hair submitted May 5, 1992.
providing a credit card number of the second party to the first party so that the second party is charged money	3, 6	p. 1, lns. 13-15 p. 2, lns. 8-10, 20-23, 38-52 p. 3, lns. 12-15, 35-37	The original as filed specification states throughout that the invention provides for electronic sales of digital audio or digital video

			signals. A skilled artisan would readily recognize credit card sales as being comprehended within electronic sales. This was addressed previously in the affidavit of Arthur Hair dated May 5, 1992.
first party controlling the first memory	3, 6	p. 2, lns. 38-43 p. 3, lns. 35-49	The as filed original specification includes <i>ipsis verbis</i> support for a first party control unit, where the authorized agent is the first party. A skilled artisan would readily recognize that the first party control unit is in possession and control of the first party because as an "agent authorized to electronically sell and distribute" digital audio or digital video, the first party would necessarily have to possess and control the source of the digital audio and digital video. This was previously pointed out in the declaration of Arthur Hair submitted May 5, 1992.
A method for transmitting a desired digital video signal	4	p. 5, lns. 36-43	<i>ipsis verbis</i> support
transmitting the desired digital video signal from the first memory with a transmitter in control and possession of the first party	4	p. 5, lns. 36-43 p. 2, ln. 47-52 p. 3, lns. 35-40 Fig. 1	The as filed original specification has <i>ipsis verbis</i> support transmitting a desired digital audio signal and that the hard disk in the control unit of the authorized agent is the source. A skilled artisan would recognize that in order to regulate distribution of the signals the authorized agent would have to possess and control the transmitter. This was previously pointed out in the declaration of Arthur Hair submitted May 5, 1992. A skilled artisan would recognize based on the disclosure at the end of the specification that this

			procedure could also be used for digital video.
storing the digital video signal in the second memory	4	p. 5, lns. 36-43 p. 2, lns. 23-27	The as filed original specification has <i>ipsis verbis</i> support for storing digital signals on the hard disk of the user control unit. A skilled artisan would recognize based on the disclosure at the end of the specification that this procedure could also be used for digital video.
searching the first memory for the desired digital video signal	5	p. 3, lns. 35-40 p. 4, lns. 12-28 p. 5, lns. 36-43	The as filed original specification has <i>ipsis verbis</i> support for electronic sales and electronic transfer of digital signals from a control unit of an authorized agent to a control unit of a user. A skilled artisan would readily recognize that this would include searching the hard disk of the first party to locate desired digital signals for purchase. A skilled artisan would recognize based on the disclosure at the end of the specification that this procedure could also be used for digital video.
selecting the desired digital video signal from the first memory	5	p. 3, lns. 35-40 p. 4, lns. 12-28 p. 5, lns. 36-43	The as filed original specification has <i>ipsis verbis</i> support for electronic sales and electronic transfer of digital signals from a control unit of an authorized agent to a control unit of a user. A skilled artisan would readily recognize that this would include selecting desired digital signals from the hard disk of the first party for purchase. A skilled artisan would recognize based on the disclosure at the end of the specification that this procedure could also be used for digital video.

For all the reasons set forth in the chart immediately above, Patentee respectfully submits that the written description standard was satisfied for originally issued Claims 1 through 6 of the '573 Patent.

2. The “Video Feature” of the Invention in Claims 4 Through 6 of the ‘573 Patent was Enabled by the Originally Filed Specification

The Office asserts the “video feature” of the invention in Claims 4 through 6 was not enabled by the disclosure in the originally filed specification. Patentee respectfully traverses this for the reasons set forth below.

The Office acknowledges the “original specification does contain a general statement at the end of the specification stating ‘[f]urther, it is intended that this invention not be limited to Digital Audio Music and can include Digital Video....’” The Office, however, generally asserts “this broad, generic statement fails to enable specifically claimed video download and processing procedures.” Office Action, page 12. Since the Office has not specifically identified which portions of the claims allegedly are not enabled, Patentee will discuss below the issue of enablement with respect to particular comments made in the Office Action.

Initially, Patentee respectfully submits that it appears the Office is attempting to apply a “mass production” standard to the claims when, in actuality, the enablement standard of Section 112 has no such requirement. As the CAFC held in *Christianson v. Colt Indus. Operating Corp.*, 822 F.2d 1544 (Fed. Cir. 1987) “the law has never required that a patentee ... must disclose in its patent the dimensions, tolerances, drawings, and other parameters of mass production not necessary to enable one skilled in the art to practice (as distinguished from mass-produce) the invention.” Nonetheless, it appears this kind of “mass production” information is exactly the kind of information the Office now seeks. For example, the Office Action states “[p]ersonal user

devices with the processing power capable of playing back much larger and more complicated digital video files, such as DVD players, were not routinely available until the late 1990(s).” Office Action, pages 19-20. (emphasis added.) Whether such devices “routinely” were available is not part of the test for enablement, nor is it one of the eight factors for reasonable experimentation that were laid out by the CAFC in *In re Wands*, 858 F.2d 731 (Fed. Cir. 1988). Rather, the only relevant test is whether, without undue experimentation, one of ordinary skill in the art could have made and used the claimed invention.

As further evidence that the Office seeks to apply a “mass production” standard, it is noted that the Office Action states “the digital bandwidth required to transmit a video signal at even VHS quality was around 1.5 megabits per second (approximately 30 megabytes in 3 minutes).” Office Action, page 14. (emphasis added.) However, while VHS quality may be appropriate for “mass production,” a limitation requiring VHS quality video is not included in any of the claims, and thus it is impermissible for the Office to use that level of quality as a benchmark for enablement. In fact, the recent success of very small screen video players shows that “mass production” can be achieved with even less than VHS quality.

Moreover, even if VHS quality were a requirement for enablement of the claims, there is no articulated basis to believe the original specification would not have enabled one of ordinary skill in the art to meet that quality for a short period of time. This fact is accentuated by the statement in the Office Action that “it is not clear ... how downloaded files of any appreciable or viable size would have been downloaded and stored on originally disclosed hard disk 60 of the user in the original specification.” Office Action, page 20. (emphasis added.) The use of “appreciable” and “viable” makes it clear that short videos are enabled, and nothing more is required. Moreover, the Office appears to acknowledge that even a 30 megabyte hard drive

could store a three-minute movie if encoded at 1.5 megabits/second. *Id.* That alone is sufficient to meet the enablement requirement.

Moreover, Patentee respectfully submits that the Office impermissibly limits the scope of what it referenced when the Office Action cites the size of available hard drives. While a 30 megabyte hard drive would have been available in a 3.5 inch form factor, the same chart relied on by the Office illustrates that hard drives larger than 1.89 gigabytes were available at the same time. See Exhibit “A” to this Response, which is a copy of the chart cited in footnote 14 of the Office Action.

The Office has applied the same “mass production” requirement to the library server. The Office initially seems to acknowledge that mainframes did exist which could have operated as repositories for copyrighted materials using hard disk drives. However, the Office then seems to discount the relevance of the existing mainframes by stating “it is not clear how even a small-sized video library ... would have been stored in the hard disk of the copyright holder ... without requiring details directed to a complex mainframe operating environment.” Patentee respectfully submits this unsupported statement on “complexity” is insufficient to prove that mainframe operating environments capable of storing digital video files were not already known at the time the original specification was filed, or that undue experimentation would have been required to store digital video files in such an environment. The statement also leaves unanswered how the Office is defining “small” -- according to the enablement standard under Section 112 or the improper “mass production” standard?

The Office Action further states “[r]egarding the transfer of these large video files over a network, the proliferation of broadband communication network[s] capable of delivering these large files to consumers, such as the Internet, simply did not exist or were not well known in

1988.” Office Action, pages 14-15. (emphasis added.) Such a statement raises at least two issues. First, “not well known” to whom? Those of ordinary skill in the art of computer systems knew of telephony-based wide area networks at the time the original specification was filed. See <http://www.rfc-editor.org/rfc-index.html> for a list of computer communications standards including those available at the time of filing. Second, utilization of a “broadband” network is not required. In fact, the originally filed specification discloses that the audio and video files can be transferred over telephone lines. While this may not be an extremely fast method of transfer, it nonetheless clearly is enabling under Section 112.

The Office further questions “how the digital video would have been coded and decoded during transmission, as digital video coding standards for purposes of transmission and file download were not settled in 1988. [T]he MPEG-1 standard which was designed to code/decode digital video information and to transmit the video via a telephone (telecommunications) network in NTSC (broadcast) quality for archiving, was only established in 1992.” Office Action, page 21. (emphasis added.) Again, Patentee respectfully notes that standardization of video coding and the use of “NTSC quality” relate to “mass production” rather than enablement under Section 112. Thus, the Office has not alleged -- and cannot allege -- that one of ordinary skill in the art could not have coded video at some other resolution or using some other encoding technique at the time the original specification was filed.

Accordingly, Patentee respectfully submits that Claims 4 through 6 directed to the “video feature” embodiment of the invention were enabled by the originally filed specification under the proper standard for Section 112 enablement.

D. Because the Originally Issued Claims of the ‘573 Patent are Entitled to the June 13, 1988 Priority Date Awarded During the Original Examination, the References *Yurt, Cohen* and *Goldwasser* are not Appropriate Prior Art

Based on the foregoing, Patentee respectfully submits that originally issued Claims 1 through 6 of the '573 Patent are entitled to the June 13, 1988 priority date. In the first instance, it is improper for the Office to reconsider the issue of priority in the present reexamination for the reasons set forth in Sections III(A) and (B) above. Further, even if it were proper to reconsider the issue of priority, Patentee respectfully submits the facts of record clearly show the claims were described adequately and enabled by the originally filed specification for the reasons set forth in Section III(C) above. Patentee therefore respectfully submits that the references *Yurt*, *Cohen* and *Goldwasser* are not appropriate prior art because all of these references post-date the applicable June 13, 1988 priority date of the claims. Patentee therefore respectfully requests that all rejections based on these references be withdrawn.

IV. THE AMENDED AND NEW CLAIMS ARE NEITHER ANTICIPATED BY, NOR OBVIOUS OVER, THE APPROPRIATE PRIOR ART OF RECORD

Claims 1 through 6 have been rejected as either anticipated by or obvious over several references that antedate the proper June 13, 1988 priority date of the claims, and one reference that post-dates the proper June 13, 1988 priority date. Specifically:

Claims 1 through 6 are rejected under 35 U.S.C. § 102(b) as anticipated by U.S. Patent No. 4,789,863 to Bush (*Bush*);

Claims 1, 2, 4 and 5 are rejected under 35 U.S.C. § 102(e) as anticipated by U.S. Patent No. 4,949,187 to Cohen (*Cohen*);

Claims 3 and 6 are rejected under 35 U.S.C. § 103 as obvious over *Cohen* in view of *Bush*;

Claims 1 through 6 are rejected under 35 U.S.C. § 103 as obvious over Japanese Published Application No. 62-284496 to Akashi (*Akashi*) in view of U.S. Patent No. 4,528,643 to Freeny (*Freeny*).

Patentee has amended Claims 1 and 4 to specify that the digital audio or digital video signals are stored in a non-volatile storage portion of the second memory, wherein the non-volatile storage portion is not a tape or CD. Patentee also has added new Claims 44 and 47 to specify that the second memory includes a hard disk and that the digital audio or digital video signals are stored in the second party hard disk. As a result, Patentee respectfully submits that none of the appropriate prior art of record, either alone or in combination, shows, suggests or teaches each and every limitation of independent Claims 1, 4, 44, and 47. By extension, none of the appropriate prior art, either alone or in combination, shows, suggests or teaches each and every limitation of dependent Claims 2, 3, 5, 6, 45, 46, 48 or 49.

A. The Rejections Based on *Cohen* are Improper and Should be Withdrawn

As demonstrated above in Section III, Claims 1 through 6 of the '573 Patent as issued were entitled to the June 13, 1988 priority filing date of the original application. Further, as shown above in Section II, the added recitations of "wherein the second memory comprises a non-volatile storage that is not a tape or CD" and "wherein the second memory comprises a hard disk" are both supported in the original specification filed June 13, 1988. As a result, amended Claims 1 and 4, new Claims 44 and 47, and all of their respective dependent claims are entitled to the June 13, 1988 priority date. *Cohen* therefore is not appropriate prior art against these claims for the purposes of 35 U.S.C. §§ 102 and 103. Patentee therefore respectfully submits that the rejections based on *Cohen* alone, and *Cohen* in combination with *Bush*, cannot be sustained and should be withdrawn.

B. None of *Bush*, *Akashi*, *Freeny* or Their Combination Shows, Suggests or Teaches Each and Every Limitation of Claims 1 Through 6, 44 or 45

As described above, amended Claims 1 and 4 recite the limitation, storing the digital audio or digital video signal in a non-volatile storage portion of the second memory, wherein the

non-volatile storage is not a tape or CD. Patentee respectfully submits that none of *Bush*, *Akashi* or *Freeny*, either alone or in combination, shows, suggests or teaches this feature. In fact, it is apparent that all of these references teach away from this feature. Further, new Claims 44 and 47 state that the second memory includes a second party hard disk and that the digital audio or digital video signals are stored in the second party hard disk. It similarly is clear that none of *Bush*, *Akashi* or *Freeny*, either alone or in combination, shows, suggests or teaches this feature, and that all of the references teach away from it.

In particular, *Bush* discloses a system whereby a user can receive selected pre-recorded entertainment over cable lines. *Bush*, col. 1, lns. 46-48. The pre-recorded entertainment includes audio and video selections that are stored at a control source in CD format. *Bush*, col. 2, lns. 30-34. According to the disclosure of *Bush*, the audio or video selection received by the user must be recorded on a cassette tape. *Bush*, col. 4, lns. 7-58. *Bush* also discloses that a CD may be used to record the audio or video entertainment. *Bush*, col. 5, lns. 24-29.

Akashi discloses a system whereby a user can select and download audio signals and record them to a tape or CD. *Akashi*, translation page 2, (6) Embodiment. Specifically, *Akashi* states, “[t]he record reproducing apparatus 1 may either be a digital audio tape recorder or a compact disk deck that employs a write-once, read-many recordable optical disk that allows data to be read immediately after the data is written.” *Id.*

Freeny discloses a kiosk system wherein audio and/or video signals are stored on a storage medium at a point of sale location. See *Freeny*, Abstract. The main teaching of *Freeny* is the reproduction of information, for example audio or video, in the form of a tangible object, such as a cassette tape or video disk. *Freeny*, col. 4, lns. 36-55.

It is clear all of the foregoing references expressly require that audio or video signals be transferred from a first memory to a second memory that is a CD or tape. Thus, all of the references recognized the same problem in the prior art -- the inherent disadvantages in centrally producing CD's, tapes, and other fixed media at a remote manufacturing location and then distributing those objects for sale to ultimate consumers via traditional "brick and mortar" wholesale and retail distribution channels. However, all of these references failed to recognize, and therefore stopped short of, the ultimate and superior solution to the prior art problems provided by the invention of the '573 Patent -- the elimination of the need to produce CD's, tapes, or other fixed media objects at the second party's location. Thus, where the cited references still required the production of CD's and tapes at the second party's location, with all of the attendant localized problems of production, physical storage, and risk of damage, the invention of the '573 Patent solved these problems by providing storage in a non-volatile storage permitting repetitive playback of audio and video without requiring the second party to make, handle, physically store, or otherwise deal with CD's or tapes.

As a result, Patentee respectfully submits that none of the above references, either alone or in combination, shows, suggests, or teaches transferring audio or video signals from a first memory to a second memory wherein the signals are stored in a non-volatile storage portion of the second memory that is not a tape or CD and/or which is a hard disk. To the contrary, all of the references expressly teach away from this invention by requiring that the digital audio or digital video signals be transferred to a CD or tape in the second memory, while failing to recognize or deal with the problems and disadvantages associated with CD's and tapes. It therefore follows that none of these references, either alone or in combination, teaches storing digital audio or video signals in a portion of a memory that is a non-volatile storage and is not a

CD or tape, or which is a hard disk. Patentee therefore respectfully submits that none of the above references, or their combination, shows, suggests or teaches each and every limitation of Claims 1, 4, 44 or 47. As a result, none of Claims 1, 4, 44 and 47, or their dependent claims, can be anticipated by or obvious over *Bush, Akashi, Freeny*, or their combination.

Respectfully submitted,

DRINKER BIDDLE & REATH LLP



Robert A. Koons, Jr.
Registration No. 32,474

DRINKER BIDDLE & REATH LLP
One Logan Square
18th & Cherry Streets
Philadelphia, PA 19103-6996
Telephone: (215) 988-3392
Facsimile: (215) 988-2757

CERTIFICATE OF SERVICE

The undersigned hereby certifies that a true and correct copy of the foregoing Statement Under 37 C.F.R. §1.560(b) in Reexamination No. 90/007,402 was served via First Class United States Mail, postage prepaid, this 1ST day of December, 2006, on the following:

Mr. Albert S. Penilla
Martine, Penilla, & Gencarella, LLP
710 Lakeway Drive, Suite 200
Sunnyvale, CA 94085
Attorney for Third Party Reexamination Requester

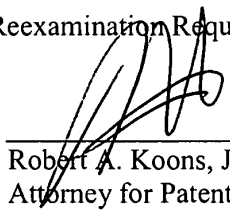
By: 
Robert A. Koons, Jr.
Attorney for Patentee

CERTIFICATE OF MAILING BY "EXPRESS MAIL" (37 CFR 1.10)Applicant(s): **Arthur R. Hair**

Docket No.

219099 (NAPS001)Application No.
90/007,402Filing Date
01/31/2005Examiner
Roland G. FosterCustomer No.
23973

Group Art Unit

Invention: **Method for Transmitting a Desired Digital Video or Digital Audio Signals****392 .70181 U.S. PTO**

I hereby certify that the following correspondence:

Statement Under 37 C.F.R. 1.560(b) w/chart attachments, Post Card.*(Identify type of correspondence)*

is being deposited with the United States Postal Service "Express Mail Post Office to Addressee" service under 37 CFR 1.10 in an envelope addressed to: Commissioner for Patents, P.O. Box 1450, Alexandria, VA 22313-1450 on

December 1, 2006*(Date)***Lorraine T. Lewis***(Typed or Printed Name of Person Mailing Correspondence)**(Signature of Person Mailing Correspondence)***EV592625220US***("Express Mail" Mailing Label Number)***Note: Each paper must have its own certificate of mailing.**DRINKER BIDDLE & REATH LLP
One Logan Square
18th & Cherry Streets
Philadelphia, PA 19103-6996
Telephone (215) 988-3392
Facsimile: (215) 988-2757

IN THE UNITED STATES PATENT AND TRADEMARK OFFICE

In re Application of:)	
)	
ARTHUR R. HAIR)	
)	
Reexamination Control No. 90/007,402)	
)	
Reexamination Filed: January 31, 2005)	METHOD FOR TRANSMITTING
)	A DESIRED DIGITAL VIDEO OR
Patent Number: 5,191,573)	AUDIO SIGNAL
)	
Examiner: Roland G. Foster)	

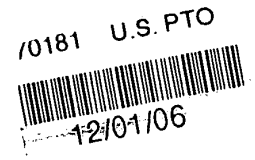

Mail Stop *Ex Parte* Reexamination
 Commissioner for Patents
 P.O. Box 1450
 Alexandria, VA 22313-1450

Sir:

STATEMENT UNDER 37 C.F.R. §1.560(b)

At the Interview with Examiners Foster, Weaver, Laballe, and Supervisory Examiner Kashnikow on November 16, 2006 in Reexamination Control Nos. 90/007,402; 90/007,403; and 90/007,407, Patentee's counsel presented the following reasons as warranting favorable action in the pending Reexamination applications:

1. The rejections of the pending claims in all three Reexaminations under Section 112 are improper and should be withdrawn because, as a matter of law, the Office is without jurisdiction to consider whether originally issued claims meet the requirements of Section 112, first paragraph.
2. The rejections of the pending claims in all three Reexaminations under Section 112 also should be withdrawn because where, as here, the original examiner considered whether

the originally issued claims in the patents in Reexamination met the requirements of Section 112, first paragraph, the Office is without jurisdiction in these three Reexaminations to consider again those same issues for those same claims under Section 112, first paragraph. Patentee's counsel presented a chart showing the manner in which the original examiner considered and passed on the issue of the originally issued claims meeting the requirements of Section 112, first paragraph. That chart is attached hereto.

3. Although the Office is without jurisdiction to consider the issue of whether the originally issued claims in all three Reexaminations meet the requirements of Section 112, first paragraph, it is clear that, in fact, those claims do meet the requirements of Section 112, first paragraph, because they find written support and are enabled by the original specification as it was filed on June 13, 1988. Patentee's counsel presented charts for all three patents in Reexamination, showing where support for all of the limitations in the originally issued claims find support in the original specification as filed on June 13, 1988. Those charts also are attached hereto.
4. Since all of the claims in the three Reexaminations properly are supported under Section 112 by the original specification as filed on June 13, 1988, those claims are entitled to June 13, 1988 as their priority date.
5. Since all of the claims in the three Reexaminations are entitled to a June 13, 1988 priority date, certain of the references cited by the Office in the pending Office Actions, i.e., United States Patent No. 5,241,421 to *Goldwasser*; United States Patent No. 5,132,992 to *Yurt*, and United States Patent No. 4,999,187 to *Cohen*, are inapplicable and not available

as prior art to the pending claims, because all three references postdate the June 13, 1988 priority date of those claims.

6. All of the other references cited by the Office in the pending Office Actions which antedate the June 13, 1988 priority date of the claims require that audio or digital signals be downloaded from a first memory to a second memory that requires a CD or tape. Patentees have amended the pending claims to make it clear those claims do not require the second memory be a CD or a tape and, as a result, those claims are not obvious over any of the pre-June 13, 1988 references, either alone or in combination.

Respectfully submitted,

DRINKER BIDDLE & REATH LLP

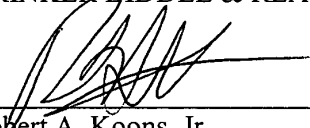

Robert A. Koons, Jr.
Registration No. 32,474

December 1, 2006

DRINKER BIDDLE & REATH LLP
One Logan Square
18th & Cherry Streets
Philadelphia, PA 19103-6996
Telephone: (215) 988-3392
Facsimile: (215) 988-2757

	Parent Application 07/206,497 filed June 13, 1988		Child Application 07/586,391 filed September 18, 1990		Office Action in Application 07/586,391 and response		Issuance of '573 Patent
Feature	Date First Appearing in Claims of Parent Application	Date First Appearing in Specification of Parent Application	Date First Appearing in Claims of Child Application	Date First Appearing in Specification of Child Application	Consideration by Examiner Nguyen	Response by Applicant	Subsequent Action by Examiner Nguyen
Transferring Money from Second Party to a First Party (Charging a Fee)	December 22, 1988 February 28, 1990			September 18, 1990	Considered in Office Action February 24, 1992	Objection specifically responded to in June 25, 1992 response	Claims allowed in September 21, 1992 Office Action
Providing a Credit Card Number	December 22, 1988			September 18, 1990	Considered in Office Action February 24, 1992	Objection specifically responded to in June 25, 1992 response	Claims allowed in September 21, 1992 Office Action
Controlling Use of First/Second Memory	December 22, 1988			September 18, 1990	Considered in Office Action February 24, 1992	Objections responded to in June 25, 1992 response	Claims allowed in September 21, 1992 Office Action
Transmitting to a Location Determined by Second Party	February 28, 1990			September 18, 1990	Considered in Office Action February 24, 1992	Objection responded to June 25, 1992	Claims allowed in September 21, 1992 Office Action
Specific Video Download Procedures	February 28, 1990			September 18, 1990	No new matter issues were ever raised	No response was ever necessary since no issue was ever raised	Claims allowed in September 21, 1992 Office Action
First Party in Possession of Transmitter	August 24, 1990 (not entered)			September 18, 1990	Considered in Office Action February 24, 1992	Objections responded to in June 25, 1992 response	Claims allowed in September 21, 1992 Office Action

Second Party in Possession of Receiver and Second Memory	August 24, 1990 (not entered)			September 18, 1990	Considered in Office Action February 24, 1992	Objection specifically responded to in June 25, 1992 response	Claims allowed in September 21, 1992 Office Action
--	-------------------------------	--	--	--------------------	---	---	--

Claim Features of '573 Patent

Feature	Claims Reciting Feature	Written Description of Feature in Original Specification	Comments
A method for transmitting a desired digital audio signal	1	p. 1, Ins. 7-9 p. 2, Ins. 8-10, 20-26	<i>ipsis verbis</i>
stored on a first memory of a first party to a second memory of a second party	1, 4	p. 3, Ins. 35-40 p. 4, Ins. 12-26	The specification states <i>ipsis verbis</i> that the hard disk in the control unit of the authorized agent is the source of the digital signal. Further, the specification states that the digital signal is transferred to the hard disk in the control unit of the user. A skilled artisan would understand this as transferring signals stored on a first memory to a second memory.
transferring money via a telecommunications line to a first party location remote from the second memory	1, 4	p. 1, Ins. 13-15 p. 2, Ins. 8-10, 20-23, 47-50 p. 3, Ins. 20-33 Fig. 1	The specification discloses electronic sales via telephone lines. Because the agent is authorized to sell and to transfer via telephone lines, there is implicitly support for selling and thereby transferring money. This was previously pointed out in the declaration of Arthur Hair submitted May 5, 1992. A skilled artisan would readily understand this to comprehend transfers between two remote locations.

second party financially distinct from the first party	1, 4	p. 1, Ins. 13-15 p. 2, Ins. 8-10, 20-23, 47-50 p. 3, Ins. 20-33	A skilled artisan would readily recognize that a sale requires the parties to be financially distinct. This was previously pointed out in the declaration of Arthur Hair submitted May 5, 1992.
second party controlling use and in possession of the second memory	1, 3	p. 3, Ins. 26-33, 40-43	The as filed original specification includes <i>ipsis verbis</i> support for a second party control unit, where the user is the second party. A skilled artisan would readily recognize that the second memory is in possession and control of the second party, since the specification as originally filed states throughout that the user can store, sort and play thousands of songs from the user unit. A skilled artisan would clearly understand that this means the second party controls and possesses the second party control unit. This was previously pointed out in the declaration of Arthur Hair submitted May 5, 1992.
connecting electronically via a telecommunications line the first memory with the second memory	1, 4	p. 3, Ins. 35-40	<i>ipsis verbis</i>

<p>transmitting the desired digital audio signal from the first memory with a transmitter in control and possession of the first party</p>	<p>1</p>	<p>p. 2, ln. 47-52 p. 3, lns. 35-40 Fig. 1</p>	<p>The as filed original specification has <i>ipsis verbis</i> support transmitting a desired digital audio signal and that the hard disk in the control unit of the authorized agent is the source. A skilled artisan would recognize that in order to regulate distribution of the signals the authorized agent would have to possess and control the transmitter. This was previously pointed out in the declaration of Arthur Hair submitted May 5, 1992.</p>
<p>to a receiver having the second memory at a location determined by the second party; said receiver in possession and control of the second party</p>	<p>1, 4</p>	<p>p. 2, lns. 47-50 p. 3, lns. 20-40 Fig. 1 p. 4, lns. 21-23</p>	<p>A skilled artisan would readily recognize in order to receive digital signals over telecommunications lines as disclosed throughout the specification, part of the second party control unit would act as a receiver. This was addressed previously in the affidavit of Arthur Hair dated May 5, 1992. A skilled artisan would also readily understand this to comprehend transfers between two remote locations. Since the second party possesses the second memory the second party can determine its location. This was addressed previously in the declaration of Arthur Hair submitted May 5, 1992.</p>

storing the digital audio signal in the second memory	1	p. 2, Ins. 23-27	<i>ipsis verbis</i>
searching the first memory for the desired digital audio signal	2	p. 3, Ins. 35-40 p. 4, Ins. 12-28	The as filed original specification has <i>ipsis verbis</i> support for electronic sales and electronic transfer of digital signals from a control unit of an authorized agent to a control unit of a user. A skilled artisan would readily recognize that this would include searching the hard disk of the first party to locate desired digital signals for purchase.
selecting the desired digital audio signal from the first memory	2	p. 3, Ins. 35-40 p. 4, Ins. 12-28	The as filed original specification has <i>ipsis verbis</i> support for electronic sales and electronic transfer of digital signals from a control unit of an authorized agent to a control unit of a user. A skilled artisan would readily recognize that this would include selecting desired digital signals from the hard disk of the first party for purchase.

<p>telephoning the first party controlling use of the first memory by the second party</p>	<p>3, 6</p>	<p>p. 2, Ins. 47-50 p. 3, Ins. 20-40 Fig. 1 p. 4, Ins. 21-23</p>	<p>The original as filed specification states throughout that digital audio or digital video signals are sold and transferred via telephone lines. A skilled artisan would readily recognize this as comprehending the telephoning of the first party by the second party to initiate a transaction. This was addressed previously in the declaration of Arthur Hair submitted May 5, 1992.</p>
<p>providing a credit card number of the second party to the first party so that the second party is charged money</p>	<p>3, 6</p>	<p>p. 1, Ins. 13-15 p. 2, Ins. 8-10, 20-23, 38-52 p. 3, Ins. 12-15, 35-37</p>	<p>The original as filed specification states throughout that the invention provides for electronic sales of digital audio or digital video signals. A skilled artisan would readily recognize credit card sales as being comprehended within electronic sales. This was addressed previously in the affidavit of Arthur Hair dated May 5, 1992.</p>

<p>first party controlling the first memory</p>	<p>3, 6</p>	<p>p. 2, Ins. 38-43 p. 3, Ins. 35-49</p>	<p>The as filed original specification includes <i>ipsis verbis</i> support for a first party control unit, where the authorized agent is the first party. A skilled artisan would readily recognize that the first party control unit is in possession and control of the first party because as an "agent authorized to electronically sell and distribute" digital audio or digital video, the first party would necessarily have to possess and control the source of the digital audio and digital video. This was previously pointed out in the declaration of Arthur Hair submitted May 5, 1992.</p>
<p>A method for transmitting a desired digital video signal</p>	<p>4</p>	<p>p. 5, Ins. 36-43</p>	<p><i>ipsis verbis</i></p>

<p>transmitting the desired digital video signal from the first memory with a transmitter in control and possession of the first party</p>	<p>4</p>	<p>p. 5, Ins. 36-43 p. 2, In. 47-52 p. 3, Ins. 35-40 Fig. 1</p>	<p>The as filed original specification has <i>ipsis verbis</i> support transmitting a desired digital audio signal and that the hard disk in the control unit of the authorized agent is the source. A skilled artisan would recognize that in order to regulate distribution of the signals the authorized agent would have to possess and control the transmitter. This was previously pointed out in the declaration of Arthur Hair submitted May 5, 1992. A skilled artisan would recognize based on the disclosure at the end of the specification that this procedure could also be used for digital video.</p>
<p>storing the digital video signal in the second memory</p>	<p>4</p>	<p>p. 5, Ins. 36-43 p. 2, Ins. 23-27</p>	<p>The as filed original specification has <i>ipsis verbis</i> support for storing digital signals on the hard disk of the user control unit. A skilled artisan would recognize based on the disclosure at the end of the specification that this procedure could also be used for digital video.</p>

<p>searching the first memory for the desired digital video signal</p>	<p>5</p>	<p>p. 3, Ins. 35-40 p. 4, Ins. 12-28 p. 5, Ins. 36-43</p>	<p>The as filed original specification has <i>ipsis verbis</i> support for electronic sales and electronic transfer of digital signals from a control unit of an authorized agent to a control unit of a user. A skilled artisan would readily recognize that this would include searching the hard disk of the first party to locate desired digital signals for purchase. A skilled artisan would recognize based on the disclosure at the end of the specification that this procedure could also be used for digital video.</p>
<p>selecting the desired digital video signal from the first memory</p>	<p>5</p>	<p>p. 3, Ins. 35-40 p. 4, Ins. 12-28 p. 5, Ins. 36-43</p>	<p>The as filed original specification has <i>ipsis verbis</i> support for electronic sales and electronic transfer of digital signals from a control unit of an authorized agent to a control unit of a user. A skilled artisan would readily recognize that this would include selecting desired digital signals from the hard disk of the first party for purchase. A skilled artisan would recognize based on the disclosure at the end of the specification that this procedure could also be used for digital video.</p>

Claim Features of '734 Patent

Feature	Claims Reciting Feature	Written Description of Feature in Original Specification	Comments
A method/system for transferring desired digital video or digital audio signals	1-34	p. 1, Ins. 7-9 p. 2, Ins. 8-10, 20-26 (video) p. 5, Ins. 36-43	<i>ipsis verbis</i>
forming a connection through telecommunications lines between a first memory of a first party and a second memory of a second party	1	p. 3, Ins. 35-40	<i>ipsis verbis</i>
first party location and second party location remote from the first party location, the second party location determined by the second party	1, 4, 11, 16, 19, 26	p. 2, Ins. 47-50 p. 3, Ins. 20-40 Fig. 1 p. 4, Ins. 21-23	The original as filed specification states throughout that digital audio or digital video signals are sold and transferred via telephone lines. A skilled artisan would readily understand this to comprehend transfers between two remote locations. Since the digital audio or digital video signals are transferred to the user's (second party's) control unit, a skilled artisan would readily understand that the second party can determine the second location.
the first party memory having a first party hard disk having a plurality of digital video or digital audio signals, including coded digital video or digital audio signals	1, 4, 16	p. 3, Ins. 35-37	<i>ipsis verbis</i>

the first memory having a sales random access memory chip	1	p. 3, lns. 19-24 Fig. 1	<i>ipsis verbis</i>
telephoning the first party controlling the first memory by the second party Possibly Amend to: "establishing telephone communications between the first memory and the second memory"	1	p. 2, lns. 47-50 p. 3, lns. 20-40 Fig. 1 p. 4, lns. 21-23	The original as filed specification states throughout that digital audio or digital video signals are sold and transferred via telephone lines. A skilled artisan would readily recognize this as comprehending the telephoning of the first party by the second party to initiate a transaction. This was addressed previously in the declaration of Arthur Hair submitted May 5, 1992.
providing a credit card number of the second party to the first party so that the second party is charged money	1	p. 1, lns. 13-15 p. 2, lns. 8-10, 20-23, 38-52 p. 3, lns. 12-15, 35-37	The original as filed specification states throughout that the invention provides for electronic sales of digital audio or digital video signals. A skilled artisan would readily recognize credit card sales as being comprehended within electronic sales. This was addressed previously in the affidavit of Arthur Hair dated May 5, 1992.
electronically coding the digital video or digital audio signals to form coded digital audio signals into a configuration that would prevent unauthorized reproduction	1	p. 2, lns. 17-19 p. 4, lns. 15-20	<i>ipsis verbis</i>

storing a replica of the coded desired digital video or digital audio signals from the hard disk to the sales random access memory chip	1	p. 4, Ins. 15-23	<i>ipsis verbis</i>
transferring the stored replica of the coded desired digital video or digital audio signal from the sales random access memory chip of the first party to the second memory of the second party through telecommunications lines while the second memory is in possession and control of the second party	1, 4	p. 4, Ins. 15-23 p. 4, ln. 35 to p. 5, ln. 21	The original as filed specification includes <i>ipsis verbis</i> support for storing a replica of the coded desired digital audio or digital video signal to the first party sales random access memory, then transferring it to the memory of the second party. A skilled artisan would readily recognize that the second memory is in possession and control of the second party, since the specification as originally filed states throughout that the user can store, sort and play thousands of songs from the user unit. A skilled artisan would clearly understand that this means the second party controls and possesses the second memory. This was previously addressed in the declaration of Arthur Hair filed May 5, 1992.
storing the transferred digital video or digital audio signals in the second memory	1	p. 2, Ins. 23-27	<i>ipsis verbis</i>

a second party integrated circuit which controls and executes commands of the second party connected to a second party control panel	2	p. 3, lns. 26-28 p. 4, lns. 15-20 Fig. 1	<i>ipsis verbis</i>
commanding the second party integrated circuit with the second party control panel to initiate the purchase of the desired digital video or digital audio signals from the first party hard disk	2	p. 4, lns. 12-20	(CANCEL)
the second memory includes a second party hard disk and an incoming random access memory chip	3, 5, 8, 13, 16, 21, 30	p. 3, lns. 26-31 Fig. 1	<i>ipsis verbis</i>
the second memory includes a playback random access memory chip	3, 5, 16, 21, 30	p. 3, lns. 26-30 p. 4, lns. 39-50 Fig. 1	<i>ipsis verbis</i>
playing the desired digital video or digital audio signal from the second party hard disk	3	p. 2, lns. 26-32	<i>ipsis verbis</i>

<p>a first party control unit (in possession and control of the first party)</p>	<p>4, 11, 16, 19, 26, 28</p>	<p>p. 2, Ins. 38-43 p. 3, Ins. 35-49</p>	<p>The as filed original specification includes <i>ipsis verbis</i> support for a first party control unit, where the authorized agent is the first party. A skilled artisan would readily recognize that the first party control unit is in possession and control of the first party because as an "agent authorized to electronically sell and distribute" digital audio or digital video, the first party would necessarily have to possess and control the source of the digital audio and digital video.</p>
--	------------------------------	--	--

<p>a second party control unit (in possession and control of the second party)</p>	<p>4, 11, 16, 19, 26, 28</p>	<p>p. 2, lns. 38-43 p. 3, lns. 35-49</p>	<p>The as filed original specification includes <i>ipsis verbis</i> support for a second party control unit, where the user is the second party. A skilled artisan would readily recognize that the second memory is in possession and control of the second party, since the specification as originally filed states throughout that the user can store, sort and play thousands of songs from the user unit. A skilled artisan would clearly understand that this means the second party controls and possesses the second party control unit. This was previously addressed in the declaration of Arthur Hair filed May 5, 1992.</p>
--	------------------------------	--	--

the first party control unit has a first party hard disk, a sales random access memory chip, and means or mechanism for electronically selling desired digital video or digital audio signals	4, 11, 19, 26, 28	p. 2, Ins. 8-10 p. 3, Ins. 20-40 Fig. 1	The as filed original specification has <i>ipsis verbis</i> support for a first party control unit with a hard disk, and sales random access memory chip. A skilled artisan would readily recognize that the first party control unit would include a means or mechanism for executing an electronic sale because the electronic sale is described in the original specification as separate from electronic transfer and electronic distribution.
the second party control unit has a second memory connected to the second party control panel	4, 19, 21, 26, 28	p. 3, Ins. 26-31 Fig. 1	The as filed original specification has <i>ipsis verbis</i> support for a control panel connected to the second party control unit. A skilled artisan would readily understand that the second party hard disk corresponds to a second memory.
the second party control unit has means for playing desired digital video or digital audio signals connected to and controlled by the second party control panel	4, 28	p. 3, Ins. 26-33 Fig. 1	<i>ipsis verbis</i>
selling digital video or digital audio signals through telecommunications lines	4	p. 2, Ins. 8-10, Ins. 47-50	<i>ipsis verbis</i>

the first party control unit includes a first party control integrated circuit connected to the first party hard disk, the sales random access memory and the second party control panel through telecommunications lines	4, 6, 11, 16, 19, 22, 26, 28, 31,	p. 3, lns. 20-33 Fig. 1	<i>ipsis verbis</i>
the first party control unit includes a first party control panel connected to and through which the first party control integrated circuit is programmed	6, 11, 16, 22, 31	p. 3, lns. 20-24 p. 4, lns. 12-14 Fig. 1	<i>ipsis verbis</i>
the second party control unit includes a second party control integrated circuit connected to the second party hard disk, the playback random access memory and the first party control integrated circuit	7, 11, 16, 23, 32	p. 3, lns. 20-33 p. 4, lns 15-20 Fig. 1	<i>ipsis verbis</i>
the second party control integrated circuit and the first party control integrated circuit regulate the transfer of desired digital video or digital audio signals	7, 22, 23, 31, 32	p. 4, lns. 15-20	<i>ipsis verbis</i>
the second party control unit includes a second party control panel connected to and through which the second party control integrated circuit is programmed	7, 16, 19, 23, 26, 28, 32	p. 3, lns. 26-28 p. 4, lns. 12-14 Fig. 1	<i>ipsis verbis</i>

the playing means of the second party control unit includes a video display	9, 14, 18, 19, 25, 34	p. 3, Ins. 26-33 p. 5, Ins. 9-21 Fig. 1	<i>ipsis verbis</i>
the telecommunications lines include telephone lines	10, 11, 12, 15, 17, 20, 27, 29	p. 3, ln. 25 Fig. 1	<i>ipsis verbis</i>
means or mechanism for transferring money electronically via telecommunications lines from the second party to the first party	11, 16, 19	p. 1, Ins. 10-12 p. 2, Ins. 8-10, 20-26, 47-52 p. 3, Ins. 20-25 p. 4, Ins. 21-23	The as filed original specification has <i>ipsis verbis</i> support for electronic sales via telecommunications lines. A skilled artisan would readily recognize that electronic sales via telecommunications lines would include the transfer of money via telecommunications lines. This was addressed previously in the affidavit of Arthur Hair dated May 5, 1992.
means or mechanism for the first party to charge a fee to the second party and granting access to desired digital video or digital audio signals	16, 19, 26	p. 1, Ins. 13-15 p. 2, Ins. 8-10, 20-23, 47-50 p. 3, Ins. 20-33 Fig. 1	The specification discloses electronic sales via telephone lines. Because the agent is authorized to sell and to transfer via telephone lines, there is implicitly support for selling and thereby charging a fee. This was previously pointed out in the declaration of Arthur Hair submitted December 30, 1993.

means or mechanism for connecting electronically via telecommunications lines the first memory with the second memory	11, 16,	p. 4, Ins. 15-20 Fig. 1	A skilled artisan would readily recognize from the specification that the first memory would include a means for connecting to the second memory via the disclosed telephone lines.
the second party control unit includes an incoming random access memory	11, 16, 24, 33	p. 3, Ins. 26-29 Fig. 1	<i>ipsis verbis</i>
means or mechanism for transmitting desired digital video or digital audio signals	11, 16, 26, 28	p. 1, Ins. 10-12 p. 2, Ins. 8-10, 20-26, 47-52 p. 3, Ins. 20-25 p. 4, Ins. 21-23	The as filed original specification has <i>ipsis verbis</i> support for electronic distribution via telecommunications lines. A skilled artisan would readily recognize that this requires transmission of those signals, where the telecommunications lines act as the transmitter. A skilled artisan would also readily recognize in order to receive digital audio or digital video signals over telecommunications lines, part of the second party control unit would act as a receiver. This was addressed previously in the affidavit of Arthur Hair dated May 5, 1992.

<p>a transmitter connected to the first memory and the telecommunications lines, the first party in possession and control of the transmitter</p>	<p>11, 16</p>	<p>p. 1, lns. 10-12 p. 2, lns. 8-10, 20-26, 47-52 p. 3, lns. 20-25 p. 4, lns. 21-23</p>	<p>The as filed original specification has <i>ipsis verbis</i> support for electronic distribution via telecommunications lines. A skilled artisan would readily recognize that this requires transmission of those signals, where the telecommunications lines act as the transmitter.</p>
---	---------------	--	---

<p>a receiver connected to the second memory and the telecommunications lines, the second party in possession and control of the receiver</p>	<p>11, 16, 19, 26</p>	<p>p. 2, Ins. 47-49 p. 3, Ins. 35-38 p. 4, Ins. 24-26</p>	<p>A skilled artisan would readily recognize in order to receive digital audio or digital video signals over telecommunications lines as disclosed throughout the specification, part of the second party control unit would act as a receiver. This was addressed previously in the affidavit of Arthur Hair dated May 5, 1992.</p> <p>A skilled artisan would readily recognize that the receiver is in possession and control of the second party, since the specification as originally filed states throughout that the user can store, sort and play thousands of songs from the user unit. A skilled artisan would clearly understand that this means the second party controls and possesses the second party control unit. This was previously pointed out in the declaration of Arthur Hair submitted December 30, 1993.</p>
---	-----------------------	---	--

<p>the transmitter remote from the receiver, the receiver at a location determined by the second party in electrical communication with the connecting means or mechanism</p>	<p>11</p>	<p>p. 2, Ins. 47-50 p. 3, Ins. 20-40 Fig. 1 p. 4, Ins. 21-23</p>	<p>The original as filed specification states throughout that digital audio or digital video signals are sold and transferred via telephone lines. A skilled artisan would readily understand this to comprehend transfers between two remote locations. A skilled artisan would further recognize that in order for transmission of the digital audio or video signals to occur the transmitter and receiver have to be in electrical communication with the connecting means.</p>
<p>means or mechanism for storing desired digital video or digital audio signals with the receiver</p>	<p>11, 16</p>	<p>p. 3, Ins. 26-31 p. 4, Ins. 15-20 Fig. 1</p>	<p>The second party control unit includes a second party control integrated circuit which regulates the transfer of the digital audio and digital video signals. A skilled artisan would readily recognize that the second party integrated circuit regulates storage of the digital audio or digital video signals.</p>

speakers in possession and control of the second party	14, 18, 26	p. 3, ln. 33, 47-49	The as filed original specification has <i>ipsis verbis</i> support for speakers. A skilled artisan would readily recognize that the speakers would be in possession and control of the second party since the specification throughout states that the second party may repeatedly listen to stored songs through the speakers.
the second party choosing desired digital audio signals from the first party's hard disk	26	p. 2, lns. 8-16, 20-27, 38-52 p. 35-49	Throughout the specification discloses electronic sales of digital video or digital audio signals. A skilled artisan would readily recognize that this includes the selection of individual desired signals by the purchaser.

Claim Features of '440 Patent

Feature	Claims Reciting Feature	Written Description of Feature in Original Specification	Comments
A method/system for transferring desired digital video or digital audio signals	1-63	p. 1, lns. 13-15 p. 2, lns. 8-10, 20-26 (video) p. 5, lns. 36-43	<i>ipsis verbis</i>
forming a connection through telecommunications lines between a first memory of a first party and a second memory of a second party control unit of a second party	1-22, 25-28, 36-46, 58-63	p. 3, lns. 35-40	<i>ipsis verbis</i>
first memory having desired digital video or digital audio signals	1-21, 25-28, 42-57, 62, 63	p. 3, lns. 35-37	<i>ipsis verbis</i>
selling electronically by the first party to the second party through telecommunications lines	1-22, 25-28, 40, 42-45	p. 2, lns. 47-52 p. 3, lns. 35-40	<i>ipsis verbis</i>
transferring the desired digital video or digital audio signals from the first memory of the first party to the second memory of the second party control unit of the second party through telecommunications lines	1-21, 25-28, 36-40, 42-46, 62-63	p. 2, ln. 47-52 p. 3, lns. 35-40 Fig. 1	<i>ipsis verbis</i>

the second party control unit with the second memory is in possession and control of the second party	1-41, 46-52, 62	p. 3, Ins. 26-33, 40-43	The as filed original specification includes <i>ipsis verbis</i> support for a second party control unit, where the user is the second party. A skilled artisan would readily recognize that the second memory is in possession and control of the second party, since the specification as originally filed states throughout that the user can store, sort and play thousands of songs from the user unit. A skilled artisan would clearly understand that this means the second party controls and possesses the second party control unit. This was previously pointed out in the declaration of Arthur Hair submitted May 5, 1992.
playing through speakers of the second party control unit the digital video or digital audio signals in the second memory	1-10, 11, 22, 36-46, 63	p. 2, Ins. 26-32	<i>ipsis verbis</i>
speakers of the second party control unit connected with the second memory of the second party control unit	1-10, 28, 35, 62	p. 3, Ins. 25-32 p. 4, Ins. 47-50 Fig. 1	<i>ipsis verbis</i>

<p>first control unit in possession and control of first party</p>	<p>24, 31-35</p>	<p>p. 2, Ins. 38-43 p. 3, Ins. 35-49</p>	<p>The as filed original specification includes <i>ipsis verbis</i> support for a first party control unit, where the authorized agent is the first party. A skilled artisan would readily recognize that the first party control unit is in possession and control of the first party because as an "agent authorized to electronically sell and distribute" digital audio or digital video, the first party would necessarily have to possess and control the source of the digital audio and digital video. This was previously pointed out in the declaration of Arthur Hair submitted May 5, 1992.</p>
<p>second party location remote from the first party location, determined by the second party</p>	<p>2-63</p>	<p>p. 2, Ins. 47-50 p. 3, Ins. 20-40 Fig. 1 p. 4, Ins. 21-23</p>	<p>The original as filed specification states throughout that digital audio or digital video signals are sold and transferred via telephone lines. A skilled artisan would readily understand this to comprehend transfers between two remote locations. Since the second party possesses the second memory the second party can determine its location. This was previously pointed out in the declaration of Arthur Hair submitted May 5, 1992.</p>

charging a fee via telecommunications lines by the first party to the second party	2-10, 19-21, 36-40, 43-45, 47-63	p. 1, lns. 13-15 p. 2, lns. 8-10, 20-23, 47-50 p. 3, lns. 20-33 Fig. 1	The specification discloses electronic sales via telephone lines. Because the agent is authorized to sell and to transfer via telephone lines, there is implicitly support for selling and thereby charging a fee. This was previously pointed out in the declaration of Arthur Hair submitted December 30, 1993.
second party has an account, charging the account of the second party Possibly Amend to: "Charging the second party"	3-10, 20-21, 38-40, 44-45, 56-57, 60-61	p. 1, lns. 13-15 p. 2, lns. 8-10, 20-23, 47-50 p. 3, lns. 20-33 Fig. 1	The specification discloses electronic sales via telephone lines. A skilled artisan would readily recognize that charging a fee via telecommunications lines would include the second party having an account that can be charged. This was previously pointed out in the declaration of Arthur Hair submitted December 30, 1993.
telephoning the first party controlling use of the first memory by the second party Possibly Amend to: "establishing telephone communications between the first memory and the second memory"	4-10, 39-40, 45, 57, 61	p. 2, lns. 47-50 p. 3, lns. 20-40 Fig. 1 p. 4, lns. 21-23	The original as filed specification states throughout that digital audio or digital video signals are sold and transferred via telephone lines. A skilled artisan would readily recognize this as comprehending the telephoning of the first party by the second party to initiate a transaction. This was addressed previously in the declaration of Arthur Hair submitted May 5, 1992.

providing a credit card number of the second party controlling the second memory to the first party controlling the first memory so the second party is charged money	4-10, 21, 39-40, 45, 61	p. 1, lns. 13-15 p. 2, lns. 8-10, 20-23, 38-52 p. 3, lns. 12-15, 35-37	The original as filed specification states throughout that the invention provides for electronic sales of digital audio or digital video signals. A skilled artisan would readily recognize credit card sales as being comprehended within electronic sales. This was addressed previously in the affidavit of Arthur Hair dated May 5, 1992.
storing the desired digital video or digital audio signals in the second memory	5-10, 22, 36-41	p. 2, lns. 23-27	<i>ipsis verbis</i>
electronically coding the desired digital video or digital audio signals into a configuration which would prevent unauthorized reproduction of the desired digital audio signals	6-8	p. 2, lns. 17-19 p. 4, lns. 15-20	<i>ipsis verbis</i>
first memory includes first party hard disk	7-8, 13, 14, 27-28, 34-35, 49-54	p. 4, lns. 5-6 p. 3, ln. 19 Fig. 1	<i>ipsis verbis</i>
second party can view desired digital video signals	58-61	p. 5, lns. 36-43 p. 3, lns. 26-33	The as filed original specification has <i>ipsis verbis</i> support for a video display. Since the specification explicitly says that the invention is applicable to video, a skilled artisan would recognize that a user could view the desired video signals on the video display.

second party can listen to the desired digital audio signals	63	p. 4, lns. 27-28, 36-50	<i>ipsis verbis</i>
first memory includes a sales random access memory chip	7-8, 13-18, 25-28, 49-54	p. 3, lns. 19-24 Fig. 1	<i>ipsis verbis</i>
second party control unit includes second memory	48-54	p. 3, lns. 26-30 Fig. 1	The as filed original specification has <i>ipsis verbis</i> support for a second party control unit. A skilled artisan would readily understand that the second party hard disk corresponds to a second memory.
second party control unit has a second party control panel	8, 12-21, 25-28, 32-35, 47-57	p. 3, lns. 26-27 Fig. 1	<i>ipsis verbis</i>
second party control panel connected to the second party integrated circuit	8, 16-18, 25-28, 32-35, 52-54	p. 3, lns. 26-28 Fig. 1	<i>ipsis verbis</i>
second memory of the second party control unit includes an incoming random access memory chip	9-10, 17-18, 25-28, 32-35, 53-54	p. 3, ln. 26-29 Fig. 1	<i>ipsis verbis</i>
second memory of the second party control unit includes a second party hard disk for storing the desired digital video or digital audio signals	9-10, 12-21, 25-28, 34-35, 50-54	p. 3, lns. 26-31 Fig. 1	<i>ipsis verbis</i>

second memory of the second party control unit includes a playback random access memory chip for temporarily storing the desired digital video or digital audio signals for sequential playback	9-10, 25-28, 32-35, 50-54	p. 3, lns. 26-30 p. 4; lns. 39-50 Fig. 1	<i>ipsis verbis</i>
a first party control unit having a first memory	12-21, 25-28	p. 3, lns. 20-24 Fig. 1	<i>ipsis verbis</i>
second party control unit having means or a mechanism for playing the desired digital video or digital audio signals connected to the second memory and the second party control panel	12-35	p. 3, lns. 26-33 Fig. 1	The as filed original specification has <i>ipsis verbis</i> support for speakers and video display which are means for playing.
first party control integrated circuit connected to the first party hard disk, the first party sales random access memory, and the second party control integrated circuit through the telecommunications lines	15-18, 25-28, 32-35, 51-54	p. 3, lns. 20-33 Fig. 1	<i>ipsis verbis</i>

second party control integrated circuit connected to the second party hard disk, the playback random access memory, and the first party control integrated circuit through the telecommunications lines	16-18, 25-28, 52-54	p. 3, lns. 20-33 Fig. 1	<i>ipsis verbis</i>
first party control integrated circuit and second party control integrated circuit regulate the transfer of the desired digital video or digital audio signals	13-18, 25-28	p. 4, lns. 15-20	<i>ipsis verbis</i>
first party control panel connected to the first party control integrated circuit	15-18, 25-28, 51-54	p. 3, lns. 20-24 Fig. 1	<i>ipsis verbis</i>
incoming random access memory chip connected to the second party hard drive and the second party control integrated circuit, and the first party control unit through the telecommunications lines	17-18, 25-28, 53-54	p. 3, lns. 20-33 Fig. 1	<i>ipsis verbis</i>
second party control unit includes a video display unit and/or speakers	18, 25-28, 35, 47-61	p. 3, lns. 26-33 Fig. 1	<i>ipsis verbis</i>

second party control unit having a receiver, second memory connected to the receiver	22, 41, 47-56, 58-60	p. 2, Ins. 47-49 p. 3, Ins. 35-38 p. 4, Ins. 24-26	A skilled artisan would readily recognize in order to receive digital audio or digital video signals over telecommunications lines as disclosed throughout the specification, part of the second party control unit would act as a receiver. This was addressed previously in the affidavit of Arthur Hair dated May 5, 1992.
second party financially distinct from the first party	22, 41	p. 2, Ins. 8-16, 20-27, 38-52 p. 35-49	Throughout the specification discloses electronic sales of digital video or digital audio signals. A skilled artisan would readily recognize that the first and second parties would be financially distinct since this is required in order to have a sale. This issue was previously addressed in the affidavit of Arthur Hair filed on May 5, 1992.
first memory with a transmitter in control and possession of the first party	22-24, 29-35, 41, 58-61, 63	p. 1, Ins. 10-12 p. 2, Ins. 8-10, 20-26, 47-52 p. 3, Ins. 20-25 p. 4, Ins. 21-23	The as filed original specification has <i>ipsis verbis</i> support for electronic distribution via telecommunications lines. A skilled artisan would readily recognize that this requires transmission of those signals, where the telecommunications lines act as the transmitter.

<p>receiver is in possession and control of the second party</p>	<p>22-24, 29-35, 41, 58-61, 63</p>	<p>p. 2, Ins. 47-49 p. 3, Ins. 35-38 p. 4, Ins. 24-26</p>	<p>A skilled artisan would readily recognize in order to receive digital audio or digital video signals over telecommunications lines as disclosed throughout the specification, part of the second party control unit would act as a receiver. This was addressed previously in the affidavit of Arthur Hair dated May 5, 1992. A skilled artisan would readily recognize that the receiver is in possession and control of the second party, since the specification as originally filed states throughout that the user can store, sort and play thousands of songs from the user unit. A skilled artisan would clearly understand that this means the second party controls and possesses the second party control unit. This was previously pointed out in the declaration of Arthur Hair submitted December 30, 1993.</p>
<p>means or mechanism for transferring money electronically via telecommunications lines from the second party to the first party controlling use of the first memory</p>	<p>23-24, 30-35</p>	<p>p. 1, Ins. 10-12 p. 2, Ins. 8-10, 20-26, 47-52 p. 3, Ins. 20-25 p. 4, Ins. 21-23</p>	<p>The as filed original specification has <i>ipsis verbis</i> support for electronic sales via telecommunications lines. A skilled artisan would readily recognize that electronic sales via telecommunications lines would include the transfer of money via telecommunications lines. This was addressed previously in the affidavit of Arthur Hair dated May 5, 1992.</p>

second party choosing desired digital video or digital audio from first memory with second party control panel	47-63	p. 2, Ins. 8-16, 20-27, 38-52 p. 35-49	Throughout the specification discloses electronic sales of digital video or digital audio signals. A skilled artisan would readily recognize that this includes the selection of individual desired signals by the purchaser.
means or mechanism for connecting electronically via telecommunications lines the first memory with the second memory	23-24, 29-35	p. 4, Ins. 15-20 Fig. 1	A skilled artisan would readily recognize from the specification that the first memory would include a means for connecting to the second memory via the disclosed telephone lines.
means or a mechanism for transmitting the desired digital video or digital audio signals from the first memory to a receiver having the second memory	23-24, 29-35	p. 1, Ins. 10-12 p. 2, Ins. 8-10, 20-26, 47-52 p. 3, Ins. 20-25 p. 4, Ins. 21-23	The as filed original specification has <i>ipsis verbis</i> support for electronic distribution via telecommunications lines. A skilled artisan would readily recognize that this requires transmission of those signals, where the telecommunications lines act as the transmitter. A skilled artisan would also readily recognize in order to receive digital audio or digital video signals over telecommunications lines, part of the second party control unit would act as a receiver. This was addressed previously in the affidavit of Arthur Hair dated May 5, 1992.

means or a mechanism for storing the digital video or digital audio signals in the second memory	23-24, 29-35	p. 3, lns. 26-31 p. 4, lns. 15-20 Fig. 1	The second party control unit includes a second party control integrated circuit which regulates the transfer of the digital audio and digital video signals. A skilled artisan would readily recognize that the second party integrated circuit regulates storage of the digital audio or digital video signals.
playing means or mechanism connected to the second memory	23-24, 29-35	p. 3, lns. 26-33 p. 4, lns. 39-50 Fig. 1	<i>ipsis verbis</i>
second memory connected to receiver and video display	48-54, 58-61	p. 3, lns. 26-33 p. 4, lns. 39-50 Fig. 1	The as filed original specification has <i>ipsis verbis</i> support for a video display connected to the second memory. A skilled artisan would also readily recognize in order to receive digital audio or digital video signals over telecommunications lines, part of the second party control unit would act as a receiver. This was addressed previously in the affidavit of Arthur Hair dated May 5, 1992.
telecommunications lines include telephone lines	26-28, 33-35	p. 3, ln. 25 Fig. 1	<i>ipsis verbis</i>
incurring a fee by second party to first party for use of telecommunication lines, the desired digital video or audio signal in first memory	46		(CANCEL)



UNITED STATES PATENT AND TRADEMARK OFFICE

UNITED STATES DEPARTMENT OF COMMERCE
United States Patent and Trademark Office
Address: COMMISSIONER FOR PATENTS
P.O. Box 1450
Alexandria, Virginia 22313-1450
www.uspto.gov

APPLICATION NO.	FILING DATE	FIRST NAMED INVENTOR	ATTORNEY DOCKET NO.	CONFIRMATION NO.
90/007,402	01/31/2005	5191573	NAPS001	2998

23973 7590 03/17/2007

DRINKER BIDDLE & REATH
ATTN: INTELLECTUAL PROPERTY GROUP
ONE LOGAN SQUARE
18TH AND CHERRY STREETS
PHILADELPHIA, PA 19103-6996

EXAMINER

ART UNIT PAPER NUMBER

DATE MAILED: 03/17/2007

Please find below and/or attached an Office communication concerning this application or proceeding.



UNITED STATES PATENT AND TRADEMARK OFFICE

Commissioner for Patents
United States Patent and Trademark Office
P.O. Box 1450
Alexandria, VA 22313-1450
www.uspto.gov

DO NOT USE IN PALM PRINTER

(THIRD PARTY REQUESTER'S CORRESPONDENCE ADDRESS)

ALBERT S. PENILA

MARTINE PENILLA & GENCARELLA LLP

710 LAKEWAY DRIVE, SUITE 200

SUNNYVALE, CA 94085

EX PARTE REEXAMINATION COMMUNICATION TRANSMITTAL FORM

REEXAMINATION CONTROL NO. 90/007,402.

PATENT NO. 5191573.

ART UNIT 3992.

Enclosed is a copy of the latest communication from the United States Patent and Trademark Office in the above identified *ex parte* reexamination proceeding (37 CFR 1.550(f)).

Where this copy is supplied after the reply by requester, 37 CFR 1.535, or the time for filing a reply has passed, no submission on behalf of the *ex parte* reexamination requester will be acknowledged or considered (37 CFR 1.550(g)).

Office Action in Ex Parte Reexamination	C ntr I N . 90/007,402	Patent Under Re xamination 5191573	
	Examiner Roland G. Foster	Art Unit 3992	

-- The MAILING DATE of this communication appears on the cover sheet with the correspondence address --

- a Responsive to the communication(s) filed on 29 November 2006. b This action is made FINAL.
c A statement under 37 CFR 1.530 has not been received from the patent owner.

A shortened statutory period for response to this action is set to expire 2 month(s) from the mailing date of this letter. Failure to respond within the period for response will result in termination of the proceeding and issuance of an *ex parte* reexamination certificate in accordance with this action. 37 CFR 1.550(d). **EXTENSIONS OF TIME ARE GOVERNED BY 37 CFR 1.550(c)**. If the period for response specified above is less than thirty (30) days, a response within the statutory minimum of thirty (30) days will be considered timely.

Part I THE FOLLOWING ATTACHMENT(S) ARE PART OF THIS ACTION:

- | | |
|--|--|
| 1. <input type="checkbox"/> Notice of References Cited by Examiner, PTO-892. | 3. <input type="checkbox"/> Interview Summary, PTO-474. |
| 2. <input type="checkbox"/> Information Disclosure Statement, PTO/SB/08. | 4. <input checked="" type="checkbox"/> <u>07/206,497 (as originally filed)</u> . |

Part II SUMMARY OF ACTION

- 1a. Claims 1-6 and 44-49 are subject to reexamination.
1b. Claims _____ are not subject to reexamination.
2. Claims 7-43 have been canceled in the present reexamination proceeding.
3. Claims _____ are patentable and/or confirmed.
4. Claims 1-6 and 44-49 are rejected.
5. Claims _____ are objected to.
6. The drawings, filed on _____ are acceptable.
7. The proposed drawing correction, filed on _____ has been (7a) approved (7b) disapproved.
8. Acknowledgment is made of the priority claim under 35 U.S.C. § 119(a)-(d) or (f).
a) All b) Some* c) None of the certified copies have
1 been received.
2 not been received.
3 been filed in Application No. _____.
4 been filed in reexamination Control No. _____.
5 been received by the International Bureau in PCT application No. _____.
* See the attached detailed Office action for a list of the certified copies not received.
9. Since the proceeding appears to be in condition for issuance of an *ex parte* reexamination certificate except for formal matters, prosecution as to the merits is closed in accordance with the practice under *Ex parte* Quayle, 1935 C.D. 11, 453 O.G. 213.
10. Other: _____

cc: Requester (if third party requester)

DETAILED ACTION

Summary

U.S. Patent No. 5,191,573 (the "'573" patent) is presently under reexamination in this proceeding. The '573 patent is generally directed to downloading audio and video content via a telecommunications line (e.g., see claims 1 and 4), where a district court has held that the term "telecommunications line" includes the Internet.¹ The amendment, filed on November 29, 2006 (the "Amendment"), has been duly considered but is not deemed persuasive to overcome the prior rejections of all claims in the '573 patent under reexamination. In addition, the Patent Owner has not shown that the effective filing date of the instant '573 patent under reexamination is earlier than September 18, 1990. Therefore, the prior rejections are repeated below, except for any new grounds of rejections necessitated by the amendment to the claims. Accordingly, this Office action is made final. See MPEP § 706.07(a) and § 2271.III.

Benefit of Earlier Filing Date Regarding Original Claims

Definitions

As an initial matter, the instant '573 patent and the earlier filed application are related as follows. The '573 patent under reexamination issued from U.S. Application No. 07/586,391 (hereinafter the "Child" application), which was filed on September 18, 1990. The parent (earlier filed) application to the Child application is U.S. Application No. 07/206,497, as originally filed on June 13, 1988 (hereinafter the "Parent" application).

¹ Sightsound.com Inc. v. NSK, Inc. Cdnw, Inc., and Cdnw Online, Inc., Civil Action No. 98-118, pp. 50 and 57 (District Court for the Western District of Pennsylvania, Feb. 2002).

Basic Statement of the Issues Regarding Priority

The Child application is alleged to be related to the Parent application as a "continuation" application (i.e., the Child application did not, on filing, contain disclosure of any subject matter not present in the Parent application, and the claims of the Child application, on filing, were fully supported by the disclosure of the Child application, see MPEP § 201.06(c).III).² However, the specification of the Child application (at the time the Child application issued as the '573 patent under reexamination) and the specification of the Parent application, as originally filed (see attachment "A"), differ considerably, as discussed below, raising issues of priority under 35 U.S.C. 120.

Furthermore, the prosecution history of the Child application (issuing as the '573 patent under reexamination) does not show that the examiner had any reason to consider the propriety of the benefit (continuation) claim set forth in the Child application to the originally filed, Parent application, as, for example a reference dated later than the filing date of the Parent application that would antedate the actual filing date of the Child application. In addition, the prosecution history of the Child patent does not contain any substantive, written discussion between the Patent Owner and the examiner regarding such a claim to the benefit of filing date in the Parent applications, as originally filed.

² Note that all the applications above were filed under the old "file wrapper continuation" procedures under 37 CFR 1.62, see MPEP § 201.06(a).

Art Unit: 3992

For the reasons to be discussed below, the effective filing date of the '573 patent under reexamination, which issued from the Child application, is September 18, 1990 (at the earliest), which is the actual filing date of the Child application.

Intervening Patents and Printed Publications Are Available as Prior Art In a Reexamination Proceeding According to 35 U.S.C. 120

A rejection may be made in an *ex-parte* reexamination proceeding based on an intervening patent when the patent claims under reexamination, under 35 U.S.C. 120, are entitled only to the filing date of the patent under reexamination. Specifically:

Rejections may be made in reexamination proceedings based on intervening patents or printed publications where the patent claims under reexamination are entitled only to the filing date of the patent and are not supported by an earlier foreign or United States patent application whose filing date is claimed. For example, under 35 U.S.C. 120, the effective date of these claims would be the filing date of the application which resulted in the patent. Intervening patents or printed publications are available as prior art under *In re Ruscetta*, 255 F.2d 687, 118 USPQ 101 (CCPA 1958), and *In re van Langenhoven*, 458 F.2d 132, 173 USPQ 426 (CCPA 1972). See also MPEP § 201.11

MPEP § 2258.I.C, Scope of Reexamination (emphasis added).

As discussed above, 35 U.S.C. 120 applies to *ex-parte* reexamination procedure. To be entitled to benefit of an earlier filing date under 35 U.S.C. 120, the previously filed specification of the Parent application must support the invention claimed in the Child application. See 35 U.S.C. 120.

Art Unit: 3992

The Original Claims of the Child Patent Under Reexamination Are Not Entitled to Benefit of the Filing Date of the Parent Application, as Originally Filed, Under 35 U.S.C. 120 Because the Parent Application, as Originally Filed, Fails to Support Several Features Claimed in the Child Patent Under Reexamination

A review of the prosecution history reveals that a significant amount of new text (directed to various features) added in a series of amendments is not found in the Parent application as originally filed (attachment "A"). Consider the following Table I:

Art Unit: 3992

Table I. New Matter Chart

	Parent Appln. 07/206,497, filed 6/13/88 (Abandoned)		Child Appln. 07/586,391, filed 9/18/90 (5,191,573)	
Feature	Date First Appearing in Claims of Parent Appln.	Date First Appearing in Spec. of Parent Appln.	Date First Appearing in Claims of Child Appln.	Date First Appearing in Spec. of Child Appln.
Hard Disk/Control Unit of Seller/User	Filing Date of the Original Application – 6/13/88	Filing Date of the Original Application – 6/13/88		Filing Date of the Child Application – 9/18/90
Electronic sales and distribution of the music				
Broad Statement at end of spec. regarding Video Applicability, Note *		Filing Date of the Original Application – 6/13/88		Filing Date of the Child Application – 9/18/90
Transferring Money from Second Party to a First Party (Charging a Fee)	12/22/88 (2/28/90)		Filing Date of the Child Application – 9/18/90	12/11/91
Providing a Credit Card Number	12/22/88		Filing Date of the Child Application – 9/18/90	
Controlling Use of First/Second Memory	12/22/88		Filing Date of the Child Application – 9/18/90	12/11/91
Transmitting to a Location Determined by Second Party	2/28/90		Filing Date of the Child Application – 9/18/90	12/11/91
Specific Video Download Procedures	2/28/90		Filing Date of the Child Application – 9/18/90	12/11/91 Note **
First Party in Possession of Transmitter	8/24/90, but not entered		Filing Date of the Child Application – 9/18/90	12/11/91
Second Party in Possession of Receiver and Second Memory	8/24/90, but not entered		Filing Date of the Child Application – 9/18/90	12/11/91

Key: Clear row means original matter present in the original Parent application. Shaded row means new matter introduced by amendment into both the Parent and Child applications subsequent to the date of the original Parent application.

Note * - The original specification also describes using a "convenient visual display of the user's library of songs" (page 5), however this section appears to relate to displaying category/lyrical information to the user regarding downloaded audio content, and not directed to the actual download, processing, and display of video content.

Art Unit: 3992

Note ** - Even more detailed video download procedures are added to the specification of subsequent Child applications, see the 90/007,403 and 90/007,407 reexaminations.

Patent owner failed to provide adequate support for all the new text added by the series of amendments (as identified in Table I above) to the Parent and Child applications. Patent owner should specifically point out the support for any amendments made to the original disclosure.

MPEP § 714.02, 2163.II.A.2(b), and 2163.06. Consider the following:

Table II. Amendment History Chart

I. Parent Application No. 07/206,497 (filed June 13, 1988)

a. Amendment of Dec. 22, 1988

New Matter in Claims

New Independent Claim 11 - "transferring money to a party controlling use of the first memory"

New Dependent Claim 13 - "providing a credit card number of the party controlling use of the first memory by the party controlling the second memory"

New Matter in Spec.

No new matter added to specification.

Support for New Matter

Applicant made a statement in the amendment that "support for these new claims is found in the figures." This statement however is very broad. Applicant does not specifically point out where in

the figures the added features are found and the examiner cannot find support for such features.

b. Amendment of Feb. 28, 1990

New Matter in Claims

New Dependent Claim 14 - "transmitting the digital signal from the first memory to the second memory at a location determined by the second party..."

New Independent Claim 15 -

* "transmitting a desired digital, a video or audio music signal...."

[detailed recitation of a method for transmitting follows]

* "charging a fee to the first party controlling use of the second memory"

New Dependent Claim 18 - "charging a fee to a party controlling the use and the location of the second memory."

New Matter in Spec.

Abstract briefly mentions storing video signals onto a hard disk.

Support for New Matter

Applicant made a statement in the amendment that "antecedent support for these claims is found in Figure 1." This statement is very broad. Applicant does not specifically point out where in the figures the added features are found and the examiner cannot find support for such features.

c. Proposed After-final Amendment of August 24, 1990 (Not Entered)

New Matter in Claims

Independent Claim 11 -

*"second party controlling use and in possession of the second memory"

Art Unit: 3992

* "with a transmitter in control and possession of the first party to a receiver having a second memory at a location determined by the second party, said receiver in possession and control of the second party"

Independent Claim 15 –

* "charging a fee by a first party controlling use of the first memory

* new limitations similar to claim 11 above

New Matter in Spec.

Title amended to state "Method for Transmitting a Desired Video or Audio Signal"

Support for New Matter

No support was provided.

II. Child Application No. 07/586,391 (filed September 18, 1990) (FWC) (Issued as 5,191,573)

A substantial amount of new matter to the Child application, with respect to the Parent application as originally filed. For example, see the preliminary amendment of September 18, 1990, the amendment of December 11, 1991, the amendment of June 25, 1992, and the amendment of October 5, 1992.

Thus, as discussed above, the Patent Owner failed to point out support in the original Parent application, as originally filed (attachment "A"), for all of the new text added by the series of amendments. Patent Owner should specifically point out the support for any amendments made to the original disclosure. MPEP § 714.02, 2163.II.A.2(b), and 2163.06.

Art Unit: 3992

Limitations Later Added by Amendment, but Missing from the Original Written Description, Must Be Required By or Necessarily Present in the Original Written Description, Otherwise Those Limitations Are New Matter To the Original Written Description

Furthermore, the new text added by the amendments identified above is in the nature of additional, narrowing limitations and elements undisclosed by the generic statements in the original disclosure of the Parent application. When an explicit limitation in a claim "is not present in the written description whose benefit is sought it must be shown that a person of ordinary skill would have understood, at the time the patent application was filed, that the description requires that limitation." Hyatt v. Boone, 146 F.3d 1348, 1353, 47 USPQ2d 1128, 1131 (Fed. Cir. 1998) (emphasis added) (Certiorari Denied). "To establish inherency, the extrinsic evidence must make clear that the missing descriptive matter is necessarily present in the thing described in the reference.... Inherency, however, may not be established by probabilities or possibilities." In re Robertson, 169 F.3d 743, 745, 49 USPQ2d 1949, 1950-51 (Fed. Cir. 1999) (citations omitted, emphasis added). As for speculation about undisclosed uses of the originally disclosed elements, it is not sufficient that the written description, when "combined with the knowledge in the art, would lead one to speculate as to modifications that the inventor might have envisioned, but failed to disclose." Lockwood v. American Airlines, Inc., 107 F.3d 1565, 1571, 41 USPQ2d 1961, 1965-66 (Fed. Cir. 1997). See also MPEP § 2163.II.A.2(b) and § 2163.05.II.

New Matter Issues Other Than Video Download Features

In the instant case, it is clear that the explicit limitations added by amendment but missing from the original written description are not required by or necessarily present in the

Art Unit: 3992

original written description. The recited details as to how money is transferred from a second party to the first party, a fee is charged, or how a credit card number is provided are not disclosed or required by the original, generic statement "electronic sales and distribution of the music...." For example, during the originally disclosed electronic sale, money could instead be transferred from a third party buyer (e.g., advertiser, local network provider, local retail store, friend, etc.) and/or transferred to a third party seller (e.g., remote wholesale music provider, local network provider, local retail store, etc.). Furthermore, a money fee would not necessarily be charged upfront during a sale (e.g., a free preview or trial period, or a sale based on barter or credits). Thus, an electronic sale could be booked without the transfer of money. Finally, digital content would not necessarily be purchased using a credit card. For example, the person downloading the content could receive the bill in the mail.

Similarly, the ability to control and possess a transmitter, receiver, and memory and to determine the location to which data is transmitted is not disclosed or required by the original, generic statements such as "control unit of the user." For example, the originally disclosed control unit of the seller or user could instead mean that seller and/or buyer instead rent or lease the equipment as is commonplace in the computer network industry rather than possess the equipment. Neither is the seller or user required to exercise control over their equipment, for example, the downloading services could be provided by a third party offering a turn-key solution.

The Patent Owner submitted a Declaration on June 25, 1992 attempting to show many of the above features were nonetheless required. This Declaration however, and related attorney arguments, were in response to a new matter objection made to one in a series of amendments, specifically the amendment of December 11, 1991 (see the non-final rejection in the Child application, mailed on February 24, 1992), where by the way, both the examiner and Patent Owner only touched upon a subset of the new matter issues described in Table I above. A series of amendments to the specification and claims were filed previously and subsequently to this single amendment in the Parent and Child applications, where each amendment gradually added new matter. See Table II, *supra*. Therefore, it is not clear whether the examiner addressed this issue in regard to the specification as originally filed in the Child application from which the '573 patent issued, much less in regard to the specification as originally filed in the Parent application, which is at issue here.

Nonetheless, the Declaration is unpersuasive. Although factual evidence is preferable to opinion testimony in a 37 C.F.R. 1.132 Declaration, opinion testimony is entitled to consideration and some weight so long as the opinion is not on the ultimate legal conclusion at issue. While an opinion as to a legal conclusion is not entitled to any weight, the underlying basis for the opinion may be persuasive. MPEP § 71601(c).III. Here, the 1.132 Declaration relies upon the opinion of the inventor, often couched in conclusory language, to reach conclusions about what would have been required by the specification, as it existed at the time of the December 11, 1991 amendment. That is, the Declaration goes to the ultimate legal conclusion at issue, whether the specification at the time of the December 11, 1991 amendment

discloses those limitations newly introduced into the December 1991 amendment. Thus, the Declaration is not entitled to any weight, and furthermore the basis for the opinion is unpersuasive. For example, consider the following conclusory statement from page 2:

One skilled in the art would know that an electronic sale inherently assumes a transferring of money by providing a credit or debit card number (since that is the only way for electronic sales to occur) coupled with a transferring of a service or product.

As discussed above, a money fee would not necessarily be charged upfront during a sale (e.g., a free preview or trial period, or a sale based on barter or credits). Thus, an electronic sale could be booked without the transfer of money. The purchaser instead could be easily identified by other types of information (e.g., account number, PIN, email address, mailing address, etc.). Furthermore, digital content would not necessarily be purchased using a credit card. The simplest example is that a person downloading the content could receive the bill in the mail.

New Matter Related to Video Download Features

Regarding the specific video download features added to the original specification and claims by the above amendments are not disclosed nor required by the one sentence, generic statement at the end of the original specification that "this invention is not to be limited to Digital Audio Music and can include Digital Video...."³ Undisclosed digital video features (assuming enablement) could be implemented into the broadly termed "invention" in an almost unlimited number of specific, possible (but not required) ways, such as at various levels of integration with

³ The original specification also describes using a "convenient visual display of the user's library of songs" (page 5), however this section appears to relate to displaying category/lyrical information to the user regarding downloaded audio content, and not directed to the actual download, processing, and display of video content.

Art Unit: 3992

the originally disclosed audio system and at various levels of detail. By introducing new text directed to specific video download features in the subsequent amendments, the Patent Owner simply chose one possible (but not required) way to integrate video features into the originally disclosed audio system.⁴ Indeed, the Patent Owner continued to add specific, video download and transmission procedures not found in the original specification (i.e., chose other possible ways to integrate video features) during the prosecution of subsequent, allegedly "continuation" applications, see the 90/007,403 and 90/007,407 reexaminations.⁵ Thus, the original, one sentence generic statement does not require all the many instances of undisclosed, specific details later added by the Patent Owner.

Furthermore, transmission and storage of digital video content significantly differs in technology from the transmission and storage of digital audio content, thus the originally disclosed audio transmission features fail to imply or require any video transmission features. For example, the decoding of digital video data is much more processor intensive than the decoding of digital audio data due to the increased information content and bandwidth of a typical video signal. In the mid 1980(s), at the time of the filing date of the original Parent specification, only compact audio disks players were routinely available.⁶ Personal user devices with the processing power capable of playing back much larger and more complex digital video

⁴ See the amendments of February 28, 1990, December 11, 1991, and June 25, 1992.

⁵ Although adding text that replaces all appearances of "audio" with "video" would be one possible (but not required) way to integrate undisclosed video features into the originally disclosed audio system, this is not what the applicant has done here, probably because such a rote replacement would create a dysfunctional system. For example, those originally disclosed audio features directed to listening to the audio during cannot be simply replaced with the word video. For example, applicant waited until the child application to add new text directed toward displaying downloaded video, see page 10 of the amendment, filed January 3, 1994, in child application 08/023,398.

⁶ See "The History of Recordings", Recording Industry of Association, retrieved from <http://www.riaa.com/issues/audio/hisotry.asp> on September 19, 2006. See also the "History of CD Technology", citing as a

Art Unit: 3992

files, such as DVD players, were not routinely available until the late 1990(s), and even these devices initially only read video data from read-only DVD disks capable of storing large digital video files, not from video data downloaded (recorded) from a remote server via a communications network.⁷ Thus, undisclosed devices capable of decoding and playing back digital video files would not have been required nor necessarily present based on the original disclosure of an integrated circuit 50 of the user, which was also originally disclosed to process and store audio information. For the same reasons, it is also not clear how the originally disclosed, incoming RAM 50c and playback RAM 50d could have supported storage of downloaded video and playback.

Further regarding the original equipment of the user (consumer), in 1988 a large capacity drive for a user (e.g., 3.5 inch form factor) was around 30 megabytes⁸, yet the digital bandwidth required to transmit a video signal at even VHS quality was 1.5 megabits per second (approximately 30 megabytes in 3 minutes) and this even using a Moving Picture Coding Experts Group Standard "1" ("MPEG-1") video compression technology not even available in 1988.⁹ Thus, undisclosed devices capable of downloading and storing digital video files would not have been required or necessarily present based on the original disclosure of hard disk 60, which was also originally disclosed to process and store audio information.

source "The compact Disc Handbook, 2nd Edition," by Ken C. Pohlmann, retrieved from <http://www.oneoffcd.com/info/hisotrycd.cfm> on September 19, 2006.

⁷ See the "History of MPEG", University of California, Berkeley, School of Information Management and Systems, retrieved from <http://www2.sims.berkeley.edu/courses/is224/s99/GroupG/report1.html> on September 19, 2006. See also the "History of CD Technology", citing as a source "The compact Disc Handbook, 2nd Edition," by Ken C. Pohlmann, retrieved from <http://www.oneoffcd.com/info/hisotrycd.cfm> on September 19, 2006.

⁸ See "IBM HDD Evolution" chart, by Ed Grochowski at Almaden, retrieved from http://www.sorageview.com/guideImages/z_ibm_sorageevolution.gif on September 19, 2006.

Regarding video equipment used at the library (server) end, even large mainframe computers (e.g., IBM mainframe computers) typically only provided hard drives with capacity well below 10 gigabytes.¹⁰ Thus, undisclosed devices capable of supporting even a small-sized video library, with its steep storage requirements as discussed above, would not have been required or necessarily present based on the original disclosure of the library (server) hard disk 10 of the copyright holder, which was originally disclosed as storing audio information.

Regarding the transfer of these large video files over a network, the proliferation of broadband communication network capable of delivering these large files to consumers, such as the Internet, simply did not exist or were not well known in 1988. Furthermore, it is not clear how the digital video would have been coded and decoded during transmission, as digital video coding standards for purposes of transmission and file downloading were not settled in 1988. As an example of the above points, the MPEG-1 standard, which was designed to code/decode digital video information and to transmit the video via a telephone (telecommunications) network in NTSC (broadcast) quality for archiving, was only established in 1992.¹¹ Thus, undisclosed devices capable of coding, transmitting, and decoding video digital data would not have been required or necessarily present based on the original disclosure of telephone line 30 (transmission line) and control IC(s) 20b and 50b (coding/decoding devices), which were originally disclosed as processing audio information.

⁹ See the "History of MPEG", University of California, Berkeley, School of Information Management and Systems, retrieved from <http://www2.sims.berkeley.edu/courses/is224/s99/GroupG/report1.html> on September 19, 2006.

¹⁰ IBM HDD Evolution chart, *supra*.

¹¹ History of MPEG, *supra*.

Conclusion Regarding Priority

In view of the above, all of the new text introduced by amendment into the Child application (as identified in Table I above) is considered new matter to the original Parent application, as originally filed (Attachment "A"), for the purposes of this reexamination. Thus, the previously filed, original specification of the Parent application fails to support the invention claimed in the Child application and thus is not entitled to priority under 35 U.S.C. 120. Thus, the effective filing date (priority) of the instant '573 patent under reexamination is latest date at which time the priority chain was broken, namely September 18, 1990 (at the earliest), which is also the filing date of the Child application (which issued as the '573 patent under reexamination).

Claim Rejections - 35 USC § 112

The following is a quotation of the first paragraph of 35 U.S.C. 112:

The specification shall contain a written description of the invention, and of the manner and process of making and using it, in such full, clear, concise, and exact terms as to enable any person skilled in the art to which it pertains, or with which it is most nearly connected, to make and use the same and shall set forth the best mode contemplated by the inventor of carrying out his invention.

Claims 1-6 and 44-49 are rejected under 35 U.S.C. 112, first paragraph, as failing to comply with the written description requirement.

Art Unit: 3992

New Claims Contain Extensive New Text that is Not Found in the Written Description of the Parent Application As Originally Filed

35 U.S.C. 112 issues can be addressed in a reexamination proceeding with respect to new claims or amendatory subject matter. MPEP § 2258.

"Most typically, the [112] issue will arise in the context of determining whether new or amended claims are supported by the description of the invention in the application as filed... whether a claimed invention is entitled to the benefit of an earlier priority date or effective filing date under 35 U.S.C. 119, 120, or 365(c)." MPEP § 2163.I. Here, the '573 patent under reexamination claims benefit under 35 U.S.C. 120 to the earlier filing date of the Parent application.

The new claim(s) contain subject matter, which was not described in the specification in such a way as to reasonably convey to one skilled in the relevant art that the inventor(s), at the time the original Parent application was filed, had possession of the claimed invention. Indeed, the new claims contain extensive new text that is not found in the written description of the originally filed Parent application (see Table I in the "Benefit of Earlier Filing Date" section above) (see attachment "A" regarding the originally filed, Parent application).

To comply with the written description requirement of 35 U.S.C. 112, para. 1, or to be entitled to an earlier priority date or filing date under 35 U.S.C. 119, 120, or 365(c), each claim limitation must be expressly, implicitly, or inherently supported in the originally filed disclosure. When an explicit limitation in a claim "is not present in the written description whose benefit is sought it must be shown that a person of ordinary skill would have understood, at the time the patent application was filed, that the description requires that limitation." Hyatt v. Boone, 146 F.3d 1348, 1353, 47 USPQ2d 1128, 1131 (Fed. Cir. 1998). See also In re Wright, 866 F.2d 422, 425, 9 USPQ2d 1649, 1651 (Fed. Cir. 1989).

MPEP § 2163.II.A.2.(b), emphasis added.

Here, the Patent Owner, on page 9 of the Amendment, states that the new claims mirror the original claims in the '573 patent, where alleged support for the original claims in the '573 patent are provided on pages 21-26 of the Amendment. Certain of the claim limitations addressed in this chart, however, are not necessarily disclosed (required by) the written description of the originally filed, Parent application, and thus are not present in the said written description. Thus these limitations are considered new matter, as extensively discussed by the examiner in the "Benefit of Earlier Filing Date Regarding the Original Claims" section above.

New and Amended Claims Contain a Negative Limitation that is Not Found in the Written Description of the Original Parent Application

The Amendment also introduced a negative limitation into independent claims 1 and 4. For example, claim 1 now recites "a non-volatile storage portion of the second memory, wherein the non-volatile storage portion is not a tape or a CD" (emphasis added).

Any negative limitation must have basis in the original disclosure. If alternative elements are positively recited in the specification, they may be explicitly excluded in the claims, however the mere absence of a positive recitation is not a basis for exclusion. Any claim containing a negative limitation, which does not have a basis in the original disclosure should be rejected under 35 U.S.C. 112. See MPEP § 2173.05(i).

Although the Parent application, as originally filed (attachment "A"), discloses a specific hard disk embodiment, which is therefore not in the form of a tape or a CD, the originally filed disclosure does not provide written description support for the recited, negative limitation. On page 8 of the Amendment, the Patent Owner points to page 4, lines 35 to 49 of the originally filed, Parent specification (attachment "A") has teaching a "hard disk for storing digital audio or digital video signals." The originally filed specification in the Parent application, including the section cited to by the Patent Owner above, only discloses one embodiment, where a hard disk 60 stores electronic audio music.¹² Thus, the originally filed, Parent specification discloses only a specific hard disk embodiment, which is not in the form of a tape or a CD. It should also be noted that "[c]laims are not necessarily limited to preferred embodiments, but if there are no other embodiments, and no other disclosure, then they may be so limited." Lizardtech, Inc. v. Earth Resource Mapping, Inc., 433 F.3d 1373, 1375 (Fed. Cir. 2006) (rehearing denied, *en banc*).

The negative limitation introduces new concepts beyond this specific embodiment. The new concepts include non-volatile storage devices that are not tapes or CDs, but that are also not hard disks. See page 3 of Ex Parte Wong, 2004 WL 4981845 (Bd.Pat.App. & Interf. 2004). The "express exclusion of certain elements implies the permissible inclusion of all other elements not so expressly excluded. This clearly illustrates that such negative limitations do, in fact, introduce new concepts. Ex parte Grasselli, 231 USPQ 393, 394 (Bd. App. 1983), *aff'd*

mem., 738 F.2d 453 (Fed. Cir. 1984). "The artificial subgenus thus created in the claims is not described in the parent case and would be new matter if introduced into the parent case. It is thus equally 'new mater'...." Ex Parte Johnson, 558 F.2d 1008, 1014 (CCPA 1977). Here, the originally filed disclosure does not necessarily disclose (require) or even suggest an undisclosed, artificial subgenus of non-volatile storage devices that are not tapes or CDs. Thus, such a claimed subgenus represents new matter.

Claims 4-6 and 47-49 are rejected under 35 U.S.C. 112, first paragraph, as failing to comply with the enablement requirement. The claim(s) contains subject matter, which was not described in the specification in such a way as to enable one skilled in the art to which it pertains, or with which it is most nearly connected, to make and/or use the invention.

35 U.S.C. 112 issues can be addressed in a reexamination proceeding with respect to new claims or amendatory subject matter. MPEP § 2258.

The new claim(s) contain subject matter, which was not described in the specification in such a way as to reasonably convey to one skilled in the relevant art that the inventor(s), at the time both original Parent application was filed, that the specification would have taught one skilled in the art how to make and/or use the full scope of the claimed invention without undue experimentation. In re Wright, 999 F.2d 1557, 1562, 27 USPQ2d 1510, 1513 (Fed. Cir. 1993). See also MPEP § 2164.01 and 2164.05(a).

¹² The originally filed specification in the Parent application, including the section cited to by the Patent Owner

Undue Experimentation Factors

There are many factors to be considered when determining whether there is sufficient evidence to support a determination that a disclosure does not satisfy the enablement requirement and whether any necessary experimentation is "undue." These factors include, but are not limited to whether the scope and breadth of the claims are reasonably related to the scope of enablement within the original specification, the level of ordinary skill in the art, and the quantity of undue experimentation. See MPEP 2164.01(a).

Here, the subject claims recite extensive new text directed to specific and detailed video download and processing procedures that is not found in original specification of the Parent Application. The original specification does contain a general statement at the end of the specification stating "[f]urther, it is intended that this invention is not to be limited to Digital Audio Music and can include Digital Video...." (attachment "A"), however this broad, generic statement fails to enable specifically claimed video download and processing procedures.¹³

The detailed and extensive claim limitations directed to video download and processing stand in contrast to the brief, generic one sentence disclosure in the original specification, as discussed above. Thus, the scope and breadth of the claims are not reasonably correlated to the scope of enablement in the original specification. The scope of enablement must at least bear a

above, also fails to teach that the hard disk stored video data despite assertions by the Patent Owner.

¹³ The original specification also describes using a "convenient visual display of the user's library of songs" (page 5), however this section appears to relate to displaying category/lyrical information to the user regarding downloaded audio content, and not directed to the actual download of video content.

Art Unit: 3992

“reasonable correlation” to the scope of the claims. See, e.g., In re Fisher, 427 F.2d 833, 839, 166 USPQ 18, 24 (CCPA 1970). See also MPEP § 2164.08.

The original specification would not have been enabling to one of ordinary skill in the art and furthermore an undue quantity of experimentation would have been required to make or use the scope of the claimed invention (video download and processing features) based on the original specification. The specification must be enabling as of the filing date of the specification. MPEP § 2164.05(a). Here, the filing date of the Parent Application was June 13, 1988. In the mid 1980(s) however, only compact audio disks players were just becoming popular.¹⁴ Personal user devices with the processing power capable of playing back much larger and more complex digital video files, such as DVD players, were not routinely available until the late 1990(s), and even these devices initially only read video data from read-only DVD disks capable of storing large digital video files, not from video data downloaded (recorded) from a remote server via a communications network.¹⁵ Thus, it is not clear how the originally disclosed, integrated circuit 50 of the user would have had the processing power to decode and playback downloaded, digital video signals. For the same reasons, it is also not clear how the originally disclosed, incoming RAM 50c and playback RAM 50d could have supported storage of downloaded video and playback.

¹⁴ See "The History of Recordings", Recording Industry of Association, retrieved from <http://www.riaa.com/issues/audio/history.asp> on September 19, 2006. See also the "History of CD Technology", citing as a source "The compact Disc Handbook, 2nd Edition," by Ken C. Pohlmann, retrieved from <http://www.oneoffcd.com/info/historycd.cfm> on September 19, 2006.

¹⁵ See the "History of MPEG", University of California, Berkeley, School of Information Management and Systems, retrieved from <http://www2.sims.berkeley.edu/courses/is224/s99/GroupG/report1.html> on September 19, 2006. See also the "History of

Further regarding the equipment of the user (consumer), in 1988 a large capacity drive for a user (e.g., 3.5 inch form factor) was around 30 megabytes¹⁶, yet the digital bandwidth required to transmit a video signal at even VHS quality was 1.5 megabits per second (approximately 30 megabytes in 3 minutes) and this even using a Moving Picture Coding Experts Group Standard "1" ("MPEG-1") video compression technology not even available in 1988.¹⁷ Thus, it is not clear how a how downloaded video files of any appreciable or viable size would have been downloaded and stored on originally disclosed hard disk 60 of the user in the original specification.

Regarding the equipment used at the library (server), even large mainframe computers (e.g., IBM mainframe computers) typically only provided hard drives with capacity well below 10 gigabytes.¹⁸ Thus, it is not clear how even a small-sized video library, with its steep bandwidth (storage) requirements (as discussed above), would have been stored in the hard disk 10 of the copyright holder in the original specification, without requiring details directed toward a complex mainframe operating environment.

Regarding the transfer of these large video files over a network, the proliferation of broadband communication network capable of delivering these large files to consumers, such as the Internet, simply did not exist or were not well known in 1988. Furthermore, it is not clear

CD Technology", citing as a source "The compact Disc Handbook, 2nd Edition," by Ken C. Pohlmann, retrieved from <http://www.oneoffcd.com/info/hisotrycd.cfm> on September 19, 2006.

¹⁶ See "IBM HDD Evolution" chart, by Ed Grochowski at Almaden, retrieved from http://www.soragereview.com/guideImages/z_ibm_sorageevolution.gif on September 19, 2006.

¹⁷ See the "History of MPEG", University of California, Berkeley, School of Information Management and Systems, retrieved from <http://www2.sims.berkeley.edu/courses/is224/s99/GroupG/report1.html> on September 19, 2006.

¹⁸ IBM HDD Evolution chart, *supra*.

Art Unit: 3992

how the digital video would have been coded and decoded during transmission, as digital video coding standards for purposes of transmission and file downloading were not settled in 1988. As an example of the above points, the MPEG-1 standard, which was designed to code/decode digital video information and to transmit the video via a telephone (telecommunications) network in NTSC (broadcast) quality for archiving, was only established in 1992.¹⁹

Thus, based on the evidence regarding each of the above factors, the specification, at the time the Parent application was filed, would not have taught one skilled in the art how to make and/or use the full scope of the claimed invention without undue experimentation.

Claim Rejections Based on Bush

Claim Rejections - 35 USC § 103

The following is a quotation of 35 U.S.C. 103(a) which forms the basis for all obviousness rejections set forth in this Office action:

(a) A patent may not be obtained though the invention is not identically disclosed or described as set forth in section 102 of this title, if the differences between the subject matter sought to be patented and the prior art are such that the subject matter as a whole would have been obvious at the time the invention was made to a person having ordinary skill in the art to which said subject matter pertains. Patentability shall not be negated by the manner in which the invention was made.

Claims 1-6 and 44-49 are rejected under 35 U.S.C. 103(a) as being unpatentable over United States Patent No. 4,789,863 ("Bush"), of record, in view of U.S. Patent No. 4,949,187 ("Cohen"), of record.

¹⁹ History of MPEG, *supra*.

Art Unit: 3992

The filing date of the Cohen patent is December 16, 1988. The earliest priority date of the '573 patent under reexamination however is September 18, 1990, as discussed extensively above in the "Benefit of Earlier Filing Date" section. Thus, Cohen is available as 102(e) type prior art.

Regarding **claim 1**,

A method for transmitting a desired digital audio signal stored on a first memory of a first party to a second memory of a second party comprising the steps of:

Bush teaches transmitting a desired digital, audio or video signal (col. 2, ll. 18-29 and col. 3, ll. 26 - 35). The digital audio or video signals are stored on compact disc machines 41-46 (first memory) of a pay per view entertainment system provider associated with source 10 (first party) (Figs. 1, 4 and col. 2, ll. 19-47). The digital signals are transmitted via a network to the consumer's receiver 14 (Fig. 1) (also illustrated as receiver 100 in Fig. 5, see also col. 3, ll. 14-17). The signals are stored on cassette recording unit and an associated cassette tape (second memory) (Fig. 5 and col. 4, ll. 1-11). Note that the second memory is also a compact disc recorder (col. 10, claim 14) and thus the second memory is also a CD.

transferring money electronically via a telecommunication line to the first party at a location remote from the second memory and controlling use of the first memory from the second party financially distinct from the first party, said second party controlling use and in possession of the second memory;

Bush teaches that money is electronically transferred via a telephone line (telecommunications line) and clearing house 200 to the source 10 (first party) by way of a credit

Art Unit: 3992

card transaction (Fig. 3 and col. 2, ll. 58-63, col. 4, ll. 44-47, col. 5, ll. 1-3, col. 6, ll. 25-28, and ll. 45-48). The first party's location (source 10) is remote via a network from the consumer (Fig. 1). The second party (consumer) commands the download of audio/video from the memories of the first party (source 10) (Fig. 7, col. 1, ll. 59-64, and col. 6, ll. 11-48). Thus, the first memory is controlled from the second party. Clearly, the second party (consumer) is financially distinct from the first party (source 10). The second party (consumer) also controls the use and also possesses the second memory, such as by the ability to determine what contents are stored in the second memory (col. 6, ll. 11-48)

connecting electronically via a telecommunications line the first memory with the second memory such that the desired digital audio signal can pass therebetween;

The limitation broadly recites "a telecommunications line," which lacks antecedent basis to the previous recitation of a telecommunications line. The examiner interprets a "telecommunications line" to mean a electronic medium of communicating between computers, which requires end-to-end connectivity, which is an interpretation that includes the Internet and that is consistent with an interpretation advanced by the Patent Owner and adopted by the district court. Sightsound.com Inc. v. NSK, Inc. Cdnow, Inc., and Cdnow Online, Inc., Civil Action No. 98-118, pp. 50 and 57 (District Court for the Western District of Pennsylvania, Feb. 2002). Here, Bush teaches of a cable system (electronic medium) that provides end-to-end communications between computer at the central cable system associated with source 10 and the

Art Unit: 3992

consumer's computer (Figs. 1, 2 and 5). The audio and video files are downloaded via the telecommunications line and thus connect the first and second memories, as discussed above.

transmitting the desired digital audio signal from the first memory with a transmitter in control and possession of the first party to a receiver having the second memory at a location determined by the second party, said receiver in possession and control of the second party; and

The desired digital audio or video signal is transmitted from the first memory as discussed above using a transmitter (Fig. 4, CADA transceiver 40) in control (col. 2, ll. 18-21) and possession of the first party, such as when the first party (source 10) determines what contents are stored in the first memory (col. 2, ll. 30-42). The second party (consumer) determines the location to which the audio/video data is transmitted as broadly recited by the claims, such as the consumer operates the invention by turning on the television and interacts with the pay per view channel at a location (e.g., consumer's home) determined by the consumer. The receiver 14 includes a cassette tape (or CD) (as discussed above) that is in possession and control of the second party (col. 1, ll. 59-64).

storing the digital signal in a non-volatile storage portion of the second memory, wherein the non-volatile storage portion is not a tape or a CD.

The received audio/video digital signal is stored in the second memory (cassette tape or CD) associated with the second party (consumer) as discussed above (i.e., a non-volatile storage portion of the second memory). See also col. 5, ll. 24-52.

Art Unit: 3992

Bush however fails to disclose that the non-volatile storage is "not a tape or a CD."

Cohen however (similarly to Bush, see the section 102 claim rejections based on Cohen in this Office action for additional details) teaches of an audio and video downloading system that also uses a magnetic, hard disk (non-volatile storage that is not or a CD) (col. 4, l. 64 – col. 5, l. 4).

The suggestion/motivation for adding the hard disk as taught by Cohen to Bush would have been to more efficiently access audio and video files because "magnetic media, such as hard disk drives....permit an almost unlimited number of read/write cycles...." (Cohen, col. 4, ll. 3-7). Storing data on magnetic media, such as a hard-disk, would have also increased the security and reliability of the stored data because magnetic, hard disks retain data when the power to the unit is removed (i.e., non-volatile) as would have been notoriously well-known in the art at the time the invention was made.

Therefore, to one of ordinary skill in the art at the time the invention was made, it would have been obvious to add a hard disk as taught by Cohen to the system taught by Bush.

Claim 4 differs substantively from claim 1 in that claim 4 recites that digital "video" signal is transmitted (downloaded) as opposed to the audio signal in claim 1. However, the claim 1 rejection clearly explained how Bush teaches that both audio and video digital signals are downloaded. Therefore, see the claim 1 rejection for additional details.

Claims 44 and 47 differ substantively from claims 1 and 4 in that claims 44 and 47 recite specifically that the second memory includes a second party hard disk. This limitation was addressed in the claim 1 rejection above regarding the obvious addition of a hard disk. Therefore, see the claims 1 and 4 rejections above for additional details.

Regarding **claims 2, 5, 45, and 48**, after the money transfer step, the recording system searches for a recording signal from the remote library (e.g., forward and reverse roll commands) and then for a subsequent video/audio file from the remote library for the purposes of recording, where the video/audio file is stored in the first memory, as discussed above (col. 5, ll. 35-44 and col. 6, ll. 23-48).

Regarding **claims 3, 6, 46, and 49**, Bush teaches of a system for downloading audio and video files from a central library to a user, where the user pays for the audio files and stores the audio files (abstract and Figs. 1 and 6). Bush also teaches that the user provides a credit card number to the second party (library) (col. 4, ll. 44-47, col. 5, ll. 1-3, col. 6, ll. 25-28, and ll. 45-48).

Claim Rejections Based on Freeny

Claim Rejections - 35 USC § 102

Claims 1-6 and 44-49 are rejected under 35 U.S.C. 103(a) as being unpatentable over Bush in view of U.S. Patent No. 4,837,797 ("Freeny"), of record.

The claim rejections based on Bush in view Freeny differ from the claim rejections based on Bush in view of Cohen above in that Freeny, instead of Cohen, is relied upon to teach a non-volatile storage portion of the second memory that is not a tape or a CD (e.g., a hard disk). Freeny however is available as 102(e) prior art regardless of the effective filing date of the '573 patent. See the Bush in view Cohen rejection above for additional details regarding the specific teachings of Bush.

Freeny (similarly to Bush) teaches of a device that receives and stores audio data (abstract) and that also stores the received messages on a non-volatile storage portion that is not a tape or a CD (e.g., a hard disk) (col. 5, ll. 20-25).

The suggestion/motivation for adding the hard disk as taught by Cohen to Bush would have been to more efficiently access audio and video files because magnetic media, such as hard disk drives permit an almost unlimited number of read/write cycles. Storing data on magnetic media, such as a hard-disk, would have also increased the security and reliability of the stored data because magnetic, hard disks retain data when the power to the unit is removed (i.e., non-volatile) as would have been notoriously well-known in the art at the time the invention was made.

Therefore, to one of ordinary skill in the art at the time the invention was made, it would have been obvious to add a hard disk as taught by Freeny to the system taught by Bush.

Claim Rejections Based on Cohen

Claim Rejections - 35 USC § 102

Claims 1, 2, 4, 5, 44, 45, 47, and 48 are rejected under 35 U.S.C. 102(e) as being anticipated by Cohen.

The filing date of the Cohen patent is December 16, 1988. The earliest priority date of the '573 patent under reexamination however is September 18, 1990, as discussed extensively above in the "Benefit of Earlier Filing Date" section. Thus, Cohen is available as 102(e) type prior art.

With respect to **claim 1**, Cohen clearly teaches a method for transmitting a desired digital movie signal (abstract) comprising video and audio components (col. 1, ll. 7-12 and ll. 46-50) of a first party (central source of audio and video data, Fig. 4) to a second memory (disk storage system 114) of a second party (home viewer) (abstract). Money is electronically transferred via a telephone (telecommunication) line, where the first (central source) and second party (home viewer) is clearly financially distinct (abstract and Fig. 4, telephone line 60). The desired digital movie (video and audio) is in the first memory (principal on line movie storage 12-26, Fig. 4) is connected to and transferred via the telephone (telecommunications) line 60 to the second memory (disk storage system 114), where it is stored (col. 4, ll. 1-68). The digital signal is stored in a non-volatile storage portion of the second memory, that is not a tape or a CD (i.e., the hard disk) (col. 4, l. 64 – col. 5, l. 4).

Art Unit: 3992

Claim 4 differs substantively from claim 1 in that claim 4 recites that digital "video" signal is transmitted (downloaded) as opposed to the audio signal in claim 1. However, the claim 1 rejection clearly explained how Cohen teaches that both audio and video digital signals are downloaded. Therefore, see the claim 1 rejection for additional details.

Claims 44 and 47 differ substantively from claims 1 and 4 in that claims 44 and 47 recite specifically that the second memory includes a second party hard disk. This limitation was addressed in the claim 1 rejection above. Therefore, see the claims 1 and 4 rejections above for additional details.

Regarding **claims 2, 5, 45, and 48**, see col. 4, ll. 19-29 and ll. 47-63, where after the money transfer (accounting) step, the system searches for the desired selection by the home viewer and commences downloading.

Claim Rejections - 35 USC § 103

Claims 3, 6, 46, and 49 are rejected under 35 U.S.C. 103(a) as being unpatentable over Cohen as applied to the claims above, and further in view of Bush.

Cohen teaches of telephoning the first party controlling use of the first memory and transferring money (as discussed above in the claim 1 rejection). Cohen however fails to teach providing a credit card number of the second party.

Art Unit: 3992

Bush teaches (similarly to Cohen, see the Bush, claim 1 rejection above) of a system for downloading audio and video files from a central library to a user, where the user pays for the audio files and stores the audio files (abstract and Figs. 1 and 6). Bush also teaches that the user provides a credit card number to the second party (library) (col. 4, ll. 44-47, col. 5, ll. 1-3, col. 6, ll. 25-28, and ll. 45-48).

The suggestion/motivation for providing a credit card number to the second party would be to reduce the expenses involved in operating a download service, because financial service organizations, such as credit card organizations, "enable the source 10 to [be] paid be a service fee for the subscriber's use of the system." Bush, col. 2, ll. 58-63. Obviously, providing a credit card number would have been required to use the services of a credit card organization.

Therefore, it would have been obvious to one of ordinary skill in the art at the time the invention was made to add the step of the user providing a credit number to the second party as taught by the audio/video download system of Bush to the audio/video download of Cohen, which teaches that the user pays for the download.

Claim Rejections Based on Akashi

Claim Rejections - 35 USC § 103

Claims 1-6 and 44-49 are rejected under 35 U.S.C. 103(a) as being unpatentable over Japanese Patent Application No. 62-284496 ("Akashi") using the English translation of record, in view Freeny.

Regarding claims 1, 3, 4, 6, 44, 46, 47, and 49, Akashi discloses a system for automatically selling recorded music via telecommunication lines (Page 1 through line 1 of Page 2). This system utilizes the telecommunications lines to transmit the recorded music data from a host computer that stores the recorded music data to a personal computer (Page 2 Section 4), which meets the limitation of connecting electronically via telecommunications line the first memory with the second memory such that the desired digital audio signal can pass therebetween, transmitting the desired digital audio signal from the first memory with a transmitter in control and possession of the first party to a receiver having the second memory at a location determined by the second party, said receiver in possession and control of the second party, storing the digital signal in the second memory.

Akashi discloses that the digital music data is purchased automatically but does not expressly detail how the purchase is transacted and whether the data is stored on a non-volatile storage portion of the second memory that is not a tape or a CD.

Freeny discloses a method of electronically distributing and selling audio and video data by way of having the requesting user transmit a consumer credit card number along with their request for the audio and video data (Col. 13, lines 25-29). This step allows the owner of the data to approve the sale and charge the sale to the consumer credit card number (Col. 13, lines 30-31), which meets the limitation of transferring money electronically via a telecommunications lines to the first party at a location remote from the second memory and controlling use of the first

Art Unit: 3992

memory from the second party financially distinct from the first party, said second party controlling use and in possession of the second memory, the transferring step includes the steps of telephoning the first party controlling use of the first memory by the second party, providing a credit card number of the second party controlling the second memory to the first party controlling the first memory so the second party is charged money. Freeny also discloses that the received audio and video data is stored on a non-volatile storage that is not a tape or CD (e.g., a hard disk) (col. 5, l. 23-25).

The suggestion/motivation for combining Akashi with Freeny would have been because this method of electronic sale allows the owner of the information to receive directly the compensation for sale of recording and such compensation is received before the reproduction is authorized as taught in Freeny (Col. 13, lines 36-39). The use of a hard disk would have allowed the user to more efficiently access audio and video files because magnetic media, such as hard disk drives, permit an almost unlimited number of read/write cycles. Furthermore, storing data on magnetic media, such as a hard-disk, would have also increased the security and reliability of the stored data because magnetic, hard disks retain data when the power to the unit is removed (i.e., non-volatile) as would have been notoriously well-known in the art at the time the invention was made.

Therefore, it would have been obvious to one of ordinary skill in the art at the time the invention was made to have the requesting user's of Akashi transmit a consumer credit card number along with their request for the digital data so that the source unit could approve and

Art Unit: 3992

charge the sale of the digital data to the consumer credit card and to store the received audio and video data on a hard disk (non-volatile storage that is not a tape or CD) as taught by Freeny.

Regarding **claims 2, 5, 45, and 48**, Akashi discloses that personal computer contains a CPU (Figure 1). The personal computer sends an access signal to the host computer, and the host computer returns a response signal that contains menu data displayed at the personal computer (Page 3 Paragraph 6). Using the monitor screen, the user chooses desired data using a control unit and sending the selection data to the host computer in the same way the initial transmission was sent (Page 4 Paragraph 1), which meets the limitation of the steps of searching the first memory for the desired digital audio signal and selecting the desired digital audio signal from the first memory.

Response to Arguments

The Office has Jurisdiction to Apply Intervening Patents and Printed Publications in a Reexamination Proceeding To a Patent that Seeks the Section 120 Benefit to the Filing Date of an Earlier Filed Application

On page 10 of the Amendment, the Patent Owner argues that the Office lacks jurisdiction in reexaminations to reassign priority dates for originally issued claims in the absence of a previous continuation-in-part application. Specifically, the Patent Owner argues that it is "impermissible, in the context of a reexamination, to apply 35 U.S.C. § 120 to reassign priority dates for originally issued claims."

Art Unit: 3992

Although the Patent Owner's arguments have been carefully considered, they are not deemed persuasive. A rejection may be made in an *ex-parte* reexamination proceeding based on an intervening patent when the patent claims under reexamination, under 35 U.S.C. 120, are entitled only to the filing date of the patent under reexamination. Specifically:

Rejections may be made in reexamination proceedings based on intervening patents or printed publications where the patent claims under reexamination are entitled only to the filing date of the patent and are not supported by an earlier foreign or United States patent application whose filing date is claimed. For example, under 35 U.S.C. 120, the effective date of these claims would be the filing date of the application which resulted in the patent. Intervening patents or printed publications are available as prior art under *In re Ruscetta*, 255 F.2d 687, 118 USPQ 101 (CCPA 1958), and *In re van Langenhoven*, 458 F.2d 132, 173 USPQ 426 (CCPA 1972). See also MPEP § 201.11

MPEP § 2258.I.C, Scope of Reexamination (emphasis added). See also MPEP § 2217.

Furthermore, no priority dates have been "reassigned" by the examiner, rather the examiner simply applied an intervening reference. When an application claims section 120 benefit to an earlier filed application (e.g. continuations, continuations-in-part), the examiner may use an intervening reference (e.g., a printed publication or patent pre-dating the actual filing date of the application, but post-dating the filing date of the different, parent application to which benefit is sought) in a rejection based on the actual filing date of an application claiming section 120 benefit. The Patent Owner may then correct the benefit claim or show that the conditions for claiming benefit to the priority date have been met. MPEP 201.11.

The Patent Owner next argues on page 10:

It is well established that the primary determination under Section 120 is whether priority is claimed to an earlier application that "fulfills the requirements of Section 112, first paragraph." *Callicrate v. Wadsworth Mfg.*, 427 F.3d 1361, 1373 (Fed. Cir. 2005) (citation omitted). It equally is well established, however, that the scope of a reexamination proceeding is limited to whether

Art Unit: 3992

claims are patentable under 35 U.S.C. §§ 102 and 103 "on the basis of patents and printed publications." 37 C.F.R. § 1.552. The reexamination rules explicitly preclude consideration of issues arising under 35 U.S.C. § 112, except "with respect to subject matter added or deleted in the reexamination proceeding." *Id.*; see also *In re Etter*, 756 F.2d 852, 856 (Fed. Cir. 1985) (en banc) ("only new or amended claims are also examined under 35 U.S.C. §§ 112 and 132").

Although the Patent Owner's arguments have been carefully considered, they are not deemed persuasive. Applying 35 U.S.C. § 120 neither requires nor implies that the specification of the '573 patent under reexamination is itself being subjected to a 35 U.S.C. § 112 analysis. Indeed, none of the original six patent claims of the '573 patent have been rejected pursuant to section 112. Rather it is the specification(s) of the Parent application that is being analyzed on that basis. For example, the examiner has taken the position that the Parent application, as originally filed, does not describe certain features recited in the claims of the instant '573 patent under reexamination. The examiner does not argue that the specification, including the claims, of '573 patent under reexamination fails to establish possession of the claimed invention, but rather whether possession of the claimed invention was established before the filing date of the '573 patent in a different U.S. application.

The 35 U.S.C. 102 and 103 rejections based on the intervening patents and publications are also, clearly, an inquiry into patentability "on the basis of patents and printed publications."

Art Unit: 3992

An Inquiry Under Section 120 Does Not Revisit Any Substantial Question of Patentability Necessarily Raised and Previously Decided by the Examiner During Prosecution of the Application Corresponding to the '573 Patent

On page 11 of the Amendment, the Patent Owner argues that an:

[I]nquiry under Section 120 as to whether the language of a particular claim, as filed or amended during an original prosecution, was supported or unsupported by sufficient disclosure is, by definition, not a *new* question.

Although the Patent Owner's arguments have been carefully considered, they are not deemed persuasive. A substantial new question of patentability was raised in this proceeding based on prior patents or printed publications identified in the Request for Reexamination, filed on January 31, 2005 (and as detailed in the Order Granting the Request for *Ex Parte* Reexamination, mailed March 18, 2005). Therefore, the issue of whether a 35 U.S.C. 120 inquiry raises a substantial new question of patentability is irrelevant.

Nonetheless, an inquiry under section 120 does not revisit any substantial question of patentability previously decided by the examiner during prosecution of the application corresponding to the '573 patent. Substantial questions of patentability are "old" only in respect to previously considered patents or printed publications, i.e., those questions based on "old art." See MPEP 2242.II. The intervening patents applied in this reexamination proceeding were not previously considered during prosecution of application leading to the '573 patent under reexamination, and thus do not raise questions of patentability previously considered by the original examiner.

The Patent Owner next argues on page 11:

Rather, it is an issue that necessarily arises at the time of original filing or amendment, and one that necessarily is before the original examiner. It cannot, therefore, raise a "substantial new question of patentability in reexamination," 35 U.S.C. § 303, because it is never a "new question" at all.

Although the Patent Owner's arguments have been carefully considered, they are not deemed persuasive. A section 120 issue does not "necessarily" arise, as argued by the Patent Owner above, during prosecution of the application leading to patent, thereby precluding all further consideration of priority issues by the Office after the patent issues. For example, in addition to the MPEP § 2258.I.C. as discussed above, the Patent Owner himself may request a reexamination proceeding to correct a failure to adequately claim benefit under 35 U.S.C. 120, see MPEP § 2258.IV.E. Priority issues can also be considered in reissue proceedings, see MPEP § 1402. The inclusion of prior application information in the patent does not necessarily indicate that the claims are entitled to the benefit of the earlier filing date, and furthermore notations in the file history regarding prior application information are only evaluated to ensure that the data itself is accurate, not necessarily that the Patent Owner is entitled to the benefit of the earlier filing date. MPEP § 202.02.

The examiner had no reason to consider the propriety of a benefit claim under section 120 during prosecution of the application leading to the '573 patent under reexamination. The examiner would not have determined the sufficiency of the Parent specification, as originally filed, which is at issue here, unless provoked by a need to use an intervening reference. For example, the prosecution history of the '573 patent reveals that it would have been unnecessary

Art Unit: 3992

for the examiner to have reviewed the particular issue of whether a different, earlier filed application established possession of the claims recited in the '573 patent, since no intervening references (e.g., documents pre-dating the actual filing date of the '573 patent, but post-dating the filing date of the Parent application) were cited of record.

Ruscetta and Langenhoven Nowhere Hold That Priority Determinations Under 35 U.S.C. 120 Are Limited To Continuation-in-Part applications, Nonetheless, the Application Corresponding to the '573 Patent Shares the Characteristics of a Continuation-in-Part in its Relationship to the Originally Filed, Parent Application

On page 11 of the Amendment, the Patent Owner argues that MPEP §§ 2258.I.C. and 2217 should be limited to situations where there was a continuation-in-part ("CIP") application because both of the cases cited for support are cases involving CIP(s), namely *In re Ruscetta*, 255 F.2d 687 (CCPA 1958) and *In re van Langenhoven*, 458 F.2d 132 (CCPA 1972).

Although the Patent Owner's arguments have been carefully considered, they are not deemed persuasive. As extensively discussed in the "Benefit of Earlier Filing Date" section above, a review of the prosecution history provides clear and objective evidence that a significant amount of new text (directed to various features) was added in a series of amendments to the application corresponding to the '573 patent that was not present in the originally filed, Parent application. See for example, Tables I and II *supra*. Thus, the '537 patent being reexamined and the specification of the original, Parent application are not congruent, that is, they do not contain the same disclosure with respect to claim support issues. Thus, the application corresponding to the '573 patent shares the characteristics of a continuation-in-part in

its relationship to the originally filed, Parent application. See 37 CFR 1.53.b.2 and MPEP § 201.08.

Nonetheless, Ruscetta and Langenhoven nowhere hold that priority determinations under 35 U.S.C. 120 should be limited to continuation-in-part applications. Instead, both cases are directed to the use of intervening references against the claims of an application that seek the benefit of priority to an earlier filed application under 35 U.S.C. 120. The ability to use an intervening reference is not limited to continuation-in-part applications, but applies to any later filed application claiming benefit of a prior application under 35 U.S.C. 120, such as continuation applications. See MPEP § 201.11, "Claiming the Benefit of an Earlier Filing Date Under 35 U.S.C. 120 and 119(e)"....(B)... [t]he examiner may use an intervening reference in a rejection until applicant corrects the benefit claim or shows that the conditions for claiming the benefit of the prior application have been met." Both continuation and continuations-in-part applications are also related in that they both rely on priority under 35 U.S.C. 120 to obtain the benefit of an earlier filing date. MPEP § 201.11 Furthermore, continuation-in-part applications are related to continuation applications as a "continuing applications" under 37 CFR 1.53(b). Indeed, the application corresponding to the '573 patent under reexamination was filed under the old "file wrapper continuation" procedure, under which both continuation and continuation-in-part applications were filed under the same rule, 37 CFR 1.62. MPEP § 201.06(b), referring to MPEP, 8th Ed., 1st Revision, February 2003. http://www.uspto.gov/web/offices/pac/mpep/mpep_e8r1_0200.pdf). Here, the present reexamination proceeding uses intervening references against the claims of an alleged continuing

Art Unit: 3992

application (the '573 patent) that seeks the benefit of priority to an earlier filed application under 35 U.S.C. 120, which is similar to the issues discussed in the Ruscetta and Langenhoven cases.

The Use of Intervening Reference Is Not Limited to Continuation-in-Part Applications, but Applies To Any Later Filed Application Claiming Priority Benefit To a Prior Application under 35 U.S.C. 120, such as Continuation Applications.

On pages 12 and 13 of the Amendment, the Patent Owner argues that examiner lacks the authority to reassign priority dates in the present reexamination proceeding because the original examiner lacked the authority to do so. Specifically, the Patent Owner argues that the original examiner "could not – and did not – reassign priority dates to the original claims" because "if the applicant does not overcome the objection and rejection the applicant has the option of refiling the application as a CIP...." that "in the absence of a CIP an original examiner cannot simply elect to assign a later effective priority date." "Such a procedure would amount to creation of a 'de facto CIP' by the original examiner, and undertaking plainly unsupported by statute, regulation, case law, or MPEP provision, or any other authority or precedent."

Although the Patent Owner's arguments have been carefully considered, they are not deemed persuasive.

First it is noted that the Patent Owner admits that the original examiner did not address the issue of whether to apply intervening references against the original claims. Thus, the use of intervening references is an open question that will be addressed in this reexamination proceeding.

Second, the ability to use an intervening reference is not limited to continuation-in-part applications, but applies to any later filed application claiming benefit of a prior application under 35 U.S.C. 120, such as continuation applications, as discussed extensively above. See again MPEP § 201.11. If the claims in the later-filed application are not entitled to the benefit of an earlier filing date under section 120, then the examiner should:

conduct a prior art search based on the actual filing date of the application instead of the earlier filing date. The examiner may use an intervening reference in a rejection until applicant corrects the benefit claim or shows that the conditions for claiming the benefit of the prior application have been met. The effective filing date of the later-filed application is the actual filing date of the later-filed application, not the filing date of the prior-filed application.

MPEP § 201.11 (emphasis added).

Thus, the present (and original) examiner has (had) the authority to apply an intervening reference by relying upon the actual filing date of the application corresponding to the '573 patent until the Patent Owner corrects the section 120 benefit claim or shows that the conditions for claiming benefit of the prior application have been met, even though the original examiner did not exercise such authority, as admitted to by the Patent Owner above and based on the prosecution history as discussed extensively above.

Art Unit: 3992

The Original Examiner Did Not Address the Specification as Originally Filed in the '573 Specification, Much Less the Specification as Originally Filed in the Parent Application

On pages 13-16 of the Amendment, the Patent Owner argues that the original examiner did "consider the various additions to the specification and concluded those additions did not constitute new matter and the subject claims therefore were supported under Section 112...." The Patent Owner also refers to a Declaration filed under 37 CFR 1.132 and to a chart on pages 14 and 15 of the Amendment.

Although the Patent Owner's arguments have been carefully considered, they are not deemed persuasive. Although the examiner addressed new matter issues in a non-final rejection in the Child application, mailed on February 24, 1992 (as the Patent Owner provided chart demonstrates), these new matter issues were in response to one amendment filed on December 11, 1991, where by the way, both the examiner and Patent Owner only touched upon a subset of the new matter issues described in Table I above. A series of amendments to the specification and claims were filed previously and subsequently to this single amendment in the Parent and Child applications, where each amendment gradually added new matter. See Table II, *supra*. Therefore, it is not clear whether the examiner addressed this issue in regard to the specification as originally filed in the Child application from which the '573 patent issued, much less in regard to the specification as originally filed in the Parent application, which is at issue here. That is, the consideration of any new matter in the December 11, 1991 amendment does not relate back to the specification as originally filed in the Parent application. For the same reasons, the consideration of any issues in the Declaration, filed on June 25, 1992 would also fail to relate back to the Parent application as originally filed (even if the Declaration were considered

Art Unit: 3992

persuasive, which it is not, as discussed in the "Benefit of Earlier Filing Date" above). Thus, the prosecution history provides further evidence that the examiner did not consider support in the specification as originally filed in the Parent application.

Patlex Makes Clear that It Does Not Apply to Situations Where the Sufficiency of the Parent Application Has Not Been Decided, Furthermore the Facts in the Patlex Case Differ Considerably from the Facts in the Instant Reexamination Proceeding

On pages 16 and 17 of the Amendment, the Patent Owner argues that in Patlex v. Quiqq, 680 F.Supp. 33, 6 USPQ2d 1296 (D.D.C. 1988), the United States District Court for the district of Columbia "addressed a situation substantially identical to the circumstances of the present reexamination" and held that where "an original examiner already has considered and determined the sufficiency of the specification's disclosure under Section 112 and the resulting entitlement of claims to an original priority date, there is no 'substantial new' question of patentability for reexamination..." and thus the "Office lacks jurisdiction to 'reexamine' that same issue for those same claims in a subsequent reexamination proceeding."

Although the Patent Owner's arguments have been carefully considered, they are not deemed persuasive. The holding relied on by the Patent Owner reads, in full, "hence, the Court concludes that the examiner and the Board lacked jurisdiction in this case to 'reexamine' the sufficiency of the specification of the 'great-grandparent' application." (Emphasis added). Id., at 37, at 1299. Obviously, this is not a broad holding that a 35 U.S.C. § 120 benefit claim can never be "reexamined" in a reexamination proceeding. Indeed, the Patlex court specifically, and rather clearly, went on to state that the "Court wishes to make clear that it is not deciding

Art Unit: 3992

whether the Commissioner has jurisdiction in a reexamination to inquire into the sufficiency of the specification of a "parent" application where the sufficiency of the "parent" application vis-a-vis the claims of the patent being reexamined was not previously determined by the PTO or a court."²⁰ As discussed extensively above, the original examiner did not consider and determine the sufficiency of the specification in the originally filed, Parent application for the purposes of priority under 35 U.S.C. 120.

Indeed, the facts in the instant reexamination proceeding differ considerably from the facts in Patlex. In Patlex, the Court found that the issues were based upon the fact that the specification of the patent being reexamined was "essentially identical" to the specification of the great-grandparent application for which section 120 benefit was claimed (Id., at 34, at 1297) and that the claims of the great-grandparent were "directed essentially to the invention for [the patent being reexamined]." (Id. at 36, at 1299). As discussed extensively above in the "Benefit of Earlier Filing Date" sections (see Tables I and II), the specification and the claims of the patent being reexamined are substantially different from the specification and claims of the original, Parent application for which section 120 benefit was claimed. A series of amendments subsequent the filing of the original, Parent application has added a substantial amount of new text to the specification and claims of both the parent application and the Child application, which issued as the '573 patent.

²⁰ In another example, the Federal Circuit recently upheld a priority determination based upon a written description analysis raised by the Office during a reexamination proceeding initiated based on prior art raising a new question of patentability. In re Curtis, 354 F.3d 1347 (Fed. Cir. 2004). See also In re Modine and Guntly, 2001 WL 898541 (Fed. Cir. 2001) (unpublished) (finding lack of priority to an ancestor application during a reexamination of a patent where the reexam was initiated based on prior art raising a new question of patentability).

If a Claim Limitation Is Not Necessarily Disclosed in (Required by) the Written Description of the Originally Filed, Parent Application, It Is Not Present in the Written Description

On pages 18-21 of the Amendment, the Patent Owner argues that the "requirement of an inherency standard under Section 112 is unsupported by *Hyatt, Robertson, or Lockwood*."

Although the Patent Owner's arguments have been carefully considered, they are not deemed persuasive. The case of *Hyatt v. Boone*, 146 F.3d 1348, 47 USPQ2d 1128 (Fed. Cir. 1998) (emphasis added) (Certiorari Denied), to which the Patent Owner refers to approvingly, is clear in this matter. When an explicit limitation in a claim "is not present in the written description whose benefit is sought it must be shown that a person of ordinary skill would have understood, at the time the patent application was filed, that the description requires that limitation." *Id.* at 1353 (emphasis added). "It is 'not a question of whether one skilled in the art might be able to construct the patentee's device from the teachings of the disclosure...Rather, it is a question whether the application necessarily discloses that particular device." *Id.* at 1353-4 (quoting from *Jepson v. Coleman*, 50 C.C.P.A. 1051, 314 F.2d 533, 536, 136 USPQ 647, 649-50 (CCPA 1963)) (emphasis added). The "written description must include all of the limitations...or the applicant must show that any absent text is necessarily comprehended in the description provided and would have been so understood at the time the patent application was filed." *Id.* at 1354-55 (emphasis added).

The case of In re Roberston, 169, F.3d 743, 49 USPQ2d 1949 (Fed. Cir. 1999) was cited for its holding that "missing descriptive matter" that is "necessarily present" also goes to inherency. Id. at 745 (emphasis added).

The case of Lockwood v. American Airlines, Inc., 107 F.3d 1565, 41 USPQ2d 1961 (Fed. Cir. 1997) was cited to emphasize that, although the written description requirement requires that the application necessarily discloses a particular device to one of ordinary skill in the art at the time the application was filed, such a test should not devolve into an inquiry that "combined with the knowledge in the art, would lead one to speculate as to modifications that the inventor might have envisioned, but failed to disclosed. Id. at 1571.

Thus, when an explicit limitation in a claim is not present in the written description whose benefit is sought, such a limitation must be required (necessarily disclosed) by the written description. Thus, if the said limitation is not necessarily disclosed in (required by) the written description, it is not present in the written description.

Certain Claim Limitations Addressed in the Patent Owner's Claim Support Chart Are Not Necessarily Disclosed (Required by) the Written Description of the Originally Filed, Parent Application, and Thus Are Not Present in the Original, Written Description

On pages 21-26 of the Amendment, the Patent Owner provides a chart to show that all of the limitations in claims 1-6 and 44-49 of the '573 patent were supported by the originally filed, Parent application.

Art Unit: 3992

Although the Patent Owner's arguments have been duly considered, they are not deemed persuasive. While the chart is certainly appreciated, certain of the claim limitations addressed in the chart are not necessarily disclosed (required by) the written description of the originally filed, Parent application, and thus are not present in the said written description, as extensively discussed by the examiner in the "Benefit of Earlier Filing Date" section *supra*. Thus, the effective filing date (priority) of the instant '573 patent under reexamination remains the latest date at which time the priority chain was broken, namely September 18, 1990 (at the earliest), which is also the actually filing date of the '573 patent.

The Enablement Rejection of Newly Added, Video Download Feature Is Based on Factors, such as Undue Experimentation, and Not upon a "Mass Production" Standard as Argued by the Patent Owner

On pages 27-30 of the Amendment, the Patent Owner argues that, regarding the enablement of various video features recited in claims 4 through 6 by the Parent application, as originally filed, the Office is attempting to apply a "mass production" standard when, "in actuality, the enablement standard of Section 112 has no such requirement."

Although the Patent Owner's arguments have been duly considered, they are not deemed persuasive. Claims 4 through 6 were not rejected under a 35 U.S.C., 112, 1st paragraph, enablement rejection. Nonetheless, the examiner of rejection under the enablement requirement of those newly introduced claims reciting a video download feature was explicitly based upon an undue experimentation factor. Nothing was stated about a "mass production" requirement. For example, the originally filed, Parent application teaches that data (not specifically video data) is

Art Unit: 3992

transmitted via a telephone line. Yet the MPEG-1 standard, which was designed to code/decode digital video information and to transmit the video via a telephone (telecommunications) network in NTSC (broadcast) quality for archiving, was only established in 1992. See the 35 U.S.C. 112, 1st paragraph rejection *supra* for additional details. Thus, digital video coding standards for purposes of transmission and file downloading over a telephone line were not settled in 1988. Thus, it would not have been clear to one of ordinary skill how the digital video would have been coded and decoded during transmission over a telephone line. Such a question does not relate to mass production, but whether a single video downloading system as claimed could be made or used without undue experimentation by one of ordinary skill in the art in 1988 facing a lack of industry standards for transmitting digital, video data via a telephone line and also facing a limited disclosure of any video features whatsoever (except for the general statements at the end of the specification regarding video applicability) in the originally filed, Parent application.

Yurt, Goldwasser, and Cohen Are Available of Prior Art Patents

On pages 32-35 of the Amendment, the Patent Owner argues that Yurt, Goldwasser, and Cohen are not available as prior art patents. The publication date of the Yurt patent however is July 21, 1992. The earliest priority date of the '573 Patent under reexamination however is September 18, 1990, as discussed extensively above in the "Benefit of Earlier Filing Date" section. Thus, Yurt is available as both 102(b) and 102(e) type prior art. For similar reasons, Goldwasser and Cohen are also available as prior art.

Art Unit: 3992

Patent Owner arguments regarding Bush, Akashi, and Freeny regarding their failure to teach a nonvolatile storage that is not a tape or CD are unpersuasive. For example, Freeny discloses the use of a hard disk (non-volatile storage not a tape or CD) to store the received files, as discussed above. The failure of Bush or Akashi to teach storing the received files on a hard disk cannot be reasonably interpreted as "teaching away" from the use of a hard disk. The "prior art's mere disclosure of more than one alternative does not constitute a teaching away from any of these alternatives because such disclosure does not criticize, discredit, or otherwise discourage the solution claimed. ..." In re Fulton, 391 F.3d 1195, 1201, 73 USPQ2d 1141, 1146 (Fed. Cir. 2004). MPEP 2145.X.D.1. Here, Bush does not criticize, discredit, or discourage the use of a hard disk and is therefore insufficient to teach away from the prior art's suggestion that a hard disk could be used to store received files. For example, Cohen, which was an obvious addition to Bush as applied above, teaches of (an explicitly provides a suggestion/motivation for) using a hard disk to store received files.

Response to Declarations

Several Declarations were filed by the Patent Owner on December 27, 2005. These Declarations were considered, but are not deemed persuasive. The Declarations by Justin Douglas Tygar, Ph.D. and Arthur R. Hair appear to argue support features generally, but do not specifically relate to the new matter issues caused by the gradual and repeated introduction of new text after the Great-grandparent application was originally filed, which is the issue here and as extensively discussed above. The Declarations by Kenneth C. Pohlmann and regarding the prior litigation are not directed to the rejections as presently formulated in this Office action.

Conclusion

The Amendment (filed on December 1, 2006) necessitated the new grounds of rejection presented in this Office action. Accordingly, **THIS ACTION IS MADE FINAL**. See MPEP § 706.07(a) and § 2271.III.

A shortened statutory period for response to this action is set to expire 2 months from the mailing date of this action.

Any amendment after a final action must include "a showing of good and sufficient reasons why the amendment is necessary and was not earlier presented" in order to be considered. See MPEP § 2260.

The filing of a timely first response to this final rejection will be construed as including a request to extend the shortened statutory period for an additional month, which will be granted even if previous extensions have been granted. In no event, however, will the statutory period for response expire later than SIX MONTHS from the mailing date of the final action. See MPEP § 2265.

Extensions of time under 37 CFR 1.136(a) will not be permitted in these proceedings because the provisions of 37 CFR 1.136 apply only to "an applicant" and not to parties in a reexamination proceeding. Further, in 35 U.S.C. 305 and in 37 CFR 1.550(a), it is required that reexamination proceedings "will be conducted with special dispatch within the Office" (37 CFR

Art Unit: 3992

1.550(a). Extension of time in *ex parte* reexamination proceedings are provided for in 37 CFR

1.550(c).

Extensions of time in reexamination proceedings are provided for in 37 CFR

1.550(c). A request for extension of time must be filed on or before the day on which a response to this action is due, and it must be accompanied by the petition fee set forth in 37 CFR 1.17(g). The mere filing of a request will not effect any extension of time. An extension of time will be granted only for sufficient cause, and for a reasonable time specified.

The patent owner is reminded of the continuing responsibility under 37 CFR 1.565(a) to apprise the Office of any litigation activity, or other prior or concurrent proceeding, involving U.S. Patent No. 5,191,573 (the "573" patent under reexamination) throughout the course of this reexamination proceeding. The third party requester is also reminded of the ability to similarly apprise the Office of any such activity or proceeding throughout the course of this reexamination proceeding. See MPEP §§ 2207, 2282 and 2286.

Art Unit: 3992

All correspondence relating to this ex parte reexamination proceeding should be directed as follows:

By U.S. Postal Service Mail to:

Mail Stop "Ex Parte Reexam"
ATTN: Central Reexamination Unit
Commissioner for Patents
P. O. Box 1450
Alexandria VA 22313-1450

By FAX to:

(571) 273-9900
Central Reexamination Unit

By hand to:

Customer Service Window
Central Reexamination Unit
Randolph Building, Lobby Level
401 Dulany Street
Alexandria, VA 22314

Any inquiry concerning this communication or earlier communications from the Reexamination Legal Advisor or Examiner, or as to the status of this proceeding, should be directed to the Central Reexamination Unit at telephone number (571) 272-7705.

Signed:



Roland G. Foster
Central Reexamination Unit, Primary Examiner
Electrical Art Unit 3992
(571) 272-7538

Conferees:



MARK J. REINHART
SPRE-AU 3992
CENTRAL REEXAMINATION UNIT



SCOTT L. WEAVER
CRU EXAMINER-AU 3992

Application Number 	Application/Contr I No. 90/007,402	Applicant(s)/Patent under Reexamination 5191573	
	Examiner Roland G. Foster	Art Unit 3992	

Index of Claims



Application/Control No.

90/007,402

Examiner

Roland G. Foster

Applicant(s)/Patent under Reexamination

5191573

Art Unit

3992

✓	Rejected
=	Allowed

—	(Thru numeral) Cancelled
+	Restricted

N	Non-Elected
I	Interference

A	Appeal
O	Objected

Claim		Date			
Final	Original	3/8/07			
	1	✓			
	2	✓			
	3	✓			
	4	✓			
	5	✓			
	6	✓			
	7				
	8				
	9				
	10				
	11				
	12				
	13				
	14				
	15				
	16				
	17				
	18				
	19				
	20				
	21				
	22				
	23				
	24				
	25				
	26				
	27				
	28				
	29				
	30				
	31				
	32				
	33				
	34				
	35				
	36				
	37				
	38				
	39				
	40				
	41				
	42				
	43				
	44	✓			
	45	✓			
	46	✓			
	47	✓			
	48	✓			
	49				
	50				

Claim		Date			
Final	Original				
	51				
	52				
	53				
	54				
	55				
	56				
	57				
	58				
	59				
	60				
	61				
	62				
	63				
	64				
	65				
	66				
	67				
	68				
	69				
	70				
	71				
	72				
	73				
	74				
	75				
	76				
	77				
	78				
	79				
	80				
	81				
	82				
	83				
	84				
	85				
	86				
	87				
	88				
	89				
	90				
	91				
	92				
	93				
	94				
	95				
	96				
	97				
	98				
	99				
	100				

Claim		Date			
Final	Original				
	101				
	102				
	103				
	104				
	105				
	106				
	107				
	108				
	109				
	110				
	111				
	112				
	113				
	114				
	115				
	116				
	117				
	118				
	119				
	120				
	121				
	122				
	123				
	124				
	125				
	126				
	127				
	128				
	129				
	130				
	131				
	132				
	133				
	134				
	135				
	136				
	137				
	138				
	139				
	140				
	141				
	142				
	143				
	144				
	145				
	146				
	147				
	148				
	149				
	150				

Search Notes



Application/Contr I No.

90/007,402

Examiner

Roland G. Foster

Applicant(s)/Patent under Reexamination

5191573

Art Unit

3992

SEARCHED

Class	Subclass	Date	Examiner

INTERFERENCE SEARCHED

Class	Subclass	Date	Examiner

**SEARCH NOTES
(INCLUDING SEARCH STRATEGY)**

	DATE	EXMR
Not Updated	3/8/2007	RGF

Litigation Search Report CRU 3999

Reexam Control No. 90/007,482

TO: James Menefee
Location: CRU
Art Unit: 3992
Date: 04/23/07
Case Serial Number: 90/007,482

From: Patricia Volpe
Location: CRU 3999
MDW 7C69
Phone: (571) 272-6825
Patricia.volpe@uspto.gov

Search Notes

Litigation was not found involving U.S. Patent Number 6,486,982

Sources:

- 1) I performed a KeyCite Search in Westlaw, which retrieves all history on the patent including any litigation.
- 2) I performed a search on the patent in Lexis CourtLink for any open dockets or closed cases.
- 3) I performed a search in Lexis in the Federal Courts and Administrative Materials databases for any cases found.
- 4) I performed a search in Lexis in the IP Journal and Periodicals database for any articles on the patent.
- 5) I performed a search in Lexis in the news databases for any articles about the patent or any articles about litigation on this patent.



Date of Printing: APR 23,2007

KEYCITE

CUS PAT 6486982 SYSTEM FOR MAKING A HOLOGRAM OF AN IMAGE BY MANIPULATING OBJECT BEAM CHARACTERISTICS TO REFLECT IMAGE DATA, Assignee: Illinois Tool Works Inc. (Nov 26, 2002)

History

- => 1 **SYSTEM FOR MAKING A HOLOGRAM OF AN IMAGE BY MANIPULATING OBJECT BEAM CHARACTERISTICS TO REFLECT IMAGE DATA, US PAT 6486982, 2002 WL 31660457 (U.S. PTO Utility Nov 26, 2002) (NO. 09/168585)**

Patent Family

- 2 MFG. HOLOGRAM, E.G. FOR IDENTITY CARD OR CREDIT CARD - MODULATING AND ANGLING OBJECT BEAMS DERIVED FROM AND INTERSECTING WITH REFERENCE LASER BEAM AT SCANNED SURFACE ACCORDING TO PIXEL DATA, DWPL 1995-179003

Assignments

- 3 ACTION: ASSIGNMENT OF ASSIGNORS INTEREST (SEE DOCUMENT FOR DETAILS). NUMBER OF PAGES: 002, DATE RECORDED: May 06, 2003
 4 ACTION: ASSIGNMENT OF ASSIGNORS INTEREST (SEE DOCUMENT FOR DETAILS). NUMBER OF PAGES: 003, DATE RECORDED: Jun 18, 2002
 5 ACTION: ASSIGNMENT OF ASSIGNORS INTEREST (SEE DOCUMENT FOR DETAILS). NUMBER OF PAGES: 004, DATE RECORDED: Oct 08, 1998

Patent Status Files

- . Request for Re-Examination, (OG date: May 17, 2005)

Prior Art

- C** 7 US PAT 4878717 APPARATUS AND METHOD FOR RAPIDLY CONSTRUCTING HOLOGRAMS, Assignee: Brown University Research Foundation, (U.S. PTO Utility 1989)
C 8 US PAT 4778262 COMPUTER AIDED HOLOGRAPHY AND HOLOGRAPHIC COMPUTER GRAPHICS, Assignee: American Bank Note Holographics, Inc., (U.S. PTO Utility 1988)
C 9 US PAT 5138471 HOLOCOMPOSER, (U.S. PTO Utility 1992)
C 10 US PAT 4498740 HOLOGRAM WRITER AND METHOD, Assignee: Aerodyne, Research, Inc., (U.S. PTO Utility 1985)
C 11 US PAT 5262879 HOLOGRAPHIC IMAGE CONVERSION METHOD FOR MAKING A CONTROLLED HOLOGRAPHIC GRATING, Assignee: Dimensional Arts. Inc., (U.S. PTO Utility 1993)
C 12 US PAT 3560071 HOLOGRAPHIC RECORDING AND VISUAL DISPLAY SYSTEMS, Assignee: Everett A Johnson;; Silverman Daniel, (U.S. PTO Utility 1971)
C 13 US PAT 4212536 HOLOGRAPHIC SUBTRACTION WITH PHASE MODULATION TO DISTINGUISH PHASE AND AMPLITUDE DIFFERENCES, Assignee: Magyar Tudományos Akademia Központi, (U.S. PTO Utility 1980)
C 14 US PAT 4498729 METHOD AND APPARATUS FOR MAKING ACHROMATIC HOLOGRAMS, Assignee: Polaroid Corporation, (U.S. PTO Utility 1985)

© Copyright 2007 West, Carswell, Sweet & Maxwell Asia and Thomson Legal & Regulatory Limited, ABN 64 058 914 668, or their Licensors. All rights reserved.

- C 15 US PAT 5119214 METHOD FOR FORMING A COMPUTER GENERATED HOLOGRAM, Assignee: Matsushita Electric Industrial Co., Ltd., (U.S. PTO Utility 1992)
- C 16 US PAT 5058992 METHOD FOR PRODUCING A DISPLAY WITH A DIFFRACTION GRATING PATTERN AND A DISPLAY PRODUCED BY THE METHOD, Assignee: Toppan Printing Co., Ltd., (U.S. PTO Utility 1991)
- C 17 US PAT 3615123 MULTIPLE EXPOSURE HOLOGRAPHIC SYSTEM, Assignee: Trw Inc., (U.S. PTO Utility 1971)
- C 18 US PAT 4655542 OPTICAL SIGNAL PROCESSING ARRANGEMENTS, Assignee: International Business Machines, (U.S. PTO Utility 1987)
- C 19 US PAT 4111519 RECORDING AND READING SYNTHETIC HOLOGRAMS, Assignee: Harris Corporation, (U.S. PTO Utility 1978)
- C 20 US PAT 3746783 SHUTTERLESS PLAYBACK DEVICE FOR HOLOGRAPHIC MOTION PICTURE RECORD PRESSINGS, Assignee: Rca Corporation, (U.S. PTO Utility 1973)
- C 21 US PAT 4017158 SPATIAL FREQUENCY CARRIER AND PROCESS OF PREPARING SAME, Assignee: E. I. Du Pont de Nemours and Company, (U.S. PTO Utility 1977)
- C 22 US PAT 3832027 SYNTHETIC HOLOGRAM GENERATION FROM A PLURALITY OF TWO-DIMENSIONAL VIEWS, Assignee: At&t Corp., (U.S. PTO Utility 1974)
- C 23 US PAT 5822092 SYSTEM FOR MAKING A HOLOGRAM OF AN IMAGE BY MANIPULATING OBJECT BEAM CHARACTERISTICS TO REFLECT IMAGE DATA, (U.S. PTO Utility 1998)

LexisNexis CourtLink **Welcome Patricia Volpe!** [Order Documents](#) | [Available Courts](#) | [Total Litigator](#) | [Lexis.com](#) | [Sign Out](#)

[My CourtLink](#) [Search](#) [Dockets & Documents](#) [Track](#) [Alert](#) [Strategic Profiles](#) [My Account](#)

 [Search](#) > [Patent Search](#) > Searching

Patent Search 6486982 4/23/2007

No cases found.

[Return to Search](#)

(Charges for search still apply)



[About LexisNexis](#) | [Terms & Conditions](#) | [Pricing](#) | [Privacy](#) | [Customer Support - 1-888-311-19](#)
Copyright © 2007 LexisNexis®. All rights reserved.

Source: [Command Searching > Utility, Design and Plant Patents](#) 
Terms: **patno=6486982** ([Edit Search](#) | [Suggest Terms for My Search](#))

168585 (09) 6486982 November 26, 2002

UNITED STATES PATENT AND TRADEMARK OFFICE GRANTED PATENT

6486982

◆ [Get Drawing Sheet 1 of 8](#)
[Access PDF of Official Patent](#) *

[Check for Patent Family Report PDF availability](#) *

* Note: A transactional charge will be incurred for downloading an Official Patent or Patent Family Report. Your acceptance of this charge occurs in a later step in your session. The transactional charge for downloading is outside of customer subscriptions; it is not included in any flat rate packages.

[Order Patent File History / Wrapper from REEDFAX®](#)
[Link to Claims Section](#)

November 26, 2002

System for making a hologram of an image by manipulating object beam characteristics to reflect image data

REEXAM-LITIGATE: March 28, 2005 - Reexamination requested March 28, 2005 by Martin P. Hoffman, Hoffman, Wasson & Gitler, PC, Arlington, VA, Reexamination No. 90/007,482 (O.G. May 17, 2005) Ex. Gp.: 2872

APPL-NO: 168585 (09)

FILED-DATE: October 8, 1998

GRANTED-DATE: November 26, 2002

ASSIGNEE-PRE-ISSUE: October 8, 1998 - ASSIGNMENT OF ASSIGNORS INTEREST (SEE DOCUMENT FOR DETAILS)., DIMENSIONAL ARTS, INC. 15730 WEST HARDY ROADHOUSTON, TEXAS, 77060, Reel and Frame Number: 009511/0418
June 18, 2002 - ASSIGNMENT OF ASSIGNORS INTEREST (SEE DOCUMENT FOR DETAILS)., ILLINOIS TOOL WORKS INC 3600 WEST LAKE AVENUEGLENVIEW, ILLINOIS, 60025, Reel and Frame Number: 013011/0028

ASSIGNEE-AT-ISSUE: Illinois Tool Works Inc., Glenview, Illinois, United States (US), United States company or corporation (02)

ASSIGNEE-AFTER-ISSUE: May 6, 2003 - ASSIGNMENT OF ASSIGNORS INTEREST (SEE DOCUMENT FOR DETAILS)., ILLINOIS TOOL WORKS INC. 3600 WEST LAKE AVENUEGLENVIEW, ILLINOIS, 60025, Reel and Frame Number: 013630/0863

CORE TERMS: beam, pixel, hologram, grating, laser, splitter, holographic, lens, photosensitive, diffraction ...

Source: [Command Searching > Utility, Design and Plant Patents](#) 
Terms: **patno=6486982** ([Edit Search](#) | [Suggest Terms for My Search](#))
View: [Custom](#)



[Switch Client](#) | [Preferences](#) | [Feedback](#) | [Sign Off](#) | [Help](#)

[My Lexis™](#) | [Search](#) | [Research Tasks](#) | [Search Advisor](#) | [Get a Document](#) | [Shepard's®](#) | [Alerts](#) | [History](#) |

[Sources](#) | [Guided Search Forms](#) | [Command Searching](#)

[Command Searching](#) > [Patent Cases from Federal Courts and Administrative Materials](#)

Enter Search Terms

Search Help

Terms and Connectors Natural Language Easy Search

6486982 or 6,486,982

Search Conn

[and](#) [and](#)
[or](#) [or](#)
[w/N](#) [withi](#)
[pre /N](#) [prec](#)
[w/p](#) [in sa](#)
[w/seg](#) [in sa](#)
[w/s](#) [in sa](#)
[and not](#) [and i](#)
> [More Connect](#)

Restrict by Document Segment:

Select a document segment, enter search terms for the segment, then click Add.

Select a Segment

Note: Segment availability differs between sources. Segments may not be applied consistently across sources.

Restrict by Date:

No Date Restrictions From To [Date Formats...](#)

How Do I...?

> Use wildcards for one or more search term?
> Restrict by do
> Restrict by da

[View](#)

[My Lexis™](#) | [Search](#) | [Research Tasks](#) | [Search Advisor](#) | [Get a Document](#) | [Shepard's®](#) | [Alerts](#)
[History](#) | [Delivery Manager](#) | [Switch Client](#) | [Preferences](#) | [Feedback](#) | [Sign Off](#) | [Help](#)



LexisNexis®

[About LexisNexis](#) | [Terms & Conditions](#)
Copyright © 2007 LexisNexis, a division of Reed Elsevier Inc. All rights reserved.

No Documents Found!

No documents were found for your search terms

"6486982 or 6,486,982"

Click "Save this search as an Alert" to schedule your search to run in the future.

- OR -

Click "Edit Search" to return to the search form and modify your search.

Suggestions:

- Check for spelling errors .
 - Remove some search terms.
 - Use more common search terms, such as those listed in "Suggested Words and Concepts"
 - Use a less restrictive date range.
-

Save this Search as an Alert



LexisNexis®

[About LexisNexis](#) | [Terms & Conditions](#)

Copyright © 2007 LexisNexis, a division of Reed Elsevier Inc. All rights reserved.



[Switch Client](#) | [Preferences](#) | [Feedback](#) | [Sign Off](#) | [Help](#)

[My Lexis™](#) | [Search](#) | [Research Tasks](#) | [Search Advisor](#) | [Get a Document](#) | [Shepard's®](#) | [Alerts](#) | [History](#) |

[Sources](#) | [Guided Search Forms](#) | [Command Searching](#)

[Command Searching](#) > [Patent, Trademark & Copyright Periodicals, Combined](#)

Enter Search Terms

Search Help

Terms and Connectors Natural Language Easy Search

6486982 or 6,486,982

Restrict by Document Segment:

Select a document segment, enter search terms for the segment, then click Add.

Select a Segment

Note: Segment availability differs between sources. Segments may not be applied consistently across sources.

Restrict by Date:

No Date Restrictions From To [Date Formats...](#)

Search Conn
and and
or or
w/N withi
pre /N prec
w/p in sa
w/seg in sa
w/s in sa
and not and
> More Connect

How Do I...?
> Use wildcards for one or mo search term?
> Restrict by do
> Restrict by da

[View](#)

[My Lexis™](#) | [Search](#) | [Research Tasks](#) | [Search Advisor](#) | [Get a Document](#) | [Shepard's®](#) | [Alerts](#)
[History](#) | [Delivery Manager](#) | [Switch Client](#) | [Preferences](#) | [Feedback](#) | [Sign Off](#) | [Help](#)



LexisNexis®

[About LexisNexis](#) | [Terms & Conditions](#)
Copyright © 2007 LexisNexis, a division of Reed Elsevier Inc. All rights reserved.

No Documents Found!

No documents were found for your search terms

"6486982 or 6,486,982"

Click "Save this search as an Alert" to schedule your search to run in the future.

- OR -

Click "Edit Search" to return to the search form and modify your search.

Suggestions:

- Check for spelling errors .
 - Remove some search terms.
 - Use more common search terms, such as those listed in "Suggested Words and Concepts"
 - Use a less restrictive date range.
-

Save this Search as an Alert



LexisNexis®

[About LexisNexis](#) | [Terms & Conditions](#)

Copyright © 2007 LexisNexis, a division of Reed Elsevier Inc. All rights reserved.

LexisNexis® Total Research System

My Lexis™ Search Research Tasks Search Advisor Get a Document Shepard's® Alerts

Sources | Guided Search Forms | Command Searching |

Switch Client | Preferences | Feedback | Sign Off | ? Help

History | ?

Command Searching > News, All (English, Full Text) ?

Enter Search Terms

Search Help

Terms and Connectors Natural Language Easy Search

6486982 or 6,486,982

Search Conn

and and
or or
w/N with
pre /N prec
w/p in sa
w/seg in sa
w/s in sa
and not and
> More Connect

Restrict by Document Segment:

Select a document segment, enter search terms for the segment, then click Add.

Select a Segment

Note: Segment availability differs between sources. Segments may not be applied consistently across sources.

Restrict by Date:

No Date Restrictions From To [Date Formats...](#)

How Do I...?

- > Use wildcards for one or more search term?
- > Restrict by do
- > Restrict by da

View

My Lexis™ | Search | Research Tasks | Search Advisor | Get a Document | Shepard's® | Alerts
History | Delivery Manager | Switch Client | Preferences | Feedback | Sign Off | Help

LexisNexis® [About LexisNexis](#) | [Terms & Conditions](#)
Copyright © 2007 LexisNexis, a division of Reed Elsevier Inc. All rights reserved.

Source: [Command Searching > News, All \(English, Full Text\)](#) 
Terms: **6486982** or **6,486,982** ([Edit Search](#) | [Suggest Terms for My Search](#))

 Select for FOCUS™ or Delivery

- 1. [Holography News](#), February 1, 2007, Pg. 8(1), 160716368, 347 words, Key claims of Davis dot matrix patent rejected; INDUSTRY NEWS ... US patent number **6,486,982** System for Making ...
- 2. [Omaha World-Herald \(Nebraska\)](#), October 20, 2004, Wednesday, IOWA;MIDLANDS EDITION, Pg. 06B,, 122 words, Probation issue sends Omaha woman to jail, Todd Cooper

Source: [Command Searching > News, All \(English, Full Text\)](#) 
Terms: **6486982** or **6,486,982** ([Edit Search](#) | [Suggest Terms for My Search](#))
View: Cite
Date/Time: Monday, April 23, 2007 - 3:59 PM EDT



LexisNexis®

[About LexisNexis](#) | [Terms & Conditions](#)
Copyright © 2007 LexisNexis, a division of Reed Elsevier Inc. All rights reserved.

56548 U.S. PTO



05/17/07

IN THE UNITED STATES PATENT AND TRADEMARK OFFICE

In re Application of:)
)
 ARTHUR R. HAIR)
)
 Reexamination Control No. 90/007,402)
)
 Reexamination Filed: January 31, 2005) METHOD FOR TRANSMITTING
) A DESIRED DIGITAL VIDEO OR
 Patent Number: 5,191,573) AUDIO SIGNAL
)
 Examiner: Roland Foster

Mail Stop *Ex Parte* Reexamination
 Commissioner for Patents
 P.O. Box 1450
 Alexandria, VA 22313-1450

Sir:

RESPONSE

In response to the Office Action for the above-identified reexamination dated
 March 17, 2007, please enter the following remarks.

Remarks begin on page **2** of this paper.

REMARKS

Claims 1 through 6, which originally issued in the patent under reexamination, and new Claims 44 through 49, are currently pending in the reexamination.

I. SUMMARY

The Office essentially has reiterated its previous position regarding the entitlement of the claims as issued in U.S. Patent No. 5,191,573 (the “573 Patent”) to the proper priority date of June 13, 1988. Patentee again wishes to point out that the Office has exceeded its jurisdiction in extending the instant reexamination to consider issues of written support and enablement, which clearly are outside the mandate given to the Office in the reexamination statutes. The Office repeatedly cites the Manual of Patent Examination Proceed (“MPEP”) as granting authority to consider in reexamination issues related to priority. In fact, a number of the sections of the MPEP cited by the Office as granting authority to address intervening references in reexamination are not themselves concerned with reexamination, but rather initial examination. Further, Patentee respectfully points out that, even with respect to MPEP sections that are relevant to reexamination, these sections merely set forth PTO procedures. The MPEP is not a rule or statement of law, and thus the MPEP cannot by itself grant any authority not previously granted by statute.

Nonetheless, even if it were within Office’s mandate to consider issues of priority, the Office clearly is not empowered to address any issues where they do not themselves present new issues related to patentability. As pointed out in detail by Patentee in the Response to the Office Action of September 29, 2006, all of the issues of alleged new matter now specifically raised in the instant reexamination were addressed previously by

the original examiner, Examiner Nguyen, during the initial examination of the '573 Patent. Patentee herein incorporates all arguments made in the Response to the previous Office Action concerning this issue as if repeated in their entirety.

Additionally, Patentee in the Response to the previous Office Action pointed out where each element in the claims currently in reexamination is supported in the specification as originally filed. Further, Patentee specifically pointed out in detail that the invention was in fact enabled as of June 13, 1988. As specifically addressed in Patentee's Response to the previous Office Action, the Office is applying an improper standard for 35 U.S.C. § 112, first paragraph, written support and enablement. Patentee also incorporates herein all arguments concerning this issue made in the Response to the previous Office Action as if repeated in their entirety.

Many of the new rejections of Claims 1 through 6 and 44 through 49 under Section 112, first paragraph, regarding written support and enablement similarly are improper because they address issues already decided during the initial examination of the '573 Patent. With respect to any issues under Section 112, first paragraph, now raised by the Office that may not have previously been decided, Patentee demonstrates herein that Claims 1 through 6 and 44 through 49 are fully supported and enabled by the specification originally filed on June 13, 1988.

As a result, Patentee reiterates its position that U.S. Patent No. 4,949,187 to Cohen (*Cohen*) cited by the Office does not qualify as prior art and is not available for the purposes of rejections under 35 U.S.C. §§ 102 and 103. Patentee similarly incorporates herein all arguments made in the Response to the previous Office Action concerning this issue as if repeated in their entirety.

To the extent the Office repeats rejections asserted in the previous Office Action based on references that are available as prior art, Patentee reiterates its position that those rejections are improper and should be withdrawn. With respect to new rejections under 35 U.S.C. §§ 102 and 103 that are based upon appropriate prior art, Patentee similarly demonstrates herein that those rejections are improper and should be withdrawn.

II. THE OFFICE IS NOT EMPOWERED TO REASSIGN PRIORITY DATES DURING REEXAMINATION

The '573 Patent issued from U.S. Patent Application Serial No. 07/586,391 (the "'391 Application'"), which was filed as a continuation of U.S. Patent Application Serial No. 07/206,497 (the "'497 Application'"). The Office admits the '573 Patent is not a continuation-in-part, but then asserts that the '573 Patent "shares the characteristics of a continuation-in-part." Based on this novel characterization of the '573 Patent, the Office proceeds to revisit the entitlement of the claims in the '573 Patent to the June 13, 1988 priority date previously awarded by Examiner Nguyen.

A. THE OFFICE IS ATTEMPTING TO REASSIGN THE PRIORITY DATE OF THE '573 PATENT

The Office asserts that "no priority dates have been 'reassigned' by the examiner." However, this is exactly what the Office has done.

1. Examiner Nguyen Assigned A Priority Date Of June 13, 1988 To The Claims In The '573 Patent

MPEP § 602.05(a) states unequivocally that, "[i]f the examiner determines that the continuation or divisional application contains new matter relative to the prior application, the examiner should so notify the applicant in the next Office action. The examiner should also (A) require a new oath or declaration along with the surcharge set

forth in 37 CFR 1.16 (f); and (B) indicate that the application should be redesignated as a continuation-in-part.”

During initial examination of the ‘573 Patent, the ‘391 Application was filed as a “continuation” of the ‘497 Application and thus, as a preliminary matter, was entitled to the filing date of the original application, June 13, 1988. Examiner Nguyen reviewed all amendments made to the specification and claims of the ‘497 Application, and did not require a new oath or declaration or require that the application be refiled as a continuation-in-part. Based on the MPEP sections cited by the Office and the Patentee, implicit in this is the fact that Examiner Nguyen thereby assigned the priority date of June 13, 1988 to the ‘391 Application.

Further, during prosecution of the ‘391 Application, Examiner Nguyen did make certain specific new matter rejections based on amendments to the specification and claims. Those rejections were traversed and responded to by the applicant, including the submission of a Declaration under 37 CFR § 1.132, which was determined to be persuasive by Examiner Nguyen.¹ The new matter rejections subsequently were withdrawn and the application proceeded to issue as the ‘573 Patent. Therefore, Examiner Nguyen expressly concluded that the alleged new matter was in fact supported by the originally filed specification; i.e. was disclosed in the manner provided by the first paragraph of Section 112. As a result, by definition, Examiner Nguyen determined that the claims in the ‘573 Patent were entitled to claim priority to the original June 13, 1988 filing date.

¹ As an ancillary matter, the Office now seems to question the persuasiveness of the Section 1.132 Declaration submitted by applicant during examination of the ‘391 Application. Patentee respectfully points out this is not an issue that can be addressed on reexamination. The original Examiner must be assumed to have done his job properly in the initial examination.

2. The Office Is Attempting To Reassign A Priority Date Of September 18, 1990 To The Claims Of The '573 Patent

The Office now asserts, contrary to Examiner Nguyen, that the '573 Patent was only entitled to a priority date of September 18, 1990. Essentially, the Office has made an *ex post* determination that Examiner Nguyen *should have* either required that the amendatory text be deleted, or *should have* required that the application be refiled as a continuation-in-part with a new oath or declaration. In short, it is the Office's position that Examiner Nguyen *should have*, at some point, assigned a priority date of September 18, 1990 to the '391 Application during prosecution. After extensively reviewing the amendments to the specification and claims during prosecution of the '391 Application, Examiner Nguyen assigned the priority date of June 13, 1988. Dissatisfied with Examiner Nguyen's conclusion, the Office now has taken it upon itself to revisit the issue and reassign the priority date of September 18, 1990 for the '573 Patent.

3. The Office is Attempting To Create A New Designation Of "De Facto CIP"

The Office admits the '573 Patent is not a continuation-in-part application, but then asserts the '573 Patent "shares the characteristics of a continuation-in-part," and cites this as a basis for assigning a later priority date to the claims of the '573 Patent. The Office points to text added to the specification of the '573 Patent that was not found in the originally filed specification as grounds for this new designation. The Office further cites MPEP § 201.11 to support its conclusion. However, the presence of additional or different text in the specification of a continuation application does not by itself render the continuation application a continuation-in-part. The prohibition of MPEP § 201.11 concerns addition of text that would constitute new matter. Indeed, MPEP § 602.05

explicitly contemplates that changes and additions to the text of specifications in continuation and divisional applications can occur and are acceptable so long as no new matter is introduced:

“A copy of the oath or declaration from a prior non-provisional application may be filed in a continuation or divisional application *even if the specification for the continuation or divisional application is different from that of the prior application*, in that revisions have been made to clarify the text to incorporate amendments made in the prior application, or to make other changes provided the changes do not constitute new matter relative to the prior application. See 37 CFR 1.52(c)(3).” MPEP § 602.05 (emphasis added).

Further, the Office has cited no authority that empowers it, in the context of reexamination, to treat a continuation application as a continuation-in-part because the examiner in reexamination believes the continuation “shares characteristics of a continuation-in-part.” Patentee submits that an application or patent is either a continuation-in-part, or it is not. There simply is no designation in the statutes or regulations for patents that are continuations, but “share the characteristics of continuations-in-part”, as asserted by the Office. Patentee therefore respectfully submits that the Office has manufactured the designation of “*de facto* CIP” to allow the Office to cite references that otherwise would be unavailable as prior art.

The Office’s reliance on *In re Russetta*, 255 F.2d 687 (CCPA 1958) and *In re van Langenhoven*, 458 F.2d 132 (CCPA 1972) as authority for creating a *de facto* CIP is misplaced. Both *Russetta* and *van Langenhoven* deal explicitly with patents that issued from continuation-in-part applications. Further, both cases pre-date the reexamination statute, and thus say nothing about the proper conduct of reexamination proceedings. The Office has cited no further authority to support its interpretation of *Russetta* or *van Langenhoven*. Moreover, the Office cannot expand the holdings of these cases simply by

inserting references to them in MPEP sections dealing with the scope of reexamination.

“The MPEP sets forth PTO procedures; it is not a statement of law.” *Regents of the*

University of New Mexico v. Knight, 321 F.3d 1111, 1121 (Fed. Cir. 2003).

B. THE PRIORITY DATE OF THE CLAIMS OF THE ‘573 PATENT IS NOT A NEW ISSUE RELATED TO PATENTABILITY AND CANNOT BE REVISITED BY THE OFFICE IN REEXAMINATION

The Office asserts the determination of the priority date of the claims in the ‘573 Patent is a new issue related to patentability. The Office then back tracks on this statement by saying that, even if were not a new issue, nothing bars the Office from revisiting the issue in reexamination.

1. The Entitlement Of The Claims In The ‘573 Patent To The Priority Date Of June 13, 1988 Was Addressed By Examiner Nguyen During The Original Prosecution Of The ‘573 Patent

The Office admits that Examiner Nguyen did in fact address the issue of the alleged new matter shown in Table I of the instant Office Action. The Office further admits that Patentee has effectively demonstrated as much through the table submitted with Patentee’s Response to the Office Action of September 29, 2006. However, the Office then asserts that Examiner Nguyen did not have an opportunity to compare all of the amendments to the claims and specification made during prosecution to the originally filed specification. The Office refers to Table II in the instant Office Action for examples of “gradually added new matter” which the Office asserts was not addressed by Examiner Nguyen. However, on reviewing Table II, it is apparent that it contains the same alleged new matter as Table I, which the Office already has admitted was reviewed and passed on by Examiner Nguyen. In fact, the text referred to by the Office in the instant Office

Action appears to be the same text presented in the previous Office Action with the exception that it has now been relabeled Table II.

2. The Absence Of Rejections Based On Intervening References During The Initial Examination Of The '573 Patent Does Not Demonstrate Examiner Nguyen Failed To Address The Issue Of Priority

The Office asserts that Examiner Nguyen never had reason to consider the propriety of the claim of priority made in the '391 Application, because no intervening references were ever cited by the Examiner. This line of argument by the Office effectively puts the rabbit in the hat, by concluding that the absence of any intervening references in the record is conclusive evidence the issue of priority was never addressed by Examiner Nguyen. Patentee respectfully submits it is more plausible to conclude that no intervening references were cited because Examiner Nguyen properly concluded the '391 Application was entitled to the priority date of June 13, 1988. Not only is Patentee's position more plausible on its face, it is fully supported by the written record as detailed in Section II(A)(1) above.

3. MPEP § 2258.IV.E Does Not Empower The Office To Revisit The Issue Of The Entitlement Of Claims In An Issued Patent To A Priority Date

The Office cites MPEP § 2258.IV.E as an example of revisiting priority issues in reexamination. However, most of this section addresses only the procedural issues in reexamination for perfecting a claim for priority made previously during initial examination.

The cited section also deals with claiming priority under 35 U.S.C. § 120 to an earlier filed copending application during reexamination, where there was an earlier *failure* to make such a claim. Where a patentee seeks to correct an earlier *failure* to claim

priority, that would be a new issue, since the priority claim was never before the Office in the first place. However, in the instant case, a claim of priority was made by the applicant and Examiner Nguyen determined the '573 Patent in fact was entitled to the priority date of June 13, 1988. Since a claim of priority is, by definition, before the Examiner when it is made, it can never be a new issue in reexamination; i.e. one that the original Examiner had no reason to consider. Indeed, MPEP § 201.11, cited favorably by the Office, *requires* an Examiner to address the issue during initial examination.

Further, MPEP § 2258.IV.E does not address revisiting and removing an earlier claim of priority made in an application, and does not address the entitlement of an issued patent to an earlier claimed right of priority.

Finally, MPEP § 2258.IV.E addresses reexaminations initiated by the Patentee, and does not empower the Office to address the issue of entitlement to a claimed priority date where the issue is not first raised by the Patentee.

The Office also cites MPEP § 1402, which concerns reissue proceedings, as an example of addressing priority issues. However, again, the cited section deals with adding or changing claims of priority, where an earlier claim contained an error or was not made at all. Patentee further respectfully points out that, while MPEP § 1405 does address deletion of a priority claim in reissue, that section does not empower the Office on its own to determine the propriety of the priority claim. Finally, 37 CFR § 1.552(c) is explicit about the scope of reexamination:

“Issues other than those indicated in paragraphs (a) and (b) of this section will not be resolved in a reexamination proceeding. If such issues are raised by the patent owner or third party requester during a reexamination proceeding, the existence of such issues will be noted by the examiner in the next Office action, in which case the patent owner may consider the advisability of filing a reissue application to have such issues considered and resolved.” 37 CFR 1.552(c) (emphasis added).

Therefore, notwithstanding MPEP § 1405, the propriety of a previously made priority claim cannot be revisited by the Office during reexamination.

C. SINCE THE ISSUE OF ENTITLEMENT OF THE CLAIMS OF THE '573 PATENT TO THE JUNE 13, 1988 FILING DATE OF THE PARENT APPLICATION IS NOT A NEW ISSUE, *PATLEX* BARS RECONSIDERATION OF THE ISSUE DURING REEXAMINATION

The Office agrees that the holding of *Patlex v. Quigg*, 680 F.Supp 33 (D.D.C. 1988) bars reconsideration of the entitlement to a claim for priority where the issue of the sufficiency of the disclosure of the application to which the claim is made has already been determined by the PTO or a court. As demonstrated by Patentee and admitted by the Office, Examiner Nguyen decided the issue of the sufficiency of the disclosure of the '497 Application during the initial examination of the '573 Patent. In short, Examiner Nguyen decided the claims in the '573 Patent are entitled to the filing date accorded the '497 Application, June 13, 1988. Recasting as arising under 35 U.S.C. § 120, as opposed to 35 U.S.C. § 132, the same Section 112, first paragraph, issues previously dealt with by Examiner Nguyen does not make them new. Therefore, by the Office's own admission, it is barred from revisiting the issue of priority in reexamination.

III. THE INSTANT REJECTIONS OF THE CLAIMS CURRENTLY IN REEXAMINATION ARE IMPROPER

The Office has rejected Claims 1 through 6 and 44 through 49 under Section 112, first paragraph, based on lack of adequate written description and lack of enablement. A number of these Section 112, first paragraph, rejections improperly address issues that previously were determined during the initial examination of the '573 Patent. The Office has also rejected Claims 1 through 6 and 44 through 49 under 35 U.S.C. §§ 102(e) and

103(a) over various references. At least one of these references, *Cohen*, is not available as prior art since it post dates the proper June 13, 1988 priority date for the '573 Patent.

A. REJECTION OF CLAIMS 44 THROUGH 49 UNDER 35 U.S.C. § 112, FIRST PARAGRAPH

Claims 44 through 49 have been rejected under Section 112, first paragraph, as introducing matter not described in the original specification. Claims 47 through 49 additionally have been rejected as not being enabled by the original specification.

Patentee traverses this rejection.

As a preliminary matter, 37 CFR § 1.552(a) states that an analysis under Section 112 will be performed with respect to *matter* added or deleted, not *claims* added or deleted. The restatement of matter already presented in Claims 1 through 6 in the form of Claims 44 through 49 does not add *matter* to the claims. MPEP § 2163.I states that issues under Section 112 “*most typically... arise in the context of...new or amended claims.*” (emphasis added). This statement does not empower the Office to assert Section 112, first paragraph, rejections every time previously claimed matter is presented in the form of a different claim.

The only element present in Claims 44 through 49 that was not previously present in Claims 1 through 6 is the recitation of a hard disk. Therefore, the Office may only examine the recitation of “hard disk” for compliance with Section 112, first paragraph. A review of the originally filed specification demonstrates this recitation is fully supported and enabled by the originally filed specification. See Original Specification, p. 3, ln. 30.

Nonetheless, even if it were proper for the Office to examine Claims 44 through 49 in their entirety for compliance with Section 112, first paragraph, under 37 CFR § 1.552(a), those issues already were addressed by Examiner Nguyen during the initial

examination of Claims 1 through 6, as recognized by the Office in the instant Office Action.

Further, as demonstrated by the Patentee in the Response to the Office Action of September 29, 2006, each element of Claims 1 through 6 is fully supported and enabled by the specification of the '497 Application as originally filed. Therefore Patentee respectfully submits that each element of Claims 44 through 49 is also fully supported. Reconsideration is respectfully requested.

B. REJECTION OF CLAIMS 1 THROUGH 6 UNDER 35 U.S.C. § 112, FIRST PARAGRAPH

Claims 1 through 6 have been rejected under Section 112, first paragraph, as introducing matter not described in the original specification. Claims 4 through 6 additionally have been rejected as not being enabled by the original specification. Patentee traverses this rejection.

The Office asserts that the negative limitation of “a non-volatile storage portion of the second memory, wherein the non-volatile storage is not a tape or a CD”, introduces a new concept to the claims that does not have a basis in the originally filed specification. The Office cites two cases from the Board of Patent Appeals and Interferences (BPAI), one case from the Court of Customs and Patent Appeals (CCPA), and one case from the Court of Appeals for the Federal Circuit (CAFC) to support this rejection.

As a preliminary matter, Patentee notes that the CAFC case cited by the Office, *Lizardtech v. Earth Resources Mapping*, 433 F.3d 1373 (Fed. Cir. 2006), is merely an opinion denying a petition for rehearing *en banc*, which does not address anything related to the current rejection, and therefore contains no holding that supports the Office’s position.

The two cases from the BPAI, *Ex Parte Wong*, 2004 WL 4981845 (Bd. Pat. App. & Interf.) and *Ex Parte Grasselli*, 231 USPQ 393 (Bd. Pat. App. & Interf. 1983), address situations where a negative limitation added to a claim was not described in the specification of the application.

The case from the CCPA, *Application of Johnson*, 558 F.2d 1008 (CCPA 1977), concerns a situation where the applicant sought to claim priority to an originally filed application for claims in a subsequent continuation-in-part application. The disclosure and claims in the CIP application recited a negative limitation excluding certain species from a polymer composition, where the negative limitation was not disclosed in the original parent application. According to the court, this new negative limitation created a new sub-genus not disclosed in the original parent application. As a result, the claims in the CIP application were not entitled to claim priority to the original parent application.

The holdings of *Wong* and *Grasselli* do not support the rejection of Claims 1 through 6 under Section 112, first paragraph, in the instant case. In both *Wong* and *Grasselli*, the issue and ultimate ground for rejection was that a negative limitation added to the claims introduced a new concept not disclosed in the respective specifications in those cases. That simply is not the situation here. Both Claims 1 and 4 recite a non-volatile storage portion of a memory that is not a tape or CD. The originally filed specification of the '497 Application explicitly states that the disclosed invention eliminates the need to handle tapes and CDs. See p. 2, lns. 23 to 26. Thus, the concept of storing digital audio or digital video signals on a memory that is not a tape or CD is explicitly disclosed by the original specification.

The holding of *Johnson* similarly is not helpful to the Office here. In *Johnson*, an original parent application disclosed and claimed a genus of polymer compositions comprising various monomer units. In a later filed continuation-in-part application, the broad genus claims in the parent application were narrowed by expressly excluding certain species from the polymer compositions. The parent application only contained a description of the broader genus. The court found that claims to the narrower sub-genus created by the express exclusion of certain species in the continuation-in-part were not supported by the description of the broader genus in the parent specification. Again, the situation with the present reexamination differs significantly from the cited case law. Claims 1 and 4 recite a non-volatile storage portion of a memory that is not a tape or CD. This is exactly what is described at page 2, lines 23 to 26 of the originally filed specification. In short, the negative limitation recited in Claims 1 and 4 is expressly disclosed in the specification of the parent application. Thus, in the instant case, the scope of the disclosure in the specification was never narrowed with respect to this element, contrary to the situation in *Johnson*. Patentee therefore respectfully submits that the recitation of a non-volatile storage portion of a memory that is not a tape or CD is fully supported by the originally filed specification, as well as the specification of the '573 Patent as issued.

With respect to the other elements recited in Claims 1 through 6, the issue of written support for the claimed matter previously was addressed by Examiner Nguyen during the initial examination of Claims 1 through 6, as recognized by the Office in the instant Office Action. Moreover, Patentee thoroughly demonstrated in the Response to the Office Action of September 29, 2006 that each element in Claims 1 through 6 is fully

supported and enabled by the original specification as filed, as well as the specification for '573 Patent as issued. Reconsideration is respectfully requested.

C. ALL FEATURES OF CLAIMS 1 THROUGH 6 AND 44 THROUGH 49 IN THE '573 PATENT FIND WRITTEN SUPPORT IN THE ORIGINALLY FILED SPECIFICATION OF THE '497 APPLICATION

In the Response to the previous Office Action, Patentee specifically pointed out in table format where each feature of Claims 1 through 6 is supported by the originally filed specification of the '497 Application. Patentee incorporates those arguments here as if repeated in their entirety. Patentee further submits for the same reason Claims 44 through 49 are also supported by the originally filed specification of the '497 Application.

To further support Patentee's position with respect to particular claim elements, Patent hereby submits a Declaration under 37 CFR § 1.132 of Dr. J. Douglas Tygar. As set forth in the Declaration of Dr. Tygar, the claim language; "transferring money electronically via a telecommunication line to a first party at a location remote from the second memory," "charging a fee," "providing a credit card number," and "charging an account," all would have been interpreted by one of ordinary skill in the art in the context of the described electronic sales and distribution of digital audio signals or digital video signals. In this context, one of ordinary skill in the art would have recognized that electronic sales encompassed transactions where a fee is charged, and thus money is transferred from one party to another electronically via a telecommunication line. It further would have been understood by one of ordinary skill in the art that electronic sales could be accomplished by providing a credit card number. As a result, one of ordinary skill in the art in 1988 would have recognized

that the description of electronic sales in the specification of the '479 Application necessarily comprehends "transferring money to a first party from a second party electronically via telecommunication lines," "charging a fee," "charging an account," and "providing a credit card number."

As further set forth in the Declaration of Dr. Tygar, one of ordinary skill in the art in 1988 would have been aware of the available means for connecting computer systems to telecommunication lines for the purpose of transferring electronic signals; for example modems. Such means could be used at the originating (transmitting) computer and at the destination (receiving) computer. The control unit or control integrated circuit of the copyright holder and user would have been recognized by one of ordinary skill in the art as being some type of computer system or part of a computer system. Therefore, the terms in the claims, "transmitter" and "receiver", describe what would have been understood by one of ordinary skill in the art as being necessarily comprehended by the description provided in the specification and figures filed with the '497 Application.

Finally, as also set forth in the Declaration of Dr. Tygar, it easily would have been recognized by one of ordinary skill in the art in 1988 that the specification's teaching requires establishing some type of connectivity as a pre-requisite to making a purchase/sale of digital signals, as well as for transferring the digital signals. Since the specification of the '497 Application explicitly discloses selling and transferring digital audio signals (or digital video signals) over telephone lines, it is clear that the step of requesting and establishing connectivity (telephoning) is necessarily comprehended in

the description provided in the '497 Application, since the step would have been recognized as a prerequisite for performing the function of the disclosed system.

D. ALL FEATURES OF CLAIMS 1 THROUGH 6 AND 44 THROUGH 49 IN THE '573 PATENT ARE ENABLED BY THE ORIGINALLY FILED SPECIFICATION OF THE '497 APPLICATION

In the Response to the previous Office Action, Patentee specifically explained how claims drawn to the video feature are enabled by the originally filed specification of the '497 Application. Patentee incorporates those arguments here as if repeated in their entirety. In response to those arguments, the Office Action stated:

Thus, it would not have been clear to one of ordinary skill how the digital video would have been coded and decoded during transmission over a telephone line. Such a question does not relate to mass production, but where a single video downloading system as claimed could be made or used without undue experimentation by one of ordinary skill in the art in 1988 facing a lack of industry standards for transmitting digital video data via a telephone line and also facing a limited disclosure of any video features whatsoever.

It is respectfully submitted that those of ordinary skill in the art would have been able to code and decode video data transmitted over a telephone line without undue experimentation. This is because there were existing video teleconferencing systems known and available to them prior to applicant's earliest priority date. Patentee hereby submits the reference "The Design of Picturephone® Meeting Service (PMS) Conference Centers For Video Teleconferencing", Bernard A. Wright, *IEEE Communications Magazine*, © 1983 (hereinafter *Wright*). In the paragraph crossing the left and right columns of page 30 of *Wright*, the article describes that five years before applicant's earliest priority date a digital video signal could have been (and was) sent via a telephone network and decoded with a picture processor in real-time. In fact, on page 36, *Wright* states:

The Bell System has developed a complete capability for full motion video teleconferencing, and as of July 2, 1982 is providing such a service. This high quality PMS service provides the user with an excellent full-motion, two-way fully interactive conferencing capability.

Similarly, in the section of page 35 entitled "Picture Processor," *Wright* discloses that not only was a TV processor for video processing available from Nippon Electric Corporation for use in the described video processing system, but a network interface specification was available for making systems that were compatible with the Bell System. (See reference [3].) It further states that "In the receive direction, a decoder accepts the two DS-1 signals as inputs, corrects errors, and recovers audio, video, and control information by performing the inverse of the encoding operations." (Emphasis added.) As such, contrary to the position of the Office Action, it is clear that at the time of filing the earliest priority application, one of ordinary skill in the art would have been able to transmit, download and decode video signals as claimed by using, for example, the digital video format of the PicturePhone system described in *Wright*, without undue experimentation. Applicant therefore respectfully requests that the Patent Office withdraw this ground for rejection.

E. REJECTION OF CLAIMS 1 THROUGH 6 AND 44 THROUGH 49 UNDER 35 U.S.C. § 103(a) OVER *BUSH* IN VIEW OF *COHEN*

Claims 1 through 6 and 44 through 49 have been rejected under 35 U.S.C. § 103(a) as obvious over the combination of U.S. Patent 4,789,863 to Bush (*Bush*) in view of U.S. Patent No. 4,949,187 to Cohen (*Cohen*). Patentee respectfully traverses this rejection.

As previously pointed out by Patentee, *Cohen* does not qualify as prior art based on the proper June 13, 1988 priority date of the '573 Patent. Therefore, a *prima facie* case of obviousness of Claims 1 through 6 and 44 through 49 has not been established by the foregoing combination of references.

F. REJECTION OF CLAIMS 1 THROUGH 6 AND 44 THROUGH 49 UNDER 35 U.S.C. § 103(a) OVER *BUSH* IN VIEW OF *FREENY I*

Claims 1 through 6 and 44 through 49 have been rejected under 35 U.S.C. § 103(a) as obvious over the combination of *Bush* in view of U.S. Patent No. 4,837,797 to Freeny (*Freeny I*). Patentee respectfully traverses this rejection.

As recognized by the Office, *Bush* does not disclose storing digital audio signals or digital video signals in a non-volatile storage portion of a second memory that is not a tape or a CD as recited in Claims 1 and 4. As further recognized by the Office, *Bush* does not disclose storing digital audio signals or digital video signals in a second party hard disk as recited in Claims 44 and 49.

Freeny I discloses a message controller for receiving voice messages and machine readable messages over telephone lines. The apparatus of *Freeny I* is capable of differentiating between voice messages and machine readable messages received over standard telephone equipment, i.e. a telephone. When the apparatus of *Freeny I* determines that a received call is a voice message, it causes the user's telephone to ring, thereby alerting the user. When the apparatus of *Freeny I* determines that a received call is a machine readable message, it converts the message to human readable form using a standard printer or display unit. One embodiment of the apparatus of *Freeny I* indicates it is capable of receiving machine readable messages and storing them on a storage medium that may be a memory chip or hard disk.

However, *Freeny I* does not discuss transmission of digital audio or digital video signals from a first memory to a second memory, let alone the sale of such digital video or digital audio signals. Thus, *Freeny I* bears no relation to the disclosure of *Bush* or the invention recited in Claims 1 through 6 and 44 through 49. The Office apparently has recognized this deficiency in *Freeny I*, because the Office must cite to *Cohen* to show motivation to combine *Bush* and *Freeny I*. However, as set forth above, *Cohen* is not available as prior art based on the priority date of June 13, 1988 for the '573 Patent.

The Supreme Court's recent holding in *KSR v. Teleflex*, 2007 WL 1237837 (U.S.), does not relieve the Office of the obligation to show motivation to combine two separate references in making out a *prima facie* case of obviousness. Quite to the contrary, the Supreme Court stated; "[t]o determine whether there was an apparent reason to combine the known elements in the way a patent claims, it will often be necessary to look to interrelated teachings of multiple patents; to the effects of demands known to the design community or present in the marketplace; and to the background knowledge possessed by a person having ordinary skill in the art. *To facilitate review, this analysis should be made explicit.*" *KSR v. Teleflex*, 2007 WL 1237837 (U.S.) at *3 (emphasis added).

Since the Office has not shown any motivation to combine *Bush* and *Freeny I*, a *prima facie* case of obviousness has not been established.

G. REJECTION OF CLAIMS 1, 2, 4, 5, 44, 45, 47 AND 48 UNDER 35 U.S.C. § 102(e) AS ANTICIPATED BY *COHEN*

Claims 1, 2, 4, 5, 44, 45, 47 and 48 have been rejected under 35 U.S.C. § 102(e) as anticipated by *Cohen*. Patentee respectfully traverses this rejection.

As set forth above, *Cohen* is not available as prior art based on the appropriate priority date of June 13, 1988 for the '573 Patent. Therefore the instant rejection is improper.

F. REJECTION OF CLAIMS 3, 6, 46 AND 49 UNDER 35 U.S.C. § 103(a) OVER *BUSH* IN VIEW OF *COHEN*

Claims 3, 6, 46 and 49 have been rejected under 35 U.S.C. § 103(a) over *Bush* in view of *Cohen*. Patentee respectfully traverses this rejection.

As set forth above *Cohen* is not available as prior art based on the appropriate priority date of June 13, 1988 for the '573 Patent. Therefore a *prima facie* case of obviousness has not been established by this combination of references.

G. REJECTION OF CLAIMS 1 THROUGH 6 AND 44 THROUGH 49 UNDER 35 U.S.C. § 103(a) OVER *AKASHI* IN VIEW OF *FREENY II*

Claims 1 through 6 and 44 through 49 have been rejected over Japanese Patent Application No. 62-284496 (*Akashi*) in view of U.S. Patent No. 4,528,643 to Freeny (*Freeny II*). Patentee respectfully traverses this rejection.

The Office asserts that *Akashi* shows a system for transmitting recorded music from a host computer that stores recorded music data to a personal computer. The Office then asserts that *Akashi* "does not expressly detail...whether the data is stored on a non-volatile portion of a second memory that is not a tape or CD." Patentee respectfully submits this is incorrect. In fact, *Akashi* explicitly discloses a record reproducing device that is a compact disk deck or a digital audio tape recorder. See, *Akashi* Translation p. 2 (Embodiment). Therefore, *Akashi* is not ambiguous at all on this point. Thus, not only does *Akashi* fail to disclose transmitting digital audio signals or digital video signals from a first memory to a second memory and storing the digital audio signals or digital video

signals in a non-volatile portion of the second memory that is not a tape or CD, *Akashi* expressly teaches away by specifically disclosing and requiring a tape recorder or CD deck.

The Office asserts the deficiencies of *Akashi* are cured by *Freeny II*. Specifically, the Office asserts that *Freeny II* discloses transmitting digital audio signals or digital video signals from a first memory in control and possession of a first party to a second memory in control and possession of a second party, and storing the digital audio signals or digital video signals in a non-volatile storage that is not a tape or CD. The Office further asserts it would have been obvious to implement the non-volatile storage of *Freeny II* in the system of *Akashi* because “[t]he use of a hard disk would have allowed the user to more efficiently access audio and video files.” The Office bases its position on the conclusion that “a hard-disk, would have also increased the security and reliability of the stored data.”

Patentee respectfully submits it would not have been obvious to combine the teachings of *Akashi* and *Freeny II* to arrive at the invention recited in Claims 1 through 6 and 44 through 49 for several reasons. First, *Freeny II* discloses a kiosk type system for producing “material objects” at a point of sale location where it is the “material object” that is sold to consumers. *Freeny II*, Abstract. Thus, like *Akashi*, *Freeny II* expressly teaches away from storing digital audio signals or digital video signals on non-volatile storage portion of a second memory that is not a tape or CD in possession and control of a second party. Further, in *Freeny II*, the second memory (information manufacturing machine) for storing the information that is transformed into material objects is in possession and control of the first party. The first party controls access to the information

on the second memory by requiring a fee to be paid for the consumer (second party) to access the information stored on the second memory. After the fee is paid, the second party has limited access to the specific information requested for the purpose of making a copy in the form of a material object. In the case of audio or video information, the material object would be in the form of a tape or CD. Therefore, again, both *Akashi* and *Freeny II* contemplate and require supplying audio information to the consumer in the form of a tape or CD. Thus, like *Akashi*, *Freeny II* expressly teaches away from storing digital audio signals or digital video signals on non-volatile storage portion of a second memory that is not a tape or CD in possession and control of a second party.

Additionally, in *Freeny II*, the necessary material object containing the digital audio or digital video signals is produced by accessing information stored on the second memory. The first memory (information control machine) simply supplies reproduction authorization codes in response to a request for reproduction from the information manufacturing machine. The second party never has access to the first memory, as recited in Claims 2, 5, 45 and 48.

Both *Akashi* and *Freeny II* solve the same problem: providing audio information, and video information in the case of *Freeny II*, to a consumer in the form of a material object, such as a tape or CD. *Akashi* and *Freeny II* solve this common problem in different and unrelated ways. Nonetheless, neither of the references teaches or discloses the benefits of transmitting digital audio signals or digital video signals from a first memory to a second memory and storing those digital audio signals or digital video signals in a non-volatile portion of the second memory that is not a tape or CD, which is in possession and control of a consumer, i.e. a second, financially distinct, party.

Therefore, the combination of *Akashi* and *Freeny II* does not teach or suggest every limitation of Claims 1 through 6 or 44 through 49. In fact, because both of *Akashi* and *Freeny II* expressly require storing digital audio signals or digital video signals on a tape or CD, they teach away from the invention recited in Claims 1 through 6 and 44 through 49. As a result, these references cannot be combined to render Claims 1 through 6 obvious. “[W]hen the prior art teaches away from combining certain known elements, discovery of a successful means of combining them is more likely to be nonobvious.” *KSR v. Teleflex*, 2007 WL 1237837 (U.S.) at *12.

Even if the combination of *Akashi* and *Freeny II* did teach each and every element of Claims 1 through 6 or 44 through 49 – which they do not -- the motivations cited by the Office for combining and/or modifying *Akashi* and *Freeny II* are not found in those references. Moreover, the Office has not cited to any other references or knowledge available to one of ordinary skill in the art in 1988 that would have motivated a skilled artisan to combine and/or modify *Akashi* and *Freeny II* as suggested by the Office. Rather, the Office simply has made vague statements that the security and reliability of hard-disks would have been well known at the time. Such general allegations are insufficient to show motivation to combine these references, particularly since neither one of them even hints at such a modified combination. Again, as the Supreme Court has just admonished: “[a] patent composed of several elements is not proved obvious merely by demonstrating that each element was, independently, known in the prior art.” *Id.* at *3

Based on all of the foregoing, Patentee respectfully submits that a *prima facie* case of obviousness of Claims 1 through 6 and 44 through 49 over the combination of *Akashi* and *Freeny II* has not been established.

* * * * *

For all of the reasons set forth above, Patentee respectfully requests that all rejections of Claims 1 through 6 and 44 through 49 be withdrawn, and those claims be allowed to issue out of the pending reexamination proceeding.

Respectfully submitted,
DRINKER BIDDLE & REATH LLP



Robert A. Koons, Jr.
Registration No. 32,474

DRINKER BIDDLE & REATH LLP
One Logan Square
18th & Cherry Streets
Philadelphia, PA 19103-6996
Telephone: (215) 988-3392
Facsimile: (215) 988-2757

IN THE UNITED STATES PATENT AND TRADEMARK OFFICE

In re Application of: 56548 U.S. PTO)
ARTHUR R. HAIR )
05/17/07)
Reexamination Control No. 90/007,402)
Reexamination Filed: January 31, 2005) A SYSTEM FOR TRANSMITTING
Patent Number: 5,191,573) DESIRED DIGITAL VIDEO OR
Examiner: Roland G. Foster) AUDIO SIGNALS
)

May , 2007

Mail Stop *Ex Parte* Reexamination
Commissioner for Patents
P.O. Box 1450
Alexandria, VA 22313-1450

DECLARATION UNDER 37 C.F.R. §1.132

I, Justin Douglas Tygar, hereby declare that:

1. I am a tenured, full Professor at the University of California, Berkeley, with a joint appointment in the Department of Electrical Engineering and Computer Science (Computer Science Division) and the School of Information. Before joining the faculty at Berkeley, I was faculty member at Carnegie Mellon University. I have continuously been Professor of electrical engineering and computer science since 1986.

2. I serve, and have served, in a number of capacities on government, academic, and industrial committees that give advice or set standards in security and electronic commerce. I have attached a copy of a recent curriculum vita to this declaration as Exhibit A.

3. I have reviewed the specification and claims of United States Patent No. 5,191,573 (“573 Patent”), United States Patent No. 5,675,734 (“734 Patent”), United States Patent No. 5,966,440 (“440 Patent”) and the specification and claims of United States patent application Serial Number 07/206,497, as originally filed on June 13, 1988 (“497 Application”).

4. I have been asked by counsel for the patent owner to analyze the claims in the ‘573 Patent, ‘734 Patent and ‘440 Patent, which currently are being reexamined, to determine if the language in the claims and the accompanying specifications have written support in the specification of the ‘497 Application, as originally filed on June 13, 1988. I understand that, for a claim to be supported by the specification of a patent, the specification must make clear to one of ordinary skill in the art that the inventor had possession of the invention recited in the claims at the time the application for the patent was filed. I also understand that the claims of a patent need not describe the invention using exactly the same terminology found in the specification of the patent, so long as one of skill in the art would recognize that what is recited in the claims is “necessarily comprehended” by what is described in the specification.

5. My understanding of the meaning of “necessarily comprehend” is that, although the specification of a patent may not exactly describe, in so many words, a limitation found in a claim, one skilled in the art on reading the specification and the claim would recognize that what is described in the specification necessarily encompasses what is recited in the claim.

6. In performing my analysis, I have reviewed the claims and specifications of the '573 Patent, '734 Patent and '440 Patent, and the specification and drawings of the '497 Application as originally filed on June 13, 1988, from the perspective of one having ordinary skill in the art of computers at that time. For the purposes of my analysis, a person having ordinary skill in the art in 1988 would have had a bachelor's degree in computer science or electrical engineering with a background in computers, or an equivalent level of knowledge and ability from working in industry for an appropriate number of years. I am well familiar with what the level of ordinary skill was in 1988 because at that time I was a Professor of computer science and each semester taught courses to students in both computer science and electrical engineering. One of ordinary skill in the art would have been familiar with then existing means for storage of digital information and transmission of digital information across telecommunications lines.

7. Based on the foregoing information and understanding, I have concluded that one of ordinary skill in the art in 1988 would have recognized the inventions claimed in the '573 Patent, '734 Patent and '440 Patent were necessarily comprehended by the description in the specification and drawings of the '497 Application. I make the following specific observations with respect to particular claim elements at issue:

A. “Transferring Money from a Second Party to a First Party,” “Charging a Fee,” “Providing a Credit Card Number,” and “Charging an Account”

8. First, I note that, throughout the specification, the '497 Application discusses electronic sales and distribution of digital audio signals (or digital video signals), e.g.

selling and distributing music over telephone lines, which are telecommunication lines. The claim language at issue; “transferring money electronically via a telecommunication line to a first party at a location remote from the second memory,” “charging a fee,” “providing a credit card number,” and “charging an account,” all would have been interpreted by one of ordinary skill in the art in the context of the described electronic sales and distribution. Thus, one of ordinary skill in the art in 1988 would have been familiar with various electronic means of making purchases over telecommunication lines. Indeed, by 1988 the definition of “money” had expanded well beyond traditional coin and paper currency to include stores of value in purely electronic form. At that time, “money” could be transferred from one account to another, or simply credited to an account purely electronically. Further, in 1988, it also was known to authorize payment, such as by credit card, electronically over telecommunications lines. This authorization would have involved providing an identification of credit card account information in the form of a credit card number. Further, since this ultimately would have resulted in a credit being made to an electronic account of a seller, it would have been understood to be an electronic transfer of money.

9. One of ordinary skill in the art in 1988 would have been aware of all of the above and would have considered them forms of electronic sales. The term “sale” involves a payment from one party to another party, which necessarily encompasses “charging a fee” to the purchasing party. Therefore, one of ordinary skill in the art would have recognized that, in the context of the electronic sale and distribution of digital audio signals (or digital video signals) over telephone lines, an electronic sale encompassed transactions where a fee is charged and thus money is transferred from one party to another electronically via a telecommunication line. It

further would have been understood by one of ordinary skill in the art that electronic sales could be accomplished by providing a credit card number. As a result, one of ordinary skill in the art in 1988 would have recognized that the description of electronic sales in the specification of the '479 Application necessarily comprehends "transferring money to a first party from a second party electronically via telecommunication lines," "charging a fee," "charging an account," and "providing a credit card number."

B. Transmitter/Receiver

10. I note that, throughout the specification, the '497 Application discusses electronic sales and distribution of digital audio signals (or digital video signals), e.g. electronically selling and distributing music over telephone lines, which are telecommunication lines. The specification of the '497 Application also explicitly discloses the electronic transfer of digital audio signals over telephone lines (telecommunication lines). Finally, the specification of the '497 Application further explicitly discloses control integrated circuits associated with the control units of both the copyright holder and user (purchaser).

11. One of ordinary skill in the art in 1988 would have been aware of the available means for connecting computer systems to telecommunication lines for the purpose of transferring electronic signals; for example modems. Such means could be used at the originating (transmitting) computer and at the destination (receiving) computer. The control unit or control integrated circuit of the copyright holder and user would have been recognized by one of ordinary skill in the art as being some type of computer system or part of a computer system.

12. Since the specification and figures as originally filed with the '497 Application explicitly show the control units being connected to telephone lines (telecommunications lines), one of ordinary skill in the art would have recognized this involved means, such as a modem, for connecting the two systems to the telephone lines. Although the specification of the '497 Application does not include an explicit description of a transmitter or receiver, one of ordinary skill in the art would have had no difficulty determining the nature of the transmitter or receiver necessary to perform the required function. Therefore, the terms in the claims, "transmitter" and "receiver", describe in so many words what would have been understood by one of ordinary skill in the art as being necessarily comprehended by the description provided in the specification and figures filed with the '497 Application.

C. Telephoning

13. As set forth above, the specification of the '497 Application explicitly teaches the sale and transfer of digital audio signals (or digital video signals) over telephone lines. Although not explicitly set forth in the specification of the '497 Application, it nonetheless would have been easily recognized by one of ordinary skill in the art in 1988 that the specification's teaching requires establishing some type of connectivity over telephone lines as a pre-requisite to making an electronic purchase/sale of digital signals over telephone lines, as well as for transferring the digital signals over telephone lines.

14. A successful telephone call, whether a human or machine originated function, always encompasses a step of initiating some type of connectivity. For example, the connectivity could be person to person, as over a voice line. As an alternative example, the

connectivity could be machine to machine, using either traditional telephone lines, optical fibers or cable. Other alternatives include person to machine connectivity and machine to person connectivity.

15. Since the specification of the '497 Application explicitly discloses electronically selling and distributing digital audio signals (or digital video signals) over telephone lines, it is clear that the step of requesting and establishing connectivity (telephoning) is necessarily comprehended in the description provided in the '497 Application, since the step would have been recognized as a prerequisite for performing the function of the disclosed system.

I further declare that all statements made herein of my own knowledge are true and that all statements made on information and belief are believed to be true; and further, that these statements are made with the knowledge that willful false statements and the like so made are punishable by fine or imprisonment, or both, under Section 1001 of Title 18 of the United States Code, and that such willful false statements may jeopardize the validity of the application or any patent issuing thereon.

11 May 2007

Date



Justin Douglas Tygar, Ph.D.

DOUG TYGAR

Address:

University of California.
102 South Hall #4600
Berkeley, CA 94720-4600
(510) 643-7855
tygar@cs.berkeley.edu

Personal Information:

Full name: Justin Douglas Tygar
US Citizen
Married to Xiaoniu Suchu Hsu

Education:

- A.B., 1982 **University of California, Berkeley**, *Math/Computer Science*
Bell Labs University Relations Student (1981)
- Ph.D., 1986 **Harvard University**, *Computer Science*
Thesis: *An Integrated Toolkit for Operating System Security*
Advisor: Michael Rabin
NSF Graduate Fellow (1982 – 1985), IBM Graduate Fellow (1985 – 1986)

Academic Appointments:

University of California, Berkeley
Department of Electrical Engineering and Computer Science
& School of Information Management and Systems
1998 – Present *Professor* (tenured, joint appointment)

Carnegie Mellon University
Computer Science Department
2000 – Present *Adjunct Professor*
1992 – 2000 *Associate Professor* (tenured 1995, on leave 1998 – 2000)
1986 – 1992 *Assistant Professor*

Major Awards:

NSF Presidential Young Investigator, 1988
Outstanding Professor Award, *Carnegie Magazine*, 1989
Chair, Defense Information Science and Technology Study Group on Security with Privacy
Member, National Research Council Committee on Information Trustworthiness
Member, INFOSEC Science and Technology Study Group
Okawa Foundation Fellow, 2003-4
Wide consulting for both industry and government

Major speeches:

Keynote addresses:

PODC (1995), ASIAN-96 (1996), NGITS (1997), VLDB (1998), CRYPTEC (1999),
CAV (2000), Human Authentication (2001), PDSN (2002), ISM (2005), ISC (2005), ASIACCS (2006),
Croucher ASI (2004, 2006)

Invited addresses:

Harvard Graduate School of Arts and Science 100th Anniversary,
CMU Computer Science Department 25th Anniversary
More than 240 talks & 20 professional seminars since 1985

External review activities:

Electronic Commerce Program, City University of Hong Kong
Information Systems Management Program, Singapore Management University
Information Technology Program, United Arab Emirates University
Computer Science Program, University of California, Davis

Publications

(Note: copies of most of these publications are available at www.tygar.net/publications.htm.)

Books

1. **Computer Security in the 21st Century.** Eds. D. Lee, S. Shieh, and J. D. Tygar. Springer, 2005. (This book includes item 7 below as well as a technical introduction by me and the other editors.)
2. **Secure Broadcast Communication in Wired and Wireless Networks.** A. Perrig and J. D. Tygar. Springer (Kluwer), 2003. Also, a Japanese translation with additional material appeared as **Waiyādo/Waiyaresu Nettowōku ni Okeru Burōdokyasuto Tsūshin no Sekyuriti** (ワイヤード/ワイヤレスネットワークにおけるブロードキャスト通信のセキュリティ), Translated by Fumio Mizoguchi and the Science University of Tokyo Information Media Science Research Group. Kyoritsu Shuppan, 2004.
3. **Trust in Cyberspace.** National Research Council Committee on Information Systems Trustworthiness (S. Bellovin, W. E. Boebert, M. Branstad, J. R. Catoe, S. Crocker, C. Kaufman, S. Kent, J. Knight, S. McGeedy, R. Nelson, A. Schiffman, F. Schneider [ed.], G. Spix, and J. D. Tygar). National Academy Press, 1999.

Book Chapters (does not include items listed above)

4. "Case Study: Acoustic Keyboard Emanations." L. Zhuang, F. Zhou, and J. D. Tygar. In **Phishing and Countermeasures: Understanding the Increasing Problem of Electronic Identity Theft**, eds. M. Jakobsson and S. Myers. Wiley-Interscience, 2007, pp. 221-240. (This is a popularized version of item 41.)
5. "Dynamic Security Skins." R. Dhamija and J. D. Tygar.. In **Phishing and Countermeasures: Understanding the Increasing Problem of Electronic Identity Theft**, eds. M. Jakobsson and S. Myers. Wiley-Interscience, 2007, pp. 339-351. (This is a popularized version of item 42.)
6. "Why Johnny can't encrypt: A usability evaluation of PGP 5.0." A. Whitten and J. D. Tygar. In **Security and Usability: Designing Secure Systems that People Can Use**, eds. L. Cranor and G. Simson. O'Reilly, 2005, pp. 679-702. (An earlier version of the paper was published in **Proceedings of the 8th USENIX Security Symposium**, August 1999, pp. 169-183. See also item 87.)
7. "Private matching." Y. Li, J. D. Tygar, J. Hellerstein. In **Computer Security in the 21st Century**, eds. D. Lee, S. Shieh, and J. D. Tygar. Springer, 2005, pp. 25-50. (See item 1.) (An early version of this paper appeared as Intel Research Laboratory Berkeley technical report IRB-TR-04-005, February 2004.)
8. "Digital cash." J. D. Tygar. In **Berkshire Encyclopedia of Human Computer Interaction**, ed. W. Bainbridge. Berkshire Publishing, 2004, pp. 167-170.

9. "Spamming." J. D. Tygar. In **Berkshire Encyclopedia of Human Computer Interaction**, ed. W. Bainbridge. Berkshire Publishing, 2004, pp. 673-675.
10. "Viruses." J. D. Tygar. In **Berkshire Encyclopedia of Human Computer Interaction**, ed. W. Bainbridge. Berkshire Publishing, 2004, pp. 788-791.
11. "Privacy in sensor webs and distributed information systems." J. D. Tygar. In **Software Security**, eds. M. Okada, B. Pierce, A. Scedrov, H. Tokuda, and A. Yonezawa. Springer, 2003, pp. 84-95.
12. "Atomicity in electronic commerce." J. D. Tygar. In **Internet Besieged**, eds. D. Denning and P. Denning. ACM Press and Addison-Wesley, 1997, pp. 389-405. (An expanded earlier version of this paper was published in **Proceedings of the Fifteenth Annual ACM Symposium on Principles of Distributed Computing, Keynote paper**, May 1996, pp. 8-26; and as Carnegie Mellon University Computer Science technical report CMU-CS-96-112, January 1996. See also item 28.)
13. "Cryptographic postage indicia." J. D. Tygar, B. Yee, and N. Heintze. In **Concurrency and Parallelism, Programming, Networking, and Security**, eds. J. Jaffar and R. Yap. Springer, 1996, pp. 378-391. (Preprint also available. Early versions appeared as Carnegie Mellon University Computer Science technical reports CMU-CS-96-113, January 1996, UC San Diego Computer Science technical report UCSD-TR-CS96-485, and in the 1996 **Securicom Proceedings**, Paris, 1996. See also item 89.)
14. "Dyad: A system for using physically secure coprocessors." J. D. Tygar and B. Yee. In **Technological Strategies for the Protection of Intellectual Property in the Networked Multimedia Environment**. Interactive Multimedia Association, 1994, pp. 121-152. (An early version appeared as Carnegie Mellon University Computer Science technical report CMU-CS-91-140R, May 1991.)
15. "A system for self-securing programs." J. D. Tygar and B. Yee. In **Carnegie Mellon Computer Science: A 25-Year Commemorative**, ed. R. Rashid. ACM Press and Addison-Wesley, 1991, pp. 163-197. (Note: The first printing of this volume had incorrect text due to a production error.)
16. "Implementing capabilities without a trusted kernel." M. Herlihy and J. D. Tygar. In **Dependable Computing for Critical Applications**, eds. A. Avizienis and J. Laprie. Springer, 1991, pp. 283-300. (Note: An early version appeared in the **(IFIP) Proceedings of the International Working Conference on Dependable Computing for Critical Applications**, August 1989.)
17. "Strongbox." J. D. Tygar and B. Yee. In **Camelot and Avalon: A Distributed Transaction Facility**, eds. J. Eppinger, L. Mummert, and A. Spector. Morgan-Kaufmann, 1991, pp. 381-400.
18. "ITOSS: An Integrated Toolkit for Operating System Security." M. Rabin and J. D. Tygar. In **Foundations of Data Organization**, eds. W. Litwin and H.-J. Shek. Springer, 1990, pp. 2-15. (Preprint also available.) (Note: Earlier, longer versions appeared as Harvard University Aiken Computation Laboratory technical report TR-05-87R and my Ph.D. dissertation.)
19. "Formal Semantics for Visual Specification of Security." M. Maimone, J. D. Tygar, and J. Wing. In **Visual Languages and Visual Programming**, ed. S. K. Chang. Plenum, 1990, pp.

97-116. (An early version was published in **Proceedings of the 1988 IEEE Workshop on Visual Programming**, pp. 45-51, and as Carnegie Mellon University Computer Science technical report CMU-CS-88-173r, December 1988.)

Journal Articles (does not include items listed above)

20. "Injecting Heterogeneity through Protocol Randomization." L. Zhuang, J. D. Tygar, R. Dhamija. In *International Journal of Network Security*, 4:1, January 2007, pp. 45-58.
21. "Cyber defense technology networking and evaluation." Members of the DETER and EMIST Projects (R. Bajcsy, T. Benzel, M. Bishop, B. Braden, C. Brodley, S. Fahmy, S. Floyd, W. Hardaker, A. Joseph, G. Kesidis, K. Levitt, B. Lindell, P. Liu, D. Miller, R. Mundy, C. Neuman, R. Ostrenga, V. Paxson, P. Porras, C. Rosenberg, S. Sastry, D. Sterne, J. D. Tygar, and S. Wu). In *Communications of the ACM*, 47:3, March 2004, pp. 58-61.
22. "Technological dimensions of privacy in Asia." J. D. Tygar. In *Asia-Pacific Review*, 10:2, November 2003, pp. 120-145.
23. "SPINS: Security protocols for sensor networks." A. Perrig, R. Szewczyk, J. D. Tygar, V. Wen, and D. Culler. In *[ACM Journal of] Wireless Networks*, 8:5, September 2002, pp. 521-534. (An early version of this paper appears in **Proceedings of the 7th Annual International Conference on Mobile Computing and Networks (MOBICOM)**, July 2001, pp. 189-199.)
24. "The TESLA broadcast authentication protocol." A. Perrig, R. Canneti, J. D. Tygar, and D. Song. In *CryptoBytes*, 5:2, Summer/Fall 2002, pp. 2-13.
25. "SAM: A flexible and secure auction architecture using trusted hardware." A. Perrig, S. Smith, D. Song, and J. D. Tygar. In *Electronic Journal on E-commerce Tools and Applications*, 1:1, January 2002 (online journal). (An early version of this paper appeared in **Proceedings of the 1st IEEE International Workshop on Internet Computing and Electronic Commerce**, April 2001, pp. 1764-1773.)
26. "Why isn't the internet secure yet?" J. D. Tygar and A. Whitten. In *ASLIB Proceedings*, 52:3, March 2000, pp. 93-97.
27. "Multi-round anonymous auction protocols." H. Kikuchi, M. Harkavy, and J. D. Tygar. In *Institute of Electronics, Information, and Communication Engineers Transactions on Information and Systems*, E82-D:4, April 1999, pp. 769-777. (An early version appeared in **Proceedings of the First IEEE Workshop on Dependable and Real-Time E-Commerce Systems (DARE '98)**, June 1998, pp. 62-69.)
28. "Atomicity in electronic commerce." J. D. Tygar. In *ACM NetWorker*, 2:2, April/May 1998, pp. 32-43. (Note: this is a revision of item 12 published together with a new article: "An update on electronic commerce." In *ACM NetWorker*, Volume 2, Number 2, April/May 1998, pp. 40-41.)
29. "A model for secure protocols and their compositions." N. Heintze and J. D. Tygar. In *IEEE Transactions on Software Engineering*, 22:1, January 1996, pp. 16-30. (An extended abstract appeared in **Proceedings of the 1994 IEEE Symposium on Security and Privacy**, May 1994, pp. 2-13. Another early version appeared as Carnegie Mellon University Computer Science technical report CMU-CS-92-100, January 1992.)

30. "NetBill: An Internet commerce system optimized for network-delivered services." M. Sirbu and J. D. Tygar. In *IEEE Personal Communications*, 2:4, August 1995, pp. 34-39. (An early version appeared in **Proceedings of Uniform '96**, February 1996, pp. 203-226. Another early version appeared in **Proceedings of the 40th IEEE Computer Society International Conference**, Spring 1995, pp. 20-25.)
31. "Optimal sampling strategies for quicksort." C. C. McGeoch and J. D. Tygar. In *Random Structures and Algorithms*, 7:4, 1995, pp. 287-300. (An early version appeared in **Proceedings of the 28th Annual Allerton Conference on Communication, Control, and Computing**, October 1990, pp. 62-71.)
32. "Geometric characterization of series-parallel variable resistor networks." R. Bryant, J. D. Tygar, and L. Huang. In *IEEE Transactions on Circuits and Systems I: Fundamental Theory and Applications*, 41:11, November 1994, pp. 686-698. (Preprint also available.) (An early version appeared in **Proceedings of the 1993 IEEE International Symposium on Circuits and Systems**, May 1993, pp. 2678-2681.)
33. "Computability and complexity of ray tracing." J. Reif, J. D. Tygar, and A. Yoshida. In *Discrete and Computational Geometry*, 11:3, April 1994, pp. 265-287. (An early version appeared in **Proceedings of the 31st Annual IEEE Symposium on Foundations of Computer Science**, October 1990, pp. 106-114.)
34. "Specifying and checking Unix security constraints." A. Heydon and J. D. Tygar. In *Computing Systems*, 7:1, Winter 1994, pp. 91-112. (An early version appeared in **Proceedings of the 3rd USENIX Security Symposium**, September 1992, pp. 211-226, preprint also available.)
35. "Protecting privacy while preserving access to data." L. J. Camp and J. D. Tygar. In *The Information Society*, 10:1, January 1994, pp. 59-71.
36. "Miro: visual specification of security." A. Heydon, M. Maimone, J. D. Tygar, J. Wing, and A. Zaremski. In *IEEE Transactions on Software Engineering*, 16:10, October 1990, pp. 1185-1197. (An early version appeared as Carnegie Mellon University Computer Science Department technical report CMU-CS-89-199, December 1989.)
37. "Efficient parallel pseudo-random number generation." J. Reif and J. D. Tygar. In *SIAM Journal of Computation*, 17:2, April 1988, pp. 404-411. (An early version appeared in **Proceedings of CRYPTO-85**, eds. E. Brickell and H. Williams, Springer, 1986, pp. 433-446.)
38. "Review of **Abstraction and Specification in Program Development**." J. D. Tygar. In *ACM Computing Reviews*, 28:9, September 1987, pp. 454-455.

Refereed Conference Papers (does not include items listed above)

39. "Why Phishing Works." R. Dhamija, J. D. Tygar, and M. Hearst. To appear in **Proceedings of CHI-2006: Conference on Human Factors in Computing Systems**, April 2006.
40. "Can Machine Learning Be Secure?" M. Barreno, B. Nelson, R. Sears, A. Joseph, and J. D. Tygar. *Invited paper*. To appear in **Proceedings of the ACM Symposium on Information, Computer, and Communication Security**, March 2006.

41. "Keyboard Acoustic Emanations Revisited." L. Zhuang, F. Zhou, and J. D. Tygar. In **Proceedings of the 12th ACM Conference on Computer and Communications Security**, November 2005, pp. 373-382. (See also item 4.)
42. "The Battle Against Phishing: Dynamic Security Skins." R. Dhamija and J. D. Tygar. In **SOUPS 2005: Proceedings of the 2005 ACM Symposium on Usable Security and Privacy**, *ACM International Conference Proceedings Series*, ACM Press, July 2005, pp. 77-88. (See also item 5.)
43. "Collaborative filtering CAPTCHAs." M. Chew and J. D. Tygar. In **Human Interactive Proofs: Second International Workshop (HIP 2005)**, eds. H. Baird and D. Lopresti, Springer, May 2005, pp. 66-81.
44. "Phish and HIPs: Human interactive proofs to detect phishing attacks." R. Dhamija and J. D. Tygar. In **Human Interactive Proofs: Second International Workshop (HIP 2005)**, eds. H. Baird and D. Lopresti, Springer, May 2005, pp. 127-141.
45. "Image recognition CAPTCHAs." M. Chew and J. D. Tygar. In **Proceedings of the 7th International Information Security Conference (ISC 2004)**, Springer, September 2004, pp. 268-279. (A longer version appeared as UC Berkeley Computer Science Division technical report UCB/CSD-04-1333, June 2004.)
46. "Side effects are not sufficient to authenticate software." U. Shankar, M. Chew, and J. D. Tygar. In **Proceedings of the 13th USENIX Security Symposium**, August 2004, pp. 89-101. (A version with an additional appendix appeared as UC Berkeley Computer Science Division technical report UCB/CSD-04-1363, September 2004.)
47. "Statistical monitoring + predictable recovery = Self-*." A. Fox, E. Kiciman, D. Patterson, R. Katz, M. Jordan, I. Stoica and J. D. Tygar. In **Proceedings of the 2nd Bertinoro Workshop on Future Directions in Distributed Computing (FuDiCo II)**, June 2004 (online proceedings).
48. "Distillation codes and their application to DoS resistant multicast authentication." C. Karlof, N. Sastry, Y. Li, A. Perrig, and J. D. Tygar. In **Proceedings of the Network and Distributed System Security Conference (NDSS 2004)**, February 2004, pp. 37-56.
49. "Privacy and security in the location-enhanced World Wide Web." J. Hong, G. Boriello, J. Landay, D. McDonald, B. Schilit, and J. D. Tygar. In **Proceedings of the Workshop on Privacy at Ubicomp 2003**, October 2003 (online proceedings).
50. "The problem with privacy." J. D. Tygar. *Keynote paper*. In **Proceedings of the 2003 IEEE Workshop on Internet Applications**, June 2003, pp. 2-8.
51. "Safe staging for computer security." A. Whitten and J. D. Tygar. In **Proceedings of the 2003 Workshop on Human-Computer Interaction and Security Systems**, April 2003 (online proceedings).
52. "Expander graphs for digital stream authentication and robust overlay networks." D. Song, D. Zuckerman, and J. D. Tygar. In **Proceedings of the 2002 IEEE Symposium on Security and Privacy**, May 2002, pp. 258-270.

53. "ELK: A new protocol for efficient large-group key distribution." A. Perrig, D. Song, and J. D. Tygar. In **Proceedings of the 2001 IEEE Symposium on Security and Privacy**, May 2001, pp. 247-262.
54. "Efficient and secure source authentication for multicast." A. Perrig, R. Canetti, D. Song, and J. D. Tygar. In **Proceedings of the Internet Society Network and Distributed System Security Symposium (NDSS 2001)**, February 2001, pp. 35-46.
55. "Efficient authentication and signing of multicast streams over lossy channels." A. Perrig, R. Canetti, J. D. Tygar, and D. Song. In **Proceedings of the 2000 IEEE Symposium on Security and Privacy**, May 2000, pp. 56-73..
56. "Flexible and scalable credential structures: NetBill implementation and experience." Y. Kawakura, M. Sirbu., I. Simpson, and J. D. Tygar. In **Proceedings of the International Workshop on Cryptographic Techniques and E-Commerce**, July 1999, pp. 231-245.
57. "Open problems in electronic commerce." J. D. Tygar. *Invited address*. In **Proceedings of the 18th ACM SIGMOD-SIGACT-SIGART Symposium on Principles of Database Systems (PODS 1999)**, May 1999, p. 101.
58. "Electronic auctions with private bids." M. Harkavy, J. D. Tygar, and H. Kikuchi. In **Proceedings of the 3rd USENIX Workshop on Electronic Commerce**, September 1998, pp. 61-73.
59. "Atomicity versus anonymity: Distributed transactions for electronic commerce." J. D. Tygar. In **Proceedings of the 24th International Conference on Very Large Data Bases**, August 1998, pp. 1-12.
60. "Smart cards in hostile environments." H. Gobiuff, S. Smith, J. D. Tygar, and B. Yee. In **Proceedings of the 2nd USENIX Workshop on Electronic Commerce**, November 1996, pp. 23-28. (An early version appeared as Carnegie Mellon University Computer Science technical report CMU-CS-95-188, September 1995.)
61. "Anonymous atomic transactions." L. J. Camp, M. Harkavy, and B. Yee. In **Proceedings of the 2nd USENIX Workshop on Electronic Commerce**, November 1996, pp. 123-133. (Preprint also available.) (An early version appeared as Carnegie Mellon University Computer Science technical report CMU-CS-96-156, July 1996.)
62. "Model checking electronic commerce protocols." N. Heintze, J. D. Tygar, J. Wing, and H. Wong. In **Proceedings of the 2nd USENIX Workshop on Electronic Commerce**, November 1996, pp. 147-164.
63. "WWW electronic commerce and Java Trojan horses." J. D. Tygar and A. Whitten. In **Proceedings of the 2nd USENIX Workshop on Electronic Commerce**, November 1996, pp. 243-250.
64. "Building blocks for atomicity in electronic commerce." J. Su and J. D. Tygar. In **Proceedings of the 6th USENIX Security Symposium**, July 1996, pp. 97-102.
65. "Token and notational money in electronic commerce." L. J. Camp, M. Sirbu, and J. D. Tygar. In **Proceedings of the 1st USENIX Workshop on Electronic Commerce**, July 1995, pp. 1-12.

(An early version was presented at the Telecommunications Policy Research Conference, October 1994.)

66. "NetBill security and transaction protocol." B. Cox, J. D. Tygar, and M. Sirbu. In **Proceedings of the 1st USENIX Workshop on Electronic Commerce**, July 1995, pp. 77-88.
67. "Secure coprocessors in electronic commerce applications." B. Yee and J. D. Tygar. In **Proceedings of the 1st USENIX Workshop on Electronic Commerce**, July 1995, pp. 155-170.
68. "Completely asynchronous optimistic recovery with minimal rollbacks." S. Smith, D. Johnson, and J. D. Tygar. In **Proceedings of the 25th IEEE Symposium on Fault-Tolerant Computing**, June 1995, pp. 361-370. (An early version appears as Carnegie Mellon University Computer Science technical report CMU-CS-94-130, March 1994.)
69. "A fast off-line electronic currency protocol." L. Tang and J. D. Tygar. In **CARDIS 94: Proceedings of the First IFIP Smart Card Research and Advanced Application Conference**, October 1994, pp. 89-100.
70. "Security and privacy for partial order time." S. Smith and J. D. Tygar. In **Proceedings 1994 Parallel and Distributed Computing Systems Conference**, October 1994, pp. 70-79. (Early versions appeared as Carnegie Mellon University Computer Science technical reports CMU-CS-93-116, October 1991 and February 1993, and CMU-CS-94-135, April 1994.)
71. "Certified electronic mail." A. Bahreman and J. D. Tygar. In **Proceedings of the 1994 Network and Distributed Systems Security Conference**, February 1994, pp. 3-19.
72. "Miro tools." A. Heydon, M. Maimone, A. Moormann, J. D. Tygar and J. Wing. In **Proceedings of the 3rd IEEE Workshop on Visual Languages**, October 1989, pp. 86-91. (A preprint appeared as Carnegie Mellon University Computer Science technical report CMU-CS-89-159, July 1989.)
73. "Constraining pictures with pictures." A. Heydon, M. Maimone, A. Moormann, J. D. Tygar, and J. Wing. In **Information Processing 89: Proceedings of the 11th World Computer Congress**, August 1989, pp. 157-162. (An early version appeared as Carnegie Mellon University Computer Science technical report CMU-CS-88-185, November 1988.)
74. "How to make replicated data secure." M. Herlihy and J. D. Tygar. In **Proceedings of CRYPTO-87**, ed. C. Pomerance, 1988, pp. 379-391. (An early version appeared as Carnegie Mellon University Computer Science Technical Report CMU-CS-87-143, August 1987.)
75. "Visual specification of security constraints." J. D. Tygar and J. Wing. In **Proceedings of the 1987 (First IEEE) Workshop on Visual Languages**, August 1987, pp. 288-301. (A preprint appeared as Carnegie Mellon University Computer Science Technical Report CMU-CS-87-122, May 1987.)
76. "Efficient netlist comparison using hierarchy and randomization." J. D. Tygar and R. Ellickson. In **Proceedings of the 22nd ACM/IEEE Design Automation Conference**, Las Vegas, NV, July 1985, pp. 702-708.
77. "Hierarchical logic comparison." R. Ellickson and J. D. Tygar. In **Proceedings of MIDCON '84**, 1984.

Other Conference Publications (does not include items listed above)

78. "When Computer Security Crashes with Multimedia." [Abstract] J. D. Tygar. In **Proceedings of the 7th International IEEE Symposium on Multimedia**, December 2005, p. 2.
79. "Notes from the Second USENIX Workshop on Electronic Commerce." M. Harkavy, A. Meyers, J. D. Tygar, A. Whitten, and H. Wong. In **Proceedings of the 3rd USENIX Workshop on Electronic Commerce**, September 1998, pp. 225-242.
80. "How are we going to pay for this? Fee-for-service in distributed systems -- research and policy issues." C. Clifton, P. Gemmel, E. Means, M. Merges, J. D. Tygar. In **Proceedings of the 15th International Conference on Distributed Computing Systems**, May 1995, pp. 344-348.
81. "Miro: A visual language for specifying security." [Abstract] M. Maimone, A. Moorman, J. D. Tygar, J. Wing. In **Proceedings of the (First) USENIX UNIX Security Workshop**, August 1988, p. 49.
82. "StrongBox: support for self-securing programs." [Abstract] J. D. Tygar, B. Yee, and A. Spector. In **Proceedings of the (First) USENIX UNIX Security Workshop**, August 1988, p. 50.

Standards Documents (does not include items listed above)

83. **TESLA: Multicast Source Authentication Transform Introduction**. A. Perrig, D. Song, R. Canetti, J. D. Tygar, B. Briscoe. IETF RFC 4082. June 2005. (Early drafts of this RFC were published in October 2002, and in May, August, and December 2004.)
84. **Performance Criteria for Information-Based Indicia and Security Architecture for Closed IBI Postage Metering Systems (PCIBI-C) (Draft)**. United States Postal Service. January 1999. (Note: I was a major contributor to this document.)
85. **Performance Criteria for Information-Based Indicia and Security Architecture for Open IBI Postage Evidence Systems (PCIBI-O) (Draft)**. United States Postal Service. February 2000. (Note: I was a major contributor to this document.)
86. **Production, Distribution, and Use of Postal Security Devices and Information Based Indicia**." United States Postal Service. *Federal Register* 65:191, October 2, 2000, pp. 58682-58698. (Note: I was a major contributor to this document.)

Technical Reports (does not include items listed above)

87. **Usability of Security: A Case Study**. A. Whitten and J. D. Tygar. Carnegie Mellon University Computer Science technical report CMU-CS-98-155, December 1998. (Note: this report partly overlaps item 6, but also includes substantial additional material.)
88. **Security for Network Attached Storage Devices**. H. Gobioff, G. Gibson and J. D. Tygar. Carnegie Mellon University Computer Science technical report CMU-CS-97-185, October 1997.
89. **Cryptography: It's Not Just for Electronic Mail Anymore**. J. D. Tygar and B. Yee. Carnegie Mellon University Computer Science technical report CMU-CS-93-107, March 1993. (See also item 13 above.)

90. **Median Separators in d Dimensions.** J. Sipelstein, S. Smith, and J. D. Tygar . Carnegie Mellon University Computer Science technical report CMU-CS-88-206, December 1988.
91. **When are Best Fit and First Fit Optimal?** C. McGeoch and J. D. Tygar. Carnegie Mellon University Computer Science technical report CMU-CS-87-168, October 1987.
92. **Display Manager User's Guide.** J. D. Tygar. Valid Logic Systems engineering memorandum, VED-050682-1-JDT, May 1982.
93. **Performance analysis of the DANTE Network.** Bell Telephone Laboratories technical memorandum, August 1981.

Patents (does not include items listed above)

94. **Anonymous certified delivery.** L. J. Camp, J. D. Tygar, and M. Harkavy. US Patent 6,076,078, June 13, 2000.
95. **Method and apparatus for purchasing and delivering digital goods over a network.** M. Sirbu, J. D. Tygar, B. Cox, T. Wagner. US Patent 5,809,144, September 15, 1998.

Miscellaneous Technical (does not include items listed above)

96. **Security with Privacy.** Briefing from the Information Science and Technology Study Group on Security and Privacy (chair: J. D. Tygar). December 2002.
97. **Expert Report of J. D. Tygar ... A&M Records et al v. Napster....** J. D. Tygar. (For Hearing) July 2000.

Miscellaneous Non-Technical (does not include items listed above)

98. "Welcome Multiculturalism (Letter to the Editor)." J. D. Tygar. *Taipei Times*, November 12, 2004, p. 8.

Attorney Docket No. 219099/573

In re Application of: ARTHUR R. HAIR
Reexamination Control No. 90/007,402
Reexamination Filed: January 31, 2005
Patent Number: 5,191,573
Title: METHOD FOR TRANSMITTING A DESIRED DIGITAL
VIDEO OR AUDIO SIGNAL
CERTIFICATE UNDER 37 C.F.R. 1.10

EXPRESS MAIL Label No.: EV 390816036US

Date of Deposit: May 17, 2007

I hereby certify that this the following correspondence

Response; Copy of cited publication; Declaration Under 37 CFR § 1.132; and

Certificate of Service

along with any paper referred to as being attached or enclosed, and/or fee, is being deposited with the United States Postal Service, "EXPRESS MAIL-POST OFFICE TO ADDRESSEE" service under 37 C.F.R. 1.10, on the date indicated above, and addressed to: MAIL STOP *Ex Parte* Reexamination, Commissioner for Patents, P.O. Box 1450, Alexandria, VA 22313-1450.

Karen M. Spina

(Typed or printed name of person mailing paper)



Signature of person mailing paper or fee)

Drinker Biddle & Reath LLP
One Logan Square
18th and Cherry Streets
Philadelphia, PA 19103
Customer No. 23973

IN THE UNITED STATES PATENT AND TRADEMARK OFFICE

In re Application of: 56548 U.S. PTO)
ARTHUR R. HAIR )
05/17/07)
Reexamination Control No. 90/007,402)
Reexamination Filed: January 31, 2005) METHOD FOR TRANSMITTING
Patent Number: 5,191,573) A DESIRED DIGITAL VIDEO OR
Examiner: Roland Foster) AUDIO SIGNAL
)

MAIL STOP *Ex Parte* Reexamination
Commissioner for Patents
P.O. Box 1450
Alexandria, VA 22313-1450

TRANSMITTAL

In response to the Office Action mailed on March 17, 2007 in the above-captioned reexamination, to which a response is due May 17, 2007, enclosed herewith are the following:

Response;
Copy of cited publication;
Declaration Under 37 CFR § 1.132; and
Certificate of Service.

No fee is believed due to support this submission. However, should any fee be due, authorization is hereby given to charge **Deposit Account No. 50-0573**.

Respectfully submitted,
DRINKER BIDDLE & REATH LLP

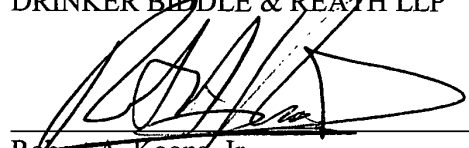
Robert A. Koons, Jr.
Registration No. 32,474

DRINKER BIDDLE & REATH LLP
One Logan Square
18th & Cherry Streets
Philadelphia, PA 19103-6996
Telephone: (215) 988-3392
Facsimile: (215) 988-2757
Customer No. 23973

PHIP5433661

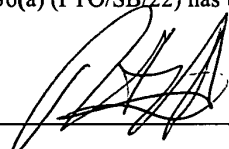
NOTICE OF APPEAL FROM THE EXAMINER TO THE BOARD OF PATENT APPEALS AND INTERFERENCES	Docket Number (Optional) NAPS001
I hereby certify that this correspondence is being deposited with the United States Postal Service with sufficient postages as first class mail in an envelope addressed to "Commissioner for Patents, P.O. Box 1450, Alexandria, VA 22313-1450" [37 CFR 1.8(a)] on _____ Signature _____ Typed or printed name: _____	In re Application of: Arthur R. Hair Control Number: 90/007,402 Filed: January 31, 2005 For: METHOD FOR TRANSMITTING A DESIRED DIGITAL VIDEO OR AUDIO SIGNAL Art Unit: 3992 Examiner: Roland G. Foster
Patentee (s) hereby appeal(s) to the Board of Patent Appeals and Interferences from the last decision of the examiner rejecting claims 1 through 6 and 44 through 49 in reexamination.	
The fee for this Notice of Appeal is (37 CFR 41.20(b)(1)) \$<u>500.00</u>	
<input type="checkbox"/> Patentee claims small entity status. See 37 CFR 1.27. Therefore, the fee shown above is reduced by half, and the resulting fee is: \$ _____.	
<input checked="" type="checkbox"/> A check in the amount of the fee is enclosed.	
<input type="checkbox"/> Payment by credit card. Form PTO-2038 is attached.	
<input type="checkbox"/> The Director has already been authorized to charge fees in this application to a Deposit Account. I have enclosed a duplicate copy of this sheet.	
<input checked="" type="checkbox"/> The Director is hereby authorized to charge any fees which may be required, or credit any overpayment to Deposit Account No. <u>50-0573</u> . I have enclosed a duplicate copy of this sheet.	
<input type="checkbox"/> A petition for an additional ___ month extension of time under 37 CFR 1.136(a) (PTO/SB/22) has been submitted.	
I am the	Signature: 
<input type="checkbox"/> applicant/inventor	Typed or printed name: Robert A. Koons, Jr., Esq.
<input type="checkbox"/> assignee of record of the entire interest. See 37 CFR 3.71. Statement under 37 CFR 3.73(b) is Enclosed. (Form PTO/SB/96)	Telephone Number: <u>215-988-3392</u>
<input checked="" type="checkbox"/> attorney or agent of record. Registration Number: 32,474	Date: <u>31 May 2007</u>
<input type="checkbox"/> attorney or agent acting under 37 CFR 1.34. Registration number if acting under 37 CFR 1.34:	
NOTE: Signatures of all the inventors or assignees of record of the entire interest or their representative(s) are required. Submit multiple forms if more than one signature is required, see below.*	
<input checked="" type="checkbox"/> Total of <u>1</u> forms are submitted.	

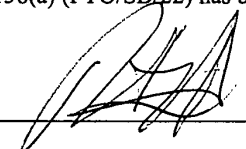
<p>NOTICE OF APPEAL FROM THE EXAMINER TO THE BOARD OF PATENT APPEALS AND INTERFERENCES</p>	<p>Docket Number (Optional) NAPS001</p>
<p>I hereby certify that this correspondence is being deposited with the United States Postal Service with sufficient postages as first class mail in an envelope addressed to "Commissioner for Patents, P.O. Box 1450, Alexandria, VA 22313-1450" [37 CFR 1.8(a)] on _____ Signature _____ Typed or printed name: _____</p>	<p>In re Application of: Arthur R. Hair Control Number: 90/007,402 Filed: January 31, 2005 For: METHOD FOR TRANSMITTING A DESIRED DIGITAL VIDEO OR AUDIO SIGNAL Art Unit: 3992 Examiner: Roland G. Foster</p>
<p>Patentee (s) hereby appeal(s) to the Board of Patent Appeals and Interferences from the last decision of the examiner rejecting claims 1 through 6 and 44 through 49 in reexamination.</p> <p>The fee for this Notice of Appeal is (37 CFR 41.20(b)(1)) \$<u>500.00</u></p> <p><input type="checkbox"/> Patentee claims small entity status. See 37 CFR 1.27. Therefore, the fee shown above is reduced by half, and the resulting fee is: \$ _____.</p> <p><input checked="" type="checkbox"/> A check in the amount of the fee is enclosed.</p> <p><input type="checkbox"/> Payment by credit card. Form PTO-2038 is attached.</p> <p><input type="checkbox"/> The Director has already been authorized to charge fees in this application to a Deposit Account. I have enclosed a duplicate copy of this sheet.</p> <p><input checked="" type="checkbox"/> The Director is hereby authorized to charge any fees which may be required, or credit any overpayment to Deposit Account No. <u>50-0573</u>. I have enclosed a duplicate copy of this sheet.</p> <p><input type="checkbox"/> A petition for an additional ___ month extension of time under 37 CFR 1.136(a) (PTO/SB/22) has been submitted.</p> <p>I am the</p> <p><input type="checkbox"/> applicant/inventor</p> <p><input type="checkbox"/> assignee of record of the entire interest. See 37 CFR 3.71. Statement under 37 CFR 3.73(b) is Enclosed. (Form PTO/SB/96)</p> <p><input checked="" type="checkbox"/> attorney or agent of record. Registration Number: 32,474</p> <p><input type="checkbox"/> attorney or agent acting under 37 CFR 1.34. Registration number if acting under 37 CFR 1.34: _____</p> <p style="text-align: right;">Signature:  Typed or printed name: Robert A. Koons, Jr., Esq. Telephone Number: <u>215-988-3392</u> Date: <u>31 May 2007</u></p> <p>NOTE: Signatures of all the inventors or assignees of record of the entire interest or their representative(s) are required. Submit multiple forms if more than one signature is required, see below.*</p> <p><input checked="" type="checkbox"/> Total of <u>1</u> forms are submitted.</p>	

CERTIFICATE OF SERVICE

The undersigned hereby certifies that a true and correct copy of the foregoing Notice of Appeal from Final Rejection in Reexamination No. 90/007,402 was served via First Class United States Mail, postage prepaid, this 31st day of May 2007, on the following:

Mr. Albert S. Penilla
Martine, Penilla, & Gencarella, LLP
710 Lakeway Drive, Suite 200
Sunnyvale, CA 94085
Attorney for Third Party Reexamination Requester

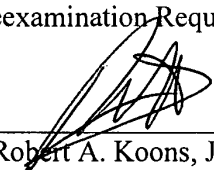
By: 
Robert A. Koons, Jr.
Attorney for Patentee

CERTIFICATE OF MAILING BY "EXPRESS MAIL" (37 CFR 1.10)Applicant(s): **Arthur R. Hair**

Docket No.

NAPSP001

Application No.

90/007,402

Filing Date

January 31, 2005

Examiner

Roland G. Foster

Customer No.

023973

Group Art Unit

3992Invention: **METHOD FOR TRANSMITTING A DESIRED DIGITAL VIDEO OR AUDIO SIGNAL**

70181 U.S. PTO



05/31/07

I hereby certify that the following correspondence:

Notice of Appeal (Form PTO/SB/31) (1p.); Check (\$500.00); Post Card*(Identify type of correspondence)*

is being deposited with the United States Postal Service "Express Mail Post Office to Addressee" service under 37 CFR 1.10 in an envelope addressed to: Commissioner for Patents, P.O. Box 1450, Alexandria, VA 22313-1450 on

May 31, 2007*(Date)***Lisa Richardson***(Typed or Printed Name of Person Mailing Correspondence)**(Signature of Person Mailing Correspondence)***EV 471677348 US***("Express Mail" Mailing Label Number)***Note: Each paper must have its own certificate of mailing.**

Drinker Biddle & Reath LLP
 One Logan Square
 18th & Cherry Streets
 Philadelphia, PA 19103

Litigation Search Report CRU 3999

Reexam Control No. 90/007,402

TO: Roland Foster

Location: CRU

Art Unit: 3992

Date: 07/17/07

Case Serial Number: 90/007,402

From: Patricia Volpe

Location: CRU 3999

MDW 7C69

Phone: (571) 272-6825

Patricia.volpe@uspto.gov

Search Notes

Litigation was found involving U.S. Patent Number 5,191,573

Status- CLOSED 2:04cv1549 Sightsound Tech v. Roxio, Inc, et al

Sources:

- 1) I performed a KeyCite Search in Westlaw, which retrieves all history on the patent including any litigation.
- 2) I performed a search on the patent in Lexis CourtLink for any open dockets or closed cases.
- 3) I performed a search in Lexis in the Federal Courts and Administrative Materials databases for any cases found.
- 4) I performed a search in Lexis in the IP Journal and Periodicals database for any articles on the patent.
- 5) I performed a search in Lexis in the news databases for any articles about the patent or any articles about litigation on this patent.



Date of Printing: JUL 17,2007

KEYCITE

HUS PAT 5191573 METHOD FOR TRANSMITTING A DESIRED DIGITAL VIDEO OR AUDIO SIGNAL, (Mar 02, 1993)

History
Direct History

- => 1 **METHOD FOR TRANSMITTING A DESIRED DIGITAL VIDEO OR AUDIO SIGNAL, US PAT 5191573, 1993 WL 1138260 (U.S. PTO Utility Mar 02, 1993) (NO. 586391)**
Construed by
- H** 2 **SightSound.Com Inc. v. N2K, Inc., 185 F.Supp.2d 445 (W.D.Pa. Feb 08, 2002) (NO. CIV.A.98-CV-118)**
- => 3 **METHOD FOR TRANSMITTING A DESIRED DIGITAL VIDEO OR AUDIO SIGNAL, US PAT 5191573, 1993 WL 1138260 (U.S. PTO Utility Mar 02, 1993) (NO. 586391)**
Ruled Valid by
- H** 4 **Sightsound.com Inc. v. N2K, Inc., 391 F.Supp.2d 321 (W.D.Pa. Oct 24, 2003) (NO. CIV.A. 98-CV-118)**
- H** 5 **SYSTEM FOR TRANSMITTING DESIRED DIGITAL VIDEO OR AUDIO SIGNALS, US PAT 5675734, 1997 WL 1488819 (U.S. PTO Utility Oct 07, 1997) (NO. 607648)**
Construed by
- H** 6 **SightSound.Com Inc. v. N2K, Inc., 185 F.Supp.2d 445 (W.D.Pa. Feb 08, 2002) (NO. CIV.A.98-CV-118)**
- H** 7 **SYSTEM FOR TRANSMITTING DESIRED DIGITAL VIDEO OR AUDIO SIGNALS, US PAT 5675734, 1997 WL 1488819 (U.S. PTO Utility Oct 07, 1997) (NO. 607648)**
Ruled Valid by
- H** 8 **Sightsound.com Inc. v. N2K, Inc., 391 F.Supp.2d 321 (W.D.Pa. Oct 24, 2003) (NO. CIV.A. 98-CV-118)**
- H** 9 **SYSTEM AND METHOD FOR TRANSMITTING DESIRED DIGITAL VIDEO OR DIGITAL AUDIO SIGNALS, US PAT 5966440, 1999 WL 1731614 (U.S. PTO Utility Oct 12, 1999) (NO. 471964)**
Construed by
- H** 10 **SightSound.Com Inc. v. N2K, Inc., 185 F.Supp.2d 445 (W.D.Pa. Feb 08, 2002) (NO. CIV.A.98-CV-118)**
- H** 11 **SYSTEM AND METHOD FOR TRANSMITTING DESIRED DIGITAL VIDEO OR DIGITAL AUDIO SIGNALS, US PAT 5966440, 1999 WL 1731614 (U.S. PTO Utility Oct 12, 1999) (NO. 471964)**

© Copyright 2007 West, Carswell, Sweet & Maxwell Asia and Thomson Legal & Regulatory Limited, ABN 64 058 914 668, or their Licensors. All rights reserved.

Ruled Valid by

- H** 12 Sightsound.com Inc. v. N2K, Inc., 391 F.Supp.2d 321 (W.D.Pa. Oct 24, 2003) (NO. CIV.A. 98-CV-118)

Court Documents
Trial Court Documents (U.S.A.)

W.D.Pa. Expert Testimony

- 13 SIGHTSOUND.COM INCORPORATED, a Pennsylvania corporation, Plaintiff, v. N2K, INC., a Delaware corporation, Cdnw, Inc., a Pennsylvania corporation, and Cdnw Online, Inc., a Pennsylvania corporation, Defendants., 1998 WL 34373758 (Expert Report and Affidavit) (W.D.Pa. 1998) **Opening Expert Report of James A. Moorer** (NO. 98-0118)
- 14 SIGHTSOUND.COM INCORPORATED, A Pennsylvania corporation, Plaintiff, v. N2K, INC., a Delaware corporation CDNOW, Inc., A Pennsylvanica corporation, and CDNOW Online, Inc., a Pennsylvania corporation, Defendants., 2001 WL 34891529 (Expert Deposition) (W.D.Pa. Apr. 19, 2001) **Proceedings** (NO. 98-118)
- 15 SIGHTSOUND.COM INCORPORATED, a Pennsylvania corporation, Plaintiff, v. N2K, INC., a Delaware Corporation, CDNOW, INC., a CDNOW Online, Inc., a Pennsylvania corporation, Defendants., 2002 WL 32994569 (Expert Report and Affidavit) (W.D.Pa. Dec. 24, 2002) **Expert Report of Michael Ian Shamos, Ph.D., J.D.** (NO. 98-118)
- 16 SIGHTSOUND.COM INCORPORATED, Plaintiff, v. N2K, INC., CDNow, Inc., and CDNow Online, Inc., Defendants., 2003 WL 24288805 (Expert Report and Affidavit) (W.D.Pa. Jan. 21, 2003) **Expert Report of Justin Douglas Tygar, Ph.D.** (NO. 98-0118)
- 17 SIGHTSOUND.COM INCORPORATED, a Pennsylvania corporation, Plaintiff, v. N2K, INC., a Delaware corporation, Cdnw, Inc., a Pennsylvania corporation, and Cdnw Online, Inc., a Pennsylvania corporation, Defendants., 2003 WL 24288806 (Expert Report and Affidavit) (W.D.Pa. Feb. 19, 2003) **Rebuttal Expert Report of James A. Moorer to Opening Report of Professor Tygar** (NO. 98-0118)
- 18 SIGHTSOUND.COM INCORPORATED a Pennsylvania corporation, Plaintiff, v. N2K, INC., a Delaware Corporation, Cdnw, Inc., a Pennsylvania corporation, and Cdnw Online, Inc., a Pennsylvania corporation, Defendants., 2003 WL 24288804 (Expert Report and Affidavit) (W.D.Pa. Feb. 20, 2003) **Rebuttal Report of Michael Ian Shamos, PH.D., J.D.** (NO. 98-118)
- 19 SIGHTSOUND.COM. INCORPORATED, Plaintiff, v. N2K, INC., CDnow, Inc., and CDnow Online, Inc., Defendants., 2003 WL 24289706 (Expert Report and Affidavit) (W.D.Pa. Feb. 20, 2003) **Rebuttal Expert Report of Justin Douglas Tygar, Ph.D.** (NO. 98-0118)
- 20 SIGHTSOUND.COM INCORPORATED, a Pennsylvania corporation, Plaintiff, v. N2K, INC., a Delaware corporation, Cdnw, Inc., a Pennsylvania corporation, and Cdnw Online, Inc., a Pennsylvania corporation, Defendants., 2003 WL 24309949 (Partial Expert Testimony) (W.D.Pa. Mar. 3, 2003) **(Partial Testimony)** (NO. 98-0118)
- 21 SIGHTSOUND.COM, INCORPORATED, Plaintiff, v. N2K, INC., Cdnw, Inc., and Cdnw Online, Inc., Defendants., 2003 WL 24309947 (Partial Expert Testimony) (W.D.Pa. Mar. 9, 2003) **Deposition of Justin Douglas Tygar, Ph.D.** (NO. 98-0118)
- 22 SIGHTSOUND.COM INCORPORATED, a Pennsylvania corporation, Plaintiff, v. N2K, INC., a Delaware corporation, Cdnw, Inc., a Pennsylvania corporation, and Cdnw Online, Inc., a Pennsylvania corporation, Defendants., 2003 WL 24309950 (Expert Deposition) (W.D.Pa. Mar. 11, 2003) **(Deposition)** (NO. 98-0118)
- 23 In the Matter of: SIGHTSOUBD.COM INC., v. N2K, INC. et al., 2003 WL 24309948 (Partial Expert Testimony) (W.D.Pa. Mar. 12, 2003) **(Partial Testimony)** (NO. 98-0118)
- 24 SIGHTSOUND.COM, INC., a Pennsylvania corporation, Plaintiff, v. N2K, INC., a Delaware corporation, Cdnw, Inc., a Pennsylvania corporation, and Cdnw Online, Inc., a Pennsylvania corporation, Defendants., 2003 WL 24288807 (Expert Report and Affidavit) (W.D.Pa. Apr. 23, 2003) **Declaration by James A. Moorer in Support of Defendants' Motion for Summary Judgment** (NO. 98-0118)

- 25 SIGHTSOUND.COM, INC., a Pennsylvania corporation, Plaintiff and, Counterdefendants, v. N2K, INC., a Delaware corporation, CDNOW, Inc., a Pennsylvania corporation, and Cdnw Online, INC., a Pennsylvania corporation, Defendants and Counterclaimants., 2004 WL 3735168 (Expert Report and Affidavit) (W.D.Pa. Jan. 27, 2004) **Declaration of Michael Ian Shamos in Support of Defendants' Motion for Summary Judgment** (NO. 98-0118)

W.D.Pa. Trial Motions, Memoranda and Affidavits

- 26 SIGHTSOUND.COM INC., Plaintiff, v. N2K, INC., Cdnw, Inc., and CDnow Online, Inc., Defendants., 2004 WL 3742179 (Trial Motion, Memorandum and Affidavit) (W.D.Pa. Jan. 12, 2004) **Sightsound's Motion in Limine to Preclude Certain Testimony of James A. Moorer, Ph. D.** (NO. 98-0118)
- 27 SIGHTSOUND.COM INC., Plaintiff, v. N2K, INC., CDnow, Inc., and CDnow Online, Inc., Defendants., 2004 WL 3742180 (Trial Motion, Memorandum and Affidavit) (W.D.Pa. Jan. 12, 2004) **Sightsound's Motion in Limine to Preclude Certain Testimony of Michael Ian Shamos, Ph.D., J.D.** (NO. 98-0118)
- 28 SIGHTSOUND.COM INC., Plaintiff, v. N2K, INC., CDnow, Inc., and CDnow Online, Inc., Defendants., 2004 WL 3742181 (Trial Motion, Memorandum and Affidavit) (W.D.Pa. Jan. 27, 2004) **Defendants' Opposition to Plaintiff's Motion in Limine to Preclude Certain Testimony of James A. Moo** (NO. 98-0118)
- 29 SIGHTSOUND.COM INC., Plaintiff, v. N2K, INC., Cdnw, Inc., and CDnow Online, Inc., Defendants., 2004 WL 3742182 (Trial Motion, Memorandum and Affidavit) (W.D.Pa. Jan. 27, 2004) **Defendants' Opposition to Plaintiff's Motion in Limine to Preclude Certain Testimony of Michael Sham** (NO. 98-0118)

Dockets (U.S.A.)

W.D.Pa.

- 30 SIGHTSOUND.COM INC. v. N2K, INC., ET AL, NO. 2:98CV00118 (Docket) (W.D.Pa. Jan. 16, 1998)

Patent Family

- 31 TRANSMITTING DESIRED DIGITAL VIDEO OR AUDIO SIGNAL - TRANSFERRING MONEY VIA TELECOMMUNICATIONS LINE, CONNECTING ELECTRONICALLY FIRST MEMORY WITH SECOND MEMORY AND TRANSMITTING SIGNAL WITH TRANSMITTER IN CONTROL OF FIRST, DWPL 1993-093541

Assignments

- 32 ACTION: ASSIGNMENT OF ASSIGNORS INTEREST (SEE DOCUMENT FOR DETAILS). NUMBER OF PAGES: 006, DATE RECORDED: Dec 27, 2005
- 33 ACTION: NOTICE OF GRANT OF SECURITY INTEREST NUMBER OF PAGES: 006, DATE RECORDED: Oct 24, 2001
- 34 ACTION: CHANGE OF NAME (SEE DOCUMENT FOR DETAILS). NUMBER OF PAGES: 016, DATE RECORDED: May 03, 2000
- 35 ASSIGNEE(S): PARSEC SIGHT/SOUND, INC., DATE RECORDED: Oct 02, 1995

Patent Status Files

- .. Request for Re-Examination, (OG date: Mar 29, 2005)
- .. Patent Suit(See LitAlert Entries),
- .. Certificate of Correction, (OG date: Dec 21, 1993)

Docket Summaries

- 39 "SIGHTSOUND TECH v. ROXIO, INC., ET AL", 2:04CV01549, (W.D.PA. Oct 08, 2004), 35 USC 271 PATENT INFRINGEMENT

Litigation Alert

40 LitAlert P1998-06-59, (1999) Action Taken: A complaint was filed.

Prior Art (Coverage Begins 1976)

- ▶ 41 US PAT 4567359 AUTOMATIC INFORMATION, GOODS AND SERVICES DISPENSING SYSTEM, (U.S. PTO Utility 1986)
- ◻ 42 US PAT 3990710 COIN-OPERATED RECORDING MACHINE, (U.S. PTO Utility 1976)
- ◻ 43 US PAT 4654799 SOFTWARE VENDING SYSTEM, Assignee: Brother Kogyo Kabushiki Kaisha, (U.S. PTO Utility 1987)
- ◻ 44 US PAT 3718906 VENDING SYSTEM FOR REMOTELY ACCESSIBLE STORED INFORMATION, Assignee: Lightner R, (U.S. PTO Utility 1973)
- ◻ 45 US PAT 4647989 VIDEO CASSETTE SELECTION MACHINE, (U.S. PTO Utility 1987)

US District Court Civil Docket

**U.S. District - Pennsylvania Western
(Pittsburgh)**

2:04cv1549

Sightsound Tech v. Roxio, Inc, et al

This case was retrieved from the court on Tuesday, July 03, 2007

Date Filed: 10/08/2004	Class Code: CLOSED
Assigned To: Chief Judge Donetta W Ambrose	Closed: yes
Referred To:	Statute: 35:271
Nature of suit: Patent (830)	Jury Demand: Both
Cause: Patent Infringement	Demand Amount: \$0
Lead Docket: None	NOS Description: Patent
Other Docket: Dkt in other court: 05-01277	
Dkt in other court: Related, 2:98-cv-118	
Jurisdiction: Federal Question	

Litigants

Sightsound Technologies, Inc A Delaware Corporation
Plaintiff

Attorneys

Brian S Mudge
[COR LD NTC]
Kenyon & Kenyon
1500 K Street, NW
Suite 700
Washington , DC 20005-1257
USA
(202) 220-4200
Fax: (202) 220-4201
Email: BMUDGE@KENYON.COM

Clyde E Findley
[COR LD NTC]
[Term: 04/28/2006]
Kenyon & Kenyon
1500 K Street, NW
Suite 700
Washington , DC 20005-1257
USA
(202) 220-4200

Duncan L Williams
[COR LD NTC]
Kenyon & Kenyon
1500 K Street, NW
Suite 700
Washington , DC 20005-1257
USA
(202) 220-4200
Email: Dlwilliams@kenyon.com

Richard F Rinaldo
[COR LD NTC]
Meyer, Unkovic & Scott

1300 Oliver Building
Pittsburgh , PA 15222
USA
(412) 456-2876
Email: Rfr@muslaw.com

William K Wells
[COR LD NTC]
Kenyon & Kenyon
1500 K Street, NW
Suite 700
Washington , DC 20005-1257
USA
(202) 220-4200
Email: Wwells@kenyon.com

Roxio, Inc A Delaware Corporation
Defendant

Charles K Verhoeven
[COR LD NTC]
Quinn, Emanuel, Urquhart, Oliver & Hedges
50 California Street
22ND Floor
San Francisco , CA 94111
USA
(415) 875-6600
Email: Charlesverhoeven@quinnemanuel.com

Kathryn M Kenyon
[COR LD NTC]
Pietragallo, Bosick & Gordon LLP
38TH Floor
One Oxford Centre
Pittsburgh , PA 15219
USA
(412) 263-1824
Fax: (412) 261-5295
Email: KMK@PBANDG.COM

Kevin P Allen
[COR LD NTC]
[Term: 01/11/2005]
Thorp, Reed & Armstrong
301 Grant Street
One Oxford Centre, 14TH Floor
Pittsburgh , PA 15219-1425
USA
(412) 394-2366
Email: Kallen@thorpreed.com

Laurence Z Shiekman
[COR LD NTC]
Pepper Hamilton Eighteenth & Arch Streets
3000 Two Logan Square
Philadelphia , PA 19103-2799
USA
(215) 981-4000
Email: Shiekmanl@pepperlaw.com

Michael E Williams
[COR LD NTC]
Quinn, Emanuel, Urquhart, Oliver & Hedges
865 South Figueroa Street
10TH Floor
Los Angeles , CA 90017
USA
(213) 443-3000
Email: Michaelwilliams@quinnemanuel.com

Napster, Llc A Delaware Limited Liability Company
Defendant

Tigran Guledjian
[COR LD NTC]
Quinn, Emanuel, Urquhart, Oliver & Hedges
865 South Figueroa Street
10TH Floor
Los Angeles , CA 90017
USA
(213) 443-3000
Email: Tigranguledjian@quinnemanuel.com

William M Wycoff
[COR LD NTC]
[Term: 01/11/2005]
Thorp, Reed & Armstrong
301 Grant Street
One Oxford Centre, 14TH Floor
Pittsburgh , PA 15222-4895
USA
394-7782
Email: Wwycoff@thorpreed.com

Charles K Verhoeven
[COR LD NTC]
Quinn, Emanuel, Urquhart, Oliver & Hedges
50 California Street
22ND Floor
San Francisco , CA 94111
USA
(415) 875-6600
Email: Charlesverhoeven@quinnemanuel.com

Kathryn M Kenyon
[COR LD NTC]
Pietragallo, Bosick & Gordon LLP
38TH Floor
One Oxford Centre
Pittsburgh , PA 15219
USA
(412) 263-1824
Fax: (412) 261-5295
Email: KMK@PBANDG.COM

Kevin P Allen
[COR LD NTC]
[Term: 01/11/2005]
Thorp, Reed & Armstrong
301 Grant Street
One Oxford Centre, 14TH Floor
Pittsburgh , PA 15219-1425
USA
(412) 394-2366
Email: Kallen@thorpreed.com

Laurence Z Shiekman
[COR LD NTC]
Pepper Hamilton Eighteenth & Arch Streets
3000 Two Logan Square
Philadelphia , PA 19103-2799
USA
(215) 981-4000
Email: Shiekmanl@pepperlaw.com

Michael E Williams
[COR LD NTC]
Quinn, Emanuel, Urquhart, Oliver & Hedges

865 South Figueroa Street
10TH Floor
Los Angeles , CA 90017
USA
(213) 443-3000
Email: Michaelwilliams@quinnemanuel.com

Michael T Zeller
[COR LD NTC]
Quinn Emanuel Urquhart Oliver & Hedges
865 S Figueroa Street, 10TH Floor
Los Angeles , CA 90017
USA
(213) 443-3000
Email: Michaelzeller@quinnemanuel.com

Tigran Guledjian
[COR LD NTC]
Quinn, Emanuel, Urquhart, Oliver & Hedges
865 South Figueroa Street
10TH Floor
Los Angeles , CA 90017
USA
(213) 443-3000
Email: Tigranguledjian@quinnemanuel.com

William M Wycoff
[COR LD NTC]
[Term: 01/11/2005]
Thorp, Reed & Armstrong
301 Grant Street
One Oxford Centre, 14TH Floor
Pittsburgh , PA 15222-4895
USA
394-7782
Email: Wwycoff@thorpreed.com

Scott Sander
Counter Defendant

Brian S Mudge
[COR LD NTC]
Kenyon & Kenyon
1500 K Street, NW
Suite 700
Washington , DC 20005-1257
USA
(202) 220-4200
Fax: (202) 220-4201
Email: BMUDGE@KENYON.COM

Richard F Rinaldo
[COR LD NTC]
Meyer, Unkovic & Scott
1300 Oliver Building
Pittsburgh , PA 15222
USA
(412) 456-2876
Email: Rfr@muslaw.com

William K Wells
[COR LD NTC]
Kenyon & Kenyon
1500 K Street, NW
Suite 700
Washington , DC 20005-1257
USA
(202) 220-4200
Email: Wwells@kenyon.com

Date	#	Proceeding Text
10/08/2004	1	COMPLAINT with summons issued; jury demand Filing Fee \$ 150.00 Receipt # 05000126 (tt) (Entered: 10/08/2004)
10/08/2004	2	DISCLOSURE statement by SIGHTSOUND TECH (tt) (Entered: 10/08/2004)
10/08/2004	--	COPY of Complaint and Docket Entries mailed to the Commissioner of Patents and Trademarks. (tt) (Entered: 10/08/2004)
11/08/2004	3	RETURN OF SERVICE executed as to ROXIO, INC. 11/5/04 Answer due on 11/26/04 for ROXIO, INC. (tt) (Entered: 11/09/2004)
11/08/2004	4	RETURN OF SERVICE executed as to NAPSTER, L.L.C. 11/5/04 Answer due on 11/26/04 for NAPSTER, L.L.C. (tt) (Entered: 11/09/2004)
11/24/2004	5	ANSWER to Complaint; jury demand and COUNTERCLAIM by ROXIO, INC., NAPSTER, L.L.C. (Attorney William M. Wycoff, Kevin P. Allen, Charles K. Verhoeven, Michael E. Williams) against SIGHTSOUND TECH (tt) Modified on 03/11/2005 (Entered: 11/24/2004)
11/24/2004	6	DISCLOSURE statement by ROXIO, INC., NAPSTER, L.L.C. (tt) (Entered: 11/24/2004)
11/24/2004	7	NOTICE Opting Out of Arbitration by ROXIO, INC., NAPSTER, L.L.C. (tt) (Entered: 11/24/2004)
12/15/2004	8	ANSWER by SIGHTSOUND TECH to [5-2] counterclaims by NAPSTER, L.L.C., ROXIO, INC. (tt) (Entered: 12/16/2004)
12/17/2004	9	Case Management Conference set for 9:15 1/11/05 (tt) (Entered: 12/17/2004)
01/10/2005	10	INITIAL Case Scheduling Conference Statement by ROXIO, INC., NAPSTER, L.L.C. (tt) (Entered: 01/10/2005)
01/10/2005	11	MOTION by SIGHTSOUND TECH for Preliminary Injunction , with Proposed Order. (tt) (Entered: 01/11/2005)
01/10/2005	12	EXHIBITS by SIGHTSOUND TECH to [11-1] motion for Preliminary Injunction (tt) (Entered: 01/11/2005)
01/10/2005	13	BRIEF by SIGHTSOUND TECH in support of [11-1] motion for Preliminary Injunction by SIGHTSOUND TECH (tt) (Entered: 01/11/2005)
01/10/2005	14	DECLARATION of Justin Douglas Tygar, Ph.D. concerning the Operation of Roxio/Napster Re: [11-1] motion for Preliminary Injunction by SIGHTSOUND TECH (tt) (Entered: 01/11/2005)
01/11/2005	15	MOTION by ROXIO, INC., NAPSTER, L.L.C. to Substitute Attorney , with Proposed Order. (tt) (Entered: 01/11/2005)
01/11/2005	16	MOTION by ROXIO, INC., NAPSTER, L.L.C. for Charles K. Verhoeven to Appear Pro Hac Vice ; Filing Fee \$ 40.00 Receipt # 05001581 , with Proposed Order. (tt) (Entered: 01/11/2005)
01/11/2005	17	MOTION by ROXIO, INC., NAPSTER, L.L.C. for Tigran Guledjian to Appear Pro Hac Vice ; Filing Fee \$ 40.00 Receipt # 05001581 , with Proposed Order. (tt) (Entered: 01/11/2005)
01/11/2005	18	MOTION by ROXIO, INC., NAPSTER, L.L.C. for Michael E. Williams to Appear Pro Hac Vice ; Filing Fee \$ 40.00 Receipt # 05001581 , with Proposed Order. (tt) (Entered: 01/11/2005)
01/11/2005	19	Status Conference held 1/11/05 before Chief Judge Donetta W. Ambrose [Reporter: none] (tt) (Entered: 01/11/2005)
01/11/2005	--	Deadline updated; Response to Motion set to 2/11/05 for [11-1] motion for Preliminary Injunction ; Reply to Response to Motion set to 2/21/05 for [11-1] motion for Preliminary Injunction ; Motion Hearing set for 1:30 3/3/05 for [11-1] motion for Preliminary Injunction (tt) (Entered: 01/11/2005)
01/11/2005	20	RESPONSE by SIGHTSOUND TECH to defts' [10-1] Initial Case Scheduling Conference Statement. (tt) (Entered: 01/11/2005)
01/11/2005	--	ORDER upon motion granting [15-1] motion to Substitute Attorney ; terminated attorney William M. Wycoff for ROXIO, INC., attorney Kevin P. Allen for ROXIO, INC., attorney William M. Wycoff for NAPSTER, L.L.C., attorney Kevin P. Allen for NAPSTER, L.L.C. and added Laurence Z. Shiekman, Kathryn M. Kenyon for defts. (signed by Chief Judge Donetta W. Ambrose on 1/11/05) CM all parties of record. (tt) (Entered: 01/12/2005)
01/11/2005	--	ORDER upon motion granting [16-1] motion for Charles K. Verhoeven to Appear Pro Hac Vice on behalf of defts. (signed by Chief Judge Donetta W. Ambrose on 1/11/05) CM all parties of record. (tt) (Entered: 01/12/2005)

- 01/11/2005 -- ORDER upon motion granting [17-1] motion for Tigran Guledjian to Appear Pro Hac Vice on behalf of defts. (signed by Chief Judge Donetta W. Ambrose on 1/11/05) CM all parties of record. (tt) (Entered: 01/12/2005)
- 01/11/2005 -- ORDER upon motion granting [18-1] motion for Michael E. Williams to Appear Pro Hac Vice on behalf of defts. (signed by Chief Judge Donetta W. Ambrose on 1/11/05) CM all parties of record. (tt) (Entered: 01/12/2005)
- 01/18/2005 21 Status Conference via phone held 1/18/05 before Chief Judge Donetta W. Ambrose [Reporter: none] ; Deft wants leave to amend counterclaims related to press release. Pltf doesn't object to motion for leave to amend. Leave granted orally by the Court; Amended counterclaim due 1/25/05. Deft to file a Motion to Stay Case pending outcome of application to Patent & Trademark Office, response due w/in 10 days. (tt) (Entered: 01/19/2005)
- 01/21/2005 22 MOTION by ROXIO, INC., NAPSTER, L.L.C. to Stay Pending Reexamination of Patents in Suit with Proposed Order. (jsp) (Entered: 01/24/2005)
- 01/21/2005 23 BRIEF by ROXIO, INC., NAPSTER, L.L.C. in support of [22-1] motion to Stay Pending Reexamination of Patents in Suit by NAPSTER, L.L.C., ROXIO, INC. (jsp) (Entered: 01/24/2005)
- 01/25/2005 24 FIRST AMENDED ANSWER to Complaint by ROXIO, INC., NAPSTER, L.L.C. amends: [5-1] answer by NAPSTER, L.L.C., ROXIO, INC. and COUNTERCLAIMS against SIGHTSOUND TECH (tt) (Entered: 01/26/2005)
- 01/27/2005 25 MOTION by SIGHTSOUND TECH to Extend Time w/in which to respond to defts' motion to stay pending receipt of defts' request for re-examination of patents and prior art which defts intend to submit to the Patent and Trademark Office , with Proposed Order. (tt) (Entered: 01/28/2005)
- 01/28/2005 26 RESPONSE by ROXIO, INC., NAPSTER, L.L.C. to pltf's [25-1] motion to Extend Time w/in which to respond to defts' motion to stay (tt) (Entered: 01/28/2005)
- 01/28/2005 27 ACCEPTANCE OF SERVICE of First Amended Answer and Counterclaim as to Scott Sander executed 1/26/05 (tt) (Entered: 01/28/2005)
- 01/28/2005 28 BRIEF by SIGHTSOUND TECH in support of [25-1] motion to Extend Time w/in which to respond to defts' motion to stay (tt) (Entered: 01/31/2005)
- 02/02/2005 29 Status Conference via phone held 1/31/05 before Chief Judge Donetta W. Ambrose [Reporter: none] ; Pltf's response to motion to stay due 2/11/05 ; Defts' reply due 2/16/05 ; Preliminary injunction date will be scheduled via order on motion to stay ; Defts do not have to file answer to preliminary injunction by March. (tt) (Entered: 02/02/2005)
- 02/02/2005 -- ORDER upon motion granting [25-1] motion to Extend Time w/in which to respond to defts' motion to stay pending receipt of defts' request for re-examination of patents and prior art which defts intend to submit to the Patent and Trademark Office. Defts shall serve on counsel for pltf by overnight delivery sent no later than 2/1/05 any request for re-examination of the patents in suit which defts intend to file with the PTO, including all prior art on which defts plan to rely in such request for re-examination ; Pltf's Response to Motion set to 2/11/05 for defts' [22-1] motion to Stay Pending Reexamination of Patents in Suit ; Defts' Reply Brief due 2/16/05 ; Defts are not required to file an answer to pltf's motion for preliminary injunction until further order of court. (signed by Chief Judge Donetta W. Ambrose on 1/31/05) CM all parties of record. (tt) (Entered: 02/02/2005)
- 02/03/2005 30 MOTION by SIGHTSOUND TECH for Brian S. Mudge to Appear Pro Hac Vice ; Filing Fee \$ 40.00 Receipt # 05001943 , with Proposed Order. (tt) (Entered: 02/04/2005)
- 02/03/2005 31 MOTION by SIGHTSOUND TECH for William K. Wells to Appear Pro Hac Vice ; Filing Fee \$ 40.00 Receipt # 05001943 , with Proposed Order. (tt) (Entered: 02/04/2005)
- 02/03/2005 32 MOTION by SIGHTSOUND TECH for Duncan L. Williams to Appear Pro Hac Vice ; Filing Fee \$ 40.00 Receipt # 05001943 , with Proposed Order. (tt) (Entered: 02/04/2005)
- 02/03/2005 33 MOTION by SIGHTSOUND TECH for Clyde E. Findley to Appear Pro Hac Vice ; Filing Fee \$40.00 05001943 Receipt # 05001943 , with Proposed Order. (tt) (Entered: 02/04/2005)
- 02/04/2005 34 NOTICE of Lodging of Pending Requests for Reexamination by ROXIO, INC., NAPSTER, L.L.C. (tt) (Entered: 02/04/2005)
- 02/04/2005 35 EXHIBITS (VOLUME I) by ROXIO, INC., NAPSTER, L.L.C. to [34-1] notice of lodging of pending requests for reexamination. (tt) (Entered: 02/04/2005)
- 02/04/2005 36 EXHIBITS (VOLUME II) by ROXIO, INC., NAPSTER, L.L.C. to [34-1] notice of lodging of pending requests for reexamination. (tt) (Entered: 02/04/2005)
- 02/04/2005 37 EXHIBITS (VOLUME III) by ROXIO, INC., NAPSTER, L.L.C. to [34-1] notice of lodging of pending requests for reexamination. (tt) (Entered: 02/04/2005)

02/07/2005 -- ORDER upon motion granting [30-1] motion for Brian S. Mudge to Appear Pro Hac Vice on behalf of pltf. (signed by Chief Judge Donetta W. Ambrose on 2/4/05) CM all parties of record. (tt) (Entered: 02/07/2005)

02/07/2005 -- ORDER upon motion granting [31-1] motion for William K. Wells to Appear Pro Hac Vice on behalf of pltf. (signed by Chief Judge Donetta W. Ambrose on 2/4/05) CM all parties of record. (tt) (Entered: 02/07/2005)

02/07/2005 -- ORDER upon motion granting [32-1] motion for Duncan L. Williams to Appear Pro Hac Vice on behalf of pltf. (signed by Chief Judge Donetta W. Ambrose on 2/4/05) CM all parties of record. (tt) (Entered: 02/07/2005)

02/07/2005 -- ORDER upon motion granting [33-1] motion for Clyde E. Findley to Appear Pro Hac Vice on behalf of pltf. (signed by Chief Judge Donetta W. Ambrose on 2/4/05) CM all parties of record. (tt) (Entered: 02/07/2005)

02/11/2005 38 REPLY by SIGHTSOUND TECH to [24-2] First Amended Counterclaims by NAPSTER, L.L.C., ROXIO, INC. (tt) (Entered: 02/14/2005)

02/11/2005 39 BRIEF by SIGHTSOUND TECH in opposition to Napster's [22-1] motion to Stay Pending Reexamination of Patents in Suit (tt) (Entered: 02/14/2005)

02/11/2005 40 MOTION by SIGHTSOUND TECH, SCOTT SANDER to Dismiss defts' Amended Counterclaims 4-9 . (tt) (Entered: 02/14/2005)

02/11/2005 41 BRIEF by SIGHTSOUND TECH, SCOTT SANDER in support of their [40-1] motion to Dismiss defts' Amended Counterclaims 4-9 (tt) (Entered: 02/14/2005)

02/16/2005 42 REPLY by ROXIO, INC., NAPSTER, L.L.C. in support of their Motion to Stay pending Reexamination of the Patents-In-Suit (tt) (Entered: 02/17/2005)

02/16/2005 43 DECLARATION of William E. Growney (tt) Modified on 02/18/2005 (Entered: 02/17/2005)

02/16/2005 44 MOTION by ROXIO, INC., NAPSTER, L.L.C. to Seal [43-1] Declaration , with Proposed Order. (tt) (Entered: 02/17/2005)

02/17/2005 45 OPPOSITION by SIGHTSOUND TECH to defts' [44-1] motion to Seal [43-1] Declaration (tt) (Entered: 02/18/2005)

02/17/2005 46 NOTICE OF FILING: Supplemental Declaration of Christopher Reese by SIGHTSOUND TECH (FILED UNDER SEAL) (tt) Modified on 02/28/2005 (Entered: 02/18/2005)

02/17/2005 47 REQUEST by SIGHTSOUND TECH for Oral Argument on Motion to Stay . (tt) (Entered: 02/18/2005)

02/18/2005 -- ORDER upon motion denying [44-1] motion to Seal [43-1] Declaration. The declaration speaks only of vague, unsuccessful attempts & no dollar values are set forth. I see no risk of confidential information being disclosed. (signed by Chief Judge Donetta W. Ambrose on 2/18/05) CM all parties of record. (tt) (Entered: 02/18/2005)

02/18/2005 -- ORDER upon motion denying [47-1] motion for Oral Argument on Motion to Stay. The parties have clearly represented their respective positions in the briefs and declarations filed. (signed by Chief Judge Donetta W. Ambrose on 2/18/05) CM all parties of record. (tt) (Entered: 02/18/2005)

02/23/2005 48 MOTION by ROXIO, INC., NAPSTER, L.L.C. to Seal Supplemental Declaration of Christopher Reese , with Proposed Order. (tt) (Entered: 02/23/2005)

02/23/2005 49 OPPOSITION by SIGHTSOUND TECH to defts' [48-1] motion to Seal Supplemental Declaration of Christopher Reese (tt) (Entered: 02/24/2005)

02/28/2005 -- ORDER upon motion granting [48-1] motion to Seal Supplemental Declaration of Christopher Reese. The Supplemental Declaration of Christopher Reese filed 2/17/05 shall be placed under seal. (signed by Chief Judge Donetta W. Ambrose on 2/28/05) CM all parties of record. (tt) (Entered: 02/28/2005)

02/28/2005 50 MEMORANDUM OPINION & ORDER granting defts' [22-1] motion to Stay. The defts are to contact this Court immediately upon receiving any notification from the PTO regarding the outcome of the Request for Reexamination. The preliminary injunction hearing scheduled for 3/3/05 is cancelled . The [11-1] motion for Preliminary Injunction is denied without prejudice to reassert once the stay is lifted. (signed by Chief Judge Donetta W. Ambrose on 2/28/05) CM all parties of record. (tt) (Entered: 02/28/2005)

03/03/2005 51 NOTICE OF APPEAL by SIGHTSOUND TECH from [50-1] memorandum opinion dated 2/28/05 FILING FEE \$ 255 RECEIPT # 2394 TPO issued. (lck) (Entered: 03/07/2005)

03/03/2005 -- Certified copy of Notice of Appeal [51-1] appeal by SIGHTSOUND TECH , certified copy of

docket, certified copy of order dated 2/28/05 mailed to USCA; copy of Notice of Appeal and information sheet to ROXIO, INC., NAPSTER, L.L.C. and judge. Copy of information sheet to appellant. (lck) (Entered: 03/07/2005)

03/11/2005 52 Transcript Purchase order re: [51-1] appeal by SIGHTSOUND TECH indicating that no transcript is being ordered. (tt) (Entered: 03/11/2005)

03/21/2005 -- Text not available. (Entered: 03/21/2005)

04/04/2005 53 NOTICE of PTO's Order granting ex parte Reexamination by ROXIO, INC., NAPSTER, L.L.C. (tt) (Entered: 04/04/2005)

07/21/2005 54 MOTION for Relief from Stay with Respect to Defamation Counterclaims by SIGHTSOUND TECHNOLOGIES, INC., SCOTT SANDER. (Attachments: # 1 Proposed Order)(jsp) (Entered: 07/21/2005)

07/21/2005 55 BRIEF in Support re 54 MOTION for Relief from Stay with Respect to Defamation Counterclaims filed by SIGHTSOUND TECHNOLOGIES, INC., SCOTT SANDER. (Attachments: # 1 Part 2 of Brief)(jsp) (Entered: 07/21/2005)

07/22/2005 56 NOTICE: re 54 MOTION for Relief from Stay with Respect to Defamation Counterclaims:Response due on or before 8/4/05. (jlh) (Entered: 07/22/2005)

08/04/2005 57 NOTICE by ROXIO, INC., NAPSTER, L.L.C. of PTO's Issuance of Office Actions in Ex Parte Reexamination (Attachments: # 1 # 2 # 3)(Helmsen, Joseph) (Entered: 08/04/2005)

08/04/2005 58 MOTION for attorney Michael T. Zeller to Appear Pro Hac Vice by ROXIO, INC., NAPSTER, L.L.C.. (Attachments: # 1 Proposed Order)(Kenyon, Kathryn) (Entered: 08/04/2005)

08/04/2005 59 NOTICE by ROXIO, INC., NAPSTER, L.L.C. re 57 Notice (Other) Letter Notice of Prior Filing (Kenyon, Kathryn) (Entered: 08/04/2005)

08/04/2005 60 BRIEF in Opposition re 54 MOTION for Relief from Stay with Respect to Defamation Counterclaims filed by ROXIO, INC., NAPSTER, L.L.C.. (Attachments: # 1 Exhibit A# 2 Exhibit B# 3 Exhibit C# 4 Exhibit D# 5 Exhibit E# 6 Exhibit F# 7 Exhibit G# 8 Exhibit H)(Kenyon, Kathryn) (Entered: 08/04/2005)

08/04/2005 -- Pro Hac Vice Fees received in the amount of \$ 40 receipt # 4877 re 58 Motion to Appear Pro Hac Vice (ept) (Entered: 08/05/2005)

08/08/2005 61 ORDER granting 58 Motion to Appear Pro Hac Vice . Signed by Judge Donetta W. Ambrose on 8/8/05. (jlh) (Entered: 08/08/2005)

09/01/2005 62 ORDER denying 54 Motion for Relief from Stay . Signed by Judge Donetta W. Ambrose on 8/31/05. (jlh) (Entered: 09/01/2005)

09/06/2005 63 NOTICE by SIGHTSOUND TECHNOLOGIES, INC., SCOTT SANDER NOTICE OF FILING TO SUPPLEMENT RECORD (Kerr, Benjamin) (Entered: 09/06/2005)

09/07/2005 64 Minute Entry for proceedings held before Judge Donetta W. Ambrose : Status Conference held on 9/7/2005. Parties to keep Court informed of PTO Action. (jlh) (Entered: 09/07/2005)

11/02/2005 65 NOTICE by ROXIO, INC., NAPSTER, L.L.C. of PTO's Issuance of Second Office Actions in Ex Parte Reexamination (Attachments: # 1 Exhibit A# 2 Exhibit B# 3 Exhibit C)(Kenyon, Kathryn) (Entered: 11/02/2005)

11/14/2005 66 MANDATE of USCA for the Federal Circuit as to [51] Notice of Appeal filed by SIGHTSOUND TECHNOLOGIES, INC., that the appeal is dismissed, with each party to bear its own costs. (jsp) (Entered: 11/15/2005)

03/02/2006 67 MOTION by Clyde E. Findley to Withdraw as Attorney by SIGHTSOUND TECHNOLOGIES, INC. (jsp) (Entered: 03/02/2006)

05/10/2006 68 NOTICE by ROXIO, INC., NAPSTER, L.L.C. Defendants' Notice of PTO's Issuance of Final Office Actions in Ex Parte Reexamination and Request for Status Conference (Attachments: # 1 Exhibit A)(Kenyon, Kathryn) (Entered: 05/10/2006)

05/10/2006 69 EXHIBITS in Support of 68 Notice (Other) by ROXIO, INC., NAPSTER, L.L.C.. (Kenyon, Kathryn) (Entered: 05/10/2006)

05/10/2006 70 EXHIBITS in Support of 68 Notice (Other) by ROXIO, INC., NAPSTER, L.L.C.. (Kenyon, Kathryn) (Entered: 05/10/2006)

05/10/2006 -- MOTION (Request) for Status Conference by ROXIO, INC., NAPSTER, L.L.C..(with Document 68) (jsp) (Entered: 05/11/2006)

05/11/2006 -- CLERK'S OFFICE QUALITY CONTROL MESSAGE. re 68 Notice (Other) ERROR: Document should have been filed as two separate documents. CORRECTION: Attorney advised in future that

documents of that nature are to be filed as separate documents. Clerk of Court docketed Request for Status Conference. This message is for informational purposes only. (jsp) (Entered: 05/11/2006)

- 05/31/2006 71 Minute Entry for proceedings held before Judge Donetta W. Ambrose : Telephone Conference held on 5/31/2006. (Court Reporter none) (jlh) (Entered: 05/31/2006)
- 05/31/2006 72 ORDER FOR ADMINISTRATIVE CLOSING.Signed by Judge Donetta W. Ambrose on 5/31/06. (jlh) (Entered: 05/31/2006)
- 06/02/2006 73 NOTICE by SIGHTSOUND TECHNOLOGIES, INC. Notice of Filing by Sightsound Technologies, Inc. of Sua Sponte Decisions of United States Patent and Trademark Office Vacating Previous Final Office Actions (Rinaldo, Richard) (Entered: 06/02/2006)

Copyright © 2007 LexisNexis CourtLink, Inc. All rights reserved.
*** THIS DATA IS FOR INFORMATIONAL PURPOSES ONLY ***

Source: [Command Searching > Utility, Design and Plant Patents](#) 
Terms: [patno=5191573](#) ([Edit Search](#) | [Suggest Terms for My Search](#))

586391 (07) 5191573 March 2, 1993

UNITED STATES PATENT AND TRADEMARK OFFICE GRANTED PATENT

5191573

[Get Drawing Sheet 1 of 2](#)
[Access PDF of Official Patent *](#)
[Check for Patent Family Report PDF availability *](#)

* Note: A transactional charge will be incurred for downloading an Official Patent or Patent Family Report. Your acceptance of this charge occurs in a later step in your session. The transactional charge for downloading is outside of customer subscriptions; it is not included in any flat rate packages.

[Order Patent File History / Wrapper from REEDFAX@](#)
[Link to Claims Section](#)

March 2, 1993

Method for transmitting a desired digital video or audio signal

REEXAM-LITIGATE: January 31, 2005 - Reexamination requested January 31, 2005 by Napster, Inc., Los Angeles, CA; c/o Albert S. Penilla, Martine, Penilla & Gencarella, LLP, Sunnyvale, CA, Reexamination No. 90/007,402 (O.G. March 29, 2005) Ex. Gp.: 2655

NOTICE OF LITIGATION

Sightsound Tech v. Roxio, Inc, et al, Filed October 8, 2004, D.C. W.D. Pennsylvania, Doc. No. 2:04cv1549

CERT-CORRECTION: December 21, 1993 - a Certificate of Correction was issued for this Patent

APPL-NO: 586391 (07)

FILED-DATE: September 18, 1990

GRANTED-DATE: March 2, 1993

ASSIGNEE-AFTER-ISSUE: October 2, 1995 - ASSIGNMENT OF ASSIGNORS INTEREST (SEE DOCUMENT FOR DETAILS)., PARSEC SIGHT/SOUND, INC. 1518 ALLISON DRIVE UPPER ST. CLAIR, PENNSYLVANIA, 15241, Reel and Frame Number: 007656/0701

May 3, 2000 - CHANGE OF NAME (SEE DOCUMENT FOR DETAILS)., SIGHTSOUND.COM INCORPORATED 733 WASHINGTON ROAD, SUITE 400 MT. LEBANON, PENNSYLVANIA, 15228; Reel and Frame Number: 010776/0703

October 24, 2001 - NOTICE OF GRANT OF SECURITY INTEREST, KENYON & KENYON ONE BROADWAY NEW YORK, NEW YORK, 10004, SCHWARTZ, ANSEL M. ONE STERLING PLAZA 201 N. CRAIG STREET, SUITE 304 PITTSBURGH, PENNSYLVANIA, 15213, WATERVIEW PARTNERS, LLP ONE STERLING PLAZA 152 WEST 57TH STREET, 46TH FLOOR NEW YORK, NEW YORK, 10019, D&DF WATERVIEW PARTNERS, L.P. ONE STERLING PLAZA 152 WEST 57TH STREET, 46TH FLOOR NEW YORK, NEW YORK, 10019, Reel and Frame Number: 012506/0415

December 27, 2005 - ASSIGNMENT OF ASSIGNORS INTEREST (SEE DOCUMENT FOR

DETAILS),, DMT LICENSING, LLC ONE INDEPENDENCE WAY PRINCETON NEW JERSEY 08540,
Reel and Frame Number: 017555/0149

CORE TERMS: user, song, music, memory, electronically, stored, digital, hardware, hard disk,
electronic ...

Source: [Command Searching > Utility, Design and Plant Patents](#) 

Terms: **patno=5191573** ([Edit Search](#) | [Suggest Terms for My Search](#))

View: **Custom**

Segments: Assign-type, Assignee, Cert-correction, Filed, Reexam-cert, Reexam-litigate, Reissue, Reissue-comment
Date/Time: Tuesday, July 17, 2007 - 1:28 PM EDT



LexisNexis[®]

[About LexisNexis](#) | [Terms & Conditions](#)

Copyright © 2007 LexisNexis, a division of Reed Elsevier Inc. All rights reserved.



[Switch Client](#) | [Preferences](#) | [Feedback](#) | [Sign Off](#) | [Help](#)

[My Lexis™](#) | [Search](#) | [Research Tasks](#) | [Search Advisor](#) | [Get a Document](#) | [Shepard's®](#) | [Alerts](#) | [History](#) | [Sources](#) | [Guided Search Forms](#) | [Command Searching](#)

[Command Searching](#) > **Patent Cases from Federal Courts and Administrative Materials**

Enter Search Terms

[Search Help](#)

Terms and Connectors Natural Language Easy Search

5191573 or 5,191,573

[Suggest Terms for My Search](#)

Search

[Check Spelling](#)

Search Conn

[and](#) [and](#)
[or](#) [or](#)
[w/N](#) [withi](#)
[pre /N](#) [preC](#)
[w/p](#) [in sa](#)
[w/seg](#) [in sa](#)
[w/s](#) [in sa](#)
[and not](#) [and i](#)
> [More Connect](#)

Restrict by Document Segment:

Select a document segment, enter search terms for the segment, then click Add.

Select a Segment [dropdown] [input] **Add** [up arrow]

Note: Segment availability differs between sources. Segments may not be applied consistently across sources.

Restrict by Date:

No Date Restrictions [dropdown] From [input] To [input] [Date Formats...](#)

How Do I...?

- > Use wildcards for one or more search term?
- > Restrict by do
- > Restrict by da

[View](#)

[My Lexis™](#) | [Search](#) | [Research Tasks](#) | [Search Advisor](#) | [Get a Document](#) | [Shepard's®](#) | [Alerts](#)
[History](#) | [Delivery Manager](#) | [Switch Client](#) | [Preferences](#) | [Feedback](#) | [Sign Off](#) | [Help](#)



[About LexisNexis](#) | [Terms & Conditions](#)
Copyright © 2007 LexisNexis, a division of Reed Elsevier Inc. All rights reserved.

Source: [Command Searching > Patent Cases from Federal Courts and Administrative Materials](#)

Terms: **5191573** or **5,191,573** ([Edit Search](#) | [Suggest Terms for My Search](#))

Select for FOCUS™ or Delivery

- 1. [Sightsound.com, Inc. v. N2K, Inc.](#), Civil Action No. 98-0118 , UNITED STATES DISTRICT COURT FOR THE WESTERN DISTRICT OF PENNSYLVANIA, 391 F. Supp. 2d 321; 2003 U.S. Dist. LEXIS 25503, October 23, 2003, Decided

OVERVIEW: Defendant was denied summary judgment on claims of patent invalidity; earlier patent described only "possibility" of use of unit in way that anticipated use of patent-in-suit, not the required "necessity," and fact question existed as to obviousness.

CORE TERMS: patent, digital, sightsound, invention, music, summary judgment, signal, prior art, license, consumer ...

... United States Patent No. **5,191,573** ("the '573 Patent") ...

- 2. [Sightsound.com Inc. v. N2k, Inc.](#), Civil Action No. 98-118 , UNITED STATES DISTRICT COURT FOR THE WESTERN DISTRICT OF PENNSYLVANIA, 185 F. Supp. 2d 445; 2002 U.S. Dist. LEXIS 6828, February 8, 2002, Decided

OVERVIEW: In an action involving patents which were directed to commercially-acceptable systems and methods for selling music and video in digital form over telecommunications lines, the judge made several recommendations regarding claim construction.

CORE TERMS: digital, memory, telecommunication, electronically, patent, audio signals, signal, specification, desired, transferring ...

... S. Patent Nos. **5,191,573** ("the '573 Patent"), 5,675,734 ("the '734 Patent") ...

Source: [Command Searching > Patent Cases from Federal Courts and Administrative Materials](#)

Terms: **5191573** or **5,191,573** ([Edit Search](#) | [Suggest Terms for My Search](#))

View: Cite

Date/Time: Tuesday, July 17, 2007 - 1:28 PM EDT

* Signal Legend:

- Warning: Negative treatment is indicated
- Questioned: Validity questioned by citing refs
- Caution: Possible negative treatment
- Positive treatment is indicated
- Citing Refs. With Analysis Available
- Citation information available

* Click on any *Shepard's* signal to *Shepardize*® that case.



[About LexisNexis](#) | [Terms & Conditions](#)

[Copyright ©](#) 2007 LexisNexis, a division of Reed Elsevier Inc. All rights reserved.

LexisNexis® Total Research System

Switch Client | Preferences | Feedback | Sign Off | Help

My Lexis™ Search Research Tasks Search Advisor Get a Document Shepard's® Alerts History
Sources | Guided Search Forms | Command Searching

Command Searching > Patent, Trademark & Copyright Periodicals, Combined

Enter Search Terms

Terms and Connectors Natural Language Easy Search

5191573 or 5,191,573

Suggest Terms for My Search

Search

Check Spelling

Restrict by Document Segment:

Select a document segment, enter search terms for the segment, then click Add.

Select a Segment Add

Note: Segment availability differs between sources. Segments may not be applied consistently across sources.

Restrict by Date:

No Date Restrictions From To Date Formats...

Search Help

Search Conn

and and
or or
w/N withi
pre /N prec
w/p in sa
w/seg in sa
w/s in sa
and not and
> More Connect

How Do I...?

> Use wildcards for one or mo search term?
> Restrict by do
> Restrict by da

View

My Lexis™ | Search | Research Tasks | Search Advisor | Get a Document | Shepard's® | Alerts
History | Delivery Manager | Switch Client | Preferences | Feedback | Sign Off | Help



About LexisNexis | Terms & Conditions
Copyright © 2007 LexisNexis, a division of Reed Elsevier Inc. All rights reserved.

No Documents Found

No documents were found for your search terms

"5191573 or 5,191,573"

Click "Save this search as an Alert" to schedule your search to run in the future.

- OR -

Click "Edit Search" to return to the search form and modify your search.

Suggestions:

- Check for spelling errors
 - Remove some search terms.
 - Use more common search terms, such as those listed in "Suggested Words and Concepts"
 - Use a less restrictive date range.
-

Save this Search as an Alert

Edit Search



[About LexisNexis](#) | [Terms & Conditions](#)
Copyright © 2007 LexisNexis, a division of Reed Elsevier Inc. All rights reserved.

Command Searching > News, All (English, Full Text) [1]

Enter Search Terms

Terms and Connectors Natural Language Easy Search

5191573 or 5,191,573

Suggest Terms for My Search

Search

Check Spelling

Restrict by Document Segment:

Select a document segment, enter search terms for the segment, then click Add.

Select a Segment [] Add [↑]

Note: Segment availability differs between sources. Segments may not be applied consistently across sources.

Restrict by Date:

No Date Restrictions [v] From [] To [] Date Formats...

Search Help

Search Conn

and and
or or
w/N withi
pre /N prec
w/p in sa
w/seg in sa
w/s in sa
and not and
> More Connect

How Do I...?

- > Use wildcards for one or mo search term?
- > Restrict by do
- > Restrict by da

View



Source: [Command Searching > News, All \(English, Full Text\)](#) Terms: **5191573** or **5,191,573** ([Edit Search](#) | [Suggest Terms for My Search](#))

☑ Select for FOCUS™ or Delivery

- 1. [Intellectual Property Today](#), April, 2004, INTERNETINFO.COLUMN; Pg. 49, 718 words, Will the Price of Music Downloads Include Patent License Fees?, BY W. SCOTT PETTY; Scott Petty, a Patent Attorney with King & Spalding, focuses on intellectual property issues for computer software, telecommunications and e-commerce companies. Scott can be contacted by telephone at 404.572.2888 or via e-mail at spetty@kslaw.com.
... U.S. Patent Nos. **5,191,573** and 5,675,734, which date back to ...
- 2. [Rutgers Computer & Technology Law Journal](#), March 22, 2002, No. 1, Vol. 28; Pg. 61; ISSN: 0735-8938, 24588 words, The multiple unconstitutionality of business method patents: common sense, congressional consideration, and constitutional history., Pollack, Malla
... U.S. Patent No. **5,191,573** (issued Mar. 2 ...
- 3. [Canadian Press Newswire](#), September 4, 2001, S 4'01, 5191573, 81 words, Trio of alleged drug-smugglers from Montreal elect trial by judge alone
- 4. [Canadian Press Newswire](#), September 4, 2001, S 4'01, 5191573, 81 words, Trio of alleged drug-smugglers from Montreal elect trial by judge alone (Record in progress)
- 5. [The Toronto Sun](#), May 19, 2000, Friday,, Final EDITION, NEWS,, Pg. 32, 174 words, KILLER INSULTS VICTIM'S KIN, ALAN CAIRNS, TORONTO SUN, BARRIE
- 6. [Mondaq Business Briefing - Hale and Dorr LLP, US](#), November 3, 1999, 02275027, 2096 words, US: Business Methods Patents - The Effects Of State Street On Electronic Commerce And The Internet, Alter, Scott M
... 7. Patent number **5,191,573** and 5,675,734 ...
- 7. [The Computer Lawyer](#), October, 1999, PATENT; Vol. 16, No. 10; Pg. 3, 11742 words, What the General Intellectual Property Practitioner Should Know about Patenting Business Methods, by David L. Hayes; David L. Hayes is a partner and is Chairman of the Intellectual Property Practice Group at Fenwick & West in Palo Alto. CA. Copyright © 1999 Fenwick & West LLP.
... terms of the matched coupons. **5,191,573** Title: "Method for ...
... US Pat. No. **5,191,573** described above. Enforcement: ...
... Sightsound.com asserted this and the **5,191,573** patent above against ...
- 8. [Salon.com](#), March 9, 1999 Tuesday, Feature, 2469 words, How can they patent that?, By Peter Wayner
... eyes. Or consider patents **5191573** and 5675734, created by ...
... N2K, is evaluating what patents **5191573** and 5675734 mean to his company's ...
- 9. [Business Wire](#), May 19, 1998, Tuesday, 867 words, Digital Sight/Sound Rolls Out First Patented Method for Sale of Digital Audio/Video Over the Internet, LOS ANGELES
... United States Patents **5,191,573** and 5,675,734. "A2B is a ...
- 10. [Business Wire](#), May 18, 1998, Monday, 867 words, Digital Sight/Sound Rolls Out First Patented Method for Sale of Digital Audio/Video Over the Internet, LOS ANGELES
... United States Patents **5,191,573** and 5,675,734. "A2B is a ...

Source: [Command Searching > News, All \(English, Full Text\)](#) 

Terms: **5191573** or **5,191,573** ([Edit Search](#) | [Suggest Terms for My Search](#))

Select for FOCUS™ or Delivery

11. [Intellectual Property Today](#), March, 1998, RFC EXPRESS TM; Recently Filed Patent Cases; Pg. 23, 1248 words
... vs. N2K INC. **5,191,573**; 5,675,734 97-2387 -- ...

Source: [Command Searching > News, All \(English, Full Text\)](#) 

Terms: **5191573** or **5,191,573** ([Edit Search](#) | [Suggest Terms for My Search](#))

View: Cite

Date/Time: Tuesday, July 17, 2007 - 1:29 PM EDT



LexisNexis®

[About LexisNexis](#) | [Terms & Conditions](#)

Copyright © 2007 LexisNexis, a division of Reed Elsevier Inc. All rights reserved.



UNITED STATES PATENT AND TRADEMARK OFFICE

UNITED STATES DEPARTMENT OF COMMERCE
United States Patent and Trademark Office
Address: COMMISSIONER FOR PATENTS
P.O. Box 1450
Alexandria, Virginia 22313-1450
www.uspto.gov

APPLICATION NO.	FILING DATE	FIRST NAMED INVENTOR	ATTORNEY DOCKET NO.	CONFIRMATION NO.
90/007,402	01/31/2005	5191573	NAPS001	2998

23973 7590 07/30/2007

DRINKER BIDDLE & REATH
ATTN: INTELLECTUAL PROPERTY GROUP
ONE LOGAN SQUARE
18TH AND CHERRY STREETS
PHILADELPHIA, PA 19103-6996

EXAMINER

ART UNIT PAPER NUMBER

DATE MAILED: 07/30/2007

Please find below and/or attached an Office communication concerning this application or proceeding.



DO NOT USE IN PALM PRINTER

(THIRD PARTY REQUESTER'S CORRESPONDENCE ADDRESS)

Albert S. Penilla
Martine Penilla & Gencarella, LLP
710 Lakeway Drive, Suite 200
Sunnyvale, CA 94085

EX PARTE REEXAMINATION COMMUNICATION TRANSMITTAL FORM

REEXAMINATION CONTROL NO. 90/007,402.

PATENT NO. 5191573.

ART UNIT 3992.

Enclosed is a copy of the latest communication from the United States Patent and Trademark Office in the above identified *ex parte* reexamination proceeding (37 CFR 1.550(f)).

Where this copy is supplied after the reply by requester, 37 CFR 1.535, or the time for filing a reply has passed, no submission on behalf of the *ex parte* reexamination requester will be acknowledged or considered (37 CFR 1.550(g)).

**Ex Parte Reexamination
Advisory Action
Before the Filing of an Appeal Brief**

Control No. 90/007,402	Patent Under Reexamination 5191573	
Examiner Roland G. Foster	Art Unit 3992	

--The MAILING DATE of this communication appears on the cover sheet with the correspondence address--

THE PROPOSED RESPONSE FILED 17 May 2007 FAILS TO OVERCOME ALL OF THE REJECTIONS IN THE FINAL REJECTION MAILED 17 March 2007.

1. Unless a timely appeal is filed, or other appropriate action by the patent owner is taken to overcome all of the outstanding rejection(s), this prosecution of the present *ex parte* reexamination proceeding WILL BE TERMINATED and a Notice of Intent to Issue *Ex Parte* Reexamination Certificate will be mailed in due course. Any finally rejected claims, or claims objected to, will be CANCELLED.
- THE PERIOD FOR RESPONSE IS EXTENDED TO RUN 2 MONTHS FROM THE MAILING DATE OF THE FINAL REJECTION. Extensions of time are governed by 37 CFR 1.550(c).

NOTICE OF APPEAL

2. An Appeal Brief is due two months from the date of the Notice of Appeal filed on 31 May 2007 to avoid dismissal of the appeal. See 37 CFR 41.37(a). Extensions of time are governed by 37 CFR 1.550(c). See 37 CFR 41.37(e).

AMENDMENTS

3. The proposed amendment(s) filed after a final action, but prior to the date of filing a brief, will not be entered because:
- (a) They raise new issues that would require further consideration and/or search (see NOTE below);
 - (b) They raise the issue of new matter (see NOTE below);
 - (c) They are not deemed to place the proceeding in better form for appeal by materially reducing or simplifying the issues for appeal; and/or
 - (d) They present additional claims without canceling a corresponding number of finally rejected claims.
- NOTE: _____ (See 37 CFR 1.116 and 41.33(a)).

4. Patent owner's proposed response filed _____ has overcome the following rejection(s): _____
5. The proposed new or amended claim(s) _____ would be allowable if submitted in a separate, timely filed amendment canceling the non-allowable claim(s).
6. For purposes of appeal, the proposed amendment(s) a) will not be entered, or b) will be entered and an explanation of how the new or amended claim(s) would be rejected is provided below or appended.
- The status of the claim(s) is (or will be) as follows:
Claim(s) patentable and/or confirmed: _____
Claim(s) objected to: _____
Claim(s) rejected: _____
Claim(s) not subject to reexamination: _____

AFFIDAVIT OR OTHER EVIDENCE

7. The affidavit or other evidence filed after a final action, but before or on the date of filing a Notice of Appeal will not be entered because patent owner failed to provide a showing of good and sufficient reasons why the affidavit or other evidence is necessary and was not earlier presented. See 37 CFR 1.116(e).
8. The affidavit or other evidence filed after the date of filing a Notice of Appeal, but prior to the date of filing a brief, will not be entered because the affidavit or other evidence fails to overcome all rejections under appeal and/or appellant failed to provide a showing of good and sufficient reasons why the affidavit or other evidence is necessary and was not earlier presented. See 37 CFR 41.33(d)(1).
9. The affidavit or other evidence is entered. An explanation of the status of the claims after entry is below or attached.

REQUEST FOR RECONSIDERATION/OTHER

10. The request for reconsideration has been considered but does NOT place the application in condition for allowance because: See the Continuation Sheet.
11. Note the attached Information Disclosure Statement(s), PTO/SB/08, Paper No(s) _____.
12. Other: _____.

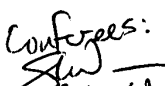
Conferees:

Scott L. Weaver
CRU Art Unit 3992

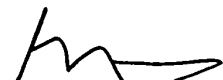
MARK J. REINHART
SPRE-AU 3992
CENTRAL REEXAMINATION UNIT

Roland G. Foster
Primary Examiner
Art Unit: 3992

cc: Requester (if third party requester)

REQUEST FOR RECONSIDERATION/OTHER (Continued)

The Request for Reconsideration, filed on May 17, 2007 (the "Request"), has been considered but is not deemed persuasive.

The Request includes a new Declaration of Dr. Tygar and other new evidence in the form of non-patent literature describing a videoconferencing system that relies upon the use of a specialized High Speed Switched Digital Service (HDDS) rather than a telephone network. Both the declaration and the other evidence were submitted on May 17, 2007 after the final rejection, mailed March 17, 2007 (the "Final Rejection"). Indeed, this new evidence was submitted after the Final Rejection in response to issues (lack of entitlement to the benefit of an earlier filing date, written description, and enablement) first raised in an earlier Non-final rejection, mailed September 29, 2006 (the "Non-final Rejection"), thereby raising questions as to why this new evidence was not earlier presented. Despite this, the Request fails to provide ANY showing of good and sufficient reasons why this new evidence is necessary and was not earlier presented, contrary to 37 CFR 1.116(e) and contrary to the notice provided on pages 38 and 39 of the Non-final Rejection. See also MPEP § 2260 and 2272, especially regarding policy reasons. Thus, the said new evidence has not been entered nor considered by the examiner.

On pages 4-11 of the Request, the Patent Owner reiterates many of the arguments made in response to the Non-final Rejection and previously deemed unpersuasive. Thus, Patent Owner's present arguments are deemed unpersuasive for similar reasons.

In addition, the Patent Owner repeatedly asserts that the "office admits the '573 patent is not a continuation-in-part, but then asserts that the '573 Patent 'shares the characteristics of a continuation-in-part." For example, see pages 4 and 6 of the Request. The Patent Owner however has not cited to a section in the Final Rejection where this admission was allegedly made, and the examiner has not determined where he made this admission. Thus, Patent Owner's arguments that such an admission was made are unpersuasive.

On page 8 of the Request, the Patent Owner asserts that the "office admits that Examiner Nguyen did in fact address the issue of alleged new matter shown in Table I of the instant Office Action...[t]he Office further admits that Patentee has effectively demonstrated as much through the table submitted with Patentee's Response to the Office Action of September 29, 2006." The Patent Owner however has not cited to a section in the Final Rejection where these admissions were allegedly made, and the examiner has not determined where he made these admissions. Thus, Patent Owner's argument that such admissions were made is unpersuasive.

On page 12 of the Request, the Patent Owner argues that the "Office may only examine the recitation of 'hard disk' for compliance with Section 112, first paragraph." This argument is unpersuasive however because the claims recite a new limitation directed to a "second memory including a second party hard disk," not simply a "hard disk" as argued. Accordingly, the Final Rejection included 112, 1st paragraph rejections regarding the download of video to a second memory and playback therefrom. Furthermore, "the question of new matter should be considered in a reexamination proceeding." MPEP 2258.II.B.

On page 14 of the Request, the Patent Owner argues that the originally filed specification explicitly states that the disclosed invention eliminates the need to handle tapes and CDs. This argument however is not persuasive because the cited portion of the specification instead states that a hard disk "thus eliminat[es]...the need to unnecessarily handl[e]...tapes, or compact discs on a regular basis." Thus, the specification as originally filed does not preclude the possibility that tapes and CDs are used to store the downloaded music, albeit not on a regular basis. This embodiment thus directly contradicts the newly introduced, negative limitations directed to a "non-volatile storage portion of the second memory, wherein the non-volatile storage portion is not a tape or a CD." Indeed by pointing to that part of the specification that teaches storing the data on a hard disk, the Patent Owner's arguments support the position that the specification as originally filed teaches of a second memory in the form of hard disk, but fails to necessarily disclose (require) the broader, artificially created sub-genus corresponding to the negative limitation, namely a second memory that is not necessarily a hard disk, and that is also not a tape or CD either.

Pages 16-20 of the Request, the Patent Owner refers to newly submitted evidence that has not been entered or considered by the examiner as discussed above.

Pages 20-27 of the Request, the Patent Owner argues against the applied references individually for failing to teach features that were not relied upon in the specific 35 USC 103 combinations set forth in the Final Rejection. Thus, the Patent Owner arguments are unpersuasive. As for arguments regarding teaching away, the mere disclosure of an alternate embodiment does not constitute "teaching away."

Index of Claims



Application/Control No.

90/007,402

Examiner

Roland G. Foster

Applicant(s)/Patent under Reexamination

5191573

Art Unit

3992

✓	Rejected
=	Allowed

-	(Through numeral) Cancelled
+	Restricted

N	Non-Elected
I	Interference

A	Appeal
O	Objected

Claim		Date			
Final	Original	7/16/07			
	1	✓			
	2	✓			
	3	✓			
	4	✓			
	5	✓			
	6	✓			
	7				
	8				
	9				
	10				
	11				
	12				
	13				
	14				
	15				
	16				
	17				
	18				
	19				
	20				
	21				
	22				
	23				
	24				
	25				
	26				
	27				
	28				
	29				
	30				
	31				
	32				
	33				
	34				
	35				
	36				
	37				
	38				
	39				
	40				
	41				
	42				
	43				
	44	✓			
	45	✓			
	46	✓			
	47	✓			
	48	✓			
	49	✓			
	50				

Claim		Date			
Final	Original				
	51				
	52				
	53				
	54				
	55				
	56				
	57				
	58				
	59				
	60				
	61				
	62				
	63				
	64				
	65				
	66				
	67				
	68				
	69				
	70				
	71				
	72				
	73				
	74				
	75				
	76				
	77				
	78				
	79				
	80				
	81				
	82				
	83				
	84				
	85				
	86				
	87				
	88				
	89				
	90				
	91				
	92				
	93				
	94				
	95				
	96				
	97				
	98				
	99				
	100				

Claim		Date			
Final	Original				
	101				
	102				
	103				
	104				
	105				
	106				
	107				
	108				
	109				
	110				
	111				
	112				
	113				
	114				
	115				
	116				
	117				
	118				
	119				
	120				
	121				
	122				
	123				
	124				
	125				
	126				
	127				
	128				
	129				
	130				
	131				
	132				
	133				
	134				
	135				
	136				
	137				
	138				
	139				
	140				
	141				
	142				
	143				
	144				
	145				
	146				
	147				
	148				
	149				
	150				

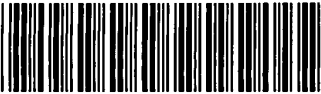
Reexamination 	Application/Control No. 90/007,402	Applicant(s)/Patent Under Reexamination 5191573
	Certificate Date	Certificate Number

Requester	Correspondence Address:	<input type="checkbox"/> Patent Owner	<input checked="" type="checkbox"/> Third Party
<p>Albert S. Penilla Martine Penilla & Gencarella, LLP 710 Lakeway Drive, Suite 200 Sunnyvale, CA 94085</p>			

LITIGATION REVIEW <input checked="" type="checkbox"/>	rgf <small>(examiner initials)</small>	2/17/07 <small>(date)</small>
Case Name		Director Initials
Sightsound Tech. v. Roxio, Inc., 2:04cv1549, U.S. District, Pennsylvania Western (stay pending reexamination)		<i>written for Lissi Mojica Margolis</i> ↓
Sightsound v. N2K, Inc., U.S. District, Pennsylvania		

COPENDING OFFICE PROCEEDINGS	
TYPE OF PROCEEDING	NUMBER
1. Ex Parte reexam for related patent	90007403
2. Ex Parte reexam for related patent	90007407
3.	
4.	



7-31-07

REEXAM
B

CERTIFICATE OF MAILING BY FIRST CLASS MAIL	
Applicant(s)	: Arthur R. Hair
Docket No.	: NAPS001
Serial No.	: 90/007,402
Filing Date	: January 31, 2005
Examiner	: Roland G. Foster
Group Art Unit	: 3992
Confirmation No.	: 2998
Invention	: Method for Transmitting a Desired Digital Video or Audio Signal

I hereby certify that the following correspondence:

<p>Brief on Appeal Under 37 C.F.R. § 41.37, check for \$500.00 and return postcard receipt</p>

is being deposited with the United States Postal Service addressed to MS Assignment Recordation Services, Commissioner for Patents, P.O. Box 1450, Alexandria, VA 22313-1450 on **July 30, 2007**

Katrina D'Oliveira

08/06/2007 JBRWN3 00000007 90007402
01 FC:1402
500.00 OP

Express Mail No.: EV 299882834 US

Control No.: 90/007,402

Attorney's Docket No. NAPS001

Patent

IN THE UNITED STATES PATENT AND TRADEMARK OFFICE

In re Application of: Arthur R. Hair	:	Group No.: 3992
	:	
Serial No.: 90/007,402	:	Examiner: Roland G. Foster
	:	
Filed: January 31, 2005	:	Confirmation No. 2998
	:	

For: METHOD FOR TRANSMITTING A DESIRED DIGITAL VIDEO OR AUDIO SIGNAL

BRIEF ON APPEAL UNDER 37 C.F.R. § 41.37

Mail Stop Appeal Brief - Patents
Commissioner for Patents
P.O. Box 1450
Alexandria, VA 22313-1450

Real Party in Interest

Appellant's real party in interest is:

DMT Licensing, LLC (a wholly-owned subsidiary of GE Intellectual Property
Licensing, Inc., which is a wholly-owned subsidiary of General
Electric Co.)
105 Carnegie Center
Princeton, New Jersey 08540

Related Appeals and Interferences

The Appeals in copending reexaminations 90/007,403 and 90/007,407 are related to the instant Appeal. The outcomes in these copending Appeals may affect, be affected by, or have some bearing on the Board's decision in the instant Appeal.

Status of the Claims

Claims 1 through 6 and 44 through 49 are currently pending. Claims numbered 1 to 6 were originally issued in U.S. Patent 5,191,573 (the "573 Patent"). Claims 7 through 43 were

added during reexamination and subsequently canceled following the vacating of the Office Action issued by the United States Patent and Trademark Office (the "Office") on March 20, 2006 finally rejecting all of the claims in reexamination. Claims 44 through 49 were added in the Response to the Non-Final Office Action issued on September 29, 2006.

Claims 1 through 6 and 44 through 49 are rejected under 35 U.S.C. § 112, first paragraph. Claims 1, 2, 4, 5, 44, 45, 47 and 48 are rejected under 35 U.S.C. § 102(e). Claims 1 through 6 and 44 through 49 are rejected under 35 U.S.C. § 103(a).

Appellant appeals the rejection of all claims.

Status of Amendments

All amendments have been entered.

Summary of the Claimed Subject Matter

Claims 1, 4, 44 and 47 are the independent claims. Below, Appellant summarizes the claimed subject matter in the independent claims per 37 C.F.R. § 41.37(c)(1)(v) using references to the Figures and column and line numbers in the issued patent.

Independent Claim 1 recites a method for transmitting a desired digital audio signal stored on a first memory of a first party to a second memory of a second party [Abstract]. The method comprises the steps of transferring money electronically via a telecommunication line to the first party at a location remote from the second memory and controlling use of the first memory from the second party, the second party being financially distinct from the first party [col. 2, lns. 63 to 67; col. 3, lns. 6 to 7; col. 5, lns. 32 to 34], and the second party controlling use and in possession of the second memory [col. 2, lns. 40 to 47; col. 3, lns. 12 to 17; col. 3, lns. 52 to 59]. The method further comprises connecting electronically via a telecommunications line the first memory with the second memory such that the desired digital

audio signal can pass there-between [Fig. 1; col. 2, lns. 51 to 67; col. 3, lns. 8 to 12], transmitting the desired digital audio signal from the first memory with a transmitter in control and possession of the first party to a receiver having the second memory at a location determined by the second party, said receiver in possession and control of the second party [Figure 1; col. 2, lns. 51 to 67; col. 3, lns. 13 to 19 and 60 to 67; col. 4, lns. 25 to 44] and storing the digital signal in a non-volatile storage portion of the second memory, wherein the non-volatile storage portion is not a tape or CD [col. 2, lns. 31 to 35; col. 3, lns. 17 to 19; col. 4, lns. 41 to 43].

Independent Claim 4 recites a method for transmitting a desired digital video signal stored on a first memory of a first party to a second memory of a second party [Abstract]. The method comprises the steps of transferring money electronically via a telecommunications line to the first party at a location remote from the second memory and controlling use of the first memory from a second party financially distinct from the first party [col. 2, lns. 63 to 67; col. 3, lns. 6 to 7; col. 5, lns. 32 to 34], said second party in control and in possession of the second memory [col. 2, lns. 40 to 47; col. 3, lns. 12 to 17; col. 3, lns. 52 to 59]. The method further comprises connecting electronically via a telecommunications line the first memory with the second memory such that the desired digital video signal can pass there-between [Figure 1; col. 2, lns. 51 to 67; col. 3, lns. 8 to 12, col. 5, ln. 67 to col. 6, ln. 2], transmitting the desired digital video signal from the first memory with a transmitter in control and possession of the first party to a receiver having the second memory at a location determined by the second party, said receiver in possession and control of the second party [Figure 1; col. 2, lns. 51 to 67; col. 3, lns. 13 to 19 and 60 to 67; col. 4, lns. 25 to 44; col. 5, ln. 67 to col. 6, ln. 2] and storing the digital

signal in a non-volatile storage portion of the second memory, wherein the non-volatile storage portion is not a tape or CD [col. 2, lns. 31 to 35; col. 3, lns. 17 to 19; col. 4, lns. 41 to 43].

Independent claim 44 recites a method for transmitting a desired digital audio signal stored on a first memory of a first party to a second memory of a second party [Abstract; col. 5, ln. 67 to col. 6, ln. 2]. The method comprises the steps of transferring money electronically via a telecommunications line to the first party at a location remote from the second memory and controlling use of the first memory from the second party financially distinct from the first party [col. 2, lns. 63 to 67; col. 3, lns. 6 to 7; col. 5, lns. 32 to 34], said second party controlling use and in possession of the second memory [col. 2, lns. 40 to 47; col. 3, lns. 12 to 17; col. 3, lns. 52 to 59]. The second memory includes a second party hard disk [Fig. 1 (60); col. 3, ln. 57]. The method further comprises connecting electronically via a telecommunications line the first memory with the second memory such that the desired digital audio signal can pass therebetween [Fig. 1 (20B, 30, 50B); col. 2, lns. 51 to 67; col. 3, lns. 8 to 12], transmitting the desired digital audio signal from the first memory with a transmitter in control and possession of the first party to a receiver having the second memory at a location determined by the second party, said receiver in possession and control of the second party [Figure 1; col. 2, lns. 51 to 67; col. 3, lns. 13 to 19 and 60 to 67; col. 4, lns. 25 to 44] and storing the digital signal in the second party hard disk [col. 3, lns. 17 to 19; col. 4, lns. 41 to 43].

Independent Claim 47 recites a method for transmitting a desired digital video signal stored on a first memory of a first party to a second memory of a second party [Abstract; col. 5, ln. 67 to col. 6, ln. 2]. The method comprises the steps of transferring money electronically via a telecommunications line to the first party at a location remote from the second memory and controlling use of the first memory from the second party financially distinct from the first party

[col. 2, lns. 63 to 67; col. 3, lns. 6 to 7; col. 5, lns. 32 to 34], said second party controlling use and in possession of the second memory [col. 2, lns. 40 to 47; col. 3, lns. 12 to 17; col. 3, lns. 52 to 59]. The second memory includes a second party hard disk [Fig. 1 (60); col. 3, ln. 57]. The method further comprises connecting electronically via a telecommunications line the first memory with the second memory such that the desired digital video signal can pass therebetween [Figure 1; col. 2, lns. 51 to 67; col. 3, lns. 8 to 12, col. 5, ln. 67 to col. 6, ln. 2], transmitting the desired digital video signal from the first memory with a transmitter in control and possession of the first party to a receiver having the second memory at a location determined by the second party, said receiver in possession and control of the second party [Figure 1; col. 2, lns. 51 to 67; col. 3, lns. 13 to 19 and 60 to 67; col. 4, lns. 25 to 44; col. 5, ln. 67 to col. 6, ln. 2] and storing the digital signal in the second party hard disk [col. 3, lns. 17 to 19; col. 4, lns. 41 to 43].

Grounds for Rejection to be Reviewed on Appeal

1. Examiner's rejection of Claims 1, 2, 4, 5, 44, 45, 47 and 48 under 35 U.S.C. § 102(e) and 35 U.S.C. § 103(a) over U.S. Patent 4,949,187 to Cohen (*Cohen*). In particular, Appellant seeks review of the Examiner's assertion that the '573 Patent is not entitled to the filing date of June 13, 1988, the assertion having to be correct before *Cohen* could be cited as a prior art reference.
2. Examiner's rejection of Claims 3, 6, 46 and 49 under 35 U.S.C. § 103(a) over *Cohen* in view of U.S. Patent 4,789,863 to Bush (*Bush*). In particular, Appellant seeks review of the Examiner's assertion that the '573 Patent is not entitled to the filing date of June 13, 1988, the assertion having to be correct before *Cohen* could be cited as a prior art reference.

3. Examiner's rejection of Claims 1 through 6 and 44 through 49 under 35 U.S.C. § 103(a) over *Bush* in view of *Cohen*. In particular, Appellant seeks review of the Examiner's assertion that the '573 Patent is not entitled to the filing date of June 13, 1988, the assertion having to be correct before *Cohen* could be cited as a prior art reference.
4. Examiner's rejection of Claims 1 through 6 and 44 through 49 under 35 U.S.C. § 103(a) over *Bush* in view of U.S. Patent 4,837,797 to Freeny (*Freeny I*).
5. Examiner's rejection of Claims 1 through 6 and 44 through 49 under 35 U.S.C. § 103(a) over Japanese Patent Application No. 62-284496 to Akashi (*Akashi*) in view of U.S. Patent 4,528,643 to Freeny (*Freeny II*).
5. Examiner's rejection of Claims 1 through 6 and 44 through 49 under 35 U.S.C. § 112, first paragraph as not being supported by the written description in the specification.
6. Examiner's rejection of Claims 4 through 6 and 47 through 49 under 35 U.S.C. § 112, first paragraph as not being enabled by the specification.

Argument

I. Summary

The instant reexamination was originally filed on January 31, 2005, and was initially assigned to Examiner Benjamin Lanier ("Examiner Lanier"). The reexamination and two related copending reexaminations subsequently were transferred to the Central Reexamination Unit ("CRU") where they were assigned to Examiner Roland Foster ("Examiner Foster").

During the course of the proceedings in the instant reexamination, five Office Actions were issued. The first three Office Actions were issued by Examiner Lanier, who consistently rejected all claims presented by Appellant as obvious. In each case, Examiner Lanier relied on combinations of up to nine references in his obviousness analyses, offering only conclusory

statements regarding the motivation or teaching to combine the multiple references. In each case, the Appellant pointed out the impropriety of the combinations. Examiner Lanier never rebutted the Appellant's arguments. Instead, Examiner Lanier simply asserted that the rejections were proper.

Following the issuance of the third Office Action by Examiner Lanier, the instant reexamination was transferred to the CRU, specifically to Examiner Foster, where the Office reviewed and vacated Examiner Lanier's Final Rejection of the claims. The Office appeared to concur with the Appellant's view that the rejections offered by Examiner Lanier were untenable, but the Office did not allow the claims. Instead, the Office issued two subsequent Office Actions.

The two subsequent Office Actions take an alternate approach which, since also improper, has led to this appeal. Instead of relying on up to nine references, these subsequent Office Actions relied primarily on references that post-dated the June 13, 1988 priority date for the '573 Patent. In other words, the Office Actions relied on non-*prior* art. To justify this, the Office first had to conduct a *de novo* review of the '573 Patent's prosecution and then, based on that review, reassign the '573 Patent's June 13, 1988 priority date; a priority date that was rightfully granted by the original Examiner during the initial examination of the '573 Patent. In taking those steps, the Office reassigned the priority date to September 18, 1990. Then, using this new priority date, the Office cited new art post-dating the June 13, 1988 priority date, which the Office asserts anticipates or makes obvious all of the claims in reexamination.

As detailed below, this *de novo* review and resulting reassignment of the priority date is clearly outside the scope of authority of the Office as granted by the Reexamination Statute. 35

USC § 301, *et seq.* Further, the attempted reassignment of a new priority date to the '573 Patent does not comport with Office procedures.

Further, as a predicate for reassigning the priority date of the claims in the '573 Patent, the Office asserts that the claims as issued are either not supported by a written description or are not enabled by the specification as filed on June 13, 1988. In making these findings, the Office has applied improper and overly strict standards for both written description and enablement under 35 U.S.C. § 112, first paragraph. Using the appropriate standards, Appellant has demonstrated that the claims in reexamination are fully supported and enabled by the originally filed specification, and are thus entitled to the priority date of June 13, 1988.

Where the Office has presented obviousness rejections relying solely on references that do qualify as prior art based on the proper June 13, 1988 priority date, the Office has failed to present a reasoned argument showing a teaching or motivation to combine the references, as required by *KSR Int'l Co. v. Teleflex Inc.*, 127 S. Ct. 1727 (U.S. 2007). Further, as demonstrated by Appellant, these references do not show each and every limitation of the claims in reexamination. As a result, the Office has not established a *prima facie* case of obviousness based on those references that are proper prior art.

The Office has also rejected Claims 1 through 6 and 44 through 49 in reexamination under 35 U.S.C. § 112, first paragraph, as not being supported by an adequate written description and as not being enabled by the specification. Here again, Appellant maintains that the Office has acted outside the mandated scope of reexamination by examining Claims 1 through 6 and 44 through 49 in their entirety for compliance with section 112, first paragraph, rather than limiting the analysis to newly claimed subject matter. Further, the Office has again applied improper standards for both written description support and enablement. Using the

appropriate standards, Appellant has demonstrated that the claims in reexamination do comply with the requirements section 112, first paragraph.

Since many of the positions taken by the Office in finally rejecting Claims 1 through 6 and 44 through 49 rely on a revisiting of issues dealt with during the original examination of the '573 Patent, it is appropriate here to summarize the prosecution history of the '573 Patent.

Appellant's arguments herein will refer to the summary provided in Section II below.

II. Prosecution History of the '573 Patent

The '573 Patent issued from U.S. Patent Application Serial No. 07/586,391 (the "'391 Application'"), which was filed as a continuation of U.S. Patent Application Serial No. 07/206,497 (the "'497 Application'"). The '497 Application was originally filed on June 13, 1988 by Arthur Hair as a *pro se* applicant.¹ In the period after the initial filing of the '497 Application, Mr. Hair retained Ansel M. Schwartz as patent counsel. The Application was assigned to Examiner Hoa T. Nguyen ("Examiner Nguyen").

On December 19, 1988, Mr. Schwartz filed a preliminary amendment canceling original Claims 1 through 10 in the '497 Application and replacing them with new Claims 11 through 13, which read as follows:

11. A method for transmitting a desired digital audio music signal stored on a first memory to a second memory comprising the steps of:
transferring money to a party controlling use of the first memory from a party controlling use of the second memory;
connecting electronically the first memory with the second memory such that the desired digital signal can pass therebetween;
transmitting the digital signal from the first memory to the second memory; and
storing the digital signal in the second memory. (emphasis added).

¹ The application which became the '497 Application was actually mailed on June 9, 1988. However, since Mr. Hair was unaware of the use of Express Mail, the application was accorded the date that it actually was received at the Office.

12. A method as described in Claim 11, including after the *transferring* step, the steps of *searching the first memory* for the desired digital audio signal; and *selecting the desired digital audio signal* from the first memory. (emphasis added).

13. A method as described in Claim 12 wherein the transferring step includes the steps of *telephoning* the party controlling use of the first memory by the party controlling the second memory; *providing a credit card number* of the party controlling the second memory to the party controlling the first memory so that the party controlling the second memory is *charged money*.

The first Office Action in the '497 Application was issued on November 15, 1988 on the basis of Claims 11 to 13 added by the preliminary amendment. All of the claims were rejected as anticipated by U.S. Patent 3,718,906. Mr. Schwartz responded to the Office Action on February 26, 1990. In this response, Claims 14 through 20 were added. Exemplary Claims 14 and 15 read as follows:

14. A method as described in Claim 11 wherein the transmitting step includes the step of transmitting the digital signal from the first memory to the second memory at *a location determined by the second party* controlling use of the second memory. (emphasis added)

15. A method for transmitting a desired a *digital video* or audio music signal stored on a first memory to a second memory comprising the steps of:
charging a fee to a first party controlling use of the second memory;
connecting the first memory with the second memory such that the digital signal can pass therebetween;
transmitting the digital signal from the first memory to the second memory; and
storing the digital signal in the second memory. (emphasis added)

The second Office Action in the '497 Application was issued on May 10, 1990 on the basis of Claims 11 to 20. All of the claims were rejected as anticipated by either of U.S. Patent 3,718,906 or 3,990,710. Mr. Schwartz responded to this Office Action on August 21, 1990. In this response, Claims 11, 12 and 15 were amended and Claim 21 was added. Claims 14 and 16

to 20 were canceled. Claims 11 and 15 were amended by including the recitation of a “transmitter” and a “receiver.” New Claim 21 read identically to Claim 12, except that it depended from independent Claim 15. On September 9, 1990, Examiner Nguyen issued an Advisory Action indicating that the amendments would not be entered.

The amendment was resubmitted with a File Wrapper Continuation and subsequently entered. The File Wrapper Continuation was assigned application serial number 07/586,391 (the “‘391 Application”). The ‘391 Application was filed as a **continuation** of the parent ‘497 Application and claimed priority to the June 13, 1988 filing date. In fact, due to a clerical error, Mr. Schwartz was required to revive the ‘497 Application as unintentionally abandoned for the express purpose of establishing copendency with the ‘391 Application so that a proper claim for priority could be made. No new oath was required by the Office when the ‘391 Application was filed.

The first Office Action in the ‘391 Application was issued on September 9, 1991 on the basis of Claims 11 to 13, 15 and 21. All of the claims were rejected as obvious over U.S. Patent 3,990,710. Mr. Schwartz responded to this Office Action on December 9, 1991. In this response, Claims 11 and 15 were amended to recite that the first party location was remote from the second party location. Claim 15 was further amended to delete the reference to digital audio signals. Claim 22 was added, and was essentially identical to Claim 13, but depended from Claim 21. In addition to the claim amendments, text was added to pages 3 and 5 of the specification.

The next Office Action in the ‘391 Application was issued on February 24, 1992 on the basis of Claims 11 to 13, 15, 21 and 22. In the Office Action, Examiner Nguyen explicitly objected to the amendments to the specification and rejected all of the claims as being

unsupported by the originally filed specification. *See* pages 5 to 6 of the February 24, 1992 Office Action. Examiner Nguyen specifically pointed out the following as not having a basis in the original specification:

- (1) "transferring money"
- (2) "second party financially distinct from the first party"
- (3) "in the controlling step 'receiver in possession...of the second party'"
- (4) "telephoning"
- (5) "providing a credit card"

The specification was objected to "as originally filed, failing to provide clear support for the amendments to pages 3 and 5." The amendments to pages 3 and 5 encompassed the entirety of the amendments to the specification. Claims 11 to 13, 15, 21 and 22 were also rejected as obvious over U.S. Patent 3,990,710.

Mr. Schwartz responded to this Office Action on June 23, 1992. In this response, the amendments to the specification adding text at pages 3 and 5 were withdrawn. A substitute specification was submitted to address formal issues. Further, a new amendment to the specification was presented adding a new Abstract and adding text at page 6 and page 12 of the substitute specification. Claims 11 and 15 were amended to recite "transferring money electronically via a telecommunications line" and "connecting electronically via a telecommunications line." Claim 15 was again amended to delete "audio." Claim 23 was added.

In addition to the amendments and arguments filed with the Office Action response on June 23, 1992, Mr. Schwartz also filed a Declaration by Arthur Hair under 37 C.F.R. § 1.132 indicating that one of ordinary skill in the art would recognize that all of the terminology presented in the claims and specification by amendment was supported by the originally filed specification.

The next Office Action in the '391 Application was issued on September 21, 1992 on the basis of Claims 11 to 13, 15 and 21 to 23. The Office Action indicated that Claims 11 to 13, 15, 21 and 22 were allowable based on the response filed on June 23, 1992. Claim 23 was rejected. Mr. Schwartz responded to this Office Action on September 30, 1992 by canceling rejected Claim 23. The Examiner proceeded to issue a Notice of Allowance and Issue Fee Due on October 19, 1992. The Issue Fee was paid on December 4, 1992 and the '391 Application duly issued as the '573 Patent on March 2, 1993.

III. THE APPROPRIATE PRIORITY DATE FOR THE CLAIMS OF THE '573 PATENT IN REEXAMINATION IS JUNE 13, 1988

As set forth in Section II above, the '573 Patent issued from U.S. Patent Application Serial No. 07/586,391 (the "'391 Application'"), which was filed as a continuation of U.S. Patent Application Serial No. 07/206,497 (the "'497 Application'"). The Office admits the '573 Patent is not a continuation-in-part, but asserts that the '573 Patent "shares the characteristics of a continuation-in-part." The Office now attempts to use this novel characterization of the '573 Patent as a pretext to re-examine the priority date of the claims in the '573 Patent, which Examiner Nguyen had properly awarded as June 13, 1988. In particular, the Office is attempting to improperly reassign a priority date of September 18, 1990 to the claims in reexamination.

The Office's actions in reassigning a priority date are improper procedurally, and incorrect based on the prosecution history of the '573 Patent. In the first instance, the reexamination statutes do not empower the Office to examine claims for issues of effective priority date in the absence of a continuation-in-part in the original examination history. On this basis alone, the Board should vacate the Examiner's findings with respect to the proper priority date of the claims in the '573 Patent. Even if the Board does not vacate the Examiner's findings

on this basis, the Board should vacate the Examiner's findings because the issue was thoroughly dealt with by Examiner Nguyen during the initial examination of the '573 Patent, and thus does not present a new issue related to patentability. Even putting those arguments aside, the Board should vacate the Examiner's findings with respect to priority because the claims as issued in the '573 Patent and as currently constituted in reexamination are clearly supported by the original specification filed on June 13, 1988.

A. The Office Exceeded Its Statutory Authority In Considering Issues Of Priority In The Instant Reexamination

The Office exceeded its statutory authority by considering issues of priority in the instant reexamination. It is well established that the scope of a reexamination proceeding is limited to whether claims are patentable under 35 U.S.C. §§ 102 and 103 "on the basis of patents and printed publications." 37 C.F.R. § 1.552. The reexamination rules explicitly preclude consideration of issues arising under 35 U.S.C. § 112, except "with respect to subject matter added or deleted in the reexamination proceeding." *Id.*; see also *In re Etter*, 756 F.2d 852, 856 (Fed. Cir. 1985) (*en banc*) ("only new or amended claims are also examined under 35 U.S.C. §§ 112 and 132").

Moreover, the inquiry under Section 120 as to whether the language of a particular claim, as filed or amended during an original prosecution, was supported or unsupported by sufficient disclosure is, by definition, not a *new* question. Rather, it is an issue that necessarily arises at the time of original filing or amendment, and one that necessarily is before the original examiner. Where a continuation-in-part ("CIP") appears in the prosecution history of a patent in reexamination, it may be necessary to make an inquiry into whether claims in the CIP, as issued or amended in reexamination, find support in the originally filed parent application or rely on new matter added when the CIP was filed during the original prosecution of the patent.

However, where no CIP appears in the record this issue cannot arise since by definition no new matter was found to be added during the original prosecution of the patent in question.

As a result, it is beyond the scope of reexamination for an examiner to make a threshold determination that new matter was added during the original examination of a patent in reexamination in the absence of a recognition of such new matter in the record of the original examination of the patent in question.

1. There Is No CIP In The Prosecution History Of The '573 Patent

The Office admits the '573 Patent is not a continuation-in-part, but then asserts the '573 Patent "shares the characteristics of a continuation-in-part," and cites this as a basis for assigning a later priority date to the claims of the '573 Patent. The Office points to text added to the specification of the '391 Application that was not found in the originally filed specification in the '497 Application as grounds for this new designation. The Office further cites MPEP § 201.11 to support its conclusion. However, the presence of additional or different text in the specification of a continuation application does not by itself render the continuation application a CIP. The prohibition of MPEP § 201.11 concerns addition of text that would constitute *new matter*.

As set forth in Section II above, the '391 Application was filed under the old File Wrapper Continuation procedure. According to MPEP § 201.06(b), in effect at the time, if the '391 Application had been filed as a CIP a new oath or declaration would have been required; none was required. Therefore, no CIP appears in the history of the original prosecution of the '573 Patent.

Further, the Office has cited no authority that empowers it, in the context of reexamination, to treat a continuation application as a CIP because the examiner in

reexamination believes the continuation “shares characteristics of a continuation-in-part.” An application or patent is either a continuation-in-part, or it is not. There simply is no designation in the statutes or regulations for patents that are continuations, but “share the characteristics of continuations-in-part”, as asserted by the Office. Therefore, the Office has no statutory basis for reassigning the priority date for the ‘573 Patent.

2. The Reexamination Statute Does Not Empower The Office To Address Issues Of Priority Under 35 U.S.C. § 120 In The Absence Of A CIP Application In The Prosecution History Of A Patent In Reexamination

The Office relies on MPEP §§ 2258(I)(C) and 2217 for an implicit grant of authority to cite intervening art based upon a newly determined effective filing date for claims. The Office refers to two cases: *In re Ruscetta*, 255 F.2d 687 (C.C.P.A. 1958) and *In re van Langenhoven*, 458 F.2d 132 (C.C.P.A. 1972), cited in MPEP § 2258(I)(C) as granting the underlying authority to address issues under 35 U.S.C. § 120 in reexamination. The Office’s reliance on *Ruscetta* and *van Langenhoven* is misplaced. Both *Ruscetta* and *van Langenhoven* deal explicitly with patents issued from CIP applications, which as discussed *supra*, is simply not the case in the present reexamination. Further, both cases pre-date the reexamination statute, and thus say nothing about the proper conduct of reexamination proceedings. The Office has cited no further authority to support its interpretation of *Ruscetta* or *van Langenhoven*. Moreover, the Office cannot expand the holdings of these cases simply by inserting references to them in MPEP sections dealing with the scope of reexamination. “The MPEP sets forth PTO procedures; it is not a statement of law.” *Regents of the Univ. of New Mexico v. Knight*, 321 F.3d 1111, 1121 (Fed. Cir. 2003).

In contrast to the present case, where a CIP application appears in the prosecution history of a patent in reexamination, it is appropriate to consider the issue of the effective priority date

of a claim in reexamination, since it is recognized that a CIP application may introduce new matter not disclosed in its parent application. However, where no CIP appears in the original prosecution record, the examiner in reexamination has no basis for determining that new matter was added during the original prosecution. Further, the limited scope of reexamination prohibits the examiner from undertaking this analysis on his own initiative.

3. MPEP § 2258.IV.E Does Not Empower The Office To Revisit The Issue Of The Entitlement To A Priority Date Of Claims In An Issued Patent

The Office cites MPEP § 2258.IV.E as an example of revisiting priority issues in reexamination. However, most of this section addresses only the procedural issues in reexamination for perfecting a claim for priority made previously during initial examination and does not address the merits of a claim for priority.

The cited section also deals with claiming priority under 35 U.S.C. § 120 to an earlier filed copending application during reexamination where there was an earlier *failure* to make such a claim. In the instant case, a claim of priority of June 13, 1988 was made by the applicant. Examiner Nguyen determined the '573 Patent was in fact entitled to that priority date. Since a claim of priority is, by definition, before the Examiner when it is made, it can never be a new issue in reexamination; *i.e.* an issue that the original Examiner had no reason to consider. Indeed, MPEP § 201.11, cited favorably by the Office, *requires* an Examiner to address the issue during initial examination.

Further, MPEP § 2258.IV.E does not address revisiting and removing an earlier claim of priority made in an application, and does not address the entitlement of an issued patent to an earlier claimed right of priority.

Finally, MPEP § 2258.IV.E addresses reexaminations initiated by the Appellant. The section does not empower the Office to address the issue of entitlement to a claimed priority date where the issue is not first raised by the Appellant.

The Office also cites MPEP § 1402, which concerns reissue proceedings, as an example of addressing priority issues. However, again, the cited section deals with adding or changing claims of priority, where an earlier claim contained an error or was not made at all. While MPEP § 1405 does address deletion of a priority claim in reissue, that section does not empower the Office on its own to determine the propriety of the priority claim.

Finally, 37 C.F.R. § 1.552(c) is explicit about the scope of re-examination:

Issues other than those indicated in paragraphs (a) and (b) of this section *will not be resolved in a reexamination proceeding*. If such issues are raised by the patent owner or third party requester during a reexamination proceeding, the existence of such issues will be noted by the examiner in the next Office action, in which case *the patent owner may consider the advisability of filing a reissue application to have such issues considered and resolved*.

37 C.F.R. § 1.552(c) (emphasis added). Therefore, notwithstanding MPEP § 1405, the propriety of a previously made priority claim cannot be revisited by the Office during reexamination.

B. The Priority Date For The Claims In The '573 Patent Is Not A New Issue Related To Patentability

Even if the reexamination statute did provide authority to address the issue of priority in reexamination, which it does not, the Office is still barred from considering the issue with respect to the '573 Patent because it does not present a new issue related to patentability.

1. Examiner Nguyen Assigned A Priority Date Of June 13, 1988 To The Claims In The '573 Patent

During initial examination of the '573 Patent, the '391 Application was filed as a **continuation** of the '497 Application and thus, as a preliminary matter, was entitled to the filing date of the original application, June 13, 1988. The Office makes much of the fact that the '391 Application was filed pursuant to the old File Wrapper Continuation procedure, which permitted the filing of CIPs. However, as set forth above, MPEP § 201.06(b), in effect at the time the '391 Application was filed, required that a CIP application filed pursuant to the File Wrapper Continuation procedure include a new oath or declaration. Since Examiner Nguyen did not require a new oath or declaration, as a threshold matter she assigned the priority date of June 13, 1988 to the '391 Application when it was filed.

Notwithstanding this, the Office has asserted that Examiner Nguyen did not consider or have reason to consider the issue of whether the additions to the specification constituted new matter. In support of these assertions, Examiner Foster provided a chart in the Office Action of September 29, 2006, showing when and under what circumstances additions to the specification and resulting claim amendments were made in the '497 and '391 Applications.

Appellant responded to this assertion by reproducing the Examiner's chart in amended form to demonstrate that Examiner Nguyen did in fact consider the various additions to the specification and concluded those additions did not constitute new matter and the subject claims therefore were supported under Section 112. The chart has been amended by adding three columns, subtitled respectively: "Consideration by Examiner Nguyen," "Response by Applicant," and "Subsequent Action by Examiner Nguyen." That chart is set forth below:

	Parent Application 07/206,497 filed June 13, 1988		Child Application 07/586,391 filed September 18, 1990		Office Action in Application 07/586,391 and response		Issuance of '573 Patent
Feature	Date First Appearing in Claims of Parent Application	Date First Appearing in Specification of Parent Application	Date First Appearing in Claims of Child Application	Date First Appearing in Specification of Child Application	Consideration by Examiner Nguyen	Response by Applicant	Subsequent Action by Examiner Nguyen
Transferring Money from Second Party to a First Party (Charging a Fee)	December 22, 1988 February 28, 1990			September 18, 1990	Considered in Office Action February 24, 1992	Objection/ rejections specifically responded to in June 25, 1992 response	Claims allowed in September 21, 1992 Office Action
Providing a Credit Card Number	December 22, 1988			September 18, 1990	Considered in Office Action February 24, 1992	Objection/ rejections specifically responded to in June 25, 1992 response	Claims allowed in September 21, 1992 Office Action
Controlling Use of First/Second Memory	December 22, 1988			September 18, 1990	Considered in Office Action February 24, 1992	Objection/ rejections responded to in June 25, 1992 response	Claims allowed in September 21, 1992 Office Action
Transmitting to a Location Determined by Second Party	February 28, 1990			September 18, 1990	Considered in Office Action February 24, 1992	Objection/ rejections responded to in June 25, 1992 response	Claims allowed in September 21, 1992 Office Action
Specific Video Download Procedures	February 28, 1990			September 18, 1990	No new matter issues were ever raised	No response was ever necessary since no issue was ever raised	Claims allowed in September 21, 1992 Office Action

First Party in Possession of Transmitter	August 24, 1990 (not entered)			September 18, 1990	Considered in Office Action February 24, 1992	Objection/rejections responded to in June 25, 1992 response	Claims allowed in September 21, 1992 Office Action
Second Party in Possession of Receiver and Second Memory	August 24, 1990 (not entered)			September 18, 1990	Considered in Office Action February 24, 1992	Objection/rejections specifically responded to in June 25, 1992 response	Claims allowed in September 21, 1992 Office Action

The foregoing chart shows that, following submission of the subject additions to the specification and corresponding amendments to the claims, Examiner Nguyen considered those additions and amendments in the Office Action of February 24, 1992. That consideration included an objection to the specification as containing new matter under Section 132, and corresponding rejections of the relevant claims under Section 112. The Applicant responded to, and overcame, that objection and those rejections in the Response of June 25, 1992. In that Response, the Applicant included arguments and a Declaration under 37 C.F.R. § 1.132 establishing that the additions to the specification had ample support in the originally filed specification because the subject matter of the additions was implicitly disclosed and understood by those skilled in the art.² After considering this Response by the Applicant, Examiner Nguyen withdrew the objection to the specification and the Section 112 rejections of the claims, and thereby determined the claims were allowable.

The amended chart set forth above demonstrates indisputably that Examiner Nguyen *did consider* the very same new matter and Section 112 rejections that the Office now asserts. As a

² As an ancillary matter, the Office now seems to question the persuasiveness of the Section 1.132 Declaration submitted by applicant during examination of the '391 Application. Appellant respectfully points out this is not an issue that can be addressed on reexamination. The original Examiner must be assumed to have done his job properly in the initial examination. See *Am. Hoist & Derrick Co. v. Sowa & Sons, Inc.*, 725 F.2d 1350, 1359 (Fed. Cir. 1984).

result, by definition, Examiner Nguyen determined that the claims in the '573 Patent were entitled to claim priority to the original June 13, 1988 filing date.

In the Office Action in the instant reexamination dated March 17, 2007, the Office admitted that Examiner Nguyen did in fact address the issue of the alleged new matter shown in the table above. The Office further admitted that Appellant has effectively demonstrated as much through the table submitted with Appellant's Response to the Office Action of September 29, 2006. However, the Office now asserts that Examiner Nguyen did not have an opportunity to compare all of the amendments to the claims and specification made during prosecution to the originally filed specification. The Office refers to "gradually added new matter," which the Office asserts was not addressed by Examiner Nguyen. However, the Office fails to explicitly identify what it considered the "gradually added new matter." At best, the Office merely refers generally to Table II in the Office Action dated March 17, 2007. Upon reviewing Table II in its entirety, it is apparent that the table merely contains the same alleged new matter as the table presented above. That is, Table II does include anything that could be identified as "gradually added new matter," nor does it include anything that the Office has not already admitted was reviewed and passed on by Examiner Nguyen. As a result, the Office's rejection amounts to a bogus rejection that fails to define what is meant by "gradually added new matter." *See, e.g.,* MPEP § 706.03(o) (noting that, in making a new matter rejection, an examiner is required to "identify the new matter by page and the line numbers and/or drawing figures and provide an appropriate explanation of [his/her] position"). Therefore, the rejection is improper and the Board should reverse it.

2. The Absence Of Rejections Based On Intervening References During The Initial Examination Of The '573 Patent Does Not Demonstrate Examiner Nguyen Failed To Address The Issue Of Priority

Notwithstanding the above, the Office also asserts that Examiner Nguyen never had reason to consider the propriety of the claim of priority made in the '391 Application, because no intervening references were ever cited by the Examiner. This line of argument by the Office effectively puts the rabbit in the hat by concluding that the absence of any intervening references in the record is conclusive evidence the issue of priority was never addressed by Examiner Nguyen. It is more plausible to conclude that no intervening references were cited because Examiner Nguyen properly concluded the '391 Application was entitled to the priority date of June 13, 1988. This conclusion is fully supported by the written record as detailed in Section II and Section III(B)(1) above.

3. The Office Lacks Jurisdiction To Review Again The Same Section 112 Issues Determined By Examiner Nguyen

As established above, the question of Section 112 support, and hence the appropriate priority date for the claims in the issued '573 Patent, were considered and passed on by Examiner Nguyen in the original examination. Therefore, as a matter of established law, the Office lacks jurisdiction under the facts in this proceeding to challenge again the Section 112 support and the June 13, 1988 priority date of the claims in reexamination.

In *Patlex Corp. v. Quiqq*, 680 F. Supp. 33 (D.C. Cir. 1988), the United States District Court for the District of Columbia addressed a situation substantially identical to the circumstances of the present reexamination. In that case, the District Court reversed, on summary judgment, a decision by the BPAI upholding the final rejection of three claims in a reexamination proceeding. The claims in question had issued in a patent that resulted from a string of continuation and divisional applications relating back to an original priority

application. The reexamination examiner took the position that the three claims were not entitled to the original priority date. Consequently, the reexamination examiner reassigned a later effective priority date, based on the reexamination examiner's determination that the specification had not enabled the three claims under Section 112 as of the original filing date.

The District Court determined, however, that the issue of whether the three claims were enabled under Section 112 previously had been considered and decided by the original examiner, and the Court therefore explicitly held that the reexamination examiner lacked jurisdiction to consider that issue again:

Entitlement to the ... [original priority] filing date was decided in the ... [original] examination. Plaintiffs contended then they were entitled to the [original priority] filing date, and the first Examiner considered then whether the [original] disclosure was enabling. Consequently, in order to reexamine ... [the patent] on the basis of whether the claims were anticipated by ... [later prior art], the reexamination examiner had to "reexamine" the question of whether the specification of the ... [original application] contained an enabling disclosure of the subject matter claimed in the ... [patent]. As noted above, however, the reexamination statute does not contemplate a "reexamination" of the sufficiency of a disclosure. Rather it is limited to reexamination of patentability based on prior art patents and publications. Hence, the Court concludes that the Examiner and the Board lack jurisdiction in this case to "reexamine" the sufficiency of the specification of the ... [original application].

Id. at 36-37. (Emphasis added). The holding of the *Patlex* case, therefore, is clear. Where, as in the present case, an original examiner already has considered and determined the sufficiency of a specification's disclosure under Section 112 and the resulting entitlement of claims to an original priority date, there is no "substantial new" question of patentability for reexamination, as required by 35 U.S.C. § 301, *et seq.* As a result, the Office lacks jurisdiction to "reexamine" that same issue for those same claims in a subsequent reexamination proceeding.

For this reason as well, the Board should vacate the Examiner's determinations regarding the proper priority date for the '573 Patent.

C. The Claims In The '573 Patent Plainly Are Supported By The Originally Filed Specification

The Office asserts that, for written description support, the claims in the '573 Patent rely on certain alleged new matter added to the specification during the original prosecution of the '573 Patent. The Office also asserts that the claims directed to the video embodiment of the invention are not supported by disclosure that was enabling as of the original June 13, 1988 filing date. As set forth above, Appellant's position is that the Office lacks jurisdiction to review issues of adequate written description and enablement, especially where the particular issue was dealt with explicitly in the original prosecution of the patent in reexamination. Those arguments aside, it is clear the originally filed specification does in fact provide both adequate written description for all of the claims and an enabling disclosure for those claims directed to the "video feature" of the invention.

1. The Claims As Issued In The '573 Patent Are Supported By Adequate Written Description In The Originally Filed Specification

Appellant provides below an analysis demonstrating that each element in Claims 1 through 6 as issued in the '573 Patent is supported, either explicitly or implicitly, by the original specification filed on June 13, 1988.

i) **The Proper Standard For Determining If The Claims Are Adequately Supported By The Specification As Filed**

As a preliminary matter, the standard for written support in the absence of *ipsis verbis* recitation of a claim limitation is not strictly the inherency or required interpretation standard urged by the Office. Rather, the proper standard generally is whether the written description reasonably conveys to the skilled artisan that the inventor was in possession of the claimed subject matter.

The issue of whether the written description requirement has been met is a question of fact, to be determined on a case-by-case basis. *Vas-Cath, Inc. v. Mahurkar*, 935 F.2d 1555, 1562 (Fed. Cir. 1991). The legal standard for determining whether the facts of a particular case meet the written description requirement is well established, however. In *Vas-Cath*, the Court of Appeals for the Federal Circuit (“CAFC”) held that “[t]he test for sufficiency of support in a patent application is whether the disclosure of the application relied on ‘*reasonably conveys* to the skilled artisan that the inventor had possession at that time of the later claimed subject matter.’” *Vas-Cath*, 935 F.2d at 1563 (emphasis added). As further held by the CAFC in *Union Oil Co. of Cal. v. Atlantic Richfield Co.*, 208 F.3d 989 (Fed. Cir. 2000), “[t]he written description does not require the applicant ‘to describe exactly the subject matter claimed, [instead] the description must clearly allow persons of ordinary skill in the art to recognize that [the inventor] invented what is claimed.’” *Id.* at 997. In other words, contrary to the Office’s assertions, the general standard does not require that the “only reasonable interpretation” of the general features in the specification be the more specific features in the claims. *Vas-Cath*, 935 F.2d at 1566 (“[t]he [district] court further erred in applying a legal standard that essentially required the drawings of the ‘081 design application to *necessarily exclude* all diameters other than those within the claimed range.”)(emphasis in original).

Because the written description requirement is fact-based, various decision makers have at times appeared to drift from the “reasonably conveys” standard mandated by the CAFC. The CAFC, however, has never wavered from this standard. For example, in *Hyatt v. Boone*, 146 F.3d 1348 (Fed. Cir. 1998) the court reviewed a Board of Patent Appeals and Interferences (“BPAI”) decision holding that one party to an interference (Hyatt) lacked the necessary written description in his originally filed application to support a later claim drawn to a count of the interference. The phraseology used by the BPAI in setting forth the standard for compliance with the written description requirement was that “the written description must be sufficient, when the entire specification is read that the ‘necessary and only reasonable construction’ that would be given it by a person of ordinary skill in the art is one that clearly supports each positive limitation in the count.” *Hyatt*, 146 F.3d at 1353. The appellant argued that the “necessary and only reasonable construction” standard applied by the BPAI was different from and more rigorous than the “reasonably conveys standard” set forth in *Vas-Cath*.

The CAFC determined that despite the arguably more rigorous phraseology used by the BPAI, the standard for meeting the written description requirement did not become more rigorous. Rather, the standard remains that “the written description must include all of the limitations...or the applicant must show that any absent text is *necessarily comprehended* in the description provided and would have been so understood at the time the patent application was filed.” *Hyatt*, at 1354-55 (emphasis added). Moreover, the CAFC has on subsequent occasions repeatedly reinforced that the standard of *Vas-Cath* remains in effect. *See, e.g., Pandrol USA, LP v. Airboss Ry. Prods, Inc.*, 424 F.3d 1161, 1165 (Fed. Cir. 2005) (“[t]he applicant must...convey with reasonable clarity to those skilled in the art that, as of the filing date sought, he or she was in possession of the invention.”)

In addition to *Hyatt*, the Office has cited *In re Robertson*, 169 F.3d 734 (Fed. Cir. 1999), and *Lockwood v. American Airlines, Inc.*, 107 F.3d 1565 (Fed. Cir. 1997), as establishing a strict inherency standard for finding written support for a claim element not having *ipsis verbis* support in the specification. In the first instance, the citation of *In Re Robertson* is inapposite. In *Robertson*, the CAFC reiterated the well-known standard for determining anticipation or obviousness of a claim by prior art where the prior art does not include literal disclosure of one or more elements of the claim. As such, *Robertson* was a case directed solely to Section 102/103 issues, and does not even mention Section 112. Moreover, nowhere in *Hyatt* or *Lockwood* does either court even allude to an inherency standard for showing support for claim limitations not described *ipsis verbis* in the specification. Rather, the CAFC simply held in *Lockwood* that “exact terms need not be used *in haec verba*..., the specification must contain an equivalent description of the claimed subject matter.” *Lockwood*, 107 F.3d at 1572 (citations omitted).

Therefore, the requirement of an inherency standard under Section 112 is unsupported by *Hyatt*, *Robertson*, or *Lockwood*. Rather, the proper standard to be applied by the Examiner in determining compliance with the written description requirement remains “whether the disclosure of the application as originally filed reasonably conveys to the artisan that the inventor had possession at that time of the later claimed subject matter, rather than the presence or absence of literal support in the specification for the claim language.” *In re Kaslow*, 707 F.2d 1366, 1375 (Fed. Cir. 1983).

ii) All Features of Claims 1 Through 6 In The ‘573 Patent Find Written Support In The Originally Filed Specification

Applying the proper standard for compliance with the written description requirement under Section 112, all of the limitations in Claims 1 through 6 of the ‘573 Patent are supported

by the originally filed specification. To illustrate this point, Appellant has prepared a detailed chart showing each feature of the invention, the claims in which those features are recited, and where support in the originally filed specification is found for each feature. That chart is set forth immediately below:

Feature	Claims Reciting Feature	Written Description of Feature in Original Specification	Comments
A method for transmitting a desired digital audio signal	1	p. 1, lns. 7-9 p. 2, lns. 8-10, 20-26	<i>ipsis verbis</i> support
stored on a first memory of a first party to a second memory of a second party	1, 4	p. 3, lns. 35-40 p. 4, lns. 12-26	The specification states <i>ipsis verbis</i> that the hard disk in the control unit of the authorized agent is the source of the digital signal. Further, the specification states that the digital signal is transferred to the hard disk in the control unit of the user. A skilled artisan would understand this as transferring signals stored on a first memory to a second memory.
transferring money via a telecommunications line to a first party location remote from the second memory	1, 4	p. 1, lns. 13-15 p. 2, lns. 8-10, 20-23, 47-50 p. 3, lns. 20-33 Fig. 1	The specification discloses electronic sales via telephone lines. Because the agent is authorized to sell and to transfer via telephone lines, there is implicit support for selling and thereby transferring money. This was previously pointed out in the declaration of Arthur Hair submitted May 5, 1992. A skilled artisan would readily understand this to comprehend transfers between two remote locations.
second party financially distinct from the first party	1, 4	p. 1, lns. 13-15 p. 2, lns. 8-10, 20-23, 47-50 p. 3, lns. 20-33	A skilled artisan would readily recognize that a sale requires the parties to be financially distinct. This was previously pointed out in the declaration of Arthur Hair submitted May 5, 1992.

second party controlling use and in possession of the second memory	1, 3	p. 3, lns. 26-33, 40-43	The as filed original specification includes <i>ipsis verbis</i> support for a second party control unit, where the user is the second party. A skilled artisan would readily recognize that the second memory is in possession and control of the second party, since the specification as originally filed states throughout that the user can store, sort and play thousands of songs from the user unit. A skilled artisan would clearly understand that this means the second party controls and possesses the second party control unit. This was previously pointed out in the declaration of Arthur Hair submitted May 5, 1992.
connecting electronically via a telecommunications line the first memory with the second memory	1, 4	p. 3, lns. 35-40	<i>ipsis verbis</i> support
transmitting the desired digital audio signal from the first memory with a transmitter in control and possession of the first party	1	p. 2, lns. 47-52 p. 3, lns. 35-40 Fig. 1	The as filed original specification has <i>ipsis verbis</i> support transmitting a desired digital audio signal and that the hard disk in the control unit of the authorized agent is the source. A skilled artisan would recognize that in order to regulate distribution of the signals the authorized agent would have to possess and control the transmitter. This was previously pointed out in the declaration of Arthur Hair submitted May 5, 1992.
to a receiver having the second memory at a location determined by the second party; said receiver in possession and control of the second party	1, 4	p. 2, lns. 47-50 p. 3, lns. 20-40 Fig. 1 p. 4, lns. 21-23	A skilled artisan would readily recognize in order to receive digital signals over telecommunications lines as disclosed throughout the specification, part of the second party control unit would act as a receiver. This was addressed

			previously in the affidavit of Arthur Hair dated May 5, 1992. A skilled artisan would also readily understand this to comprehend transfers between two remote locations. Since the second party possesses the second memory, the second party can determine its location. This was addressed previously in the declaration of Arthur Hair submitted May 5, 1992.
storing the digital audio signal in the second memory	1	p. 2, lns. 23-27	<i>ipsis verbis</i> support
searching the first memory for the desired digital audio signal	2	p. 3, lns. 35-40 p. 4, lns. 12-28	The as filed original specification has <i>ipsis verbis</i> support for electronic sales and electronic transfer of digital signals from a control unit of an authorized agent to a control unit of a user. A skilled artisan would readily recognize that this would include searching the hard disk of the first party to locate desired digital signals for purchase.
selecting the desired digital audio signal from the first memory	2	p. 3, lns. 35-40 p. 4, lns. 12-28	The as filed original specification has <i>ipsis verbis</i> support for electronic sales and electronic transfer of digital signals from a control unit of an authorized agent to a control unit of a user. A skilled artisan would readily recognize that this would include selecting desired digital signals from the hard disk of the first party for purchase.
telephoning the first party controlling use of the first memory by the second party	3, 6	p. 2, lns. 47-50 p. 3, lns. 20-40 Fig. 1 p. 4, lns. 21-23	The original as filed specification states throughout that digital audio or digital video signals are sold and transferred via telephone lines. A skilled artisan would readily recognize this as comprehending the

			telephoning of the first party by the second party to initiate a transaction. This was addressed previously in the declaration of Arthur Hair submitted May 5, 1992.
providing a credit card number of the second party to the first party so that the second party is charged money	3, 6	p. 1, lns. 13-15 p. 2, lns. 8-10, 20-23, 38-52 p. 3, lns. 12-15, 35-37	The original as filed specification states throughout that the invention provides for electronic sales of digital audio or digital video signals. A skilled artisan would readily recognize credit card sales as being comprehended within electronic sales. This was addressed previously in the affidavit of Arthur Hair dated May 5, 1992.
first party controlling the first memory	3, 6	p. 2, lns. 38-43 p. 3, lns. 35-49	The as filed original specification includes <i>ipsis verbis</i> support for a first party control unit, where the authorized agent is the first party. A skilled artisan would readily recognize that the first party control unit is in possession and control of the first party because as an "agent authorized to electronically sell and distribute" digital audio or digital video, the first party would necessarily have to possess and control the source of the digital audio and digital video. This was previously pointed out in the declaration of Arthur Hair submitted May 5, 1992.
A method for transmitting a desired digital video signal	4	p. 5, lns. 36-43	<i>ipsis verbis</i> support
transmitting the desired digital video signal from the first memory with a transmitter in control and possession of the first party	4	p. 5, lns. 36-43 p. 2, lns. 47-52 p. 3, lns. 35-40 Fig. 1	The as filed original specification has <i>ipsis verbis</i> support transmitting a desired digital audio signal and that the hard disk in the control unit of the authorized agent is the source. A skilled artisan

			would recognize that in order to regulate distribution of the signals the authorized agent would have to possess and control the transmitter. This was previously pointed out in the declaration of Arthur Hair submitted May 5, 1992. A skilled artisan would recognize based on the disclosure at the end of the specification that this procedure could also be used for digital video.
storing the digital video signal in the second memory	4	p. 5, lns. 36-43 p. 2, lns. 23-27	The as filed original specification has <i>ipsis verbis</i> support for storing digital signals on the hard disk of the user control unit. A skilled artisan would recognize based on the disclosure at the end of the specification that this procedure could also be used for digital video.
searching the first memory for the desired digital video signal	5	p. 3, lns. 35-40 p. 4, lns. 12-28 p. 5, lns. 36-43	The as filed original specification has <i>ipsis verbis</i> support for electronic sales and electronic transfer of digital signals from a control unit of an authorized agent to a control unit of a user. A skilled artisan would readily recognize that this would include searching the hard disk of the first party to locate desired digital signals for purchase. A skilled artisan would recognize based on the disclosure at the end of the specification that this procedure could also be used for digital video.
selecting the desired digital video signal from the first memory	5	p. 3, lns. 35-40 p. 4, lns. 12-28 p. 5, lns. 36-43	The as filed original specification has <i>ipsis verbis</i> support for electronic sales and electronic transfer of digital signals from a control unit of an authorized agent to a control unit of a user. A skilled artisan would readily

			recognize that this would include selecting desired digital signals from the hard disk of the first party for purchase. A skilled artisan would recognize based on the disclosure at the end of the specification that this procedure could also be used for digital video.
--	--	--	--

For all the reasons set forth in the chart immediately above, the written description standard was satisfied for Claims 1 through 6 of the '573 Patent. For the same reason, Claims 44 through 49 are also supported by the originally filed specification of the '497 Application.

To further support Appellant's position with respect to particular claim elements, Appellant submitted a Declaration under 37 C.F.R. § 1.132 of Dr. J. Douglas Tygar with the response to the March 17, 2007 Office Action ("Tygar Dec. 2007"). As set forth in the Declaration of Dr. Tygar, the claim language "transferring money electronically via a telecommunication line to a first party at a location remote from the second memory," "charging a fee," "providing a credit card number," and "charging an account," all would have been understood by one of ordinary skill in the art in the context of the described electronic sales and distribution of digital audio signals or digital video signals. *See* Tygar Dec. 2007, para. 6-9. In this context, one of ordinary skill in the art would have recognized that electronic sales encompassed transactions where a fee is charged, and thus money is transferred from one party to another electronically via a telecommunication line. *See* Tygar Dec. 2007, para. 8-9. It further would have been understood by one of ordinary skill in the art that electronic sales could be accomplished by providing a credit card number. *Id.* As a result, one of ordinary skill in the art in 1988 would have recognized that the description of

electronic sales in the specification of the '497 Application necessarily comprehends "transferring money to a first party from a second party electronically via telecommunication lines," "charging a fee," "charging an account," and "providing a credit card number."

As further set forth in the Declaration of Dr. Tygar, one of ordinary skill in the art in 1988 would have been aware of the available means for connecting computer systems to telecommunication lines for the purpose of transferring electronic signals; for example modems. *See* Tygar Dec. 2007, para. 11. Such means could be used at the originating (transmitting) computer and at the destination (receiving) computer. *Id.* The control unit or control integrated circuit of the copyright holder and user would have been recognized by one of ordinary skill in the art as being some type of computer system or part of a computer system. *Id.* Therefore, the terms in the claims "transmitter" and "receiver" describe what would have been understood by one of ordinary skill in the art as being necessarily comprehended by the description provided in the specification and figures filed with the '497 Application.

Finally, as also set forth in the Declaration of Dr. Tygar, it easily would have been recognized by one of ordinary skill in the art in 1988 that the specification's teaching requires establishing some type of connectivity as a pre-requisite to making a purchase/sale of digital signals, as well as for transferring the digital signals. *See* Tygar Dec. 2007, para. 13-14. Since the specification of the '497 Application explicitly discloses selling and transferring digital audio signals (or digital video signals) over telephone lines, it is clear that the step of requesting and establishing connectivity (telephoning) is necessarily comprehended in the description provided in the '497 Application, since the step would have been recognized as a prerequisite for performing the function of the disclosed system. *Id.*

For all of the above reasons, Claims 1 through 6 and 44 through 49 find adequate written support in the specification of the '497 Application as filed and are therefore entitled to the June 13, 1988 priority date. For this reason as well, the Board should vacate the Examiner's findings with respect to the priority date of the '573 Patent.

2. The "Video Feature" of the Invention in Claims 4 Through 6 Of The '573 Patent Was Enabled By The Originally Filed Specification

The Office asserts the "video feature" of the invention in Claims 4 through 6 was not enabled by the disclosure in the originally filed specification.

The Office acknowledges the "original specification does contain a general statement at the end of the specification stating '[f]urther, it is intended that this invention not be limited to Digital Audio Music and can include Digital Video....'" The Office, however, generally asserts "this broad, generic statement fails to enable specifically claimed video download and processing procedures." September 29, 2006 Office Action, page 12. Since the Office has not specifically identified which portions of the claims allegedly are not enabled, Appellant will discuss below the issue of enablement with respect to particular comments made in the September 29, 2006 Office Action.

i) The Office Is Attempting To Apply An Improper Standard For Enablement

The Office is attempting to apply a "mass production" standard to the claims when, in actuality, the enablement standard of Section 112 has no such requirement. As the CAFC held in *Christianson v. Colt Indus. Operating Corp.*, 822 F.2d 1544, 1562 (Fed. Cir. 1987), "the law has never required that [an Appellant]... must disclose in its patent the dimensions, tolerances, drawings, and other parameters of mass production not necessary to enable one skilled in the art to practice (as distinguished from mass-produce) the invention." Nonetheless, it appears this

kind of “mass production” information is exactly the kind of information the Office now seeks. For example, the Office Action states “[p]ersonal user devices with the processing power capable of playing back much larger and more complicated digital video files, such as DVD players, were not routinely available until the late 1990(s).” September 29, 2006 Office Action, pages 19-20. (emphasis added.) Whether such devices “routinely” were available is not part of the test for enablement, nor is it one of the eight factors for reasonable experimentation that were laid out by the CAFC in *In re Wands*, 858 F.2d 731 (Fed. Cir. 1988). Rather, the only relevant test is whether, without undue experimentation, one of ordinary skill in the art could have made and used the claimed invention.

As further evidence that the Office seeks to apply a “mass production” standard, it is noted that the Office Action states “the digital bandwidth required to transmit a video signal at even VHS quality was around 1.5 megabits per second (approximately 30 megabytes in 3 minutes).” Office Action, page 14. (emphasis added.) However, while VHS quality may be appropriate for “mass production,” a limitation requiring VHS quality video is not included in any of the claims, and thus it is impermissible for the Office to use that level of quality as a benchmark for enablement. In fact, the recent success of very small screen video players shows that “mass production” can be achieved with even less than VHS quality.

Even if VHS quality were a requirement for enablement of the claims, there is no articulated basis to believe the original specification would not have enabled one of ordinary skill in the art to meet that quality for a short period of time. This fact is accentuated by the statement in the Office Action that “it is not clear ... how downloaded files of any appreciable or viable size would have been downloaded and stored on originally disclosed hard disk 60 of the user in the original specification.” September 29, 2006 Office Action, page 20. (emphasis

added.) The use of “appreciable” and “viable” makes it clear that short videos are enabled, and nothing more is required. Further, the Office appears to acknowledge that even a 30-megabyte hard drive could store a three-minute movie if encoded at 1.5 megabits/second. *Id.* That alone is sufficient to meet the enablement requirement.

Moreover, the Office impermissibly limits the scope of what it referenced when the Office Action cites the size of available hard drives. While a 30-megabyte hard drive would have been available in a 3.5-inch form factor, the same chart relied on by the Office illustrates that hard drives larger than 1.89 gigabytes were available at the same time. *See* September 29, 2006 Office Action, footnote 14.

Furthermore, the Office has applied the same “mass production” requirement to the library server. The Office initially seems to acknowledge that mainframes did exist which could have operated as repositories for copyrighted materials using hard disk drives. However, the Office then seems to discount the relevance of the existing mainframes by stating “it is not clear how even a small-sized video library ... would have been stored in the hard disk of the copyright holder ... without requiring details directed to a complex mainframe operating environment.” This unsupported statement on “complexity” is insufficient to prove that mainframe operating environments capable of storing digital video files were not already known at the time the original specification was filed, or that undue experimentation would have been required to store digital video files in such an environment. The statement also leaves unanswered how the Office is defining “small” -- according to the enablement standard under Section 112 or the improper “mass production” standard?

The Office Action further states “[r]egarding the transfer of these large video files over a network, the proliferation of broadband communication network[s] capable of delivering these

large files to consumers, such as the Internet, simply did not exist or were not well known in 1988.” September 29, 2006 Office Action, pages 14-15. (emphasis added.) Such a statement raises at least two issues. First, “not well known” to whom? Those of ordinary skill in the art of computer systems knew of telephony-based wide area networks at the time the original specification was filed. See <http://www.rfc-editor.org/rfc-index.html> for a list of computer communications standards including those available at the time of filing. Second, utilization of a “broadband” network is not required. In fact, the originally filed specification discloses that the audio and video files can be transferred over telephone lines. While this may not be an extremely fast method of transfer, it nonetheless clearly is enabling under Section 112.

The Office further questions “how the digital video would have been coded and decoded during transmission, as digital video coding standards for purposes of transmission and file download were not settled in 1988. [T]he MPEG-1 standard which was designed to code/decode digital video information and to transmit the video via a telephone (telecommunications) network in NTSC (broadcast) quality for archiving, was only established in 1992.” September 29, 2006 Office Action, page 21. (emphasis added.) Again, standardization of video coding and the use of “NTSC quality” relate to “mass production” rather than enablement under Section 112. Thus, the Office has not alleged -- and cannot allege -- that one of ordinary skill in the art could not have coded video at some other resolution or using some other encoding technique at the time the original specification was filed.

In contrast, those of ordinary skill in the art would have been able to code and decode video data transmitted over a telephone line without undue experimentation. This is because there were existing video teleconferencing systems known and available to them prior to applicant’s earliest priority date. In response to the March 17, 2007 Office Action, the

Appellant submitted the reference “The Design of Picturephone® Meeting Service (PMS) Conference Centers For Video Teleconferencing”, Bernard A. Wright, *IEEE Communications Magazine*, © 1983 (hereinafter *Wright*). In the paragraph crossing the left and right columns of page 30 of *Wright*, the article describes that five years before applicant’s earliest priority date a digital video signal could have been (and was) sent via a telephone network and decoded with a picture processor in real-time. In fact, on page 36, *Wright* states:

The Bell System has developed a complete capability for full motion video teleconferencing, and as of July 2, 1982 is providing such a service. This high quality PMS service provides the user with an excellent full-motion, two-way fully interactive conferencing capability.

Similarly, in the section of page 35 entitled “Picture Processor,” *Wright* discloses that not only was a TV processor for video processing available from Nippon Electric Corporation for use in the described video processing system, but a network interface specification was available for making systems that were compatible with the Bell System. (See reference [3].) It further states that “In the receive direction, a decoder accepts the two DS-1 signals as inputs, corrects errors, and recovers audio, video, and control information by performing the inverse of the encoding operations.” (Emphasis added.) As such, contrary to the position of the Office Action, it is clear that at the time of filing of the earliest priority application, one of ordinary skill in the art would have been able to transmit, download and decode video signals as claimed by using, for example, the digital video format of the PicturePhone system described in *Wright*, without undue experimentation.

Accordingly, Claims 4 through 6 and Claims 47 through 49 directed to the “video feature” embodiment of the invention are enabled by the originally filed specification under the proper standard for Section 112 enablement.

D. Because Claims 1 Through 6 And 44 Through 49 Are Entitled To The June 13, 1988 Priority Date Awarded During the Original Examination, *Cohen* Is Not Appropriate Prior Art

Based on the foregoing, Claims 1 through 6 and 44 through 49 in reexamination are entitled to the June 13, 1988 priority date. In the first instance, it is improper for the Office to reconsider the issue of priority in the present reexamination for the reasons set forth in Sections III(A) and (B) above. Further, even if it were proper to reconsider the issue of priority, the facts of record clearly show the claims were described adequately and enabled by the originally filed specification for the reasons set forth in Section III(C) above. Therefore, U.S. Patent 4,949,187 to Cohen (*Cohen*) cannot be a proper basis for a rejection because the reference post-dates the applicable June 13, 1988 priority date for the claims. The Board should, therefore, reverse all rejections based on *Cohen*. *See supra*, Grounds 1-3 under the Grounds for Rejection to be Reviewed on Appeal.

IV. THE CLAIMS AS AMENDED ARE SUPPORTED AND ENABLED BY THE WRITTEN DESCRIPTION

In addition to questioning the written support and enablement of Claims 1 through 6 in the originally filed specification, the Office has also asserted separate rejections of Claims 1 through 6 as amended and new Claims 44 through 49 under 35 U.S.C. § 112, first paragraph. In making these rejections, the Office has improperly applied Section 112 analysis to claim elements that existed in the claims as issued, rather than limiting the analysis to “matter added or deleted” as required by 37 C.F.R. § 1.552. As detailed herein, Claims 1 through 6 and 44 through 49 are fully supported and enabled by the specification of the ‘573 Patent.

A. Rejection Of Claims 44 Through 49 Under 35 U.S.C. § 112, First Paragraph

Claims 44 through 49 have been rejected under Section 112, first paragraph, as introducing matter not described in the original specification. Claims 47 through 49 additionally have been rejected as not being enabled by the original specification.

As a preliminary matter, 37 C.F.R. § 1.552(a) states that an analysis under Section 112 will be performed with respect to *matter* added or deleted, not *claims* added or deleted. The restatement of matter already presented in Claims 1 through 6 in the form of Claims 44 through 49 does not add *matter* to the claims. MPEP § 2163.I states that issues under Section 112 “*most typically... arise in the context of...new or amended claims.*” (emphasis added.) This statement does not empower the Office to assert Section 112, first paragraph, rejections every time previously claimed matter is presented in the form of a different claim.

The only element present in Claims 44 through 49 that was not previously present in Claims 1 through 6 is the recitation of a hard disk. Therefore, the Office may only examine the recitation of “hard disk” for compliance with Section 112, first paragraph. A review of the originally filed specification demonstrates this recitation is fully supported and enabled by the originally filed specification. *See* Original Specification, p. 3, ln. 30.

Nonetheless, even if it were proper for the Office to examine Claims 44 through 49 in their entirety for compliance with Section 112, first paragraph, under 37 C.F.R. § 1.552(a), those issues were already addressed by Examiner Nguyen during the initial examination of Claims 1 through 6, as set forth above.

Further, as demonstrated by the Appellant in Section III above, each element of Claims 44 through 49 is fully supported and enabled by the specification of the ‘497 Application as

originally filed. Therefore, the Board should reverse the rejections of Claims 44 through 49 under 35 U.S.C. § 112, first paragraph.

B. Rejection Of Claims 1 Through 6 Under 35 U.S.C. § 112, First Paragraph

Claims 1 through 6 have been rejected under Section 112, first paragraph, as introducing matter not described in the original specification. Claims 4 through 6 additionally have been rejected as not being enabled by the original specification.

The Office asserts that the negative limitation of “a non-volatile storage portion of the second memory, wherein the non-volatile storage is not a tape or a CD”, introduces a new concept to the claims that does not have a basis in the originally filed specification. The Office cites two cases from the BPAI, one case from the CAFC, and one case from the Court of Customs and Patent Appeals (“C.C.P.A.”) to support this rejection. None of the cases support the rejection.

The CAFC case cited by the Office, *Lizardtech, Inc. v. Earth Res. Mapping, Inc.*, 433 F.3d 1373 (Fed. Cir. 2006), is merely an opinion denying a petition for rehearing *en banc*. The case does not address anything related to the current rejection. Therefore, the case simply does not support the Office’s position.

The two cases from the BPAI, *Ex Parte Wong*, No. 2004-1144, 2004 WL 4981845 (Bd. Pat. App. & Interf. June 10, 2004) and *Ex Parte Grasselli*, 231 U.S.P.Q. 393 (Bd. Pat. App. & Interf. 1983), address situations where a negative limitation added to a claim was not described in the specification of the application. However, neither *Wong* nor *Grasselli* support the rejection of Claims 1 through 6 under Section 112, first paragraph, in the instant case. In both *Wong* and *Grasselli*, the issue and ultimate ground for rejection was that a negative limitation added to the claims introduced a new concept not disclosed in the respective specifications in

those cases. That simply is not the situation here. Both Claims 1 and 4 recite a non-volatile storage portion of a memory that is not a tape or CD. The originally filed specification of the '497 Application explicitly states that the disclosed invention eliminates the need to handle tapes and CDs. See p. 2, lns. 23 to 26. Thus, the concept of storing digital audio or digital video signals on a memory that is not a tape or CD is explicitly disclosed by the original specification. Therefore, *Wong* and *Grasselli* are inapposite to the present case.

The case from the C.C.P.A., *Application of Johnson*, 558 F.2d 1008 (C.C.P.A. 1977), concerns a situation where the applicant sought to claim priority to an originally filed application for claims in a subsequent continuation-in-part application. The holding of *Johnson* also fails to support the Office's position. In *Johnson*, an original parent application disclosed and claimed a genus of polymer compositions comprising various monomer units. In a later filed CIP application, the broad genus claims in the parent application were narrowed by expressly excluding certain species from the polymer compositions. The parent application only contained a description of the broader genus. The court found that claims to the narrower sub-genus created by the express exclusion of certain species in the CIP were not supported by the description of the broader genus in the parent specification. Again, the situation with the present reexamination differs significantly from the cited case law. Claims 1 and 4 recite a non-volatile storage portion of a memory that is not a tape or CD. This is exactly what is described at page 2, lines 23 to 26 of the originally filed specification. In short, the negative limitation recited in Claims 1 and 4 is expressly disclosed in the specification of the parent application. Thus, in the instant case, the scope of the disclosure in the specification was never narrowed with respect to this element, contrary to the situation in *Johnson*. Therefore, the recitation of a

non-volatile storage portion of a memory that is not a tape or CD is fully supported by the originally filed specification, as well as the specification of the '573 Patent as issued.

With respect to the other elements recited in Claims 1 through 6, the issue of written support for the claimed matter previously was addressed by Examiner Nguyen during the initial examination of Claims 1 through 6, as recognized by the Office in the Office Action dated March 17, 2007. Moreover, Appellant has thoroughly demonstrated in Sections III(C)(1)(ii) and III(C)(2) above that each element in Claims 1 through 6 is fully supported and enabled by the original specification as filed, as well as the specification for '573 Patent as issued.

Therefore, the Board should reverse the Examiner's rejections of Claims 1 through 6 under 35 U.S.C. § 112, first paragraph.

V. BASED ON THE PROPER PRIORITY DATE FOR THE CLAIMS IN REEXAMINATION, THE REJECTIONS OF CLAIMS 1 THROUGH 6 AND 44 THROUGH 49 BASED ON *COHEN* ARE IMPROPER

As set forth above, the proper priority for Claims 1 through 6 and 44 through 49 in reexamination is June 13, 1988. Therefore, any rejections under Sections 102 or 103 which rely on references that are not prior art based on the June 13, 1988 priority date are improper and should be reversed. U.S. Patent 4,949,187 to Cohen (*Cohen*) issued on August 14, 1990 from an application filed on December 16, 1988. Therefore, *Cohen* does not qualify as prior art for the purposes of Sections 102 and 103.

A. Rejection Of Claims 1, 2, 4, 5, 44, 45, 47 And 48 Under 35 U.S.C. § 102(e) As Anticipated By *Cohen*

Claims 1, 2, 4, 5, 44, 45, 47 and 48 have been rejected under 35 U.S.C. § 102(e) as anticipated by *Cohen*. Because *Cohen* is not available as prior art based on the proper priority date of June 13, 1988 for the '573 Patent, the instant rejection is improper. Therefore, the Board should reverse this rejection.

B. Rejection Of Claims 1 Through 6 and 44 Through 49 Under 35 U.S.C. § 103(a) Over *Bush* In View Of *Cohen*

Claims 1 through 6 and 44 through 49 have been rejected under 35 U.S.C. § 103(a) as obvious over the combination of U.S. Patent 4,789,863 to Bush (*Bush*) in view of *Cohen*. Because *Cohen* does not qualify as prior art based on the proper June 13, 1988 priority date of the '573 Patent, a combination of *Cohen* and another reference cannot provide a proper basis for an obviousness rejection. As a result, the rejection of Claims 1 through 6 and 44 through 49 based on a combination of *Bush* and *Cohen* is improper. Therefore, the Board should reverse this rejection.

C. Rejection Of Claims 3, 6, 46 and 49 Under 35 U.S.C. § 103 (a) Over *Cohen* In View Of *Bush*

Claims 3, 6, 46 and 49 have been rejected under 35 U.S.C. § 103(a) over *Cohen* in view of *Bush*. Because *Cohen* does not qualify as prior art based on the proper June 13, 1988 priority date of the '573 Patent, a combination of *Cohen* and another reference cannot provide a proper basis for an obviousness rejection. As a result, the rejection of Claims 3, 6, 46 and 49 based on a combination of *Bush* and *Cohen* is improper. Therefore, the Board should reverse this rejection.

VI. CLAIMS 1 THROUGH 6 AND 44 THROUGH 49 ARE PATENTABLE OVER THE REFERENCES OF RECORD THAT ARE PROPER PRIOR ART

The Office has also presented rejections under 35 U.S.C. § 103(a) that are based on references that qualify as prior art based on the June 13, 1988 priority date for the claims in reexamination. However, the Office has not established a *prima facie* case of obviousness of any of Claims 1 through 6 or 44 through 49 based on these references.

A. Rejection Of Claims 1 Through 6 And 44 Through 49 Under 35 U.S.C. § 103(a) Over *Bush* In View Of *Freeny I*

Claims 1 through 6 and 44 through 49 have been rejected under 35 U.S.C. § 103(a) as obvious over the combination of *Bush* in view of U.S. Patent 4,837,797 to Freeny (*Freeny I*).

The Office admits that *Bush* does not disclose storing digital audio signals or digital video signals in a non-volatile storage portion of a second memory that is not a tape or a CD as recited in Claims 1 and 4. As further admitted by the Office, *Bush* does not disclose storing digital audio signals or digital video signals in a second party hard disk as recited in Claims 44 and 49.

Freeny I discloses a message controller for receiving voice messages and machine readable messages over telephone lines. The apparatus of *Freeny I* is capable of differentiating between voice messages and machine readable messages received over standard telephone equipment, *i.e.* a telephone. When the apparatus of *Freeny I* determines that a received call is a voice message, it causes the user's telephone to ring, thereby alerting the user. When the apparatus of *Freeny I* determines that a received call is a machine readable message, it converts the message to human readable form using a standard printer or display unit. One embodiment of the apparatus of *Freeny I* indicates it is capable of receiving machine readable messages and storing them on a storage medium that may be a memory chip or hard disk.

However, *Freeny I* does not discuss transmission of digital audio or digital video signals from a first memory to a second memory, let alone the sale of such digital video or digital audio signals. Thus, *Freeny I* bears no relation to the disclosure of *Bush* or the invention recited in Claims 1 through 6 and 44 through 49. The Office apparently has recognized this deficiency in *Freeny I*, because the Office must cite to *Cohen* to show motivation to combine *Bush* and *Freeny I*. However, as set forth above, *Cohen* is not available as prior art based on the priority date of June 13, 1988 for the '573 Patent.

The Supreme Court's recent holding in *KSR Int'L Co. v. Teleflex Inc.*, 127 S. Ct. 1727 (U.S. 2007), does not relieve the Office of the obligation to show motivation to combine two separate references in making out a *prima facie* case of obviousness. Quite to the contrary, the Supreme Court stated: "[t]o determine whether there was an apparent reason to combine the known elements in the way a patent claims, it will often be necessary to look to interrelated teachings of multiple patents; to the effects of demands known to the design community or present in the marketplace; and to the background knowledge possessed by a person having ordinary skill in the art. *To facilitate review, this analysis should be made explicit.*" *KSR*, 127 S. Ct. at 1731 (emphasis added).

Since the Office has not shown any motivation to combine *Bush* and *Freeny I*, a *prima facie* case of obviousness has not been established. Therefore, the Board should reverse this rejection.

**B. Rejection Of Claims 1 Through 6 And 44 Through 49 Under 35 U.S.C. § 103(a)
Over *Akashi* In View Of *Freeny II***

Claims 1 through 6 and 44 through 49 have been rejected over Japanese Patent Application No. 62-284496 (*Akashi*) in view of U.S. Patent 4,528,643 to Freeny (*Freeny II*). Such a rejection is unfounded. First, the combination of *Akashi* and *Freeny II* would not reach the presently claimed invention. Second, there is no motivation to combine *Akashi* and *Freeny II*.

The Office asserts that *Akashi* shows a system for transmitting recorded music from a host computer that stores recorded music data to a personal computer. The Office then asserts that *Akashi* “does not expressly detail...whether the data is stored on a non-volatile portion of a second memory that is not a tape or CD.” This is incorrect. *Akashi* explicitly discloses a record reproducing device that is a compact disk deck or a digital audio tape recorder. See *Akashi* Translation, p. 2 (Embodiment). In other words, *Akashi* is not ambiguous at all on this point. Thus, not only does *Akashi* fail to disclose transmitting digital audio signals or digital video signals from a first memory to a second memory and storing the digital audio signals or digital video signals in a non-volatile portion of the second memory that is not a tape or CD, *Akashi* expressly teaches away by specifically disclosing and requiring a tape recorder or CD deck.

The Office asserts the deficiencies of *Akashi* are cured by *Freeny II*. Specifically, the Office asserts that *Freeny II* discloses transmitting digital audio signals or digital video signals from a first memory in control and possession of a first party to a second memory in control and possession of a second party, and storing the digital audio signals or digital video signals in a non-volatile storage that is not a tape or CD. The Office further asserts it would have been obvious to implement the non-volatile storage of *Freeny II* in the system of *Akashi* because “[t]he use of a hard disk would have allowed the user to more efficiently access audio and video

files.” The Office bases its position on the conclusion that “a hard-disk, would have also increased the security and reliability of the stored data.”

For several reasons, it would not have been obvious to combine the teachings of *Akashi* and *Freeny II* to arrive at the invention recited in Claims 1 through 6 and 44 through 49. First, *Freeny II* discloses a kiosk-type system for producing “material objects” at a point of sale location where it is the “material object” that is sold to consumers. *Freeny II*, Abstract. Thus, like *Akashi*, *Freeny II* expressly teaches away from storing digital audio signals or digital video signals on a non-volatile storage portion of a second memory that is not a tape or CD in possession and control of a second party. Further, in *Freeny II*, the second memory (information manufacturing machine) for storing the information that is transformed into material objects is in possession and control of the first party. The first party controls access to the information on the second memory by requiring a fee to be paid for the consumer (second party) to access the information stored on the second memory. After the fee is paid, the second party has limited access to the specific information requested for the purpose of making a copy in the form of a material object. In the case of audio or video information, the material object would be in the form of a tape or CD. Therefore, again, both *Akashi* and *Freeny II* contemplate and require supplying audio information to the consumer in the form of a tape or CD. Thus, like *Akashi*, *Freeny II* expressly teaches away from storing digital audio signals or digital video signals on non-volatile storage portion of a second memory that is not a tape or CD in possession and control of a second party.

Additionally, in *Freeny II*, the necessary material object containing the digital audio or digital video signals is produced by accessing information stored on the second memory. The first memory (information control machine) simply supplies reproduction authorization codes in

response to a request for reproduction from the information manufacturing machine. The second party never has access to the first memory, as recited in present Claims 2, 5, 45 and 48.

Both *Akashi* and *Freeny II* solve the same problem: providing audio information, and video information in the case of *Freeny II*, to a consumer in the form of a material object, such as a tape or CD. *Akashi* and *Freeny II* solve this common problem in different and unrelated ways. Nonetheless, neither of the references teaches or discloses the benefits of transmitting digital audio signals or digital video signals from a first memory to a second memory and storing those digital audio signals or digital video signals in a non-volatile portion of the second memory that is not a tape or CD, which is in possession and control of a consumer, *i.e.* a second, financially distinct, party. Therefore, the combination of *Akashi* and *Freeny II* does not teach or suggest every limitation of Claims 1 through 6 or 44 through 49. In fact, because both *Akashi* and *Freeny II* expressly require storing digital audio signals or digital video signals on a tape or CD, they teach away from the invention recited in Claims 1 through 6 and 44 through 49. “[W]hen the prior art teaches away from combining certain known elements, discovery of a successful means of combining them is more likely to be nonobvious.” *KSR*, 127 S. Ct. at 1740. As a result, these references cannot be combined to render Claims 1 through 6 obvious.

Even if the combination of *Akashi* and *Freeny II* did teach each and every element of Claims 1 through 6 or 44 through 49 – which they do not – the motivations cited by the Office for combining and/or modifying *Akashi* and *Freeny II* are not found in those references. Moreover, the Office has not cited to any other references or knowledge available to one of ordinary skill in the art in 1988 that would have motivated a skilled artisan to combine and/or modify *Akashi* and *Freeny II* as suggested by the Office. Rather, the Office simply has made vague statements that the security and reliability of hard disks would have been well known at

the time. Such general allegations are insufficient to show motivation to combine these references, particularly since neither one of them even hints at such a modified combination. Again, as the Supreme Court has just admonished: “[a] patent composed of several elements is not proved obvious merely by demonstrating that each element was, independently, known in the prior art.” *KSR*, 127 S. Ct. at 1731.

Based on all of the foregoing, the Office has not established a *prima facie* case of obviousness of Claims 1 through 6 and 44 through 49 over the combination of *Akashi* and *Freeny II*. Therefore, the Board should reverse this rejection.

C. The Secondary Considerations Of Non-Obviousness Support The Finding Of Non-Obviousness Of Claims 1 Through 6 And 44 Through 49

Although a showing of secondary considerations is not strictly necessary to establish the non-obviousness of Appellant’s invention, such secondary considerations in fact do exist.

The CAFC has explicitly set forth the factors, such as commercial success, long felt but unresolved needs, skepticism by experts, and copying by competitors that can be used to establish non-obviousness. *Brown & Williamson Tobacco Corp. v. Philip Morris Inc.*, 229 F.3d 1120, 1129 (Fed. Cir. 2000). The CAFC has held that a nexus must be established between the merits of a claimed invention and the evidence of non-obviousness offered if that evidence is to be given substantial weight enroute to a conclusion of non-obviousness. *Ex parte Remark*, 15 U.S.P.Q.2d 1498, 1502 (Bd. Pat. App. & Interfer. 1990). The CAFC has also held, however, that copying of a patented feature or features of an invention, while other unpatented features are not copied, gives rise to an inference that there is a nexus between the patented feature and the commercial success. *Hughes Tool Co. v. Dresser Industries, Inc.*, 816 F.2d 1549, 1556 (Fed. Cir. 1987). Moreover, it is well established that copying of a patented invention, rather

than one within the public domain, is by itself indicative of non-obviousness. *See Windsurfing Int'l Inc., v. AMF, Inc.*, 782 F.2d 995, 1000 (Fed. Cir. 1986).

The invention recited in Claims 1-6 (and Claims 44-49) generally comprises transferring “for pay” digital video or digital audio signals between a first memory controlled by a seller and a second memory at a remote location controlled by a buyer over a telecommunication line. The invention has in the past achieved significant commercial success. *See, e.g.*, Declaration of Arthur R. Hair submitted with Appellant’s Response dated December 27, 2005.

Moreover, the invention continues to achieve commercial success in that it has been copied by a major participant in the field. The features of the invention generally included in Claims 1-6 (and Claims 44-49) have been copied by at least one commercially successful system available today: Napster Light. The Napster Light system (“Napster”) for purchasing digital music files online at www.napster.com is a commercially successful system that embodies the features of the claimed invention. The Declaration of Justin Douglas Tygar, Ph.D. (“Tygar Dec. 2005”), a copy of which is filed herewith, supports the assertion that Napster is commercially successful and has copied the claimed invention.

Dr. Tygar determined that Napster has achieved a level of commercial success. *See* Tygar Dec. 2005, para. 6. Further, Dr. Tygar compared Napster to the invention recited in Claims 1-6 and determined Napster copied the invention. Specifically, Dr. Tygar found that Napster operates a music download system incorporating servers having hard disks and memory, through which it sells digital music files to a buyer for download over the Internet. *See* Tygar Dec. 2005, para. 10. The buyer using Napster has a computer at a home, office, or other location remote from Napster. *See* Tygar Dec. 2005, para. 11. The buyer forms a connection between his or her computer and Napster via the Internet, selects digital music

file(s) he or she wishes to purchase, provides a credit card number, and receives the music file via a download process where the file is transferred from Napster's server to the buyer's computer and stored on the hard drive. The buyer can then play the file using his or her computer system. *See* Tygar Dec. 2005, paras. 12-16. In view of this comparison, Dr. Tygar properly concludes that Napster has copied the features taught by the present invention. *See* Tygar Dec. 2005, para. 19.

Additionally, Napster *does not* copy the alleged closest prior art cited by the Examiner, *i.e.*, *Freeny* and *Akashi*. *Freeny* teaches a point-of-sale device (e.g., a kiosk) that dispenses a material object (e.g., tape) containing the music purchased. *See Freeny*, col. 1, line 64 to col. 2, line 12. These features of *Freeny* are plainly not found in Napster. *See* Tygar Dec. 2005, para. 16. *Akashi* teaches writing data to a digital audio tape recorder or a compact disk deck that employs a write-once, read-many times recordable optical disk which allows data to be read immediately after the data is written. The user downloads data to a RAM and then the data is written directly from the RAM to a recordable optical disk. *See Akashi* para. 6. This process of *Akashi* is not how Napster operates. *See* Tygar Dec. 2005, para. 18.

Therefore, it is apparent that Napster chose to copy the system taught by the '573 patent. *See* Tygar Dec. 2005, para. 19. It is also apparent that Napster chose *not* to copy the prior art systems of *Freeny* and *Akashi*. *See* Tygar Dec. 2005, para. 20 and 21. This selective copying by Napster of the invention recited in Claims 1-6 (and Claims 44-49), while Napster ignored the systems of *Freeny* and *Akashi*, provides a sound basis upon which the required nexus between commercial success and Appellant's claimed invention can be found. *See Hughes Tool*, 816 F.2d at 1556. Additionally, Napster's selective copying of Appellant's invention, coupled with Napster's disregard of the *Freeny* and *Akashi* systems, is itself substantive evidence of a

recognized secondary indication of non-obviousness. See *Windsurfing International Inc.*, 782 F.2d 995 (Fed. Cir. 1986).

The foregoing remarks and the Declaration of Dr. Tygar establish the requisite nexus between the commercial success of Napster and Appellant's claimed invention. These remarks and the Declaration of Dr. Tygar similarly have established copying by Napster as a secondary indicia of non-obviousness.

Conclusion

Based on the foregoing, the Board should reverse the rejections of Claims 1 through 6 and 44 through 49 under 35 U.S.C. §§ 102(e) and 103(a). Also based on the foregoing, the Board should reverse the rejection of Claims 1 through 6 and 44 through 49 under 35 U.S.C. § 112, first paragraph.

Respectfully submitted,

Robert A. Koons, Jr., Esq.
Attorney for Appellants
Reg. No. 32,474

Drinker Biddle & Reath LLP
One Logan Square
18th and Cherry Streets
Philadelphia, PA 19103-6996
Telephone (215) 988-3392
Facsimile (215) 988-2757
Date: July 30, 2007

CLAIMS APPENDIX

1.(Amended) A method for transmitting a desired digital audio signal stored on a first memory of a first party to a second memory of a second party comprising the steps of: transferring money electronically via a telecommunication line to the first party at a location remote from the second memory and controlling use of the first memory from the second party financially distinct from the first party, said second party controlling use and in possession of the second memory; connecting electronically via a telecommunications line the first memory with the second memory such that the desired digital audio signal can pass there-between; transmitting the desired digital audio signal from the first memory with a transmitter in control and possession of the first party to a receiver having the second memory at a location determined by the second party, said receiver in possession and control of the second party; and storing the digital signal in a non-volatile storage portion of the second memory, wherein the non-volatile storage portion is not a tape or CD.

2.(Original) A method as described in claim 1 including after the transferring step, the steps of searching the first memory for the desired digital audio signal; and selecting the desired digital audio signal from the first memory.

3.(Original) A method as described in claim 2 wherein the transferring step includes the steps of telephoning the first party controlling use of the first memory by the second party; providing a credit card number of the second party controlling the second

memory to the first party controlling the first memory so the second party is charged money.

4.(Amended) A method for transmitting a desired digital video signal stored on a first memory of a first party to a second memory of a second party comprising the steps of: transferring money electronically via a telecommunications line to the first party at a location remote from the second memory and controlling use of the first memory, from a second party financially distinct from the first party, said second party in control and in possession of the second memory; connecting electronically via a telecommunications line the first memory with the second memory such that the desired digital video signal can pass there-between; transmitting the desired digital video signal from the first memory with a transmitter in control and possession of the first party to a receiver having the second memory at a location determined by the second party, said receiver in possession and control of the second party; and storing the digital signal in a non-volatile storage portion of the second memory, wherein the non-volatile storage portion is not a tape or a CD.

5.(Original) A method as described in claim 4 including after the transferring money step, the step of searching the first memory for the desired digital signal and selecting the desired digital signal from the first memory.

6.(Original) A method as described in claim 5 wherein the transferring step includes the steps of telephoning the first party controlling use of the first memory by the second party controlling the second memory; providing a credit card number of the second party controlling the second memory to the first party controlling the first memory so the second party controlling the second memory is charged money.

7-43 (Canceled)

44.(New) A method for transmitting a desired digital audio signal stored on a first memory of a first party to a second memory of a second party comprising the steps of:

transferring money electronically via a telecommunications line to the first party at a location remote from the second memory and controlling use of the first memory from the second party financially distinct from the first party, said second party controlling use and in possession of the second memory;

the second memory including a second party hard disk;

connecting electronically via a telecommunications line the first memory with the second memory such that the desired digital audio signal can pass therebetween;

transmitting the desired digital audio signal from the first memory with a transmitter in control and possession of the first party to a receiver having the second memory at a location determined by the second party, said receiver in possession and control of the second party;

and storing the digital signal in the second party hard disk.

45.(New) A method as described in claim 44 including after the transferring step, the steps of searching the first memory for the desired digital audio signal; and selecting the desired digital audio signal from the first memory.

46.(New) A method as described in claim 45 wherein the transferring step includes the steps of telephoning the first party controlling use of the first memory by the second party; providing a credit card number of the second party controlling the second memory to the first party controlling the first memory so the second party is charged money.

47.(New) A method for transmitting a desired digital video signal stored on a first memory of a first party to a second memory of a second party comprising the steps of:

transferring money electronically via a telecommunications line to the first party at a location remote from the second memory and controlling use of the first memory from the second party financially distinct from the first party, said second party controlling use and in possession of the second memory;

the second memory including a second party hard disk;

connecting electronically via a telecommunications line the first memory with the second memory such that the desired digital video signal can pass therebetween;

transmitting the desired digital video signal from the first memory with a transmitter in control and possession of the first party to a receiver having the second memory at a location determined by the second party, said receiver in possession and control of the second party;

and storing the digital signal in the second party hard disk.

48.(New) A method as described in claim 47 including after the transferring step, the steps of searching the first memory for the desired digital signal; and selecting the desired digital signal from the first memory.

49. (New) A method as described in claim 47 wherein the transferring step includes the steps of telephoning the first party controlling use of the first memory by the second party; providing a credit card number of the second party controlling the second memory to the first party controlling the first memory so the second party is charged money.

EVIDENCE APPENDIX

- 1) Declaration under 37 C.F.R. § 1.132 of Dr. J. Douglas Tygar submitted with the Appellant's response of May 17, 2007 to the final rejection of Claims 1 through 6 and 44 through 49.
- 2) "The Design of Picturephone® Meeting Service (PMS) Conference Centers For Video Teleconferencing", Bernard A. Wright, *IEEE Communications Magazine*, © 1983 (hereinafter *Wright*), submitted with the Appellant's response of May 17, 2007 to the final rejection of Claims 1 through 6 and 44 through 49.
- 3) Declaration under 37 C.F.R. § 1.132 of Arthur R. Hair submitted with the Appellant's response of December 27, 2005.
- 4) Declaration under 37 C.F.R. § 1.132 of Dr. J. Douglas Tygar submitted with the Appellant's response of December 27, 2005.
- 5) Website: <http://www.rfc-editor.org/rfc-index.html>, referenced in Appellant's response of November 29, 2006.
- 6) Website: http://en.wikipedia.org/wiki/Non-volatile_storage, referenced in Appellant's response of November 29, 2006.

IN THE UNITED STATES PATENT AND TRADEMARK OFFICE

In re Application of: 56548 U.S. PTO)
ARTHUR R. HAIR )
05/17/07)
Reexamination Control No. 90/007,402)
Reexamination Filed: January 31, 2005) A SYSTEM FOR TRANSMITTING
Patent Number: 5,191,573) DESIRED DIGITAL VIDEO OR
Examiner: Roland G. Foster) AUDIO SIGNALS)

May , 2007

Mail Stop *Ex Parte* Reexamination
Commissioner for Patents
P.O. Box 1450
Alexandria, VA 22313-1450

DECLARATION UNDER 37 C.F.R. §1.132

I, Justin Douglas Tygar, hereby declare that:

1. I am a tenured, full Professor at the University of California, Berkeley, with a joint appointment in the Department of Electrical Engineering and Computer Science (Computer Science Division) and the School of Information. Before joining the faculty at Berkeley, I was faculty member at Carnegie Mellon University. I have continuously been Professor of electrical engineering and computer science since 1986.

2. I serve, and have served, in a number of capacities on government, academic, and industrial committees that give advice or set standards in security and electronic commerce. I have attached a copy of a recent curriculum vita to this declaration as Exhibit A.

3. I have reviewed the specification and claims of United States Patent No. 5,191,573 ("573 Patent"), United States Patent No. 5,675,734 ("734 Patent"), United States Patent No. 5,966,440 ("440 Patent") and the specification and claims of United States patent application Serial Number 07/206,497, as originally filed on June 13, 1988 ("497 Application").

4. I have been asked by counsel for the patent owner to analyze the claims in the '573 Patent, '734 Patent and '440 Patent, which currently are being reexamined, to determine if the language in the claims and the accompanying specifications have written support in the specification of the '497 Application, as originally filed on June 13, 1988. I understand that, for a claim to be supported by the specification of a patent, the specification must make clear to one of ordinary skill in the art that the inventor had possession of the invention recited in the claims at the time the application for the patent was filed. I also understand that the claims of a patent need not describe the invention using exactly the same terminology found in the specification of the patent, so long as one of skill in the art would recognize that what is recited in the claims is "necessarily comprehended" by what is described in the specification.

5. My understanding of the meaning of "necessarily comprehend" is that, although the specification of a patent may not exactly describe, in so many words, a limitation found in a claim, one skilled in the art on reading the specification and the claim would recognize that what is described in the specification necessarily encompasses what is recited in the claim.

6. In performing my analysis, I have reviewed the claims and specifications of the '573 Patent, '734 Patent and '440 Patent, and the specification and drawings of the '497 Application as originally filed on June 13, 1988, from the perspective of one having ordinary skill in the art of computers at that time. For the purposes of my analysis, a person having ordinary skill in the art in 1988 would have had a bachelor's degree in computer science or electrical engineering with a background in computers, or an equivalent level of knowledge and ability from working in industry for an appropriate number of years. I am well familiar with what the level of ordinary skill was in 1988 because at that time I was a Professor of computer science and each semester taught courses to students in both computer science and electrical engineering. One of ordinary skill in the art would have been familiar with then existing means for storage of digital information and transmission of digital information across telecommunications lines.

7. Based on the foregoing information and understanding, I have concluded that one of ordinary skill in the art in 1988 would have recognized the inventions claimed in the '573 Patent, '734 Patent and '440 Patent were necessarily comprehended by the description in the specification and drawings of the '497 Application. I make the following specific observations with respect to particular claim elements at issue:

A. "Transferring Money from a Second Party to a First Party," "Charging a Fee," "Providing a Credit Card Number," and "Charging an Account"

8. First, I note that, throughout the specification, the '497 Application discusses electronic sales and distribution of digital audio signals (or digital video signals), e.g.

selling and distributing music over telephone lines, which are telecommunication lines. The claim language at issue; "transferring money electronically via a telecommunication line to a first party at a location remote from the second memory," "charging a fee," "providing a credit card number," and "charging an account," all would have been interpreted by one of ordinary skill in the art in the context of the described electronic sales and distribution. Thus, one of ordinary skill in the art in 1988 would have been familiar with various electronic means of making purchases over telecommunication lines. Indeed, by 1988 the definition of "money" had expanded well beyond traditional coin and paper currency to include stores of value in purely electronic form. At that time, "money" could be transferred from one account to another, or simply credited to an account purely electronically. Further, in 1988, it also was known to authorize payment, such as by credit card, electronically over telecommunications lines. This authorization would have involved providing an identification of credit card account information in the form of a credit card number. Further, since this ultimately would have resulted in a credit being made to an electronic account of a seller, it would have been understood to be an electronic transfer of money.

9. One of ordinary skill in the art in 1988 would have been aware of all of the above and would have considered them forms of electronic sales. The term "sale" involves a payment from one party to another party, which necessarily encompasses "charging a fee" to the purchasing party. Therefore, one of ordinary skill in the art would have recognized that, in the context of the electronic sale and distribution of digital audio signals (or digital video signals) over telephone lines, an electronic sale encompassed transactions where a fee is charged and thus money is transferred from one party to another electronically via a telecommunication line. It

further would have been understood by one of ordinary skill in the art that electronic sales could be accomplished by providing a credit card number. As a result, one of ordinary skill in the art in 1988 would have recognized that the description of electronic sales in the specification of the '479 Application necessarily comprehends "transferring money to a first party from a second party electronically via telecommunication lines," "charging a fee," "charging an account," and "providing a credit card number."

B. Transmitter/Receiver

10. I note that, throughout the specification, the '497 Application discusses electronic sales and distribution of digital audio signals (or digital video signals), e.g. electronically selling and distributing music over telephone lines, which are telecommunication lines. The specification of the '497 Application also explicitly discloses the electronic transfer of digital audio signals over telephone lines (telecommunication lines). Finally, the specification of the '497 Application further explicitly discloses control integrated circuits associated with the control units of both the copyright holder and user (purchaser).

11. One of ordinary skill in the art in 1988 would have been aware of the available means for connecting computer systems to telecommunication lines for the purpose of transferring electronic signals; for example modems. Such means could be used at the originating (transmitting) computer and at the destination (receiving) computer. The control unit or control integrated circuit of the copyright holder and user would have been recognized by one of ordinary skill in the art as being some type of computer system or part of a computer system.

12. Since the specification and figures as originally filed with the '497 Application explicitly show the control units being connected to telephone lines (telecommunications lines), one of ordinary skill in the art would have recognized this involved means, such as a modem, for connecting the two systems to the telephone lines. Although the specification of the '497 Application does not include an explicit description of a transmitter or receiver, one of ordinary skill in the art would have had no difficulty determining the nature of the transmitter or receiver necessary to perform the required function. Therefore, the terms in the claims, "transmitter" and "receiver", describe in so many words what would have been understood by one of ordinary skill in the art as being necessarily comprehended by the description provided in the specification and figures filed with the '497 Application.

C. Telephoning

13. As set forth above, the specification of the '497 Application explicitly teaches the sale and transfer of digital audio signals (or digital video signals) over telephone lines. Although not explicitly set forth in the specification of the '497 Application, it nonetheless would have been easily recognized by one of ordinary skill in the art in 1988 that the specification's teaching requires establishing some type of connectivity over telephone lines as a pre-requisite to making an electronic purchase/sale of digital signals over telephone lines, as well as for transferring the digital signals over telephone lines.

14. A successful telephone call, whether a human or machine originated function, always encompasses a step of initiating some type of connectivity. For example, the connectivity could be person to person, as over a voice line. As an alternative example, the

connectivity could be machine to machine, using either traditional telephone lines, optical fibers or cable. Other alternatives include person to machine connectivity and machine to person connectivity.

15. Since the specification of the '497 Application explicitly discloses electronically selling and distributing digital audio signals (or digital video signals) over telephone lines, it is clear that the step of requesting and establishing connectivity (telephoning) is necessarily comprehended in the description provided in the '497 Application, since the step would have been recognized as a prerequisite for performing the function of the disclosed system.

I further declare that all statements made herein of my own knowledge are true and that all statements made on information and belief are believed to be true; and further, that these statements are made with the knowledge that willful false statements and the like so made are punishable by fine or imprisonment, or both, under Section 1001 of Title 18 of the United States Code, and that such willful false statements may jeopardize the validity of the application or any patent issuing thereon.

11 May 2007



Date

Justin Douglas Tygar, Ph.D.

DOUG TYGAR

Address:

University of California.
102 South Hall #4600
Berkeley, CA 94720-4600
(510) 643-7855
tygar@cs.berkeley.edu

Personal Information:

Full name: Justin Douglas Tygar
US Citizen
Married to Xiaoniu Suchu Hsu

Education:

- A.B., 1982 **University of California, Berkeley, Math/Computer Science**
Bell Labs University Relations Student (1981)
- Ph.D., 1986 **Harvard University, Computer Science**
Thesis: *An Integrated Toolkit for Operating System Security*
Advisor: Michael Rabin
NSF Graduate Fellow (1982 – 1985), IBM Graduate Fellow (1985 – 1986)

Academic Appointments:

University of California, Berkeley
Department of Electrical Engineering and Computer Science
& School of Information Management and Systems
1998 – Present *Professor (tenured, joint appointment)*

Carnegie Mellon University
Computer Science Department
2000 – Present *Adjunct Professor*
1992 – 2000 *Associate Professor (tenured 1995, on leave 1998 – 2000)*
1986 – 1992 *Assistant Professor*

Major Awards:

NSF Presidential Young Investigator, 1988
Outstanding Professor Award, *Carnegie Magazine*, 1989
Chair, Defense Information Science and Technology Study Group on Security with Privacy
Member, National Research Council Committee on Information Trustworthiness
Member, INFOSEC Science and Technology Study Group
Okawa Foundation Fellow, 2003-4
Wide consulting for both industry and government

Major speeches:

Keynote addresses:

PODC (1995), ASIAN-96 (1996), NGITS (1997), VLDB (1998), CRYPTEC (1999),
CAV (2000), Human Authentication (2001), PDSN (2002), ISM (2005), ISC (2005), ASIACCS (2006),
Croucher ASI (2004, 2006)

Invited addresses:

Harvard Graduate School of Arts and Science 100th Anniversary,
CMU Computer Science Department 25th Anniversary
More than 240 talks & 20 professional seminars since 1985

External review activities:

Electronic Commerce Program, City University of Hong Kong
Information Systems Management Program, Singapore Management University
Information Technology Program, United Arab Emirates University
Computer Science Program, University of California, Davis

Publications

(Note: copies of most of these publications are available at www.tygar.net/publications.htm.)

Books

1. **Computer Security in the 21st Century.** Eds. D. Lee, S. Shieh, and J. D. Tygar. Springer, 2005. (This book includes item 7 below as well as a technical introduction by me and the other editors.)
2. **Secure Broadcast Communication in Wired and Wireless Networks.** A. Perrig and J. D. Tygar. Springer (Kluwer), 2003. Also, a Japanese translation with additional material appeared as **Waiyādo/Waiyaresu Nettowōku ni Okeru Burōdokyasuto Tsūshin no Sekyuriti** (ワイヤード/ワイヤレスネットワークにおけるブロードキャスト通信のセキュリティ). Translated by Fumio Mizoguchi and the Science University of Tokyo Information Media Science Research Group. Kyoritsu Shuppan, 2004.
3. **Trust in Cyberspace.** National Research Council Committee on Information Systems Trustworthiness (S. Bellovin, W. E. Boebert, M. Branstad, J. R. Catoe, S. Crocker, C. Kaufman, S. Kent, J. Knight, S. McGeady, R. Nelson, A. Schiffman, F. Schneider [ed.], G. Spix, and J. D. Tygar). National Academy Press, 1999.

Book Chapters (does not include items listed above)

4. "Case Study: Acoustic Keyboard Emanations." L. Zhuang, F. Zhou, and J. D. Tygar. In **Phishing and Countermeasures: Understanding the Increasing Problem of Electronic Identity Theft**, eds. M. Jakobsson and S. Myers. Wiley-Interscience, 2007, pp. 221-240. (This is a popularized version of item 41.)
5. "Dynamic Security Skins." R. Dhamija and J. D. Tygar.. In **Phishing and Countermeasures: Understanding the Increasing Problem of Electronic Identity Theft**, eds. M. Jakobsson and S. Myers. Wiley-Interscience, 2007, pp. 339-351. (This is a popularized version of item 42.)
6. "Why Johnny can't encrypt: A usability evaluation of PGP 5.0." A. Whitten and J. D. Tygar. In **Security and Usability: Designing Secure Systems that People Can Use**, eds. L. Cranor and G. Simson. O'Reilly, 2005, pp. 679-702. (An earlier version of the paper was published in **Proceedings of the 8th USENIX Security Symposium**, August 1999, pp. 169-183. See also item 87.)
7. "Private matching." Y. Li, J. D. Tygar, J. Hellerstein. In **Computer Security in the 21st Century**, eds. D. Lee, S. Shieh, and J. D. Tygar. Springer, 2005, pp. 25-50. (See item 1.) (An early version of this paper appeared as Intel Research Laboratory Berkeley technical report IRB-TR-04-005, February 2004.)
8. "Digital cash." J. D. Tygar. In **Berkshire Encyclopedia of Human Computer Interaction**, ed. W. Bainbridge. Berkshire Publishing, 2004, pp. 167-170.

9. "Spamming." J. D. Tygar. In **Berkshire Encyclopedia of Human Computer Interaction**, ed. W. Bainbridge. Berkshire Publishing, 2004, pp. 673-675.
10. "Viruses." J. D. Tygar. In **Berkshire Encyclopedia of Human Computer Interaction**, ed. W. Bainbridge. Berkshire Publishing, 2004, pp. 788-791.
11. "Privacy in sensor webs and distributed information systems." J. D. Tygar. In **Software Security**, eds. M. Okada, B. Pierce, A. Scedrov, H. Tokuda, and A. Yonezawa. Springer, 2003, pp. 84-95.
12. "Atomicity in electronic commerce." J. D. Tygar. In **Internet Besieged**, eds. D. Denning and P. Denning. ACM Press and Addison-Wesley, 1997, pp. 389-405. (An expanded earlier version of this paper was published in **Proceedings of the Fifteenth Annual ACM Symposium on Principles of Distributed Computing, Keynote paper**, May 1996, pp. 8-26; and as Carnegie Mellon University Computer Science technical report CMU-CS-96-112, January 1996. See also item 28.)
13. "Cryptographic postage indicia." J. D. Tygar, B. Yee, and N. Heintze. In **Concurrency and Parallelism, Programming, Networking, and Security**, eds. J. Jaffar and R. Yap. Springer, 1996, pp. 378-391. (Preprint also available. Early versions appeared as Carnegie Mellon University Computer Science technical reports CMU-CS-96-113, January 1996, UC San Diego Computer Science technical report UCSD-TR-CS96-485, and in the 1996 **Securicom Proceedings**, Paris, 1996. See also item 89.
14. "Dyad: A system for using physically secure coprocessors." J. D. Tygar and B. Yee. In **Technological Strategies for the Protection of Intellectual Property in the Networked Multimedia Environment**. Interactive Multimedia Association, 1994, pp. 121-152. (An early version appeared as Carnegie Mellon University Computer Science technical report CMU-CS-91-140R, May 1991.)
15. "A system for self-securing programs." J. D. Tygar and B. Yee. In **Carnegie Mellon Computer Science: A 25-Year Commemorative**, ed. R. Rashid. ACM Press and Addison-Wesley, 1991, pp. 163-197. (Note: The first printing of this volume had incorrect text due to a production error.)
16. "Implementing capabilities without a trusted kernel." M. Herlihy and J. D. Tygar. In **Dependable Computing for Critical Applications**, eds. A. Avizienis and J. Laprie. Springer, 1991, pp. 283-300. (Note: An early version appeared in the **(IFIP) Proceedings of the International Working Conference on Dependable Computing for Critical Applications**, August 1989.)
17. "Strongbox." J. D. Tygar and B. Yee. In **Camelot and Avalon: A Distributed Transaction Facility**, eds. J. Eppinger, L. Mummert, and A. Spector. Morgan-Kaufmann, 1991, pp. 381-400.
18. "ITOSS: An Integrated Toolkit for Operating System Security." M. Rabin and J. D. Tygar. In **Foundations of Data Organization**, eds. W. Litwin and H.-J. Shek. Springer, 1990, pp. 2-15. (Preprint also available.) (Note: Earlier, longer versions appeared as Harvard University Aiken Computation Laboratory technical report TR-05-87R and my Ph.D. dissertation.)
19. "Formal Semantics for Visual Specification of Security." M. Maimone, J. D. Tygar, and J. Wing. In **Visual Languages and Visual Programming**, ed. S. K. Chang. Plenum, 1990, pp.

97-116. (An early version was published in **Proceedings of the 1988 IEEE Workshop on Visual Programming**, pp. 45-51, and as Carnegie Mellon University Computer Science technical report CMU-CS-88-173r, December 1988.)

Journal Articles (does not include items listed above)

20. "Injecting Heterogeneity through Protocol Randomization." L. Zhuang, J. D. Tygar, R. Dhamija. In *International Journal of Network Security*, 4:1, January 2007, pp. 45-58.
21. "Cyber defense technology networking and evaluation." Members of the DETER and EMIST Projects (R. Bajcsy, T. Benzel, M. Bishop, B. Braden, C. Brodley, S. Fahmy, S. Floyd, W. Hardaker, A. Joseph, G. Kesidis, K. Levitt, B. Lindell, P. Liu, D. Miller, R. Mundy, C. Neuman, R. Ostrenga, V. Paxson, P. Porras, C. Rosenberg, S. Sastry, D. Sterne, J. D. Tygar, and S. Wu). In *Communications of the ACM*, 47:3, March 2004, pp. 58-61.
22. "Technological dimensions of privacy in Asia." J. D. Tygar. In *Asia-Pacific Review*, 10:2, November 2003, pp. 120-145.
23. "SPINS: Security protocols for sensor networks." A. Perrig, R. Szewczyk, J. D. Tygar, V. Wen, and D. Culler. In *[ACM Journal of] Wireless Networks*, 8:5, September 2002, pp. 521-534. (An early version of this paper appears in **Proceedings of the 7th Annual International Conference on Mobile Computing and Networks (MOBICOM)**, July 2001, pp. 189-199.)
24. "The TESLA broadcast authentication protocol." A. Perrig, R. Canetti, J. D. Tygar, and D. Song. In *CryptoBytes*, 5:2, Summer/Fall 2002, pp. 2-13.
25. "SAM: A flexible and secure auction architecture using trusted hardware." A. Perrig, S. Smith, D. Song, and J. D. Tygar. In *Electronic Journal on E-commerce Tools and Applications*, 1:1, January 2002 (online journal). (An early version of this paper appeared in **Proceedings of the 1st IEEE International Workshop on Internet Computing and Electronic Commerce**, April 2001, pp. 1764-1773.)
26. "Why isn't the internet secure yet?" J. D. Tygar and A. Whitten. In *ASLIB Proceedings*, 52:3, March 2000, pp. 93-97.
27. "Multi-round anonymous auction protocols." H. Kikuchi, M. Harkavy, and J. D. Tygar. In *Institute of Electronics, Information, and Communication Engineers Transactions on Information and Systems*, E82-D:4, April 1999, pp. 769-777. (An early version appeared in **Proceedings of the First IEEE Workshop on Dependable and Real-Time E-Commerce Systems (DARE '98)**, June 1998, pp. 62-69.)
28. "Atomicity in electronic commerce." J. D. Tygar. In *ACM NetWorker*, 2:2, April/May 1998, pp. 32-43. (Note: this is a revision of item 12 published together with a new article: "An update on electronic commerce." In *ACM NetWorker*, Volume 2, Number 2, April/May 1998, pp. 40-41.)
29. "A model for secure protocols and their compositions." N. Heintze and J. D. Tygar. In *IEEE Transactions on Software Engineering*, 22:1, January 1996, pp. 16-30. (An extended abstract appeared in **Proceedings of the 1994 IEEE Symposium on Security and Privacy**, May 1994, pp. 2-13. Another early version appeared as Carnegie Mellon University Computer Science technical report CMU-CS-92-100, January 1992.)

30. "NetBill: An Internet commerce system optimized for network-delivered services." M. Sirbu and J. D. Tygar. In *IEEE Personal Communications*, 2:4, August 1995, pp. 34-39. (An early version appeared in *Proceedings of Uniforum '96*, February 1996, pp. 203-226. Another early version appeared in *Proceedings of the 40th IEEE Computer Society International Conference*, Spring 1995, pp. 20-25.)
31. "Optimal sampling strategies for quicksort." C. C. McGeoch and J. D. Tygar. In *Random Structures and Algorithms*, 7:4, 1995, pp. 287-300. (An early version appeared in *Proceedings of the 28th Annual Allerton Conference on Communication, Control, and Computing*, October 1990, pp. 62-71.)
32. "Geometric characterization of series-parallel variable resistor networks." R. Bryant, J. D. Tygar, and L. Huang. In *IEEE Transactions on Circuits and Systems 1: Fundamental Theory and Applications*, 41:11, November 1994, pp. 686-698. (Preprint also available.) (An early version appeared in *Proceedings of the 1993 IEEE International Symposium on Circuits and Systems*, May 1993, pp. 2678-2681.)
33. "Computability and complexity of ray tracing." J. Reif, J. D. Tygar, and A. Yoshida. In *Discrete and Computational Geometry*, 11:3, April 1994, pp. 265-287. (An early version appeared in *Proceedings of the 31st Annual IEEE Symposium on Foundations of Computer Science*, October 1990, pp. 106-114.)
34. "Specifying and checking Unix security constraints." A. Heydon and J. D. Tygar. In *Computing Systems*, 7:1, Winter 1994, pp. 91-112. (An early version appeared in *Proceedings of the 3rd USENIX Security Symposium*, September 1992, pp. 211-226, preprint also available.)
35. "Protecting privacy while preserving access to data." L. J. Camp and J. D. Tygar. In *The Information Society*, 10:1, January 1994, pp. 59-71.
36. "Miro: visual specification of security." A. Heydon, M. Maimone, J. D. Tygar, J. Wing, and A. Zaremski. In *IEEE Transactions on Software Engineering*, 16:10, October 1990, pp. 1185-1197. (An early version appeared as Carnegie Mellon University Computer Science Department technical report CMU-CS-89-199, December 1989.)
37. "Efficient parallel pseudo-random number generation." J. Reif and J. D. Tygar. In *SIAM Journal of Computation*, 17:2, April 1988, pp. 404-411. (An early version appeared in *Proceedings of CRYPTO-85*, eds. E. Brickell and H. Williams, Springer, 1986, pp. 433-446.)
38. "Review of Abstraction and Specification in Program Development." J. D. Tygar. In *ACM Computing Reviews*, 28:9, September 1987, pp. 454-455.

Refereed Conference Papers (does not include items listed above)

39. "Why Phishing Works." R. Dhamija, J. D. Tygar, and M. Hearst. To appear in *Proceedings of CHI-2006: Conference on Human Factors in Computing Systems*, April 2006.
40. "Can Machine Learning Be Secure?" M. Barreno, B. Nelson, R. Sears, A. Joseph, and J. D. Tygar. *Invited paper*. To appear in *Proceedings of the ACM Symposium on Information, Computer, and Communication Security*, March 2006.

41. "Keyboard Acoustic Emanations Revisited." L. Zhuang, F. Zhou, and J. D. Tygar. In **Proceedings of the 12th ACM Conference on Computer and Communications Security**, November 2005, pp. 373-382. (See also item 4.)
42. "The Battle Against Phishing: Dynamic Security Skins." R. Dhamija and J. D. Tygar. In **SOUPS 2005: Proceedings of the 2005 ACM Symposium on Usable Security and Privacy**, *ACM International Conference Proceedings Series*, ACM Press, July 2005, pp. 77-88. (See also item 5.)
43. "Collaborative filtering CAPTCHAs." M. Chew and J. D. Tygar. In **Human Interactive Proofs: Second International Workshop (HIP 2005)**, eds. H. Baird and D. Lopresti, Springer, May 2005, pp. 66-81.
44. "Phish and HIPs: Human interactive proofs to detect phishing attacks." R. Dhamija and J. D. Tygar. In **Human Interactive Proofs: Second International Workshop (HIP 2005)**, eds. H. Baird and D. Lopresti, Springer, May 2005, pp. 127-141.
45. "Image recognition CAPTCHAs." M. Chew and J. D. Tygar. In **Proceedings of the 7th International Information Security Conference (ISC 2004)**, Springer, September 2004, pp. 268-279. (A longer version appeared as UC Berkeley Computer Science Division technical report UCB/CSD-04-1333, June 2004.)
46. "Side effects are not sufficient to authenticate software." U. Shankar, M. Chew, and J. D. Tygar. In **Proceedings of the 13th USENIX Security Symposium**, August 2004, pp. 89-101. (A version with an additional appendix appeared as UC Berkeley Computer Science Division technical report UCB/CSD-04-1363, September 2004.)
47. "Statistical monitoring + predictable recovery = Self-*." A. Fox, E. Kiciman, D. Patterson, R. Katz, M. Jordan, I. Stoica and J. D. Tygar. In **Proceedings of the 2nd Bertinoro Workshop on Future Directions in Distributed Computing (FuDiCo II)**, June 2004 (online proceedings).
48. "Distillation codes and their application to DoS resistant multicast authentication." C. Karlof, N. Sastry, Y. Li, A. Perrig, and J. D. Tygar. In **Proceedings of the Network and Distributed System Security Conference (NDSS 2004)**, February 2004, pp. 37-56.
49. "Privacy and security in the location-enhanced World Wide Web." J. Hong, G. Boriello, J. Landay, D. McDonald, B. Schilit, and J. D. Tygar. In **Proceedings of the Workshop on Privacy at Ubicomp 2003**, October 2003 (online proceedings).
50. "The problem with privacy." J. D. Tygar. *Keynote paper*. In **Proceedings of the 2003 IEEE Workshop on Internet Applications**, June 2003, pp. 2-8.
51. "Safe staging for computer security." A. Whitten and J. D. Tygar. In **Proceedings of the 2003 Workshop on Human-Computer Interaction and Security Systems**, April 2003 (online proceedings).
52. "Expander graphs for digital stream authentication and robust overlay networks." D. Song, D. Zuckerman, and J. D. Tygar. In **Proceedings of the 2002 IEEE Symposium on Security and Privacy**, May 2002, pp. 258-270.

53. "ELK: A new protocol for efficient large-group key distribution." A. Perrig, D. Song, and J. D. Tygar. In **Proceedings of the 2001 IEEE Symposium on Security and Privacy**, May 2001, pp. 247-262.
54. "Efficient and secure source authentication for multicast." A. Perrig, R. Canetti, D. Song, and J. D. Tygar. In **Proceedings of the Internet Society Network and Distributed System Security Symposium (NDSS 2001)**, February 2001, pp. 35-46.
55. "Efficient authentication and signing of multicast streams over lossy channels." A. Perrig, R. Canetti, J. D. Tygar, and D. Song. In **Proceedings of the 2000 IEEE Symposium on Security and Privacy**, May 2000, pp. 56-73..
56. "Flexible and scalable credential structures: NetBill implementation and experience." Y. Kawakura, M. Sirbu., I. Simpson, and J. D. Tygar. In **Proceedings of the International Workshop on Cryptographic Techniques and E-Commerce**, July 1999, pp. 231-245.
57. "Open problems in electronic commerce." J. D. Tygar. *Invited address*. In **Proceedings of the 18th ACM SIGMOD-SIGACT-SIGART Symposium on Principles of Database Systems (PODS 1999)**, May 1999, p. 101.
58. "Electronic auctions with private bids." M. Harkavy, J. D. Tygar, and H. Kikuchi. In **Proceedings of the 3rd USENIX Workshop on Electronic Commerce**, September 1998, pp. 61-73.
59. "Atomicity versus anonymity: Distributed transactions for electronic commerce." J. D. Tygar. In **Proceedings of the 24th International Conference on Very Large Data Bases**, August 1998, pp. 1-12.
60. "Smart cards in hostile environments." H. Gobiuff, S. Smith, J. D. Tygar, and B. Yee. In **Proceedings of the 2nd USENIX Workshop on Electronic Commerce**, November 1996, pp. 23-28. (An early version appeared as Carnegie Mellon University Computer Science technical report CMU-CS-95-188, September 1995.)
61. "Anonymous atomic transactions." L. J. Camp, M. Harkavy, and B. Yee. In **Proceedings of the 2nd USENIX Workshop on Electronic Commerce**, November 1996, pp. 123-133. (Preprint also available.) (An early version appeared as Carnegie Mellon University Computer Science technical report CMU-CS-96-156, July 1996.)
62. "Model checking electronic commerce protocols." N. Heintze, J. D. Tygar, J. Wing, and H. Wong. In **Proceedings of the 2nd USENIX Workshop on Electronic Commerce**, November 1996, pp. 147-164.
63. "WWW electronic commerce and Java Trojan horses." J. D. Tygar and A. Whitten. In **Proceedings of the 2nd USENIX Workshop on Electronic Commerce**, November 1996, pp. 243-250.
64. "Building blocks for atomicity in electronic commerce." J. Su and J. D. Tygar. In **Proceedings of the 6th USENIX Security Symposium**, July 1996, pp. 97-102.
65. "Token and notational money in electronic commerce." L. J. Camp, M. Sirbu, and J. D. Tygar. In **Proceedings of the 1st USENIX Workshop on Electronic Commerce**, July 1995, pp. 1-12.

(An early version was presented at the Telecommunications Policy Research Conference, October 1994.)

66. "NetBill security and transaction protocol." B. Cox, J. D. Tygar, and M. Sirbu. In **Proceedings of the 1st USENIX Workshop on Electronic Commerce**, July 1995, pp. 77-88.
67. "Secure coprocessors in electronic commerce applications." B. Yee and J. D. Tygar. In **Proceedings of the 1st USENIX Workshop on Electronic Commerce**, July 1995, pp. 155-170.
68. "Completely asynchronous optimistic recovery with minimal rollbacks." S. Smith, D. Johnson, and J. D. Tygar. In **Proceedings of the 25th IEEE Symposium on Fault-Tolerant Computing**, June 1995, pp. 361-370. (An early version appears as Carnegie Mellon University Computer Science technical report CMU-CS-94-130, March 1994.)
69. "A fast off-line electronic currency protocol." L. Tang and J. D. Tygar. In **CARDIS 94: Proceedings of the First IFIP Smart Card Research and Advanced Application Conference**, October 1994, pp. 89-100.
70. "Security and privacy for partial order time." S. Smith and J. D. Tygar. In **Proceedings 1994 Parallel and Distributed Computing Systems Conference**, October 1994, pp. 70-79. (Early versions appeared as Carnegie Mellon University Computer Science technical reports CMU-CS-93-116, October 1991 and February 1993, and CMU-CS-94-135, April 1994.)
71. "Certified electronic mail." A. Bahreman and J. D. Tygar. In **Proceedings of the 1994 Network and Distributed Systems Security Conference**, February 1994, pp. 3-19.
72. "Miro tools." A. Heydon, M. Maimone, A. Moormann, J. D. Tygar and J. Wing. In **Proceedings of the 3rd IEEE Workshop on Visual Languages**, October 1989, pp. 86-91. (A preprint appeared as Carnegie Mellon University Computer Science technical report CMU-CS-89-159, July 1989.)
73. "Constraining pictures with pictures." A. Heydon, M. Maimone, A. Moormann, J. D. Tygar, and J. Wing. In **Information Processing 89: Proceedings of the 11th World Computer Congress**, August 1989, pp. 157-162. (An early version appeared as Carnegie Mellon University Computer Science technical report CMU-CS-88-185, November 1988.)
74. "How to make replicated data secure." M. Herlihy and J. D. Tygar. In **Proceedings of CRYPTO-87**, ed. C. Pomerance, 1988, pp. 379-391. (An early version appeared as Carnegie Mellon University Computer Science Technical Report CMU-CS-87-143, August 1987.)
75. "Visual specification of security constraints." J. D. Tygar and J. Wing. In **Proceedings of the 1987 (First IEEE) Workshop on Visual Languages**, August 1987, pp. 288-301. (A preprint appeared as Carnegie Mellon University Computer Science Technical Report CMU-CS-87-122, May 1987.)
76. "Efficient netlist comparison using hierarchy and randomization." J. D. Tygar and R. Ellickson. In **Proceedings of the 22nd ACM/IEEE Design Automation Conference**, Las Vegas, NV, July 1985, pp. 702-708.
77. "Hierarchical logic comparison." R. Ellickson and J. D. Tygar. In **Proceedings of MIDCON '84**, 1984.

Other Conference Publications (does not include items listed above)

78. "When Computer Security Crashes with Multimedia." [Abstract] J. D. Tygar. In **Proceedings of the 7th International IEEE Symposium on Multimedia**, December 2005, p. 2.
79. "Notes from the Second USENIX Workshop on Electronic Commerce." M. Harkavy, A. Meyers, J. D. Tygar, A. Whitten, and H. Wong. In **Proceedings of the 3rd USENIX Workshop on Electronic Commerce**, September 1998, pp. 225-242.
80. "How are we going to pay for this? Fee-for-service in distributed systems -- research and policy issues." C. Clifton, P. Gemmel, E. Means, M. Merges, J. D. Tygar. In **Proceedings of the 15th International Conference on Distributed Computing Systems**, May 1995, pp. 344-348.
81. "Miro: A visual language for specifying security." [Abstract] M. Maimone, A. Moormani, J. D. Tygar, J. Wing. In **Proceedings of the (First) USENIX UNIX Security Workshop**, August 1988, p. 49.
82. "StrongBox: support for self-securing programs." [Abstract] J. D. Tygar, B. Yee, and A. Spector. In **Proceedings of the (First) USENIX UNIX Security Workshop**, August 1988, p. 50.

Standards Documents (does not include items listed above)

83. **TESLA: Multicast Source Authentication Transform Introduction**. A. Perrig, D. Song, R. Canetti, J. D. Tygar, B. Briscoe. IETF RFC 4082. June 2005. (Early drafts of this RFC were published in October 2002, and in May, August, and December 2004.)
84. **Performance Criteria for Information-Based Indicia and Security Architecture for Closed IBI Postage Metering Systems (PCIBI-C) (Draft)**. United States Postal Service. January 1999. (Note: I was a major contributor to this document.)
85. **Performance Criteria for Information-Based Indicia and Security Architecture for Open IBI Postage Evidence Systems (PCIBI-O) (Draft)**. United States Postal Service. February 2000. (Note: I was a major contributor to this document.)
86. **Production, Distribution, and Use of Postal Security Devices and Information Based Indicia**. United States Postal Service. *Federal Register* 65:191, October 2, 2000, pp. 58682-58698. (Note: I was a major contributor to this document.)

Technical Reports (does not include items listed above)

87. **Usability of Security: A Case Study**. A. Whitten and J. D. Tygar. Carnegie Mellon University Computer Science technical report CMU-CS-98-155, December 1998. (Note: this report partly overlaps item 6, but also includes substantial additional material.)
88. **Security for Network Attached Storage Devices**. H. Gobioff, G. Gibson and J. D. Tygar. Carnegie Mellon University Computer Science technical report CMU-CS-97-185, October 1997.
89. **Cryptography: It's Not Just for Electronic Mail Anymore**. J. D. Tygar and B. Yee. Carnegie Mellon University Computer Science technical report CMU-CS-93-107, March 1993. (See also item 13 above.)

90. **Median Separators in d Dimensions.** J. Sipelstein, S. Smith, and J. D. Tygar . Carnegie Mellon University Computer Science technical report CMU-CS-88-206, December 1988.
91. **When are Best Fit and First Fit Optimal?** C. McGeoch and J. D. Tygar. Carnegie Mellon University Computer Science technical report CMU-CS-87-168, October 1987.
92. **Display Manager User's Guide.** J. D. Tygar. Valid Logic Systems engineering memorandum, VED-050682-1-JDT, May 1982.
93. **Performance analysis of the DANTE Network.** Bell Telephone Laboratories technical memorandum, August 1981.

Patents (does not include items listed above)

94. **Anonymous certified delivery.** L. J. Camp, J. D. Tygar, and M. Harkavy. US Patent 6,076,078, June 13, 2000.
95. **Method and apparatus for purchasing and delivering digital goods over a network.** M. Sirbu, J. D. Tygar, B. Cox, T. Wagner. US Patent 5,809,144, September 15, 1998.

Miscellaneous Technical (does not include items listed above)

96. **Security with Privacy.** Briefing from the Information Science and Technology Study Group on Security and Privacy (chair: J. D. Tygar). December 2002.
97. **Expert Report of J. D. Tygar ... A&M Records et al v. Napster....** J. D. Tygar. (For Hearing) July 2000.

Miscellaneous Non-Technical (does not include items listed above)

98. "Welcome Multiculturalism (Letter to the Editor)." J. D. Tygar. *Taipei Times*, November 12, 2004, p. 8.

IN THE UNITED STATES PATENT AND TRADEMARK OFFICE

In re Application of:)
ARTHUR R. HAIR)
Reexamination Control No. 90/007,402)
Reexamination Filed: January 31, 2005) METHOD FOR TRANSMITTING A
Patent Number: 5,191,573) DESIRED DIGITAL VIDEO OR
Examiner: Benjamin E. Lanier) AUDIO SIGNALS
Pittsburgh, Pennsylvania 15213

December 23, 2005

Mail Stop *Ex Parte* Reexamination
Commissioner for Patents
P.O. Box 1450
Alexandria, VA 22313-1450

DECLARATION UNDER 37 C.F.R. §1.132

I, Arthur R. Hair, hereby declare that:

1. I am the sole inventor of United States Patent Nos. 5,191,573; 5,675,734; and 5,966,440.
2. I am Chairman of the Board and Chief Technology Officer of SightSound Technologies, Inc.
3. I assigned my rights in United States Patent Nos. 5,191,573; 5,675,734; and 5,966,440 to the company that ultimately became SightSound Technologies, Inc ("SightSound").
These patents served SightSound Technologies well and were essential in raising the

capital necessary to launch a company that would build eCommerce systems protected by the patents.

4. With the foregoing three patents in hand, SightSound Technologies achieved many notable firsts, including:
 - first to electronically sell a music download via the Internet;
 - first to electronically sell a movie download via the Internet;
 - first to produce a motion picture specifically for simultaneous electronic distribution worldwide via the Internet;
 - first to electronically sell encrypted movies legally through the Gnutella file-sharing networks, without being in violation of copyrights;
 - first to develop a legal system to sell encrypted music legally through the Napster file-sharing networks, without being in violation of copyrights;
 - first to electronically sell a movie into a movie theater projection booth via the Internet for digital exhibition from a windows workstation; and
 - first to electronically sell a movie into a handheld unit, a Compaq iPac Pocket PC.

5. SightSound built five Media eCommerce Systems. Over time, these systems grew from a single server located in Pittsburgh to a geographically distributed system with a central core in Pittsburgh that controlled remote servers located in New York, Los Angeles, Santa Clara, Seattle, Chicago, Washington D.C. and Boston. Version 1 was built in 1995

and Version 2 was built in 1998, both of these versions only sold music. Version 3.1, 3.2 and 3.3 were built between 1999 and 2001 and sold both music and movies. The fifth system built at SightSound Technologies (which we called Version 3.3) was a fully automated, database driven secure Media eCommerce System that had the hardware capacity to rent and/or sell 380,000 movies a day.

6. The foregoing Media eCommerce Systems were covered by one or more claims in each of United States Patent Nos. 5,141,573, 5,675,734 and 5,966,440.

7. The Media eCommerce Systems were designed to support:
 - official movie websites;
 - banner ads that automatically invoke a download;
 - digital cinema (download to the projection booth);
 - portable audio/video devices
 - database driven websites; and
 - peer-to-peer file-sharing networks.

8. Using its Media eCommerce Systems, SightSound Technologies provided client services releasing motion pictures and music for Internet download sale for more than 40 filmmakers, special interest video production companies and recording artists. SightSound Technologies first offered music for sale via the Internet in download fashion in September 1995. At that time, SightSound Technologies offered music from the band

IN THE UNITED STATES PATENT AND TRADEMARK OFFICE

In re Application of:)
ARTHUR R. HAIR)
Reexamination Control No. 90/007,402)
Reexamination Filed: January 31, 2005) A SYSTEM FOR TRANSMITTING
Patent Number: 5,191,573) DESIRED DIGITAL VIDEO OR
Examiner: Benjamin E. Lanier) AUDIO SIGNALS

December 23, 2005

Mail Stop *Ex Parte* Reexamination
Commissioner for Patents
P.O. Box 1450
Alexandria, VA 22313-1450

DECLARATION UNDER 37 C.F.R. §1.132

I, Justin Douglas Tygar, hereby declare that:

1. I am a tenured, full Professor at the University of California, Berkeley with a joint appointment in the Department of Electrical Engineering and Computer Science (Computer Science Division) and the School of Information Management and Systems.

2. I earned an A.B. degree in Math/Computer Science from the University of California, Berkeley, in 1982 and I earned a Ph.D. in Computer Science from Harvard University in 1986.

3. I am an expert in software engineering, computer security, and cryptography. I have taught courses in software engineering and computer security at the

undergraduate, master's, and doctorate level at both the University of California, Berkeley and Carnegie Mellon University.

4. I serve in a number of capacities on government, academic, and industrial committees that give advice or set standards in security and electronic commerce. In addition, I have authored numerous publications in the fields of computer science and security in electronic commerce. I have attached a copy of a recent curriculum vita to this declaration as Exhibit A.

5. At the request of counsel, I have compared a currently available system for purchasing digital audio files, namely the online music service offered at www.napster.com known as Napster Light¹ (hereinafter "Napster Light"), with the teachings of U.S. Patent 5,191,573 (the "'573 patent").

6. Napster Light is a currently operating service with an apparently wide user base. It is therefore apparent that Napster Light, which uses the teachings of the '734 Patent, has been commercially successful.

7. The '573 Patent generally discloses a method pertaining to the electronic sale and transfer of digital audio or video signals, which are signals containing recorded sound or

¹ It should be noted that the Napster Light service offered by the entity known currently as Napster, Inc. at www.napster.com is separate and distinct from a previous file sharing on-line service offered by an earlier entity entitled Napster. It is my understanding that this prior entity went out of business in 2002, at which time Roxio, Inc. acquired the Napster name and trademark rights. Subsequently, Roxio, Inc. changed their name to Napster, Inc., thus creating the current entity referred to herein as "the new Napster, Inc."

video, such as a musical or video recording, converted into binary form. The steps of the method pertain to the following:

- A first party who is a seller of digital audio or video signals through telecommunication lines. Telecommunication lines can include the Internet. The seller must have control over a computer memory, which includes a hard disk and RAM. The hard disk includes copies of encoded digital audio or video signals, which are the digital audio or video signals configured in a form that would prevent unauthorized copying.

- A second party who is a buyer of the digital audio or video signals. The buyer must possess and control his or her own computer memory. The buyer's memory must be located at a location remote from the location of the memory controlled by the seller.

8. The invention of the '573 patent comprises a number of steps, though not in any particular order except as indicated below. The steps are:

- Forming an end-to-end electronic connection over the telecommunications lines between the computer memory controlled by the seller and the buyer's computer memory, which is controlled by the buyer;

- Transmitting the desired digital audio signal from the first memory to the second memory; and

- Storing the transferred copy of the digital audio or video signals in the buyer's memory.

9. I have accessed Napster Light for the purpose of comparing it to the '734 patent. Based on my review, I have determined the following facts set forth in paragraphs 10 through 20 of this declaration.

10. The operator of Napster Light (i.e., the new Napster, Inc.), the "first party" for the purposes of this comparison, operates a music download system through which digital music files are sold to buyers for download over the internet. The digital music files contain digital representations of sound recordings. I have concluded from viewing information on www.napster.com that Napster Light uses a system that includes servers, which have memory that includes hard disks that store digital music for sale over the internet. The new Napster, Inc. appears to control the servers that contain the digital music files for sale.

11. The typical online buyer using Napster Light, the "second party" for the purposes of this comparison, controls a personal computer. For instance, the buyer controls which software to install and run on the computer, what data to store in the computer, and when to operate the computer. The buyer has the computer at a home, office, or other location remote from Napster Light.

12. Using a software application downloaded from a website associated with Napster Light, the online buyer may connect to Napster Light's online music library over the Internet and browse online music catalogs. The buyer forms a connection between his or her computer and the Internet through an Internet Service Provider (ISP) that may be accessed via a dial-up connection using a modem and a telephone line.

13. Using the downloaded software application, the online buyer browses Napster Light's online music catalogs. The online buyer can select a particular digital music file he or she desires.

14. The digital music file is delivered to the online buyer via a download operation that is automatically initiated between Napster Light's servers and the online buyer's computer.

15. The download process occurs by transmitting a copy of the digital music file over the Internet to the online buyer's computer. The transmitted copy is stored in the online buyer's computer hard drive. Throughout this downloading process, the online buyer is in control of his or her computer's memory.

16. The downloaded copy of the digital music is stored to the hard drive of the buyer's computer, from which it can be written to other media such as an optical disk or memory of a portable device.

17. Napster Light does not include a point-of-sale device such as a kiosk, as used in United States Patent No. 4,528,643 to Freeny (the "Freeny Patent").

18. Napster Light does not writing a digital signal from memory directly to an optical disk or digital tape, as taught in Japanese Patent Publication 62-284496 to Akashi (the "Akashi Patent").

19. In view of the foregoing, I have determined that Napster Light embodies the elements taught in the '573 Patent. As a result, it can be concluded that Napster Light has copied the teachings of the '573 Patent.

20. Also in view of the foregoing, I have determined that the Napster system does not embody essential elements of the Freeny patent. As a result, it can be concluded that Napster Light has not copied the Freeny patent.

21. Also in view of the foregoing, I have determined that the Napster system does not embody essential elements of the Akashi patent. As a result, it can be concluded that Napster Light has not copied the Akashi patent.

18. Napster Light does not writing a digital signal from memory directly to an optical disk or digital tape, as taught in Japanese Patent Publication 62-284496 to Akashi (the "Akashi Patent").

19. In view of the foregoing, I have determined that Napster Light embodies the elements taught in the '573 Patent. As a result, it can be concluded that Napster Light has copied the teachings of the '573 Patent.

20. Also in view of the foregoing, I have determined that the Napster system does not embody essential elements of the Freeny patent. As a result, it can be concluded that Napster Light has not copied the Freeny patent.

21. Also in view of the foregoing, I have determined that the Napster system does not embody essential elements of the Akashi patent. As a result, it can be concluded that Napster Light has not copied the Akashi patent.

I further declare that all statements made herein of my own knowledge are true and that all statements made on information and belief are believed to be true; and further, that these statements are made with the knowledge that willful false statements and the like so made are punishable by fine or imprisonment, or both, under Section 1001 of Title 18 of the United States Code, and that such willful false statements may jeopardize the validity of the application or any patent issuing thereon.

26 Dec 05

Date

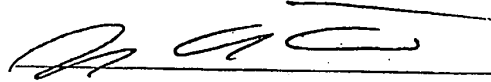

Justin Douglas Tygar, Ph.D.

RELATED PROCEEDINGS APPENDIX

- 1) *Sightsound.com Inc. v. N2K, Inc.*, 2:98-cv-00118-DWA (W.D. Pa).
-“Magistrate Judge’s Report and Recommendation” dated February 8, 2002

- 2) *Sightsound Technologies, Inc. v. ROXIO, Inc.*, 2:04-cv-01549-DWA (W.D. Pa).
- “Memorandum Order and Opinion” dated February 28, 2005, granting Defendants’
 motion to stay

- 3) Appeal from final rejection in copending reexamination Control No. 90/007,403.

- 4) Appeal from final rejection in copending reexamination Control No. 90/007,407.

CERTIFICATE OF SERVICE

The undersigned hereby certifies that a true and correct copy of the foregoing Brief on Appeal Under 37 C.F.R. § 41.37 from Final Rejection in Reexamination No. 90/007,402 was served via First Class United States Mail, postage prepaid, this 30th day of July 2007, on the following:

Mr. Albert S. Penilla
Martine, Penilla, & Gencarella, LLP
710 Lakeway Drive, Suite 200
Sunnyvale, CA 94085
Attorney for Third Party Reexamination Requester

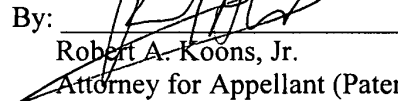
By: 
Robert A. Koons, Jr.
Attorney for Appellant (Patentee)



UNITED STATES PATENT AND TRADEMARK OFFICE

UNITED STATES DEPARTMENT OF COMMERCE
United States Patent and Trademark Office
Address: COMMISSIONER FOR PATENTS
P.O. Box 1450
Alexandria, Virginia 22313-1450
www.uspto.gov

APPLICATION NO.	FILING DATE	FIRST NAMED INVENTOR	ATTORNEY DOCKET NO.	CONFIRMATION NO.
90/007,402	01/31/2005	5191573	NAPS001	2998

23973 7590 01/17/2008

DRINKER BIDDLE & REATH
ATTN: INTELLECTUAL PROPERTY GROUP
ONE LOGAN SQUARE
18TH AND CHERRY STREETS
PHILADELPHIA, PA 19103-6996

EXAMINER

ART UNIT PAPER NUMBER

DATE MAILED: 01/17/2008

Please find below and/or attached an Office communication concerning this application or proceeding.



DO NOT USE IN PALM PRINTER

(THIRD PARTY REQUESTER'S CORRESPONDENCE ADDRESS)

Albert S. Penilla
Martine Penilla & Gencarella, LLP
710 Lakeway Drive, Suite 200
Sunnyvale, CA 94085

EX PARTE REEXAMINATION COMMUNICATION TRANSMITTAL FORM

REEXAMINATION CONTROL NO. 90/007,402.

PATENT NO. 5191573.

ART UNIT 3992.

Enclosed is a copy of the latest communication from the United States Patent and Trademark Office in the above identified *ex parte* reexamination proceeding (37 CFR 1.550(f)).

Where this copy is supplied after the reply by requester, 37 CFR 1.535, or the time for filing a reply has passed, no submission on behalf of the *ex parte* reexamination requester will be acknowledged or considered (37 CFR 1.550(g)).

Notification of Non-Compliant Appeal Brief (37 CFR 41.37)	Application No. 90/007,402	Applicant(s) 5191573	
	Examiner Roland G. Foster	Art Unit 3992	

--The MAILING DATE of this communication appears on the cover sheet with the correspondence address--

The Appeal Brief filed on 30 July 2007 is defective for failure to comply with one or more provisions of 37 CFR 41.37.

To avoid dismissal of the appeal, applicant must file an amended brief or other appropriate correction (see MPEP 1205.03) within **ONE MONTH or THIRTY DAYS** from the mailing date of this Notification, whichever is longer. **EXTENSIONS OF THIS TIME PERIOD MAY BE GRANTED UNDER 37 CFR 1.136.**

1. The brief does not contain the items required under 37 CFR 41.37(c), or the items are not under the proper heading or in the proper order.
2. The brief does not contain a statement of the status of all claims, (e.g., rejected, allowed, withdrawn, objected to, canceled), or does not identify the appealed claims (37 CFR 41.37(c)(1)(iii)).
3. At least one amendment has been filed subsequent to the final rejection, and the brief does not contain a statement of the status of each such amendment (37 CFR 41.37(c)(1)(iv)).
4. (a) The brief does not contain a concise explanation of the subject matter defined in each of the independent claims involved in the appeal, referring to the specification by page and line number and to the drawings, if any, by reference characters; and/or (b) the brief fails to: (1) identify, for each independent claim involved in the appeal and for each dependent claim argued separately, every means plus function and step plus function under 35 U.S.C. 112, sixth paragraph, and/or (2) set forth the structure, material, or acts described in the specification as corresponding to each claimed function with reference to the specification by page and line number, and to the drawings, if any, by reference characters (37 CFR 41.37(c)(1)(v)).
5. The brief does not contain a concise statement of each ground of rejection presented for review (37 CFR 41.37(c)(1)(vi)).
6. The brief does not present an argument under a separate heading for each ground of rejection on appeal (37 CFR 41.37(c)(1)(vii)).
7. The brief does not contain a correct copy of the appealed claims as an appendix thereto (37 CFR 41.37(c)(1)(viii)).
8. The brief does not contain copies of the evidence submitted under 37 CFR 1.130, 1.131, or 1.132 or of any other evidence entered by the examiner **and relied upon by appellant in the appeal**, along with a statement setting forth where in the record that evidence was entered by the examiner, as an appendix thereto (37 CFR 41.37(c)(1)(ix)).
9. The brief does not contain copies of the decisions rendered by a court or the Board in the proceeding identified in the Related Appeals and Interferences section of the brief as an appendix thereto (37 CFR 41.37(c)(1)(x)).
10. Other (including any explanation in support of the above items):

Reference to unentered information is not permitted in the Appeal Brief. See 37 CFR § 41.37(c)(1)(ix). See also MPEP § 1205.02.(ix). The instant Appeal Brief refers to unentered evidence, such as a "March 17, 2007" (in actuality a May 17, 2007) Declaration of Dr. J. Douglas Tygar, which is cited and discussed, for example, on pages 34 and 35 of the Brief. Furthermore, the "Evidence Appendix" to the Brief cites to the 2007 Tygar Declaration and to an IEEE article submitted May 17, 2007. For reasons why the above identified evidence was not entered, see the Advisory Action, mailed July 30, 2007.

Conferee
SW
ESK

Roland G. Foster
Primary Examiner
Art Unit: 3992

Express Mail No.: EV 299882953 US

Control No.: 90/007,402

Attorney's Docket No. NAPS001

Patent

IN THE UNITED STATES PATENT AND TRADEMARK OFFICE

In re Application of: Arthur R. Hair	:	Group No.: 3992
	:	
Serial No.: 90/007,402	:	Examiner: Roland G. Foster
	:	
Filed: January 31, 2005	:	Confirmation No. 2998
	:	

For: METHOD FOR TRANSMITTING A DESIRED DIGITAL VIDEO OR AUDIO SIGNAL

AMENDED BRIEF ON APPEAL UNDER 37 C.F.R. § 41.37

Mail Stop Appeal Brief - Patents
Commissioner for Patents
P.O. Box 1450
Alexandria, VA 22313-1450

Real Party in Interest

Appellant's real party in interest is:

DMT Licensing, LLC (a wholly-owned subsidiary of GE Intellectual Property
Licensing, Inc., which is a wholly-owned subsidiary of General
Electric Co.)
105 Carnegie Center
Princeton, New Jersey 08540

Related Appeals and Interferences

The Appeals in copending reexaminations 90/007,403 and 90/007,407 are related to the instant Appeal. The outcomes in these copending Appeals may affect, be affected by, or have some bearing on the Board's decision in the instant Appeal.

Status of the Claims

Claims 1 through 6 and 44 through 49 are currently pending. Claims numbered 1 to 6 were originally issued in U.S. Patent 5,191,573 (the "573 Patent"). Claims 7 through 43 were

added during reexamination and subsequently canceled following the vacating of the Office Action issued by the United States Patent and Trademark Office (the "Office") on March 20, 2006 finally rejecting all of the claims in reexamination. Claims 44 through 49 were added in the Response to the Non-Final Office Action issued on September 29, 2006.

Claims 1 through 6 and 44 through 49 are rejected under 35 U.S.C. § 112, first paragraph. Claims 1, 2, 4, 5, 44, 45, 47 and 48 are rejected under 35 U.S.C. § 102(e). Claims 1 through 6 and 44 through 49 are rejected under 35 U.S.C. § 103(a).

Appellant appeals the rejection of all claims.

Status of Amendments

All amendments have been entered.

Summary of the Claimed Subject Matter

Claims 1, 4, 44 and 47 are the independent claims. Below, Appellant summarizes the claimed subject matter in the independent claims per 37 C.F.R. § 41.37(c)(1)(v) using references to the Figures and column and line numbers in the issued patent.

Independent Claim 1 recites a method for transmitting a desired digital audio signal stored on a first memory of a first party to a second memory of a second party [Abstract]. The method comprises the steps of transferring money electronically via a telecommunication line to the first party at a location remote from the second memory and controlling use of the first memory from the second party, the second party being financially distinct from the first party [col. 2, lns. 63 to 67; col. 3, lns. 6 to 7; col. 5, lns. 32 to 34], and the second party controlling use and in possession of the second memory [col. 2, lns. 40 to 47; col. 3, lns. 12 to 17; col. 3, lns. 52 to 59]. The method further comprises connecting electronically via a telecommunications line the first memory with the second memory such that the desired digital

audio signal can pass there-between [Fig. 1; col. 2, lns. 51 to 67; col. 3, lns. 8 to 12], transmitting the desired digital audio signal from the first memory with a transmitter in control and possession of the first party to a receiver having the second memory at a location determined by the second party, said receiver in possession and control of the second party [Figure 1; col. 2, lns. 51 to 67; col. 3, lns. 13 to 19 and 60 to 67; col. 4, lns. 25 to 44] and storing the digital signal in a non-volatile storage portion of the second memory, wherein the non-volatile storage portion is not a tape or CD [col. 2, lns. 31 to 35; col. 3, lns. 17 to 19; col. 4, lns. 41 to 43].

Independent Claim 4 recites a method for transmitting a desired digital video signal stored on a first memory of a first party to a second memory of a second party [Abstract]. The method comprises the steps of transferring money electronically via a telecommunications line to the first party at a location remote from the second memory and controlling use of the first memory from a second party financially distinct from the first party [col. 2, lns. 63 to 67; col. 3, lns. 6 to 7; col. 5, lns. 32 to 34], said second party in control and in possession of the second memory [col. 2, lns. 40 to 47; col. 3, lns. 12 to 17; col. 3, lns. 52 to 59]. The method further comprises connecting electronically via a telecommunications line the first memory with the second memory such that the desired digital video signal can pass there-between [Figure 1; col. 2, lns. 51 to 67; col. 3, lns. 8 to 12, col. 5, ln. 67 to col. 6, ln. 2], transmitting the desired digital video signal from the first memory with a transmitter in control and possession of the first party to a receiver having the second memory at a location determined by the second party, said receiver in possession and control of the second party [Figure 1; col. 2, lns. 51 to 67; col. 3, lns. 13 to 19 and 60 to 67; col. 4, lns. 25 to 44; col. 5, ln. 67 to col. 6, ln. 2] and storing the digital

signal in a non-volatile storage portion of the second memory, wherein the non-volatile storage portion is not a tape or CD [col. 2, lns. 31 to 35; col. 3, lns. 17 to 19; col. 4, lns. 41 to 43].

Independent claim 44 recites a method for transmitting a desired digital audio signal stored on a first memory of a first party to a second memory of a second party [Abstract; col. 5, ln. 67 to col. 6, ln. 2]. The method comprises the steps of transferring money electronically via a telecommunications line to the first party at a location remote from the second memory and controlling use of the first memory from the second party financially distinct from the first party [col. 2, lns. 63 to 67; col. 3, lns. 6 to 7; col. 5, lns. 32 to 34], said second party controlling use and in possession of the second memory [col. 2, lns. 40 to 47; col. 3, lns. 12 to 17; col. 3, lns. 52 to 59]. The second memory includes a second party hard disk [Fig. 1 (60); col. 3, ln. 57]. The method further comprises connecting electronically via a telecommunications line the first memory with the second memory such that the desired digital audio signal can pass therebetween [Fig. 1 (20B, 30, 50B); col. 2, lns. 51 to 67; col. 3, lns. 8 to 12], transmitting the desired digital audio signal from the first memory with a transmitter in control and possession of the first party to a receiver having the second memory at a location determined by the second party, said receiver in possession and control of the second party [Figure 1; col. 2, lns. 51 to 67; col. 3, lns. 13 to 19 and 60 to 67; col. 4, lns. 25 to 44] and storing the digital signal in the second party hard disk [col. 3, lns. 17 to 19; col. 4, lns. 41 to 43].

Independent Claim 47 recites a method for transmitting a desired digital video signal stored on a first memory of a first party to a second memory of a second party [Abstract; col. 5, ln. 67 to col. 6, ln. 2]. The method comprises the steps of transferring money electronically via a telecommunications line to the first party at a location remote from the second memory and controlling use of the first memory from the second party financially distinct from the first party

[col. 2, lns. 63 to 67; col. 3, lns. 6 to 7; col. 5, lns. 32 to 34], said second party controlling use and in possession of the second memory [col. 2, lns. 40 to 47; col. 3, lns. 12 to 17; col. 3, lns. 52 to 59]. The second memory includes a second party hard disk [Fig. 1 (60); col. 3, ln. 57]. The method further comprises connecting electronically via a telecommunications line the first memory with the second memory such that the desired digital video signal can pass there-between [Figure 1; col. 2, lns. 51 to 67; col. 3, lns. 8 to 12, col. 5, ln. 67 to col. 6, ln. 2], transmitting the desired digital video signal from the first memory with a transmitter in control and possession of the first party to a receiver having the second memory at a location determined by the second party, said receiver in possession and control of the second party [Figure 1; col. 2, lns. 51 to 67; col. 3, lns. 13 to 19 and 60 to 67; col. 4, lns. 25 to 44; col. 5, ln. 67 to col. 6, ln. 2] and storing the digital signal in the second party hard disk [col. 3, lns. 17 to 19; col. 4, lns. 41 to 43].

Grounds for Rejection to be Reviewed on Appeal

1. Examiner's rejection of Claims 1, 2, 4, 5, 44, 45, 47 and 48 under 35 U.S.C. § 102(e) and 35 U.S.C. § 103(a) over U.S. Patent 4,949,187 to Cohen (*Cohen*). In particular, Appellant seeks review of the Examiner's assertion that the '573 Patent is not entitled to the filing date of June 13, 1988, the assertion having to be correct before *Cohen* could be cited as a prior art reference.
2. Examiner's rejection of Claims 3, 6, 46 and 49 under 35 U.S.C. § 103(a) over *Cohen* in view of U.S. Patent 4,789,863 to Bush (*Bush*). In particular, Appellant seeks review of the Examiner's assertion that the '573 Patent is not entitled to the filing date of June 13, 1988, the assertion having to be correct before *Cohen* could be cited as a prior art reference.

3. Examiner's rejection of Claims 1 through 6 and 44 through 49 under 35 U.S.C. § 103(a) over *Bush* in view of *Cohen*. In particular, Appellant seeks review of the Examiner's assertion that the '573 Patent is not entitled to the filing date of June 13, 1988, the assertion having to be correct before *Cohen* could be cited as a prior art reference.
4. Examiner's rejection of Claims 1 through 6 and 44 through 49 under 35 U.S.C. § 103(a) over *Bush* in view of U.S. Patent 4,837,797 to Freeny (*Freeny I*).
5. Examiner's rejection of Claims 1 through 6 and 44 through 49 under 35 U.S.C. § 103(a) over Japanese Patent Application No. 62-284496 to Akashi (*Akashi*) in view of U.S. Patent 4,528,643 to Freeny (*Freeny II*).
5. Examiner's rejection of Claims 1 through 6 and 44 through 49 under 35 U.S.C. § 112, first paragraph as not being supported by the written description in the specification.
6. Examiner's rejection of Claims 4 through 6 and 47 through 49 under 35 U.S.C. § 112, first paragraph as not being enabled by the specification.

Argument

I. Summary

The instant reexamination was originally filed on January 31, 2005, and was initially assigned to Examiner Benjamin Lanier ("Examiner Lanier"). The reexamination and two related copending reexaminations subsequently were transferred to the Central Reexamination Unit ("CRU") where they were assigned to Examiner Roland Foster ("Examiner Foster").

During the course of the proceedings in the instant reexamination, five Office Actions were issued. The first three Office Actions were issued by Examiner Lanier, who consistently rejected all claims presented by Appellant as obvious. In each case, Examiner Lanier relied on combinations of up to nine references in his obviousness analyses, offering only conclusory

statements regarding the motivation or teaching to combine the multiple references. In each case, the Appellant pointed out the impropriety of the combinations. Examiner Lanier never rebutted the Appellant's arguments. Instead, Examiner Lanier simply asserted that the rejections were proper.

Following the issuance of the third Office Action by Examiner Lanier, the instant reexamination was transferred to the CRU, specifically to Examiner Foster, where the Office reviewed and vacated Examiner Lanier's Final Rejection of the claims. The Office appeared to concur with the Appellant's view that the rejections offered by Examiner Lanier were untenable, but the Office did not allow the claims. Instead, the Office issued two subsequent Office Actions.

The two subsequent Office Actions take an alternate approach which, since also improper, has led to this appeal. Instead of relying on up to nine references, these subsequent Office Actions relied primarily on references that post-dated the June 13, 1988 priority date for the '573 Patent. In other words, the Office Actions relied on non-*prior* art. To justify this, the Office first had to conduct a *de novo* review of the '573 Patent's prosecution and then, based on that review, reassign the '573 Patent's June 13, 1988 priority date; a priority date that was rightfully granted by the original Examiner during the initial examination of the '573 Patent. In taking those steps, the Office reassigned the priority date to September 18, 1990. Then, using this new priority date, the Office cited new art post-dating the June 13, 1988 priority date, which the Office asserts anticipates or makes obvious all of the claims in reexamination.

As detailed below, this *de novo* review and resulting reassignment of the priority date is clearly outside the scope of authority of the Office as granted by the Reexamination Statute. 35

USC § 301, *et seq.* Further, the attempted reassignment of a new priority date to the '573 Patent does not comport with Office procedures.

Further, as a predicate for reassigning the priority date of the claims in the '573 Patent, the Office asserts that the claims as issued are either not supported by a written description or are not enabled by the specification as filed on June 13, 1988. In making these findings, the Office has applied improper and overly strict standards for both written description and enablement under 35 U.S.C. § 112, first paragraph. Using the appropriate standards, Appellant has demonstrated that the claims in reexamination are fully supported and enabled by the originally filed specification, and are thus entitled to the priority date of June 13, 1988.

Where the Office has presented obviousness rejections relying solely on references that do qualify as prior art based on the proper June 13, 1988 priority date, the Office has failed to present a reasoned argument showing a teaching or motivation to combine the references, as required by *KSR Int'l Co. v. Teleflex Inc.*, 127 S. Ct. 1727 (U.S. 2007). Further, as demonstrated by Appellant, these references do not show each and every limitation of the claims in reexamination. As a result, the Office has not established a *prima facie* case of obviousness based on those references that are proper prior art.

The Office has also rejected Claims 1 through 6 and 44 through 49 in reexamination under 35 U.S.C. § 112, first paragraph, as not being supported by an adequate written description and as not being enabled by the specification. Here again, Appellant maintains that the Office has acted outside the mandated scope of reexamination by examining Claims 1 through 6 and 44 through 49 in their entirety for compliance with section 112, first paragraph, rather than limiting the analysis to newly claimed subject matter. Further, the Office has again applied improper standards for both written description support and enablement. Using the

appropriate standards, Appellant has demonstrated that the claims in reexamination do comply with the requirements section 112, first paragraph.

Since many of the positions taken by the Office in finally rejecting Claims 1 through 6 and 44 through 49 rely on a revisiting of issues dealt with during the original examination of the '573 Patent, it is appropriate here to summarize the prosecution history of the '573 Patent.

Appellant's arguments herein will refer to the summary provided in Section II below.

II. Prosecution History of the '573 Patent

The '573 Patent issued from U.S. Patent Application Serial No. 07/586,391 (the "'391 Application'"), which was filed as a continuation of U.S. Patent Application Serial No. 07/206,497 (the "'497 Application'"). The '497 Application was originally filed on June 13, 1988 by Arthur Hair as a *pro se* applicant.¹ In the period after the initial filing of the '497 Application, Mr. Hair retained Ansel M. Schwartz as patent counsel. The Application was assigned to Examiner Hoa T. Nguyen ("Examiner Nguyen").

On December 19, 1988, Mr. Schwartz filed a preliminary amendment canceling original Claims 1 through 10 in the '497 Application and replacing them with new Claims 11 through 13, which read as follows:

11. A method for transmitting a desired digital audio music signal stored on a first memory to a second memory comprising the steps of:
transferring money to a party controlling use of the first memory
from a party controlling use of the second memory;
connecting electronically the first memory with the second
memory such that the desired digital signal can pass therebetween;
transmitting the digital signal from the first memory to the second
memory; and
storing the digital signal in the second memory. (emphasis added).

¹ The application which became the '497 Application was actually mailed on June 9, 1988. However, since Mr. Hair was unaware of the use of Express Mail, the application was accorded the date that it actually was received at the Office.

12. A method as described in Claim 11, including after the transferring step, the steps of searching the first memory for the desired digital audio signal; and selecting the desired digital audio signal from the first memory. (emphasis added).

13. A method as described in Claim 12 wherein the transferring step includes the steps of telephoning the party controlling use of the first memory by the party controlling the second memory; providing a credit card number of the party controlling the second memory to the party controlling the first memory so that the party controlling the second memory is charged money.

The first Office Action in the '497 Application was issued on November 15, 1988 on the basis of Claims 11 to 13 added by the preliminary amendment. All of the claims were rejected as anticipated by U.S. Patent 3,718,906. Mr. Schwartz responded to the Office Action on February 26, 1990. In this response, Claims 14 through 20 were added. Exemplary Claims 14 and 15 read as follows:

14. A method as described in Claim 11 wherein the transmitting step includes the step of transmitting the digital signal from the first memory to the second memory at a location determined by the second party controlling use of the second memory. (emphasis added)

15. A method for transmitting a desired a digital video or audio music signal stored on a first memory to a second memory comprising the steps of:

- charging a fee to a first party controlling use of the second memory;
- connecting the first memory with the second memory such that the digital signal can pass therebetween;
- transmitting the digital signal from the first memory to the second memory; and
- storing the digital signal in the second memory. (emphasis added)

The second Office Action in the '497 Application was issued on May 10, 1990 on the basis of Claims 11 to 20. All of the claims were rejected as anticipated by either of U.S. Patent 3,718,906 or 3,990,710. Mr. Schwartz responded to this Office Action on August 21, 1990. In this response, Claims 11, 12 and 15 were amended and Claim 21 was added. Claims 14 and 16

to 20 were canceled. Claims 11 and 15 were amended by including the recitation of a “transmitter” and a “receiver.” New Claim 21 read identically to Claim 12, except that it depended from independent Claim 15. On September 9, 1990, Examiner Nguyen issued an Advisory Action indicating that the amendments would not be entered.

The amendment was resubmitted with a File Wrapper Continuation and subsequently entered. The File Wrapper Continuation was assigned application serial number 07/586,391 (the “‘391 Application”). The ‘391 Application was filed as a **continuation** of the parent ‘497 Application and claimed priority to the June 13, 1988 filing date. In fact, due to a clerical error, Mr. Schwartz was required to revive the ‘497 Application as unintentionally abandoned for the express purpose of establishing copendency with the ‘391 Application so that a proper claim for priority could be made. No new oath was required by the Office when the ‘391 Application was filed.

The first Office Action in the ‘391 Application was issued on September 9, 1991 on the basis of Claims 11 to 13, 15 and 21. All of the claims were rejected as obvious over U.S. Patent 3,990,710. Mr. Schwartz responded to this Office Action on December 9, 1991. In this response, Claims 11 and 15 were amended to recite that the first party location was remote from the second party location. Claim 15 was further amended to delete the reference to digital audio signals. Claim 22 was added, and was essentially identical to Claim 13, but depended from Claim 21. In addition to the claim amendments, text was added to pages 3 and 5 of the specification.

The next Office Action in the ‘391 Application was issued on February 24, 1992 on the basis of Claims 11 to 13, 15, 21 and 22. In the Office Action, Examiner Nguyen explicitly objected to the amendments to the specification and rejected all of the claims as being

unsupported by the originally filed specification. *See* pages 5 to 6 of the February 24, 1992

Office Action. Examiner Nguyen specifically pointed out the following as not having a basis in the original specification:

- (1) “transferring money”
- (2) “second party financially distinct from the first party”
- (3) “in the controlling step ‘receiver in possession...of the second party’”
- (4) “telephoning”
- (5) “providing a credit card”

The specification was objected to “as originally filed, failing to provide clear support for the amendments to pages 3 and 5.” The amendments to pages 3 and 5 encompassed the entirety of the amendments to the specification. Claims 11 to 13, 15, 21 and 22 were also rejected as obvious over U.S. Patent 3,990,710.

Mr. Schwartz responded to this Office Action on June 23, 1992. In this response, the amendments to the specification adding text at pages 3 and 5 were withdrawn. A substitute specification was submitted to address formal issues. Further, a new amendment to the specification was presented adding a new Abstract and adding text at page 6 and page 12 of the substitute specification. Claims 11 and 15 were amended to recite “transferring money electronically via a telecommunications line” and “connecting electronically via a telecommunications line.” Claim 15 was again amended to delete “audio.” Claim 23 was added.

In addition to the amendments and arguments filed with the Office Action response on June 23, 1992, Mr. Schwartz also filed a Declaration by Arthur Hair under 37 C.F.R. § 1.132 indicating that one of ordinary skill in the art would recognize that all of the terminology presented in the claims and specification by amendment was supported by the originally filed specification.

The next Office Action in the '391 Application was issued on September 21, 1992 on the basis of Claims 11 to 13, 15 and 21 to 23. The Office Action indicated that Claims 11 to 13, 15, 21 and 22 were allowable based on the response filed on June 23, 1992. Claim 23 was rejected. Mr. Schwartz responded to this Office Action on September 30, 1992 by canceling rejected Claim 23. The Examiner proceeded to issue a Notice of Allowance and Issue Fee Due on October 19, 1992. The Issue Fee was paid on December 4, 1992 and the '391 Application duly issued as the '573 Patent on March 2, 1993.

III. THE APPROPRIATE PRIORITY DATE FOR THE CLAIMS OF THE '573 PATENT IN REEXAMINATION IS JUNE 13, 1988

As set forth in Section II above, the '573 Patent issued from U.S. Patent Application Serial No. 07/586,391 (the "'391 Application'"), which was filed as a continuation of U.S. Patent Application Serial No. 07/206,497 (the "'497 Application'"). The Office admits the '573 Patent is not a continuation-in-part, but asserts that the '573 Patent "shares the characteristics of a continuation-in-part." The Office now attempts to use this novel characterization of the '573 Patent as a pretext to re-examine the priority date of the claims in the '573 Patent, which Examiner Nguyen had properly awarded as June 13, 1988. In particular, the Office is attempting to improperly reassign a priority date of September 18, 1990 to the claims in reexamination.

The Office's actions in reassigning a priority date are improper procedurally, and incorrect based on the prosecution history of the '573 Patent. In the first instance, the reexamination statutes do not empower the Office to examine claims for issues of effective priority date in the absence of a continuation-in-part in the original examination history. On this basis alone, the Board should vacate the Examiner's findings with respect to the proper priority date of the claims in the '573 Patent. Even if the Board does not vacate the Examiner's findings

on this basis, the Board should vacate the Examiner's findings because the issue was thoroughly dealt with by Examiner Nguyen during the initial examination of the '573 Patent, and thus does not present a new issue related to patentability. Even putting those arguments aside, the Board should vacate the Examiner's findings with respect to priority because the claims as issued in the '573 Patent and as currently constituted in reexamination are clearly supported by the original specification filed on June 13, 1988.

A. The Office Exceeded Its Statutory Authority In Considering Issues Of Priority In The Instant Reexamination

The Office exceeded its statutory authority by considering issues of priority in the instant reexamination. It is well established that the scope of a reexamination proceeding is limited to whether claims are patentable under 35 U.S.C. §§ 102 and 103 "on the basis of patents and printed publications." 37 C.F.R. § 1.552. The reexamination rules explicitly preclude consideration of issues arising under 35 U.S.C. § 112, except "with respect to subject matter added or deleted in the reexamination proceeding." *Id.*; see also *In re Etter*, 756 F.2d 852, 856 (Fed. Cir. 1985) (*en banc*) ("only new or amended claims are also examined under 35 U.S.C. §§ 112 and 132").

Moreover, the inquiry under Section 120 as to whether the language of a particular claim, as filed or amended during an original prosecution, was supported or unsupported by sufficient disclosure is, by definition, not a *new* question. Rather, it is an issue that necessarily arises at the time of original filing or amendment, and one that necessarily is before the original examiner. Where a continuation-in-part ("CIP") appears in the prosecution history of a patent in reexamination, it may be necessary to make an inquiry into whether claims in the CIP, as issued or amended in reexamination, find support in the originally filed parent application or rely on new matter added when the CIP was filed during the original prosecution of the patent.

However, where no CIP appears in the record this issue cannot arise since by definition no new matter was found to be added during the original prosecution of the patent in question.

As a result, it is beyond the scope of reexamination for an examiner to make a threshold determination that new matter was added during the original examination of a patent in reexamination in the absence of a recognition of such new matter in the record of the original examination of the patent in question.

1. There Is No CIP In The Prosecution History Of The '573 Patent

The Office admits the '573 Patent is not a continuation-in-part, but then asserts the '573 Patent "shares the characteristics of a continuation-in-part," and cites this as a basis for assigning a later priority date to the claims of the '573 Patent. The Office points to text added to the specification of the '391 Application that was not found in the originally filed specification in the '497 Application as grounds for this new designation. The Office further cites MPEP § 201.11 to support its conclusion. However, the presence of additional or different text in the specification of a continuation application does not by itself render the continuation application a CIP. The prohibition of MPEP § 201.11 concerns addition of text that would constitute *new matter*.

As set forth in Section II above, the '391 Application was filed under the old File Wrapper Continuation procedure. According to MPEP § 201.06(b), in effect at the time, if the '391 Application had been filed as a CIP a new oath or declaration would have been required; none was required. Therefore, no CIP appears in the history of the original prosecution of the '573 Patent.

Further, the Office has cited no authority that empowers it, in the context of reexamination, to treat a continuation application as a CIP because the examiner in

reexamination believes the continuation “shares characteristics of a continuation-in-part.” An application or patent is either a continuation-in-part, or it is not. There simply is no designation in the statutes or regulations for patents that are continuations, but “share the characteristics of continuations-in-part”, as asserted by the Office. Therefore, the Office has no statutory basis for reassigning the priority date for the ‘573 Patent.

2. The Reexamination Statute Does Not Empower The Office To Address Issues Of Priority Under 35 U.S.C. § 120 In The Absence Of A CIP Application In The Prosecution History Of A Patent In Reexamination

The Office relies on MPEP §§ 2258(I)(C) and 2217 for an implicit grant of authority to cite intervening art based upon a newly determined effective filing date for claims. The Office refers to two cases: *In re Ruscetta*, 255 F.2d 687 (C.C.P.A. 1958) and *In re van Langenhoven*, 458 F.2d 132 (C.C.P.A. 1972), cited in MPEP § 2258(I)(C) as granting the underlying authority to address issues under 35 U.S.C. § 120 in reexamination. The Office’s reliance on *Ruscetta* and *van Langenhoven* is misplaced. Both *Ruscetta* and *van Langenhoven* deal explicitly with patents issued from CIP applications, which as discussed *supra*, is simply not the case in the present reexamination. Further, both cases pre-date the reexamination statute, and thus say nothing about the proper conduct of reexamination proceedings. The Office has cited no further authority to support its interpretation of *Ruscetta* or *van Langenhoven*. Moreover, the Office cannot expand the holdings of these cases simply by inserting references to them in MPEP sections dealing with the scope of reexamination. “The MPEP sets forth PTO procedures; it is not a statement of law.” *Regents of the Univ. of New Mexico v. Knight*, 321 F.3d 1111, 1121 (Fed. Cir. 2003).

In contrast to the present case, where a CIP application appears in the prosecution history of a patent in reexamination, it is appropriate to consider the issue of the effective priority date

of a claim in reexamination, since it is recognized that a CIP application may introduce new matter not disclosed in its parent application. However, where no CIP appears in the original prosecution record, the examiner in reexamination has no basis for determining that new matter was added during the original prosecution. Further, the limited scope of reexamination prohibits the examiner from undertaking this analysis on his own initiative.

3. MPEP § 2258.IV.E Does Not Empower The Office To Revisit The Issue Of The Entitlement To A Priority Date Of Claims In An Issued Patent

The Office cites MPEP § 2258.IV.E as an example of revisiting priority issues in reexamination. However, most of this section addresses only the procedural issues in reexamination for perfecting a claim for priority made previously during initial examination and does not address the merits of a claim for priority.

The cited section also deals with claiming priority under 35 U.S.C. § 120 to an earlier filed copending application during reexamination where there was an earlier *failure* to make such a claim. In the instant case, a claim of priority of June 13, 1988 was made by the applicant. Examiner Nguyen determined the '573 Patent was in fact entitled to that priority date. Since a claim of priority is, by definition, before the Examiner when it is made, it can never be a new issue in reexamination; *i.e.* an issue that the original Examiner had no reason to consider. Indeed, MPEP § 201.11, cited favorably by the Office, *requires* an Examiner to address the issue during initial examination.

Further, MPEP § 2258.IV.E does not address revisiting and removing an earlier claim of priority made in an application, and does not address the entitlement of an issued patent to an earlier claimed right of priority.

Finally, MPEP § 2258.IV.E addresses reexaminations initiated by the Appellant. The section does not empower the Office to address the issue of entitlement to a claimed priority date where the issue is not first raised by the Appellant.

The Office also cites MPEP § 1402, which concerns reissue proceedings, as an example of addressing priority issues. However, again, the cited section deals with adding or changing claims of priority, where an earlier claim contained an error or was not made at all. While MPEP § 1405 does address deletion of a priority claim in reissue, that section does not empower the Office on its own to determine the propriety of the priority claim.

Finally, 37 C.F.R. § 1.552(c) is explicit about the scope of re-examination:

Issues other than those indicated in paragraphs (a) and (b) of this section *will not be resolved in a reexamination proceeding*. If such issues are raised by the patent owner or third party requester during a reexamination proceeding, the existence of such issues will be noted by the examiner in the next Office action, in which case *the patent owner may consider the advisability of filing a reissue application to have such issues considered and resolved*.

37 C.F.R. § 1.552(c) (emphasis added). Therefore, notwithstanding MPEP § 1405, the propriety of a previously made priority claim cannot be revisited by the Office during reexamination.

B. The Priority Date For The Claims In The '573 Patent Is Not A New Issue Related To Patentability

Even if the reexamination statute did provide authority to address the issue of priority in reexamination, which it does not, the Office is still barred from considering the issue with respect to the '573 Patent because it does not present a new issue related to patentability.

1. Examiner Nguyen Assigned A Priority Date Of June 13, 1988 To The Claims In The '573 Patent

During initial examination of the '573 Patent, the '391 Application was filed as a **continuation** of the '497 Application and thus, as a preliminary matter, was entitled to the filing date of the original application, June 13, 1988. The Office makes much of the fact that the '391 Application was filed pursuant to the old File Wrapper Continuation procedure, which permitted the filing of CIPs. However, as set forth above, MPEP § 201.06(b), in effect at the time the '391 Application was filed, required that a CIP application filed pursuant to the File Wrapper Continuation procedure include a new oath or declaration. Since Examiner Nguyen did not require a new oath or declaration, as a threshold matter she assigned the priority date of June 13, 1988 to the '391 Application when it was filed.

Notwithstanding this, the Office has asserted that Examiner Nguyen did not consider or have reason to consider the issue of whether the additions to the specification constituted new matter. In support of these assertions, Examiner Foster provided a chart in the Office Action of September 29, 2006, showing when and under what circumstances additions to the specification and resulting claim amendments were made in the '497 and '391 Applications.

Appellant responded to this assertion by reproducing the Examiner's chart in amended form to demonstrate that Examiner Nguyen did in fact consider the various additions to the specification and concluded those additions did not constitute new matter and the subject claims therefore were supported under Section 112. The chart has been amended by adding three columns, subtitled respectively: "Consideration by Examiner Nguyen," "Response by Applicant," and "Subsequent Action by Examiner Nguyen." That chart is set forth below:

	Parent Application 07/206,497 filed June 13, 1988		Child Application 07/586,391 filed September 18, 1990		Office Action in Application 07/586,391 and response		Issuance of '573 Patent
Feature	Date First Appearing in Claims of Parent Application	Date First Appearing in Specification of Parent Application	Date First Appearing in Claims of Child Application	Date First Appearing in Specification of Child Application	Consideration by Examiner Nguyen	Response by Applicant	Subsequent Action by Examiner Nguyen
Transferring Money from Second Party to a First Party (Charging a Fee)	December 22, 1988 February 28, 1990			September 18, 1990	Considered in Office Action February 24, 1992	Objection/ rejections specifically responded to in June 25, 1992 response	Claims allowed in September 21, 1992 Office Action
Providing a Credit Card Number	December 22, 1988			September 18, 1990	Considered in Office Action February 24, 1992	Objection/ rejections specifically responded to in June 25, 1992 response	Claims allowed in September 21, 1992 Office Action
Controlling Use of First/Second Memory	December 22, 1988			September 18, 1990	Considered in Office Action February 24, 1992	Objection/ rejections responded to in June 25, 1992 response	Claims allowed in September 21, 1992 Office Action
Transmitting to a Location Determined by Second Party	February 28, 1990			September 18, 1990	Considered in Office Action February 24, 1992	Objection/ rejections responded to in June 25, 1992 response	Claims allowed in September 21, 1992 Office Action
Specific Video Download Procedures	February 28, 1990			September 18, 1990	No new matter issues were ever raised	No response was ever necessary since no issue was ever raised	Claims allowed in September 21, 1992 Office Action

First Party in Possession of Transmitter	August 24, 1990 (not entered)			September 18, 1990	Considered in Office Action February 24, 1992	Objection/rejections responded to in June 25, 1992 response	Claims allowed in September 21, 1992 Office Action
Second Party in Possession of Receiver and Second Memory	August 24, 1990 (not entered)			September 18, 1990	Considered in Office Action February 24, 1992	Objection/rejections specifically responded to in June 25, 1992 response	Claims allowed in September 21, 1992 Office Action

The foregoing chart shows that, following submission of the subject additions to the specification and corresponding amendments to the claims, Examiner Nguyen considered those additions and amendments in the Office Action of February 24, 1992. That consideration included an objection to the specification as containing new matter under Section 132, and corresponding rejections of the relevant claims under Section 112. The Applicant responded to, and overcame, that objection and those rejections in the Response of June 25, 1992. In that Response, the Applicant included arguments and a Declaration under 37 C.F.R. § 1.132 establishing that the additions to the specification had ample support in the originally filed specification because the subject matter of the additions was implicitly disclosed and understood by those skilled in the art.² After considering this Response by the Applicant, Examiner Nguyen withdrew the objection to the specification and the Section 112 rejections of the claims, and thereby determined the claims were allowable.

The amended chart set forth above demonstrates indisputably that Examiner Nguyen *did consider* the very same new matter and Section 112 rejections that the Office now asserts. As a

² As an ancillary matter, the Office now seems to question the persuasiveness of the Section 1.132 Declaration submitted by applicant during examination of the '391 Application. Appellant respectfully points out this is not an issue that can be addressed on reexamination. The original Examiner must be assumed to have done his job properly in the initial examination. *See Am. Hoist & Derrick Co. v. Sowa & Sons, Inc.*, 725 F.2d 1350, 1359 (Fed. Cir. 1984).

result, by definition, Examiner Nguyen determined that the claims in the '573 Patent were entitled to claim priority to the original June 13, 1988 filing date.

In the Office Action in the instant reexamination dated March 17, 2007, the Office admitted that Examiner Nguyen did in fact address the issue of the alleged new matter shown in the table above. The Office further admitted that Appellant has effectively demonstrated as much through the table submitted with Appellant's Response to the Office Action of September 29, 2006. However, the Office now asserts that Examiner Nguyen did not have an opportunity to compare all of the amendments to the claims and specification made during prosecution to the originally filed specification. The Office refers to "gradually added new matter," which the Office asserts was not addressed by Examiner Nguyen. However, the Office fails to explicitly identify what it considered the "gradually added new matter." At best, the Office merely refers generally to Table II in the Office Action dated March 17, 2007. Upon reviewing Table II in its entirety, it is apparent that the table merely contains the same alleged new matter as the table presented above. That is, Table II does include anything that could be identified as "gradually added new matter," nor does it include anything that the Office has not already admitted was reviewed and passed on by Examiner Nguyen. As a result, the Office's rejection amounts to a bogus rejection that fails to define what is meant by "gradually added new matter." *See, e.g.,* MPEP § 706.03(o) (noting that, in making a new matter rejection, an examiner is required to "identify the new matter by page and the line numbers and/or drawing figures and provide an appropriate explanation of [his/her] position"). Therefore, the rejection is improper and the Board should reverse it.

2. The Absence Of Rejections Based On Intervening References During The Initial Examination Of The '573 Patent Does Not Demonstrate Examiner Nguyen Failed To Address The Issue Of Priority

Notwithstanding the above, the Office also asserts that Examiner Nguyen never had reason to consider the propriety of the claim of priority made in the '391 Application, because no intervening references were ever cited by the Examiner. This line of argument by the Office effectively puts the rabbit in the hat by concluding that the absence of any intervening references in the record is conclusive evidence the issue of priority was never addressed by Examiner Nguyen. It is more plausible to conclude that no intervening references were cited because Examiner Nguyen properly concluded the '391 Application was entitled to the priority date of June 13, 1988. This conclusion is fully supported by the written record as detailed in Section II and Section III(B)(1) above.

3. The Office Lacks Jurisdiction To Review Again The Same Section 112 Issues Determined By Examiner Nguyen

As established above, the question of Section 112 support, and hence the appropriate priority date for the claims in the issued '573 Patent, were considered and passed on by Examiner Nguyen in the original examination. Therefore, as a matter of established law, the Office lacks jurisdiction under the facts in this proceeding to challenge again the Section 112 support and the June 13, 1988 priority date of the claims in reexamination.

In *Patlex Corp. v. Quiqq*, 680 F. Supp. 33 (D.C. Cir. 1988), the United States District Court for the District of Columbia addressed a situation substantially identical to the circumstances of the present reexamination. In that case, the District Court reversed, on summary judgment, a decision by the BPAI upholding the final rejection of three claims in a reexamination proceeding. The claims in question had issued in a patent that resulted from a string of continuation and divisional applications relating back to an original priority

application. The reexamination examiner took the position that the three claims were not entitled to the original priority date. Consequently, the reexamination examiner reassigned a later effective priority date, based on the reexamination examiner's determination that the specification had not enabled the three claims under Section 112 as of the original filing date.

The District Court determined, however, that the issue of whether the three claims were enabled under Section 112 previously had been considered and decided by the original examiner, and the Court therefore explicitly held that the reexamination examiner lacked jurisdiction to consider that issue again:

Entitlement to the ... [original priority] filing date was decided in the ... [original] examination. Plaintiffs contended then they were entitled to the [original priority] filing date, and the first Examiner considered then whether the [original] disclosure was enabling. Consequently, in order to reexamine ... [the patent] on the basis of whether the claims were anticipated by ... [later prior art], the reexamination examiner had to "reexamine" the question of whether the specification of the ... [original application] contained an enabling disclosure of the subject matter claimed in the ... [patent]. As noted above, however, the reexamination statute does not contemplate a "reexamination" of the sufficiency of a disclosure. Rather it is limited to reexamination of patentability based on prior art patents and publications. Hence, the Court concludes that the Examiner and the Board lack jurisdiction in this case to "reexamine" the sufficiency of the specification of the ... [original application].

Id. at 36-37. (Emphasis added). The holding of the *Patlex* case, therefore, is clear. Where, as in the present case, an original examiner already has considered and determined the sufficiency of a specification's disclosure under Section 112 and the resulting entitlement of claims to an original priority date, there is no "substantial new" question of patentability for reexamination, as required by 35 U.S.C. § 301, *et seq.* As a result, the Office lacks jurisdiction to "reexamine" that same issue for those same claims in a subsequent reexamination proceeding.

For this reason as well, the Board should vacate the Examiner's determinations regarding the proper priority date for the '573 Patent.

C. The Claims In The '573 Patent Plainly Are Supported By The Originally Filed Specification

The Office asserts that, for written description support, the claims in the '573 Patent rely on certain alleged new matter added to the specification during the original prosecution of the '573 Patent. The Office also asserts that the claims directed to the video embodiment of the invention are not supported by disclosure that was enabling as of the original June 13, 1988 filing date. As set forth above, Appellant's position is that the Office lacks jurisdiction to review issues of adequate written description and enablement, especially where the particular issue was dealt with explicitly in the original prosecution of the patent in reexamination. Those arguments aside, it is clear the originally filed specification does in fact provide both adequate written description for all of the claims and an enabling disclosure for those claims directed to the "video feature" of the invention.

1. The Claims As Issued In The '573 Patent Are Supported By Adequate Written Description In The Originally Filed Specification

Appellant provides below an analysis demonstrating that each element in Claims 1 through 6 as issued in the '573 Patent is supported, either explicitly or implicitly, by the original specification filed on June 13, 1988.

i) The Proper Standard For Determining If The Claims Are Adequately Supported By The Specification As Filed

As a preliminary matter, the standard for written support in the absence of *ipsis verbis* recitation of a claim limitation is not strictly the inherency or required interpretation standard urged by the Office. Rather, the proper standard generally is whether the written description

reasonably conveys to the skilled artisan that the inventor was in possession of the claimed subject matter.

The issue of whether the written description requirement has been met is a question of fact, to be determined on a case-by-case basis. *Vas-Cath, Inc. v. Mahurkar*, 935 F.2d 1555, 1562 (Fed. Cir. 1991). The legal standard for determining whether the facts of a particular case meet the written description requirement is well established, however. In *Vas-Cath*, the Court of Appeals for the Federal Circuit (“CAFC”) held that “[t]he test for sufficiency of support in a patent application is whether the disclosure of the application relied on ‘*reasonably conveys* to the skilled artisan that the inventor had possession at that time of the later claimed subject matter.’” *Vas-Cath*, 935 F.2d at 1563 (emphasis added). As further held by the CAFC in *Union Oil Co. of Cal. v. Atlantic Richfield Co.*, 208 F.3d 989 (Fed. Cir. 2000), “[t]he written description does not require the applicant ‘to describe exactly the subject matter claimed, [instead] the description must clearly allow persons of ordinary skill in the art to recognize that [the inventor] invented what is claimed.’” *Id.* at 997. In other words, contrary to the Office’s assertions, the general standard does not require that the “only reasonable interpretation” of the general features in the specification be the more specific features in the claims. *Vas-Cath*, 935 F.2d at 1566 (“[t]he [district] court further erred in applying a legal standard that essentially required the drawings of the ‘081 design application to *necessarily exclude* all diameters other than those within the claimed range.”)(emphasis in original).

Because the written description requirement is fact-based, various decision makers have at times appeared to drift from the “reasonably conveys” standard mandated by the CAFC. The CAFC, however, has never wavered from this standard. For example, in *Hyatt v. Boone*, 146 F.3d 1348 (Fed. Cir. 1998) the court reviewed a Board of Patent Appeals and Interferences

(“BPAI”) decision holding that one party to an interference (Hyatt) lacked the necessary written description in his originally filed application to support a later claim drawn to a count of the interference. The phraseology used by the BPAI in setting forth the standard for compliance with the written description requirement was that “the written description must be sufficient, when the entire specification is read that the ‘necessary and only reasonable construction’ that would be given it by a person of ordinary skill in the art is one that clearly supports each positive limitation in the count.” *Hyatt*, 146 F.3d at 1353. The appellant argued that the “necessary and only reasonable construction” standard applied by the BPAI was different from and more rigorous than the “reasonably conveys standard” set forth in *Vas-Cath*.

The CAFC determined that despite the arguably more rigorous phraseology used by the BPAI, the standard for meeting the written description requirement did not become more rigorous. Rather, the standard remains that “the written description must include all of the limitations...or the applicant must show that any absent text is *necessarily comprehended* in the description provided and would have been so understood at the time the patent application was filed.” *Hyatt*, at 1354-55 (emphasis added). Moreover, the CAFC has on subsequent occasions repeatedly reinforced that the standard of *Vas-Cath* remains in effect. *See, e.g., Pandrol USA, LP v. Airboss Ry. Prods, Inc.*, 424 F.3d 1161, 1165 (Fed. Cir. 2005) (“[t]he applicant must...convey with reasonable clarity to those skilled in the art that, as of the filing date sought, he or she was in possession of the invention.”)

In addition to *Hyatt*, the Office has cited *In re Robertson*, 169 F.3d 734 (Fed. Cir. 1999), and *Lockwood v. American Airlines, Inc.*, 107 F.3d 1565 (Fed. Cir. 1997), as establishing a strict inherency standard for finding written support for a claim element not having *ipsis verbis* support in the specification. In the first instance, the citation of *In Re Robertson* is inapposite.

In *Robertson*, the CAFC reiterated the well-known standard for determining anticipation or obviousness of a claim by prior art where the prior art does not include literal disclosure of one or more elements of the claim. As such, *Robertson* was a case directed solely to Section 102/103 issues, and does not even mention Section 112. Moreover, nowhere in *Hyatt* or *Lockwood* does either court even allude to an inherency standard for showing support for claim limitations not described *ipsis verbis* in the specification. Rather, the CAFC simply held in *Lockwood* that “exact terms need not be used *in haec verba*..., the specification must contain an equivalent description of the claimed subject matter.” *Lockwood*, 107 F.3d at 1572 (citations omitted).

Therefore, the requirement of an inherency standard under Section 112 is unsupported by *Hyatt*, *Robertson*, or *Lockwood*. Rather, the proper standard to be applied by the Examiner in determining compliance with the written description requirement remains “whether the disclosure of the application as originally filed reasonably conveys to the artisan that the inventor had possession at that time of the later claimed subject matter, rather than the presence or absence of literal support in the specification for the claim language.” *In re Kaslow*, 707 F.2d 1366, 1375 (Fed. Cir. 1983).

ii) **All Features of Claims 1 Through 6 In The ‘573 Patent Find Written Support In The Originally Filed Specification**

Applying the proper standard for compliance with the written description requirement under Section 112, all of the limitations in Claims 1 through 6 of the ‘573 Patent are supported by the originally filed specification. To illustrate this point, Appellant has prepared a detailed chart showing each feature of the invention, the claims in which those features are recited, and where support in the originally filed specification is found for each feature. That chart is set forth immediately below:

Feature	Claims Reciting Feature	Written Description of Feature in Original Specification	Comments
A method for transmitting a desired digital audio signal	1	p. 1, lns. 7-9 p. 2, lns. 8-10, 20-26	<i>ipsis verbis</i> support
stored on a first memory of a first party to a second memory of a second party	1, 4	p. 3, lns. 35-40 p. 4, lns. 12-26	The specification states <i>ipsis verbis</i> that the hard disk in the control unit of the authorized agent is the source of the digital signal. Further, the specification states that the digital signal is transferred to the hard disk in the control unit of the user. A skilled artisan would understand this as transferring signals stored on a first memory to a second memory.
transferring money via a telecommunications line to a first party location remote from the second memory	1, 4	p. 1, lns. 13-15 p. 2, lns. 8-10, 20-23, 47-50 p. 3, lns. 20-33 Fig. 1	The specification discloses electronic sales via telephone lines. Because the agent is authorized to sell and to transfer via telephone lines, there is implicit support for selling and thereby transferring money. This was previously pointed out in the declaration of Arthur Hair submitted May 5, 1992. A skilled artisan would readily understand this to comprehend transfers between two remote locations.
second party financially distinct from the first party	1, 4	p. 1, lns. 13-15 p. 2, lns. 8-10, 20-23, 47-50 p. 3, lns. 20-33	A skilled artisan would readily recognize that a sale requires the parties to be financially distinct. This was previously pointed out in the declaration of Arthur Hair submitted May 5, 1992.
second party controlling use and in possession of the second memory	1, 3	p. 3, lns. 26-33, 40-43	The as filed original specification includes <i>ipsis verbis</i> support for a second party control unit, where the user is the second party. A skilled artisan would readily recognize that the second memory is in possession and control of the second party, since the

			specification as originally filed states throughout that the user can store, sort and play thousands of songs from the user unit. A skilled artisan would clearly understand that this means the second party controls and possesses the second party control unit. This was previously pointed out in the declaration of Arthur Hair submitted May 5, 1992.
connecting electronically via a telecommunications line the first memory with the second memory	1, 4	p. 3, lns. 35-40	<i>ipsis verbis</i> support
transmitting the desired digital audio signal from the first memory with a transmitter in control and possession of the first party	1	p. 2, lns. 47-52 p. 3, lns. 35-40 Fig. 1	The as filed original specification has <i>ipsis verbis</i> support transmitting a desired digital audio signal and that the hard disk in the control unit of the authorized agent is the source. A skilled artisan would recognize that in order to regulate distribution of the signals the authorized agent would have to possess and control the transmitter. This was previously pointed out in the declaration of Arthur Hair submitted May 5, 1992.
to a receiver having the second memory at a location determined by the second party; said receiver in possession and control of the second party	1, 4	p. 2, lns. 47-50 p. 3, lns. 20-40 Fig. 1 p. 4, lns. 21-23	A skilled artisan would readily recognize in order to receive digital signals over telecommunications lines as disclosed throughout the specification, part of the second party control unit would act as a receiver. This was addressed previously in the affidavit of Arthur Hair dated May 5, 1992. A skilled artisan would also readily understand this to comprehend transfers between two remote locations. Since the second party possesses the second memory, the second party

			can determine its location. This was addressed previously in the declaration of Arthur Hair submitted May 5, 1992.
storing the digital audio signal in the second memory	1	p. 2, lns. 23-27	<i>ipsis verbis</i> support
searching the first memory for the desired digital audio signal	2	p. 3, lns. 35-40 p. 4, lns. 12-28	The as filed original specification has <i>ipsis verbis</i> support for electronic sales and electronic transfer of digital signals from a control unit of an authorized agent to a control unit of a user. A skilled artisan would readily recognize that this would include searching the hard disk of the first party to locate desired digital signals for purchase.
selecting the desired digital audio signal from the first memory	2	p. 3, lns. 35-40 p. 4, lns. 12-28	The as filed original specification has <i>ipsis verbis</i> support for electronic sales and electronic transfer of digital signals from a control unit of an authorized agent to a control unit of a user. A skilled artisan would readily recognize that this would include selecting desired digital signals from the hard disk of the first party for purchase.
telephoning the first party controlling use of the first memory by the second party	3, 6	p. 2, lns. 47-50 p. 3, lns. 20-40 Fig. 1 p. 4, lns. 21-23	The original as filed specification states throughout that digital audio or digital video signals are sold and transferred via telephone lines. A skilled artisan would readily recognize this as comprehending the telephoning of the first party by the second party to initiate a transaction. This was addressed previously in the declaration of Arthur Hair submitted May 5, 1992.
providing a credit card number of the second party to the first party so that the	3, 6	p. 1, lns. 13-15 p. 2, lns. 8-10, 20-23, 38-52	The original as filed specification states throughout that the

second party is charged money		p. 3, lns. 12-15, 35-37	invention provides for electronic sales of digital audio or digital video signals. A skilled artisan would readily recognize credit card sales as being comprehended within electronic sales. This was addressed previously in the affidavit of Arthur Hair dated May 5, 1992.
first party controlling the first memory	3, 6	p. 2, lns. 38-43 p. 3, lns. 35-49	The as filed original specification includes <i>ipsis verbis</i> support for a first party control unit, where the authorized agent is the first party. A skilled artisan would readily recognize that the first party control unit is in possession and control of the first party because as an "agent authorized to electronically sell and distribute" digital audio or digital video, the first party would necessarily have to possess and control the source of the digital audio and digital video. This was previously pointed out in the declaration of Arthur Hair submitted May 5, 1992.
A method for transmitting a desired digital video signal	4	p. 5, lns. 36-43	<i>ipsis verbis</i> support
transmitting the desired digital video signal from the first memory with a transmitter in control and possession of the first party	4	p. 5, lns. 36-43 p. 2, lns. 47-52 p. 3, lns. 35-40 Fig. 1	The as filed original specification has <i>ipsis verbis</i> support transmitting a desired digital audio signal and that the hard disk in the control unit of the authorized agent is the source. A skilled artisan would recognize that in order to regulate distribution of the signals the authorized agent would have to possess and control the transmitter. This was previously pointed out in the declaration of Arthur Hair submitted May 5, 1992. A skilled artisan would

			recognize based on the disclosure at the end of the specification that this procedure could also be used for digital video.
storing the digital video signal in the second memory	4	p. 5, lns. 36-43 p. 2, lns. 23-27	The as filed original specification has <i>ipsis verbis</i> support for storing digital signals on the hard disk of the user control unit. A skilled artisan would recognize based on the disclosure at the end of the specification that this procedure could also be used for digital video.
searching the first memory for the desired digital video signal	5	p. 3, lns. 35-40 p. 4, lns. 12-28 p. 5, lns. 36-43	The as filed original specification has <i>ipsis verbis</i> support for electronic sales and electronic transfer of digital signals from a control unit of an authorized agent to a control unit of a user. A skilled artisan would readily recognize that this would include searching the hard disk of the first party to locate desired digital signals for purchase. A skilled artisan would recognize based on the disclosure at the end of the specification that this procedure could also be used for digital video.
selecting the desired digital video signal from the first memory	5	p. 3, lns. 35-40 p. 4, lns. 12-28 p. 5, lns. 36-43	The as filed original specification has <i>ipsis verbis</i> support for electronic sales and electronic transfer of digital signals from a control unit of an authorized agent to a control unit of a user. A skilled artisan would readily recognize that this would include selecting desired digital signals from the hard disk of the first party for purchase. A skilled artisan would recognize based on the disclosure at the end of the specification that this procedure could also be used

			for digital video.
--	--	--	--------------------

For all the reasons set forth in the chart immediately above, the written description standard was satisfied for Claims 1 through 6 of the '573 Patent. For the same reason, Claims 44 through 49 are also supported by the originally filed specification of the '497 Application.

Moreover, the claim language "transferring money electronically via a telecommunication line to a first party at a location remote from the second memory," "charging a fee," "providing a credit card number," and "charging an account," all would have been understood by one of ordinary skill in the art in the context of the described electronic sales and distribution of digital audio signals or digital video signals. In this context, one of ordinary skill in the art would have recognized that electronic sales encompassed transactions where a fee is charged, and thus money is transferred from one party to another electronically via a telecommunication line. It further would have been understood by one of ordinary skill in the art that electronic sales could be accomplished by providing a credit card number. As a result, one of ordinary skill in the art in 1988 would have recognized that the description of electronic sales in the specification of the '497 Application necessarily comprehends "transferring money to a first party from a second party electronically via telecommunication lines," "charging a fee," "charging an account," and "providing a credit card number."

One of ordinary skill in the art in 1988 would have also been aware of the available means for connecting computer systems to telecommunication lines for the purpose of transferring electronic signals; for example modems. Such means could be used at the originating (transmitting) computer and at the destination (receiving) computer. The control

unit or control integrated circuit of the copyright holder and user would have been recognized by one of ordinary skill in the art as being some type of computer system or part of a computer system. Therefore, the terms in the claims “transmitter” and “receiver” describe what would have been understood by one of ordinary skill in the art as being necessarily comprehended by the description provided in the specification and figures filed with the ‘497 Application.

Finally, it easily would have been recognized by one of ordinary skill in the art in 1988 that the specification’s teaching requires establishing some type of connectivity as a prerequisite to making a purchase/sale of digital signals, as well as for transferring the digital signals. Since the specification of the ‘497 Application explicitly discloses selling and transferring digital audio signals (or digital video signals) over telephone lines, it is clear that the step of requesting and establishing connectivity (telephoning) is necessarily comprehended in the description provided in the ‘497 Application, since the step would have been recognized as a prerequisite for performing the function of the disclosed system.

For all of the above reasons, Claims 1 through 6 and 44 through 49 find adequate written support in the specification of the ‘497 Application as filed and are therefore entitled to the June 13, 1988 priority date. For this reason as well, the Board should vacate the Examiner’s findings with respect to the priority date of the ‘573 Patent.

2. The “Video Feature” of the Invention in Claims 4 Through 6 Of The ‘573 Patent Was Enabled By The Originally Filed Specification

The Office asserts the “video feature” of the invention in Claims 4 through 6 was not enabled by the disclosure in the originally filed specification.

The Office acknowledges the “original specification does contain a general statement at the end of the specification stating ‘[f]urther, it is intended that this invention not be limited to Digital Audio Music and can include Digital Video....’” The Office, however, generally asserts “this broad, generic statement fails to enable specifically claimed video download and processing procedures.” September 29, 2006 Office Action, page 12. Since the Office has not specifically identified which portions of the claims allegedly are not enabled, Appellant will discuss below the issue of enablement with respect to particular comments made in the September 29, 2006 Office Action.

i) The Office Is Attempting To Apply An Improper Standard For Enablement

The Office is attempting to apply a “mass production” standard to the claims when, in actuality, the enablement standard of Section 112 has no such requirement. As the CAFC held in *Christianson v. Colt Indus. Operating Corp.*, 822 F.2d 1544, 1562 (Fed. Cir. 1987), “the law has never required that [an Appellant]... must disclose in its patent the dimensions, tolerances, drawings, and other parameters of mass production not necessary to enable one skilled in the art to practice (as distinguished from mass-produce) the invention.” Nonetheless, it appears this kind of “mass production” information is exactly the kind of information the Office now seeks. For example, the Office Action states “[p]ersonal user devices with the processing power capable of playing back much larger and more complicated digital video files, such as DVD players, were not routinely available until the late 1990(s).” September 29, 2006 Office Action, pages 19-20. (emphasis added.) Whether such devices “routinely” were available is not part of the test for enablement, nor is it one of the eight factors for reasonable experimentation that were laid out by the CAFC in *In re Wands*, 858 F.2d 731 (Fed. Cir. 1988). Rather, the only

relevant test is whether, without undue experimentation, one of ordinary skill in the art could have made and used the claimed invention.

As further evidence that the Office seeks to apply a “mass production” standard, it is noted that the Office Action states “the digital bandwidth required to transmit a video signal at even VHS quality was around 1.5 megabits per second (approximately 30 megabytes in 3 minutes).” Office Action, page 14. (emphasis added.) However, while VHS quality may be appropriate for “mass production,” a limitation requiring VHS quality video is not included in any of the claims, and thus it is impermissible for the Office to use that level of quality as a benchmark for enablement. In fact, the recent success of very small screen video players shows that “mass production” can be achieved with even less than VHS quality.

Even if VHS quality were a requirement for enablement of the claims, there is no articulated basis to believe the original specification would not have enabled one of ordinary skill in the art to meet that quality for a short period of time. This fact is accentuated by the statement in the Office Action that “it is not clear ... how downloaded files of any appreciable or viable size would have been downloaded and stored on originally disclosed hard disk 60 of the user in the original specification.” September 29, 2006 Office Action, page 20. (emphasis added.) The use of “appreciable” and “viable” makes it clear that short videos are enabled, and nothing more is required. Further, the Office appears to acknowledge that even a 30-megabyte hard drive could store a three-minute movie if encoded at 1.5 megabits/second. *Id.* That alone is sufficient to meet the enablement requirement.

Moreover, the Office impermissibly limits the scope of what it referenced when the Office Action cites the size of available hard drives. While a 30-megabyte hard drive would have been available in a 3.5-inch form factor, the same chart relied on by the Office illustrates

that hard drives larger than 1.89 gigabytes were available at the same time. *See* September 29, 2006 Office Action, footnote 14.

Furthermore, the Office has applied the same “mass production” requirement to the library server. The Office initially seems to acknowledge that mainframes did exist which could have operated as repositories for copyrighted materials using hard disk drives. However, the Office then seems to discount the relevance of the existing mainframes by stating “it is not clear how even a small-sized video library ... would have been stored in the hard disk of the copyright holder ... without requiring details directed to a complex mainframe operating environment.” This unsupported statement on “complexity” is insufficient to prove that mainframe operating environments capable of storing digital video files were not already known at the time the original specification was filed, or that undue experimentation would have been required to store digital video files in such an environment. The statement also leaves unanswered how the Office is defining “small” -- according to the enablement standard under Section 112 or the improper “mass production” standard?

The Office Action further states “[r]egarding the transfer of these large video files over a network, the proliferation of broadband communication network[s] capable of delivering these large files to consumers, such as the Internet, simply did not exist or were not well known in 1988.” September 29, 2006 Office Action, pages 14-15. (emphasis added.) Such a statement raises at least two issues. First, “not well known” to whom? Those of ordinary skill in the art of computer systems knew of telephony-based wide area networks at the time the original specification was filed. See <http://www.rfc-editor.org/rfc-index.html> for a list of computer communications standards including those available at the time of filing. Second, utilization of a “broadband” network is not required. In fact, the originally filed specification discloses that

the audio and video files can be transferred over telephone lines. While this may not be an extremely fast method of transfer, it nonetheless clearly is enabling under Section 112.

The Office further questions “how the digital video would have been coded and decoded during transmission, as digital video coding standards for purposes of transmission and file download were not settled in 1988. [T]he MPEG-1 standard which was designed to code/decode digital video information and to transmit the video via a telephone (telecommunications) network in NTSC (broadcast) quality for archiving, was only established in 1992.” September 29, 2006 Office Action, page 21. (emphasis added.) Again, standardization of video coding and the use of “NTSC quality” relate to “mass production” rather than enablement under Section 112. Thus, the Office has not alleged -- and cannot allege -- that one of ordinary skill in the art could not have coded video at some other resolution or using some other encoding technique at the time the original specification was filed.

In contrast, those of ordinary skill in the art would have been able to code and decode video data transmitted over a telephone line without undue experimentation. This is because there were existing video teleconferencing systems known and available to them prior to applicant’s earliest priority date. As earlier as five years before applicant’s earliest priority date digital video signals could have been and were sent via telephone networks and decoded with picture processors in real-time.

Similarly, not only were TV processors for video processing available for use in video processing systems, but network interface specifications were available for making systems that were compatible with signals sent via telephone networks. As such, contrary to the position of the Office Action, it is clear that at the time of filing of the earliest priority application, one of

ordinary skill in the art would have been able to transmit, download and decode video signals as claimed without undue experimentation.

Accordingly, Claims 4 through 6 and Claims 47 through 49 directed to the “video feature” embodiment of the invention are enabled by the originally filed specification under the proper standard for Section 112 enablement.

D. Because Claims 1 Through 6 And 44 Through 49 Are Entitled To The June 13, 1988 Priority Date Awarded During the Original Examination, *Cohen* Is Not Appropriate Prior Art

Based on the foregoing, Claims 1 through 6 and 44 through 49 in reexamination are entitled to the June 13, 1988 priority date. In the first instance, it is improper for the Office to reconsider the issue of priority in the present reexamination for the reasons set forth in Sections III(A) and (B) above. Further, even if it were proper to reconsider the issue of priority, the facts of record clearly show the claims were described adequately and enabled by the originally filed specification for the reasons set forth in Section III(C) above. Therefore, U.S. Patent 4,949,187 to Cohen (*Cohen*) cannot be a proper basis for a rejection because the reference post-dates the applicable June 13, 1988 priority date for the claims. The Board should, therefore, reverse all rejections based on *Cohen*. See *supra*, Grounds 1-3 under the Grounds for Rejection to be Reviewed on Appeal.

IV. THE CLAIMS AS AMENDED ARE SUPPORTED AND ENABLED BY THE WRITTEN DESCRIPTION

In addition to questioning the written support and enablement of Claims 1 through 6 in the originally filed specification, the Office has also asserted separate rejections of Claims 1 through 6 as amended and new Claims 44 through 49 under 35 U.S.C. § 112, first paragraph. In making these rejections, the Office has improperly applied Section 112 analysis to claim elements that existed in the claims as issued, rather than limiting the analysis to “matter added or deleted” as required by 37 C.F.R. § 1.552. As detailed herein, Claims 1 through 6 and 44 through 49 are fully supported and enabled by the specification of the ‘573 Patent.

A. Rejection Of Claims 44 Through 49 Under 35 U.S.C. § 112, First Paragraph

Claims 44 through 49 have been rejected under Section 112, first paragraph, as introducing matter not described in the original specification. Claims 47 through 49 additionally have been rejected as not being enabled by the original specification.

As a preliminary matter, 37 C.F.R. § 1.552(a) states that an analysis under Section 112 will be performed with respect to *matter* added or deleted, not *claims* added or deleted. The restatement of matter already presented in Claims 1 through 6 in the form of Claims 44 through 49 does not add *matter* to the claims. MPEP § 2163.I states that issues under Section 112 “*most typically... arise in the context of...new or amended claims.*” (emphasis added.) This statement does not empower the Office to assert Section 112, first paragraph, rejections every time previously claimed matter is presented in the form of a different claim.

The only element present in Claims 44 through 49 that was not previously present in Claims 1 through 6 is the recitation of a hard disk. Therefore, the Office may only examine the recitation of “hard disk” for compliance with Section 112, first paragraph. A review of the originally filed specification demonstrates this recitation is fully supported and enabled by the originally filed specification. *See* Original Specification, p. 3, ln. 30.

Nonetheless, even if it were proper for the Office to examine Claims 44 through 49 in their entirety for compliance with Section 112, first paragraph, under 37 C.F.R. § 1.552(a), those issues were already addressed by Examiner Nguyen during the initial examination of Claims 1 through 6, as set forth above.

Further, as demonstrated by the Appellant in Section III above, each element of Claims 44 through 49 is fully supported and enabled by the specification of the ‘497 Application as

originally filed. Therefore, the Board should reverse the rejections of Claims 44 through 49 under 35 U.S.C. § 112, first paragraph.

B. Rejection Of Claims 1 Through 6 Under 35 U.S.C. § 112, First Paragraph

Claims 1 through 6 have been rejected under Section 112, first paragraph, as introducing matter not described in the original specification. Claims 4 through 6 additionally have been rejected as not being enabled by the original specification.

The Office asserts that the negative limitation of “a non-volatile storage portion of the second memory, wherein the non-volatile storage is not a tape or a CD”, introduces a new concept to the claims that does not have a basis in the originally filed specification. The Office cites two cases from the BPAI, one case from the CAFC, and one case from the Court of Customs and Patent Appeals (“C.C.P.A.”) to support this rejection. None of the cases support the rejection.

The CAFC case cited by the Office, *Lizardtech, Inc. v. Earth Res. Mapping, Inc.*, 433 F.3d 1373 (Fed. Cir. 2006), is merely an opinion denying a petition for rehearing *en banc*. The case does not address anything related to the current rejection. Therefore, the case simply does not support the Office’s position.

The two cases from the BPAI, *Ex Parte Wong*, No. 2004-1144, 2004 WL 4981845 (Bd. Pat. App. & Interf. June 10, 2004) and *Ex Parte Grasselli*, 231 U.S.P.Q. 393 (Bd. Pat. App. & Interf. 1983), address situations where a negative limitation added to a claim was not described in the specification of the application. However, neither *Wong* nor *Grasselli* support the rejection of Claims 1 through 6 under Section 112, first paragraph, in the instant case. In both *Wong* and *Grasselli*, the issue and ultimate ground for rejection was that a negative limitation added to the claims introduced a new concept not disclosed in the respective specifications in

those cases. That simply is not the situation here. Both Claims 1 and 4 recite a non-volatile storage portion of a memory that is not a tape or CD. The originally filed specification of the '497 Application explicitly states that the disclosed invention eliminates the need to handle tapes and CDs. *See* p. 2, Ins. 23 to 26. Thus, the concept of storing digital audio or digital video signals on a memory that is not a tape or CD is explicitly disclosed by the original specification. Therefore, *Wong* and *Grasselli* are inapposite to the present case.

The case from the C.C.P.A., *Application of Johnson*, 558 F.2d 1008 (C.C.P.A. 1977), concerns a situation where the applicant sought to claim priority to an originally filed application for claims in a subsequent continuation-in-part application. The holding of *Johnson* also fails to support the Office's position. In *Johnson*, an original parent application disclosed and claimed a genus of polymer compositions comprising various monomer units. In a later filed CIP application, the broad genus claims in the parent application were narrowed by expressly excluding certain species from the polymer compositions. The parent application only contained a description of the broader genus. The court found that claims to the narrower sub-genus created by the express exclusion of certain species in the CIP were not supported by the description of the broader genus in the parent specification. Again, the situation with the present reexamination differs significantly from the cited case law. Claims 1 and 4 recite a non-volatile storage portion of a memory that is not a tape or CD. This is exactly what is described at page 2, lines 23 to 26 of the originally filed specification. In short, the negative limitation recited in Claims 1 and 4 is expressly disclosed in the specification of the parent application. Thus, in the instant case, the scope of the disclosure in the specification was never narrowed with respect to this element, contrary to the situation in *Johnson*. Therefore, the recitation of a

non-volatile storage portion of a memory that is not a tape or CD is fully supported by the originally filed specification, as well as the specification of the '573 Patent as issued.

With respect to the other elements recited in Claims 1 through 6, the issue of written support for the claimed matter previously was addressed by Examiner Nguyen during the initial examination of Claims 1 through 6, as recognized by the Office in the Office Action dated March 17, 2007. Moreover, Appellant has thoroughly demonstrated in Sections III(C)(1)(ii) and III(C)(2) above that each element in Claims 1 through 6 is fully supported and enabled by the original specification as filed, as well as the specification for '573 Patent as issued.

Therefore, the Board should reverse the Examiner's rejections of Claims 1 through 6 under 35 U.S.C. § 112, first paragraph.

V. BASED ON THE PROPER PRIORITY DATE FOR THE CLAIMS IN REEXAMINATION, THE REJECTIONS OF CLAIMS 1 THROUGH 6 AND 44 THROUGH 49 BASED ON *COHEN* ARE IMPROPER

As set forth above, the proper priority for Claims 1 through 6 and 44 through 49 in reexamination is June 13, 1988. Therefore, any rejections under Sections 102 or 103 which rely on references that are not prior art based on the June 13, 1988 priority date are improper and should be reversed. U.S. Patent 4,949,187 to Cohen (*Cohen*) issued on August 14, 1990 from an application filed on December 16, 1988. Therefore, *Cohen* does not qualify as prior art for the purposes of Sections 102 and 103.

A. Rejection Of Claims 1, 2, 4, 5, 44, 45, 47 And 48 Under 35 U.S.C. § 102(e) As Anticipated By *Cohen*

Claims 1, 2, 4, 5, 44, 45, 47 and 48 have been rejected under 35 U.S.C. § 102(e) as anticipated by *Cohen*. Because *Cohen* is not available as prior art based on the proper priority date of June 13, 1988 for the '573 Patent, the instant rejection is improper. Therefore, the Board should reverse this rejection.

B. Rejection Of Claims 1 Through 6 and 44 Through 49 Under 35 U.S.C. § 103(a) Over *Bush* In View Of *Cohen*

Claims 1 through 6 and 44 through 49 have been rejected under 35 U.S.C. § 103(a) as obvious over the combination of U.S. Patent 4,789,863 to Bush (*Bush*) in view of *Cohen*. Because *Cohen* does not qualify as prior art based on the proper June 13, 1988 priority date of the '573 Patent, a combination of *Cohen* and another reference cannot provide a proper basis for an obviousness rejection. As a result, the rejection of Claims 1 through 6 and 44 through 49 based on a combination of *Bush* and *Cohen* is improper. Therefore, the Board should reverse this rejection.

C. Rejection Of Claims 3, 6, 46 and 49 Under 35 U.S.C. § 103 (a) Over *Cohen* In View Of *Bush*

Claims 3, 6, 46 and 49 have been rejected under 35 U.S.C. § 103(a) over *Cohen* in view of *Bush*. Because *Cohen* does not qualify as prior art based on the proper June 13, 1988 priority date of the '573 Patent, a combination of *Cohen* and another reference cannot provide a proper basis for an obviousness rejection. As a result, the rejection of Claims 3, 6, 46 and 49 based on a combination of *Bush* and *Cohen* is improper. Therefore, the Board should reverse this rejection.

VI. CLAIMS 1 THROUGH 6 AND 44 THROUGH 49 ARE PATENTABLE OVER THE REFERENCES OF RECORD THAT ARE PROPER PRIOR ART

The Office has also presented rejections under 35 U.S.C. § 103(a) that are based on references that qualify as prior art based on the June 13, 1988 priority date for the claims in reexamination. However, the Office has not established a *prima facie* case of obviousness of any of Claims 1 through 6 or 44 through 49 based on these references.

A. Rejection Of Claims 1 Through 6 And 44 Through 49 Under 35 U.S.C. § 103(a) Over *Bush* In View Of *Freeny I*

Claims 1 through 6 and 44 through 49 have been rejected under 35 U.S.C. § 103(a) as obvious over the combination of *Bush* in view of U.S. Patent 4,837,797 to Freeny (*Freeny I*).

The Office admits that *Bush* does not disclose storing digital audio signals or digital video signals in a non-volatile storage portion of a second memory that is not a tape or a CD as recited in Claims 1 and 4. As further admitted by the Office, *Bush* does not disclose storing digital audio signals or digital video signals in a second party hard disk as recited in Claims 44 and 49.

Freeny I discloses a message controller for receiving voice messages and machine readable messages over telephone lines. The apparatus of *Freeny I* is capable of differentiating between voice messages and machine readable messages received over standard telephone equipment, *i.e.* a telephone. When the apparatus of *Freeny I* determines that a received call is a voice message, it causes the user's telephone to ring, thereby alerting the user. When the apparatus of *Freeny I* determines that a received call is a machine readable message, it converts the message to human readable form using a standard printer or display unit. One embodiment of the apparatus of *Freeny I* indicates it is capable of receiving machine readable messages and storing them on a storage medium that may be a memory chip or hard disk.

However, *Freeny I* does not discuss transmission of digital audio or digital video signals from a first memory to a second memory, let alone the sale of such digital video or digital audio signals. Thus, *Freeny I* bears no relation to the disclosure of *Bush* or the invention recited in Claims 1 through 6 and 44 through 49. The Office apparently has recognized this deficiency in *Freeny I*, because the Office must cite to *Cohen* to show motivation to combine *Bush* and *Freeny I*. However, as set forth above, *Cohen* is not available as prior art based on the priority date of June 13, 1988 for the '573 Patent.

The Supreme Court's recent holding in *KSR Int'L Co. v. Teleflex Inc.*, 127 S. Ct. 1727 (U.S. 2007), does not relieve the Office of the obligation to show motivation to combine two separate references in making out a *prima facie* case of obviousness. Quite to the contrary, the Supreme Court stated: "[t]o determine whether there was an apparent reason to combine the known elements in the way a patent claims, it will often be necessary to look to interrelated teachings of multiple patents; to the effects of demands known to the design community or present in the marketplace; and to the background knowledge possessed by a person having ordinary skill in the art. *To facilitate review, this analysis should be made explicit.*" *KSR*, 127 S. Ct. at 1731 (emphasis added).

Since the Office has not shown any motivation to combine *Bush* and *Freeny I*, a *prima facie* case of obviousness has not been established. Therefore, the Board should reverse this rejection.

B. Rejection Of Claims 1 Through 6 And 44 Through 49 Under 35 U.S.C. § 103(a) Over *Akashi* In View Of *Freeny II*

Claims 1 through 6 and 44 through 49 have been rejected over Japanese Patent Application No. 62-284496 (*Akashi*) in view of U.S. Patent 4,528,643 to Freeny (*Freeny II*). Such a rejection is unfounded. First, the combination of *Akashi* and *Freeny II* would not reach the presently claimed invention. Second, there is no motivation to combine *Akashi* and *Freeny II*.

The Office asserts that *Akashi* shows a system for transmitting recorded music from a host computer that stores recorded music data to a personal computer. The Office then asserts that *Akashi* “does not expressly detail...whether the data is stored on a non-volatile portion of a second memory that is not a tape or CD.” This is incorrect. *Akashi* explicitly discloses a record reproducing device that is a compact disk deck or a digital audio tape recorder. See *Akashi* Translation, p. 2 (Embodiment). In other words, *Akashi* is not ambiguous at all on this point. Thus, not only does *Akashi* fail to disclose transmitting digital audio signals or digital video signals from a first memory to a second memory and storing the digital audio signals or digital video signals in a non-volatile portion of the second memory that is not a tape or CD, *Akashi* expressly teaches away by specifically disclosing and requiring a tape recorder or CD deck.

The Office asserts the deficiencies of *Akashi* are cured by *Freeny II*. Specifically, the Office asserts that *Freeny II* discloses transmitting digital audio signals or digital video signals from a first memory in control and possession of a first party to a second memory in control and possession of a second party, and storing the digital audio signals or digital video signals in a non-volatile storage that is not a tape or CD. The Office further asserts it would have been obvious to implement the non-volatile storage of *Freeny II* in the system of *Akashi* because “[t]he use of a hard disk would have allowed the user to more efficiently access audio and video

files.” The Office bases its position on the conclusion that “a hard-disk, would have also increased the security and reliability of the stored data.”

For several reasons, it would not have been obvious to combine the teachings of *Akashi* and *Freeny II* to arrive at the invention recited in Claims 1 through 6 and 44 through 49. First, *Freeny II* discloses a kiosk-type system for producing “material objects” at a point of sale location where it is the “material object” that is sold to consumers. *Freeny II*, Abstract. Thus, like *Akashi*, *Freeny II* expressly teaches away from storing digital audio signals or digital video signals on a non-volatile storage portion of a second memory that is not a tape or CD in possession and control of a second party. Further, in *Freeny II*, the second memory (information manufacturing machine) for storing the information that is transformed into material objects is in possession and control of the first party. The first party controls access to the information on the second memory by requiring a fee to be paid for the consumer (second party) to access the information stored on the second memory. After the fee is paid, the second party has limited access to the specific information requested for the purpose of making a copy in the form of a material object. In the case of audio or video information, the material object would be in the form of a tape or CD. Therefore, again, both *Akashi* and *Freeny II* contemplate and require supplying audio information to the consumer in the form of a tape or CD. Thus, like *Akashi*, *Freeny II* expressly teaches away from storing digital audio signals or digital video signals on non-volatile storage portion of a second memory that is not a tape or CD in possession and control of a second party.

Additionally, in *Freeny II*, the necessary material object containing the digital audio or digital video signals is produced by accessing information stored on the second memory. The first memory (information control machine) simply supplies reproduction authorization codes in

response to a request for reproduction from the information manufacturing machine. The second party never has access to the first memory, as recited in present Claims 2, 5, 45 and 48.

Both *Akashi* and *Freeny II* solve the same problem: providing audio information, and video information in the case of *Freeny II*, to a consumer in the form of a material object, such as a tape or CD. *Akashi* and *Freeny II* solve this common problem in different and unrelated ways. Nonetheless, neither of the references teaches or discloses the benefits of transmitting digital audio signals or digital video signals from a first memory to a second memory and storing those digital audio signals or digital video signals in a non-volatile portion of the second memory that is not a tape or CD, which is in possession and control of a consumer, *i.e.* a second, financially distinct, party. Therefore, the combination of *Akashi* and *Freeny II* does not teach or suggest every limitation of Claims 1 through 6 or 44 through 49. In fact, because both *Akashi* and *Freeny II* expressly require storing digital audio signals or digital video signals on a tape or CD, they teach away from the invention recited in Claims 1 through 6 and 44 through 49. “[W]hen the prior art teaches away from combining certain known elements, discovery of a successful means of combining them is more likely to be nonobvious.” *KSR*, 127 S. Ct. at 1740. As a result, these references cannot be combined to render Claims 1 through 6 obvious.

Even if the combination of *Akashi* and *Freeny II* did teach each and every element of Claims 1 through 6 or 44 through 49 – which they do not – the motivations cited by the Office for combining and/or modifying *Akashi* and *Freeny II* are not found in those references. Moreover, the Office has not cited to any other references or knowledge available to one of ordinary skill in the art in 1988 that would have motivated a skilled artisan to combine and/or modify *Akashi* and *Freeny II* as suggested by the Office. Rather, the Office simply has made vague statements that the security and reliability of hard disks would have been well known at

the time. Such general allegations are insufficient to show motivation to combine these references, particularly since neither one of them even hints at such a modified combination. Again, as the Supreme Court has just admonished: “[a] patent composed of several elements is not proved obvious merely by demonstrating that each element was, independently, known in the prior art.” *KSR*, 127 S. Ct. at 1731.

Based on all of the foregoing, the Office has not established a *prima facie* case of obviousness of Claims 1 through 6 and 44 through 49 over the combination of *Akashi* and *Freemy II*. Therefore, the Board should reverse this rejection.

C. The Secondary Considerations Of Non-Obviousness Support The Finding Of Non-Obviousness Of Claims 1 Through 6 And 44 Through 49

Although a showing of secondary considerations is not strictly necessary to establish the non-obviousness of Appellant’s invention, such secondary considerations in fact do exist.

The CAFC has explicitly set forth the factors, such as commercial success, long felt but unresolved needs, skepticism by experts, and copying by competitors that can be used to establish non-obviousness. *Brown & Williamson Tobacco Corp. v. Philip Morris Inc.*, 229 F. 3d 1120, 1129 (Fed. Cir. 2000). The CAFC has held that a nexus must be established between the merits of a claimed invention and the evidence of non-obviousness offered if that evidence is to be given substantial weight enroute to a conclusion of non-obviousness. *Ex parte Remark*, 15 U.S.P.Q.2d 1498, 1502 (Bd. Pat. App. & Interfer. 1990). The CAFC has also held, however, that copying of a patented feature or features of an invention, while other unpatented features are not copied, gives rise to an inference that there is a nexus between the patented feature and the commercial success. *Hughes Tool Co. v. Dresser Industries, Inc.*, 816 F.2d 1549, 1556 (Fed. Cir. 1987). Moreover, it is well established that copying of a patented invention, rather

than one within the public domain, is by itself indicative of non-obviousness. *See Windsurfing Int'l Inc., v. AMF, Inc.*, 782 F.2d 995, 1000 (Fed. Cir. 1986).

The invention recited in Claims 1-6 (and Claims 44-49) generally comprises transferring “for pay” digital video or digital audio signals between a first memory controlled by a seller and a second memory at a remote location controlled by a buyer over a telecommunication line. The invention has in the past achieved significant commercial success. *See, e.g.*, Declaration of Arthur R. Hair submitted with Appellant’s Response dated December 27, 2005.

Moreover, the invention continues to achieve commercial success in that it has been copied by a major participant in the field. The features of the invention generally included in Claims 1-6 (and Claims 44-49) have been copied by at least one commercially successful system available today: Napster Light. The Napster Light system (“Napster”) for purchasing digital music files online at www.napster.com is a commercially successful system that embodies the features of the claimed invention. The Declaration of Justin Douglas Tygar, Ph.D. (“Tygar Dec. 2005”), a copy of which is filed herewith, supports the assertion that Napster is commercially successful and has copied the claimed invention.

Dr. Tygar determined that Napster has achieved a level of commercial success. *See* Tygar Dec. 2005, para. 6. Further, Dr. Tygar compared Napster to the invention recited in Claims 1-6 and determined Napster copied the invention. Specifically, Dr. Tygar found that Napster operates a music download system incorporating servers having hard disks and memory, through which it sells digital music files to a buyer for download over the Internet. *See* Tygar Dec. 2005, para. 10. The buyer using Napster has a computer at a home, office, or other location remote from Napster. *See* Tygar Dec. 2005, para. 11. The buyer forms a connection between his or her computer and Napster via the Internet, selects digital music

file(s) he or she wishes to purchase, provides a credit card number, and receives the music file via a download process where the file is transferred from Napster's server to the buyer's computer and stored on the hard drive. The buyer can then play the file using his or her computer system. *See* Tygar Dec. 2005, paras. 12-16. In view of this comparison, Dr. Tygar properly concludes that Napster has copied the features taught by the present invention. *See* Tygar Dec. 2005, para. 19.

Additionally, Napster *does not* copy the alleged closest prior art cited by the Examiner, *i.e.*, *Freeny* and *Akashi*. *Freeny* teaches a point-of-sale device (e.g., a kiosk) that dispenses a material object (e.g., tape) containing the music purchased. *See Freeny*, col. 1, line 64 to col. 2, line 12. These features of *Freeny* are plainly not found in Napster. *See* Tygar Dec. 2005, para. 16. *Akashi* teaches writing data to a digital audio tape recorder or a compact disk deck that employs a write-once, read-many times recordable optical disk which allows data to be read immediately after the data is written. The user downloads data to a RAM and then the data is written directly from the RAM to a recordable optical disk. *See Akashi* para. 6. This process of *Akashi* is not how Napster operates. *See* Tygar Dec. 2005, para. 18.

Therefore, it is apparent that Napster chose to copy the system taught by the '573 patent. *See* Tygar Dec. 2005, para. 19. It is also apparent that Napster chose *not* to copy the prior art systems of *Freeny* and *Akashi*. *See* Tygar Dec. 2005, para. 20 and 21. This selective copying by Napster of the invention recited in Claims 1-6 (and Claims 44-49), while Napster ignored the systems of *Freeny* and *Akashi*, provides a sound basis upon which the required nexus between commercial success and Appellant's claimed invention can be found. *See Hughes Tool*, 816 F.2d at 1556. Additionally, Napster's selective copying of Appellant's invention, coupled with Napster's disregard of the *Freeny* and *Akashi* systems, is itself substantive evidence of a

recognized secondary indication of non-obviousness. *See Windsurfing International Inc.*, 782 F.2d 995 (Fed. Cir. 1986).

The foregoing remarks and the Declaration of Dr. Tygar establish the requisite nexus between the commercial success of Napster and Appellant's claimed invention. These remarks and the Declaration of Dr. Tygar similarly have established copying by Napster as a secondary indicia of non-obviousness.

Conclusion

Based on the foregoing, the Board should reverse the rejections of Claims 1 through 6 and 44 through 49 under 35 U.S.C. §§ 102(e) and 103(a). Also based on the foregoing, the Board should reverse the rejection of Claims 1 through 6 and 44 through 49 under 35 U.S.C. § 112, first paragraph.

Respectfully submitted,



Robert A. Koons, Jr., Esq.
Attorney for Appellant
Reg. No. 32,474

Drinker Biddle & Reath LLP
One Logan Square
18th and Cherry Streets
Philadelphia, PA 19103-6996
Telephone (215) 988-3392
Facsimile (215) 988-2757
Date: January 30, 2008

CLAIMS APPENDIX

1.(Amended) A method for transmitting a desired digital audio signal stored on a first memory of a first party to a second memory of a second party comprising the steps of: transferring money electronically via a telecommunication line to the first party at a location remote from the second memory and controlling use of the first memory from the second party financially distinct from the first party, said second party controlling use and in possession of the second memory; connecting electronically via a telecommunications line the first memory with the second memory such that the desired digital audio signal can pass there-between; transmitting the desired digital audio signal from the first memory with a transmitter in control and possession of the first party to a receiver having the second memory at a location determined by the second party, said receiver in possession and control of the second party; and storing the digital signal in a non-volatile storage portion of the second memory, wherein the non-volatile storage portion is not a tape or CD.

2.(Original) A method as described in claim 1 including after the transferring step, the steps of searching the first memory for the desired digital audio signal; and selecting the desired digital audio signal from the first memory.

3.(Original) A method as described in claim 2 wherein the transferring step includes the steps of telephoning the first party controlling use of the first memory by the second party; providing a credit card number of the second party controlling the second

memory to the first party controlling the first memory so the second party is charged money.

4.(Amended) A method for transmitting a desired digital video signal stored on a first memory of a first party to a second memory of a second party comprising the steps of: transferring money electronically via a telecommunications line to the first party at a location remote from the second memory and controlling use of the first memory, from a second party financially distinct from the first party, said second party in control and in possession of the second memory; connecting electronically via a telecommunications line the first memory with the second memory such that the desired digital video signal can pass there-between; transmitting the desired digital video signal from the first memory with a transmitter in control and possession of the first party to a receiver having the second memory at a location determined by the second party, said receiver in possession and control of the second party; and storing the digital signal in a non-volatile storage portion of the second memory, wherein the non-volatile storage portion is not a tape or a CD.

5.(Original) A method as described in claim 4 including after the transferring money step, the step of searching the first memory for the desired digital signal and selecting the desired digital signal from the first memory.

6.(Original) A method as described in claim 5 wherein the transferring step includes the steps of telephoning the first party controlling use of the first memory by the second party controlling the second memory; providing a credit card number of the second party controlling the second memory to the first party controlling the first memory so the second party controlling the second memory is charged money.

7-43 (Canceled)

44.(New) A method for transmitting a desired digital audio signal stored on a first memory of a first party to a second memory of a second party comprising the steps of:
transferring money electronically via a telecommunications line to the first party at a location remote from the second memory and controlling use of the first memory from the second party financially distinct from the first party, said second party controlling use and in possession of the second memory;
the second memory including a second party hard disk;
connecting electronically via a telecommunications line the first memory with the second memory such that the desired digital audio signal can pass therebetween;
transmitting the desired digital audio signal from the first memory with a transmitter in control and possession of the first party to a receiver having the second memory at a location determined by the second party, said receiver in possession and control of the second party;
and storing the digital signal in the second party hard disk.

45.(New) A method as described in claim 44 including after the transferring step, the steps of searching the first memory for the desired digital audio signal; and selecting the desired digital audio signal from the first memory.

46.(New) A method as described in claim 45 wherein the transferring step includes the steps of telephoning the first party controlling use of the first memory by the second party; providing a credit card number of the second party controlling the second memory to the first party controlling the first memory so the second party is charged money.

47.(New) A method for transmitting a desired digital video signal stored on a first memory of a first party to a second memory of a second party comprising the steps of:

transferring money electronically via a telecommunications line to the first party at a location remote from the second memory and controlling use of the first memory from the second party financially distinct from the first party, said second party controlling use and in possession of the second memory;

the second memory including a second party hard disk;

connecting electronically via a telecommunications line the first memory with the second memory such that the desired digital video signal can pass therebetween;

transmitting the desired digital video signal from the first memory with a transmitter in control and possession of the first party to a receiver having the second memory at a location determined by the second party, said receiver in possession and control of the second party;

and storing the digital signal in the second party hard disk.

48.(New) A method as described in claim 47 including after the transferring step, the steps of searching the first memory for the desired digital signal; and selecting the desired digital signal from the first memory.

49. (New) A method as described in claim 47 wherein the transferring step includes the steps of telephoning the first party controlling use of the first memory by the second party; providing a credit card number of the second party controlling the second memory to the first party controlling the first memory so the second party is charged money.

EVIDENCE APPENDIX

- 1) Declaration under 37 C.F.R. § 1.132 of Arthur R. Hair submitted with the Appellant's response of December 27, 2005.
- 2) Declaration under 37 C.F.R. § 1.132 of Dr. J. Douglas Tygar submitted with the Appellant's response of December 27, 2005.
- 3) Website: <http://www.rfc-editor.org/rfc-index.html>, referenced in Appellant's response of November 29, 2006.
- 4) Website: http://en.wikipedia.org/wiki/Non-volatile_storage, referenced in Appellant's response of November 29, 2006.

IN THE UNITED STATES PATENT AND TRADEMARK OFFICE

In re Application of:)
)
ARTHUR R. HAIR)
)
Reexamination Control No. 90/007,402)
)
Reexamination Filed: January 31, 2005) METHOD FOR TRANSMITTING A
) DESIRED DIGITAL VIDEO OR
Patent Number: 5,191,573) AUDIO SIGNALS
)
Examiner: Benjamin E. Lanier

Pittsburgh, Pennsylvania 15213

December 23, 2005

Mail Stop *Ex Parte* Reexamination
Commissioner for Patents
P.O. Box 1450
Alexandria, VA 22313-1450

DECLARATION UNDER 37 C.F.R. §1.132

I, Arthur R. Hair, hereby declare that:

1. I am the sole inventor of United States Patent Nos. 5,191,573; 5,675,734; and 5,966,440.
2. I am Chairman of the Board and Chief Technology Officer of SightSound Technologies, Inc.
3. I assigned my rights in United States Patent Nos. 5,191,573; 5,675,734; and 5,966,440 to the company that ultimately became SightSound Technologies, Inc ("SightSound").
These patents served SightSound Technologies well and were essential in raising the

capital necessary to launch a company that would build eCommerce systems protected by the patents.

4. With the foregoing three patents in hand, SightSound Technologies achieved many notable firsts, including:
 - first to electronically sell a music download via the Internet;
 - first to electronically sell a movie download via the Internet;
 - first to produce a motion picture specifically for simultaneous electronic distribution worldwide via the Internet;
 - first to electronically sell encrypted movies legally through the Gnutella file-sharing networks, without being in violation of copyrights;
 - first to develop a legal system to sell encrypted music legally through the Napster file-sharing networks, without being in violation of copyrights;
 - first to electronically sell a movie into a movie theater projection booth via the Internet for digital exhibition from a windows workstation; and
 - first to electronically sell a movie into a handheld unit, a Compaq iPac Pocket PC.

5. SightSound built five Media eCommerce Systems. Over time, these systems grew from a single server located in Pittsburgh to a geographically distributed system with a central core in Pittsburgh that controlled remote servers located in New York, Los Angeles, Santa Clara, Seattle, Chicago, Washington D.C. and Boston. Version 1 was built in 1995

and Version 2 was built in 1998, both of these versions only sold music. Version 3.1, 3.2 and 3.3 were built between 1999 and 2001 and sold both music and movies. The fifth system built at SightSound Technologies (which we called Version 3.3) was a fully automated, database driven secure Media eCommerce System that had the hardware capacity to rent and/or sell 380,000 movies a day.

6. The foregoing Media eCommerce Systems were covered by one or more claims in each of United States Patent Nos. 5,141,573, 5,675,734 and 5,966,440.

7. The Media eCommerce Systems were designed to support:
 - official movie websites;
 - banner ads that automatically invoke a download;
 - digital cinema (download to the projection booth);
 - portable audio/video devices
 - database driven websites; and
 - peer-to-peer file-sharing networks.

8. Using its Media eCommerce Systems, SightSound Technologies provided client services releasing motion pictures and music for Internet download sale for more than 40 filmmakers, special interest video production companies and recording artists. SightSound Technologies first offered music for sale via the Internet in download fashion in September 1995. At that time, SightSound Technologies offered music from the band

"The Gathering Field." Individual songs were priced at 99 cents and the entire album was available for \$6.00. SightSound Technologies went on to build a respectable client roster that included over 65 companies and individuals, including:

- Miramax Films (a subsidiary of the Walt Disney Company)
- Showtime Networks (the Tyson -vs- Norris boxing match)
- Comedy Central (half owned by Fox and half owned by Warner Brothers)
- Lyric Studios (the children's television program "Barney")
- WQED TV

9. I have attached as part of this Declaration several announcements and media coverage illustrating the many accomplishments that United States Patent Nos. 5,191,573; 5,675,734; and 5,966,440 assisted SightSound Technologies to achieve.

I further declare that all statements made herein of my own knowledge are true and that all statements made on information and belief are believed to be true; and further, that these statements are made with the knowledge that willful false statements and the like so made are punishable by fine or imprisonment, or both, under Section 1001 of Title 18 of the United States Code, and that such willful false statements may jeopardize the validity of the application or any patent issuing thereon.

23 DECEMBER 2005
Date

Arthur R. Hair
Arthur R. Hair

IN THE UNITED STATES PATENT AND TRADEMARK OFFICE

In re Application of:)
ARTHUR R. HAIR)
Reexamination Control No. 90/007,402)
Reexamination Filed: January 31, 2005) A SYSTEM FOR TRANSMITTING
Patent Number: 5,191,573) DESIRED DIGITAL VIDEO OR
Examiner: Benjamin E. Lanier) AUDIO SIGNALS
)

December 23, 2005

Mail Stop *Ex Parte* Reexamination
Commissioner for Patents
P.O. Box 1450
Alexandria, VA 22313-1450

DECLARATION UNDER 37 C.F.R. §1.132

I, Justin Douglas Tygar, hereby declare that:

1. I am a tenured, full Professor at the University of California, Berkeley with a joint appointment in the Department of Electrical Engineering and Computer Science (Computer Science Division) and the School of Information Management and Systems.
2. I earned an A.B. degree in Math/Computer Science from the University of California, Berkeley, in 1982 and I earned a Ph.D. in Computer Science from Harvard University in 1986.
3. I am an expert in software engineering, computer security, and cryptography. I have taught courses in software engineering and computer security at the

undergraduate, master's, and doctorate level at both the University of California, Berkeley and Carnegie Mellon University.

4. I serve in a number of capacities on government, academic, and industrial committees that give advice or set standards in security and electronic commerce. In addition, I have authored numerous publications in the fields of computer science and security in electronic commerce. I have attached a copy of a recent curriculum vita to this declaration as Exhibit A.

5. At the request of counsel, I have compared a currently available system for purchasing digital audio files, namely the online music service offered at www.napster.com known as Napster Light¹ (hereinafter "Napster Light"), with the teachings of U.S. Patent 5,191,573 (the "'573 patent").

6. Napster Light is a currently operating service with an apparently wide user base. It is therefore apparent that Napster Light, which uses the teachings of the '734 Patent, has been commercially successful.

7. The '573 Patent generally discloses a method pertaining to the electronic sale and transfer of digital audio or video signals, which are signals containing recorded sound or

¹ It should be noted that the Napster Light service offered by the entity known currently as Napster, Inc. at www.napster.com is separate and distinct from a previous file sharing on-line service offered by an earlier entity entitled Napster. It is my understanding that this prior entity went out of business in 2002, at which time Roxio, Inc. acquired the Napster name and trademark rights. Subsequently, Roxio, Inc. changed their name to Napster, Inc., thus creating the current entity referred to herein as "the new Napster, Inc."

video, such as a musical or video recording, converted into binary form. The steps of the method pertain to the following:

- A first party who is a seller of digital audio or video signals through telecommunication lines. Telecommunication lines can include the Internet. The seller must have control over a computer memory, which includes a hard disk and RAM. The hard disk includes copies of encoded digital audio or video signals, which are the digital audio or video signals configured in a form that would prevent unauthorized copying.

- A second party who is a buyer of the digital audio or video signals. The buyer must possess and control his or her own computer memory. The buyer's memory must be located at a location remote from the location of the memory controlled by the seller.

8. The invention of the '573 patent comprises a number of steps, though not in any particular order except as indicated below. The steps are:

- Forming an end-to-end electronic connection over the telecommunications lines between the computer memory controlled by the seller and the buyer's computer memory, which is controlled by the buyer;

- Transmitting the desired digital audio signal from the first memory to the second memory; and

- Storing the transferred copy of the digital audio or video signals in the buyer's memory.

9. I have accessed Napster Light for the purpose of comparing it to the '734 patent. Based on my review, I have determined the following facts set forth in paragraphs 10 through 20 of this declaration.

10. The operator of Napster Light (i.e., the new Napster, Inc.), the "first party" for the purposes of this comparison, operates a music download system through which digital music files are sold to buyers for download over the internet. The digital music files contain digital representations of sound recordings. I have concluded from viewing information on www.napster.com that Napster Light uses a system that includes servers, which have memory that includes hard disks that store digital music for sale over the internet. The new Napster, Inc. appears to control the servers that contain the digital music files for sale.

11. The typical online buyer using Napster Light, the "second party" for the purposes of this comparison, controls a personal computer. For instance, the buyer controls which software to install and run on the computer, what data to store in the computer, and when to operate the computer. The buyer has the computer at a home, office, or other location remote from Napster Light.

12. Using a software application downloaded from a website associated with Napster Light, the online buyer may connect to Napster Light's online music library over the Internet and browse online music catalogs. The buyer forms a connection between his or her computer and the Internet through an Internet Service Provider (ISP) that may be accessed via a dial-up connection using a modem and a telephone line.

13. Using the downloaded software application, the online buyer browses Napster Light's online music catalogs. The online buyer can select a particular digital music file he or she desires.

14. The digital music file is delivered to the online buyer via a download operation that is automatically initiated between Napster Light's servers and the online buyer's computer.

15. The download process occurs by transmitting a copy of the digital music file over the Internet to the online buyer's computer. The transmitted copy is stored in the online buyer's computer hard drive. Throughout this downloading process, the online buyer is in control of his or her computer's memory.

16. The downloaded copy of the digital music is stored to the hard drive of the buyer's computer, from which it can be written to other media such as an optical disk or memory of a portable device.

17. Napster Light does not include a point-of-sale device such as a kiosk, as used in United States Patent No. 4,528,643 to Freeny (the "Freeny Patent").

18. Napster Light does not writing a digital signal from memory directly to an optical disk or digital tape, as taught in Japanese Patent Publication 62-284496 to Akashi (the "Akashi Patent").

19. In view of the foregoing, I have determined that Napster Light embodies the elements taught in the '573 Patent. As a result, it can be concluded that Napster Light has copied the teachings of the '573 Patent.

20. Also in view of the foregoing, I have determined that the Napster system does not embody essential elements of the Freeny patent. As a result, it can be concluded that Napster Light has not copied the Freeny patent.

21. Also in view of the foregoing, I have determined that the Napster system does not embody essential elements of the Akashi patent. As a result, it can be concluded that Napster Light has not copied the Akashi patent.

I further declare that all statements made herein of my own knowledge are true and that all statements made on information and belief are believed to be true; and further, that these statements are made with the knowledge that willful false statements and the like so made are punishable by fine or imprisonment, or both, under Section 1001 of Title 18 of the United States Code, and that such willful false statements may jeopardize the validity of the application or any patent issuing thereon.

26 Dec 05

Date

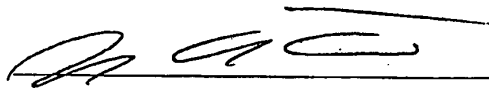

Justin Douglas Tygar, Ph.D.

2-1-08

Reexam

Express Mail Label No.: EV 299882953 US
Attorney's Docket No. NAPS001

Patent

67274 U.S. PTO



013008

01789 U.S. PTO

IN THE UNITED STATES PATENT AND TRADEMARK OFFICE



In re Application of: Arthur R. Hair

Group No.: 3992

Serial No.: 90/007,402

Examiner: Roland G. Foster

Filed: January 31, 2005

Confirmation No. 2998

For: METHOD FOR TRANSMITTING A DESIRED DIGITAL VIDEO OR AUDIO SIGNAL

RESPONSE TO NOTIFICATION OF NON-COMPLIANT APPEAL BRIEF

Mail Stop Appeal Brief - Patents
Commissioner for Patents
P.O. Box 1450
Alexandria, VA 22313-1450

Sir:

In response to the Notification of Non-Compliant Appeal Brief dated January 17, 2008 ("the Notification"), Appellant respectfully encloses herewith an AMENDED BRIEF ON APPEAL UNDER 37 C.F.R. § 41.37, which removes reference to information that the examiner failed to enter (*i.e.*, the May 17, 2007 Declaration of Dr. J. Douglas Tygar and the IEEE article by Wright submitted on May 17, 2007). This response is being timely filed within the one month period set forth in the Notification. No fee is believed to be due for the filing of this response. Please charge any fee that is due, and credit any overpayment, to deposit account no. 50-0573.

CERTIFICATE OF MAILING
UNDER 37 C.F.R. 1.8(a)

I hereby certify that this paper, along with any paper referred to as being attached or enclosed, is being deposited with the United States Postal Service on the date indicated below, with sufficient postage, as first class mail, in an envelope addressed to: Mail Stop Appeal Brief - Patents, Commissioner for Patents, P.O. Box 1450, Alexandria, VA 22313-1450.

BY David R. Rugg

DATE: JANUARY 30, 2008



Express Mail Label No.: EV 299882953 US

Control No.: 90/007,402

Appellant respectfully submits that removing reference to the unentered information overcomes the objections in the Notification and places the brief in compliance with 37 C.F.R. § 41.37. If, in the opinion of the examiner, a telephone conference would aid in processing the subject brief, the examiner is invited to call the undersigned attorney.

Respectfully submitted,



Robert A. Koons, Jr., Esq.
Attorney for Appellant
Reg. No. 32,474

Drinker Biddle & Reath LLP
One Logan Square
18th and Cherry Streets
Philadelphia, PA 19103-6996
Telephone (215) 988-3392
Facsimile (215) 988-2757
Date: January 30, 2008



RECEIVED

FEB 06 2008

CENTRAL REEXAMINATION UNIT **Drinker Biddle & Reath**
L L P

One Logan Square
18th & Cherry Streets
Philadelphia, PA 19103-6996
■ 215-988-2700

FACSIMILE INFORMATION SHEET

TO:	<u>Manuel Saldana</u>	FROM:	<u>Daniel P. Reilly</u>	DIRECT DIAL:	<u>215-988-1992</u>
DATE:	<u>February 6, 2008</u>	DOCUMENT NAME:	<u>90/007,402</u>		
NUMBER OF PAGES: INCLUDING COVER					<u>2</u>
TELEPHONE NUMBER:	<u>(571) 272-7740</u>	FAX NUMBER:	<u>(571) 273-9900</u>		

IF YOU DO NOT RECEIVE THIS FAX DOCUMENT IN ITS ENTIRETY, PLEASE CALL **Daniel P. Reilly** AT 215-988-1992
DB&R FACSIMILE MACHINES
215-988-2757

Message:

In response to your voicemail message to Mr. Robert Koons on February 5, 2008, the following is a Certificate of Service for Reexamination No. 90/007,402.

If you have any questions, please contact Robert Koons at (215) 988-3392 or Daniel Reilly at (215) 988-1992.

Original will not follow

Original will follow via Regular Mail Overnight Delivery Hand Delivery Other:

The pages which follow are confidential and/or privileged. They are intended solely for the person to whom this cover sheet is addressed. Any review, reproduction or retransmission of such material by any person other than such addressee is unauthorized. If this cover sheet and the pages which follow have been received at your location in error, please notify the operator by telephone (collect) at the number set forth above and return the material U.S. First-Class Mail without inspection. We will reimburse your postage. Thank you for your cooperation.

PHIP560581\1

Reexamination Number 90/007,402

RECEIVED

Attorney's Docket No. NAPS001

Patent

FEB 06 2008

CENTRAL REEXAMINATION UNIT

IN THE UNITED STATES PATENT AND TRADEMARK OFFICE

In re Application of: Arthur R. Hair	:	Group No.: 3992
	:	
Serial No.: 90/007,402	:	Examiner: Roland G. Foster
	:	
Filed: January 31, 2005	:	Confirmation No. 2998
	:	
For: METHOD FOR TRANSMITTING A DESIRED DIGITAL VIDEO OR AUDIO SIGNAL		

CERTIFICATE OF SERVICE

The undersigned hereby certifies that true and correct copies of the AMENDED BRIEF ON APPEAL UNDER 37 C.F.R. § 41.37 and the RESPONSE TO NOTIFICATION OF NON-COMPLIANT APPEAL BRIEF, which were filed with the United States Patent & Trademark Office on January 30, 2008, in Reexamination No. 90/007,402, were served via First Class United States Mail, postage prepaid, this 6th day of February 2008, on the following:

Mr. Albert S. Penilla
 Martine, Penilla, & Gencarella, LLP
 710 Lakeway Drive, Suite 200
 Sunnyvale, CA 94085
 Attorney for Third Party Reexamination Requester

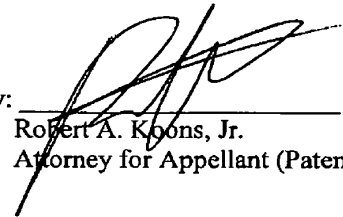
By: 
 Robert A. Koons, Jr.
 Attorney for Appellant (Patentee)



UNITED STATES PATENT AND TRADEMARK OFFICE

UNITED STATES DEPARTMENT OF COMMERCE
United States Patent and Trademark Office
Address: COMMISSIONER FOR PATENTS
P.O. Box 1450
Alexandria, Virginia 22313-1450
www.uspto.gov

APPLICATION NO.	FILING DATE	FIRST NAMED INVENTOR	ATTORNEY DOCKET NO.	CONFIRMATION NO.
90/007,402	01/31/2005	5191573	NAPS001	2998

23973 7590 04/24/2008

DRINKER BIDDLE & REATH
ATTN: INTELLECTUAL PROPERTY GROUP
ONE LOGAN SQUARE
18TH AND CHERRY STREETS
PHILADELPHIA, PA 19103-6996

EXAMINER

ART UNIT PAPER NUMBER

DATE MAILED: 04/24/2008

Please find below and/or attached an Office communication concerning this application or proceeding.



UNITED STATES PATENT AND TRADEMARK OFFICE

Commissioner for Patents
United States Patent and Trademark Office
P.O. Box 1450
Alexandria, VA 22313-1450
www.uspto.gov

DO NOT USE IN PALM PRINTER

(THIRD PARTY REQUESTER'S CORRESPONDENCE ADDRESS)

Albert S. Penilla
Martine Penilla & Gencarella, LLP
710 Lakeway Drive, Suite 200
Sunnyvale, CA 94085

MAILED
APR 24 2008
CENTRAL REEXAMINATION UNIT

EX PARTE REEXAMINATION COMMUNICATION TRANSMITTAL FORM

REEXAMINATION CONTROL NO. 90/007,402.

PATENT NO. 5191573.

ART UNIT 3992.

Enclosed is a copy of the latest communication from the United States Patent and Trademark Office in the above identified *ex parte* reexamination proceeding (37 CFR 1.550(f)).

Where this copy is supplied after the reply by requester, 37 CFR 1.535, or the time for filing a reply has passed, no submission on behalf of the *ex parte* reexamination requester will be acknowledged or considered (37 CFR 1.550(g)).



UNITED STATES PATENT AND TRADEMARK OFFICE

Commissioner for Patents
United States Patent and Trademark Office
P.O. Box 1450
Alexandria, VA 22313-1450
www.uspto.gov

DO NOT USE IN PALM PRINTER

(THIRD PARTY REQUESTER'S CORRESPONDENCE ADDRESS)

Albert S. Penilla
Martine Penilla & Gencarella, LLP
710 Lakeway Drive, Suite 200
Sunnyvale, CA 94085

EX PARTE REEXAMINATION COMMUNICATION TRANSMITTAL FORM

REEXAMINATION CONTROL NO. 90/007,402.

PATENT NO. 5191573.

ART UNIT 3992.

Enclosed is a copy of the latest communication from the United States Patent and Trademark Office in the above identified *ex parte* reexamination proceeding (37 CFR 1.550(f)).

Where this copy is supplied after the reply by requester, 37 CFR 1.535, or the time for filing a reply has passed, no submission on behalf of the *ex parte* reexamination requester will be acknowledged or considered (37 CFR 1.550(g)).



UNITED STATES PATENT AND TRADEMARK OFFICE

Commissioner for Patents
United States Patent and Trademark Office
P.O. Box 1450
Alexandria, VA 22313-1450
www.uspto.gov

**BEFORE THE BOARD OF PATENT APPEALS
AND INTERFERENCES**

Application Number: 90/007,402
Filing Date: January 31, 2005
Appellant(s): 5191573

Robert A. Koons, Jr.
For Appellant

EXAMINER'S ANSWER

This is in response to the appeal brief filed January 30, 2008 appealing from the Office action mailed March 17, 2007.

(1) Real Party in Interest

A statement identifying by name the real party in interest is contained in the brief.

(2) Related Appeals and Interferences

Related appeals are pending from reexamination proceeding for the following U.S. Patents, which are all related to the subject '573 patent.

<u>U.S. Patent No.</u>	<u>Reexamination Proceeding</u>	<u>Relationship To Subject U.S. Patent</u>
5,675,734	90/007,403	Great Grand-Child
5,966,440	90/007,407	Great Grand-Child

(3) Status of Claims

The statement of the status of claims contained in the brief is correct.

(4) Status of Amendments After Final

The appellant's statement of the status of amendments after final rejection contained in the brief is correct.

(5) Summary of Claimed Subject Matter

The summary of claimed subject matter contained in the brief is correct to the extent it contains a concise explanation of the subject matter.

(6) Grounds of Rejection to be Reviewed on Appeal

The appellant's statement of the grounds of rejection to be reviewed on appeal is substantially correct. The changes are as follows: claims 1, 2, 4, 5, 44, 45, 47 and 48 stand rejected under 35 U.S.C. § 102(e), not under 35 U.S.C. § 103(a) over U.S. Patent No. 4,949,187 to Cohen.

(7) Claims Appendix

The copy of the appealed claims contained in the Appendix to the brief is correct.

(8) Evidence Relied Upon

4,528,643	Freeny	7-1985
4,789,863	Bush	12-1988
4,837,797	Freeny, Jr.	6-1989
4,949,187	Cohen	8-1990
62-284496	Akashi	12-1987

"The History of Recordings", Recording Industry of Association, retrieved from <http://www.riaa.com/issues/audio/hisotry.asp> on September 19, 2006.

"History of CD Technology", citing as a source "The compact Disc Handbook, 2nd Edition," by Ken C. Pohlmann, retrieved from <http://www.oneoffcd.com/info/hisotrycd.cfm> on September 19, 2006.

"History of MPEG", University of California, Berkeley, School of Information Management and Systems, retrieved from <http://www2.sims.berkeley.edu/courses/is224/s99/GroupG/report1.html> on September 19, 2006

"IBM HDD Evolution" chart, by Ed Grochowski at Almaden, retrieved from http://www.sorageview.com/guideImages/z_ibm_sorageevolution.gif on September 19, 2006.

(9) Grounds of Rejection

Summary

U.S. Patent No. 5,191,573 is presently under reexamination in this proceeding. The claims of said patent are generally directed to downloading audio and video content via a "telecommunications line," where a district court, consistent with the appellant's arguments in that proceeding, held that the term "telecommunications line" may include the Internet.¹ The appellant has not characterized the claimed invention differently in this reexamination proceeding. See for example, the Declaration by Arthur R. Hair, filed on December 27, 2005, especially paragraphs 4-6.

¹ Sightsound.com Inc. v. NSK, Inc. Cdnow, Inc., and Cdnow Online, Inc., Civil Action No. 98-118, pp. 50 and 57 (District Court for the Western District of Pennsylvania, Feb. 2002).

Intervening Printed Publications

Summary

Claims in an *ex parte* reexamination proceeding will be examined on the basis of patents or printed publications. 37 CFR 1.552. The examiner may use an intervening printed publication when the claims under reexamination are entitled only to the actual filing date of the patent being reexamined, not to the filing date of a different, earlier filed patent. 35 U.S.C. 120. See also MPEP § 2258.I.C.

Definitions

As an initial matter, the instant 5,191,573 (the "'573") patent under reexamination and the earlier filed application are related as follows. The '573 patent under reexamination issued from U.S. Application No. 07/586,391 (hereinafter the "Child" application), which was filed on September 18, 1990. The parent (earlier filed) application to the Child application is U.S. Application No. 07/206,497, as originally filed on June 13, 1988 (hereinafter the "Parent" application).

Basic Statement of the Issues Regarding Entitlement to the Benefit of a Filing Date of an Earlier Application

The Child application is alleged to be related to the Parent application as a "continuation" application (i.e., the Child application did not, on filing, contain disclosure of any subject matter not present in the Parent application, and the claims of the Child application, on filing, were fully

supported by the disclosure of the Child application, see MPEP § 201.06(c).III).² However, the specification of the Child application (at the time the Child application issued as the '573 patent under reexamination) and the specification of the Parent application, as originally filed (see attachment "A"), differ considerably, as discussed below, raising issues of priority under 35 U.S.C. 120.

Furthermore, the prosecution history of the Child application (issuing as the '573 patent under reexamination) does not show that the examiner had any reason to consider the propriety of the benefit (continuation) claim set forth in the Child application to the originally filed, Parent application, as, for example a reference dated later than the filing date of the Parent application that would antedate the actual filing date of the Child application. In addition, the prosecution history of the Child patent does not contain any substantive, written discussion between the appellant and the examiner regarding such a claim to the benefit of filing date in the Parent applications, as originally filed.

For the reasons to be discussed below, the effective filing date of the '573 patent under reexamination, which issued from the Child application, is September 18, 1990 (at the earliest), which is the actual filing date of the Child application.

² Note that all the applications above were filed under the old "file wrapper continuation" procedures under 37 CFR 1.62, see MPEP § 201.06(a).

Art Unit: 3992

Intervening Patents and Printed Publications Are Available as Prior Art In a Reexamination Proceeding According to 35 U.S.C. 120

A rejection may be made in an *ex-parte* reexamination proceeding based on an intervening patent when the patent claims under reexamination, under 35 U.S.C. 120, are entitled only to the filing date of the patent under reexamination. Specifically:

Rejections may be made in reexamination proceedings based on intervening patents or printed publications where the patent claims under reexamination are entitled only to the filing date of the patent and are not supported by an earlier foreign or United States patent application whose filing date is claimed. For example, under 35 U.S.C. 120, the effective date of these claims would be the filing date of the application which resulted in the patent. Intervening patents or printed publications are available as prior art under *In re Ruscetta*, 255 F.2d 687, 118 USPQ 101 (CCPA 1958), and *In re van Langenhoven*, 458 F.2d 132, 173 USPQ 426 (CCPA 1972). See also MPEP § 201.11

MPEP § 2258.I.C, Scope of Reexamination (emphasis added).

As discussed above, 35 U.S.C. 120 applies to *ex-parte* reexamination procedure. To be entitled to benefit of an earlier filing date under 35 U.S.C. 120, the previously filed specification of the Parent application must support the invention claimed in the Child application. See 35 U.S.C. 120.

The Original Claims of the Child Patent Under Reexamination Are Not Entitled to Benefit of the Filing Date of the Parent Application, as Originally Filed, Under 35 U.S.C. 120 Because the Parent Application, as Originally Filed, Fails to Support Several Features Claimed in the Child Patent Under Reexamination

A review of the prosecution history reveals that a significant amount of new text (directed to various features) added in a series of amendments is not found in the Parent application as originally filed (attachment "A"). Consider the following Table I:

Table I. New Matter Chart

	Parent Appln. 07/206,497, filed 6/13/88 (Abandoned)		Child Appln. 07/586,391, filed 9/18/90 (5,191,573)	
Feature	Date First Appearing in Claims of Parent Appln.	Date First Appearing in Spec. of Parent Appln.	Date First Appearing in Claims of Child Appln.	Date First Appearing in Spec. of Child Appln.
Hard Disk/Control Unit of Seller/User	Filing Date of the Original Application – 6/13/88	Filing Date of the Original Application – 6/13/88		Filing Date of the Child Application – 9/18/90
Electronic sales and distribution of the music				
Broad Statement at end of spec. regarding Video Applicability, Note *		Filing Date of the Original Application – 6/13/88		Filing Date of the Child Application – 9/18/90
Transferring Money from Second Party to a First Party (Charging a Fee)	12/22/88 (2/28/90)		Filing Date of the Child Application – 9/18/90	12/11/91
Providing a Credit Card Number	12/22/88		Filing Date of the Child Application – 9/18/90	
Controlling Use of First/Second Memory	12/22/88		Filing Date of the Child Application – 9/18/90	12/11/91
Transmitting to a Location Determined by Second Party	2/28/90		Filing Date of the Child Application – 9/18/90	12/11/91
Specific Video Download Procedures	2/28/90		Filing Date of the Child Application – 9/18/90	12/11/91 Note **
First Party in Possession of Transmitter	8/24/90, but not entered		Filing Date of the Child Application – 9/18/90	12/11/91
Second Party in Possession of Receiver and Second Memory	8/24/90, but not entered		Filing Date of the Child Application – 9/18/90	12/11/91

Key: Clear row means original matter present in the original Parent application. Shaded row means new matter introduced by amendment into both the Parent and Child applications subsequent to the date of the original Parent application.

Note * - The original specification also describes using a "convenient visual display of the user's library of songs" (page 5), however this section appears to relate to displaying category/lyrical information to the user regarding downloaded audio content, and not directed to the actual download, processing, and display of video content.

Note ** - Even more detailed video download procedures are added to the specification of subsequent Child applications, see the 90/007,403 and 90/007,407 reexaminations.

Appellant failed to provide adequate support for all the new text added by the series of amendments (as identified in Table I above) to the Parent and Child applications. Appellant should specifically point out the support for any amendments made to the original disclosure. MPEP § 714.02, 2163.II.A.2(b), and 2163.06. Consider the following:

Table II. Amendment History Chart

I. Parent Application No. 07/206,497 (filed June 13, 1988)

a. *Amendment of Dec. 22, 1988*

New Matter in Claims

New Independent Claim 11 – "transferring money to a party controlling use of the first memory"

New Dependent Claim 13 - "providing a credit card number of the party controlling use of the first memory by the party controlling the second memory"

New Matter in Spec.

No new matter added to specification.

Support for New Matter

Applicant made a statement in the amendment that "support for these new claims is found in the figures." This statement however is very broad. Applicant does not specifically point out where in the figures the added features are found and the examiner cannot find support for such features.

b. Amendment of Feb. 28, 1990

New Matter in Claims

New Dependent Claim 14 - "transmitting the digital signal from the first memory to the second memory at a location determined by the second party..."

New Independent Claim 15 –

* "transmitting a desired digital, a video or audio music signal...."

[detailed recitation of a method for transmitting follows]

* "charging a fee to the first party controlling use of the second memory"

New Dependent Claim 18 – "charging a fee to a party controlling the use and the location of the second memory."

New Matter in Spec.

Abstract briefly mentions storing video signals onto a hard disk.

Support for New Matter

Applicant made a statement in the amendment that "antecedent support for these claims is found in Figure 1." This statement is very broad. Applicant does not specifically point out where in the figures the added features are found and the examiner cannot find support for such features.

c. Proposed After-final Amendment of August 24, 1990 (Not Entered)

New Matter in Claims

Independent Claim 11 –

*"second party controlling use and in possession of the second memory"

* "with a transmitter in control and possession of the first party to a receiver having a second memory at a location

determined by the second party, said receiver in possession and control of the second party"

Independent Claim 15 –

- * "charging a fee by a first party controlling use of the first memory
- * new limitations similar to claim 11 above

New Matter in Spec.

Title amended to state "Method for Transmitting a Desired Video or Audio Signal"

Support for New Matter

No support was provided.

II. Child Application No. 07/586,391 (filed September 18, 1990) (FWC) (Issued as 5,191,573)

A substantial amount of new matter was added to the Child application, with respect to the Parent application as originally filed. For example, see the preliminary amendment of September 18, 1990, the amendment of December 11, 1991, the amendment of June 25, 1992, and the amendment of October 5, 1992.

Thus, as discussed above, the appellant failed to point out support in the original Parent application, as originally filed (attachment "A"), for all of the new text added by the series of amendments. Appellant should specifically point out the support for any amendments made to the original disclosure. MPEP § 714.02, 2163.II.A.2(b), and 2163.06.

Limitations Later Added by Amendment, but Missing from the Original Written Description, Must Be Required By or Necessarily Present in the Original Written Description, Otherwise Those Limitations Are New Matter To the Original Written Description

Furthermore, the new text added by the amendments identified above is in the nature of additional, narrowing limitations and elements undisclosed by the generic statements in the original disclosure of the Parent application. When an explicit limitation in a claim "is not present in the written description whose benefit is sought it must be shown that a person of ordinary skill would have understood, at the time the patent application was filed, that the description requires that limitation." Hyatt v. Boone, 146 F.3d 1348, 1353, 47 USPQ2d 1128, 1131 (Fed. Cir. 1998) (emphasis added) (Certiorari Denied). The written description must "actually or inherently disclose the claim element." Poweroasis, Inc. v. T-Mobile USA, Inc., 2008 WL 1012561, p. 6 (Fed. Cir. 2008). "To establish inherency, the extrinsic evidence must make clear that the missing descriptive matter is necessarily present in the thing described in the reference.... Inherency, however, may not be established by probabilities or possibilities." In re Robertson, 169 F.3d 743, 745, 49 USPQ2d 1949, 1950-51 (Fed. Cir. 1999) (citations omitted, emphasis added). As for speculation about undisclosed uses of the originally disclosed elements, it is not sufficient that the written description, when "combined with the knowledge in the art, would lead one to speculate as to modifications that the inventor might have envisioned, but failed to disclose." Lockwood v. American Airlines, Inc., 107 F.3d 1565, 1571, 41 USPQ2d 1961, 1965-66 (Fed. Cir. 1997). See also MPEP § 2163.II.A.2(b) and § 2163.05.II.

New Matter Issues Other Than Video Download Features

In the instant case, it is clear that the explicit limitations added by amendment but missing from the original written description are not required by or necessarily present in the original written description. The recited details as to how money is transferred from a second party to the first party, a fee is charged, or how a credit card number is provided are not disclosed or required by the original, generic statement "electronic sales and distribution of the music...." For example, during the originally disclosed electronic sale, money could instead be transferred from a third party buyer (e.g., advertiser, local network provider, local retail store, friend, etc.) and/or transferred to a third party seller (e.g., remote wholesale music provider, local network provider, local retail store, etc.). Furthermore, a money fee would not necessarily be charged upfront during a sale (e.g., a free preview or trial period, or a sale based on barter or credits). Thus, an electronic sale could be booked without the transfer of money. Finally, digital content would not necessarily be purchased using a credit card. For example, the person downloading the content could receive the bill in the mail.

Similarly, the ability to control and possess a transmitter, receiver, and memory and to determine the location to which data is transmitted is not disclosed or required by the original, generic statements such as "control unit of the user." For example, the originally disclosed control unit of the seller or user could instead mean that seller and/or buyer instead rent or lease the equipment as is commonplace in the computer network industry rather than possess the equipment. Neither is the seller or user required to exercise control over their equipment, for

example, the downloading services could be provided by a third party offering a turn-key solution.

The appellant submitted a Declaration on June 25, 1992 attempting to show many of the above features were nonetheless required. This Declaration however, and related attorney arguments, were in response to a new matter objection made to one in a series of amendments, specifically the amendment of December 11, 1991 (see the non-final rejection in the Child application, mailed on February 24, 1992), where by the way, both the examiner and appellant only touched upon a subset of the new matter issues described in Table I above. A series of amendments to the specification and claims were filed previously and subsequently to this single amendment in the Parent and Child applications, where each amendment gradually added new matter. See Table II, *supra*. Therefore, it is not clear whether the examiner addressed this issue in regard to the specification as originally filed in the Child application from which the '573 patent issued, much less in regard to the specification as originally filed in the Parent application, which is at issue here.

Nonetheless, the Declaration is unpersuasive. Although factual evidence is preferable to opinion testimony in a 37 C.F.R. 1.132 Declaration, opinion testimony is entitled to consideration and some weight so long as the opinion is not on the ultimate legal conclusion at issue. While an opinion as to a legal conclusion is not entitled to any weight, the underlying basis for the opinion may be persuasive. MPEP § 71601(c).III. Here, the 1.132 Declaration relies upon the opinion of the inventor, often couched in conclusory language, to reach

conclusions about what would have been required by the specification, as it existed at the time of the December 11, 1991 amendment. That is, the Declaration goes to the ultimate legal conclusion at issue, whether the specification at the time of the December 11, 1991 amendment discloses those limitations newly introduced into the December 1991 amendment. Thus, the Declaration is not entitled to any weight, and furthermore the basis for the opinion is unpersuasive. For example, consider the following conclusory statement from page 2:

One skilled in the art would know that an electronic sale inherently assumes a transferring of money by providing a credit or debit card number (since that is the only way for electronic sales to occur) coupled with a transferring of a service or product.

As discussed above, a money fee would not necessarily be charged upfront during a sale (e.g., a free preview or trial period, or a sale based on barter or credits). Thus, an electronic sale could be booked without the transfer of money. The purchaser instead could be easily identified by other types of information (e.g., account number, PIN, email address, mailing address, etc.). Furthermore, digital content would not necessarily be purchased using a credit card. The simplest example is that a person downloading the content could receive the bill in the mail.

New Matter Related to Video Download Features

The specific video download features added to the original specification and claims by the above amendments are not disclosed nor required by the one sentence, generic statement at the end of the original specification that "this invention is not to be limited to Digital Audio

Music and can include Digital Video...."³ Undisclosed digital video features (assuming enablement) could be implemented into the broadly termed "invention" in an almost unlimited number of specific, possible (but not required) ways, such as at various levels of integration with the originally disclosed audio system and at various levels of detail. By introducing new text directed to specific video download features in the subsequent amendments, the appellant simply chose one possible (but not required) way to integrate video features into the originally disclosed audio system.⁴ Indeed, the appellant continued to add specific, video download and transmission procedures not found in the original specification (i.e., chose other possible ways to integrate video features) during the prosecution of subsequent, allegedly "continuation" applications, see the 90/007,403 and 90/007,407 reexaminations.⁵ Thus, the original, one sentence generic statement does not require all the many instances of undisclosed, specific details later added by the appellant.

Furthermore, transmission and storage of digital video content significantly differs in technology from the transmission and storage of digital audio content, thus the originally disclosed audio transmission features fail to imply or require any video transmission features. For example, the decoding of digital video data is much more processor intensive than the decoding of digital audio data due to the increased information content and bandwidth of a

³ The original specification also describes using a "convenient visual display of the user's library of songs" (page 5), however this section appears to relate to displaying category/lyrical information to the user regarding downloaded audio content, and not directed to the actual download, processing, and display of video content.

⁴ See the amendments of February 28, 1990, December 11, 1991, and June 25, 1992.

⁵ Although adding text that replaces all appearances of "audio" with "video" would be one possible (but not required) way to integrate undisclosed video features into the originally disclosed audio system, this is not what the applicant has done here, probably because such a rote replacement would create a dysfunctional system. For example, those originally disclosed audio features directed to listening to the audio cannot be simply replaced with the word video (e.g., listening to "video"). For example, applicant waited until the child application to add new text directed toward displaying downloaded video, see page 10 of the amendment, filed January 3, 1994, in child application 08/023,398.

typical video signal. In the mid 1980(s), at the time of the filing date of the original Parent specification, only compact audio disk players were routinely available.⁶ Personal user devices with the processing power capable of playing back much larger and more complex digital video files, such as DVD players, were not routinely available until the late 1990(s), and even these devices initially only read video data from read-only DVD disks capable of storing large digital video files, not from video data downloaded (recorded) from a remote server via a communications network.⁷ Thus, undisclosed devices capable of decoding and playing back digital video files would not have been required nor necessarily present based on the original disclosure of an integrated circuit 50 of the user, which was also originally disclosed to process and store audio information. For the same reasons, it is also not clear how the originally disclosed, incoming RAM 50c and playback RAM 50d could have supported storage of downloaded video and playback.

Further regarding the original equipment of the user (consumer), in 1988 a large capacity drive for a user (e.g., 3.5 inch form factor) was around 30 megabytes⁸, yet the digital bandwidth required to transmit a video signal at even VHS quality was 1.5 megabits per second (approximately 30 megabytes in 3 minutes) and this even using a Moving Picture Coding Experts Group Standard "1" ("MPEG-1") video compression technology not even available in

⁶ See "The History of Recordings", Recording Industry of Association, retrieved from <http://www.naa.com/issues/audio/hisotry.asp> on September 19, 2006. See also the "History of CD Technology", citing as a source "The compact Disc Handbook, 2nd Edition," by Ken C. Pohlmann, retrieved from <http://www.oneoffcd.com/info/hisotrycd.cfm> on September 19, 2006.

⁷ See the "History of MPEG", University of California, Berkeley, School of Information Management and Systems, retrieved from <http://www2.sims.berkeley.edu/courses/is224/s99/GroupG/report1.html> on September 19, 2006. See also the "History of CD Technology", citing as a source "The compact Disc Handbook, 2nd Edition," by Ken C. Pohlmann, retrieved from <http://www.oneoffcd.com/info/hisotrycd.cfm> on September 19, 2006.

1988.⁹ Thus, undisclosed devices capable of downloading and storing digital video files would not have been required or necessarily present based on the original disclosure of hard disk 60, which was also originally disclosed to process and store audio information.

Regarding video equipment used at the library (server) end, even large mainframe computers (e.g., IBM mainframe computers) typically only provided hard drives with capacity well below 10 gigabytes.¹⁰ Thus, undisclosed devices capable of supporting even a small-sized video library, with its steep storage requirements as discussed above, would not have been required or necessarily present based on the original disclosure of the library (server) hard disk 10 of the copyright holder, which was originally disclosed as storing audio information.

Regarding the transfer of these large video files over a network, the proliferation of broadband communication network capable of delivering these large files to consumers simply did not exist or were not well known in 1988. Furthermore, it is not clear how the digital video would have been coded and decoded during transmission, as digital video coding standards for purposes of transmission and file downloading were not settled in 1988. As an example of the above points, the MPEG-1 standard, which was designed to code/decode digital video information and to transmit the video via a telephone (telecommunications) network in NTSC (broadcast) quality for archiving, was only established in 1992.¹¹ Thus, undisclosed devices

⁸ See "IBM HDD Evolution" chart, by Ed Grochowski at Almaden, retrieved from http://www.soragereview.com/guideImages/z_ibm_sorageevolution.gif on September 19, 2006.

⁹ See the "History of MPEG", University of California, Berkeley, School of Information Management and Systems, retrieved from <http://www2.sims.berkeley.edu/courses/is224/s99/GroupG/report1.html> on September 19, 2006.

¹⁰ IBM HDD Evolution chart, *supra*.

¹¹ History of MPEG, supra.

capable of coding, transmitting, and decoding video digital data would not have been required or necessarily present based on the original disclosure of telephone line 30 (transmission line) and control IC(s) 20b and 50b (coding/decoding devices), which were originally disclosed as processing audio information.

Conclusion Regarding Entitlement to the Benefit of a Filing Date
in an Earlier Application

In view of the above, all of the new text introduced by amendment into the Child application (as identified in Table I above) is considered new matter to the original Parent application, as originally filed (attachment "A"), for the purposes of this reexamination. Thus, the previously filed, original specification of the Parent application fails to support the invention claimed in the Child application and thus is not entitled to priority under 35 U.S.C. 120. Thus, the effective filing date (priority) of the instant '573 patent under reexamination is latest date at which time the priority chain was broken, namely September 18, 1990 (at the earliest), which is also the filing date of the Child application (which issued as the '573 patent under reexamination).

Claim Rejections - 35 USC § 112

The following is a quotation of the first paragraph of 35 U.S.C. 112:

The specification shall contain a written description of the invention, and of the manner and process of making and using it, in such full, clear, concise, and exact terms as to enable any person skilled in the art to which it pertains, or with which it is most nearly connected, to make and use the same and shall set forth the best mode contemplated by the inventor of carrying out his invention.

Claims 1-6 and 44-49 are rejected under 35 U.S.C. 112, first paragraph, as failing to comply with the written description requirement.

New Claims Contain Extensive New Text that is Not Found in the Written Description of the Parent Application As Originally Filed

35 U.S.C. 112 issues can be addressed in a reexamination proceeding with respect to new claims or amendatory subject matter. MPEP § 2258.

"Most typically, the [112] issue will arise in the context of determining whether new or amended claims are supported by the description of the invention in the application as filed... whether a claimed invention is entitled to the benefit of an earlier priority date or effective filing date under 35 U.S.C. 119, 120, or 365(c)." MPEP § 2163.I. Here, the '573 patent under reexamination claims benefit under 35 U.S.C. 120 to the earlier filing date of the Parent application.

The new claim(s) contain subject matter, which was not described in the specification in such a way as to reasonably convey to one skilled in the relevant art that the inventor(s), at the time the original Parent application was filed, had possession of the claimed invention. Indeed,

the new claims contain extensive new text that is not found in the written description of the originally filed Parent application, see Table I in the "Intervening Printed Publications" section (9) above. See also attachment "A" regarding the originally filed, Parent application.

To comply with the written description requirement of 35 U.S.C. 112, para. 1, or to be entitled to an earlier priority date or filing date under 35 U.S.C. 119, 120, or 365(c), each claim limitation must be expressly, implicitly, or inherently supported in the originally filed disclosure. When an explicit limitation in a claim "is not present in the written description whose benefit is sought it must be shown that a person of ordinary skill would have understood, at the time the patent application was filed, that the description requires that limitation." Hyatt v. Boone, 146 F.3d 1348, 1353, 47 USPQ2d 1128, 1131 (Fed. Cir. 1998). See also In re Wright, 866 F.2d 422, 425, 9 USPQ2d 1649, 1651 (Fed. Cir. 1989).

MPEP § 2163.II.A.2.(b), emphasis added.

Here, the appellant, on page 9 of the amendment filed November 29, 2006 (the "Amendment"), states that the new claims mirror the original claims in the '573 patent, where alleged support for the original claims in the '573 patent are provided on pages 21-26 of the Amendment. Certain of the claim limitations addressed in this chart, however, are not necessarily disclosed (required by) the written description of the originally filed, Parent application, and thus are not present in the said written description. Thus these limitations are considered new matter, as extensively discussed by the examiner in the "Intervening Printed Publications" section (9) above.

New and Amended Claims Contain a Negative Limitation that is Not Found in the
Written Description of the Original Parent Application

The Amendment also introduced a negative limitation into independent claims 1 and 4. For example, claim 1 now recites "a non-volatile storage portion of the second memory, wherein the non-volatile storage portion is not a tape or a CD" (emphasis added).

Any negative limitation must have basis in the original disclosure. If alternative elements are positively recited in the specification, they may be explicitly excluded in the claims, however the mere absence of a positive recitation is not a basis for exclusion. Any claim containing a negative limitation, which does not have a basis in the original disclosure should be rejected under 35 U.S.C. 112. See MPEP § 2173.05(i).

Although the Parent application, as originally filed (attachment "A"), discloses a specific hard disk embodiment, which is therefore not in the form of a tape or a CD, the originally filed disclosure does not provide written description support for the recited, negative limitation. On page 8 of the Amendment, the appellant points to page 4, lines 35 to 49 of the originally filed, Parent specification (attachment "A") has teaching a "hard disk for storing digital audio or digital video signals." The originally filed specification in the Parent application, including the section cited to by the appellant above, only discloses one embodiment, where a hard disk 60 stores electronic audio music.¹² Thus, the originally filed, Parent specification discloses only a specific hard disk embodiment, which is not in the form of a tape or a CD. It should also be noted that

"[c]laims are not necessarily limited to preferred embodiments, but if there are no other embodiments, and no other disclosure, then they may be so limited." Lizardtech, Inc. v. Earth Resource Mapping, Inc., 433 F.3d 1373, 1375 (Fed. Cir. 2006) (rehearing denied, *en banc*).

The negative limitation introduces new concepts beyond this specific embodiment. The new concepts include non-volatile storage devices that are not tapes or CDs, but that are also not hard disks. See page 3 of Ex Parte Wong, 2004 WL 4981845 (Bd.Pat.App. & Interf. 2004). The "express exclusion of certain elements implies the permissible inclusion of all other elements not so expressly excluded. This clearly illustrates that such negative limitations do, in fact, introduce new concepts. Ex parte Grasselli, 231 USPQ 393, 394 (Bd. App. 1983), *aff'd* mem., 738 F.2d 453 (Fed. Cir. 1984). "The artificial subgenus thus created in the claims is not described in the parent case and would be new matter if introduced into the parent case. It is thus equally 'new matter'...." Ex Parte Johnson, 558 F.2d 1008, 1014 (CCPA 1977). Here, the originally filed disclosure does not necessarily disclose (require) or even suggest an undisclosed, artificial subgenus of non-volatile storage devices that are not tapes or CDs. Thus, such a claimed subgenus represents new matter.

Claims 4-6 and 47-49 are rejected under 35 U.S.C. 112, first paragraph, as failing to comply with the enablement requirement. The claim(s) contains subject matter, which was not described in the specification in such a way as to enable one skilled in the art to which it pertains, or with which it is most nearly connected, to make and/or use the invention.

¹² The originally filed specification in the Parent application, including the section cited to by the Appellant above,

35 U.S.C. 112 issues can be addressed in a reexamination proceeding with respect to new claims or amendatory subject matter. MPEP § 2258.

The new claim(s) contain subject matter, which was not described in the specification in such a way as to reasonably convey to one skilled in the relevant art that the inventor(s), at the time that the original Parent application was filed, that the specification would have taught one skilled in the art how to make and/or use the full scope of the claimed invention without undue experimentation. In re Wright, 999 F.2d 1557, 1562, 27 USPQ2d 1510, 1513 (Fed. Cir. 1993). See also MPEP § 2164.01 and 2164.05(a).

Undue Experimentation Factors

There are many factors to be considered when determining whether there is sufficient evidence to support a determination that a disclosure does not satisfy the enablement requirement and whether any necessary experimentation is "undue." These factors include, but are not limited to whether the scope and breadth of the claims are reasonably related to the scope of enablement within the original specification, the level of ordinary skill in the art, and the quantity of undue experimentation. See MPEP 2164.01(a).

Here, the subject claims recite extensive new text directed to specific and detailed video download and processing procedures that is not found in original specification of the Parent

also fails to teach that the hard disk stored video data despite assertions by the Appellant.

Application. The original specification does contain a general statement at the end of the specification stating "[f]urther, it is intended that this invention is not to be limited to Digital Audio Music and can include Digital Video...." (attachment "A"), however this broad, generic statement fails to enable specifically claimed video download and processing procedures.¹³

The detailed and extensive claim limitations directed to video download and processing stand in contrast to the brief, generic one sentence disclosure in the original specification, as discussed above. Thus, the scope and breadth of the claims are not reasonably correlated to the scope of enablement in the original specification. The scope of enablement must at least bear a "reasonable correlation" to the scope of the claims. See, e.g., In re Fisher, 427 F.2d 833, 839, 166 USPQ 18, 24 (CCPA 1970). See also MPEP § 2164.08.

The original specification would not have been enabling to one of ordinary skill in the art and furthermore an undue quantity of experimentation would have been required to make or use the scope of the claimed invention (video download and processing features) based on the original specification. The specification must be enabling as of the filing date of the specification. MPEP § 2164.05(a). Here, the filing date of the Parent Application was June 13, 1988. In the mid 1980(s) however, compact audio disks players were just becoming popular.¹⁴ Personal user devices with the processing power capable of playing back much larger and more

¹³ The original specification also describes using a "convenient visual display of the user's library of songs" (page 5), however this section appears to relate to displaying category/lyrical information to the user regarding downloaded audio content, and not directed to the actual download of video content.

¹⁴ See "The History of Recordings", Recording Industry of Association, retrieved from <http://www.riaa.com/issues/audio/hisotry.asp> on September 19, 2006. See also the "History of CD Technology", citing as a source "The compact Disc Handbook, 2nd Edition," by Ken C. Pohlmann, retrieved from <http://www.oneoffcd.com/info/hisotrycd.cfm> on September 19, 2006.

Art Unit: 3992

complex digital video files, such as DVD players, were not routinely available until the late 1990(s), and even these devices initially only read video data from read-only DVD disks capable of storing large digital video files, not from video data downloaded (recorded) from a remote server via a communications network.¹⁵ Thus, it is not clear how the originally disclosed, integrated circuit 50 of the user would have had the processing power to decode and playback downloaded, digital video signals. For the same reasons, it is also not clear how the originally disclosed, incoming RAM 50c and playback RAM 50d could have supported storage of downloaded video and playback.

Further regarding the equipment of the user (consumer), in 1988 a large capacity drive for a user (e.g., 3.5 inch form factor) was around 30 megabytes¹⁶, yet the digital bandwidth required to transmit a video signal at even VHS quality was 1.5 megabits per second (approximately 30 megabytes in 3 minutes) and this even using a Moving Picture Coding Experts Group Standard "1" ("MPEG-1") video compression technology not even available in 1988.¹⁷ Thus, it is not clear how downloaded video files of any appreciable or viable size would have been downloaded and stored on originally disclosed hard disk 60 of the user in the original specification.

¹⁵ See the "History of MPEG", University of California, Berkeley, School of Information Management and Systems, retrieved from <http://www2.sims.berkeley.edu/courses/is224/s99/GroupG/report1.html> on September 19, 2006. See also the "History of CD Technology", citing as a source "The compact Disc Handbook, 2nd Edition," by Ken C. Pohlmann, retrieved from <http://www.oneoffcd.com/info/hisotrycd.cfm> on September 19, 2006.

¹⁶ See "IBM HDD Evolution" chart, by Ed Grochowski at Almaden, retrieved from http://www.soragereview.com/guideImages/z_ibm_sorageevolution.gif on September 19, 2006.

¹⁷ See the "History of MPEG", University of California, Berkeley, School of Information Management and Systems, retrieved from <http://www2.sims.berkeley.edu/courses/is224/s99/GroupG/report1.html> on September 19, 2006.

Regarding the equipment used at the library (server), even large mainframe computers (e.g., IBM mainframe computers) typically only provided hard drives with capacity well below 10 gigabytes.¹⁸ Thus, it is not clear how even a small-sized video library, with its steep bandwidth (storage) requirements (as discussed above), would have been stored in the hard disk 10 of the copyright holder in the original specification, without requiring details directed toward a complex mainframe operating environment.

Regarding the transfer of these large video files over a network, the proliferation of broadband communication network capable of delivering these large files to consumers simply did not exist or were not well known in 1988. Furthermore, it is not clear how the digital video would have been coded and decoded during transmission, as digital video coding standards for purposes of transmission and file downloading were not settled in 1988. As an example of the above points, the MPEG-1 standard, which was designed to code/decode digital video information and to transmit the video via a telephone (telecommunications) network in NTSC (broadcast) quality for archiving, was only established in 1992.¹⁹

Thus, based on the evidence regarding each of the above factors, the specification, at the time the Parent application was filed, would not have taught one skilled in the art how to make and/or use the full scope of the claimed invention without undue experimentation.

¹⁸ IBM HDD Evolution chart, *supra*.

¹⁹ History of MPEG, *supra*.

Claim Rejections Based on Bush

Claim Rejections - 35 USC § 103

The following is a quotation of 35 U.S.C. 103(a) which forms the basis for all obviousness rejections set forth in this Office action:

(a) A patent may not be obtained though the invention is not identically disclosed or described as set forth in section 102 of this title, if the differences between the subject matter sought to be patented and the prior art are such that the subject matter as a whole would have been obvious at the time the invention was made to a person having ordinary skill in the art to which said subject matter pertains. Patentability shall not be negated by the manner in which the invention was made.

Claims 1-6 and 44-49 are rejected under 35 U.S.C. 103(a) as being unpatentable over United States Patent No. 4,789,863 ("Bush"), of record, in view of U.S. Patent No. 4,949,187 ("Cohen"), of record.

The filing date of the Cohen patent is December 16, 1988. The earliest priority date of the '573 patent under reexamination however is September 18, 1990, as discussed extensively above in the "Intervening Printed Publication" section (9) above. Thus, Cohen is available as 102(e) type prior art.

Regarding **claim 1**,

A method for transmitting a desired digital audio signal stored on a first memory of a first party to a second memory of a second party comprising the steps of:

Bush teaches transmitting a desired digital, audio or video signal (col. 2, ll. 18-29 and col. 3, ll. 26 - 35). The digital audio or video signals are stored on compact disc machines 41-46 (first memory) of a pay per view entertainment system provider associated with source 10 (first

party) (Figs. 1, 4 and col. 2, ll. 19-47). The digital signals are transmitted via a network to the consumer's receiver 14 (Fig. 1) (also illustrated as receiver 100 in Fig. 5, see also col. 3, ll. 14-17). The signals are stored on cassette recording unit and an associated cassette tape (second memory) (Fig. 5 and col. 4, ll. 1-11). Note that the second memory is also a compact disc recorder (col. 10, claim 14) and thus the second memory is also a CD.

transferring money electronically via a telecommunication line to the first party at a location remote from the second memory and controlling use of the first memory from the second party financially distinct from the first party, said second party controlling use and in possession of the second memory;

Bush teaches that money is electronically transferred via a telephone line (telecommunications line) and clearing house 200 to the source 10 (first party) by way of a credit card transaction (Fig. 3 and col. 2, ll. 58-63, col. 4, ll. 44-47, col. 5, ll. 1-3, col. 6, ll. 25-28, and ll. 45-48). The first party's location (source 10) is remote via a network from the consumer (Fig. 1). The second party (consumer) commands the download of audio/video from the memories of the first party (source 10) (Fig. 7, col. 1, ll. 59-64, and col. 6, ll. 11-48). Thus, the first memory is controlled from the second party. Clearly, the second party (consumer) is financially distinct from the first party (source 10). The second party (consumer) also controls the use and also possesses the second memory, such as by the ability to determine what contents are stored in the second memory (col. 6, ll. 11-48)

connecting electronically via a telecommunications line the first memory with the second memory such that the desired digital audio signal can pass therebetween;

The limitation broadly recites "a telecommunications line," which lacks antecedent basis to the previous recitation of a telecommunications line. The examiner interprets a "telecommunications line" to mean a electronic medium of communicating between computers, which requires end-to-end connectivity, which is an interpretation that could include the Internet and that is consistent with an interpretation advanced by the appellant and adopted by the district court. Sightsound.com Inc. v. NSK, Inc. Cdnow, Inc., and Cdnow Online, Inc., Civil Action No. 98-118, pp. 50 and 57 (District Court for the Western District of Pennsylvania, Feb. 2002). The appellant has not characterized the claimed invention differently in this reexamination proceeding. See for example, the Declaration by Arthur R. Hair, filed on December 27, 2005, especially paragraphs 4-6. Here, Bush teaches of a cable system (electronic medium) that provides end-to-end communications between computer at the central cable system associated with source 10 and the consumer's computer (Figs. 1, 2 and 5). The audio and video files are downloaded via the telecommunications line and thus connect the first and second memories, as discussed above.

transmitting the desired digital audio signal from the first memory with a transmitter in control and possession of the first party to a receiver having the second memory at a location determined by the second party, said receiver in possession and control of the second party; and

The desired digital audio or video signal is transmitted from the first memory as discussed above using a transmitter (Fig. 4, CADA transceiver 40) in control (col. 2, ll. 18-21) and possession of the first party, such as when the first party (source 10) determines what contents are stored in the first memory (col. 2, ll. 30-42). The second party (consumer)

determines the location to which the audio/video data is transmitted as broadly recited by the claims, such as when the consumer operates the invention by turning on the television and interacts with the pay per view channel at a location (e.g., consumer's home) determined by the consumer. The receiver 14 includes a cassette tape (or CD) (as discussed above) that is in possession and control of the second party (col. 1, ll. 59-64).

storing the digital signal in a non-volatile storage portion of the second memory, wherein the non-volatile storage portion is not a tape or a CD.

The received audio/video digital signal is stored in the second memory (cassette tape or CD) associated with the second party (consumer) as discussed above (i.e., a non-volatile storage portion of the second memory). See also col. 5, ll. 24-52.

Bush however fails to disclose that the non-volatile storage is "not a tape or a CD."

Cohen however (similarly to Bush, see the section 102 claim rejections based on Cohen in this Office action for additional details) teaches of an audio and video downloading system that also uses a magnetic, hard disk (non-volatile storage that is not or a CD) (col. 4, l. 64 – col. 5, l. 4).

The suggestion/motivation for adding the hard disk as taught by Cohen to Bush would have been to more efficiently access audio and video files because "magnetic media, such as hard disk drives....permit an almost unlimited number of read/write cycles...." (Cohen, col. 4, ll.

3-7). Storing data on magnetic media, such as a hard-disk, would have also increased the security and reliability of the stored data because magnetic, hard disks retain data when the power to the unit is removed (i.e., non-volatile) as would have been notoriously well-known in the art at the time the invention was made.

Therefore, to one of ordinary skill in the art at the time the invention was made, it would have been obvious to add a hard disk as taught by Cohen to the system taught by Bush.

Claim 4 differs substantively from claim 1 in that claim 4 recites that digital "video" signal is transmitted (downloaded) as opposed to the audio signal in claim 1. However, the claim 1 rejection clearly explained how Bush teaches that both audio and video digital signals are downloaded. Therefore, see the claim 1 rejection for additional details.

Claims 44 and 47 differ substantively from claims 1 and 4 in that claims 44 and 47 recite specifically that the second memory includes a second party hard disk. This limitation was addressed in the claim 1 rejection above regarding the obvious addition of a hard disk. Therefore, see the claims 1 and 4 rejections above for additional details.

Regarding **claims 2, 5, 45, and 48**, after the money transfer step, the recording system searches for a recording signal from the remote library (e.g., forward and reverse roll commands) and then for a subsequent video/audio file from the remote library for the purposes of recording,

where the video/audio file is stored in the first memory, as discussed above (col. 5, ll. 35-44 and col. 6, ll. 23-48).

Regarding **claims 3, 6, 46, and 49**, Bush teaches of a system for downloading audio and video files from a central library to a user, where the user pays for the audio files and stores the audio files (abstract and Figs. 1 and 6). Bush also teaches that the user provides a credit card number to the second party (library) (col. 4, ll. 44-47, col. 5, ll. 1-3, col. 6, ll. 25-28, and ll. 45-48).

Claims 1-6 and 44-49 are rejected under 35 U.S.C. 103(a) as being unpatentable over Bush in view of U.S. Patent No. 4,837,797 ("Freeny I"), of record.

The claim rejections based on Bush in view Freeny I differ from the claim rejections based on Bush in view of Cohen above in that Freeny I, instead of Cohen, is relied upon to teach a non-volatile storage portion of the second memory that is not a tape or a CD (e.g., a hard disk). Freeny I however is available as 102(e) prior art regardless of the effective filing date of the '573 patent. See the Bush in view Cohen rejection above for additional details regarding the specific teachings of Bush.

Freeny I (similarly to Bush) teaches of a device that receives and stores audio data (abstract) and that also stores the received messages on a non-volatile storage portion that is not a tape or a CD (e.g., a hard disk) (col. 5, ll. 20-25).

The suggestion/motivation for adding the hard disk as taught by Freeny I to Bush would have been to more efficiently access audio and video files because magnetic media, such as hard disk drives permit an almost unlimited number of read/write cycles. Storing data on magnetic media, such as a hard-disk, would have also increased the security and reliability of the stored data because magnetic, hard disks retain data when the power to the unit is removed (i.e., non-volatile) as would have been notoriously well-known in the art at the time the invention was made.

Therefore, to one of ordinary skill in the art at the time the invention was made, it would have been obvious to add a hard disk as taught by Freeny I to the system taught by Bush.

Claim Rejections Based on Cohen

Claim Rejections - 35 USC § 102

Claims 1, 2, 4, 5, 44, 45, 47, and 48 are rejected under 35 U.S.C. 102(e) as being anticipated by Cohen.

The filing date of the Cohen patent is December 16, 1988. The earliest priority date of the '573 patent under reexamination however is September 18, 1990, as discussed extensively above in the "Intervening Printed Publication" section (9) above. Thus, Cohen is available as 102(e) type, intervening prior art.

With respect to **claim 1**, Cohen clearly teaches a method for transmitting a desired digital movie signal (abstract) comprising video and audio components (col. 1, ll. 7-12 and ll. 46-50) of a first party (central source of audio and video data, Fig. 4) to a second memory (disk storage system 114) of a second party (home viewer) (abstract). Money is electronically transferred via a telephone (telecommunication) line, where the first (central source) and second party (home viewer) is clearly financially distinct (abstract and Fig. 4, telephone line 60). The desired digital movie (video and audio) is in the first memory (principal on line movie storage 12-26, Fig. 4) is connected to and transferred via the telephone (telecommunications) line 60 to the second memory (disk storage system 114), where it is stored (col. 4, ll. 1-68). The digital signal is stored in a non-volatile storage portion of the second memory, that is not a tape or a CD (i.e., the hard disk) (col. 4, l. 64 – col. 5, l. 4).

Claim 4 differs substantively from claim 1 in that claim 4 recites that digital "video" signal is transmitted (downloaded) as opposed to the audio signal in claim 1. However, the claim 1 rejection clearly explained how Cohen teaches that both audio and video digital signals are downloaded. Therefore, see the claim 1 rejection for additional details.

Claims 44 and 47 differ substantively from claims 1 and 4 in that claims 44 and 47 recite specifically that the second memory includes a second party hard disk. This limitation was addressed in the claim 1 rejection above. Therefore, see the claims 1 and 4 rejections above for additional details.

Regarding claims 2, 5, 45, and 48, see col. 4, ll. 19-29 and ll. 47-63, where after the money transfer (accounting) step, the system searches for the desired selection by the home viewer and commences downloading.

Claim Rejections - 35 USC § 103

Claims 3, 6, 46, and 49 are rejected under 35 U.S.C. 103(a) as being unpatentable over Cohen as applied to the claims above, and further in view of Bush.

Cohen teaches of telephoning the first party controlling use of the first memory and transferring money (as discussed above in the claim 1 rejection). Cohen however fails to teach providing a credit card number of the second party.

Bush teaches (similarly to Cohen, see the Bush, claim 1 rejection above) of a system for downloading audio and video files from a central library to a user, where the user pays for the audio files and stores the audio files (abstract and Figs. 1 and 6). Bush also teaches that the user provides a credit card number to the second party (library) (col. 4, ll. 44-47, col. 5, ll. 1-3, col. 6, ll. 25-28, and ll. 45-48).

The suggestion/motivation for providing a credit card number to the second party would be to reduce the expenses involved in operating a download service, because financial service organizations, such as credit card organizations, "enable the source 10 to [be] paid be a service

fee for the subscriber's use of the system." Bush, col. 2, ll. 58-63. Obviously, providing a credit card number would have been required to use the services of a credit card organization.

Therefore, it would have been obvious to one of ordinary skill in the art at the time the invention was made to add the step of the user providing a credit number to the second party as taught by the audio/video download system of Bush to the audio/video download of Cohen, which teaches that the user pays for the download.

Claim Rejections Based on Akashi

Claim Rejections - 35 USC § 103

Claims 1-6 and 44-49 are rejected under 35 U.S.C. 103(a) as being unpatentable over Japanese Patent Application No. 62-284496 ("Akashi") using the English translation of record, in view U.S. Patent No. 4,528,643 to Freeny ("Freeny II").

Regarding **claims 1, 3, 4, 6, 44, 46, 47, and 49**, Akashi discloses a system for automatically selling recorded music via telecommunication lines (Page 1 through line 1 of Page 2). This system utilizes the telecommunications lines to transmit the recorded music data from a host computer that stores the recorded music data to a personal computer (Page 2 Section 4), which meets the limitation of connecting electronically via telecommunications line the first memory with the second memory such that the desired digital audio signal can pass therebetween, transmitting the desired digital audio signal from the first memory with a transmitter in control and possession of the first party to a receiver having the second memory at

a location determined by the second party, said receiver in possession and control of the second party, storing the digital signal in the second memory.

Akashi discloses that the digital music data is purchased automatically but does not expressly detail how the purchase is transacted and whether the data is stored on a non-volatile storage portion of the second memory that is not a tape or a CD.

Freeny II discloses a method of electronically distributing and selling audio and video data by way of having the requesting user transmit a consumer credit card number along with their request for the audio and video data (col. 13, lines 25-29). This step allows the owner of the data to approve the sale and charge the sale to the consumer credit card number (col. 13, lines 30-31), which meets the limitation of transferring money electronically via a telecommunications line to the first party at a location remote from the second memory and controlling use of the first memory from the second party financially distinct from the first party, said second party controlling use and in possession of the second memory, the transferring step includes the steps of telephoning the first party controlling use of the first memory by the second party, providing a credit card number of the second party controlling the second memory to the first party controlling the first memory so the second party is charged money. Freeny II also discloses that the received audio and video data is stored on a non-volatile storage that is not a tape or CD (e.g., a hard disk) (col. 5, l. 23-25).

The suggestion/motivation for combining Akashi with Freeny II would have been because this method of electronic sale allows the owner of the information to receive directly the compensation for sale of recording and such compensation is received before the reproduction is authorized as taught in Freeny II (col. 13, lines 36-39). The use of a hard disk would have allowed the user to more efficiently access audio and video files because magnetic media, such as hard disk drives, permit an almost unlimited number of read/write cycles. Furthermore, storing data on magnetic media, such as a hard-disk, would have also increased the security and reliability of the stored data because magnetic, hard disks retain data when the power to the unit is removed (i.e., non-volatile) as would have been notoriously well-known in the art at the time the invention was made.

Therefore, it would have been obvious to one of ordinary skill in the art at the time the invention was made to have the requesting user's of Akashi transmit a consumer credit card number along with their request for the digital data so that the source unit could approve and charge the sale of the digital data to the consumer credit card and to store the received audio and video data on a hard disk (non-volatile storage that is not a tape or CD) as taught by Freeny II.

Regarding **claims 2, 5, 45, and 48**, Akashi discloses that personal computer contains a CPU (Figure 1). The personal computer sends an access signal to the host computer, and the host computer returns a response signal that contains menu data displayed at the personal computer (page 3, paragraph 6). Using the monitor screen, the user chooses desired data using a control unit and sending the selection data to the host computer in the same way the initial transmission

was sent (page 4, paragraph 1), which meets the limitation of the steps of searching the first memory for the desired digital audio signal and selecting the desired digital audio signal from the first memory.

(10) Response to Argument

I. Summary

On pages 6-9 of the Brief, the appellant provides a summary. The examiner responds with the following summary.

The claims of the '573 patent are broadly directed to downloading audio and video content via the Internet. For example, claims 1 and 4 recite downloading audio and video content via a telecommunications line, where a district court, consistent with the appellant's arguments in that proceeding, held that the term "telecommunications line" may include the Internet.²⁰ The appellant has not characterized the claimed invention differently in this reexamination proceeding. See for example, the Declaration by Arthur R. Hair, filed on December 27, 2005, especially paragraphs 4-6.

In view of the important and broad nature of these claims, the examiner carefully reviewed the prior art of record. Claims in an *ex parte* reexamination proceeding will be examined on the basis of patents or printed publications. 37 CFR 1.552. Here, the examiner

²⁰ Sightsound.com Inc. v. NSK, Inc. Cdnow, Inc., and Cdnow Online, Inc., Civil Action No. 98-118, pp. 50 and 57 (District Court for the Western District of Pennsylvania, Feb. 2002).

examined the claims of the '573 patent on the basis of printed publications, such as the intervening Cohen patent, which was never applied during the original prosecution of the application that issued as the '573 patent. The examiner may use an intervening printed publication, such as the Cohen patent, where the patent claims under reexamination are entitled only to the actual filing date of said patent and are not supported by an earlier patent. 35 U.S.C. 120. See also MPEP § 2258.I.C. See also MPEP § 201.11(B), where the examiner may use an intervening printed publication and the applicant may respond by showing that conditions for claiming the benefit of the prior application have been met. In the instant reexamination proceeding, the appellant's response focused not upon a showing that conditions for claiming the benefit of an earlier filing date were met, but instead upon the argument that the examiner has no authority to apply an intervening printed publication. Such a response is unsurprising, since a substantial amount of new text, not found in the Parent application as originally filed on the date whose benefit is sought, was systematically added in a series of amendments to both the Parent and Child applications. That is, although the Parent and Child applications were alleged to be related as continuation applications, the specifications of said Parent and Child are objectively incongruent.

Indeed, the appellant failed to even dispute teachings of the newly applied Cohen publication, which is also unsurprising, because the Cohen publication teaches features regarding downloading and storing audio and video that are highly pertinent to the claims of the '573 patent.

Neither did a section 120 issue "necessarily arise." The prosecution history of the '573 patent fails to show that the examiner had reason to consider the propriety of a benefit claim set forth in the '573 patent, and the record does not contain any written discussion or consideration of such benefit claim. The original examiner did not make a determination regarding the priority date for the asserted claims with respect to any reference, much less an intervening reference, such as Cohen. Although the examiner addressed some new matter issues in a single, non-final rejection in the Child application, the rejection only facially raised the issue of new matter in the Child application that was then being examined at the time, not the distinct issue of whether the actual filing date of the Child application is entitled to extend to the filing date of the earlier Parent. See sections III.A. and III.B.1 below for additional details. Thus, any argument by the appellant that said new matter rejection was based on the specification of the Parent application, as originally filed, is speculation.

Furthermore, said new matter rejection only touched upon a subset of the new matter issues described in Table I above in this reexamination proceeding. See section III.B.1 below for additional details. Thus, any argument by the appellant that said new matter rejection addressed all the same new matter issues that were addressed in the instant reexamination proceeding contradicts the evidence.

Thus, the determination as to whether entitlement to the filing date of the earlier Parent application would allow the appellant to antedate the intervening Cohen printed publication, thereby removing it as a reference against the claims, is an open question that was properly

addressed in this reexamination proceeding. For the reasons previously discussed, the examiner determined that the effective filing date of the claims in '573 patent under reexamination, which issued from the Child application, is September 18, 1990 (at the earliest), which is the actual filing date of the Child application. Thus, the intervening Cohen patent is available as prior art.

II. Prosecution History of the '573 Patent

On pages 9-13 of the Brief, the appellant characterizes the prosecution history of the '573 patent. The examiner does not agree with this characterization, especially regarding the selective highlighting of amendments to both the specification and claims. The relatively brief and complete prosecution history of both the Parent and Child speaks for itself and is available in the image file wrapper ("IFW") for U.S. Application No. 07/586,391 (Child), which also contains the prosecution history of U.S. Application No. 07/296,497 (Parent).

III. The Appropriate Date for the Claims of the '573 Patent Is September 18, 1990, At the Earliest

On pages 13 and 14 of the Brief, the appellant argues that the Office lacks the authority in reexaminations to "reassign" priority dates for originally issued claims in the absence of a previous continuation-in-part application. Specifically, the appellant argues that "reexamination statutes do not empower the Office to examine claims for issues of effective priority date in the absence of a continuation-in-part in the original examination history." The patent also argues

that the "Board should vacate the Examiner's findings because the issue was thoroughly dealt with by Examiner Nguyen during the initial examination of the '573 patent...."

Appellant arguments are unpersuasive. As discussed in Section I above, an examiner may use an intervening printed publication, such as the Cohen patent, where the patent claims under reexamination are entitled only to the actual filing date of said patent. 37 CFR 1.552, 35 U.S.C. 120, MPEP § 2258.I.C, and MPEP § 201.11.(B). The appellant has failed to cite to any law or procedure that prohibits the Office from applying intervening printed publications during an *ex parte* reexamination proceeding in the absence of a continuation-in-part. In contrast, the examiner relies upon long-standing procedure specifically authorized by the Office. A rejection may be made in an *ex-parte* reexamination proceeding based on an intervening printed publication, in accordance with 37 CFR 1.552, whenever patent claims under reexamination, in accordance with 35 U.S.C. 120, are entitled only to the filing date of the patent under reexamination. Specifically:

Rejections may be made in reexamination proceedings based on intervening patents or printed publications where the patent claims under reexamination are entitled only to the filing date of the patent and are not supported by an earlier foreign or United States patent application whose filing date is claimed. For example, under 35 U.S.C. 120, the effective date of these claims would be the filing date of the application which resulted in the patent. Intervening patents or printed publications are available as prior art under *In re Ruscetta*, 255 F.2d 687, 118 USPQ 101 (CCPA 1958), and *In re van Langenhoven*, 458 F.2d 132, 173 USPQ 426 (CCPA 1972). See also MPEP § 201.11

MPEP § 2258.I.C, Scope of Reexamination (emphasis added). See also MPEP § 2217.

Furthermore, no priority dates have been "reassigned" by the examiner. Rather the examiner simply applied an intervening reference, which is a printed publication (U.S. patent).

The appellant could have responded by amending the claims of the patent under reexamination, such that the subject matter of the claims is clearly possessed in the earlier patent, thus allowing entitlement to the benefit of the filing date of the earlier patent. The appellant declined to do so.

The appellant could have also responded by simply correcting the benefit claim or showing that the conditions for claiming benefit to the priority date have been met. MPEP 201.11(B). The appellant declined to do so.

The appellant also had yet another option for responding. The appellant could have simply argued that the intervening printed publication does not read upon the claims. The appellant declined to do so.

III.A. The Office Acts Within Its Authority In Considering Issues of Priority During a Reexamination

The Office has Jurisdiction to Apply Intervening Patents and Printed Publications in a Reexamination Proceeding To a Patent that Seeks the Section 120 Benefit to the Filing Date of an Earlier Filed Application

On pages 14 of the Brief, the appellant argues:

It is well established that the scope of a reexamination proceeding is limited to whether claims are patentable under 35 U.S.C. §§ 102 and 103 "on the basis of patents and printed publications." 37 C.F.R. § 1.552. The reexamination rules explicitly preclude consideration of issues arising under 35 U.S.C. § 112, except "with respect to subject matter added or deleted in the reexamination proceeding." *Id.*; see also *In re Etter*, 756 F.2d 852, 856 (Fed. Cir. 1985) (en banc) ("only new or amended claims are also examined under 35 U.S.C. §§ 112 and 132").

Appellant arguments are unpersuasive. The claims of the '573 patent were examined on the basis of printed publications, such as the intervening Cohen patent, where the claims were entitled only to the actual filing date of '573 patent. 37 CFR 1.552, 35 U.S.C. 120, MPEP § 2258.I.C, and MPEP § 201.11.(B). Applying 35 U.S.C. § 120 neither requires nor implies that the specification of the '573 patent under reexamination is itself being subjected to a 35 U.S.C. § 112 analysis. Indeed, none of the original six patent claims of the '573 patent have been rejected pursuant to section 112. Rather it is the specification(s) of the separate Parent application that is being analyzed on that basis. For example, the examiner has taken the position that the Parent application, as originally filed, does not describe certain features recited in the claims of the instant '573 patent under reexamination. The examiner does not argue that the specification, including the claims, of '573 patent under reexamination fails to establish possession of the claimed invention, but rather whether possession of the claimed invention was established before the filing date of the '573 patent in a different U.S. application.

An Inquiry Under Section 120 Does Not Revisit Any Substantial Question of Patentability Necessarily Raised and Previously Decided by the Examiner During Prosecution of the Application Corresponding to the '573 Patent

On page 14 of the Brief, the appellant argues that an:

[I]nquiry under Section 120 as to whether the language of a particular claim, as filed or amended during an original prosecution, was supported or unsupported by sufficient disclosure is, by definition, not a *new* question.

Appellant arguments are unpersuasive. A substantial new question of patentability was raised in this proceeding based on prior patents or printed publications identified in the Request for Reexamination, filed on January 31, 2005 (and as detailed in the Order Granting the Request for *Ex Parte* Reexamination, mailed March 18, 2005). Therefore, the issue of whether a 35 U.S.C. 120 inquiry raises a substantial new question of patentability is irrelevant.

Nonetheless, an inquiry under section 120 does not revisit any substantial question of patentability previously decided by the examiner during prosecution of the application corresponding to the '573 patent. Substantial questions of patentability are "old" only in respect to previously considered patents or printed publications, i.e., those questions based on "old art." See MPEP 2242.II. The new intervening patents applied in this reexamination proceeding, such as Cohen, were not previously considered during prosecution of application leading to the '573 patent under reexamination, and thus do not raise questions of patentability previously considered by the original examiner.

The appellant then argues on page 14 of the Brief that:

Rather, it is an issue that necessarily arises at the time of original filing or amendment, and one that necessarily is before the original examiner.

Appellant arguments are not persuasive. As discussed above, substantial questions of patentability are "old" only in respect to previously considered patents or printed publications.

Nonetheless, a section 120 issue does not "necessarily" arise, as argued by the appellant above, during prosecution of the continuing application leading to patent, thereby precluding all further consideration of priority issues by the Office after the patent issues. Regarding a continuing application, only if an examiner determines that the claims in the later-filed application are not entitled to the benefit of an earlier filing date should the examiner apply an intervening reference. MPEP 201.11 ("If the claims in the later-filed application are not entitled to the benefit of an earlier filing date, the examiner should:....(B)...use an intervening reference....") Thus, the lack of intervening rejection during the original examination may simply indicate that the examiner never determined whether the claims were entitled to the benefit of the earlier filing date, not necessarily the more sweeping conclusion that the examiner determined the claims were entitled to the benefit, as argued by the appellant. For example regarding continuing applications, the mere inclusion of prior application information in the patent does not necessarily indicate that the claims are entitled to the benefit of the earlier filing date. MPEP § 202.02. Furthermore, the examiner had no reason to consider the propriety of a benefit claim under section 120 during prosecution of the application leading to the '573 patent under reexamination. For example, the original examiner relied exclusively upon statutory bar

type (i.e., 102(b)) type prior art). Indeed, the '573 patent under reexamination lists no intervening references at all.

There are other examples of why a section 120 issue is not "necessarily" addressed during the original examination. In addition to the MPEP § 2258.I.C. as discussed above, the appellant himself may request a reexamination proceeding to correct a failure to adequately claim benefit under 35 U.S.C. 120, see MPEP § 2258.IV.E. Priority issues can also be considered in reissue proceedings, see MPEP § 1402. If a section 120 issue "necessarily" arises and is always completely disposed of during the original examination of a continuing application as argued by the appellant, then the above corrective procedures have no purpose, which is an untenable argument.

Instead of addressing whether the claims in the Child application were entitled to the filing date benefit of the Parent application, as originally filed, in view of an intervening printed publication, the examiner set forth a new matter rejection of the claims in the Child application in the absence of an intervening printed publication. The two lines of analysis are distinct, contrary to appellant attempts to conflate them. See section III.B.1. for additional details. Furthermore and nonetheless, the new matter rejection incompletely addressed all new matter issues identified in Table I above and the rejection did not clearly address the Parent specification as originally filed. See section III.B.1. for additional details.

Finally, the appellant admitted earlier in the reexamination proceeding that the original examiner did not address the issue of whether to apply intervening references against the original claims. Specifically, on pages 12 and 13 of the amendment filed on November 29, 2006, the appellant argued that the original examiner "could not – and did not – reassign priority dates to the original claims...." Thus, the use of intervening references is an open question that will be addressed in this reexamination proceeding.

Thus, there is insufficient evidence to conclude that a section 120 issue "necessarily" arose during the original prosecution. Indeed, there is evidence to the contrary. Thus, appellant's arguments amount to speculation that contradicts the evidence.

III.A.1. Whether There Is a CIP in the Prosecution History of the '573 Patent

On page 15 of the Brief, the appellant asserts that the "office admits the '573 patent in not a continuation-in-part, but then asserts that the '573 Patent 'shares the characteristics of a continuation-in-part."

The appellant however has not cited to a section in the final Office action where the examiner admitted that the '573 patent was not a continuation-in-part. The examiner has not determined where he made this admission. Thus, appellant's arguments that such an admission was made are unpersuasive.

III.A.2. The Reexamination Statute Empowers the Office To Apply Intervening Printed Publications During an Reexamination

Ruscetta and Langenhoven Nowhere Hold That Priority Determinations Under 35 U.S.C. 120 Are Limited To Continuation-in-Part applications, Nonetheless, the Application Corresponding to the '573 Patent Shares the Characteristics of a Continuation-in-Part in its Relationship to the Originally Filed, Parent Application

On page 16 of the Brief, the appellant argues that MPEP §§ 2258.I.C. and 2217 should be limited to situations where there was a continuation-in-part ("CIP") application because both of the cases cited for support are cases involving CIP(s), namely *In re Ruscetta*, 255 F.2d 687 (CCPA 1958) and *In re van Langenhoven*, 458 F.2d 132 (CCPA 1972).

Appellant arguments are not persuasive. *Ruscetta* and *Langenhoven* nowhere hold that rejections based on intervening printed publications during an *ex parte* reexamination procedure should be limited to continuation-in-part applications. Instead, both cases are directed to the use of intervening references against the claims of an application that seek the benefit of priority to an earlier filed application under 35 U.S.C. 120. The ability to use an intervening reference is not limited to continuation-in-part applications, but applies to any later filed application claiming benefit of a prior application under 35 U.S.C. 120, such as continuation applications. See MPEP § 201.11, "Claiming the Benefit of an Earlier Filing Date Under 35 U.S.C. 120 and 119(e)"....(B)... [t]he examiner may use an intervening reference in a rejection until applicant corrects the benefit claim or shows that the conditions for claiming the benefit of the prior application have been met." Both continuation and continuations-in-part applications are also related in that they both rely on priority under 35 U.S.C. 120 to obtain the benefit of an earlier filing date. MPEP § 201.11

Furthermore, continuation-in-part applications are related to continuation applications as a "continuing applications" under 37 CFR 1.53(b). Indeed, the application corresponding to the '573 patent under reexamination was filed under the old "file wrapper continuation" procedure, under which both continuation and continuation-in-part applications were filed under the same rule, 37 CFR 1.62. MPEP § 201.06(b), referring to MPEP, 8th Ed., 1st Revision, February 2003. http://www.uspto.gov/web/offices/pac/mpep/mpep_e8r1_0200.pdf). Here, the present reexamination proceeding uses intervening references against the claims of an alleged continuing application (the '573 patent) that seeks the benefit of priority to an earlier filed application under 35 U.S.C. 120, which is similar to the issues discussed in the Ruscetta and Langenhoven cases.

Nonetheless, as extensively discussed in the "Intervening Printed Publication" section (9) above, a review of the prosecution history provides clear and objective evidence that a significant amount of new text (directed to various features) was added in a series of amendments to the application corresponding to the '573 patent that was not present in the originally filed, Parent application. See for example, Tables I and II *supra*. Thus, the '537 patent being reexamined and the specification of the original, Parent application are not congruent, that is, they do not contain the same disclosure with respect to claim support issues. Thus, the application corresponding to the '573 patent shares the characteristics of a continuation-in-part in its relationship to the originally filed, Parent application. See 37 CFR 1.53.b.2 and MPEP § 201.08. That is, the consideration of any new matter in the December 11, 1991 amendment does not relate back to the specification as originally filed in the Parent application. For the same

reasons, the consideration of any issues in the Declaration, filed on June 25, 1992 would also fail to relate back to the Parent application as originally filed (even if the Declaration were considered persuasive, which it is not, as discussed in the "Intervening Printed Publication" section (9) above).

III.A.3. MPEP § 2258.IV.E. Empowers the Office to Address the Issue of Entitlement to a Priority Date of Claims in an Issued Patent

On page 17 and 18, the appellant argues that MPEP § 2258.IV.E. only applies where "there was an earlier failure to make...[a benefit] claim" whereas in the instant case, "Examiner Nguyen determined the '573 Patent was in fact entitled to that priority date." The appellant then admits that MPEP § 1402 "deals with adding or changing claims of priority, where an earlier claim contained an error or was not made at all" and that MPEP § 1405 "does address deletion of a priority claim in reissue." The appellant then repeats arguments that a rejection based upon an intervening printed publication is outside the scope of reexamination.

Appellant arguments regarding MPEP § 2258.IV.E are wholly unpersuasive. If 35 USC 120 issues must "necessarily" arise and be completely disposed of by examiner during the examination of a continuing application, as proposed by the appellant, then there would certainly be no failure to make a benefit claim in the first place, and MPEP § 2258.IV would be rendered useless, which is an untenable argument. Nonetheless, MPEP § 2258.IV.E also states that the appellant may correct a "failure to **adequately** claim...benefit under 35 U.S.C. 120 of an earlier

filed...application." Emphasis added. Such a statement does not equate to a simple failure to make a benefit claim contrary to appellant arguments. See section III.A for additional details.

Appellant's argument that the original examiner determined that the '573 patent was in entitled to the priority date is incorrect. Instead, the examiner set forth a new matter rejection in absence of any intervening reference, which is distinct from a priority determination for claims rejected by an intervening printed publication, contrary to appellant attempts to conflate these two issues. Furthermore and nonetheless, the new matter rejection incompletely addressed all new matter issues identified in Table I above and the rejection did not clearly address the Parent specification as originally filed. See section III.B.1 for additional details.

The corrective procedures discussed in MPEP § 1402 and 1405 also shows that priority issues are not "necessarily" addressed during the original examination of a continuing application.

Appellant's argument that that a rejection based upon an intervening printed publication is outside the scope of reexamination is unpersuasive. An examiner may reject the claims of a patent under reexamination on the basis of an intervening printed publication, such as the Cohen patent, where the patent claims under reexamination are entitled only to the actual filing date of said patent. 37 CFR 1.552, 35 U.S.C. 120, MPEP § 2258.I.C, and MPEP § 201.11.(B).

III.B. The Priority Date for the Claims in the '573 Patent Is a New Issue Related To Patentability

III.B.1. The Original Examiner Never Assigned a Priority Date of June 13, 1988 to the Claims in the '573 Patent

On page 19 of the Brief, the appellant argues:

The Office makes much of the fact that the '391 Application was filed pursuant to the old File Wrapper Continuation procedure, which permitted the filing of CIPs. However, as set forth above, MPEP § 201.06(b), in effect at the time the '391 Application was filed, required that a CIP application filed pursuant to the File Wrapper Continuation procedure include a new oath or declaration. Since Examiner Nguyen did not require a new oath or declaration, as a threshold matter she assigned the priority date of June 13, 1988 to the '391 Application when it was filed.

The examiner disagrees. The patent owner again makes a sweeping conclusion based upon the lack of affirmative acts and furthermore regarding a separate issue. The more reasonable conclusion is this lack of evidence fails to support a showing that the distinct issue of priority issue was addressed. For example, the mere lack of a new oath or declaration in the Child application coupled with the lack of any affirmative acts on the part of the examiner stating to the applicant that a declaration was not needed cannot be reasonably viewed as a sound basis for concluding the original examiner addressed the separate and distinct issue of whether the applicant was entitled to the benefit of filing date in the earlier parent application per 37 CFR 1.552, 35 U.S.C. 120, MPEP § 2258.I.C, and MPEP § 201.11.(B).

On pages 19-22 of the Brief, the appellant argues:

The foregoing chart shows that, following submission of the subject additions to the specification and corresponding amendments to the claims, Examiner Nguyen considered those additions and amendments in the Office Action of February 24, 1992. That consideration included an objection to the specification as containing new matter under Section 132, and corresponding rejections of the relevant claims under Section

Art Unit: 3992

112. The Applicant responded to, and overcame, that objection and those rejections in the Response of June 25, 1992. In that Response, the Applicant included arguments and a Declaration under 37 C.F.R. § 1.132 establishing that the additions to the specification had ample support in the originally filed specification because the subject matter of the additions was implicitly disclosed and understood by those skilled in the art. After considering this Response by the Applicant, Examiner Nguyen withdrew the objection to the specification and the Section 112 rejections of the claims, and thereby determined the claims were allowable. The amended chart set forth above demonstrates indisputably that Examiner Nguyen did consider the very same new matter and Section 112 rejections that the Office now asserts.

Appellant arguments flatly contradict the evidence.

First, the prosecution history fails to show the examiner ever made a priority determination for claims rejected by an intervening printed publication. Instead, the examiner set forth a new matter rejection in absence of any intervening reference, which is distinct, contrary to appellant attempts to conflate these two issues. For example, the new matter rejection only needed to establish whether the new matter at issue in the rejection was relative to the Child application as originally filed. Thus, the new matter rejection did not need to establish, and indeed did not establish, whether the new matter at issue in the rejection was relative to the original Parent application as originally filed, as would have been required in a full priority analysis. Specifically, in the Child application and subsequent to a series of amendments that added substantial new text to both the specification and claims of the Parent and Child applications, the examiner objected to "original specification" for failing to establish a basis for certain features. See pages 5 and 6 of the non-final Office action, mailed February 24, 1992, in the IFW record for the Child application. Thus, it is not clear whether the examiner referred to the Child specification as originally filed or to the Parent specification as originally filed. Thus, any argument by the appellant that said new matter rejection was based on the specification of the Parent application, as originally filed, is speculation.

Also unclear is on what basis the new matter rejection was withdrawn, indeed no reason was given. See the final Office action, mailed September 21, 1992. Thus, for this reason alone it is unclear if the new matter rejection was withdrawn on the basis of the Parent specification, as originally filed.

Nonetheless, although the applicant responded with an amendment and declaration on June 25, 1992, the applicant based support arguments upon both the specification as originally filed in the Parent application and on subsequent amendments that added the new text (e.g., "applicant have utilized the now questioned language in the claims and the Examiner has never question it. Only now, after 4 years does the Examiner raise a rejection based upon the same"). Thus, it is not clear whether the decision to withdraw the rejection was based upon support from the subsequent amendments that added new text instead of upon the Parent specification as originally filed.

Furthermore, the applicant characterized the new text as being introduced by a "preliminary amendment filed on the parent application....," however said preliminary amendment was submitted on December 22, 1988 almost 6 months after the filing of the original Parent specification and thus was not part of the original Parent specification. Thus, even the applicant arguments regarding the "preliminary" amendment where were not based upon the original Parent specification. Thus, it is not clear whether the decision to withdraw this rejection was based upon the Parent specification, as originally filed.

Thus, any argument by the appellant that said new matter rejection was withdrawn in response to applicant arguments about support in the Parent application, as originally filed, is also speculation.

Third, said new matter rejection only touched upon a subset of the new matter issues addressed in this reexamination proceeding as described in Table I above (see the section entitled "Intervening Printed Publications"), where Table I was used to show new matter issues in regard to the Parent application, as originally filed. As a starting point, consider the appellant's list of the new matter issues allegedly addressed by the original examiner on page 12 of the Brief. See also page 5 and 6 of the non-final Office action, mailed February 24, 1992. When these issues are compared to the issues in Table I, substantial differences are immediately noticed. A result of the comparison is provided in Table III below. **Bold face** means the new matter issue was not addressed by the original examiner in regard to the Parent application, as originally filed. *Italics* means that although the new matter issue was addressed in the Child application, it is not clear whether the new matter issue was also addressed in the regard to the Parent application, as originally filed.

Table III: Comparison of New Matters Issues Originally Addressed in the Child Application Versus New Matter Issues Addressed in the Instant Reexamination Proceeding

New Matters Issues Addressed in the Child Application (Whether Addressed In Regard to the Parent Application As Originally Filed Is Unclear)	New Matter Issues Addressed in the Reexamination In Regard to the Parent Application, As Originally Filed
Transferring Money	<i>Transferring Money from Second Party to a First Party (Charging a Fee)</i>
Second Party Financially Distinct from the First Party	Not Addressed
Receiver in Possession of the Second Party	<i>Receiver and Second Memory in Possession of Second Party</i>
Telephoning	Not Addressed
Providing a Credit Card	<i>Providing a Credit Card Number</i>
Not Addressed	Controlling Use of First/Second Memory
Not Addressed	Transmitting to a Location Determined by Second Party
Not Addressed	Specific Download Procedures
Not Addressed	First Party in Possession of Transmitter

Thus, appellant's argument that the "the amended chart set forth above demonstrates indisputably that Examiner Nguyen did consider the very same new matter and Section 112 rejections that the Office now asserts" is clearly contradicted by the evidence.

On page 22 of the Brief, the appellant argues:

In the Office Action in the instant reexamination dated March 17, 2007, the Office admitted that Examiner Nguyen did in fact address the issue of the alleged new matter shown in the table above. The Office further admitted that Appellant has effectively demonstrated as much through the table submitted with Appellant's Response to the Office Action of September 29, 2006.

The appellant has not cited to a section in the final Office action where these admissions were allegedly made, and the examiner has not determined where he made these admissions. Thus, appellant arguments that such admissions were made is unpersuasive. Indeed, appellant's argument that the original examiner addressed all the issues illustrated in Table I is contradicted by the evidence, as discussed above. Furthermore, appellant's argument that the new matter addressed in the Child application were in regard to the Parent application, as originally filed, is also speculative, as discussed above.

On page 22 of the Brief, the appellant argues that the "office's rejection amounts to a bogus rejection that fails to define what is meant by 'gradually added new matter.'"

The final Office action, which is repeated here in the Examiner's Answer, clearly defines how new matter was gradually added after the Parent specification was originally filed. Nonetheless, the prosecution history, available in IFW, even upon cursory inspection, speaks for itself.

III.B.2. The Absence of Rejections Based on Intervening References During the Initial Examination Demonstrates the Examiner Never Addressed the Issue of Priority

On page 23 of the Brief, that appellant argues that "[i]t is more plausible to conclude that no intervening references were cited because Examiner Nguyen properly concluded the '391 Application was entitled to the priority date of June 13, 1988."

Appellant arguments are unpersuasive and amount to speculation, which is also contradicted by evidence. First, the patent owner again makes a sweeping conclusion based upon the lack of affirmative acts (e.g., a lack of rejections based upon intervening references). The more logical conclusion is this lack of evidence fails to support a showing that the issue of intervening references was addressed. There is insufficient evidence to conclude that the original examiner considered the propriety of the benefit claim under section 120 to the Parent application as originally filed during prosecution of the Child application leading to the '573 patent under reexamination. Second, there is indeed evidence to the contrary. See section III.A above. Thus it would not be more plausible to conclude that no intervening references were cited for this reason. Rather, it would be speculation contradicting the evidence.

III.B.3. The Office Has Jurisdiction to Apply an Intervening Printed Publication in a Reexamination Proceeding

Patlex Makes Clear that It Does Not Apply to Situations Where the Sufficiency of the Parent Application Has Not Been Decided, Furthermore the Facts in the Patlex Case Differ Considerably from the Facts in the Instant Reexamination Proceeding

On pages 23-25 of the Brief, the appellant argues that in Patlex v. Quiqq, 680 F.Supp. 33, 6 USPQ2d 1296 (D.D.C. 1988), the United States District Court for the District of Columbia "addressed a situation substantially identical to the circumstances of the present reexamination" and held that where "an original examiner already has considered and determined the sufficiency of the specification's disclosure under Section 112 and the resulting entitlement of claims to an original priority date, there is no 'substantial new' question of patentability for reexamination..." and thus the "Office lacks jurisdiction to 'reexamine' that same issue for those same claims in a subsequent reexamination proceeding."

Appellant arguments are unpersuasive. The holding relied on by the appellant reads, in full, "hence, the Court concludes that the examiner and the Board lacked jurisdiction in this case to 'reexamine' the sufficiency of the specification of the 'great-grandparent' application." (Emphasis added). Id., at 37, at 1299. Obviously, this is not a broad holding that a 35 U.S.C. § 120 benefit claim can never be "reexamined" in a reexamination proceeding. Indeed, the Patlex court specifically, and rather clearly, went on to state that the "Court wishes to make clear that it is not deciding whether the Commissioner has jurisdiction in a reexamination to inquire into the sufficiency of the specification of a "parent" application where the sufficiency of the "parent" application vis-a-vis the claims of the patent being reexamined was not previously determined by

the PTO or a court."²¹ As discussed extensively above, the original examiner did not consider and determine the sufficiency of the specification in the originally filed, Parent application for the purposes of priority under 35 U.S.C. 120.

Indeed, the facts in the instant reexamination proceeding differ considerably from the facts in Patlex. In Patlex, the Court found that the issues were based upon the fact that the specification of the patent being reexamined was "essentially identical" to the specification of the great-grandparent application for which section 120 benefit was claimed (Id., at 34, at 1297) and that the claims of the great-grandparent were "directed essentially to the invention for [the patent being reexamined]." (Id. at 36, at 1299). In other words, in Patlex not only were the specifications essentially identical, but so were the claims. In contrast, and as discussed extensively above in the "Intervening Printed Publication" section (9) (see Tables I and II), the specification and the claims of the patent being reexamined are substantially different from the specification and claims of the original, Parent application for which section 120 benefit was claimed. A series of amendments subsequent the filing of the original, Parent application has added a substantial amount of new text to the specification and claims of both the parent application and the Child application, which issued as the '573 patent.

²¹ In another example, the Federal Circuit recently upheld a priority determination based upon a written description analysis raised by the Office during a reexamination proceeding initiated based on prior art raising a new question of patentability. In re Curtis, 354 F.3d 1347 (Fed. Cir. 2004). See also In re Modine and Guntly, 2001 WL 898541 (Fed. Cir. 2001) (unpublished) (finding lack of priority to an ancestor application during a reexamination of a patent where the reexam was initiated based on prior art raising a new question of patentability).

III.C. The Claims of the '573 Patent Are Not Entitled to the Benefit of Filing Date of the Parent Application, as Originally Filed

III.C.1. The Written Description of the Parent Application, as Originally Filed

III.C.1.i) The Proper Standard Is that the Original Written Description Must Actually or *Inherently* Disclose the Claim Element

On pages 25-28 of the Brief, the appellant argues that the "requirement of an inherency standard under Section 112 is unsupported by *Hyatt, Robertson, or Lockwood*."

Appellant arguments are unpersuasive. The written description must "actually or inherently disclose the claim element." Poweroasis, Inc. v. T-Mobile USA, Inc., 2008 WL 1012561, p. 6 (Fed. Cir. 2008). In the case of Hyatt v. Boone, 146 F.3d 1348, 47 USPQ2d 1128 (Fed. Cir. 1998) (emphasis added) (Certiorari Denied), to which the appellant refers to approvingly, is clear in this matter. When an explicit limitation in a claim "is not present in the written description whose benefit is sought it must be shown that a person of ordinary skill would have understood, at the time the patent application was filed, that the description requires that limitation." Id. at 1353 (emphasis added). "It is 'not a question of whether one skilled in the art might be able to construct the patentee's device from the teachings of the disclosure...Rather, it is a question whether the application necessarily discloses that particular device." Id. at 1353-4 (quoting from Jepson v. Coleman, 50 C.C.P.A. 1051, 314 F.2d 533, 536, 136 USPQ 647, 649-50 (CCPA 1963)) (emphasis added). The "written description must include all of the limitations...or the applicant must show that any absent text is necessarily comprehended in the description

provided and would have been so understood at the time the patent application was filed." Id. at 1354-55 (emphasis added).

The case of In re Roberston, 169, F.3d 743, 49 USPQ2d 1949 (Fed. Cir. 1999) was cited for its holding that "missing descriptive matter" that is "necessarily present" also goes to inherency. Id. at 745 (emphasis added). See also Poweroasis cited above.

The case of Lockwood v. American Airlines, Inc., 107 F.3d 1565, 41 USPQ2d 1961 (Fed. Cir. 1997) was cited to emphasize that, although the written description requirement requires that the application necessarily discloses a particular device to one of ordinary skill in the art at the time the application was filed, such a test should not devolve into an inquiry that "combined with the knowledge in the art, would lead one to speculate as to modifications that the inventor might have envisioned, but failed to disclosed." Id. at 1571.

Thus, when an explicit limitation in a claim is not present in the written description whose benefit is sought, such a limitation must be required (necessarily disclosed) by the written description. Thus, if the said limitation is not necessarily disclosed in (required by) the written description, it is not present in the written description.

III.C.1.ii) Claim 1 Through 6 in the '573 Patent Lack Written Description Support in the Originally Filed Specification

On pages 28-35 of the Brief, the appellant provides a chart to show that all of the limitations in claims 1-6 and 44-49 of the '573 patent were supported by the originally filed, Parent application.

Although the appellant's arguments have been duly considered, they are not deemed persuasive. While the chart is certainly appreciated, certain of the claim limitations addressed in the chart are not necessarily disclosed (required by) the written description of the originally filed, Parent application, and thus are not present in the said written description, as extensively discussed by the examiner in the "Intervening Printed Publications" section (9) *supra*. Thus, the effective filing date (priority) of the instant '573 patent under reexamination remains the latest date at which time the priority chain was broken, namely September 18, 1990 (at the earliest), which is also the actually filing date of the '573 patent.

III.C.2. The "Video Feature" of the Claims 4-6 Of the '573 Patent Was Not Enabled by the Originally Filed Specification

The Enablement Rejection of Newly Added, Video Download Feature Is Based on Factors, such as Undue Experimentation, and Not upon a "Mass Production" Standard as Argued by the Appellant

On pages 35-40 of the Brief, the appellant argues that, regarding the enablement of various video features recited in claims 4 through 6 by the Parent application, as originally filed,

the Office is attempting to apply a "mass production" standard when, "in actuality, the enablement standard of Section 112 has no such requirement."

Appellant arguments are unpersuasive. Claims 4 through 6 were not rejected under a 35 U.S.C., 112, 1st paragraph, enablement rejection. Nonetheless, the rejection under the enablement requirement of those newly introduced claims reciting a video download feature was explicitly based upon an undue experimentation factor. Nothing was stated about a "mass production" requirement. For example, the originally filed, Parent application teaches that data (not specifically video data) is transmitted via a telephone line. Yet the MPEG-1 standard, which was designed to code/decode digital video information and to transmit the video via a telephone (telecommunications) network in NTSC (broadcast) quality for archiving, was only established in 1992. See the 35 U.S.C. 112, 1st paragraph rejection *supra* for additional details. Thus, digital video coding standards for purposes of transmission and file downloading over a telephone line were not settled in 1988. Thus, it would not have been clear to one of ordinary skill how the digital video would have been coded and decoded during transmission over a telephone line. Such a question does not relate to mass production, but whether a single video downloading system as claimed could be made or used without undue experimentation by one of ordinary skill in the art in 1988 facing a lack of industry standards for transmitting digital, video data via a telephone line and also facing a limited disclosure of any video features whatsoever (except for the general statements at the end of the specification regarding video applicability) in the originally filed, Parent application.

III.D. Cohen Is Available as Prior Art

On page 41 of the Brief, the appellant argues that Cohen is not available as prior art. The publication date of the Cohen patent however is August 14, 1990. The earliest priority date of the '573 Patent under reexamination however is September 18, 1990, as discussed extensively above in the "Intervening Printed Publication" section (9) and the arguments above. Thus, Cohen is available as prior art.

IV. The Claims As Amended Are Neither Supported Nor Enabled by the Written Description

On pages 42 of the Brief, the appellant argues that the "Office may only examine the recitation of 'hard disk' for compliance with Section 112, first paragraph." This argument is unpersuasive however because the claims recite a new limitation directed to a "second memory including a second party hard disk," not simply a "hard disk" as argued. Accordingly, the final Office action included 112, 1st paragraph rejections regarding the download of video to a second memory and playback therefrom. Furthermore, "the question of new matter should be considered in a reexamination proceeding." MPEP 2258.II.B.

On pages 43-45 of the Brief, the appellant argues that the originally filed specification explicitly states that the disclosed invention eliminates the need to handle tapes and CDs. This argument however is not persuasive because the cited portion of the specification (p. 2, ll. 23-26) instead states that a hard disk "thus eliminat[es]...the need to unnecessarily handl[e]...tapes, or

compact discs on a regular basis." Thus, the specification as originally filed does not preclude the possibility that tapes and CDs are used to store the downloaded music, albeit not on a regular basis. This embodiment thus directly contradicts the newly introduced, negative limitations directed to a "non-volatile storage portion of the second memory, wherein the non-volatile storage portion is not a tape or a CD." Indeed by pointing to that part of the specification that teaches storing the data on a hard disk, the appellant's arguments support the position that the specification as originally filed teaches of a second memory in the form of hard disk, but fails to necessarily disclose (require) the broader, artificially created sub-genus corresponding to the negative limitation, namely a second memory that is not necessarily a hard disk, and that is also not a tape or CD either.

V. Based on the Proper Priority Date for the Claims in Reexamination, the Rejection of Claims 1 through 6 and 44-49 Based on Cohen are proper.

The earliest priority date of the '573 Patent under reexamination is September 18, 1990, as discussed extensively above in the "Intervening Printed Publication" section (9) and also in the arguments above. Thus, Cohen is available as prior art.

VI. Claims 1 through 6 and 44-49 Are Unpatentable Over the Other Applied Prior Art

VI.A. Rejections of Claims 1 through 6 and 44 through 49 under 35 U.S.C. § 103(a) Over Bush in View of Freeny

On page 48 of the Brief, the appellant argues that "Freeny I bears no relation to the disclosure of Bush or the invention recited in Claims 1 through 6 and 44 through 49. The Office

apparently has recognized this deficiency in Freeny I, because the Office must cite to Cohen to show motivation to combine Bush and Freeny I."

Appellant arguments are unpersuasive. As the rejection in the final Office action made clear, which is repeated here, Bush teaches the downloading and storing of audio and video data. Freeny I is relied for the unremarkable proposition that said stored audio and video data may be stored on a hard disk (i.e., "non-volatile storage portion is not a tape or a CD" as claimed). As stated in the final Office action, Freeny I (similarly to Bush) teaches of a device that receives and stores audio data (abstract). Thus, Freeny I and Bush are analogous prior art (devices that receive and store media data, such as audio).

On page 48 of the Brief, the appellant argues:

The Supreme Court's recent holding in *KSR Int'L Co. v. Teleflex Inc.*, 127 S. Ct. 1727 (U.S. 2007), does not relieve the Office of the obligation to show motivation to combine two separate references in making out a *prima facie* case of obviousness. Quite to the contrary, the Supreme Court stated: "[t]o determine whether there was an apparent reason to combine the known elements in the way a patent claims, it will often be necessary to look to interrelated teachings of multiple patents; to the effects of demands known to the design community or present in the marketplace; and to the background knowledge possessed by a person having ordinary skill in the art. *To facilitate review, this analysis should be made explicit.*" *KSR*, 127 S. Ct. at 1731 (emphasis added).

The final Office action, which is repeated here, showed an explicit motivation to add a hard disk to the teaching of Bush, which already disclosed downloading and storing audio and video data. Furthermore regarding KSR, the Court stated the "combination of familiar elements according to known methods is likely to be obvious when it does no more than yield predictable results." *Id.* at 1739. A "combination of familiar elements according to known methods is likely

to be obvious when it does no more than yield predictable results." *Id.* at 1731. Here, the combination of a hard disk with a system that stores audio and video data would yield predictable results, such as the efficient access to audio and video files because magnetic media, such as hard disk drives permit an almost unlimited number of read/write cycles. Other predictable results include increased security and reliability because magnetic hard disks retain data when the power to the unit is removed. Furthermore, storing audio and video data as taught by Bush does not affect the hard disk operational advantages as taught by Freeny I and vice versa. Thus, since the functionalities of Bush and Freeny I do not interfere with each other the results of the combination would have been a combination of familiar elements according to known methods to yield predictable results.

Furthermore, since each individual element and its function are shown in the prior art combination of Bush in view of Freeny I, the difference between the claimed subject matter and the prior art rests not on any individual element or function but in the very combination itself, that is, the substitution of a hard disk (i.e., "non-volatile storage portion is not a tape or a CD") with the tape/CD teachings of the primary references. An improvement is more than the predictable use of prior-art elements if the claimed subject matter involves more than the simple substitution of one known element for another or the mere application of a known technique to a piece of prior art ready for the improvement. *Id.* at 1731.

VI.B. Rejections of Claims 1 through 6 and 44 through 49 under 35 U.S.C. § 103(a) Over Akashi in View of Freeny II

On pages 49-52 of the Brief, the appellant arguments that Akashi teaches away because it teaches a recording device that is a compact disk or digital audio tape record are unpersuasive. The mere disclosure of an embodiment that will be substituted out does not constitute "teaching away." If it were otherwise, the simple substitution of one known element for another would not be obvious, contrary to the holdings in KSR. *Id.* at 1731. Furthermore, regarding KSR and for similar reasons discussed in section VI.A above, the functionalities of Akashi and Freeny II do not interfere with each other and the results of the combination would have been a combination of familiar elements according to known methods to yield predictable results. Furthermore for reasons similar to those discussed in section VI.A above, the claimed subject matter involves more than the simple substitution of one known element for another or the mere application of a known technique to a piece of prior art ready for the improvement.

VI.C. The Secondary Considerations of Non-Obviousness Fail to Support the Finding of Non-obviousness of Claims 1 through 6 and Claims 44-49

On pages 53-55 of the Brief, the appellant argues that secondary considerations of non-obviousness render those rejections based on 35 U.S.C. § 103 invalid.

However, as discussed above, those rejections were directed to adding a hard disk and a credit card transaction to a system that already teaches downloading and storing media (audio and video) data. Not surprisingly then, the examiner was able to make a strong *prima facie*

showing of obviousness in each of the rejections. Thus, even if the Appellant has established substantial evidence of secondary considerations, which it has not done here, see Leapfrog Enterprises, Inc. v. Fisher-Price, Inc., 458 F.3d 1157, 1162 (Fed. Cir. 2007), where the court held that substantial evidence of secondary considerations had been established, but "[g]iven the strength of the prima facie obviousness showing, the evidence on secondary considerations was inadequate to overcome a final conclusion that...[the claims] would have been obvious."

Nexus

An applicant who is asserting commercial success to support its contention of nonobviousness bears the burden of proof of establishing a nexus between the claimed invention and evidence of commercial success. MPEP § 716.03. The appellant has failed to establish such a nexus. The said Tygar declaration only characterizes the claimed invention in general terms (paragraphs 7 and 8). For example, the characterization of the claimed invention fails to discuss the secondary teachings relied upon in the subject 103 claim rejections, such as the addition of a "hard disk" to the second party or the use of a credit card transaction. As for the said Hair declaration, it fails to discuss the invention in terms of the claim language. Thus, the appellant has failed to establish a "nexus" between the merits of the claimed invention and the evidence of secondary considerations.

Commercial Success

On page 53 of the Brief, the appellant argues that the December 27, 2005 Declaration of Arthur R. Hair and the separate Declaration of Justin Douglas Tygar, Ph.D. establish commercial success.

Appellant evidence is unpersuasive. MPEP 716.03(b).I states in part:

In considering evidence of commercial success; care should be taken to determine that the commercial success alleged is directly derived from the invention claimed, in a marketplace where the consumer is free to choose on the basis of objective principles, and that such success is not the result of heavy promotion or advertising, shift in advertising, consumption by purchasers normally tied to applicant or assignee, or other business events extraneous to the merits of the claimed invention, etc. In re Mageli, 470 F.2d 1380, 176 USPQ 305 (CCPA 1973) (conclusory statements or opinions that increased sales were due to the merits of the invention are entitled to little weight); In re Noznick, 478 F.2d 1260, 178 USPQ 43 (CCPA 1973).

In ex parte proceedings before the Patent and Trademark Office, an applicant must show that the claimed features were responsible for the commercial success of an article if the evidence of nonobviousness is to be accorded substantial weight. See In re Huang, 100 F.3d 135, 140, 40 USPQ2d 1685, 1690 (Fed. Cir. 1996) (Inventor's opinion as to the purchaser's reason for buying the product is insufficient to demonstrate a nexus between the sales and the claimed invention.). Merely showing that there was commercial success of an article which embodied the invention is not sufficient. Ex parte Remark, 15 USPQ2d 1498, 1502-02 (Bd. Pat. App. & Inter. 1990). Compare Demaco Corp. v. F. Von Langsdorff Licensing Ltd., 851 F.2d 1387, 7 USPQ2d 1222 (Fed. Cir. 1988) (In civil litigation, a patentee does not have to prove that the commercial success is not due to other factors. "A requirement for proof of the negative of all imaginable contributing factors would be unfairly burdensome, and contrary to the ordinary rules of evidence.").

Here, the said Hair Declaration fails to establish that the commercial success was directly derived from the invention as claimed and that such success was not caused by other factors, such as heavy promotion or advertising. Indeed, the appellant has failed to provide a showing why the claimed features caused the commercial success. Merely showing that there was commercial success of an article which embodied the invention, which the appellant has done

Art Unit: 3992

here, is insufficient. The said Tygar Declaration suffers from the same defects. Although the Tygar Declaration at least attempts to characterize in general terms the claimed invention (paragraphs 7 and 8), this is response to a competing system (Napster) and not in regard to a showing of commercial success. Indeed, the portion of the Tygar declaration cited to by the appellant (paragraph 6) not only fails to relate to any claimed subject matter, but is based upon wholly unpersuasive evidence of commercial success. For example, the statement "Napster Light is a currently operating service with an apparently wide user base" is a conclusory and equivocating statement that even if assumed to be true, falls far short in showing commercial success.

Copying

MPEP § 716.06 states in part:

Another form of secondary evidence which may be presented by applicants during prosecution of an application, but which is more often presented during litigation, is evidence that competitors in the marketplace are copying the invention instead of using the prior art. However, more than the mere fact of copying is necessary to make that action significant because copying may be attributable to other factors such as a lack of concern for patent property or contempt for the patentees ability to enforce the patent. *Cable Electric Products, Inc. v. Genmark, Inc.*, 770 F.2d 1015, 226 USPQ 881 (Fed. Cir. 1985). Evidence of copying was persuasive of nonobviousness when an alleged infringer tried for a substantial length of time to design a product or process similar to the claimed invention, but failed and then copied the claimed invention instead. *Dow Chem. Co. v. American Cyanamid Co.*, 816 F.2d 617, 2 USPQ2d 1350 (Fed. Cir. 1987). Alleged copying is not persuasive of nonobviousness when the copy is not identical to the claimed product, and the other manufacturer had not expended great effort to develop its own solution. *Pentec, Inc. v. Graphic Controls Corp.*, 776 F.2d 309, 227 USPQ 766 (Fed. Cir. 1985). See also *Vandenberg v. Dairy Equipment Co.*, 740 F.2d 1560, 1568, 224 USPQ 195, 199 (Fed. Cir. 1984) (evidence of copying not found persuasive of nonobviousness) and *Panduit Corp. v. Dennison Manufacturing Co.*, 774 F.2d 1082, 1098-99, 227 USPQ 337, 348, 349 (Fed. Cir. 1985), vacated on other grounds, 475 U.S. 809, 229 USPQ 478 (1986), on remand, 810 F.2d 1561, 1 USPQ2d 1593 (Fed. Cir. 1987) (evidence of copying found persuasive of nonobviousness where admitted infringer failed to satisfactorily produce a solution after 10 years of effort and expense).

Here, the appellant presents in the Tygar Declaration some conclusory evidence that the invention was copied. However, more than the mere fact of copying is necessary to make that action significant because copying may be caused by other factors. Furthermore, the appellant has not provided evidence that the copier tried for a substantial length of time to design the system, but then copied the claimed invention instead.

Thus, the secondary evidence presented is not commensurate in scope to the claimed subject matter.

Conclusion

For the above reasons, it is believed that the rejections should be sustained.

Respectfully submitted,

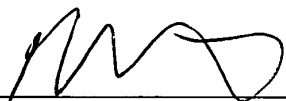

Roland G. Foster
Central Reexamination Unit, Primary Examiner
Electrical Art Unit 3992
(571) 272-7538

Conferees:



Scott Weaver
Central Reexamination Unit, Primary Examiner
Electrical Art Unit 3992
(571) 272-7548



Mark J. Reinhart
Central Reexamination Unit, SPE
Electrical Art Unit 3992
(571) 272-1611

Express Mail No.: EV 502961945 US

Control No.: 90/007,402



06/23/08

Attorney's Docket No. NAPS001

Patent

IN THE UNITED STATES PATENT AND TRADEMARK OFFICE

In re Application of: Arthur R. Hair : Group No.: 3992
 Serial No.: 90/007,402 : Examiner: Roland G. Foster
 Filed: January 31, 2005 : Confirmation No. 2998
 For: METHOD FOR TRANSMITTING A DESIRED DIGITAL VIDEO OR AUDIO SIGNAL

REPLY BRIEF ON APPEAL UNDER 37 C.F.R. § 41.41

Mail Stop Appeal Brief - Patents
 Commissioner for Patents
 P.O. Box 1450
 Alexandria, VA 22313-1450

Sir:

This reply is in response to the Examiner's Answer mailed April 24, 2008. This Reply is being filed within the two month time period set by regulation. No fee is believed to be due for this reply.

If any fees are due, please charge deposit account number 50-0573.

CERTIFICATE OF MAILING
 UNDER 37 C.F.R. 1.8(a)

I hereby certify that this paper, along with any paper referred to as being attached or enclosed, is being deposited with the United States Postal Service on the date indicated below, with sufficient postage, as Express mail, in an envelope addressed to: Commissioner for Patents, P.O. Box 1450, Alexandria, VA 22313-1450.

BY *Katya H' Oliveira*
 DATE: *June 23, 2008*

6575772300 15N 151E 00000001 90007402
 01 FC:1403 1030.00 0P

Real Party in Interest

Appellant's real party in interest is:

DMT Licensing, LLC (a wholly-owned subsidiary of GE Intellectual Property Licensing,
Inc., which is a wholly-owned subsidiary of General Electric Co.)

105 Carnegie Center

Princeton, New Jersey 08540

Status of the Claims

Claims 1 through 6 and 44 through 49 are currently pending. Claims numbered 1 to 6 were originally issued in U.S. Patent 5,191,573 (the “573 Patent”). Claims 7 through 43 were added during reexamination and subsequently canceled following the vacating of the Office Action issued by the United States Patent and Trademark Office (the “Office”) on March 20, 2006 finally rejecting all of the claims in reexamination. Claims 44 through 49 were added in the Response to the Non-Final Office Action issued on September 29, 2006.

Claims 1 through 6 and 44 through 49 are rejected under 35 U.S.C. § 112, first paragraph. Claims 1, 2, 4, 5, 44, 45, 47 and 48 are rejected under 35 U.S.C. § 102(e). Claims 1 through 6 and 44 through 49 are rejected under 35 U.S.C. § 103(a).

Appellant appeals the rejection of all claims.

Grounds for Rejection to be Reviewed on Appeal

1. Office's rejection of Claims 1, 2, 4, 5, 44, 45, 47 and 48 under 35 U.S.C. § 102(e) and 35 U.S.C. § 103(a) over U.S. Patent 4,949,187 to Cohen (*Cohen*). In particular, Appellant seeks review of the Office's assertion that the '573 Patent is not entitled to the filing date of June 13, 1988, the assertion having to be correct before *Cohen* could be cited as a prior art reference.
2. Office's rejection of Claims 3, 6, 46 and 49 under 35 U.S.C. § 103(a) over *Cohen* in view of U.S. Patent 4,789,863 to Bush (*Bush*). In particular, Appellant seeks review of the Office's assertion that the '573 Patent is not entitled to the filing date of June 13, 1988, the assertion having to be correct before *Cohen* could be cited as a prior art reference.
3. Office's rejection of Claims 1 through 6 and 44 through 49 under 35 U.S.C. § 103(a) over *Bush* in view of *Cohen*. In particular, Appellant seeks review of the Office's assertion that the '573 Patent is not entitled to the filing date of June 13, 1988, the assertion having to be correct before *Cohen* could be cited as a prior art reference.
4. Office's rejection of Claims 1 through 6 and 44 through 49 under 35 U.S.C. § 103(a) over *Bush* in view of U.S. Patent 4,837,797 to Freeny (*Freeny I*).
5. Office's rejection of Claims 1 through 6 and 44 through 49 under 35 U.S.C. § 103(a) over Japanese Patent Application No. 62-284496 to Akashi (*Akashi*) in view of U.S. Patent 4,528,643 to Freeny (*Freeny II*).
5. Office's rejection of Claims 1 through 6 and 44 through 49 under 35 U.S.C. § 112, first paragraph as not being supported by the written description in the specification.
6. Office's rejection of Claims 4 through 6 and 47 through 49 under 35 U.S.C. § 112, first paragraph as not being enabled by the specification.

Argument

I. SUMMARY

The Examiner's Answer ("the Answer") essentially rehashes the arguments/rejections made in the Examiner's last Office Action. Appellant addressed each of those arguments/rejections in its Opening Appeal Brief. Appellant will not repeat all of those arguments here.¹ Instead, this Reply will focus specifically on three deficiencies in the Answer. First, the Answer's attempt to reassign priority dates to the present claims circumvents the rules and regulations governing the scope of reexamination. Second, the Answer continues to apply the incorrect enablement standard. Third, the Answer misconstrues the specification disclosure with respect to the "non-volatile storage portion is not a tape or a CD" element.

II. THE ANSWER'S REASSIGNING OF PRIORITY HAS NO LEGAL SUPPORT.

In rejecting the present claims based on "intervening" references, the Answer takes a two step approach that amounts to an improper *de novo* determination of priority for the existing claims. In the first step, the Answer alleges that "new matter" was added during the prosecution of the patent. Using that alleged "new matter," the Answer improperly converts the present continuation application to a continuation in part application by assigning varying priority dates to each of the claims.² In the second step, having already improperly created multiple artificial priority dates, the Answer asserts that it is now authorized to use intervening references to reject

¹ The fact that Appellant, in this Reply, has not raised all of the issues in the Opening Appeal Brief should not be considered a waiver of those issues.

² The Answer tries to hide the ball by repeatedly stating the Appellant is conflating the new matter issue with the priority issue. What the Answer fails to acknowledge is that its actions necessarily require the issues to be combined. If the Answer does not examine the claims under 35 USC 112, then the Answer would not have created the alleged "new matter." Without the alleged "new matter," there would be no question of priority because all of the claims would have been entitled to the original priority date. In other words, the Answer could not have reached the second step without initially taking the first step.

the claims. An examiner in a reexamination lacks the authority to take those two steps. As a result, the rejections based on the “intervening” references are improper.

A. Reassigning priority clearly falls outside the scope of reexamination.

The first step, *i.e.*, alleging that new matter was added during the original prosecution is outside the scope of reexamination for the pending application. That scope is defined by 37 CFR 1.552, which, in relevant part, recites:

(a) Claims in an *ex parte* reexamination proceeding will be examined on the basis of patents or printed publications and, with respect to subject matter added or deleted in the reexamination proceeding, on the basis of the requirements of 35 U.S.C. 112.

(c) Issues other than those indicated in paragraphs (a) and (b) of this section will not be resolved in a reexamination proceeding. If such issues are raised by the patent owner or third party requester during a reexamination proceeding, the existence of such issues will be noted by the examiner in the next Office action, in which case the patent owner may consider the advisability of filing a reissue application to have such issues considered and resolved.

In short, the reexamination regulations clearly state that issues with respect to 35 U.S.C. §112 can only be raised in a reexamination for “subject matter added or deleted in the reexamination proceeding.” 37 CFR 1.552; *see also In re Etter*, 756 F.2d 852, 856 (Fed. Cir. 1985) (*en banc*) (“only new or amended claims are also examined under 35 U.S.C. §§ 112 and 132”). That is not the case here.

Determining that material in the specification is “new matter” and then subsequently converting a continuation application to a continuation in part application, as the Answer improperly does in this case, plainly is an issue with raised under 35 U.S.C. §112. However, the material that the Answer alleges is new matter was not “added or deleted in the reexamination proceeding.” The Answer does not – and cannot – dispute this fact. On the contrary, the Answer lists each of dates in which the alleged new matter was added during the *original* prosecution.

Because the material was added during the *original* prosecution and not during reexamination, 37 CFR 1.552 makes clear that the reexamination examiner has no authority to review the material under 35 U.S.C. §112.

Without the first step of magically and improperly converting the continuation application to a continuation in part application, the Answer's rejection based on "intervening references" must fail. The priority date of a continuation application is the filing date of the original application to which the continuation claims priority. There is only one priority date. With only one priority date, there cannot be intervening references. For intervening references to exist, let alone be applied, the examiner necessarily had to reassign priority dates. Thus, the Answer is simply wrong when it asserted that "the examiner simply applied an intervening reference" and that "no priority dates [had] been 'reassigned' by the examiner." Answer, p. 44.

B. The new matter rejections are not a new question of patentability.

During the original prosecution, the original examiner was required to, and in fact did, review all added material to determine whether this material was new matter. As a result, conducting a new matter analysis on material added to the application during the original prosecution is not a new question of patentability in this reexamination. Because it is not a new question of patentability, the issue is outside the scope of reexamination.

As acknowledge in the Answer, the examiner in the original prosecution issued a new matter rejection in the office action of February 24, 1992. This rejection evidences the original examiner's attention to this issue; an issue that the statutes and rules mandate the examiner address. See 35 U.S.C. 132 (a) ("No amendment shall introduce new matter into the disclosure of the invention."); MPEP 706.03(o) ("In the examination of an application following amendment thereof, the examiner must be on the alert to detect new matter" and should object

“to amendments to the abstract, specification, or drawings attempting to add new disclosure to that originally disclosed on filing.”). This action is presumed to be complete. *See* 37 CFR §1.104 (“The examiner’s action will be complete as to all matters,” except in certain circumstances, none of which apply here). Therefore, the alleged new matter cannot be a new question of patentability here.³

C. The authority the Answer cites fails to support the action of converting a continuation application to a continuation in part application during reexamination.

The Answer cites several sections of the MPEP that allegedly empower a reexamination examiner to make a *de novo* priority determination of a *continuation* application. As discussed below, none of the cited sections give a reexamination examiner such authority.⁴ In fact, the reexamination examiner attempts to take actions (*i.e.*, convert a continuation to a continuation in part application) that no examiner – not even an original examiner – has authority to do. Thus, if an original examiner believes new matter has been added to an application that is not a continuation-in-part, and further believes the new matter is required to support claims, the proper courses for that original examiner is to object to the new matter under 35 U.S.C. § 132(a), and to reject the claims under 35 U.S.C. §112. It is undisputed there is absolutely no authority for an original examiner to do what the examiner did here – magically turn the application into a continuation-in-part, arbitrarily assign a new priority date to the claims, and thereafter reject those claims based on intervening prior art. Plainly, if an original examiner could not do that, then a reexamination examiner cannot do it either, absent some express authority in the

³ The Answer asserts that the appellant’s statement that the original examiner “could not – and did not – reassign priority dates to the original claims...” was an admission “that the original examiner did not address the issue of whether to apply intervening references against the original claims.” This assertion is just plain wrong. That statement was not an admission that the original examiner did not address the issue, but rather a statement that the original examiner correctly and properly did not reassign priority when it had an opportunity to do so.

⁴ It is important to note that “the MPEP does not have the force of law,” although it is entitled to judicial notice. *Molins PLC v. Textron, Inc.*, 48 F.3d 1172, 1180, n. 10 (Fed. Cir. 1995).

reexamination statutes or rules which, contrary to the present examiner's assertions, simply does not exist:

- MPEP § 201.11(B) – This section is not directed to reexaminations, and therefore does not apply to the present application.
- MPEP § 202.02 – The Answer cites this section for the proposition that “the inclusion of prior application information in the patent does not necessarily indicate that the claims are entitled to the benefit of the earlier filing date.” First, while this is true, it does not empower a reexamination examiner to convert a continuation application to a continuation in part application. Second, this section is not directed to reexaminations, and therefore does not apply to the present application.
- MPEP § 2258(I)(C) – This section notes that rejections based on intervening references are allowed during reexamination, but does not provide authority for an examiner to conduct a *de novo* priority determination of a *continuation* application during reexamination. The two cases cited in the section addressed continuation in part applications. Neither the section, nor the cases cited in the section provide an examiner with authority to convert a continuation application to a continuation in part application during reexamination.
- MPEP § 2258 (IV)(E) – This section provides that an examiner in reexamination can review priority claims *if* the patentee makes a claim for priority during the reexamination. Appellant did not make such a claim because Appellant did not need to. There is only one priority date to this application. To hold otherwise would in essence convert the continuation application into a continuation in part application, which, as discussed above, cannot be done.
- MPEP § 1402 – This section is directed to reissue applications, not applications in reexamination. The section does not provide an examiner with authority to convert a continuation application to a continuation in part application during reexamination.
- MPEP § 1405 – This section is directed to reissue applications, not applications in reexamination. The section does not provide an examiner with authority to convert a continuation application to a continuation in part application during reexamination.

There is no dispute that an examiner in a reexamination may, under limited circumstances, have authority to review intervening references in a reexamination. However, an examiner can only do so if the patent under reexamination issued from a continuation in part application. Again,

that is not the case here. The patent instead issued from a continuation application. The Answer's smoke and mirrors arguments⁵ that shift the burden to the appellant to show why the present continuation application cannot be treated like a continuation in part application are, just that -- smoke and mirrors. Each of the sections cited by the Answer relates to non-reexamination applications and/or continuation in part applications. None of the references relate to a continuation application in reexamination, which is what we have here. As a result, it is the Office that has the burden to show how these sections can apply. Not surprisingly, even with its manufactured arguments, the Answer failed to do that.

III. THE ANSWER APPLIED THE IMPROPER STANDARD AND IMPROPERLY IMPORTED LIMITATIONS INTO THE CLAIMS IN SUPPORT OF THE SECTION 112 REJECTIONS.

A. The Answer tacitly admits that short videos are enabled.

In the Opening Brief, Appellant pointed out that the rejection included an implicit admission that short videos were enabled. Appellant quoted the Office Action which stated "it is not clear ... how downloaded video files of any appreciable or viable size would have been downloaded and stored on originally disclosed hard disk 60 of the user in the original specification." Opening Brief, p. 37. In light of that statement, Appellant argued "The use of 'appreciable' and 'viable' makes it clear that short videos are enabled, and nothing more is required." *Id.* Not only is the use of the qualifying language "appreciable" and "viable" in the Office Action a tacit admission by the Office that the present specification at least enables videos of *some* size, the Answer's (e.g., on pages 26 and 67) failure to provide *any evidence* to rebut Appellant's argument that short videos are enabled is legally tantamount to an admission

⁵ The Answer inexplicably asserts that the "appellant has failed to cite to any law or procedure that prohibits the Office from applying intervening printed publications during an *ex parte* reexamination proceeding in the absence of a continuation-in-part." Answer, p. 44. The Answer apparently has overlooked 37 CFR 1.552.

that short videos are enabled. *See In re Herrmann*, 261 F.2d 598, 120 USPQ 182 (CCPA 1958) and *In re Soni*, 54 F.3d 746, 751, 34 USPQ2d 1684, 1688 (Fed. Cir. 1995) reversing rejections for failure to rebut applicant's argument. Because the enablement requirement does not have an "appreciable or viable size" requirement,⁶ and because the Answer admits the present specification enables videos of *some* size (*i.e.*, short videos), there can be no doubt the present claims meet the enablement requirement. Appellant therefore submits that the Proposed Findings of Fact and Conclusion of Law, attached hereto as Exhibit A, should be adopted of record in this Appeal.

B. The Answer applies the wrong standard and improperly imports limitations into the claims in support of the Section 112 rejections.

The Answer does nothing more than state the enablement rejection is based on the alleged fact that undue experimentation would be required to reach the claimed invention. Without more, that statement falls on its face. The Answer does not even discuss – much less provide any evidence -- as to how much or what kind of experimentation would be required. Instead, the Answer merely states that the level of experimentation would be "undue." This is not enough. Moreover, the Answer attempts to support the undue experimentation statement by introducing qualifiers (*e.g.*, "popular" or "routinely available") that are not present in the claims, and therefore not part of a proper enablement analysis. Again, by using such qualifiers, the examiner has tacitly admitted the claims are enabled in some manner, albeit in ways the examiner considers to be not "popular" or not "routinely available."

Despite its contentions to the contrary, the Answer clearly attempts to apply a "mass production" standard to the claims when, in actuality, the enablement standard of Section 112

⁶ The Answer acknowledges that even a 30-megabyte hard drive could store a three-minute movie if encoded at 1.5 megabits/second, which is more than enough to meet the enablement requirement. Answer, p. 26.

has no such requirement. As the Federal Circuit held in *Christianson v. Colt Indus. Operating Corp.*, 822 F.2d 1544, 1562 (Fed. Cir. 1987), “the law has never required that [an Appellant]... must disclose in its patent the dimensions, tolerances, drawings, and other parameters of mass production not necessary to enable one skilled in the art to practice (as distinguished from mass-produce) the invention.” Nonetheless, this kind of “mass production” information is exactly the kind of information the Answer now seeks. The Answer asserts that it did not apply the “mass production” standard,⁷ but as can be seen from the quotations directly from the Answer, this assertion defies reality.

Thus, the Answer states “[p]ersonal user devices with the processing power capable of playing back much larger and more complicated digital video files, such as DVD players, were not routinely available until the late 1990(s).” Answer, pp. 25-26 (emphasis added). Whether such devices “routinely” were available is not part of the test for enablement, nor is it one of the eight factors for reasonable experimentation that were laid out by the Federal Circuit in *In re Wands*, 858 F.2d 731 (Fed. Cir. 1988). Rather, the only relevant test is whether, without undue experimentation, one of ordinary skill in the art could have made and used the claimed invention.

As further evidence the Answer seeks to apply a “mass production” standard, the Answer states “the digital bandwidth required to transmit a video signal at even VHS quality was around 1.5 megabits per second (approximately 30 megabytes in 3 minutes).” Answer, p. 26 (emphasis added). However, while VHS quality may be appropriate for “mass production,” a limitation requiring VHS quality video is not included in any of the claims, and thus it is impermissible for the Office to use that level of quality as a benchmark for enablement. In fact, the recent success

⁷ The Answer asserts on page 67 that “Nothing was stated about a ‘mass production’ requirement.” Simply because the Answer did not use the exact words “mass production” does not mean that the requirement was not applied.

of very small screen video players shows that “mass production” can be achieved with even less than VHS quality.

Moreover, the Answer impermissibly limits the scope of what it referenced when it cites the size of available hard drives. While a 30-megabyte hard drive would have been available in a 3.5-inch form factor, the same chart relied on by the Office illustrates that hard drives larger than 1.89 gigabytes were available at the same time.

Furthermore, the Answer has applied the same “mass production” requirement to the library server. The Answer acknowledges that mainframes did exist which could have operated as repositories for copyrighted materials using hard disk drives, but then discounts the relevance of the existing mainframes by stating “it is not clear how even a small-sized video library ... would have been stored in the hard disk of the copyright holder ... without requiring details directed to a complex mainframe operating environment.” This unsupported statement on “complexity” is insufficient to prove that mainframe operating environments capable of storing digital video files were not already known at the time the original specification was filed, or that undue experimentation would have been required to store digital video files in such an environment. The statement also leaves unanswered how the Answer is defining “small” -- according to the enablement standard under Section 112 or the improper “mass production” standard?

The Answer also states “[r]egarding the transfer of these large video files over a network, the proliferation of broadband communication network[s] capable of delivering these large files to consumers, such as the Internet, simply did not exist or were not well known in 1988.” Answer, p. 27. (emphasis added). Such a statement raises at least two issues. First, “not well known” to whom? Those of ordinary skill in the art of computer systems knew of telephony-

based wide area networks at the time the original specification was filed. See <http://www.rfc-editor.org/rfc-index.html> for a list of computer communications standards including those available at the time of filing. Second, utilization of a “broadband” network is not required. In fact, the originally filed specification discloses that the audio and video files can be transferred over telephone lines. While this may not be an extremely fast method of transfer, it nonetheless clearly is enabling under Section 112.

The Office further questions “how the digital video would have been coded and decoded during transmission, as digital video coding standards for purposes of transmission and file download were not settled in 1988. [T]he MPEG-1 standard which was designed to code/decode digital video information and to transmit the video via a telephone (telecommunications) network in NTSC (broadcast) quality for archiving, was only established in 1992.” Answer, p. 27 (emphasis added). Again, standardization of video coding and the use of “NTSC quality” relate to “mass production” rather than enablement under Section 112. Thus, the Office has not alleged -- and cannot allege -- that one of ordinary skill in the art could not have coded video at some other resolution or using some other encoding technique at the time the original specification was filed.

In contrast, those of ordinary skill in the art would have been able to code and decode video data transmitted over a telephone line without undue experimentation. This is because there were existing video teleconferencing systems known and available to them prior to applicant’s earliest priority date. As earlier as five years before applicant’s earliest priority date digital video signals could have been and were sent via telephone networks and decoded with picture processors in real-time.

Similarly, not only were TV processors for video processing available for use in video processing systems, but network interface specifications were available for making systems that were compatible with signals sent via telephone networks. As such, contrary to the position of the Answer, it is clear that at the time of filing of the earliest priority application, one of ordinary skill in the art would have been able to transmit, download and decode video signals as claimed without undue experimentation.

Accordingly, Claims 4 through 6 and Claims 47 through 49 directed to the “video feature” embodiment of the invention are clearly enabled by the originally filed specification under the proper standard for Section 112 enablement.

IV. Negative Limitation

The Answer asserts the negative limitation of “a non-volatile storage portion of the second memory, wherein the non-volatile storage is not a tape or a CD”, introduces a new concept to the claims that does not have a basis in the originally filed specification. The Answer cites two cases from the BPAI, one case from the CAFC, and one case from the Court of Customs and Patent Appeals (“C.C.P.A.”) to support this rejection. None of the cases support the rejection.

The CAFC case cited in the Answer, *Lizardtech, Inc. v. Earth Res. Mapping, Inc.*, 433 F.3d 1373 (Fed. Cir. 2006), is merely an opinion denying a petition for rehearing *en banc*. The case does not address anything related to the current rejection. Therefore, the case simply does not support the Answer’s position.

The two cases from the BPAI, *Ex Parte Wong*, No. 2004-1144, 2004 WL 4981845 (Bd. Pat. App. & Interf. June 10, 2004) and *Ex Parte Grasselli*, 231 U.S.P.Q. 393 (Bd. Pat. App. & Interf. 1983), address situations where a negative limitation added to a claim was not described

in the specification of the application. However, neither *Wong* nor *Grasselli* support the rejection of Claims 1 through 6 under Section 112, first paragraph in the instant case. In both *Wong* and *Grasselli*, the issue and ultimate ground for rejection was that a negative limitation added to the claims introduced a new concept not disclosed in the respective specifications in those cases. That simply is not the situation here. Both Claims 1 and 4 recite a non-volatile storage portion of a memory that is not a tape or CD. The originally filed specification of the '497 Application explicitly states that the disclosed invention eliminates the need to handle tapes and CDs. See p. 2, lns. 23 to 26.⁸ Thus, the concept of storing digital audio or digital video signals on a memory that is not a tape or CD is explicitly disclosed by the original specification. Therefore, *Wong* and *Grasselli* are inapposite to the present case.

The case from the C.C.P.A., *Application of Johnson*, 558 F.2d 1008 (C.C.P.A. 1977), concerns a situation where the applicant sought to claim priority to an originally filed application for claims in a subsequent continuation-in-part application. The holding of *Johnson* also fails to support the Answer's position. In *Johnson*, an original parent application disclosed and claimed a genus of polymer compositions comprising various monomer units. In a later filed CIP application, the broad genus claims in the parent application were narrowed by expressly excluding certain species from the polymer compositions. The parent application only contained a description of the broader genus. The court found that claims to the narrower sub-genus created by the express exclusion of certain species in the CIP were not supported by the description of the broader genus in the parent specification. Again, the situation with the present reexamination differs significantly from the cited case law. Claims 1 and 4 recite a non-volatile

⁸ The Answer argues that the specification's disclosure of the present invention eliminating the need to handle tapes and CDs somehow means that present invention includes tapes and CDs. Eliminating something does not mean including that something. To find otherwise would be nonsensical.

storage portion of a memory that is not a tape or CD. This is exactly what is described at page 2, lines 23 to 26 of the originally filed specification. In short, the negative limitation recited in Claims 1 and 4 is expressly disclosed in the specification of the parent application. Thus, in the instant case, the scope of the disclosure in the specification was never narrowed with respect to this element, contrary to the situation in *Johnson*. Therefore, the recitation of a non-volatile storage portion of a memory that is not a tape or CD is fully supported by the originally filed specification, as well as the specification of the '573 Patent as issued.

The Board should therefore reverse the "negative limitation" rejections of Claims 1 through 6 under 35 U.S.C. § 112, first paragraph.

Conclusion

Based on all of the foregoing and the Appellant's Opening Brief, Appellant respectfully submits that the Board should reverse the rejections of Claims 1 through 6 and 44 through 49 under 35 U.S.C. §§ 102(e) and 103(a). Also based on the foregoing and on the Appellant's Opening Brief, the Board should reverse the rejection of Claims 1 through 6 and 44 through 49 under 35 U.S.C. § 112, first paragraph. Appellant respectfully requests an oral hearing by way of the Request for Oral Hearing form filed herewith.

Date: June 23, 2008

Drinker Biddle & Reath LLP
One Logan Square
18th and Cherry Streets
Philadelphia, PA 19103-6996
Telephone (215) 988-3392
Facsimile (215) 988-2757

Respectfully submitted,



Robert A. Koons, Jr., Esq.
Attorney for Appellant
Reg. No. 32,474

Exhibit A

Proposed Findings of Fact

1. Page 37 of Appellant's brief argued "The use of 'appreciable' and 'viable' makes it clear that short videos are enabled, and nothing more is required."
2. The Examiner's Answer provided no evidence to rebut Appellant's argument that "The use of 'appreciable' and 'viable' makes it clear that short videos are enabled."

Proposed Conclusion of Law

1. The Examiner's failure to rebut Appellant's argument that short videos are enabled is legally an implicit admission that short videos are enabled. *See In re Herrmann*, 261 F.2d 598, 120 USPQ 182 (CCPA 1958) and *In re Soni*, 54 F.3d 746, 751, 34 USPQ2d 1684, 1688 (Fed. Cir. 1995).

Express Mail No.: EV 502961945 US

Control No.: 90/007,402

Attorney's Docket No. NAPS001

Patent

IN THE UNITED STATES PATENT AND TRADEMARK OFFICE

In re Application of: Arthur R. Hair	:	Group No.: 3992
	:	
Serial No.: 90/007,402	:	Examiner: Roland G. Foster
	:	
Filed: January 31, 2005	:	Confirmation No. 2998
	:	
For: METHOD FOR TRANSMITTING A DESIRED DIGITAL VIDEO OR AUDIO SIGNAL		

CERTIFICATE OF SERVICE

The undersigned hereby certifies that true and correct copies of the REPLY BRIEF ON APPEAL UNDER 37 C.F.R. § 41.41 and the REQUEST FOR ORAL HEARING, which were filed with the United States Patent & Trademark Office on June 23, 2008, in Reexamination No. 90/007,402, were served via First Class United States Mail, postage prepaid, this 23rd day of June 2008, on the following:

Mr. Albert S. Penilla
Martine, Penilla, & Gencarella, LLP
710 Lakeway Drive, Suite 200
Sunnyvale, CA 94085
Attorney for Third Party Reexamination Requester

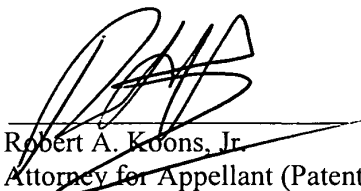
By: 
Robert A. Koons, Jr.
Attorney for Appellant (Patentee)



06-24-08

RE-EXAM

Approved for use through 06/30/2008. OMB 0651-0031
U.S. Patent and Trademark Office; U.S. DEPARTMENT OF COMMERCE
Under the Paperwork Reduction Act of 1995, no persons are required to respond to a collection of information unless it displays a valid OMB control number.



06/23/08

**REQUEST FOR ORAL HEARING
BEFORE
THE BOARD OF PATENT APPEALS AND INTERFERENCES**

Docket Number (Optional)

NAPS001

I hereby certify that this correspondence is being facsimile transmitted to the USPTO or deposited with the United States Postal Service with sufficient postage as first class mail in an envelope addressed to "Commissioner for Patents, P.O. Box 1450, Alexandria, VA 22313-1450" [37 CFR 1.8(a)] on July 23, 2008

Signature *Patricia D'Oliveira*
Typed or printed name Patricia D'Oliveira

In re Application of

Arthur R. Hair

Application Number

90/007,402

Filed

January 31, 2005

For **Method for Transmitting A Desired Digital Video or Audio Signal**

Art Unit

3992

Examiner

Roland G. Foster

Applicant hereby requests an oral hearing before the Board of Patent Appeals and Interferences in the appeal of the above-identified application.

The fee for this Request for Oral Hearing is (37 CFR 41.20(b)(3))

\$ 1,030.00

Applicant claims small entity status. See 37 CFR 1.27. Therefore, the fee shown above is reduced by half, and the resulting fee is:

\$ _____

A check in the amount of the fee is enclosed.

Payment by credit card. Form PTO-2038 is attached.

The Director has already been authorized to charge fees in this application to a Deposit Account. I have enclosed a duplicate copy of this sheet.

The Director is hereby authorized to charge any fees which may be required, or credit any overpayment to Deposit Account No. 50-0573. I have enclosed a duplicate copy of this sheet.

A petition for an extension of time under 37 CFR 1.136(b) (PTO/SB/23) is enclosed. For extensions of time in reexamination proceedings, see 37 CFR 1.550.

WARNING: Information on this form may become public. Credit card information should not be included on this form. Provide credit card information and authorization on PTO-2038.

I am the

applicant/inventor.

assignee of record of the entire interest. See 37 CFR 3.71. Statement under 37 CFR 3.73(b) is enclosed. (Form PTO/SB/96)

attorney or agent of record. Registration number _____

attorney or agent acting under 37 CFR 1.34. Registration number if acting under 37 CFR 1.34. 32,474

Robert A. Koons, Jr.
Signature

Robert A. Koons, Jr.
Typed or printed name

6/23/08
Date

(215) 988-3392
Telephone number

NOTE: Signatures of all the inventors or assignees of record of the entire interest or their representative(s) are required. Submit multiple forms if more than one signature is required, see below*.

*Total of 1 forms are submitted.

This collection of information is required by 37 CFR 41.20(b)(3). The information is required to obtain or retain a benefit by the public which is to file (and by the USPTO to process) an application. Confidentiality is governed by 35 U.S.C. 122 and 37 CFR 1.11, 1.14 and 41.6. This collection is estimated to take 12 minutes to complete, including gathering, preparing, and submitting the completed application form to the USPTO. Time will vary depending upon the individual case. Any comments on the amount of time you require to complete this form and/or suggestions for reducing this burden, should be sent to the Chief Information Officer, U.S. Patent and Trademark Office, U.S. Department of Commerce, P.O. Box 1450, Alexandria, VA 22313-1450. DO NOT SEND FEES OR COMPLETED FORMS TO THIS ADDRESS. SEND TO: Commissioner for Patents, P.O. Box 1450, Alexandria, VA 22313-1450.

If you need assistance in completing the form, call 1-800-PTO-9199 and select option 2.



UNITED STATES PATENT AND TRADEMARK OFFICE

UNITED STATES DEPARTMENT OF COMMERCE
United States Patent and Trademark Office
Address: COMMISSIONER FOR PATENTS
P.O. Box 1450
Alexandria, Virginia 22313-1450
www.uspto.gov

APPLICATION NO.	FILING DATE	FIRST NAMED INVENTOR	ATTORNEY DOCKET NO.	CONFIRMATION NO.
90/007,402	01/31/2005	5191573	NAPS001	2998

23973 7590 07/11/2008

DRINKER BIDDLE & REATH
ATTN: INTELLECTUAL PROPERTY GROUP
ONE LOGAN SQUARE
18TH AND CHERRY STREETS
PHILADELPHIA, PA 19103-6996

EXAMINER

ART UNIT PAPER NUMBER

DATE MAILED: 07/11/2008

Please find below and/or attached an Office communication concerning this application or proceeding.



DO NOT USE IN PALM PRINTER

(THIRD PARTY REQUESTER'S CORRESPONDENCE ADDRESS)

Albert S. Penilla

Martine Penilla & Gencarella, LLP

710 Lakeway Drive, Suite 200

Sunnyvale, CA 94085

EX PARTE REEXAMINATION COMMUNICATION TRANSMITTAL FORM

REEXAMINATION CONTROL NO. 90/007,402.

PATENT NO. 5191573.

ART UNIT 3992.

Enclosed is a copy of the latest communication from the United States Patent and Trademark Office in the above identified *ex parte* reexamination proceeding (37 CFR 1.550(f)).

Where this copy is supplied after the reply by requester, 37 CFR 1.535, or the time for filing a reply has passed, no submission on behalf of the *ex parte* reexamination requester will be acknowledged or considered (37 CFR 1.550(g)).



UNITED STATES DEPARTMENT OF COMMERCE

U.S. Patent and Trademark Office

Address : COMMISSIONER FOR PATENTS
P.O. Box 1450
Alexandria, Virginia 22313-1450

APPLICATION NO./ CONTROL NO.	FILING DATE	FIRST NAMED INVENTOR / PATENT IN REEXAMINATION	ATTORNEY DOCKET NO.
90007402	1/31/05	5191573	NAPS001

DRINKER BIDDLE & REATH
ATTN: INTELLECTUAL PROPERTY GROUP
ONE LOGAN SQUARE
18TH AND CHERRY STREETS
PHILADELPHIA, PA 19103-6996

EXAMINER

ROLAND G.. FOSTER

ART UNIT	PAPER
3992	20080707-A

DATE MAILED:

Please find below and/or attached an Office communication concerning this application or proceeding.

Commissioner for Patents

The examiner requests the opportunity to present arguments at the oral hearing.

Roland G. Foster
Primary Examiner
Electrical Art Unit 3992
Central Reexamination Unit

MARK J. REINHART
CRU SPE-AU 3992



UNITED STATES PATENT AND TRADEMARK OFFICE

UNITED STATES DEPARTMENT OF COMMERCE
United States Patent and Trademark Office
Address: COMMISSIONER FOR PATENTS
P.O. Box 1450
Alexandria, Virginia 22313-1450
www.uspto.gov

APPLICATION NO.	FILING DATE	FIRST NAMED INVENTOR	ATTORNEY DOCKET NO.	CONFIRMATION NO.
90/007,402	01/31/2005	5191573	NAPS001	2998

23973 7590 04/24/2008

DRINKER BIDDLE & REATH
ATTN: INTELLECTUAL PROPERTY GROUP
ONE LOGAN SQUARE
18TH AND CHERRY STREETS
PHILADELPHIA, PA 19103-6996

EXAMINER

ART UNIT PAPER NUMBER

DATE MAILED: 7-11-07

Please find below and/or attached an Office communication concerning this application or proceeding.



DO NOT USE IN PALM PRINTER

(THIRD PARTY REQUESTER'S CORRESPONDENCE ADDRESS)

Albert S. Penilla
Martine Penilla & Gencarella, LLP
710 Lakeway Drive, Suite 200
Sunnyvale, CA 94085

EX PARTE REEXAMINATION COMMUNICATION TRANSMITTAL FORM

REEXAMINATION CONTROL NO. 90/007,402.

PATENT NO. 5191573.

ART UNIT 3992.

Enclosed is a copy of the latest communication from the United States Patent and Trademark Office in the above identified *ex parte* reexamination proceeding (37 CFR 1.550(f)).

Where this copy is supplied after the reply by requester, 37 CFR 1.535, or the time for filing a reply has passed, no submission on behalf of the *ex parte* reexamination requester will be acknowledged or considered (37 CFR 1.550(g)).



UNITED STATES DEPARTMENT OF COMMERCE
U.S. Patent and Trademark Office
 Address: COMMISSIONER FOR PATENTS
 P.O. Box 1450
 Alexandria, Virginia 22313-1450

APPLICATION NO./ CONTROL NO.	FILING DATE	FIRST NAMED INVENTOR / PATENT IN REEXAMINATION	ATTORNEY DOCKET NO.
90007402	1/31/05	5191573	NAPS001

DRINKER BIDDLE & REATH
 ATTN: INTELLECTUAL PROPERTY GROUP
 ONE LOGAN SQUARE
 18TH AND CHERRY STREETS
 PHILADELPHIA, PA 19103-6996

EXAMINER

ROLAND G. FOSTER

ART UNIT	PAPER
-----------------	--------------

3992 20080707

DATE MAILED:

Please find below and/or attached an Office communication concerning this application or proceeding.

Commissioner for Patents

The reply brief filed on June 23, 2008 has been entered and considered. The proceeding has been forwarded to the Board of Patent Appeals and Interferences for decision on the appeal.

 Roland G. Foster
 Primary Examiner
 Electrical Art Unit 3992
 Central Reexamination Unit

MARK J. REINHART
 CRU SPE-AU 3992



UNITED STATES PATENT AND TRADEMARK OFFICE

UNITED STATES DEPARTMENT OF COMMERCE
United States Patent and Trademark Office
Address: COMMISSIONER FOR PATENTS
P.O. Box 1450
Alexandria, Virginia 22313-1450
www.uspto.gov

Table with 5 columns: APPLICATION NO., FILING DATE, FIRST NAMED INVENTOR, ATTORNEY DOCKET NO., CONFIRMATION NO.

90/007,402 01/31/2005 5191573 NAPS001 2998

23973 7590 09/26/2008
DRINKER BIDDLE & REATH
ATTN: INTELLECTUAL PROPERTY GROUP
ONE LOGAN SQUARE
18TH AND CHERRY STREETS
PHILADELPHIA, PA 19103-6996

Table with 1 column: EXAMINER

FOSTER, ROLAND G

Table with 2 columns: ART UNIT, PAPER NUMBER

3992

Table with 2 columns: MAIL DATE, DELIVERY MODE

09/26/2008 PAPER

Please find below and/or attached an Office communication concerning this application or proceeding.

The time period for reply, if any, is set in the attached communication.



United States Patent and Trademark Office

**Under Secretary of Commerce for Intellectual Property and
Director of the United States Patent and Trademark Office**
P.O. Box 1450
Alexandria, Virginia 22313-1450
www.uspto.gov

DRINKER BIDDLE & REATH
ATTN: INTELLECTUAL PROPERTY
GROUP
ONE LOGAN SQUARE
18TH AND CHERRY STREETS
PHILADELPHIA, PA 19103-6996

Appeal No: 2008-6178
Application: 90/007,402
Appellant: Arthur R. Hair

Board of Patent Appeals and Interferences Docketing Notice

Application 90/007,402 was received from the Technology Center at the Board on August 14, 2008 and has been assigned Appeal No: 2008-6178.

A review of the file indicates that the following documents have been filed by appellant:

Appeal Brief filed on: January 30, 2008
Reply Brief filed on: June 23, 2008
Request for Hearing filed on: June 23, 2008

In all future communications regarding this appeal, please include both the application number and the appeal number.

The mailing address for the Board is:

**BOARD OF PATENT APPEALS AND INTERFERENCES
UNITED STATES PATENT AND TRADEMARK OFFICE
P.O. BOX 1450
ALEXANDRIA, VIRGINIA 22313-1450**

The facsimile number of the Board is 571-273-0052. Because of the heightened security in the Washington D.C. area, facsimile communications are recommended. Telephone inquiries can be made by calling 571-272-9797 and should be directed to a Program and Resource Administrator.

By order of the Board of Patent Appeals and Interferences.

Third Party Requester:

Albert S. Penilla
MARTINE PENILLA & GENCARELLA, LLP
710 Lakeway Drive
Suite 200
Sunnyvale, CA 94085

UNITED STATES PATENT AND TRADEMARK OFFICE

BEFORE THE BOARD OF PATENT APPEALS
AND INTERFERENCES

Ex parte: ARTHUR R. HAIR

Appeal No. 2008-6178
Reexamination Control No. 90/007,402
Patent No. 5,191,573
Technology Center 3900

Mailed: November 13, 2008

Before LYNN KRYZA *Deputy Chief Trial Administrator*

ORDER REMANDING TO EXAMINER

This reexamination was electronically received at the Board of Patent Appeals and Interferences on August 14, 2008. Upon review of the reexamination, it has been determined that a remand to the Examiner is

Appeal No. 2008- 6178
Application No. 90/007,402

necessary to consider the following issue and to take necessary corrective action.

APPEAL BRIEF, MISSING EVIDENCE

A review of the file finds that with regard to the evidence listed in the Evidence Appendix of the Appeal Brief filed January 30, 2008, it does not appear that copies of such evidence have been provided, nor does there appear to be a statement setting forth where in the record the evidence was entered in the record by the Examiner in accordance with 37 CFR 41.37(c)(1)(ix).

CONCLUSION

Accordingly, it is **ORDERED** that this reexamination be remanded to the Examiner to:

- 1) to hold the Appeal Brief filed January 30, 2008 defective; and,
- 2) notify Appellant to file a corrected paper addressing the evidence listed in the Evidence Appendix; and,
- 3) for such further action as appropriate.

If there are any questions pertaining to this Order, please contact the Board of Patent Appeals and Interferences at 571-272-9797.

LK/SD

Appeal No. 2008- 6178
Application No. 90/007,402

For Patent Owner:

DRINKER BIDDLE & REATH LLP
ATTN: INTELLECTUAL PROPERTY GROUP
One Logan Square
18th and Cherry Streets
Philadelphia, PA 19103-6996

For Third Party Requester:

Albert S. Penilla
MARTINE PENILLA & GENCARELLA, LLP
710 Lakeway Drive
Suite 200
Sunnyvale, CA 94805

Application Number 	Application/Control No. 90/007,402	Applicant(s)/Patent Under Reexamination 5191573
	Examiner ROLAND G. FOSTER	Art Unit 3992



UNITED STATES PATENT AND TRADEMARK OFFICE

Commissioner for Patents
United States Patents and Trademark Office
P.O. Box 1450
Alexandria, VA 22313-1450
www.uspto.gov

THIRD PARTY REQUESTER'S CORRESPONDENCE ADDRESS

ALBERT S. PENILA
MARTINE PENILLA & GENCARELLA LLP
710 LAKEWAY DRIVE, SUITE 200
SUNNYVALE, CA 94085

Date:

MAILED

DEC 04 2008

CENTRAL REEXAMINATION UNIT

EX PARTE REEXAMINATION COMMUNICATION TRANSMITTAL FORM

REEXAMINATION CONTROL NO. : 90007402
PATENT NO. : 5191573
ART UNIT : 3900

Enclosed is a copy of the latest communication from the United States Patent and Trademark Office in the above identified ex parte reexamination proceeding (37 CFR 1.550(f)).

Where this copy is supplied after the reply by requester, 37 CFR 1.535, or the time for filing a reply has passed, no submission on behalf of the ex parte reexamination requester will be acknowledged or considered (37 CFR 1.550(g)).



UNITED STATES PATENT AND TRADEMARK OFFICE

UNITED STATES DEPARTMENT OF COMMERCE
United States Patent and Trademark Office
Address: COMMISSIONER FOR PATENTS
P.O. Box 1450
Alexandria, Virginia 22313-1450
www.uspto.gov

APPLICATION NO.	FILING DATE	FIRST NAMED INVENTOR	ATTORNEY DOCKET NO.	CONFIRMATION NO.
90/007,402	01/31/2005	5191573	NAPS001	2998

23973 7590 12/04/2008

DRINKER BIDDLE & REATH
ATTN: INTELLECTUAL PROPERTY GROUP
ONE LOGAN SQUARE
18TH AND CHERRY STREETS
PHILADELPHIA, PA 19103-6996

EXAMINER

ART UNIT PAPER NUMBER

DATE MAILED: 12/04/2008

Please find below and/or attached an Office communication concerning this application or proceeding.

**Notification of Non-Compliant Appeal
Brief (37 CFR 41.37) in
Ex Parte Reexamination**

Control No.	Patent Under Reexamination
90/007,402	5,191,573
Examiner	Art Unit
ROLAND G. FOSTER	3992

--The MAILING DATE of this communication appears on the cover sheet with the correspondence address--

The Appeal Brief filed on 30 January 2008 is defective for failure to comply with one or more provisions of 37 CFR 41.37(c).

Patent owner is given a TIME PERIOD of ONE MONTH or THIRTY DAYS, whichever is longer, from the mailing date of this Notification for filing an amended brief or other appropriate correction of the Appeal brief (see MPEP 1205.03). If an amended brief or other appropriate correction (see MPEP 1205.03) is not timely submitted, the appeal will be dismissed as of the expiration of the period for reply to this Notification. Extensions of this time period may be obtained only under 37 CFR 1.550(c).

1. The brief does not contain the items required under 37 CFR 41.37(c), or the items are not under the proper heading or in the proper order.
2. The brief does not contain a statement of the status of all claims (e.g., rejected, allowed or confirmed, withdrawn, objected to, canceled), or does not identify the appealed claims (37 CFR 41.37(c)(1)(iii)).
3. At least one amendment has been filed subsequent to the final rejection, and the brief does not contain a statement of the status of each such amendment (37 CFR 41.37(c)(1)(iv)).
4. The brief does not comply with 37 CFR 41.37(c)(1)(v) if that it fails to (1) contain a concise explanation of the subject matter defined in each of the independent claims involved in the appeal, referring to the specification by page and line number and to the drawings, if any, by reference characters; (2) identify, for each independent claim involved in the appeal and for each dependent claim argued separately, every means plus function and step plus function under 35 U.S.C. 112, sixth paragraph, and/or (3) set forth the structure, material, or acts described in the specification as corresponding to each claimed function with reference to the specification by page and line number, and to the drawings, if any, by reference characters.
5. The brief does not contain a concise statement of each ground of rejection presented for review (37 CFR 41.37(c)(1)(vi)).
6. The brief does not present an argument under a separate heading for each ground of rejection on appeal (37 CFR 41.37(c)(1)(vii)).
7. The brief does not contain a correct copy of the appealed claims as an appendix thereto (37 CFR 41.37(c)(1)(viii)).
8. The brief does not contain, as an appendix thereto (37 CFR 41.37(c)(1)(ix)), copies of the evidence submitted under 37 CFR 1.130, 131, or 1.132 or of any other evidence entered by the examiner and relied upon by appellant in the appeal, along with a statement setting forth where in the record that evidence was entered by the examiner.
9. The brief does not contain, as an appendix thereto (37 CFR 41.37(c)(1)(x)), copies of the decisions rendered by a court or the Board in the proceeding identified in the Related Appeals and Interferences section of the brief.
10. Other (including any explanation in support of the above items):
See Continuation Sheet.

* If this is a merged proceeding, one copy must be added for each reexamination in addition to the first reexamination.

cc: Requester (if third party requester)

U.S. Patent and Trademark Office

PTOL-462R (Rev. 07-05) Notification of Non-Compliant Appeal Brief (37 CFR 41.37) in Ex Parte Reexamination

Part of Paper No. 20081203

Continuation of 10. Other (including any explanation in support of the above items):

In accordance with the Order from the Board of Patent Appeals and Interferences, mailed November 13, 2008:

- 1) the examiner holds the Appeal Brief defective; and
- 2) hereby notifies Appellant to file a corrected paper addressing the evidence listed in the Evidence Appendix as described in the Order.

/Roland G. Foster/
Roland G. Foster
Primary Examiner
Electrical Art Unit 3992
Central Reexamination Unit

Express Mail No.: EV 320481168 US

Control No.: 90/007,402

Attorney's Docket No. NAPS001

Patent

66155 U.S. PTO



12/15/08

IN THE UNITED STATES PATENT AND TRADEMARK OFFICE

In re Application of: Arthur R. Hair	:	Group No.: 3992
	:	
Serial No.: 90/007,402	:	Examiner: Roland G. Foster
	:	
Filed: January 31, 2005	:	Confirmation No. 2998
	:	

For: METHOD FOR TRANSMITTING A DESIRED DIGITAL VIDEO OR AUDIO SIGNAL

AMENDED BRIEF ON APPEAL UNDER 37 C.F.R. § 41.37

Mail Stop Appeal Brief - Patents
Commissioner for Patents
P.O. Box 1450
Alexandria, VA 22313-1450

This Amended Brief on Appeal in being submitted in response to the Examiner's Notification of Non-Compliant Appeal Brief dated December 4, 2008, which was prompted by the Board's Remand Order dated November 13, 2008. To address alleged deficiencies identified in the Examiner's Notification and the Board's Order, and expedite consideration of the brief by the Board, this Amended Brief (1) deletes reference to the website http://en.wikipedia.org/wiki/Non-volatile_storage in the Evidence Appendix (no reference was made to this website in the body of the Brief), (2) deletes reference to the website <http://www.rfc-editor.org/rfc-index.html> in the Evidence Appendix and on page 39 of the text of this Appeal Brief, and (3) notes in the Evidence Appendix, where in the record the examiner considered the Hair and Tygar Declarations. No other changes have been made.

Real Party in Interest

Appellant's real party in interest is:

DMT Licensing, LLC (a wholly-owned subsidiary of GE Intellectual Property Licensing, Inc., which is a wholly-owned subsidiary of General Electric Co.)
105 Carnegie Center
Princeton, New Jersey 08540

Related Appeals and Interferences

The Appeals in copending reexaminations 90/007,403 and 90/007,407 are related to the instant Appeal. The outcomes in these copending Appeals may affect, be affected by, or have some bearing on the Board's decision in the instant Appeal.

Status of the Claims

Claims 1 through 6 and 44 through 49 are currently pending. Claims numbered 1 to 6 were originally issued in U.S. Patent 5,191,573 (the "573 Patent"). Claims 7 through 43 were added during reexamination and subsequently canceled following the vacating of the Office Action issued by the United States Patent and Trademark Office (the "Office") on March 20, 2006 finally rejecting all of the claims in reexamination. Claims 44 through 49 were added in the Response to the Non-Final Office Action issued on September 29, 2006.

Claims 1 through 6 and 44 through 49 are rejected under 35 U.S.C. § 112, first paragraph. Claims 1, 2, 4, 5, 44, 45, 47 and 48 are rejected under 35 U.S.C. § 102(e). Claims 1 through 6 and 44 through 49 are rejected under 35 U.S.C. § 103(a).

Appellant appeals the rejection of all claims.

Status of Amendments

All amendments have been entered.

Summary of the Claimed Subject Matter

Claims 1, 4, 44 and 47 are the independent claims. Below, Appellant summarizes the claimed subject matter in the independent claims per 37 C.F.R. § 41.37(c)(1)(v) using references to the Figures and column and line numbers in the issued patent.

Independent Claim 1 recites a method for transmitting a desired digital audio signal stored on a first memory of a first party to a second memory of a second party [Abstract]. The method comprises the steps of transferring money electronically via a telecommunication line to the first party at a location remote from the second memory and controlling use of the first memory from the second party, the second party being financially distinct from the first party [col. 2, lns. 63 to 67; col. 3, lns. 6 to 7; col. 5, lns. 32 to 34], and the second party controlling use and in possession of the second memory [col. 2, lns. 40 to 47; col. 3, lns. 12 to 17; col. 3, lns. 52 to 59]. The method further comprises connecting electronically via a telecommunications line the first memory with the second memory such that the desired digital audio signal can pass there-between [Fig. 1; col. 2, lns. 51 to 67; col. 3, lns. 8 to 12], transmitting the desired digital audio signal from the first memory with a transmitter in control and possession of the first party to a receiver having the second memory at a location determined by the second party, said receiver in possession and control of the second party [Figure 1; col. 2, lns. 51 to 67; col. 3, lns. 13 to 19 and 60 to 67; col. 4, lns. 25 to 44] and storing the digital signal in a non-volatile storage portion of the second memory, wherein the non-volatile storage portion is not a tape or CD [col. 2, lns. 31 to 35; col. 3, lns. 17 to 19; col. 4, lns. 41 to 43].

Independent Claim 4 recites a method for transmitting a desired digital video signal stored on a first memory of a first party to a second memory of a second party [Abstract]. The

method comprises the steps of transferring money electronically via a telecommunications line to the first party at a location remote from the second memory and controlling use of the first memory from a second party financially distinct from the first party [col. 2, lns. 63 to 67; col. 3, lns. 6 to 7; col. 5, lns. 32 to 34], said second party in control and in possession of the second memory [col. 2, lns. 40 to 47; col. 3, lns. 12 to 17; col. 3, lns. 52 to 59]. The method further comprises connecting electronically via a telecommunications line the first memory with the second memory such that the desired digital video signal can pass there-between [Figure 1; col. 2, lns. 51 to 67; col. 3, lns. 8 to 12, col. 5, ln. 67 to col. 6, ln. 2], transmitting the desired digital video signal from the first memory with a transmitter in control and possession of the first party to a receiver having the second memory at a location determined by the second party, said receiver in possession and control of the second party [Figure 1; col. 2, lns. 51 to 67; col. 3, lns. 13 to 19 and 60 to 67; col. 4, lns. 25 to 44; col. 5, ln. 67 to col. 6, ln. 2] and storing the digital signal in a non-volatile storage portion of the second memory, wherein the non-volatile storage portion is not a tape or CD [col. 2, lns. 31 to 35; col. 3, lns. 17 to 19; col. 4, lns. 41 to 43].

Independent claim 44 recites a method for transmitting a desired digital audio signal stored on a first memory of a first party to a second memory of a second party [Abstract; col. 5, ln. 67 to col. 6, ln. 2]. The method comprises the steps of transferring money electronically via a telecommunications line to the first party at a location remote from the second memory and controlling use of the first memory from the second party financially distinct from the first party [col. 2, lns. 63 to 67; col. 3, lns. 6 to 7; col. 5, lns. 32 to 34], said second party controlling use and in possession of the second memory [col. 2, lns. 40 to 47; col. 3, lns. 12 to 17; col. 3, lns. 52 to 59]. The second memory includes a second party hard disk [Fig. 1 (60); col. 3, ln. 57]. The method further comprises connecting electronically via a telecommunications line the first

memory with the second memory such that the desired digital audio signal can pass therebetween [Fig. 1 (20B, 30, 50B); col. 2, lns. 51 to 67; col. 3, lns. 8 to 12], transmitting the desired digital audio signal from the first memory with a transmitter in control and possession of the first party to a receiver having the second memory at a location determined by the second party, said receiver in possession and control of the second party [Figure 1; col. 2, lns. 51 to 67; col. 3, lns. 13 to 19 and 60 to 67; col. 4, lns. 25 to 44] and storing the digital signal in the second party hard disk [col. 3, lns. 17 to 19; col. 4, lns. 41 to 43].

Independent Claim 47 recites a method for transmitting a desired digital video signal stored on a first memory of a first party to a second memory of a second party [Abstract; col. 5, ln. 67 to col. 6, ln. 2]. The method comprises the steps of transferring money electronically via a telecommunications line to the first party at a location remote from the second memory and controlling use of the first memory from the second party financially distinct from the first party [col. 2, lns. 63 to 67; col. 3, lns. 6 to 7; col. 5, lns. 32 to 34], said second party controlling use and in possession of the second memory [col. 2, lns. 40 to 47; col. 3, lns. 12 to 17; col. 3, lns. 52 to 59]. The second memory includes a second party hard disk [Fig. 1 (60); col. 3, ln. 57]. The method further comprises connecting electronically via a telecommunications line the first memory with the second memory such that the desired digital video signal can pass therebetween [Figure 1; col. 2, lns. 51 to 67; col. 3, lns. 8 to 12, col. 5, ln. 67 to col. 6, ln. 2], transmitting the desired digital video signal from the first memory with a transmitter in control and possession of the first party to a receiver having the second memory at a location determined by the second party, said receiver in possession and control of the second party [Figure 1; col. 2, lns. 51 to 67; col. 3, lns. 13 to 19 and 60 to 67; col. 4, lns. 25 to 44; col. 5, ln.

67 to col. 6, ln. 2] and storing the digital signal in the second party hard disk [col. 3, lns. 17 to 19; col. 4, lns. 41 to 43].

Grounds for Rejection to be Reviewed on Appeal

1. Examiner's rejection of Claims 1, 2, 4, 5, 44, 45, 47 and 48 under 35 U.S.C. § 102(e) and 35 U.S.C. § 103(a) over U.S. Patent 4,949,187 to Cohen (*Cohen*). In particular, Appellant seeks review of the Examiner's assertion that the '573 Patent is not entitled to the filing date of June 13, 1988, the assertion having to be correct before *Cohen* could be cited as a prior art reference.
2. Examiner's rejection of Claims 3, 6, 46 and 49 under 35 U.S.C. § 103(a) over *Cohen* in view of U.S. Patent 4,789,863 to Bush (*Bush*). In particular, Appellant seeks review of the Examiner's assertion that the '573 Patent is not entitled to the filing date of June 13, 1988, the assertion having to be correct before *Cohen* could be cited as a prior art reference.
3. Examiner's rejection of Claims 1 through 6 and 44 through 49 under 35 U.S.C. § 103(a) over *Bush* in view of *Cohen*. In particular, Appellant seeks review of the Examiner's assertion that the '573 Patent is not entitled to the filing date of June 13, 1988, the assertion having to be correct before *Cohen* could be cited as a prior art reference.
4. Examiner's rejection of Claims 1 through 6 and 44 through 49 under 35 U.S.C. § 103(a) over *Bush* in view of U.S. Patent 4,837,797 to Freeny (*Freeny I*).
5. Examiner's rejection of Claims 1 through 6 and 44 through 49 under 35 U.S.C. § 103(a) over Japanese Patent Application No. 62-284496 to Akashi (*Akashi*) in view of U.S. Patent 4,528,643 to Freeny (*Freeny II*).
5. Examiner's rejection of Claims 1 through 6 and 44 through 49 under 35 U.S.C. § 112, first paragraph as not being supported by the written description in the specification.

6. Examiner's rejection of Claims 4 through 6 and 47 through 49 under 35 U.S.C. § 112, first paragraph as not being enabled by the specification.

Argument

I. Summary

The instant reexamination was originally filed on January 31, 2005, and was initially assigned to Examiner Benjamin Lanier ("Examiner Lanier"). The reexamination and two related copending reexaminations subsequently were transferred to the Central Reexamination Unit ("CRU") where they were assigned to Examiner Roland Foster ("Examiner Foster").

During the course of the proceedings in the instant reexamination, five Office Actions were issued. The first three Office Actions were issued by Examiner Lanier, who consistently rejected all claims presented by Appellant as obvious. In each case, Examiner Lanier relied on combinations of up to nine references in his obviousness analyses, offering only conclusory statements regarding the motivation or teaching to combine the multiple references. In each case, the Appellant pointed out the impropriety of the combinations. Examiner Lanier never rebutted the Appellant's arguments. Instead, Examiner Lanier simply asserted that the rejections were proper.

Following the issuance of the third Office Action by Examiner Lanier, the instant reexamination was transferred to the CRU, specifically to Examiner Foster, where the Office reviewed and vacated Examiner Lanier's Final Rejection of the claims. The Office appeared to concur with the Appellant's view that the rejections offered by Examiner Lanier were untenable, but the Office did not allow the claims. Instead, the Office issued two subsequent Office Actions.

The two subsequent Office Actions take an alternate approach which, since also improper, has led to this appeal. Instead of relying on up to nine references, these subsequent Office Actions relied primarily on references that post-dated the June 13, 1988 priority date for the '573 Patent. In other words, the Office Actions relied on non-*prior* art. To justify this, the Office first had to conduct a *de novo* review of the '573 Patent's prosecution and then, based on that review, reassign the '573 Patent's June 13, 1988 priority date; a priority date that was rightfully granted by the original Examiner during the initial examination of the '573 Patent. In taking those steps, the Office reassigned the priority date to September 18, 1990. Then, using this new priority date, the Office cited new art post-dating the June 13, 1988 priority date, which the Office asserts anticipates or makes obvious all of the claims in reexamination.

As detailed below, this *de novo* review and resulting reassignment of the priority date is clearly outside the scope of authority of the Office as granted by the Reexamination Statute. 35 USC § 301, *et seq.* Further, the attempted reassignment of a new priority date to the '573 Patent does not comport with Office procedures.

Further, as a predicate for reassigning the priority date of the claims in the '573 Patent, the Office asserts that the claims as issued are either not supported by a written description or are not enabled by the specification as filed on June 13, 1988. In making these findings, the Office has applied improper and overly strict standards for both written description and enablement under 35 U.S.C. § 112, first paragraph. Using the appropriate standards, Appellant has demonstrated that the claims in reexamination are fully supported and enabled by the originally filed specification, and are thus entitled to the priority date of June 13, 1988.

Where the Office has presented obviousness rejections relying solely on references that do qualify as prior art based on the proper June 13, 1988 priority date, the Office has failed to

present a reasoned argument showing a teaching or motivation to combine the references, as required by *KSR Int'l Co. v. Teleflex Inc.*, 127 S. Ct. 1727 (U.S. 2007). Further, as demonstrated by Appellant, these references do not show each and every limitation of the claims in reexamination. As a result, the Office has not established a *prima facie* case of obviousness based on those references that are proper prior art.

The Office has also rejected Claims 1 through 6 and 44 through 49 in reexamination under 35 U.S.C. § 112, first paragraph, as not being supported by an adequate written description and as not being enabled by the specification. Here again, Appellant maintains that the Office has acted outside the mandated scope of reexamination by examining Claims 1 through 6 and 44 through 49 in their entirety for compliance with section 112, first paragraph, rather than limiting the analysis to newly claimed subject matter. Further, the Office has again applied improper standards for both written description support and enablement. Using the appropriate standards, Appellant has demonstrated that the claims in reexamination do comply with the requirements section 112, first paragraph.

Since many of the positions taken by the Office in finally rejecting Claims 1 through 6 and 44 through 49 rely on a revisiting of issues dealt with during the original examination of the '573 Patent, it is appropriate here to summarize the prosecution history of the '573 Patent. Appellant's arguments herein will refer to the summary provided in Section II below.

II. Prosecution History of the '573 Patent

The '573 Patent issued from U.S. Patent Application Serial No. 07/586,391 (the "'391 Application'"), which was filed as a continuation of U.S. Patent Application Serial No. 07/206,497 (the "'497 Application'"). The '497 Application was originally filed on June 13,

1988 by Arthur Hair as a *pro se* applicant.¹ In the period after the initial filing of the '497 Application, Mr. Hair retained Ansel M. Schwartz as patent counsel. The Application was assigned to Examiner Hoa T. Nguyen ("Examiner Nguyen").

On December 19, 1988, Mr. Schwartz filed a preliminary amendment canceling original Claims 1 through 10 in the '497 Application and replacing them with new Claims 11 through 13, which read as follows:

11. A method for transmitting a desired digital audio music signal stored on a first memory to a second memory comprising the steps of: transferring money to a party controlling use of the first memory from a party controlling use of the second memory; connecting electronically the first memory with the second memory such that the desired digital signal can pass therebetween; transmitting the digital signal from the first memory to the second memory; and storing the digital signal in the second memory. (emphasis added).

12. A method as described in Claim 11, including after the transferring step, the steps of searching the first memory for the desired digital audio signal; and selecting the desired digital audio signal from the first memory. (emphasis added).

13. A method as described in Claim 12 wherein the transferring step includes the steps of telephoning the party controlling use of the first memory by the party controlling the second memory; providing a credit card number of the party controlling the second memory to the party controlling the first memory so that the party controlling the second memory is charged money.

The first Office Action in the '497 Application was issued on November 15, 1988 on the basis of Claims 11 to 13 added by the preliminary amendment. All of the claims were rejected as anticipated by U.S. Patent 3,718,906. Mr. Schwartz responded to the Office Action on February 26, 1990. In this response, Claims 14 through 20 were added. Exemplary Claims 14 and 15 read as follows:

¹ The application which became the '497 Application was actually mailed on June 9, 1988. However, since Mr. Hair was unaware of the use of Express Mail, the application was accorded the date that it actually was received at the Office.

14. A method as described in Claim 11 wherein the transmitting step includes the step of transmitting the digital signal from the first memory to the second memory at a location determined by the second party controlling use of the second memory. (emphasis added)

15. A method for transmitting a desired a digital video or audio music signal stored on a first memory to a second memory comprising the steps of:

- charging a fee to a first party controlling use of the second memory;
- connecting the first memory with the second memory such that the digital signal can pass therebetween;
- transmitting the digital signal from the first memory to the second memory; and
- storing the digital signal in the second memory. (emphasis added)

The second Office Action in the '497 Application was issued on May 10, 1990 on the basis of Claims 11 to 20. All of the claims were rejected as anticipated by either of U.S. Patent 3,718,906 or 3,990,710. Mr. Schwartz responded to this Office Action on August 21, 1990. In this response, Claims 11, 12 and 15 were amended and Claim 21 was added. Claims 14 and 16 to 20 were canceled. Claims 11 and 15 were amended by including the recitation of a "transmitter" and a "receiver." New Claim 21 read identically to Claim 12, except that it depended from independent Claim 15. On September 9, 1990, Examiner Nguyen issued an Advisory Action indicating that the amendments would not be entered.

The amendment was resubmitted with a File Wrapper Continuation and subsequently entered. The File Wrapper Continuation was assigned application serial number 07/586,391 (the "391 Application"). The '391 Application was filed as a **continuation** of the parent '497 Application and claimed priority to the June 13, 1988 filing date. In fact, due to a clerical error, Mr. Schwartz was required to revive the '497 Application as unintentionally abandoned for the express purpose of establishing copendency with the '391 Application so that a proper claim for

priority could be made. No new oath was required by the Office when the '391 Application was filed.

The first Office Action in the '391 Application was issued on September 9, 1991 on the basis of Claims 11 to 13, 15 and 21. All of the claims were rejected as obvious over U.S. Patent 3,990,710. Mr. Schwartz responded to this Office Action on December 9, 1991. In this response, Claims 11 and 15 were amended to recite that the first party location was remote from the second party location. Claim 15 was further amended to delete the reference to digital audio signals. Claim 22 was added, and was essentially identical to Claim 13, but depended from Claim 21. In addition to the claim amendments, text was added to pages 3 and 5 of the specification.

The next Office Action in the '391 Application was issued on February 24, 1992 on the basis of Claims 11 to 13, 15, 21 and 22. In the Office Action, Examiner Nguyen explicitly objected to the amendments to the specification and rejected all of the claims as being unsupported by the originally filed specification. *See* pages 5 to 6 of the February 24, 1992 Office Action. Examiner Nguyen specifically pointed out the following as not having a basis in the original specification:

- (1) "transferring money"
- (2) "second party financially distinct from the first party"
- (3) "in the controlling step 'receiver in possession...of the second party'"
- (4) "telephoning"
- (5) "providing a credit card"

The specification was objected to "as originally filed, failing to provide clear support for the amendments to pages 3 and 5." The amendments to pages 3 and 5 encompassed the entirety of the amendments to the specification. Claims 11 to 13, 15, 21 and 22 were also rejected as obvious over U.S. Patent 3,990,710.

Mr. Schwartz responded to this Office Action on June 23, 1992. In this response, the amendments to the specification adding text at pages 3 and 5 were withdrawn. A substitute specification was submitted to address formal issues. Further, a new amendment to the specification was presented adding a new Abstract and adding text at page 6 and page 12 of the substitute specification. Claims 11 and 15 were amended to recite "transferring money electronically via a telecommunications line" and "connecting electronically via a telecommunications line." Claim 15 was again amended to delete "audio." Claim 23 was added.

In addition to the amendments and arguments filed with the Office Action response on June 23, 1992, Mr. Schwartz also filed a Declaration by Arthur Hair under 37 C.F.R. § 1.132 indicating that one of ordinary skill in the art would recognize that all of the terminology presented in the claims and specification by amendment was supported by the originally filed specification.

The next Office Action in the '391 Application was issued on September 21, 1992 on the basis of Claims 11 to 13, 15 and 21 to 23. The Office Action indicated that Claims 11 to 13, 15, 21 and 22 were allowable based on the response filed on June 23, 1992. Claim 23 was rejected. Mr. Schwartz responded to this Office Action on September 30, 1992 by canceling rejected Claim 23. The Examiner proceeded to issue a Notice of Allowance and Issue Fee Due on October 19, 1992. The Issue Fee was paid on December 4, 1992 and the '391 Application duly issued as the '573 Patent on March 2, 1993.

III. THE APPROPRIATE PRIORITY DATE FOR THE CLAIMS OF THE '573 PATENT IN REEXAMINATION IS JUNE 13, 1988

As set forth in Section II above, the '573 Patent issued from U.S. Patent Application Serial No. 07/586,391 (the "'391 Application'"), which was filed as a continuation of U.S. Patent

Application Serial No. 07/206,497 (the “497 Application”). The Office admits the ‘573 Patent is not a continuation-in-part, but asserts that the ‘573 Patent “shares the characteristics of a continuation-in-part.” The Office now attempts to use this novel characterization of the ‘573 Patent as a pretext to re-examine the priority date of the claims in the ‘573 Patent, which Examiner Nguyen had properly awarded as June 13, 1988. In particular, the Office is attempting to improperly reassign a priority date of September 18, 1990 to the claims in reexamination.

The Office’s actions in reassigning a priority date are improper procedurally, and incorrect based on the prosecution history of the ‘573 Patent. In the first instance, the reexamination statutes do not empower the Office to examine claims for issues of effective priority date in the absence of a continuation-in-part in the original examination history. On this basis alone, the Board should vacate the Examiner’s findings with respect to the proper priority date of the claims in the ‘573 Patent. Even if the Board does not vacate the Examiner’s findings on this basis, the Board should vacate the Examiner’s findings because the issue was thoroughly dealt with by Examiner Nguyen during the initial examination of the ‘573 Patent, and thus does not present a new issue related to patentability. Even putting those arguments aside, the Board should vacate the Examiner’s findings with respect to priority because the claims as issued in the ‘573 Patent and as currently constituted in reexamination are clearly supported by the original specification filed on June 13, 1988.

A. The Office Exceeded Its Statutory Authority In Considering Issues Of Priority In The Instant Reexamination

The Office exceeded its statutory authority by considering issues of priority in the instant reexamination. It is well established that the scope of a reexamination proceeding is limited to whether claims are patentable under 35 U.S.C. §§ 102 and 103 “on the basis of patents and

printed publications.” 37 C.F.R. § 1.552. The reexamination rules explicitly preclude consideration of issues arising under 35 U.S.C. § 112, except “with respect to subject matter added or deleted in the reexamination proceeding.” *Id.*; see also *In re Etter*, 756 F.2d 852, 856 (Fed. Cir. 1985) (*en banc*) (“only new or amended claims are also examined under 35 U.S.C. §§ 112 and 132”).

Moreover, the inquiry under Section 120 as to whether the language of a particular claim, as filed or amended during an original prosecution, was supported or unsupported by sufficient disclosure is, by definition, not a *new* question. Rather, it is an issue that necessarily arises at the time of original filing or amendment, and one that necessarily is before the original examiner. Where a continuation-in-part (“CIP”) appears in the prosecution history of a patent in reexamination, it may be necessary to make an inquiry into whether claims in the CIP, as issued or amended in reexamination, find support in the originally filed parent application or rely on new matter added when the CIP was filed during the original prosecution of the patent. However, where no CIP appears in the record this issue cannot arise since by definition no new matter was found to be added during the original prosecution of the patent in question.

As a result, it is beyond the scope of reexamination for an examiner to make a threshold determination that new matter was added during the original examination of a patent in reexamination in the absence of a recognition of such new matter in the record of the original examination of the patent in question.

1. There Is No CIP In The Prosecution History Of The ‘573 Patent

The Office admits the ‘573 Patent is not a continuation-in-part, but then asserts the ‘573 Patent “shares the characteristics of a continuation-in-part,” and cites this as a basis for assigning a later priority date to the claims of the ‘573 Patent. The Office points to text added

to the specification of the '391 Application that was not found in the originally filed specification in the '497 Application as grounds for this new designation. The Office further cites MPEP § 201.11 to support its conclusion. However, the presence of additional or different text in the specification of a continuation application does not by itself render the continuation application a CIP. The prohibition of MPEP § 201.11 concerns addition of text that would constitute *new matter*.

As set forth in Section II above, the '391 Application was filed under the old File Wrapper Continuation procedure. According to MPEP § 201.06(b), in effect at the time, if the '391 Application had been filed as a CIP a new oath or declaration would have been required; none was required. Therefore, no CIP appears in the history of the original prosecution of the '573 Patent.

Further, the Office has cited no authority that empowers it, in the context of reexamination, to treat a continuation application as a CIP because the examiner in reexamination believes the continuation "shares characteristics of a continuation-in-part." An application or patent is either a continuation-in-part, or it is not. There simply is no designation in the statutes or regulations for patents that are continuations, but "share the characteristics of continuations-in-part", as asserted by the Office. Therefore, the Office has no statutory basis for reassigning the priority date for the '573 Patent.

2. The Reexamination Statute Does Not Empower The Office To Address Issues Of Priority Under 35 U.S.C. § 120 In The Absence Of A CIP Application In The Prosecution History Of A Patent In Reexamination

The Office relies on MPEP §§ 2258(I)(C) and 2217 for an implicit grant of authority to cite intervening art based upon a newly determined effective filing date for claims. The Office refers to two cases: *In re Ruscetta*, 255 F.2d 687 (C.C.P.A. 1958) and *In re van Langenhoven*,

458 F.2d 132 (C.C.P.A. 1972), cited in MPEP § 2258(I)(C) as granting the underlying authority to address issues under 35 U.S.C. § 120 in reexamination. The Office's reliance on *Ruscetta* and *van Langenhoven* is misplaced. Both *Ruscetta* and *van Langenhoven* deal explicitly with patents issued from CIP applications, which as discussed *supra*, is simply not the case in the present reexamination. Further, both cases pre-date the reexamination statute, and thus say nothing about the proper conduct of reexamination proceedings. The Office has cited no further authority to support its interpretation of *Ruscetta* or *van Langenhoven*. Moreover, the Office cannot expand the holdings of these cases simply by inserting references to them in MPEP sections dealing with the scope of reexamination. "The MPEP sets forth PTO procedures; it is not a statement of law." *Regents of the Univ. of New Mexico v. Knight*, 321 F.3d 1111, 1121 (Fed. Cir. 2003).

In contrast to the present case, where a CIP application appears in the prosecution history of a patent in reexamination, it is appropriate to consider the issue of the effective priority date of a claim in reexamination, since it is recognized that a CIP application may introduce new matter not disclosed in its parent application. However, where no CIP appears in the original prosecution record, the examiner in reexamination has no basis for determining that new matter was added during the original prosecution. Further, the limited scope of reexamination prohibits the examiner from undertaking this analysis on his own initiative.

3. MPEP § 2258.IV.E Does Not Empower The Office To Revisit The Issue Of The Entitlement To A Priority Date Of Claims In An Issued Patent

The Office cites MPEP § 2258.IV.E as an example of revisiting priority issues in reexamination. However, most of this section addresses only the procedural issues in reexamination for perfecting a claim for priority made previously during initial examination and does not address the merits of a claim for priority.

The cited section also deals with claiming priority under 35 U.S.C. § 120 to an earlier filed copending application during reexamination where there was an earlier *failure* to make such a claim. In the instant case, a claim of priority of June 13, 1988 was made by the applicant. Examiner Nguyen determined the '573 Patent was in fact entitled to that priority date. Since a claim of priority is, by definition, before the Examiner when it is made, it can never be a new issue in reexamination; *i.e.* an issue that the original Examiner had no reason to consider. Indeed, MPEP § 201.11, cited favorably by the Office, *requires* an Examiner to address the issue during initial examination.

Further, MPEP § 2258.IV.E does not address revisiting and removing an earlier claim of priority made in an application, and does not address the entitlement of an issued patent to an earlier claimed right of priority.

Finally, MPEP § 2258.IV.E addresses reexaminations initiated by the Appellant. The section does not empower the Office to address the issue of entitlement to a claimed priority date where the issue is not first raised by the Appellant.

The Office also cites MPEP § 1402, which concerns reissue proceedings, as an example of addressing priority issues. However, again, the cited section deals with adding or changing claims of priority, where an earlier claim contained an error or was not made at all. While MPEP § 1405 does address deletion of a priority claim in reissue, that section does not empower the Office on its own to determine the propriety of the priority claim.

Finally, 37 C.F.R. § 1.552(c) is explicit about the scope of re-examination:

Issues other than those indicated in paragraphs (a) and (b) of this section *will not be resolved in a reexamination proceeding*. If such issues are raised by the patent owner or third party requester during a reexamination proceeding, the existence of such issues will be noted by the examiner in the next Office action, in which

case the patent owner may consider the advisability of filing a reissue application to have such issues considered and resolved.

37 C.F.R. § 1.552(c) (emphasis added). Therefore, notwithstanding MPEP § 1405, the propriety of a previously made priority claim cannot be revisited by the Office during reexamination.

B. The Priority Date For The Claims In The '573 Patent Is Not A New Issue Related To Patentability

Even if the reexamination statute did provide authority to address the issue of priority in reexamination, which it does not, the Office is still barred from considering the issue with respect to the '573 Patent because it does not present a new issue related to patentability.

1. Examiner Nguyen Assigned A Priority Date Of June 13, 1988 To The Claims In The '573 Patent

During initial examination of the '573 Patent, the '391 Application was filed as a **continuation** of the '497 Application and thus, as a preliminary matter, was entitled to the filing date of the original application, June 13, 1988. The Office makes much of the fact that the '391 Application was filed pursuant to the old File Wrapper Continuation procedure, which permitted the filing of CIPs. However, as set forth above, MPEP § 201.06(b), in effect at the time the '391 Application was filed, required that a CIP application filed pursuant to the File Wrapper Continuation procedure include a new oath or declaration. Since Examiner Nguyen did not require a new oath or declaration, as a threshold matter she assigned the priority date of June 13, 1988 to the '391 Application when it was filed.

Notwithstanding this, the Office has asserted that Examiner Nguyen did not consider or have reason to consider the issue of whether the additions to the specification constituted new matter. In support of these assertions, Examiner Foster provided a chart in the Office Action of

September 29, 2006, showing when and under what circumstances additions to the specification and resulting claim amendments were made in the '497 and '391 Applications.

Appellant responded to this assertion by reproducing the Examiner's chart in amended form to demonstrate that Examiner Nguyen did in fact consider the various additions to the specification and concluded those additions did not constitute new matter and the subject claims therefore were supported under Section 112. The chart has been amended by adding three columns, subtitled respectively: "Consideration by Examiner Nguyen," "Response by Applicant," and "Subsequent Action by Examiner Nguyen." That chart is set forth below:

	Parent Application 07/206,497 filed June 13, 1988		Child Application 07/586,391 filed September 18, 1990		Office Action in Application 07/586,391 and response		Issuance of '573 Patent
Feature	Date First Appearing in Claims of Parent Application	Date First Appearing in Specification of Parent Application	Date First Appearing in Claims of Child Application	Date First Appearing in Specification of Child Application	Consideration by Examiner Nguyen	Response by Applicant	Subsequent Action by Examiner Nguyen
Transferring Money from Second Party to a First Party (Charging a Fee)	December 22, 1988 February 28, 1990			September 18, 1990	Considered in Office Action February 24, 1992	Objection/ rejections specifically responded to in June 25, 1992 response	Claims allowed in September 21, 1992 Office Action
Providing a Credit Card Number	December 22, 1988			September 18, 1990	Considered in Office Action February 24, 1992	Objection/ rejections specifically responded to in June 25, 1992 response	Claims allowed in September 21, 1992 Office Action
Controlling Use of First/Second Memory	December 22, 1988			September 18, 1990	Considered in Office Action February 24, 1992	Objection/ rejections responded to in June 25, 1992 response	Claims allowed in September 21, 1992 Office Action

Transmitting to a Location Determined by Second Party	February 28, 1990			September 18, 1990	Considered in Office Action February 24, 1992	Objection/rejections responded to in June 25, 1992 response	Claims allowed in September 21, 1992 Office Action
Specific Video Download Procedures	February 28, 1990			September 18, 1990	No new matter issues were ever raised	No response was ever necessary since no issue was ever raised	Claims allowed in September 21, 1992 Office Action
First Party in Possession of Transmitter	August 24, 1990 (not entered)			September 18, 1990	Considered in Office Action February 24, 1992	Objection/rejections responded to in June 25, 1992 response	Claims allowed in September 21, 1992 Office Action
Second Party in Possession of Receiver and Second Memory	August 24, 1990 (not entered)			September 18, 1990	Considered in Office Action February 24, 1992	Objection/rejections specifically responded to in June 25, 1992 response	Claims allowed in September 21, 1992 Office Action

The foregoing chart shows that, following submission of the subject additions to the specification and corresponding amendments to the claims, Examiner Nguyen considered those additions and amendments in the Office Action of February 24, 1992. That consideration included an objection to the specification as containing new matter under Section 132, and corresponding rejections of the relevant claims under Section 112. The Applicant responded to, and overcame, that objection and those rejections in the Response of June 25, 1992. In that Response, the Applicant included arguments and a Declaration under 37 C.F.R. § 1.132 establishing that the additions to the specification had ample support in the originally filed specification because the subject matter of the additions was implicitly disclosed and

understood by those skilled in the art.² After considering this Response by the Applicant, Examiner Nguyen withdrew the objection to the specification and the Section 112 rejections of the claims, and thereby determined the claims were allowable.

The amended chart set forth above demonstrates indisputably that Examiner Nguyen *did consider* the very same new matter and Section 112 rejections that the Office now asserts. As a result, by definition, Examiner Nguyen determined that the claims in the '573 Patent were entitled to claim priority to the original June 13, 1988 filing date.

In the Office Action in the instant reexamination dated March 17, 2007, the Office admitted that Examiner Nguyen did in fact address the issue of the alleged new matter shown in the table above. The Office further admitted that Appellant has effectively demonstrated as much through the table submitted with Appellant's Response to the Office Action of September 29, 2006. However, the Office now asserts that Examiner Nguyen did not have an opportunity to compare all of the amendments to the claims and specification made during prosecution to the originally filed specification. The Office refers to "gradually added new matter," which the Office asserts was not addressed by Examiner Nguyen. However, the Office fails to explicitly identify what it considered the "gradually added new matter." At best, the Office merely refers generally to Table II in the Office Action dated March 17, 2007. Upon reviewing Table II in its entirety, it is apparent that the table merely contains the same alleged new matter as the table presented above. That is, Table II does include anything that could be identified as "gradually added new matter," nor does it include anything that the Office has not already admitted was reviewed and passed on by Examiner Nguyen. As a result, the Office's rejection amounts to a

² As an ancillary matter, the Office now seems to question the persuasiveness of the Section 1.132 Declaration submitted by applicant during examination of the '391 Application. Appellant respectfully points out this is not an issue that can be addressed on reexamination. The original Examiner must be assumed to have done his job properly in the initial examination. *See Am. Hoist & Derrick Co. v. Sowa & Sons, Inc.*, 725 F.2d 1350, 1359 (Fed. Cir. 1984).

bogus rejection that fails to define what is meant by “gradually added new matter.” *See, e.g.*, MPEP § 706.03(o) (noting that, in making a new matter rejection, an examiner is required to “identify the new matter by page and the line numbers and/or drawing figures and provide an appropriate explanation of [his/her] position”). Therefore, the rejection is improper and the Board should reverse it.

2. The Absence Of Rejections Based On Intervening References During The Initial Examination Of The ‘573 Patent Does Not Demonstrate Examiner Nguyen Failed To Address The Issue Of Priority

Notwithstanding the above, the Office also asserts that Examiner Nguyen never had reason to consider the propriety of the claim of priority made in the ‘391 Application, because no intervening references were ever cited by the Examiner. This line of argument by the Office effectively puts the rabbit in the hat by concluding that the absence of any intervening references in the record is conclusive evidence the issue of priority was never addressed by Examiner Nguyen. It is more plausible to conclude that no intervening references were cited because Examiner Nguyen properly concluded the ‘391 Application was entitled to the priority date of June 13, 1988. This conclusion is fully supported by the written record as detailed in Section II and Section III(B)(1) above.

3. The Office Lacks Jurisdiction To Review Again The Same Section 112 Issues Determined By Examiner Nguyen

As established above, the question of Section 112 support, and hence the appropriate priority date for the claims in the issued ‘573 Patent, were considered and passed on by Examiner Nguyen in the original examination. Therefore, as a matter of established law, the Office lacks jurisdiction under the facts in this proceeding to challenge again the Section 112 support and the June 13, 1988 priority date of the claims in reexamination.

In *Patlex Corp. v. Quiqq*, 680 F. Supp. 33 (D.C. Cir. 1988), the United States District Court for the District of Columbia addressed a situation substantially identical to the circumstances of the present reexamination. In that case, the District Court reversed, on summary judgment, a decision by the BPAI upholding the final rejection of three claims in a reexamination proceeding. The claims in question had issued in a patent that resulted from a string of continuation and divisional applications relating back to an original priority application. The reexamination examiner took the position that the three claims were not entitled to the original priority date. Consequently, the reexamination examiner reassigned a later effective priority date, based on the reexamination examiner's determination that the specification had not enabled the three claims under Section 112 as of the original filing date.

The District Court determined, however, that the issue of whether the three claims were enabled under Section 112 previously had been considered and decided by the original examiner, and the Court therefore explicitly held that the reexamination examiner lacked jurisdiction to consider that issue again:

Entitlement to the ... [original priority] filing date was decided in the ... [original] examination. Plaintiffs contended then they were entitled to the [original priority] filing date, and the first Examiner considered then whether the [original] disclosure was enabling. Consequently, in order to reexamine ... [the patent] on the basis of whether the claims were anticipated by ... [later prior art], the reexamination examiner had to "reexamine" the question of whether the specification of the ... [original application] contained an enabling disclosure of the subject matter claimed in the ... [patent]. As noted above, however, the reexamination statute does not contemplate a "reexamination" of the sufficiency of a disclosure. Rather it is limited to reexamination of patentability based on prior art patents and publications. Hence, the Court concludes that the Examiner and the Board lack jurisdiction in this case to "reexamine" the sufficiency of the specification of the ... [original application].

Id. at 36-37. (Emphasis added). The holding of the *Patlex* case, therefore, is clear. Where, as in the present case, an original examiner already has considered and determined the sufficiency of a specification's disclosure under Section 112 and the resulting entitlement of claims to an original priority date, there is no "substantial new" question of patentability for reexamination, as required by 35 U.S.C. § 301, *et seq.* As a result, the Office lacks jurisdiction to "reexamine" that same issue for those same claims in a subsequent reexamination proceeding.

For this reason as well, the Board should vacate the Examiner's determinations regarding the proper priority date for the '573 Patent.

C. The Claims In The '573 Patent Plainly Are Supported By The Originally Filed Specification

The Office asserts that, for written description support, the claims in the '573 Patent rely on certain alleged new matter added to the specification during the original prosecution of the '573 Patent. The Office also asserts that the claims directed to the video embodiment of the invention are not supported by disclosure that was enabling as of the original June 13, 1988 filing date. As set forth above, Appellant's position is that the Office lacks jurisdiction to review issues of adequate written description and enablement, especially where the particular issue was dealt with explicitly in the original prosecution of the patent in reexamination. Those arguments aside, it is clear the originally filed specification does in fact provide both adequate written description for all of the claims and an enabling disclosure for those claims directed to the "video feature" of the invention.

1. The Claims As Issued In The '573 Patent Are Supported By Adequate Written Description In The Originally Filed Specification

Appellant provides below an analysis demonstrating that each element in Claims 1 through 6 as issued in the '573 Patent is supported, either explicitly or implicitly, by the original specification filed on June 13, 1988.

i) The Proper Standard For Determining If The Claims Are Adequately Supported By The Specification As Filed

As a preliminary matter, the standard for written support in the absence of *ipsis verbis* recitation of a claim limitation is not strictly the inherency or required interpretation standard urged by the Office. Rather, the proper standard generally is whether the written description reasonably conveys to the skilled artisan that the inventor was in possession of the claimed subject matter.

The issue of whether the written description requirement has been met is a question of fact, to be determined on a case-by-case basis. *Vas-Cath, Inc. v. Mahurkar*, 935 F.2d 1555, 1562 (Fed. Cir. 1991). The legal standard for determining whether the facts of a particular case meet the written description requirement is well established, however. In *Vas-Cath*, the Court of Appeals for the Federal Circuit ("CAFC") held that "[t]he test for sufficiency of support in a patent application is whether the disclosure of the application relied on '*reasonably conveys* to the skilled artisan that the inventor had possession at that time of the later claimed subject matter.'" *Vas-Cath*, 935 F.2d at 1563 (emphasis added). As further held by the CAFC in *Union Oil Co. of Cal. v. Atlantic Richfield Co.*, 208 F.3d 989 (Fed. Cir. 2000), "[t]he written description does not require the applicant 'to describe exactly the subject matter claimed, [instead] the description must clearly allow persons of ordinary skill in the art to recognize that [the inventor] invented what is claimed.'" *Id.* at 997. In other words, contrary to the Office's

assertions, the general standard does not require that the “only reasonable interpretation” of the general features in the specification be the more specific features in the claims. *Vas-Cath*, 935 F.2d at 1566 (“[t]he [district] court further erred in applying a legal standard that essentially required the drawings of the ‘081 design application to *necessarily exclude* all diameters other than those within the claimed range.”)(emphasis in original).

Because the written description requirement is fact-based, various decision makers have at times appeared to drift from the “reasonably conveys” standard mandated by the CAFC. The CAFC, however, has never wavered from this standard. For example, in *Hyatt v. Boone*, 146 F.3d 1348 (Fed. Cir. 1998) the court reviewed a Board of Patent Appeals and Interferences (“BPAI”) decision holding that one party to an interference (Hyatt) lacked the necessary written description in his originally filed application to support a later claim drawn to a count of the interference. The phraseology used by the BPAI in setting forth the standard for compliance with the written description requirement was that “the written description must be sufficient, when the entire specification is read that the ‘necessary and only reasonable construction’ that would be given it by a person of ordinary skill in the art is one that clearly supports each positive limitation in the count.” *Hyatt*, 146 F.3d at 1353. The appellant argued that the “necessary and only reasonable construction” standard applied by the BPAI was different from and more rigorous than the “reasonably conveys standard” set forth in *Vas-Cath*.

The CAFC determined that despite the arguably more rigorous phraseology used by the BPAI, the standard for meeting the written description requirement did not become more rigorous. Rather, the standard remains that “the written description must include all of the limitations...or the applicant must show that any absent text is *necessarily comprehended* in the description provided and would have been so understood at the time the patent application

was filed.” *Hyatt*, at 1354-55 (emphasis added). Moreover, the CAFC has on subsequent occasions repeatedly reinforced that the standard of *Vas-Cath* remains in effect. *See, e.g., Pandrol USA, LP v. Airboss Ry. Prods, Inc.*, 424 F.3d 1161, 1165 (Fed. Cir. 2005) (“[t]he applicant must...convey with reasonable clarity to those skilled in the art that, as of the filing date sought, he or she was in possession of the invention.”)

In addition to *Hyatt*, the Office has cited *In re Robertson*, 169 F.3d 734 (Fed. Cir. 1999), and *Lockwood v. American Airlines, Inc.*, 107 F.3d 1565 (Fed. Cir. 1997), as establishing a strict inherency standard for finding written support for a claim element not having *ipsis verbis* support in the specification. In the first instance, the citation of *In Re Robertson* is inapposite. In *Robertson*, the CAFC reiterated the well-known standard for determining anticipation or obviousness of a claim by prior art where the prior art does not include literal disclosure of one or more elements of the claim. As such, *Robertson* was a case directed solely to Section 102/103 issues, and does not even mention Section 112. Moreover, nowhere in *Hyatt* or *Lockwood* does either court even allude to an inherency standard for showing support for claim limitations not described *ipsis verbis* in the specification. Rather, the CAFC simply held in *Lockwood* that “exact terms need not be used *in haec verba*..., the specification must contain an equivalent description of the claimed subject matter.” *Lockwood*, 107 F.3d at 1572 (citations omitted).

Therefore, the requirement of an inherency standard under Section 112 is unsupported by *Hyatt*, *Robertson*, or *Lockwood*. Rather, the proper standard to be applied by the Examiner in determining compliance with the written description requirement remains “whether the disclosure of the application as originally filed reasonably conveys to the artisan that the inventor had possession at that time of the later claimed subject matter, rather than the presence

or absence of literal support in the specification for the claim language.” *In re Kaslow*, 707 F.2d 1366, 1375 (Fed. Cir. 1983).

ii) All Features of Claims 1 Through 6 In The ‘573 Patent Find Written Support In The Originally Filed Specification

Applying the proper standard for compliance with the written description requirement under Section 112, all of the limitations in Claims 1 through 6 of the ‘573 Patent are supported by the originally filed specification. To illustrate this point, Appellant has prepared a detailed chart showing each feature of the invention, the claims in which those features are recited, and where support in the originally filed specification is found for each feature. That chart is set forth immediately below:

Feature	Claims Reciting Feature	Written Description of Feature in Original Specification	Comments
A method for transmitting a desired digital audio signal	1	p. 1, lns. 7-9 p. 2, lns. 8-10, 20-26	<i>ipsis verbis</i> support
stored on a first memory of a first party to a second memory of a second party	1, 4	p. 3, lns. 35-40 p. 4, lns. 12-26	The specification states <i>ipsis verbis</i> that the hard disk in the control unit of the authorized agent is the source of the digital signal. Further, the specification states that the digital signal is transferred to the hard disk in the control unit of the user. A skilled artisan would understand this as transferring signals stored on a first memory to a second memory.
transferring money via a telecommunications line to a first party location remote from the second memory	1, 4	p. 1, lns. 13-15 p. 2, lns. 8-10, 20-23, 47-50 p. 3, lns. 20-33 Fig. 1	The specification discloses electronic sales via telephone lines. Because the agent is authorized to sell and to transfer via telephone lines, there is implicit support for selling and thereby transferring money. This was previously pointed out in the declaration of Arthur Hair submitted May

			5, 1992. A skilled artisan would readily understand this to comprehend transfers between two remote locations.
second party financially distinct from the first party	1, 4	p. 1, lns. 13-15 p. 2, lns. 8-10, 20-23, 47-50 p. 3, lns. 20-33	A skilled artisan would readily recognize that a sale requires the parties to be financially distinct. This was previously pointed out in the declaration of Arthur Hair submitted May 5, 1992.
second party controlling use and in possession of the second memory	1, 3	p. 3, lns. 26-33, 40-43	The as filed original specification includes <i>ipsis verbis</i> support for a second party control unit, where the user is the second party. A skilled artisan would readily recognize that the second memory is in possession and control of the second party, since the specification as originally filed states throughout that the user can store, sort and play thousands of songs from the user unit. A skilled artisan would clearly understand that this means the second party controls and possesses the second party control unit. This was previously pointed out in the declaration of Arthur Hair submitted May 5, 1992.
connecting electronically via a telecommunications line the first memory with the second memory	1, 4	p. 3, lns. 35-40	<i>ipsis verbis</i> support
transmitting the desired digital audio signal from the first memory with a transmitter in control and possession of the first party	1	p. 2, lns. 47-52 p. 3, lns. 35-40 Fig. 1	The as filed original specification has <i>ipsis verbis</i> support transmitting a desired digital audio signal and that the hard disk in the control unit of the authorized agent is the source. A skilled artisan would recognize that in order to regulate distribution of the signals the authorized agent would have to possess and control the transmitter. This was previously pointed

			out in the declaration of Arthur Hair submitted May 5, 1992.
to a receiver having the second memory at a location determined by the second party; said receiver in possession and control of the second party	1, 4	p. 2, lns. 47-50 p. 3, lns. 20-40 Fig. 1 p. 4, lns. 21-23	A skilled artisan would readily recognize in order to receive digital signals over telecommunications lines as disclosed throughout the specification, part of the second party control unit would act as a receiver. This was addressed previously in the affidavit of Arthur Hair dated May 5, 1992. A skilled artisan would also readily understand this to comprehend transfers between two remote locations. Since the second party possesses the second memory, the second party can determine its location. This was addressed previously in the declaration of Arthur Hair submitted May 5, 1992.
storing the digital audio signal in the second memory	1	p. 2, lns. 23-27	<i>ipsis verbis</i> support
searching the first memory for the desired digital audio signal	2	p. 3, lns. 35-40 p. 4, lns. 12-28	The as filed original specification has <i>ipsis verbis</i> support for electronic sales and electronic transfer of digital signals from a control unit of an authorized agent to a control unit of a user. A skilled artisan would readily recognize that this would include searching the hard disk of the first party to locate desired digital signals for purchase.
selecting the desired digital audio signal from the first memory	2	p. 3, lns. 35-40 p. 4, lns. 12-28	The as filed original specification has <i>ipsis verbis</i> support for electronic sales and electronic transfer of digital signals from a control unit of an authorized agent to a control unit of a user. A skilled artisan would readily recognize that this would include selecting desired

			digital signals from the hard disk of the first party for purchase.
telephoning the first party controlling use of the first memory by the second party	3, 6	p. 2, Ins. 47-50 p. 3, Ins. 20-40 Fig. 1 p. 4, Ins. 21-23	The original as filed specification states throughout that digital audio or digital video signals are sold and transferred via telephone lines. A skilled artisan would readily recognize this as comprehending the telephoning of the first party by the second party to initiate a transaction. This was addressed previously in the declaration of Arthur Hair submitted May 5, 1992.
providing a credit card number of the second party to the first party so that the second party is charged money	3, 6	p. 1, Ins. 13-15 p. 2, Ins. 8-10, 20-23, 38-52 p. 3, Ins. 12-15, 35-37	The original as filed specification states throughout that the invention provides for electronic sales of digital audio or digital video signals. A skilled artisan would readily recognize credit card sales as being comprehended within electronic sales. This was addressed previously in the affidavit of Arthur Hair dated May 5, 1992.
first party controlling the first memory	3, 6	p. 2, Ins. 38-43 p. 3, Ins. 35-49	The as filed original specification includes <i>ipsis verbis</i> support for a first party control unit, where the authorized agent is the first party. A skilled artisan would readily recognize that the first party control unit is in possession and control of the first party because as an "agent authorized to electronically sell and distribute" digital audio or digital video, the first party would necessarily have to possess and control the source of the digital audio and digital video. This was previously pointed out in the declaration of Arthur Hair

			submitted May 5, 1992.
A method for transmitting a desired digital video signal	4	p. 5, lns. 36-43	<i>ipsis verbis</i> support
transmitting the desired digital video signal from the first memory with a transmitter in control and possession of the first party	4	p. 5, lns. 36-43 p. 2, lns. 47-52 p. 3, lns. 35-40 Fig. 1	The as filed original specification has <i>ipsis verbis</i> support transmitting a desired digital audio signal and that the hard disk in the control unit of the authorized agent is the source. A skilled artisan would recognize that in order to regulate distribution of the signals the authorized agent would have to possess and control the transmitter. This was previously pointed out in the declaration of Arthur Hair submitted May 5, 1992. A skilled artisan would recognize based on the disclosure at the end of the specification that this procedure could also be used for digital video.
storing the digital video signal in the second memory	4	p. 5, lns. 36-43 p. 2, lns. 23-27	The as filed original specification has <i>ipsis verbis</i> support for storing digital signals on the hard disk of the user control unit. A skilled artisan would recognize based on the disclosure at the end of the specification that this procedure could also be used for digital video.
searching the first memory for the desired digital video signal	5	p. 3, lns. 35-40 p. 4, lns. 12-28 p. 5, lns. 36-43	The as filed original specification has <i>ipsis verbis</i> support for electronic sales and electronic transfer of digital signals from a control unit of an authorized agent to a control unit of a user. A skilled artisan would readily recognize that this would include searching the hard disk of the first party to locate desired digital signals for purchase. A skilled artisan would recognize based on the

			disclosure at the end of the specification that this procedure could also be used for digital video.
selecting the desired digital video signal from the first memory	5	p. 3, lns. 35-40 p. 4, lns. 12-28 p. 5, lns. 36-43	The as filed original specification has <i>ipsis verbis</i> support for electronic sales and electronic transfer of digital signals from a control unit of an authorized agent to a control unit of a user. A skilled artisan would readily recognize that this would include selecting desired digital signals from the hard disk of the first party for purchase. A skilled artisan would recognize based on the disclosure at the end of the specification that this procedure could also be used for digital video.

For all the reasons set forth in the chart immediately above, the written description standard was satisfied for Claims 1 through 6 of the '573 Patent. For the same reason, Claims 44 through 49 are also supported by the originally filed specification of the '497 Application.

Moreover, the claim language "transferring money electronically via a telecommunication line to a first party at a location remote from the second memory," "charging a fee," "providing a credit card number," and "charging an account," all would have been understood by one of ordinary skill in the art in the context of the described electronic sales and distribution of digital audio signals or digital video signals. In this context, one of ordinary skill in the art would have recognized that electronic sales encompassed transactions where a fee is charged, and thus money is transferred from one party to another electronically via a telecommunication line. It further would have been understood by one of ordinary skill in the art that electronic sales could be accomplished by providing a credit card number. As a result, one of ordinary skill in the art in 1988 would have recognized that the description of

electronic sales in the specification of the '497 Application necessarily comprehends "transferring money to a first party from a second party electronically via telecommunication lines," "charging a fee," "charging an account," and "providing a credit card number."

One of ordinary skill in the art in 1988 would have also been aware of the available means for connecting computer systems to telecommunication lines for the purpose of transferring electronic signals; for example modems. Such means could be used at the originating (transmitting) computer and at the destination (receiving) computer. The control unit or control integrated circuit of the copyright holder and user would have been recognized by one of ordinary skill in the art as being some type of computer system or part of a computer system. Therefore, the terms in the claims "transmitter" and "receiver" describe what would have been understood by one of ordinary skill in the art as being necessarily comprehended by the description provided in the specification and figures filed with the '497 Application.

Finally, it easily would have been recognized by one of ordinary skill in the art in 1988 that the specification's teaching requires establishing some type of connectivity as a prerequisite to making a purchase/sale of digital signals, as well as for transferring the digital signals. Since the specification of the '497 Application explicitly discloses selling and transferring digital audio signals (or digital video signals) over telephone lines, it is clear that the step of requesting and establishing connectivity (telephoning) is necessarily comprehended in the description provided in the '497 Application, since the step would have been recognized as a prerequisite for performing the function of the disclosed system.

For all of the above reasons, Claims 1 through 6 and 44 through 49 find adequate written support in the specification of the '497 Application as filed and are therefore entitled to

the June 13, 1988 priority date. For this reason as well, the Board should vacate the Examiner's findings with respect to the priority date of the '573 Patent.

2. The "Video Feature" of the Invention in Claims 4 Through 6 Of The '573 Patent Was Enabled By The Originally Filed Specification

The Office asserts the "video feature" of the invention in Claims 4 through 6 was not enabled by the disclosure in the originally filed specification.

The Office acknowledges the "original specification does contain a general statement at the end of the specification stating '[f]urther, it is intended that this invention not be limited to Digital Audio Music and can include Digital Video....'" The Office, however, generally asserts "this broad, generic statement fails to enable specifically claimed video download and processing procedures." September 29, 2006 Office Action, page 12. Since the Office has not specifically identified which portions of the claims allegedly are not enabled, Appellant will discuss below the issue of enablement with respect to particular comments made in the September 29, 2006 Office Action.

i) The Office Is Attempting To Apply An Improper Standard For Enablement

The Office is attempting to apply a "mass production" standard to the claims when, in actuality, the enablement standard of Section 112 has no such requirement. As the CAFC held in *Christianson v. Colt Indus. Operating Corp.*, 822 F.2d 1544, 1562 (Fed. Cir. 1987), "the law has never required that [an Appellant]... must disclose in its patent the dimensions, tolerances, drawings, and other parameters of mass production not necessary to enable one skilled in the art to practice (as distinguished from mass-produce) the invention." Nonetheless, it appears this kind of "mass production" information is exactly the kind of information the Office now seeks. For example, the Office Action states "[p]ersonal user devices with the processing power

capable of playing back much larger and more complicated digital video files, such as DVD players, were not routinely available until the late 1990(s).” September 29, 2006 Office Action, pages 19-20. (emphasis added.) Whether such devices “routinely” were available is not part of the test for enablement, nor is it one of the eight factors for reasonable experimentation that were laid out by the CAFC in *In re Wands*, 858 F.2d 731 (Fed. Cir. 1988). Rather, the only relevant test is whether, without undue experimentation, one of ordinary skill in the art could have made and used the claimed invention.

As further evidence that the Office seeks to apply a “mass production” standard, it is noted that the Office Action states “the digital bandwidth required to transmit a video signal at even VHS quality was around 1.5 megabits per second (approximately 30 megabytes in 3 minutes).” Office Action, page 14. (emphasis added.) However, while VHS quality may be appropriate for “mass production,” a limitation requiring VHS quality video is not included in any of the claims, and thus it is impermissible for the Office to use that level of quality as a benchmark for enablement. In fact, the recent success of very small screen video players shows that “mass production” can be achieved with even less than VHS quality.

Even if VHS quality were a requirement for enablement of the claims, there is no articulated basis to believe the original specification would not have enabled one of ordinary skill in the art to meet that quality for a short period of time. This fact is accentuated by the statement in the Office Action that “it is not clear ... how downloaded files of any appreciable or viable size would have been downloaded and stored on originally disclosed hard disk 60 of the user in the original specification.” September 29, 2006 Office Action, page 20. (emphasis added.) The use of “appreciable” and “viable” makes it clear that short videos are enabled, and nothing more is required. Further, the Office appears to acknowledge that even a 30-megabyte

hard drive could store a three-minute movie if encoded at 1.5 megabits/second. *Id.* That alone is sufficient to meet the enablement requirement.

Moreover, the Office impermissibly limits the scope of what it referenced when the Office Action cites the size of available hard drives. While a 30-megabyte hard drive would have been available in a 3.5-inch form factor, the same chart relied on by the Office illustrates that hard drives larger than 1.89 gigabytes were available at the same time. *See* September 29, 2006 Office Action, footnote 14.

Furthermore, the Office has applied the same “mass production” requirement to the library server. The Office initially seems to acknowledge that mainframes did exist which could have operated as repositories for copyrighted materials using hard disk drives. However, the Office then seems to discount the relevance of the existing mainframes by stating “it is not clear how even a small-sized video library ... would have been stored in the hard disk of the copyright holder ... without requiring details directed to a complex mainframe operating environment.” This unsupported statement on “complexity” is insufficient to prove that mainframe operating environments capable of storing digital video files were not already known at the time the original specification was filed, or that undue experimentation would have been required to store digital video files in such an environment. The statement also leaves unanswered how the Office is defining “small” -- according to the enablement standard under Section 112 or the improper “mass production” standard?

The Office Action further states “[r]egarding the transfer of these large video files over a network, the proliferation of broadband communication network[s] capable of delivering these large files to consumers, such as the Internet, simply did not exist or were not well known in 1988.” September 29, 2006 Office Action, pages 14-15. (emphasis added.) Such a statement

raises at least two issues. First, “not well known” to whom? Those of ordinary skill in the art of computer systems knew of telephony-based wide area networks at the time the original specification was filed. Second, utilization of a “broadband” network is not required. In fact, the originally filed specification discloses that the audio and video files can be transferred over telephone lines. While this may not be an extremely fast method of transfer, it nonetheless clearly is enabling under Section 112.

The Office further questions “how the digital video would have been coded and decoded during transmission, as digital video coding standards for purposes of transmission and file download were not settled in 1988. [T]he MPEG-1 standard which was designed to code/decode digital video information and to transmit the video via a telephone (telecommunications) network in NTSC (broadcast) quality for archiving, was only established in 1992.” September 29, 2006 Office Action, page 21. (emphasis added.) Again, standardization of video coding and the use of “NTSC quality” relate to “mass production” rather than enablement under Section 112. Thus, the Office has not alleged -- and cannot allege -- that one of ordinary skill in the art could not have coded video at some other resolution or using some other encoding technique at the time the original specification was filed.

In contrast, those of ordinary skill in the art would have been able to code and decode video data transmitted over a telephone line without undue experimentation. This is because there were existing video teleconferencing systems known and available to them prior to applicant’s earliest priority date. As earlier as five years before applicant’s earliest priority date digital video signals could have been and were sent via telephone networks and decoded with picture processors in real-time.

Similarly, not only were TV processors for video processing available for use in video processing systems, but network interface specifications were available for making systems that were compatible with signals sent via telephone networks. As such, contrary to the position of the Office Action, it is clear that at the time of filing of the earliest priority application, one of ordinary skill in the art would have been able to transmit, download and decode video signals as claimed without undue experimentation.

Accordingly, Claims 4 through 6 and Claims 47 through 49 directed to the “video feature” embodiment of the invention are enabled by the originally filed specification under the proper standard for Section 112 enablement.

D. Because Claims 1 Through 6 And 44 Through 49 Are Entitled To The June 13, 1988 Priority Date Awarded During the Original Examination, *Cohen* Is Not Appropriate Prior Art

Based on the foregoing, Claims 1 through 6 and 44 through 49 in reexamination are entitled to the June 13, 1988 priority date. In the first instance, it is improper for the Office to reconsider the issue of priority in the present reexamination for the reasons set forth in Sections III(A) and (B) above. Further, even if it were proper to reconsider the issue of priority, the facts of record clearly show the claims were described adequately and enabled by the originally filed specification for the reasons set forth in Section III(C) above. Therefore, U.S. Patent 4,949,187 to Cohen (*Cohen*) cannot be a proper basis for a rejection because the reference post-dates the applicable June 13, 1988 priority date for the claims. The Board should, therefore, reverse all rejections based on *Cohen*. See *supra*, Grounds 1-3 under the Grounds for Rejection to be Reviewed on Appeal.

IV. THE CLAIMS AS AMENDED ARE SUPPORTED AND ENABLED BY THE WRITTEN DESCRIPTION

In addition to questioning the written support and enablement of Claims 1 through 6 in the originally filed specification, the Office has also asserted separate rejections of Claims 1 through 6 as amended and new Claims 44 through 49 under 35 U.S.C. § 112, first paragraph. In making these rejections, the Office has improperly applied Section 112 analysis to claim elements that existed in the claims as issued, rather than limiting the analysis to “matter added or deleted” as required by 37 C.F.R. § 1.552. As detailed herein, Claims 1 through 6 and 44 through 49 are fully supported and enabled by the specification of the ‘573 Patent.

A. Rejection Of Claims 44 Through 49 Under 35 U.S.C. § 112, First Paragraph

Claims 44 through 49 have been rejected under Section 112, first paragraph, as introducing matter not described in the original specification. Claims 47 through 49 additionally have been rejected as not being enabled by the original specification.

As a preliminary matter, 37 C.F.R. § 1.552(a) states that an analysis under Section 112 will be performed with respect to *matter* added or deleted, not *claims* added or deleted. The restatement of matter already presented in Claims 1 through 6 in the form of Claims 44 through 49 does not add *matter* to the claims. MPEP § 2163.I states that issues under Section 112 “*most typically... arise in the context of...new or amended claims.*” (emphasis added.) This statement does not empower the Office to assert Section 112, first paragraph, rejections every time previously claimed matter is presented in the form of a different claim.

The only element present in Claims 44 through 49 that was not previously present in Claims 1 through 6 is the recitation of a hard disk. Therefore, the Office may only examine the recitation of “hard disk” for compliance with Section 112, first paragraph. A review of the

originally filed specification demonstrates this recitation is fully supported and enabled by the originally filed specification. *See* Original Specification, p. 3, ln. 30.

Nonetheless, even if it were proper for the Office to examine Claims 44 through 49 in their entirety for compliance with Section 112, first paragraph, under 37 C.F.R. § 1.552(a), those issues were already addressed by Examiner Nguyen during the initial examination of Claims 1 through 6, as set forth above.

Further, as demonstrated by the Appellant in Section III above, each element of Claims 44 through 49 is fully supported and enabled by the specification of the '497 Application as originally filed. Therefore, the Board should reverse the rejections of Claims 44 through 49 under 35 U.S.C. § 112, first paragraph.

B. Rejection Of Claims 1 Through 6 Under 35 U.S.C. § 112, First Paragraph

Claims 1 through 6 have been rejected under Section 112, first paragraph, as introducing matter not described in the original specification. Claims 4 through 6 additionally have been rejected as not being enabled by the original specification.

The Office asserts that the negative limitation of “a non-volatile storage portion of the second memory, wherein the non-volatile storage is not a tape or a CD”, introduces a new concept to the claims that does not have a basis in the originally filed specification. The Office cites two cases from the BPAI, one case from the CAFC, and one case from the Court of Customs and Patent Appeals (“C.C.P.A.”) to support this rejection. None of the cases support the rejection.

The CAFC case cited by the Office, *Lizardtech, Inc. v. Earth Res. Mapping, Inc.*, 433 F.3d 1373 (Fed. Cir. 2006), is merely an opinion denying a petition for rehearing *en banc*. The

case does not address anything related to the current rejection. Therefore, the case simply does not support the Office's position.

The two cases from the BPAI, *Ex Parte Wong*, No. 2004-1144, 2004 WL 4981845 (Bd. Pat. App. & Interf. June 10, 2004) and *Ex Parte Grasselli*, 231 U.S.P.Q. 393 (Bd. Pat. App. & Interf. 1983), address situations where a negative limitation added to a claim was not described in the specification of the application. However, neither *Wong* nor *Grasselli* support the rejection of Claims 1 through 6 under Section 112, first paragraph, in the instant case. In both *Wong* and *Grasselli*, the issue and ultimate ground for rejection was that a negative limitation added to the claims introduced a new concept not disclosed in the respective specifications in those cases. That simply is not the situation here. Both Claims 1 and 4 recite a non-volatile storage portion of a memory that is not a tape or CD. The originally filed specification of the '497 Application explicitly states that the disclosed invention eliminates the need to handle tapes and CDs. *See* p. 2, Ins. 23 to 26. Thus, the concept of storing digital audio or digital video signals on a memory that is not a tape or CD is explicitly disclosed by the original specification. Therefore, *Wong* and *Grasselli* are inapposite to the present case.

The case from the C.C.P.A., *Application of Johnson*, 558 F.2d 1008 (C.C.P.A. 1977), concerns a situation where the applicant sought to claim priority to an originally filed application for claims in a subsequent continuation-in-part application. The holding of *Johnson* also fails to support the Office's position. In *Johnson*, an original parent application disclosed and claimed a genus of polymer compositions comprising various monomer units. In a later filed CIP application, the broad genus claims in the parent application were narrowed by expressly excluding certain species from the polymer compositions. The parent application only contained a description of the broader genus. The court found that claims to the narrower

sub-genus created by the express exclusion of certain species in the CIP were not supported by the description of the broader genus in the parent specification. Again, the situation with the present reexamination differs significantly from the cited case law. Claims 1 and 4 recite a non-volatile storage portion of a memory that is not a tape or CD. This is exactly what is described at page 2, lines 23 to 26 of the originally filed specification. In short, the negative limitation recited in Claims 1 and 4 is expressly disclosed in the specification of the parent application. Thus, in the instant case, the scope of the disclosure in the specification was never narrowed with respect to this element, contrary to the situation in *Johnson*. Therefore, the recitation of a non-volatile storage portion of a memory that is not a tape or CD is fully supported by the originally filed specification, as well as the specification of the '573 Patent as issued.

With respect to the other elements recited in Claims 1 through 6, the issue of written support for the claimed matter previously was addressed by Examiner Nguyen during the initial examination of Claims 1 through 6, as recognized by the Office in the Office Action dated March 17, 2007. Moreover, Appellant has thoroughly demonstrated in Sections III(C)(1)(ii) and III(C)(2) above that each element in Claims 1 through 6 is fully supported and enabled by the original specification as filed, as well as the specification for '573 Patent as issued. Therefore, the Board should reverse the Examiner's rejections of Claims 1 through 6 under 35 U.S.C. § 112, first paragraph.

V. BASED ON THE PROPER PRIORITY DATE FOR THE CLAIMS IN REEXAMINATION, THE REJECTIONS OF CLAIMS 1 THROUGH 6 AND 44 THROUGH 49 BASED ON *COHEN* ARE IMPROPER

As set forth above, the proper priority for Claims 1 through 6 and 44 through 49 in reexamination is June 13, 1988. Therefore, any rejections under Sections 102 or 103 which rely on references that are not prior art based on the June 13, 1988 priority date are improper and

should be reversed. U.S. Patent 4,949,187 to Cohen (*Cohen*) issued on August 14, 1990 from an application filed on December 16, 1988. Therefore, *Cohen* does not qualify as prior art for the purposes of Sections 102 and 103.

A. Rejection Of Claims 1, 2, 4, 5, 44, 45, 47 And 48 Under 35 U.S.C. § 102(e) As Anticipated By *Cohen*

Claims 1, 2, 4, 5, 44, 45, 47 and 48 have been rejected under 35 U.S.C. § 102(e) as anticipated by *Cohen*. Because *Cohen* is not available as prior art based on the proper priority date of June 13, 1988 for the '573 Patent, the instant rejection is improper. Therefore, the Board should reverse this rejection.

B. Rejection Of Claims 1 Through 6 and 44 Through 49 Under 35 U.S.C. § 103(a) Over *Bush* In View Of *Cohen*

Claims 1 through 6 and 44 through 49 have been rejected under 35 U.S.C. § 103(a) as obvious over the combination of U.S. Patent 4,789,863 to Bush (*Bush*) in view of *Cohen*. Because *Cohen* does not qualify as prior art based on the proper June 13, 1988 priority date of the '573 Patent, a combination of *Cohen* and another reference cannot provide a proper basis for an obviousness rejection. As a result, the rejection of Claims 1 through 6 and 44 through 49 based on a combination of *Bush* and *Cohen* is improper. Therefore, the Board should reverse this rejection.

C. Rejection Of Claims 3, 6, 46 and 49 Under 35 U.S.C. § 103 (a) Over *Cohen* In View Of *Bush*

Claims 3, 6, 46 and 49 have been rejected under 35 U.S.C. § 103(a) over *Cohen* in view of *Bush*. Because *Cohen* does not qualify as prior art based on the proper June 13, 1988 priority date of the '573 Patent, a combination of *Cohen* and another reference cannot provide a proper basis for an obviousness rejection. As a result, the rejection of Claims 3, 6, 46 and 49 based on

a combination of *Bush* and *Cohen* is improper. Therefore, the Board should reverse this rejection.

VI. CLAIMS 1 THROUGH 6 AND 44 THROUGH 49 ARE PATENTABLE OVER THE REFERENCES OF RECORD THAT ARE PROPER PRIOR ART

The Office has also presented rejections under 35 U.S.C. § 103(a) that are based on references that qualify as prior art based on the June 13, 1988 priority date for the claims in reexamination. However, the Office has not established a *prima facie* case of obviousness of any of Claims 1 through 6 or 44 through 49 based on these references.

A. Rejection Of Claims 1 Through 6 And 44 Through 49 Under 35 U.S.C. § 103(a) Over *Bush* In View Of *Freeny I*

Claims 1 through 6 and 44 through 49 have been rejected under 35 U.S.C. § 103(a) as obvious over the combination of *Bush* in view of U.S. Patent 4,837,797 to Freeny (*Freeny I*).

The Office admits that *Bush* does not disclose storing digital audio signals or digital video signals in a non-volatile storage portion of a second memory that is not a tape or a CD as recited in Claims 1 and 4. As further admitted by the Office, *Bush* does not disclose storing digital audio signals or digital video signals in a second party hard disk as recited in Claims 44 and 49.

Freeny I discloses a message controller for receiving voice messages and machine readable messages over telephone lines. The apparatus of *Freeny I* is capable of differentiating between voice messages and machine readable messages received over standard telephone equipment, *i.e.* a telephone. When the apparatus of *Freeny I* determines that a received call is a voice message, it causes the user's telephone to ring, thereby alerting the user. When the apparatus of *Freeny I* determines that a received call is a machine readable message, it converts the message to human readable form using a standard printer or display unit. One embodiment

of the apparatus of *Freeny I* indicates it is capable of receiving machine readable messages and storing them on a storage medium that may be a memory chip or hard disk.

However, *Freeny I* does not discuss transmission of digital audio or digital video signals from a first memory to a second memory, let alone the sale of such digital video or digital audio signals. Thus, *Freeny I* bears no relation to the disclosure of *Bush* or the invention recited in Claims 1 through 6 and 44 through 49. The Office apparently has recognized this deficiency in *Freeny I*, because the Office must cite to *Cohen* to show motivation to combine *Bush* and *Freeny I*. However, as set forth above, *Cohen* is not available as prior art based on the priority date of June 13, 1988 for the '573 Patent.

The Supreme Court's recent holding in *KSR Int'L Co. v. Teleflex Inc.*, 127 S. Ct. 1727 (U.S. 2007), does not relieve the Office of the obligation to show motivation to combine two separate references in making out a *prima facie* case of obviousness. Quite to the contrary, the Supreme Court stated: "[t]o determine whether there was an apparent reason to combine the known elements in the way a patent claims, it will often be necessary to look to interrelated teachings of multiple patents; to the effects of demands known to the design community or present in the marketplace; and to the background knowledge possessed by a person having ordinary skill in the art. *To facilitate review, this analysis should be made explicit.*" *KSR*, 127 S. Ct. at 1731 (emphasis added).

Since the Office has not shown any motivation to combine *Bush* and *Freeny I*, a *prima facie* case of obviousness has not been established. Therefore, the Board should reverse this rejection.

B. Rejection Of Claims 1 Through 6 And 44 Through 49 Under 35 U.S.C. § 103(a) Over *Akashi* In View Of *Freeny II*

Claims 1 through 6 and 44 through 49 have been rejected over Japanese Patent Application No. 62-284496 (*Akashi*) in view of U.S. Patent 4,528,643 to Freeny (*Freeny II*). Such a rejection is unfounded. First, the combination of *Akashi* and *Freeny II* would not reach the presently claimed invention. Second, there is no motivation to combine *Akashi* and *Freeny II*.

The Office asserts that *Akashi* shows a system for transmitting recorded music from a host computer that stores recorded music data to a personal computer. The Office then asserts that *Akashi* “does not expressly detail...whether the data is stored on a non-volatile portion of a second memory that is not a tape or CD.” This is incorrect. *Akashi* explicitly discloses a record reproducing device that is a compact disk deck or a digital audio tape recorder. See *Akashi* Translation, p. 2 (Embodiment). In other words, *Akashi* is not ambiguous at all on this point. Thus, not only does *Akashi* fail to disclose transmitting digital audio signals or digital video signals from a first memory to a second memory and storing the digital audio signals or digital video signals in a non-volatile portion of the second memory that is not a tape or CD, *Akashi* expressly teaches away by specifically disclosing and requiring a tape recorder or CD deck.

The Office asserts the deficiencies of *Akashi* are cured by *Freeny II*. Specifically, the Office asserts that *Freeny II* discloses transmitting digital audio signals or digital video signals from a first memory in control and possession of a first party to a second memory in control and possession of a second party, and storing the digital audio signals or digital video signals in a non-volatile storage that is not a tape or CD. The Office further asserts it would have been obvious to implement the non-volatile storage of *Freeny II* in the system of *Akashi* because “[t]he use of a hard disk would have allowed the user to more efficiently access audio and video

files.” The Office bases its position on the conclusion that “a hard-disk, would have also increased the security and reliability of the stored data.”

For several reasons, it would not have been obvious to combine the teachings of *Akashi* and *Freeny II* to arrive at the invention recited in Claims 1 through 6 and 44 through 49. First, *Freeny II* discloses a kiosk-type system for producing “material objects” at a point of sale location where it is the “material object” that is sold to consumers. *Freeny II*, Abstract. Thus, like *Akashi*, *Freeny II* expressly teaches away from storing digital audio signals or digital video signals on a non-volatile storage portion of a second memory that is not a tape or CD in possession and control of a second party. Further, in *Freeny II*, the second memory (information manufacturing machine) for storing the information that is transformed into material objects is in possession and control of the first party. The first party controls access to the information on the second memory by requiring a fee to be paid for the consumer (second party) to access the information stored on the second memory. After the fee is paid, the second party has limited access to the specific information requested for the purpose of making a copy in the form of a material object. In the case of audio or video information, the material object would be in the form of a tape or CD. Therefore, again, both *Akashi* and *Freeny II* contemplate and require supplying audio information to the consumer in the form of a tape or CD. Thus, like *Akashi*, *Freeny II* expressly teaches away from storing digital audio signals or digital video signals on non-volatile storage portion of a second memory that is not a tape or CD in possession and control of a second party.

Additionally, in *Freeny II*, the necessary material object containing the digital audio or digital video signals is produced by accessing information stored on the second memory. The first memory (information control machine) simply supplies reproduction authorization codes in

response to a request for reproduction from the information manufacturing machine. The second party never has access to the first memory, as recited in present Claims 2, 5, 45 and 48.

Both *Akashi* and *Freeny II* solve the same problem: providing audio information, and video information in the case of *Freeny II*, to a consumer in the form of a material object, such as a tape or CD. *Akashi* and *Freeny II* solve this common problem in different and unrelated ways. Nonetheless, neither of the references teaches or discloses the benefits of transmitting digital audio signals or digital video signals from a first memory to a second memory and storing those digital audio signals or digital video signals in a non-volatile portion of the second memory that is not a tape or CD, which is in possession and control of a consumer, *i.e.* a second, financially distinct, party. Therefore, the combination of *Akashi* and *Freeny II* does not teach or suggest every limitation of Claims 1 through 6 or 44 through 49. In fact, because both *Akashi* and *Freeny II* expressly require storing digital audio signals or digital video signals on a tape or CD, they teach away from the invention recited in Claims 1 through 6 and 44 through 49. “[W]hen the prior art teaches away from combining certain known elements, discovery of a successful means of combining them is more likely to be nonobvious.” *KSR*, 127 S. Ct. at 1740. As a result, these references cannot be combined to render Claims 1 through 6 obvious.

Even if the combination of *Akashi* and *Freeny II* did teach each and every element of Claims 1 through 6 or 44 through 49 – which they do not – the motivations cited by the Office for combining and/or modifying *Akashi* and *Freeny II* are not found in those references. Moreover, the Office has not cited to any other references or knowledge available to one of ordinary skill in the art in 1988 that would have motivated a skilled artisan to combine and/or modify *Akashi* and *Freeny II* as suggested by the Office. Rather, the Office simply has made vague statements that the security and reliability of hard disks would have been well known at

the time. Such general allegations are insufficient to show motivation to combine these references, particularly since neither one of them even hints at such a modified combination. Again, as the Supreme Court has just admonished: “[a] patent composed of several elements is not proved obvious merely by demonstrating that each element was, independently, known in the prior art.” *KSR*, 127 S. Ct. at 1731.

Based on all of the foregoing, the Office has not established a *prima facie* case of obviousness of Claims 1 through 6 and 44 through 49 over the combination of *Akashi* and *Freeny II*. Therefore, the Board should reverse this rejection.

C. The Secondary Considerations Of Non-Obviousness Support The Finding Of Non-Obviousness Of Claims 1 Through 6 And 44 Through 49

Although a showing of secondary considerations is not strictly necessary to establish the non-obviousness of Appellant’s invention, such secondary considerations in fact do exist.

The CAFC has explicitly set forth the factors, such as commercial success, long felt but unresolved needs, skepticism by experts, and copying by competitors that can be used to establish non-obviousness. *Brown & Williamson Tobacco Corp. v. Philip Morris Inc.*, 229 F.3d 1120, 1129 (Fed. Cir. 2000). The CAFC has held that a nexus must be established between the merits of a claimed invention and the evidence of non-obviousness offered if that evidence is to be given substantial weight enroute to a conclusion of non-obviousness. *Ex parte Remark*, 15 U.S.P.Q.2d 1498, 1502 (Bd. Pat. App. & Interfer. 1990). The CAFC has also held, however, that copying of a patented feature or features of an invention, while other unpatented features are not copied, gives rise to an inference that there is a nexus between the patented feature and the commercial success. *Hughes Tool Co. v. Dresser Industries, Inc.*, 816 F.2d 1549, 1556 (Fed. Cir. 1987). Moreover, it is well established that copying of a patented invention, rather

than one within the public domain, is by itself indicative of non-obviousness. *See Windsurfing Int'l Inc., v. AMF, Inc.*, 782 F.2d 995, 1000 (Fed. Cir. 1986).

The invention recited in Claims 1-6 (and Claims 44-49) generally comprises transferring “for pay” digital video or digital audio signals between a first memory controlled by a seller and a second memory at a remote location controlled by a buyer over a telecommunication line. The invention has in the past achieved significant commercial success. *See, e.g.*, Declaration of Arthur R. Hair submitted with Appellant’s Response dated December 27, 2005.

Moreover, the invention continues to achieve commercial success in that it has been copied by a major participant in the field. The features of the invention generally included in Claims 1-6 (and Claims 44-49) have been copied by at least one commercially successful system available today: Napster Light. The Napster Light system (“Napster”) for purchasing digital music files online at www.napster.com is a commercially successful system that embodies the features of the claimed invention. The Declaration of Justin Douglas Tygar, Ph.D. (“Tygar Dec. 2005”), a copy of which is filed herewith, supports the assertion that Napster is commercially successful and has copied the claimed invention.

Dr. Tygar determined that Napster has achieved a level of commercial success. *See* Tygar Dec. 2005, para. 6. Further, Dr. Tygar compared Napster to the invention recited in Claims 1-6 and determined Napster copied the invention. Specifically, Dr. Tygar found that Napster operates a music download system incorporating servers having hard disks and memory, through which it sells digital music files to a buyer for download over the Internet. *See* Tygar Dec. 2005, para. 10. The buyer using Napster has a computer at a home, office, or other location remote from Napster. *See* Tygar Dec. 2005, para. 11. The buyer forms a connection between his or her computer and Napster via the Internet, selects digital music

file(s) he or she wishes to purchase, provides a credit card number, and receives the music file via a download process where the file is transferred from Napster's server to the buyer's computer and stored on the hard drive. The buyer can then play the file using his or her computer system. *See Tygar Dec. 2005, paras. 12-16.* In view of this comparison, Dr. Tygar properly concludes that Napster has copied the features taught by the present invention. *See Tygar Dec. 2005, para. 19.*

Additionally, Napster *does not* copy the alleged closest prior art cited by the Examiner, *i.e., Freeny and Akashi.* *Freeny* teaches a point-of-sale device (e.g., a kiosk) that dispenses a material object (e.g., tape) containing the music purchased. *See Freeny, col. 1, line 64 to col. 2, line 12.* These features of *Freeny* are plainly not found in Napster. *See Tygar Dec. 2005, para. 16.* *Akashi* teaches writing data to a digital audio tape recorder or a compact disk deck that employs a write-once, read-many times recordable optical disk which allows data to be read immediately after the data is written. The user downloads data to a RAM and then the data is written directly from the RAM to a recordable optical disk. *See Akashi para. 6.* This process of *Akashi* is not how Napster operates. *See Tygar Dec. 2005, para. 18.*

Therefore, it is apparent that Napster chose to copy the system taught by the '573 patent. *See Tygar Dec. 2005, para. 19.* It is also apparent that Napster chose *not* to copy the prior art systems of *Freeny* and *Akashi.* *See Tygar Dec. 2005, para. 20 and 21.* This selective copying by Napster of the invention recited in Claims 1-6 (and Claims 44-49), while Napster ignored the systems of *Freeny* and *Akashi,* provides a sound basis upon which the required nexus between commercial success and Appellant's claimed invention can be found. *See Hughes Tool, 816 F.2d at 1556.* Additionally, Napster's selective copying of Appellant's invention, coupled with Napster's disregard of the *Freeny* and *Akashi* systems, is itself substantive evidence of a

recognized secondary indication of non-obviousness. See *Windsurfing International Inc.*, 782 F.2d 995 (Fed. Cir. 1986).

The foregoing remarks and the Declaration of Dr. Tygar establish the requisite nexus between the commercial success of Napster and Appellant's claimed invention. These remarks and the Declaration of Dr. Tygar similarly have established copying by Napster as a secondary indicia of non-obviousness.

Conclusion

Based on the foregoing, the Board should reverse the rejections of Claims 1 through 6 and 44 through 49 under 35 U.S.C. §§ 102(e) and 103(a). Also based on the foregoing, the Board should reverse the rejection of Claims 1 through 6 and 44 through 49 under 35 U.S.C. § 112, first paragraph.

Respectfully submitted,

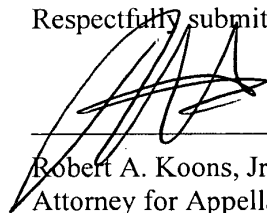

Robert A. Koons, Jr., Esq.
Attorney for Appellant
Reg. No. 32,474

Drinker Biddle & Reath LLP
One Logan Square
18th and Cherry Streets
Philadelphia, PA 19103-6996
Telephone (215) 988-3392
Facsimile (215) 988-2757
Date: December 15, 2008

CLAIMS APPENDIX

1.(Amended) A method for transmitting a desired digital audio signal stored on a first memory of a first party to a second memory of a second party comprising the steps of: transferring money electronically via a telecommunication line to the first party at a location remote from the second memory and controlling use of the first memory from the second party financially distinct from the first party, said second party controlling use and in possession of the second memory; connecting electronically via a telecommunications line the first memory with the second memory such that the desired digital audio signal can pass there-between; transmitting the desired digital audio signal from the first memory with a transmitter in control and possession of the first party to a receiver having the second memory at a location determined by the second party, said receiver in possession and control of the second party; and storing the digital signal in a non-volatile storage portion of the second memory, wherein the non-volatile storage portion is not a tape or CD.

2.(Original) A method as described in claim 1 including after the transferring step, the steps of searching the first memory for the desired digital audio signal; and selecting the desired digital audio signal from the first memory.

3.(Original) A method as described in claim 2 wherein the transferring step includes the steps of telephoning the first party controlling use of the first memory by the second party; providing a credit card number of the second party controlling the second

memory to the first party controlling the first memory so the second party is charged money.

4.(Amended) A method for transmitting a desired digital video signal stored on a first memory of a first party to a second memory of a second party comprising the steps of: transferring money electronically via a telecommunications line to the first party at a location remote from the second memory and controlling use of the first memory, from a second party financially distinct from the first party, said second party in control and in possession of the second memory; connecting electronically via a telecommunications line the first memory with the second memory such that the desired digital video signal can pass there-between; transmitting the desired digital video signal from the first memory with a transmitter in control and possession of the first party to a receiver having the second memory at a location determined by the second party, said receiver in possession and control of the second party; and storing the digital signal in a non-volatile storage portion of the second memory, wherein the non-volatile storage portion is not a tape or a CD.

5.(Original) A method as described in claim 4 including after the transferring money step, the step of searching the first memory for the desired digital signal and selecting the desired digital signal from the first memory.

6.(Original) A method as described in claim 5 wherein the transferring step includes the steps of telephoning the first party controlling use of the first memory by the second party controlling the second memory; providing a credit card number of the second party controlling the second memory to the first party controlling the first memory so the second party controlling the second memory is charged money.

7-43 (Canceled)

44.(New) A method for transmitting a desired digital audio signal stored on a first memory of a first party to a second memory of a second party comprising the steps of:
transferring money electronically via a telecommunications line to the first party at a location remote from the second memory and controlling use of the first memory from the second party financially distinct from the first party, said second party controlling use and in possession of the second memory;
the second memory including a second party hard disk;
connecting electronically via a telecommunications line the first memory with the second memory such that the desired digital audio signal can pass therebetween;
transmitting the desired digital audio signal from the first memory with a transmitter in control and possession of the first party to a receiver having the second memory at a location determined by the second party, said receiver in possession and control of the second party;
and storing the digital signal in the second party hard disk.

45.(New) A method as described in claim 44 including after the transferring step, the steps of searching the first memory for the desired digital audio signal; and selecting the desired digital audio signal from the first memory.

46.(New) A method as described in claim 45 wherein the transferring step includes the steps of telephoning the first party controlling use of the first memory by the second party; providing a credit card number of the second party controlling the second memory to the first party controlling the first memory so the second party is charged money.

47.(New) A method for transmitting a desired digital video signal stored on a first memory of a first party to a second memory of a second party comprising the steps of:

transferring money electronically via a telecommunications line to the first party at a location remote from the second memory and controlling use of the first memory from the second party financially distinct from the first party, said second party controlling use and in possession of the second memory;

the second memory including a second party hard disk;

connecting electronically via a telecommunications line the first memory with the second memory such that the desired digital video signal can pass therebetween;

transmitting the desired digital video signal from the first memory with a transmitter in control and possession of the first party to a receiver having the second memory at a location determined by the second party, said receiver in possession and control of the second party;

and storing the digital signal in the second party hard disk.

48.(New) A method as described in claim 47 including after the transferring step, the steps of searching the first memory for the desired digital signal; and selecting the desired digital signal from the first memory.

49. (New) A method as described in claim 47 wherein the transferring step includes the steps of telephoning the first party controlling use of the first memory by the second party; providing a credit card number of the second party controlling the second memory to the first party controlling the first memory so the second party is charged money.

EVIDENCE APPENDIX

- 1) Declaration under 37 C.F.R. § 1.132 of Arthur R. Hair, submitted by Appellant in a response dated December 27, 2005 (and again in a response dated February 6, 2006). The Declaration was repeatedly cited on pages 20 to 23 of the February 6, 2006 response to support the argument for secondary considerations of non-obviousness, including copying and commercial success. A copy of the Declaration was included in the response as an exhibit. The Examiner, in an Office Action dated March 20, 2006, considered the Declaration stating on page 5, “Applicant’s arguments with respect to commercial success are not persuasive because commercial success may have been attributable to extensive advertising and position as a market leader before the introduction of the patented product.” Because (a) Appellant’s response having the Declaration attached was entered into the record, (b) Appellant’s commercial success argument was predicated in substantial part on the Declaration, and (c) the Examiner stated he considered the commercial success arguments, it is apparent that the Declaration was considered and entered.
- 2) Declaration under 37 C.F.R. § 1.132 of Dr. J. Douglas Tygar, submitted by Appellant in a response dated December 27, 2005 (and again in a response dated February 6, 2006). The Declaration was repeatedly cited on pages 20 to 23 of the February 6, 2006 response to support the argument for secondary considerations of non-obviousness, including copying and commercial success. A copy of the Declaration was included in the response as an exhibit. The Examiner, in an Office Action dated March 20, 2006, considered the Declaration stating on page 5, “Applicant’s arguments with respect to

commercial success are not persuasive because commercial success may have been attributable to extensive advertising and position as a market leader before the introduction of the patented product.” Because (a) Appellant’s response having the Declaration attached was entered into the record, (b) Appellant’s commercial success argument was predicated in substantial part on the Declaration, and (c) the Examiner stated he considered the commercial success arguments, it is apparent that the Declaration was considered and entered.

IN THE UNITED STATES PATENT AND TRADEMARK OFFICE

In re Application of:)
ARTHUR R. HAIR)
Reexamination Control No. 90/007,402)
Reexamination Filed: January 31, 2005) METHOD FOR TRANSMITTING A
Patent Number: 5,191,573) DESIRED DIGITAL VIDEO OR
Examiner: Benjamin E. Lanier) AUDIO SIGNALS
Pittsburgh, Pennsylvania 15213
December 23, 2005

Mail Stop *Ex Parte* Reexamination
Commissioner for Patents
P.O. Box 1450
Alexandria, VA 22313-1450

DECLARATION UNDER 37 C.F.R. §1.132

I, Arthur R. Hair, hereby declare that:

1. I am the sole inventor of United States Patent Nos. 5,191,573; 5,675,734; and 5,966,440.
2. I am Chairman of the Board and Chief Technology Officer of SightSound Technologies, Inc.
3. I assigned my rights in United States Patent Nos. 5,191,573; 5,675,734; and 5,966,440 to the company that ultimately became SightSound Technologies, Inc ("SightSound").
These patents served SightSound Technologies well and were essential in raising the

capital necessary to launch a company that would build eCommerce systems protected by the patents.

4. With the foregoing three patents in hand, SightSound Technologies achieved many notable firsts, including:
 - first to electronically sell a music download via the Internet;
 - first to electronically sell a movie download via the Internet;
 - first to produce a motion picture specifically for simultaneous electronic distribution worldwide via the Internet;
 - first to electronically sell encrypted movies legally through the Gnutella file-sharing networks, without being in violation of copyrights;
 - first to develop a legal system to sell encrypted music legally through the Napster file-sharing networks, without being in violation of copyrights;
 - first to electronically sell a movie into a movie theater projection booth via the Internet for digital exhibition from a windows workstation; and
 - first to electronically sell a movie into a handheld unit, a Compaq iPac Pocket PC.

5. SightSound built five Media eCommerce Systems. Over time, these systems grew from a single server located in Pittsburgh to a geographically distributed system with a central core in Pittsburgh that controlled remote servers located in New York, Los Angeles, Santa Clara, Seattle, Chicago, Washington D.C. and Boston. Version 1 was built in 1995

and Version 2 was built in 1998, both of these versions only sold music. Version 3.1, 3.2 and 3.3 were built between 1999 and 2001 and sold both music and movies. The fifth system built at SightSound Technologies (which we called Version 3.3) was a fully automated, database driven secure Media eCommerce System that had the hardware capacity to rent and/or sell 380,000 movies a day.

6. The foregoing Media eCommerce Systems were covered by one or more claims in each of United States Patent Nos. 5,141,573, 5,675,734 and 5,966,440.

7. The Media eCommerce Systems were designed to support:

- official movie websites;
- banner ads that automatically invoke a download;
- digital cinema (download to the projection booth);
- portable audio/video devices
- database driven websites; and
- peer-to-peer file-sharing networks.

8. Using its Media eCommerce Systems, SightSound Technologies provided client services releasing motion pictures and music for Internet download sale for more than 40 filmmakers, special interest video production companies and recording artists.

SightSound Technologies first offered music for sale via the Internet in download fashion in September 1995. At that time, SightSound Technologies offered music from the band

“The Gathering Field.” Individual songs were priced at 99 cents and the entire album was available for \$6.00. SightSound Technologies went on to build a respectable client roster that included over 65 companies and individuals, including:

- Miramax Films (a subsidiary of the Walt Disney Company)
- Showtime Networks (the Tyson –vs– Norris boxing match)
- Comedy Central (half owned by Fox and half owned by Warner Brothers)
- Lyric Studios (the children’s television program “Barney”)
- WQED TV

9. I have attached as part of this Declaration several announcements and media coverage illustrating the many accomplishments that United States Patent Nos. 5,191,573; 5,675,734; and 5,966,440 assisted SightSound Technologies to achieve.

I further declare that all statements made herein of my own knowledge are true and that all statements made on information and belief are believed to be true; and further, that these statements are made with the knowledge that willful false statements and the like so made are punishable by fine or imprisonment, or both, under Section 1001 of Title 18 of the United States Code, and that such willful false statements may jeopardize the validity of the application or any patent issuing thereon.

23 DECEMBER 2005
Date

Arthur R. Hair
Arthur R. Hair

IN THE UNITED STATES PATENT AND TRADEMARK OFFICE

In re Application of:)
ARTHUR R. HAIR)
Reexamination Control No. 90/007,402)
Reexamination Filed: January 31, 2005) A SYSTEM FOR TRANSMITTING
Patent Number: 5,191,573) DESIRED DIGITAL VIDEO OR
Examiner: Benjamin E. Lanier) AUDIO SIGNALS
)

December 23, 2005

Mail Stop *Ex Parte* Reexamination
Commissioner for Patents
P.O. Box 1450
Alexandria, VA 22313-1450

DECLARATION UNDER 37 C.F.R. §1.132

I, Justin Douglas Tygar, hereby declare that:

1. I am a tenured, full Professor at the University of California, Berkeley with a joint appointment in the Department of Electrical Engineering and Computer Science (Computer Science Division) and the School of Information Management and Systems.
2. I earned an A.B. degree in Math/Computer Science from the University of California, Berkeley, in 1982 and I earned a Ph.D. in Computer Science from Harvard University in 1986.
3. I am an expert in software engineering, computer security, and cryptography. I have taught courses in software engineering and computer security at the

undergraduate, master's, and doctorate level at both the University of California, Berkeley and Carnegie Mellon University.

4. I serve in a number of capacities on government, academic, and industrial committees that give advice or set standards in security and electronic commerce. In addition, I have authored numerous publications in the fields of computer science and security in electronic commerce. I have attached a copy of a recent curriculum vita to this declaration as Exhibit A.

5. At the request of counsel, I have compared a currently available system for purchasing digital audio files, namely the online music service offered at www.napster.com known as Napster Light¹ (hereinafter "Napster Light"), with the teachings of U.S. Patent 5,191,573 (the "'573 patent").

6. Napster Light is a currently operating service with an apparently wide user base. It is therefore apparent that Napster Light, which uses the teachings of the '734 Patent, has been commercially successful.

7. The '573 Patent generally discloses a method pertaining to the electronic sale and transfer of digital audio or video signals, which are signals containing recorded sound or

¹ It should be noted that the Napster Light service offered by the entity known currently as Napster, Inc. at www.napster.com is separate and distinct from a previous file sharing on-line service offered by an earlier entity entitled Napster. It is my understanding that this prior entity went out of business in 2002, at which time Roxio, Inc. acquired the Napster name and trademark rights. Subsequently, Roxio, Inc. changed their name to Napster, Inc., thus creating the current entity referred to herein as "the new Napster, Inc."

video, such as a musical or video recording, converted into binary form. The steps of the method pertain to the following:

- A first party who is a seller of digital audio or video signals through telecommunication lines. Telecommunication lines can include the Internet. The seller must have control over a computer memory, which includes a hard disk and RAM. The hard disk includes copies of encoded digital audio or video signals, which are the digital audio or video signals configured in a form that would prevent unauthorized copying.

- A second party who is a buyer of the digital audio or video signals. The buyer must possess and control his or her own computer memory. The buyer's memory must be located at a location remote from the location of the memory controlled by the seller.

8. The invention of the '573 patent comprises a number of steps, though not in any particular order except as indicated below. The steps are:

- Forming an end-to-end electronic connection over the telecommunications lines between the computer memory controlled by the seller and the buyer's computer memory, which is controlled by the buyer;

- Transmitting the desired digital audio signal from the first memory to the second memory; and

- Storing the transferred copy of the digital audio or video signals in the buyer's memory.

9. I have accessed Napster Light for the purpose of comparing it to the '734 patent. Based on my review, I have determined the following facts set forth in paragraphs 10 through 20 of this declaration.

10. The operator of Napster Light (i.e., the new Napster, Inc.), the "first party" for the purposes of this comparison, operates a music download system through which digital music files are sold to buyers for download over the internet. The digital music files contain digital representations of sound recordings. I have concluded from viewing information on www.napster.com that Napster Light uses a system that includes servers, which have memory that includes hard disks that store digital music for sale over the internet. The new Napster, Inc. appears to control the servers that contain the digital music files for sale.

11. The typical online buyer using Napster Light, the "second party" for the purposes of this comparison, controls a personal computer. For instance, the buyer controls which software to install and run on the computer, what data to store in the computer, and when to operate the computer. The buyer has the computer at a home, office, or other location remote from Napster Light.

12. Using a software application downloaded from a website associated with Napster Light, the online buyer may connect to Napster Light's online music library over the Internet and browse online music catalogs. The buyer forms a connection between his or her computer and the Internet through an Internet Service Provider (ISP) that may be accessed via a dial-up connection using a modem and a telephone line.

13. Using the downloaded software application, the online buyer browses Napster Light's online music catalogs. The online buyer can select a particular digital music file he or she desires.

14. The digital music file is delivered to the online buyer via a download operation that is automatically initiated between Napster Light's servers and the online buyer's computer.

15. The download process occurs by transmitting a copy of the digital music file over the Internet to the online buyer's computer. The transmitted copy is stored in the online buyer's computer hard drive. Throughout this downloading process, the online buyer is in control of his or her computer's memory.

16. The downloaded copy of the digital music is stored to the hard drive of the buyer's computer, from which it can be written to other media such as an optical disk or memory of a portable device.

17. Napster Light does not include a point-of-sale device such as a kiosk, as used in United States Patent No. 4,528,643 to Freeny (the "Freeny Patent").

18. Napster Light does not writing a digital signal from memory directly to an optical disk or digital tape, as taught in Japanese Patent Publication 62-284496 to Akashi (the "Akashi Patent").

19. In view of the foregoing, I have determined that Napster Light embodies the elements taught in the '573 Patent. As a result, it can be concluded that Napster Light has copied the teachings of the '573 Patent.

20. Also in view of the foregoing, I have determined that the Napster system does not embody essential elements of the Freeny patent. As a result, it can be concluded that Napster Light has not copied the Freeny patent.

21. Also in view of the foregoing, I have determined that the Napster system does not embody essential elements of the Akashi patent. As a result, it can be concluded that Napster Light has not copied the Akashi patent.

I further declare that all statements made herein of my own knowledge are true and that all statements made on information and belief are believed to be true; and further, that these statements are made with the knowledge that willful false statements and the like so made are punishable by fine or imprisonment, or both, under Section 1001 of Title 18 of the United States Code, and that such willful false statements may jeopardize the validity of the application or any patent issuing thereon.

26 Dec 05

Date

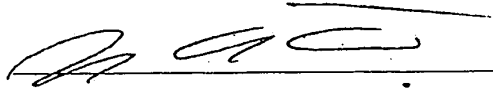

Justin Douglas Tygar, Ph.D.

RELATED PROCEEDINGS APPENDIX

- 1) *Sightsound.com Inc. v. N2K, Inc.*, 2:98-cv-00118-DWA (W.D. Pa).
-“Magistrate Judge’s Report and Recommendation” dated February 8, 2002

- 2) *Sightsound Technologies, Inc. v. ROXIO, Inc.*, 2:04-cv-01549-DWA (W.D. Pa).
- “Memorandum Order and Opinion” dated February 28, 2005, granting Defendants’
motion to stay

- 3) Appeal from final rejection in copending reexamination Control No. 90/007,403.

- 4) Appeal from final rejection in copending reexamination Control No. 90/007,407.

IN THE UNITED STATES DISTRICT COURT
FOR THE WESTERN DISTRICT OF PENNSYLVANIA

SIGHTSOUND.COM INCORPORATED,)
 a Pennsylvania Corporation,)
)
 Plaintiff,)
)
 v.)
)
 NSK, INC., a Delaware)
 corporation, CDNOW, INC.,)
 a Pennsylvania Corporation,)
 and CDNOW ONLINE, INC.,)
 a Pennsylvania Corporation,)
)
 Defendants.)

Civil Action No. 98-118
 JUDGE DONALD J. LEE
 MAGISTRATE JUDGE BENSON

MAGISTRATE JUDGE'S REPORT AND RECOMMENDATION

I. RECOMMENDATION

It is respectfully recommended that the claims in suit be interpreted as set forth in more detail in the following report.

II. REPORT

This is a patent infringement action filed by the holder of three patents which, as described by plaintiff, "are directed to commercially-acceptable systems and methods for selling music and video in digital form over telecommunications lines." (Docket #69 at 1). Plaintiff, Sightsound.com, Inc. ("Sightsound") accuses defendants N2K, Inc. ("N2K"), CDnow, Inc., and CDnow Online, Inc. (collectively referred to as "CDnow" or "defendants") of infringing multiple claims of U.S. Patent Nos. 5,191,573 ("the '573 Patent"), 5,675,734 ("the '734 Patent"), and 5,966,440 ("the '440 Patent")

through the practice of downloading digital music over the internet.¹

In view of the numerous claims which have allegedly been infringed, the court encouraged the parties to narrow issues by agreeing, where possible, to interpretations of various claims in the patents. After the parties engaged in this process, however, many disputes remained concerning claim interpretation². Hence, the court scheduled a Markman hearing, and the parties filed claim construction briefs (Docket #s 65, 69 and 75), a joint compilation of exhibits (Docket #s 70-72), and expert reports and declarations filed independently (Docket #s). A hearing was held before the undersigned on April 18, 19, 20 and May 16, 2001, at which expert testimony, demonstrative evidence, exhibits and argument were offered by the parties (Docket #s 93-96). The undersigned has

1. Of course, the court is not concerned with the accused product or practice at this point. Claim construction is accomplished "independent of the accused product." Embrix, Inc. v. Service Engineering Corp., 216 F.3d 1343, 1347 (Fed. Cir. 2000); Union Oil Company of California v. Atlantic Richfield Co., 208 F.3d 989, 994 (Fed.Cir. 2000).

2. Plaintiff initially asserted a total of thirty-nine (39) claims which contain thirty-four (34) instances of disputed claim language. The claims-in-suit are claims 1-3 of the '573 patent, claims 1-8, 10-14, and 26-27 of the '734 patent, and claims 1-10, 12-15, 22, and 36-41 of the '440 patent. Plaintiff also seeks to assert claim 11 of the '440 patent, and defendants challenge this on the basis that it was added just prior to the briefing prior the hearing (Docket #75 at 17-18). While the undersigned agrees that claim 11 was submitted late in the day, the terms used therein are not unique. Hence, for purposes of claim construction, no new burden is imposed for the parties or the court by including claim 11 at this stage. The question of the propriety of this claim being considered by the court in ruling on the ultimate issue shall be held in abeyance.

considered all of the briefs, exhibits, testimony and argument submitted. The following conclusions of law are recommended.

1. THE LAW OF CLAIM CONSTRUCTION

Construction of patent claims is a matter exclusively within the province of the court, and is a determination made as a matter of law. Markman v. Westview Instruments, Inc., 517 U.S. 370, 372 (1996); Interactive Gift Express, Inc. v. Compuserve, Inc., 231 F.3d 859, 865 (Fed.Cir. 2000); Markman v. Westview Instruments, Inc., 52 F.3d 967, 979 (Fed. Cir. 1995). In making this determination, "the viewing glass through which the claims are construed is that of a person skilled in the art." Interactive Gift, 231 F.3d at 866.

A. INTRINSIC EVIDENCE

Intrinsic evidence is the most important source of information in construing the language used in a patent. Vitronics Corporation v. Conceptronic, Inc., 90 F.3d 1576, 1582 (Fed.Cir. 1996). "Intrinsic" evidence consists of the claim language, the specification and the prosecution history. Id.; Markman, 52 F.3d at 979. "In construing claims, the analytical focus must begin and remain centered on the language of the claims themselves, for it is that language that the patentee chose to use to 'particularly point[] out and distinctly claim[] the subject matter which the patentee regards as his invention.' 35 U.S.C. §112, ¶2." Interactive Gift, 231 F.3d at 865.

The purpose of a patent is to secure to the patentee "all to which he is entitled" while "appris[ing] the public of what is still open to them." Markman, 517 U.S. at 373. In construing the scope and meaning of a claim, terms used in the claim are to be given their ordinary meaning to one skilled in the art unless it appears from the patent and file history that the terms were used differently by the inventor. Id.; Intellicall, supra; Phillips Electronics v. Universal Electronics, Inc., 930 F.Supp. 986, 997 (D.Del. 1996). Thus, the court must first look to the language of the patent claim. "If the claim language is clear on its face, then [the court's] consideration of the rest of the intrinsic evidence is restricted to determining if a deviation from the clear language of the claim is specified." Interactive Gift, 231 F.3d at 865. A patentee, after all, may "choose to be his own lexicographer and use terms in a manner other than their ordinary meaning." Vitrionics, 90 F.3d at 1582.

The court may also find that a deviation from the plain meaning of the terms used in a patent claim is warranted because the patentee, in amending a claim before the PTO or in arguing to distinguish a reference to prior art, has relinquished part of what would normally be included within a claim's plain meaning. Interactive Gift, 231 F.3d at 865, quoting Elkay Manufacturing Co. v. Ebco Manufacturing Co., 192 F.3d 973, 976 (Fed.Cir. 1999). Hence, "[i]f a patentee takes a position before the PTO, such that a 'competitor would reasonably believe that the applicant had surrendered the relevant subject matter,' the patentee may be barred

from asserting an inconsistent position on claim construction." Katz v. AT&T Corp., 63 F.Supp.2d 583, 591 (E.D.Pa. 1999). This does not mean, however, that every amendment, or every attempt by an applicant during the application process to distinguish prior art, automatically results in a corresponding limitation during claim construction. "Unless altering claim language to escape an examiner rejection, a patent applicant only limits claims during prosecution by clearly disavowing claim coverage." York Products, Inc. v. Central Tractor Farm & Family Center, 99 F.3d 1568, 1575 (Fed.Cir. 1996).

Further, although the specification may be "the single best guide to the meaning of a disputed term." Vitrionics, 90 F.3d at 1582, the court must be careful to use the specification to ascertain the meaning of disputed claim term, and not merely to impose a limit on a claim term. Interactive Gift, 231 F.3d at 865-66; citing Comark Communications, Inc. v. Harris Corp., 156 F.3d 1182, 1186 (Fed.Cir. 1998) ("fine line" exists between "reading a claim in light of the specification" and impermissible practice of "reading a limitation into the claim from the specification.").

B. EXTRINSIC EVIDENCE

"In most situations, an analysis of the intrinsic evidence alone will resolve any ambiguity in a disputed claim term. In such circumstances, it is improper to rely on extrinsic evidence." Id., 90 F.3d at 1583. In cases where the scope of the invention is described unambiguously by the intrinsic evidence, it is improper to

consider extrinsic evidence. Id. The public is entitled to rely upon the "public record" of the invention, i.e., the claims, the specification and the file history. Id., citing Markman, 52 F.3d at 978-79. "Allowing the public record to be altered or changed by extrinsic evidence introduced at trial, such as expert testimony, would make this right meaningless." Vitrionics, 90 F.3d at 1583. This same limitation applies whether it is the alleged infringer or the patentee who seeks to alter the scope of the claims. Id.

"Only if there were still some genuine ambiguity in the claims, after review of all available intrinsic evidence, should the trial court have resorted to extrinsic evidence, such as expert testimony" Vitrionics, 90 F.3d at 1584. Further, even if expert testimony is accepted and properly considered, it should be afforded no weight if it is inconsistent with the specification and file history. Id. Likewise, the inventor's subjective intent, if not expressed in the patent documents, is not entitled to any weight. Id.

In fact, a preferred type of extrinsic evidence, useful to demonstrate how a particular term is used by those skilled in the art, ~~is a prior art reference, whether or not that reference is~~ cited in the specification or file history. Vitrionics, 90 F.3d at 1584. Again, however, consideration of such extrinsic evidence is "unnecessary, indeed improper, when the disputed terms can be understood from a careful reading of the public record." Id.

This does not mean that extrinsic evidence ought never to be considered. On the contrary, extrinsic evidence may be

appropriate for a purpose other than clarifying ambiguous language in the patent:

A judge is not usually a person conversant in the particular technical art involved and is not the hypothetical person skilled in the art to whom a patent is addressed. Extrinsic evidence, therefore, may be necessary to inform the court about the language in which the patent is written. But this evidence is not for the purpose of clarifying ambiguity in claim terminology. It is not ambiguity in the document that creates the need for extrinsic evidence but rather unfamiliarity of the court with the terminology of the art to which the patent is addressed.

Markman, 52 F.3d at 986.³ The court may, then, and in this instance, did, resort to extrinsic evidence for the purpose of determining "what one of ordinary skill in the art at the time of the invention would have understood [a particular] term to mean." Id.; see also, Pitney Bowes, Inc. v. Hewlett-Packard Co., 182 F.3d 1298, 1309 (Fed.Cir. 1999). Technical treatises and dictionaries, although extrinsic evidence, may be consulted "at any time in order to better understand the underlying technology" Vitrionics, 90 F.3d at 1584. Dictionary definitions may be used by the court "when construing claim terms, so long as the dictionary definition does not contradict any definition found in or ascertained by a reading of the patent documents." Id.

3. Indeed, as one who felt (and still feels) uncomfortable with the technology of the 20th Century, and who will undoubtedly feel increasingly so with the technology of the present century, this explanation from the Court of Appeals in Markman is particularly trenchant.

C. MEANS-PLUS-FUNCTION CLAIMS

Also relevant to the construction of the claims at issue in this case is the "means-plus-function" format of stating patent claims:

An element in a claim for a combination may be expressed as a means of step for performing a specified function without the recital of structure, material, or acts in support thereof, and such claim shall be construed to cover the corresponding structure, material, or acts described in the specification and equivalents thereof.

35 U.S.C. §112, ¶6 (1994). "This provision of the patent statute permits a patentee to write a limitation in a combination claim as a means for performing a function without reciting structure, materials or acts in the limitation." Katz, 63 F.Supp.2d at 592. When interpreting a claim written in the "means-plus-function" format, the court must construe the functional language of the claim "to cover the corresponding structure, material, or acts described in the specification and equivalents thereof." 35 U.S.C. §112; Valmont Industries, Inc. v. Reinke Manufacturing Co., Inc., 983 F.2d 1039, 1042 (Fed. Cir. 1993). The patentee, however, must describe in the specification some structure which performs the specified function. Id., at 1042.

In determining whether to apply the statutory procedures of section 112, ¶ 6, the use of the word "means" triggers a presumption that the inventor used this term advisedly to invoke the statutory mandates for means-plus-function clauses. 35 U.S.C. § 112, ¶ 6 (1994); see Greenburg v. Ethicon Endo-Surgery, Inc., 91 F.3d 1580, 1584, 39 USPQ2d 1783, 1787 (Fed. Cir. 1996). Nonetheless, mere incantation of the word "means" in a clause reciting predominantly structure cannot evoke section 112, ¶ 6. [citations omitted]. Conversely, "[t]he

recitation of some structure in a means plus function element does not preclude the applicability of section 112(6)." Laitrim Corp. v. Rexnord, Inc., 939 F.2d 1533, 1536, 10 USPQ2d 1367, 1369 (Fed. Cir. 1991).

York Products, Inc. V. Central Tractor, 99 F.3d 1568, 1574 (Fed. Cir. 1996). Thus, "[t]o invoke this statute, the alleged means-plus-function claim element must not recite a definite structure which performs the described function." Cole v. Kimberly-Clark Corp., 102 F.3d 524, 531 (Fed. Cir. 1996). The court must "decide on an element-by-element basis, based upon the patent and its prosecution history, whether § 112, ¶ 6 applies." Id.

Once having decided that the means-plus-function analysis applies, the court should: (1) determine what function the means performs, and (2) find in the claim language a link between the means and the function. Katz, 63 F.Supp.2d at 593. The specification is next considered, and the court "must determine what structure, material or acts . . . correspond to the word 'means.'" Id., citing Chiuminatta Concrete Concepts, Inc. v. Cardinal Industries, Inc., 145 F.3d 1303, 1308 (Fed.Cir. 1998). There is no specific level of detail necessary in the description of structure, so long as one skilled in the art would identify the structure from the description. Atmel Corp. v. Information Storage Devices, Inc., 198 F.3d 1374, 1381 (Fed.Cir. 1999).

2. SUMMARY OF THE EVIDENCE

A. BACKGROUND AND CLAIM LANGUAGE

The patents-in-suit stem from a patent application initially filed with the United States Patent and Trademark Office (USPTO) in June, 1988. In fact, the '734 and '440 patents are "continuations" of the '573 patent, disclosing additional inventions arising from the original invention. Unsurprisingly, therefore, the patent specifications for the '734 and '440 patents mirror the patent specification for the '573 patent.

The patents each address a "system and associated method for the electronic sales and distribution of digital audio or digital video signals, and more particularly, to a system and method which a user may purchase and receive digital audio or digital video signals from any location which the user has access to telecommunications lines." (Docket #70, Exhibit 51 at 1).

In its first claim, the '573 patent discloses a four-step method of transmitting a digital audio or video signal including steps addressed to: (1) transferring money electronically; (2) connecting two "memories" by telecommunications lines so that a signal can be transmitted from the first to the second; (3) transmitting the signal; and (4) storing the digital signal in the second memory. Claim 2 is a dependent claim, building on the first claim by adding the step of searching for and selecting a desired digital signal from the first memory. Step 3 is, in turn, dependent on claims 1 and 2, and discloses additional steps in transferring money, specifically the steps of telephoning the first party and

providing the second party's credit card number "so the second party is charged money."⁴

The '734 patent, which has claims 1-8, 10-14, and 26-27 in suit, discloses in claim 1 the same basic invention as was disclosed in the '573 patent, but with the addition of steps involving the use of a "hard disk" and "sales random access memory" by the selling party, and "electronic coding" of the signal to prevent unauthorized copying thereof. Claim 2 adds the use of a "second party integrated circuit" and a "control panel" to execute commands during the process described in Claim 1. Claim 3 describes an "incoming random access memory chip" in the buyer's possession which temporarily stores the incoming digital signal until it is transferred to the buyer's hard disk. Claims 4-8 describe the use of a "control integrated circuit" in this process, and claims 10-14 describe the use of "telephone lines" as a type of "telecommunications lines" in the invention disclosed in Claim 4. Claims 26 and 27 summarize much of the preceding claims, and disclose a "means or mechanism for the first party to charge a fee to the second party remote from the second party location."

The '440 patent has sixty-three (63) claims, of which 1-15, 22, and 36-41 are at issue. Again, the claims set forth a method for transferring digital audio or digital video signals, but also disclose methods for playing such digital signals on an integrated system used by the second party.

4. The remaining claims of the '573 patent are not asserted in this suit.

The actual language of a claim is the key consideration in any construction of a patent; that language is not reproduced as an attachment to this Report, but is set out at length in the text as appropriate. So too, certain intrinsic evidence, the patent specifications and prosecution histories, are set forth in relevant part during the analysis portion of this report.

B. OTHER EVIDENCE

Other evidence presented, in the nature of declarations, dictionary definitions, expert testimony, etc., will, likewise be set forth in relevant part as necessary to discuss particular issues. However, the court will summarize the testimony presented at the hearing from the expert witnesses (which is premised upon declarations earlier submitted by the parties). This testimony has been relied upon by the undersigned to understand the technology underlying the patents-in-suit, and to determine the level of education and experience which would define "one skilled in the art" in this case. The court will also indicate during the analysis portion which, if any, of the extrinsic evidence has been considered as relevant to the construction of particular claims.

1. Dr. Tygar

Justin Douglas Tygar, Ph.D., testified as an expert on behalf of plaintiff (Docket #95 at 4-41). Dr. Tygar is a professor at the University of California at Berkeley in the department of electrical engineering and computer science (*Id.*, at 4). He works in the area of software engineering, computer security and

electronic commerce (Id., at 5). He has also "had occasion" to work with digital audio (Id.). Dr. Tygar is a senior member of the Institute of Electrical and Electronic Engineers (IEEE) (Id.).

Dr. Tygar explained the process of recording sound both by analog and digital means. He explained that a "digital converter" takes an analog representation of a sound wave, samples it at many, many points, measures the signal at each sampling point, representing the measurements with binary numbers (Id., at 8-9). The reverse process is used to change the digital sound representations back into an analog sound wave through a process of "interpolating" a sound wave between the digital signals. This, in turn, can be played through a speaker to create audible sound waves (Id., at 9).

Digital audio may be stored on a compact disk, and then "read" by a laser. The benefits of this technology are obvious to all, most notably the fact that, unlike vinyl records, CD's, unless damaged, will retain the digital information unchanged indefinitely.

"Compressed" digital audio, whereby the binary representation of a sound wave is made smaller by, for example, ~~eliminating repeated signals, is, in Dr. Tygar's opinion, still~~ digital audio (Id., at 3).

Dr. Tygar also testified that there is a difference between digital sound on one hand, and digital instructions for sound on the other. He compared the MIDI format (for "Music Instrument Digital Interface"), or instructions for sound, with sheet music. The MIDI instructions, which are binary, tell the

computer what sounds to make on an internal synthesizer (Id., at 13-14; Docket #74, Exhibit B at 5-8). He contrasted this with a sound wave represented digitally, which, although also stored in binary, permits a computer program to reproduce a sound wave which has been recorded. One of the differences between MIDI and digital sound is that vocals cannot be faithfully represented in MIDI format, while digital sound has no such limitations (Docket #95 at 15). MIDI, although versatile, is, in Dr. Tygar's opinion, simply a series of on/off commands (Id., at 6).

Dr. Tygar also testified concerning the advantages inherent in sending digital music from one computer to another (Id., at 17). There is no need for packaging, no stock problems, low overhead, and presents an easier way to find and keep in storage various types of music (Id., at 17-18).

Part of Dr. Tygar's expert report is also addressed to the nature of telecommunications systems (Docket #74, Exhibit B at 8-14). He testified that about 80% of households have a "direct link" to a telecommunication provider's "central office" (Docket #95 at 18). Although the connection between a private home and a central office is now, and was in 1988, likely to be copper wire carrying electric impulses, the telephone network is mostly digital from the central office until the individual communication reaches the other party's copper lines (Id., at 19). Hence, in 1988, as today, a telephone call could proceed entirely through copper wire as electric impulses, it could be changed into light impulses and travel through fiber optic cable, and it could also travel as radio

waves, or a combination of all three types (Id., at 20). Today, most telecommunications links are established through the fiber optic "backbone network" used by all telecommunications companies (Id., at 19).

There is in the telephone industry a concept known as "multiplexing" which occurs in telephone links. Time Division Multiplexing, or "TDM," occurs when calls are digitized and broken up into segments. These segments are sent in order, with segments from other telephone calls placed in between, then reassembled at the other end (Id., at 21)⁵. In Dr. Tygar's view, this does not create a "continuous physical conduction path" between the person sending and the person receiving a telephone call (Id.).

The Internet uses the same infrastructure as is used by the telephone system, including telephone lines and the fiber optic "backbone" (Id., at 22). There is "end to end connectivity" in an Internet transaction in that the computers at opposite ends of a transmission must establish communication with one another, i.e., a "session." (Id.). On cross-examination, Dr. Tygar conceded that a book he uses in instructing his students provides a definition of

~~"connection" which does not include the Internet, but does include~~
the telephone network (Id., at 37). He believes this to be an error in the text (Id., at 40), and noted when he was recalled as a witness that the same text, at a different point, clearly states

-
5. For example, if three calls, A, B and C were sent through the TDM process, the segments might share a fiber optic strand in the order ABCABCABCABC. The segments are then reassembled prior to reaching the ultimate destination, AAAA, BBBB, CCCC.

that a type of connection is made over the Internet (Id., at 161), and that the ultimate delivery to the receiving user in an Internet communication is in the same order as it was sent (Id., at 162).

Cell phones use radio waves, and call segments may be "handed off" between cells in a network while the cell phone user is traveling (Id., at 23). This is comparable to the manner in which the Internet uses different means of routing a message, i.e., the path used for different "packets" of information may change.

Dr. Tygar also offered opinions concerning the meaning of various terms in the patent. Briefly, they are that one skilled in the art would not have interpreted the Hair patents (the patents-in-suit, identified by the inventor's name) as covering instructions to produce sound, or MIDI (Id., at 25). Further, the process of compressing or storing digital audio is not in the nature of "computer instructions" (Id., at 27).

Also, the term "telecommunications" as used in the patents-in-suit includes both telephone communications and TCP/IP networks such as the Internet (Id., at 28). Each provides end-to-end connectivity, and uses the same infrastructure (Id., at 29).

~~Further, TDM has many similarities to the packet-switch nature of the Internet (Id.).~~

The term "telephoning" includes both human and machine-initiated calls (Id.).

"Providing payment electronically" can constitute any means of payment which is accomplished over telecommunications lines, such as the buyer providing his or her credit card number, or

the more advanced means of electronic commerce systems now being used on the Internet (Id., at 30).

ii. Professor Larky

Arthur I. Larky, Ph.D., is professor emeritus at Lehigh University where he taught as a tenured professor in electrical engineering and computer science from 1960 until his retirement. (Docket #95 at 44-45; Docket #68). He holds a Ph.D. in electrical engineering (Docket #95 at 47), and has extensive experience teaching the use of computers in the telephone system for Bell Telephone Laboratories from 1962 through 1992 (Id., 47-48). He has also helped design telephone switching systems and performed experimental work for telephone companies (Id., at 49). He was called by the defendants.

Professor Larky reviewed the Hair patents and concluded that one "skilled in the art" for purposes of those patents would be "someone who had a background in computer engineering or a combination of computer engineering and computer programming background and about two years experience in actually doing some things in the field." (Id., at 50-51).

Doctor Larky testified that an integrated circuit (IC) is a microprocessor or the "brains" of a computer (Id., at 53). Random Access Memory (RAM) is the "basic storage unit for programs and data on a computer." (Id., at 54). Although the patent lists "incoming" and "playback" RAM separately, such functions are normally performed by the same "set of chips" in a computer (Id.). The "hard disk" of

a computer is a metal disk which retains information recorded on it until that information is erased (Id., at 55).

Dr. Larky testified that it was common in 1988 to connect two computers directly by means of telephone lines (Id., at 56). One would use the keyboard or the mouse to instruct the computer to make a telephone connection through a modem (Id., at 57-58). Further, there were also, in 1988, services available which would provide computer files for download over telephone lines (Id., at 58). Files which produced audible sounds could also be downloaded in this time frame (Id., at 59).

Professor Larky described the connection made between computers via telephone lines in 1988 as establishing a "direct line connection" in that a wire would connect the computer to the telephone company, and the company would "close the necessary switches" so that the signals reach the other end (Id.). There is, in his view, allowing for the use of fiber optics, "a closed electrical path" from one computer to the other (Id., at 60). The telephone system was using both analog and digital formats in 1988 (Id., at 63).

Important to his discussion of the nature of the connections made is the concept of "conduction path," which has two meanings. The first is an electrical conduction path whereby electrons flow through a wire, and the second denotes a path through which a conversation is conducted, but which is not necessarily purely electrical in nature (Id., at 65).

Dr. Larky also addressed time division multiplexing, or TDM, which, he explained, works because the segments are always in a predetermined order. Hence, the receiving multiplexing equipment parcels the information out in the order in which it is received (Id., at 67-68). Further, each piece of information or segment follows the same path as the first. These segments are not individually "addressed" in any way because they are "in step" and are thus sorted out on the receiving end (Id., at 68, 71). There is also no means for verifying the correct delivery of information (Id., at 72). In Dr. Larky's view, as of 1988, a "solid conduction path" would exist between computers which accessed each other over the telephone system (Id., at 73).

As of 1988, two computers could connect via modem over telephone lines and exchange data (Docket #68 at 7). This is accomplished in "a single, unbroken transmission." Data exchange via a package-switch network occurred in 1988, as it does today, by the "executing computer dividing up data into packets as described by internet protocols, transmitting each packet individually to the second computer by way of network routers. The second computer, after receiving all of the packets, reassembles the data into its original form. During the packet-switch transmission, no "continuous point-to-point conduction path" is established between the computers, and the information is not sent in one unbroken transmission (Id.).

At the hearing, Dr. Larky explained that the information being exchanged in an Internet transmission is broken down into

packets by the sending computer, and that the packets are individually "addressed" so that the particular packet's proper place in order can be identified at the other end of the transmission (Docket #95 at 74). The packets are sent over the telephone system to Internet "nodes," where a computer "looks" at a packet and sends it on to another such node, and so on toward its final destination (Id., at 74). Not all packets from the same transmission necessarily follow the same path (Id., at 75). Also, a particular packet may be detained, with some packets sent later arriving at their destination before packets sent earlier (Id., at 77). A person skilled in the art would have been aware of the existence of the Internet as of 1988 (Id., at 78).

In summary, Dr. Larky indicated that the Internet is connectionless and best-effort and, therefore, inherently less reliable than a telephone connection (Id., at 79). The Internet is "connection-oriented," which means it attempts to do what a connection would do (Id., at 89). He contrasted the use of TDM by the telephone system on the basis that TDM packets are of uniform length, whereas Internet packages are of varying lengths (Id., at 85). A packet used in a switch network has a "checksum" and an "address," consisting of digital information which tells a receiving computer how large the total communication should be, and the ultimate destination, respectively. "Segment" is a term used to identify a TDM bit of information, as opposed to "packet" (Id., at 88).

The Internet operates according to the Transmission Control Protocol and the Internet Protocol ("TCP/IP"), which are part of the Internet Suite of Protocols (Docket #68 at 4). TCP governs how data is broken down into packets, IP governs the routing of the packets, and TCP governs how the packets are recombined (Id.).

On cross-examination, Dr. Larky conceded that connections exist between each router, or on each "leg," of a packet-switch network (Docket #95 at 98-100). In fact, Newton's Telecom Dictionary (Plaintiff's Exhibit A at page 680) states that "TCP first establishes a connection between the two systems that intend to exchange data" (Docket #95 at 102-03). Dr. Larky was also shown a glossary of telecommunications terms from the Federal Standard, marked as Plaintiff's Exhibit B (Id., at 104). There is no date on this exhibit, although there is reference therein to standards adopted in 1994. In that glossary, "telecommunications" is defined as meaning any transmission by wire, radio, optical or other electromagnetic systems (Id.).

Dr. Larky, too, offered an opinion concerning the Hair patents. In his view, one skilled in the art in 1988 would have understood "that the Internet is connectionless" and that "connecting electronically via a telecommunications line" would not apply to Internet communications (Id., at 90). Further, there is no reference to computer networks in the patents or the accompanying papers, and no reference to the Internet or packet-switch networks (Id., at 92).

Dr. Larky also filed a rebuttal declaration (Docket #88) in which he explains that a user of the Internet today normally has a continuous connection with the Internet Service Provider ("ISP") over a telephone line, and that the ISP then "affords access" to the Internet (Id., at 8). There is, however, no "similar connection" formed with the server of the ISP and other routers and servers located on the Internet (Id., at 9).

iii. James A. Moorer, Ph.D.

Also testifying for defendants was James Anderson Moorer, an expert in the field of digital audio signals and digital audio music (Docket #95 at 110-11; Docket #86). He has Bachelor's Degrees in electrical engineering and applied mathematics, and a Ph.D. in computer science (Docket #95 at 113). He has extensive experience with digital audio, including work with Lucasfilm and later for his own firm, Sonic Solutions (Id., at 114). Dr. Moorer has created software which address sound concerns in the film industry (Id., at 114-115), and has published in the area of digital audio, and has taught courses at Stanford University in that field (Id., at 115-16). He built a number of products used in the digital audio field, and composed digital audio music, including the theme played before the feature film in every theater equipped with a THX sound system (Id., at 116-17). He has received numerous awards, including an Emmy and a technical Oscar (Id., at 117).

Dr. Moorer believes one "skilled in the art" for purposes of these patents would possess a degree in engineering or computers.

but that some experience or skill in digital audio or digital music would be necessary as well (Id., at 112).

In 1988, the Pulse Code Modulation ("PCM") format, the format described by Dr. Tygar as a digital representation of a sound wave, would not have been practical in 1988 on account of the size of such files, while MIDI and other formats would have been (Id.). This is because commercially available hard drives at that time were between 10 to 40 megabytes in size for a consumer (Id., at 143), while such hard drives were as large as 85 megabytes for professional applications (Id., at 144). The 85 megabyte size would have allowed for the storage of about 8 minutes of music in PCM format (Id.). To do "thousands" of songs, as referenced in the patents, would have required about 30 gigabytes of storage space, a size not commercially viable for consumers at that time (Id., at 145).

However, thousands of songs could have been stored at that time in MIDI format (Id., at 146). For example, a performance of Beethoven's piano sonata "Für Elise" played for the court in PCM format was 74,000 bytes for 6.7 seconds, while three minutes of the same music in MIDI format was 6,600 bytes (Id., at 148-49). In Dr. Moorer's opinion, MIDI is digital music (Id., at 149), although "[i]n some ways, MIDI operates like the old player pianos, in that it is capable of recording the exact performance without having to record the sounds." (Docket #86 at 10). In fact, he would have chosen MIDI as the commercially viable format in 1988 for the invention disclosed in the patent (Docket #95 at 150).

Further, the CD format in 1988 included both "digitized audio" as well as "music encoded as MIDI data and graphical information as well." (Docket #86 at 3). "Therefore, as of 1988, the complete specification for CD-based audio was not merely sound waves in digital form, but also included instructions of various kinds, optionally including MIDI data." (Id., at 6).

All forms of digital music, MIDI or otherwise, go through a digital to analog converter and then to a speaker (Id., at 121). The audio format for a compact disk was first published in the early 1980's (Id., at 123). One form of representations on a CD is pulse code modulation or PCM (Id.). PCM audio on a compact disk is more than a sound wave converted to binary form (Id., at 124). There are correction codes and instructions which direct the decoding process (Id., at 124-25), as well as instructions which start and stop the individual tracks (Id., at 125). Some CDs in 1988 had MIDI information on them (Id., at 127).

There were forms of digital audio in 1988 other than PCM or MIDI (Id., at 128; Docket #86 at 5). All of these forms contain some kind of instructions or directions, such as commands to the decoding software and hardware concerning interpretation of the data (Docket #95 at 129). MP3 is another means of digital audio, and it also contains instructions (Id., at 130).

MIDI revolutionized music in the mid-80's, by allowing artists to play complex pieces without doing so all at one time (Id., at 132). MIDI does have limitations, such as the inability to

represent voices well (Id., at 136). MIDI, however, does not lack nuance (Id.).

All methods of producing sound digitally ultimately involve "numbers that describe how to make a sound pressure wave. In other words, they include instructions to a computer decoding device as to how to create a voltage that can then be sent to a loudspeaker or headphone." (Docket #86 at 12).

In Dr. Moorer's opinion, the inventor did not exclude MIDI from the definition of "digital audio music" (Id., at 113). Rather, Mr. Hair was referring to any means of using zeros and ones to encode musical sound (Id., at 138). The witness based his opinion on the fact that the patents do not use words "sound wave" or "sound pressure wave" at any point, and there is no limitation in the patent on the way the music is stored digitally (Id., at 139).

Also, the use of the term "laser retrieval" in the specification means any information which can be placed on CD (Id.). MIDI is not excluded by this language (Id., at 141).

"Software" as used in the patent means a way of representing digital music as opposed to being a physical device (Id., at 142). Thus, any method of creating music from zeros and ones appears acceptable under the patent (Docket #86 at 12).

3. CONSTRUCTION OF THE CLAIMS PRESENTED AT THE MARKMAN HEARING

The parties dispute the meaning of numerous terms, many of which are used throughout the three patents-in-suit. The court will

initially focus upon the four terms which the parties recognize as being at the center of the dispute in this matter.

A. "Digital Audio Signal"

This term appears in each of the patents, beginning with the '573 patent in Claim 1, which begins "A method for transmitting a desired *digital audio signal* stored on a first memory" (Docket #69, Exhibit J at 6) (italics added). Plaintiff maintains that this term should be construed to mean "a sound wave converted to binary form." (Docket #69 at 11). Defendants assert that the term's proper construction should be thus:

A representation of audio in binary form intended to produce an audible sound. It can be recorded sound, a sound effect, or instructions for producing a sound, and need not be a complete song.

(Docket #65 at 15). The essence of the dispute in this instance is whether or not the term "digital audio signal" includes MIDI instructions or computer software programs as opposed to simply digital representations of audible sounds.

MIDI is a means of creating musical sounds by instructing a computer to play a synthesizer to produce a specified tone. By contrast, Pulse Code Modulation, or PCM, is a means of converting a sound wave into binary form so that the same sound wave (or one so close to the original so as to be indistinguishable by the human ear) may be produced when the binary language is interpreted by a computer and sent through a digital/analog converter to a speaker.

Sightsound asserts that the phrase "digital audio music" does not include MIDI representations. Resort to contemporaneous dictionary definitions for those skilled in the art supports this conclusion. The IEEE⁶ Standard Dictionary of Electrical and Electronics Terms in 1988 defined "audio" in the context of data transmission as "pertaining to frequencies corresponding to a normally audible sound wave - roughly 15Hz-20Hz." (Docket #69, Exhibit A). "Digital" is defined as "pertaining to data in the form of digits." (*Id.*, Exhibit B). "Signal," again as employed in the context of data transmission, is "(a) a visual, audible or other indication used to convey information; (b) the intelligence, message or effect to be conveyed over a communication system; (c) a signal wave; the physical embodiment of a message." (*Id.*, Exhibit C).

Defendants argue that the phrase "sound wave," which is part of Sightsound's proposed definition of "digital audio signal," is nowhere to be found in the specification. While this is true, "sound wave" is part of the IEEE definition of "audio," and is a source to which one skilled in the art would refer in construing the claim terms. Indeed, Sightsound persuasively argues that, relying upon contemporaneous trade definitions, the term "digital audio signal" refers to "a normally audible sound wave" which has been represented as "data in the form of digits" for purposes of sending or conveying it.

6. The Institute of Electrical and Electronic Engineers, which is part of an American National Standard (ANSI).

Resort to the specification for purposes of determining if a different meaning was intended by the patentee does nothing to change the meaning of the phrase. The specification of all three patents provides several clues concerning the meaning of "digital audio signal." A review of the specification in some detail at this point will serve to provide needed background for this term, as well as for the other terms which remained to be construed.

First, in rather graceless language in common to the species, the specification contains a description of the field of the invention:

The present invention is related to a method for the electronic sales and distribution of digital audio or video signals, and more particularly, to a method which a user may purchase and receive digital audio or video signal from any location which the user has access to a telecommunication line.

(Docket #70, Tab 51, '573 Patent at col. 1, lines 9-14). What follows is a description of the then-existing "medium" or "hardware units" of music, which include records, tapes and compact discs (Id., lines 17-68). Throughout this discussion, the disadvantages inherent in the use of "hardware units" for storing, selling and playing back music are discussed. Then, the advent of digitizing sound is discussed:

QUALITY: Until the recent invention of Digital Audio Music, as used on Compact Discs, distortion free transfer from the hardware units to the stereo system was virtually impossible. Digital Audio Music is simply music converted into a very basic computer language known as binary. A series of commands known as zeros and ones encode the music for future playback. Use of laser retrieval of the binary commands results in distortion free transfer

of the music from the compact disc to the stereo system

(Id., lines 50-59). With respect to copyright protection of musical pieces, the specification indicates that, "[i]f music exists on hardware units, it can be copied." (Id., col. 2 lines 8-9).

Thus, the objectives of the invention are listed as providing a new "methodology/system" to: (1) "electronically sell and distribute Digital Electronic Music"; (2) "electronically storing and retrieving Digital Audio Music"; (3) electronically sorting, cuing and selecting Digital Audio Music; and (4) preventing "unauthorized electronic copying" of Digital Audio Music. (Id., lines 10-23).

The specification goes on to explain that Digital Audio Music, in the disclosed invention, is stored on only one piece of "hardware," that being a hard-disk (Id., lines 31-34). This eliminates the former types of "hardware" identified in the specification, namely "records, tapes, or compact discs." (Id., line 34). The reader is further informed that, "[i]nasmuch as Digital Audio Music is software an[d] this invention electronically transfers and stores such music, electronic sales and distribution of the music can take place via telephone lines onto a hard disk." (Id., lines 63-67). A more concise description of the invention is then provided:

The present invention is a method for transmitting a desired digital video or audio signal stored on a first memory of a first party to a second memory of a second party. The method comprises the steps of transferring money via a telecommunications line to the first party from the second party. Additionally, the method comprises

the step of then connecting electronically via a telecommunications line the first memory with the second memory such that the desired digital signal can pass therebetween. Next, there is the step of transmitting desired digital signal from the first memory with a transmitter in control and in possession of the first party to a receiver having the second memory at a location determined by the second party. The receiver is in possession and in control of the second party. There is also the step of then storing the digital signal in the second memory.

(Id., col. 3, lines 3-19). This description is repeated after the preferred embodiment is set forth (Id., col. 5 lines 29-45).

Again, it is helpful to focus the court's inquiry on the crux of the dispute between the parties. Defendants assert that any means of directing a computer to make sound through use of binary code is acceptable as a "digital audio signal" for purposes of the invention. This is so, defendants argue, because the specification identifies "digital audio music" as "music converted into a very basic computer language known as binary" and because the specification refers to Digital Audio Music as "software." (Docket #65 at 16). MIDI is a form of computer "software" in that it consists of instructions, stored in binary form, which will produce sound when interpreted by the computer. "Instructions" to produce sound are, in defendants' view, part of the claimed invention.

Sightsound responds that software programs, such as MIDI, are not properly within the scope of the term "digital audio signal." The manner in which the terms "hardware" and "software" are used in the specification are, Sightsound argues, the most important indicia of the meaning of those terms. The specification consistently refers to any physical storage medium for sound,

whether in binary form or not, as "hardware." Such storage units including records, tapes, compact discs and even the hard drive of a computer. The specification explains that the key advantage to storing music as digital signals is that the digital signal is "software," i.e., it can be transferred to a purchaser without also transferring along with the signal some type of "hardware" unit on which the signal is stored.

There are repeated references in the specification to "music" and "songs." Likewise, the patentee refers to storing music on other media, such as records and tapes, which do not normally contain computer instructions. These references from the specification lead the court to conclude that Sightsound's definition is the preferred one in this case, and that "digital audio signal" does not include all types of computer software or, more specifically, MIDI.⁷ Rather, it includes only digital representations of sound waves.

The court understands that, in order to play these digital representations of sound waves, a computer must have instructions for converting the binary into analog form. Hence, as Dr. Moorer pointed out, compact discs include, along with a digital representation of sound waves, instructions concerning how those digital representations are to be interpreted. This, however, does

7. This conclusion has been reached without reference to extrinsic evidence, with the exception of dictionary references. Further, evidence presented by defendants addressed to the ability of the technology available to the normal consumer in 1988 to handle the transfer of PCM songs is not, at this stage, relevant.

not alter the nature of what is being represented: a recorded sound as opposed to an instruction to a computer to play an instrument which, in turn, will produce a sound.

The specification does not, therefore, support the construction proffered by defendants that "digital audio signal" includes "software programs." The specification does not refer to such programs, and clearly uses "software" in a sense different from what is commonly understood when used to refer to "software programs."⁸ Further, the specification focuses upon the common practice of selling musical recordings, and does not mention storing or transferring instructions for playing music.

B. "First Party/Second Party"

Again, these are terms utilized throughout the patents-in-suit referring to the two entities which interact during the transfer of the digital signal, e.g., a "method for transmitting a desired digital audio signal stored on a first memory of a first party to a second memory of a second party" (Docket #69, Exhibit J at 6). Plaintiff asserts that the term "party" should be construed as meaning "an entity and/or its agent." Defendants

8. This ruling does not require resort to extrinsic evidence. If it did, however, the undersigned would find persuasive the testimony of the inventor, Arthur Hair, that MIDI is "a set of instructions" while "digital music is music that is embodied in a digital signal . . . one is a set of instructions and the other is music digitized." (Docket #74, Exhibit A, Tab 2, Hair Deposition at 169:4-10). This is consistent with Dr. Tygar's and Dr. Moorer's testimony, that MIDI, while a means of creating music, is not a representation of a sound wave.

respond that the meaning, each time that the terms are used, should be "a single financially distinct entity at locations separate and distinct from each other."

Sightsound does not contest that, in the context of the claims at issue in this case, the "first party" and "second party" are financially distinct from one another, or that various claims require that the transaction occur when certain items or entities are at distinct locations (Docket #96 at 8). However, Sightsound takes the position that "financially distinct" and "at separate locations" are limitations imposed, where appropriate, in particular claims, and that there is no need to impose them on the definition of the terms "first party/second party" each and every time that those terms are used.

In claim 1 of the '573 patent, the reader is informed that during the transferring money step the "first party" is "at a location remote from the second memory," and that the "second party" is "financially distinct from the first party." (Docket #70, Tab 51). This claim also contains the limitation that the second party is in the position of "controlling use and in possession of the second memory" (Id.). Later in this report, the "control and possession" question is addressed. It is enough to say, however, that the combination of the first party being at a location remote from the second memory, and the second party being in possession and control of the second memory, all but ensures that the first and second party will be at distinct locations. The remaining two

claims in suit from the '573 patent, claims 2 and 3, are dependent claims which also have these limitations.

The '734 patent includes in each of the asserted claims the requirement that the memory of the first party and that of the second party be "remote" from one another (Docket #71, Tab 35, '734 Patent Claims 1, 4, 11, 26)⁹. Hence, the issue of whether the parties are at separate locations is not specifically addressed, although the use of memories at distinct locations would generally describe situations where the parties are with their respective memories. Further, as Sightsound suggests, the claims also include at least one step which requires that money or a fee be charged (Claims 1, 26), or that the digital audio signal is "sold" to the second party (Claim 4), or that there must be a means for "transferring money" between the first and second memories (Claim 11). None of these transactions makes sense unless they occur between parties which are "financially distinct."

Finally, the '440 patent also contains language indicating distinct locations for the first and second party memories (Docket #69, Exhibit K, Claims 2, 12, 22, 36, 41), as well as "charging a fee" or other indicia that the parties are, necessarily, financially distinct (Id., Claims 1, 12, 22, 36, 41).

Therefore, in virtually all of the claims asserted in this case, the "first party" and the second memory, or the first memory

9. Again, the remaining claims are dependent claims which incorporate these same limitations.

and second memory, must be remote from one another.¹⁰ The context of those claims further requires that the parties be financially distinct in order for their actions to read on the patent. This distinction, however, is not a matter of construction of the terms "first party/second party," but of the language of each particular claim in which those terms are used. In other words, the location and financial distinctions arise, if at all, from other language in the claims, and not from the use of the terms "first party" or "second party." The terms will not be construed to include any location or financial distinctions apart from those imparted in the language of particular claims.¹¹

10. The two claims which do not contain such language are Claims 1 and 11 of the '440 patent, although each claim states that the connection between the first and second party memories is to be made through telecommunications lines. It may be possible, therefore, for these claims to apply to a situation where two financially distinct entities have their equipment at the same location, e.g., in the same room, even though the connection between them occurs over telecommunications lines. The court, however, again sees no basis for including within the term "party" the requirement that the parties be at distinct locations. Any further analysis of these claims must await issues which lie beyond claim construction.
11. The court's finding that "financially distinct" is a concept incorporated into each claim-in-suit by the use of the concept of a sale taking place makes it unnecessary for the court to address defendants' argument that the patentee bound himself to "financially distinct" parties through an amendment process before the PTO (See Docket #75 at 7). Since the asserted limitation appears to be contained in each claim asserted by Sightsound, and since Sightsound does not contest that the first party and second party must be financially distinct from one another, there is no need to determine whether the claims must be construed in light of subject matter allegedly abandoned during prosecution of the patents.

There is a further dispute, however, concerning the term "party," and it has to do with Sightsound's insistence that the term includes an entity or an entities' agent. Defendants assert that there is no indication in the patents or the specifications that an "agent" may act on behalf of either the first party or the second party. Defendants also argue that permitting the use of the term "agent" would create a situation where infringement may occur in one state, but not in another, because of differences in the laws of agency from state to state.

Sightsound responds that the term "agent," offered as part of the definition of "party," simply means "someone who stands in the shoes of the first party," and that there is no intent to imply any particular legal relationship (Docket #96 at 9).

In the court's view, the use of the term "party" is clearly meant to include any legally distinct entity which performs the activities described. For example, a corporation could clearly be either the "first party" or the "second party" for purposes of the claims in suit. A corporation acts only through its employees or "agents". Likewise, a person may also act on behalf of another. The court agrees with plaintiff that there is no language in the claims which suggests that "first party" and "second party" must act for themselves in performing the tasks set forth in the claims. Likewise, nothing in the specification indicates that the patentee was restricting himself in such fashion.

On the other hand, defendants are correct that the term "agent" may add ambiguity to a term which is not ambiguous. There

is no need to add such a term to make the meaning of the claims plain.

Reading the claims-in-suit, the court has no difficulty construing the term "party." A party is an entity, whether a corporation or real person, possessing and/or controlling the stated structure, or performing the necessary steps for the claims. One skilled in the art would understand that a party can act through another. Thus, although the term "agent" will not be added to the term party, the term will not be construed so as to require that a party act on its own behalf for purposes of the claims in suit, i.e., a party may, as in all other matters, act through others it authorizes to do so for purposes of the claims in suit.

C. "Control" and "Possession" and related phrases.

"Control," in plaintiff's view, is "the authority to guide or manage." "Possession" is "to have and to hold as property." Plaintiff maintains that these terms should be accorded these meanings wherever used, including when they are used in combination or separately.

Defendants, on the other hand, seek to have each of the following phrases construed as meaning the same thing: "controlling use and possession," "in control and possession," "in possession and control," "controlling," and "controlling use." These must each be construed, in defendants' view, to mean "in physical control and ownership." Therefore, there are two disputes here which are

interwoven. The court must determine what the terms mean and whether they are being used interchangeably.

Initially, it must be noted that both Sightsound and CDnow offer definitions for each term. "Control" in defendants' view is "physical control" while "possession" is "ownership." These terms may be measured against Sightsound's proposed definitions, and then the question whether they are being used interchangeably in the patent may be addressed.

A useful starting point for construing these terms is Claim 1 of the '573 patent:

1. A method of transmitting a desired digital audio signal stored on a first memory of a first party to a second memory of a second party comprising the steps of:

transferring money electronically via a telecommunications lien [sic] to the first party at a location remote from the second memory and controlling use of the first memory from the second party financially distinct from the first party, said second party controlling use and in possession of the second memory;

connecting electronically via a telecommunications line in the first memory with the second memory such that the desired digital audio signal can pass therebetween;

transmitting the desired digital audio signal from the first memory with a transmitter in control and possession of the first party to a receiver having the second memory at a location determined by the second party, said receiver in possession and control of the second party; and

storing the digital audio signal in the second memory.

(Docket #69, Tab J, Claim 1) (emphasis added).

The dictionary defines "control" as meaning "exercise authority or influence over: direct" (Docket #69, Exhibit E, The 1995 Webster's II New College Dictionary). "Possess" is defined as "to hold as property or occupy in person; have as something that belongs to one; own" (Webster's New World Dictionary, Third College Edition, 1988). "Possession" is defined as "a possessing or being possessed, as by ownership or occupancy; hold" (*Id.*). That these dictionary definitions offer slight but important variations of the meaning for the term "possess," only comports, in the court's view, with the common understanding of this prosaic term. One can "possess" one's house as a renter, with a possessory interest assertable against the whole world except, under some circumstances, against the owner, who also enjoys a possessory interest. "Possession" thus does not mean "ownership"; it means "holding as property."

The dispute with respect to "control," however, is whether or not the patents require that physical control be exercised over a particular object, or if the authority to direct the use of the object is sufficient. A review of the claims in suit does not reveal any support for defendants' assertion that physical control over any particular object is required as opposed to the authority to direct the use of that object. Therefore, physical control is not a requirement where the term "control," or any derivation thereof, is used in the claims-in-suit.¹²

12. Defendants also make the argument that referring to the "plain meaning" of the terms used would end in an absurd result (which, in any event, defendants profess would be acceptable to

The issue of the interchangeability of the terms is largely disposed of by recognition that the terms do have generally accepted meanings which are distinct. Thus, in Claim 1 of '573 patent, the first party has "controlling use" of the first memory, while the terms possession and control are used together with respect to the first party vis-a-vis a transmitter, and the second party vis-a-vis both the second memory and a receiver. The claim clearly makes a distinction, with respect to possession, between the first party's memory and the first party's transmitter.

Indeed, being in control of a thing, however, is not the same as being in possession of that same thing. The language of the '573 patent does not indicate to the court, nor would it to one skilled in the art, that the party is "in physical control and ownership" when the party is merely "controlling use" of the first memory.

In the court's view, the fact that the terms control and possession have common meanings which are not identical, and that

them). Specifically, defendants allude to the third paragraph of Claim 1 of the '573 patent, where the receiver "is in possession and control of the second party." A "plain reading" of this language, in defendants' view, would require the receiver to possess and control the second party, rather than the other way around (Docket #65 at 21-22). The court disagrees. At most, defendants have pointed out the infelicitous placement of a verb. This does not, however, establish that the meaning of the terms in issue are ambiguous. Rather, a reader of normal skill in the art, and with a normal understanding of the English language, will not be confused by the claims which place (or misplace) the terms "possession" and "control." In fact, it does not take one skilled in any art, past a common understanding of English, to understand that "a transmitter in control and possession of the first party" means that the first party controls and possesses the transmitter.

they are not used jointly in all of the relevant patent claims, is strong evidence that each term is intended to convey its own meaning. Also, the dispute is limited in this case to several instances where the first party is asserted to be either "controlling" or "controlling use" of the first memory"¹³

In Claim 4 of the '734 patent, by contrast, the phrase "possession and control" is used only once, and that is in reference to the second party possessing and controlling the second memory (Docket #66, Exhibit 2 at Claim 4, column 10, lines 3-5). Claim 11, by contrast, places the first memory "in possession and control of the first party," and the second memory "in possession and control of the second party." (Id., Column 10, lines 54-56).

Defendants point to the '734 patent specification where it is stated that "the receiver is in possession and control of the second party. The receiver is placed by the second party at a second party location determined by the second party." (Docket #66, Exhibit 2, '734 Patent at 5:56-59). Defendants argue that this, too, evidences that control and possession are required when either term is used in a claim. However, defendants fail to note that

13. Defendants also assert that the term "controlling" is used individually with respect to the second party controlling the second memory in Claim 3 of the '573 patent (Docket #65, Appendix B at 3. However, that claim is a dependent claim, which includes the limitation from Claim 1 that "said second party controlling use and in possession of the second memory." (Emphasis supplied). Thus, Claim 3, by definition, includes the restriction that the second party controls the use and possesses the second memory. This is, therefore, a non-issue with respect to Claim 3 of the '573 patent.

this language is used in describing the preferred embodiment of the invention. Indeed, the first portion of the first sentence cited by defendants reads in relevant part "preferably having the second memory while the receiver is in possession and control of the second party." (Id., 5:54-55). Further, the cited portion of the specification is addressed to the second party and the second memory. As noted above, the only disputed use of "control" are with reference to the first party and the first memory. Thus, this is not persuasive evidence supporting defendants' argument.

Further, to the extent that any ambiguity might exist, resort to the prosecution history establishes that the examiner, a person skilled in the art, understood "control" to mean "authority to guide or manage." (Docket #70, '573 File History, Tab 13 at 3). This was expressed in the course of explaining the term "control" in light of prior art, the Lightner patent. Likewise, the term "possession" was explained by the applicant in 1991, in the course of distinguishing the patent from the Hughes patent:

[The] Hughes' receiver, although located in the user's home is taught to be owned by the owner of the transmitter and is thus 'in possession' of the owner.

(Id., Tab 34 at 9). Thus, the prosecution history also informs the court that control and possession are separate terms, that possession has an element of holding as property attached to it, and that physical control is not necessary.

The court therefore agrees that the terms control and possession have the meanings of "authority to direct" and "holding

as property," respectively. Further, the court finds that the terms are not used interchangeably in the claims in suit.

D. "First Memory (or hard disk)/Second Memory (or hard disk)"

Defendants assert that, each time the terms "first memory" and "second memory" are used (and they are used throughout the three patents-in-suit) they should be read as being in the "possession and control" of the respective parties. Sightsound responds, much as it did with respect to the location dispute concerning the terms "first party/second party," that "control" and "possession" of the first and second memories are expressly stated in those claims which possess those limitations.

In support of their position, defendants argue that the specification of the patents recites explicitly that the first memory is in the first party's control and possession, and that the "receiver" is in the second party's possession (Docket #70, Tab 51, '573 Patent at col. 3, lines 10-18). The terms "possession" and "control" are used throughout the patents, and the court finds that they are used where and when the patentee intended. In any event, reading them into the patent claims every time the first memory or second memory are mentioned would be an improper reading into the claims of a limitation set forth in the specification. Intervet Am., Inc. v. Kee-Vet, Inc., 887 F.2d 1050, 1053 (Fed.Cir. 1989).

Defendants also assert that, with respect to the '573 patent, the inventor overcame a prior art rejection by asserting that the "second party" has "control of the second memory throughout

the transaction." (Id., Tab 16, at 5-7). Accepting this argument on its face, it proves too little. Claim 1 of the '573 patent explicitly requires (and this requirement carries through to dependent claims 2 and 3) that the second memory is in the second party's possession and control. The reference to the prosecution history made by defendants does not address the possession and control of the first memory by the first party.

The court would be rewriting the claims asserted to read "first memory" and "second memory" to include the restriction that they each be possessed and controlled by the respective parties. Such a reading would, moreover, contradict the express terms of the claims. "In construing claims, the analytical focus must begin and remain centered on the language of the claims themselves, for it is that language that the patentee chose to use to 'particularly point[] out and distinctly claim[] the subject matter which the patentee regards as his invention.' 35 U.S.C. §112, ¶2." Interactive Gift, 231 F.3d at 865. The terms "first memory" and "second memory" will not be construed to include the terms "in the control and possession" of the respective parties unless such language expressly appears in the claim.

E. "Transferring money electronically," "Charging a fee," "providing a credit card number . . . so the second party is charged money," "Selling electronically," "Electronic sales," and "Electronically Selling."

Sightsound asserts that the term "transferring money electronically" should be construed to mean "providing payment electronically." Defendants assert that "transferring money electronically and "charging a fee" should be construed to mean the same thing: "providing an authorization over telecommunications lines which allows the first party access to funds." Put more directly, Sightsound asserts that the claim language permits any type of payment which is accomplished electronically. Defendants assert that the only type of payment arrangements covered by the claim language would be provision of authorization by the buyer, as in providing a credit card number, which permits the seller access to funds.

The '573 patent recites in claim 1 the step of "transferring money electronically via a telecommunications [line]." (Docket #70, Tab 51, Column 6 lines 8-9). Then, in claim 3 (a dependent claim) an additional limitation is recited "wherein the transferring step includes the steps of telephoning the first party . . . by the second party; providing a credit card number of the second party . . . to the first party so the second party is charged money." (Id., lines 29-36).¹⁴ The specification states that this is

14. Defendants' voice a concern that, if Sightsound's definition is accepted, Sightsound may later choose to argue that "payment" would exclude providing authorization for payment, as by providing a credit card number. The court cannot agree. The provision of authorization for use of a credit card is expressly claimed in claim 3 of the '573 patent. Further, while this express language is not used in Claims 11-14 of the '734 (the other instance where "transferring money electronically" appears) Mr. Hair's declaration in the prosecution history of the '573 and '734 patents clearly binds Sightsound to include situations where authorization to charge

"a method for the electronic sales and distribution of digital video and audio signals, and more particularly, to a method by which a user may purchase and receive digital audio or video signal from any location which the user has access to a telecommunication line." (Id., Column 1, lines 9-14).

Defendants assert that missing from the specification is any mention of the word "payment" in relation to the term "transferring money electronically." (Docket #65 at 25). While this is true, the concept of the second party purchasing, i.e., making a payment for and receiving, the "desired digital signals" is manifest. Defendants also argue, however, that the inventor noted during the prosecution history of both the '573 and '734 patents that "[o]ne skilled in the art would know that an electronic sale inherently assumes a transferring of money by providing an account number or a credit card or a debit card number (since that is the only way for electronic sales to occur) coupled with a transferring of a service or product." (Docket #70, Tab 37, at 2; Docket #71, Tab 10, at 2).

In the court's view, there is no need to resort to the prosecution history. The fact that the '573 patent employs "transferring money electronically" as a general term, and includes within that term the concept of providing a credit card number and authorization, establishes clearly that the methods of providing payment electronically over a telecommunications line include but

a credit card is provided over telecommunications lines.

are not limited to providing authorization to charge a credit card account. If this had been intended, there would have been no reason to use a more general term and then include provision of a credit card account number within that concept.

Also, at issue is the phrase "charging a fee via telecommunications lines," which is language used in claims 2, 36 and 37 of the '440 patent. The context of this claim language also does not limit itself to any specific manner of accomplishing the end result, which is to ensure payment for the services provided through information provided over a telecommunications line.

A related phrase, "providing a credit card number . . . so the second party is charged money" is also disputed by the parties. Defendants assert that this must be accomplished over the telephone, verbally, between two persons, one at each location (Docket #65, Appendix A at 4). Sightsound objects to the inclusion of the "person to person" limitation, and to the verbal exchange requirement (Docket #74 at 24). Indeed, the court can find no support in the plain language of the claims, or the specification, for the requirement that the information be exchanged in a person-to-person call.

Providing authorization to access a credit card account is one means of "transferring money electronically." There is no evidence that the inventor ceded coverage of any other means of making payment for the desired digital signals so long as it is done "over telecommunications lines." In the court's view, "transferring money electronically" is a sufficiently descriptive phrase that no

further description than that set forth above is necessary for its construction.

Related to this discussion is the dispute concerning the terms "selling electronically," "electronic sales," and "electronically selling." Sightsound contends that each of these three terms should be interpreted as meaning "providing a product or service electronically in exchange for payment provided electronically." Defendants agree that these terms each mean the same thing, but would have them be construed to mean "a transaction including authorization over telecommunications lines which allows the first party access to funds, and the providing of a service or product." Defendants present the same argument as they did for the phrase "transferring money electronically." Again, the court is not persuaded.

Defendants further assert that "electronic sales" may include situations where the product is not provided electronically. Sightsound disagrees, and argues that, in the context of these patents, the service must also be provided electronically.

The claims which use these terms all appear in the '734 patent and the later '440 patent. An illustrative example of the use of the language within a claim is claim 4 of the '734 patent wherein a system is described which includes a "means for electronically selling" digital signals, and "electronic sales" of the signals which involve those signals being "electronically transferred" to the second party (Docket #66, Exhibit 2, Column 9 at lines 51-53, 65-67; Column 10, lines 1-6). Thus, the requirement

that the sale include both payment and electronic transfer of the digital signal is express in claim 4 of the '734 patent. Further, the '734 specification begins by describing "[a] method for transferring desired digital . . . signals." (Docket #66, Exhibit 2, Abstract). It sets forth the "forming a connection" requirement, and then describes "the step of selling electronically by the first party to the second party through telecommunications lines, the desired . . . signals . . ." followed by transferring the signals. (Id.) (emphasis added). Also, in support of the '734 patent, Mr. Hair made the following representation:

The terms "electronically sell", "electronic sales" and "electronically sold" are used throughout the specification of the above-identified patent application.

One skilled in the art would know that an electronic sale inherently assumes a transferring of money by providing an account number of a credit card or debit card number which then allows for access to or transferring of a service or product through telecommunications lines."

(Docket #71, Tab 10 at 2) (emphasis supplied).

The language used in the patents, the specification, and the prosecution history each and all indicate that the concept of "electronic sales" or "selling electronically" involves transactions in which both the payment and the provision of services is accomplished "electronically" via "telecommunications lines." Therefore, this is an additional limitation on the claims which include those terms.

F. Terms which include "Telecommunications Line(s)"

Sightsound asserts that the term "telecommunications line," which is used throughout the claims in suit, should be interpreted in all instances to mean "a medium for the transmission of information from one location to another." Defendants respond that this could refer to, among other things, the Pony Express.

Defendants, on the other hand, wish to focus the inquiry upon the use of the term "connecting" in relation to "telecommunications lines," as in the following examples from the various patent claims: "connecting electronically via a telecommunications line," "forming a connection through telecommunications lines," "telecommunications lines connected," "connecting electronically via the telecommunications lines," and "connecting electronically via telecommunications lines." Defendants assert that each of these formulations of the terms "connection" and "telecommunications lines" entails the following construction:

Establishing a continuous point-to-point conduction path using a telephone service providers' circuit-switched network for the transfer of information. These terms do not include a packet-switched network link, such as a TCP/IP link.

The TCP/IP reference is, of course, addressed to the Internet. Defendants take the position that the use of the terms "connect[ion]" and "telecommunications line(s)" bespeak the use of telephone lines and telephone switching services only. A connection over the Internet (which would, in most cases, involve at least some use of telephone lines and the telephone switching system), would not be covered.

The expert testimony in this case was most helpful in describing the distinction between the telephone system and a TCP/IP system such as the Internet. What becomes clear from a review of the testimony and the sources relied upon by the experts, however, is that the distinction which defendants wish to make is not drawn from the claim language, or from the specification.

It is helpful, first, to note that both sides agree that a modem-to-modem connection between two computers over telephone lines would clearly be covered by the claim language. Defendants, however, wish to differentiate from this the process by which an Internet transfer occurs. A common form of such a transaction, and one which was known in 1988, would involve the second party (or buyer) connecting to an internet service provider (ISP) through a modem and over a telephone line. The next part of the process occurs between "nodes" on the packet-switch network (the Internet), until the transmission, in the form of information "packets," reaches another ISP connected to the first party (the seller) by telephone lines. Thus, in each instance, the transmission is ultimately accomplished, at each end, by a traditional telephone communication over telephone lines and through a telephone switching system.

The difference between the two methods of exchanging data occurs in the manner in which the information is sent between the nodes of the packet-switch system, and the manner in which data is sent through a telephone company switching system. However, while a transfer over the Internet differs in some respects from a

transfer made directly between two computers over modems and through telephone lines, there is simply no way of reading the plain language of the claims in suit explicitly or implicitly to exclude any means of transferring information so long as it can occur over telecommunications lines.

Defendants, for example, rely upon Figure 1 from the specification of each patent which shows the respective equipment of the first party and second party connected to a "box" entitled "Telephone Lines 30." Even if the use of the phrase "telephone lines" limited the invention, it is not clear that it would do so to omit the Internet, which is normally connected to individual users by telephone lines in any event. Also, Figure 1 is a representation of the preferred embodiment only. It is improper to read into the patent claims limitations from the specification. Comark Communications, 156 F.3d at 1186 ("fine line" exists between "reading a claim in light of the specification" and impermissible practice of "reading a limitation into the claim from the specification.").

Likewise, defendants' asserted definition of the term "connection" to differentiate telephone communications and an Internet session is not persuasive. Dr. Larky explained in detail how a telephone communication establishes a "continuous point-to-point conduction path," regardless of the use of time division multiplexing (TDM), which results in several different telephone connections sharing the same line. This is so, in his view, because TDM still results in the telephone user having the right to a

specific and consistent pathway through which his or her entire conversation is put through to the other party. Resort to the claims and the specification, however, does not yield any basis for making a distinction between the "connection" made in an Internet session, which produces "end-to-end" connectivity, but not a continuous conduction path, and a telephone connection which produces both end-to-end connectivity and a continuous conduction path.

Defendants resort to the prosecution history and note that the term "telecommunications lines" did not become part of the patent until 1992. The manner in which this was accomplished, in defendants' view, should inform the court's interpretation of that term. The original specification and claims disclosed "electronically transferred via telephone lines" (Docket #70, Tab 4 at 6). This was altered in December, 1988, to "connecting electronically the first memory with the second memory" (*Id.*, Tab 7 at 1). In December, 1991, the first use of the term "telecommunications link" is proposed, and rejected by the examiner as not being well-connected in the system (*Id.*, Tabs 34 and 35). Ultimately, in June, 1992, the term "telecommunications line" was added throughout the claims (*Id.*, Tab 36).

First, defendants assert that, if the term "telecommunications line" is read to reach anything more than a "continuous telephone-circuit network path" this would violate the "written description requirement" which requires a patentee in the initial disclosure to provide an adequate description of what is

being patented. See, Purdue Pharma L.P. v. Faulding Inc., 230 F.3d 1320 (Fed.Cir. 2000). This, however, is a validity issue which the court should not reach at this point. And, in any event, the use of the term "telephone lines" in the initial disclosure does not, in light of the fact that the Internet is normally accessed through telephone lines on each end of a transaction between parties, provide support for limiting the definition of "telecommunications lines" to exclude Internet transactions.¹⁵

Defendants also seek to limit the reach of the term "telecommunications line" in light of the changes made during the prosecution of the patents from "link" to "line," a small portion of which the court has already described above. A more complete description of the prosecution history is now necessary.

The original term in the application for the '573 patent was "telephone line." Then, in December, 1988, the term "electronically connecting" was proffered and rejected. This rejection was premised upon the Lightner patent (Docket #70, Tab 11). The next attempt was simply to recite "connecting" the first and second memories, but this was also rejected over Lightner and the Hughes patent (Id., Tabs 12 and 13). "Connecting electronically" was added (Id., Tab 16), but again a rejection over

15. Defendants also assert that "telecommunications lines" is "new matter" which was improperly added to the patent in the years following the initial application. Again, however, defendants seek to introduce a matter normally addressed during the validity stage into the construction phase, and, in any event, it does not serve to raise the distinction which defendants desire.

Hughes resulted because "Hughes . . . shows that the first and second memory are connected electronically . . . such that information can pass therethrough." (Id., tab 30). Claim 11 was amended to state "connecting electronically via a telecommunications link" (Id., Tab 34). The examiner found the term "telecommunications link" to be "not well connected in the system" (Id., Tab 35 at 6). This resulted in the inclusion of the term "telecommunications line" in the next amendment, which was approved (Id., Tab 38 at 6).

Defendants assert that, in view of the prior art, "link" is a broad term, and "line" is a narrower term. Specifically, defendants point to the Hughes patent which discloses "transmitting and recording stations" which are "linked by telephone lines or other signal transmission means" (Defendants' Exhibit 4 at Column 8, lines 39-42). Lightner disclosed a "signal transmission link" with examples thereof including telephone lines, a microwave transmission link and CATV cable (Defendants' Exhibit 8, Column 15, line 47; Column 14, lines 53-55; Figures 10 and 12). Lockwood discloses "any suitable remote links . . . such as phone line data communication links" and an indirect link "via a computerized telecommunication network service such as TELENET." (Defendants' Exhibit 7, Column 4, lines 1-16). TELENET is described in Newton's Telecomm Dictionary, 7th Ed., p. 686, as a "private, commercially available network

providing both packet-switched and circuit-switched service to subscribers in North America, Europe and some parts of Asia."¹⁶

Thus, defendants argue that anything defined in the prior art as a "link" was given up when the Mr. Hair amended his claim from "telecommunications link" to "telecommunications line." This, in defendants' view, includes claiming a packet-switched network, such as that offered by TELENET.

A patentee may limit the definition of a claim term through "altering claim language to escape an examiner rejection" or by "clearly disavowing claim coverage." York Products, Inc. v. Central Tractor Farm & Family Center, 99 F.3d at 1575. Here, in offering the amendment, the patentee gave the following explanation:

The Examiner has also stated that "telecommunication link" is not well connected in the system. Accordingly, "link" has been amended to the more familiar term "line" and "via telephone line" has been added to the connecting step in Claims 11 and 15.

(Docket #70, Tab 38 at 15).

Here, the examiner did not reject the term "link" on the basis that it was taught by the prior art. Rather, the examiner indicated that a term more closely connected with the disclosed invention was required. Thus, the applicant indicated during the amendment not that he was giving up coverage, but that he was amending to include a "more familiar term" in the patent. Hence, this is not a situation where coverage was expressly conceded, nor

16. Defendants also point to Freeny (Defendants Exhibit 5) and Elkins (Defendants' Exhibit 6) as examples of prior art which use the term "communications link" as a broad term.

would a person skilled in the art believe that any specific coverage had been conceded through this amendment. In fact, neither the examiner nor the patentee ever indicated that there was any difference beyond familiarity between the terms "link" and "line."

Once again, this review of the prosecution history was an attempt by defendants to establish that Sightsound cannot claim coverage of package-switch networks such as the Internet. The court is not convinced that this is so. Thus, the terms "telecommunications line," even when used in the context of "connecting," should not be interpreted as excluding the Internet.

Further, with respect to Sightsound's construction, it is true that "a medium for the transmission of information from one location to another" is much too broad in the context of these patents. This does not mean, however, that Sightsound is attempting to claim coverage of the Pony Express or notes sent by carrier pigeon. Reading the term in context, "telecommunications lines" is used most often in conjunction with the terms "connecting" and "electronically." Where this is done, the coverage claimed is both narrow and clear. Sightsound is claiming an electronic medium of communicating between computers, which requires end-to-end connectivity. The court has not located any language in the patents which would permit any other reading, in context, of the term "telecommunication line(s)".

G. "Sales random access memory chip," "Incoming Random Access Memory Chip," and "Playback Random Access Memory Chip"

Sightsound sees no reason to further define these terms. Defendants assert that "sales random access memory chip," and "sales random access memory," should be interpreted as "a semiconductor storage element within the first memory at the first party location." "Incoming playback memory chip" should be "a semiconductor storage element within the second memory at the second party location," and "playback random access memory chip" should be "a semiconductor storage element within the second memory at the second party location that is separate and distinct from the incoming random access memory chip."

These terms appear in the '734 and '440 patents. Claim 1 of the '734 patent discloses a "first memory" which has a "hard disk having a plurality of digital . . . signals . . . and a sales random access memory chip which temporarily stores a replica of the . . . desired . . . signals" (Docket #69, Exhibit I, Column 8, lines 42-50). Claim 3, which builds upon claims 1 and 2, then discloses that "the second memory includes an incoming random access memory chip which temporarily stores the coded desired . . . signals . . . and a playback random access memory chip for temporarily storing the . . . signals . . . for sequential playback." (*Id.*, Column 9, lines 17-26). Other claims are similar, except that the term "chip" is not included in all iterations.

The specification of the '734 patent also provides a detailed description of the preferred embodiment:

In FIG. 1 and FIG. 2, the following components are already commercially available: the agent's Hard Disk 10, the Telephone Lines 30, the Compact Disc Player 40, the user's Hard Disk 60, the Video Display Unit 70, and the Stereo Speakers 80. The Control Units 20 and 50, however, would be designed specifically to meet the teachings of this invention. The design of the control units would incorporate the following functional features:

* * *

- 3) the Sales Random Access Memory Chip 20c would be designed to temporarily store user purchased Digital Audio Music for subsequent electronic transfer via telephone lines to user's Control Unit 50.
- 4) the Incoming Random Access Memory Chip 50c would be designed to temporarily store Digital Audio Music for subsequent electronic storage to the user's Hard Disk 60.
- 5) the Play Back Random Access Memory Chip 50d would be designed to temporarily store Digital Audio Music for sequential playback.

The foregoing description of the Control Units 20 and 50 is intended as an example only and thereby is not restrictive with respect to the exact number of components and/or its actual design.

(Id., Column 4, lines 32-65).

The focus of the dispute in this case is whether the claims may be read to include configurations where the RAM of a computer is used interchangeably as the "Sales Random Access Memory" and for other functions as part of the first party's control unit, and as the "Incoming Random Access Memory" and "Playback Random Access Memory" as well as other functions in the second party's control unit. Defendants would read each of these phrases as

requiring a separate storage element in the respective computers, apparently without the ability to be used for other purposes for which RAM is typically used on personal computers.

Reading the language of the claims in light of the specification, and particularly the language following the description of the preferred embodiment regarding the intended breadth with respect to the number of components and design of the control units, there is no indication that the inventor limited himself to situations in which particular RAM chips are designated for a specific purpose only. In the court's view, the language cited covers any RAM in a system which is configured to perform the function described, whether or not that is the only function it is configured to perform.

H. "before the forming step . . . commanding the second integrated circuit . . . to initiate the purchase"

This language appears in claims 2 and 3 of the '734 patent and claim 8 of the '440 patent. The parties agree that the language imposes an order with respect to the timing of the claimed steps. Defendants maintain, however, that the language requires that the second part "formulate" the request, and that the second party personally performs the "commanding" step. Sightsound sees no reason to include a "formulating" step when "commanding" is all which is disclosed, and disputes defendants' analysis that an "automated" form of commanding would be outside the scope of the claim language.

The language, in context, reads as follows:

2. A method as described in claim 1 wherein there is a second party integrated circuit which controls and executes commands of the second party, and a second party control panel connected to the second party integrated circuit, and before the forming step, there is a step of commanding the second party integrated circuit with the second party control panel to initiate the purchase of the desired digital video of digital audio signals from the first party hard disk.

(Docket #69, Exhibit 1, Column 9, lines 9-16). Claim 8 of the '440 patent reads virtually the same (Id., Exhibit K, Column 9, lines 33-41).

While it is clear that the "command" must originate from the second party, there is no indication that this must be accomplished by the second party physically entering a command at any specific time. The claim requires that, before the forming step, the integrated circuit be commanded to initiate the purchase. This command clearly must originate with the second party, but there is no limitation on how the second party can accomplish this. Thus, the limitation that the command be "performed personally" by the second party does not arise from plain language of the claims and, hence, is inappropriate.

The court also sees no basis to change the term "command" to "formulates a request." One skilled in the art would clearly understand the means by which an integrated circuit may be commanded to perform a function. Therefore, the court finds that this language does not impose a limitation requiring that a request be "formulated," or that the command be personally entered by the second party.

I. "Control integrated circuit"

This term appears in several claims in the '734 and '440 patents. Defendants assert that it should be defined as "a microelectronics device with at least 1 transistor." Sightsound does not contest that this is an accurate description of a control integrated circuit, but notes that this is an incomplete definition, as it potentially includes devices, such as an Operational Amplifier (Docket #74, Exhibit B, Tab 3 at 340), which would fit this definition but would make the claimed invention inoperable. Defendants respond that the "control integrated circuits" of the claimed inventions "perform too many functions to be defined with any more specificity." The court, however, sees no need to define them any more specifically than the plain language of the patents suggest: a microelectronics device which is capable of performing the functions identified in the patents.

J. "Regulate the transfer"

This language appears in claim 7 of the '734 patent in describing the role of the integrated circuits with respect to the transfer of signals: "said second party control integrated circuit and said first party control integrated circuit regulate the transfer of the desired digital video or digital audio signals" (Docket #69, Exhibit I, Column 10, lines 29-32). Identical language appears in claim 15 of the '440 patent (*Id.*, Tab K, Column 11, lines 20-23).

Defendants assert that this means "receive or transmit." Sightsound responds that "the claimed term 'transfer' may not be exactly the same as receive or transmit, as such verbs may describe part of the transfer but not the whole occurrence thereof." (Docket #74 at 29). Clearly, the transfer of the digital signals involves transmitting on one end and receiving on the other. To "regulate" that transfer, however, bespeaks more than simply transmitting or receiving. The use of the term "regulate" indicates that the transmitting and receiving are being controlled, directed or governed. See, Webster's New World Dictionary, Third College Edition (1988). Thus, in the context of the patent claims at issue, the phrase "regulate the transfer" is construed to mean that the first party and second party integrated circuits control the transfer of the digital signals, i.e., control the transmitting and receiving of such signals.

K. "electrical communication/electronically connected"

These terms are used in several claims in the '734 patent and claims 13-15 of the '440 patent, such as in claim 4 of the '734 patent referring to a "first party control unit" which has "a sales random access memory chip electronically connected to the first party hard disk . . ." (Docket #69, Exhibit I, Column 9, lines 44-48). Claim 5 describes "the second memory" which includes "a playback random access memory chip electronically connected to the second party hard disk . . ." (Id., Column 10, lines 7, 10-12). Claim 11 discloses a "means or a mechanism for connecting

electronically via the telecommunications lines the first memory with the second memory such that the desired digital video or digital audio signals can pass therebetween, said connecting means or mechanism in electrical connection with the transferring means or mechanism. . . ." (Id., Column 10, lines 60-61).

Defendants assert that the ordinary and accustomed meaning of "electrical communication" is a connection through "a hard-wired conduction path." Defendants further point out that Figure 1 of the patents illustrates a hard-wired conduction path between all of the elements.

Sightsound responds, first, that even if a hard-wired conduction path is necessary, there is no basis in the claims or specification for requiring that it be "single," as opposed to multiple, hard-wired conduction paths. The court agrees. The term "single" cannot be part of the definition.

Second, Sightsound notes that defendants' definition would require that the parties' respective control units be in a hard-wired conduction path with one another. The court has already analyzed the term "connecting through telecommunications lines," and the court agrees, for the reasons set forth above, that the control units need not be in a hard-wired conduction path while "electronically connected over telecommunications lines."

What remains, however, is a determination of whether the individual components of the first party memory must be connected by a hard-wired conduction path, and whether the same is true for the components of the second party memory. Sightsound states that, as

to invention elements at the same site, "[t]he language of the claims specifically uses these terms to link related elements and it does so by clear and express recitations." (Docket #74, at 30). Thus, the parties are in agreement that, as to invention elements at the same location, "electronically connected" and "electrical communication" each require a hard-wired conduction path.

L. "Individual songs" and "Temporary Staging Area"

Defendants assert that "individual songs" should be interpreted as meaning "one or more digital audio signals." This language is used in Claims 26 and 27 of the '734 patent, and is in the context of describing "a plurality of digital audio signals which include a plurality of desired individual songs as desired digital audio signals" (Docket #69, Exhibit I, column 14, lines 41-43). Defendants are correct, therefore, that "individual songs" are a subset of "digital audio signals."

Likewise, the phrase "temporary staging area" is used in reference to the "playback random access memory chip" and the "playback random access memory chip." Specifically, claim 14 of the '440 patent discloses:

14. A system as described in claim 13 wherein the second party control unit includes a second party hard disk which stores a plurality of digital video or digital audio signals, and a playback random access memory chip electronically connected to the second party hard disk for storing a replica of the desired digital video or digital audio signals as a temporary staging area for playback.

(Docket #69, Exhibit K, Column 10, lines 63-67; Column 11, lines 1-2) (emphasis added). Similar language appears in claim 5 of the '734 patent with respect to the use of the "playback random access memory chip" of the second memory. Thus, defendants are correct that, in each instance, the term "temporary staging area" refers to the "random access memory chip" being used for that purpose.

M. Means-Plus-Function Claims

The parties also present several claims which employ the means-plus-function format. As a general matter, the parties disagree on the amount of structure necessary for each means-plus-function claim, although there are also two disputes concerning the propriety of analyzing claims as means-plus-function. The claims will be addressed seriatim.

1. "Means [or a mechanism] for electronically selling the desired digital video or digital audio signals" (Claims 4-8 & 10 of the '734 patent, and claims 12-15 of the '440 patent)

The parties agree that this is "means-plus-function" language which occurs in claims 4 and 10 of the '734 patent and claim 12 of the '440 patent¹⁷. Defendants assert that the phrase as

17. This limitation also appears by incorporation in dependent claims 5-8 of the '734 patent and 13-15 of the '440 patent.

used in claim 4 of the '734 patent (which uses the term "means," and not "mechanism") should be construed to include the following structure:

A structure equivalent to (i) a continuous hard-wired conduction path directly interconnecting portions of Control Panel 20a and Control IC 20b, (ii) telephone lines 30, and (iii) a continuous hard-wired conduction path directly interconnecting portions of Control Panel 50a and Control IC 50b.

(Docket #65 at 36). Additionally, the language used in claim 12 of the '440 patent (which employs the phrase "means or a mechanism") requires a structure, in defendants' view, consisting of "a continuous hard-wired conduction path directly interconnecting portions of Control Panel 50a, Control IC 50b, Hard Disk 60, Playback RAM Chip 50d and Stereo Speakers 80." (*Id.*, at 40). Sightsound responds, with respect to both forms of the phrase, that "the corresponding structure is a control integrated circuit configured to effect the electronic sale of the digital video or digital audio signals." (Docket #69 at 24).

Thus, the parties have a very basic disagreement (which carries over to each of the remaining means-plus-function claims in dispute) concerning the amount of structure necessary to the disclosed function. Sightsound seeks an interpretation which limits the structure to the control integrated circuit and the particular configuration thereof which will enable the disclosed function to occur.¹⁸ Defendants, on the other hand, seek to include in the

18. As discussed above with respect to the construction of the term "electronically connected," the court does not understand Sightsound to contest that the individual elements of the first party control unit are connected electronically through a

required structure all elements necessary to carry out the "selling," including the structure on the receiving end of the sale, and a "hard-wired conduction path."

Initially, the court agrees that the claim term at issue recites a function, but does not recite a definite structure in support of that function. Hence, this is means-plus-function language, and analysis pursuant to 35 U.S.C. §112(6) is appropriate. Cole v. Kimberly-Clark Corp., supra, 102 F.3d at 531.

Before determining the structure associated with the disclosed means, the court must first determine the meaning of the term "electronically selling." The parties have disputed this language, and the court has already determined that "the requirement that the sale include both payment and electronic transfer of the digital signal is express in claim 4 of the '734 patent." Hence, the function disclosed, a means for "electronically selling," is a means for effectuating the transfer of payment and product over telecommunications lines.

Defendants' inclusion of telephone lines and the structure on the buyer's side of the transaction is, however, improper in this case. Claim 4 of the '734 patent (and claim 12 of the '440 patent) set forth the "means for electronically selling" as part of the "first party control unit." The elements of the buyer's control unit, as well as the telecommunications lines connecting the two

"hard-wired" connection, and that the same is true with respect to the elements of the second party control unit. Hence, the court will not address this element of the defendants' proposed definition in this or the ensuing claims.

control units, are set forth in separate paragraphs of the same claims, and are clearly not part of the "means" by which the first party control unit accomplishes the function necessary to effectuate the sale.

Thus, the more specific question to be answered in this case is what structure, as part of the first party control unit, is disclosed in the specification as being related to the function of electronically selling? The specification discloses that "the Control Unit 20 of the authorized agent is the means by which the electronic transfer of the Digital Audio Music from the agent's Hard Disk 10 via the Telephone Lines 30 to the user's or second party's Control Unit 50 is possible." (Docket #69, Exhibit I, Column 4, lines 12-16)¹⁹. Further, "Control Unit 20 has a control panel and control integrated circuit . . . [which] requires the Sales Random Access Memory Chip." (*Id.*, lines 19-23). The reader is also informed that "[t]he Control Units 20 and 50 . . . would be designed specifically to meet the teachings of this invention." (*Id.*, lines 35-37). The design of the control units is further described:

- 2) the Control Integrated Circuits 20b and 50b would be designed to control and execute the respective commands of the agent and user and regulate the electronic transfer of Digital Audio Music throughout the system, additionally, the sales Control Integrated Circuit 20b could electronically code the Digital Audio Music in a configuration which

19. This is the specification for the '734 patent. Identical language appears in the '440 patent specification (*Id.*, Exhibit J, Column 4).

would prevent unauthorized reproductions of the copyrighted material,

(Id., lines 43-50) (emphasis added). Later in the specification, the "means or mechanism for electronically selling" is discussed.

Preferably, the means or mechanism for electronically selling includes a means or a mechanism for charging a fee via telecommunications lines by the first party to the second party . . . Preferably, the second party has an account and the means or mechanism for charging a fee includes means or mechanism for charging the account of the second party. Preferably, the means or mechanism for charging the account includes means or a mechanism for receiving the credit card number of the second party. The means or mechanism for receiving a credit card number preferably is part of the control integrated circuit 20b.

(Id., Column 7, lines 40-52).

Therefore, the specification discloses that the first party control integrated circuit will be "designed to control and execute the . . . commands of the [first party] and regulate the electronic transfer," and that it will be the "means or mechanism" for charging the account of the buyer. It follows, then, that the "means" for electronically selling, which includes the transfer of the product in return for electronic payment, is a properly programmed control integrated circuit.

2. "Means or mechanism for the first party to charge a fee to the second party" (Claims 26 and 27 of '734 patent).

This language appears in claims 26 and 27 of the '724 patent. Defendants propose that the structure disclosed for this function is:

... equivalent to (1) a continuous hard-wired conduction path directly interconnecting portions of Control Panel 20a and Control IC 20b, (ii) telephone lines 30, and (iii) a continuous hard-wired conduction path directly interconnecting portions of Control Panel 50a and Control IC 50b.

(Docket #65 at 39). Sightsound again responds that the only structure of the disclosed function is "a control integrated circuit configured to enable the first party to charge a fee to the second party." (Docket #69 at 25).

The analysis of this claim proceeds in much the same fashion as the analysis for the prior claim language. The inclusion of telephone lines and the structure associated with the second party control unit is unnecessary because the "means for charging a fee" is expressly made part of the first party control unit only. Thus, the structure the court must discern is the means by which the first party control unit "charges a fee."

The specification discloses that the function of charging a fee is accomplished by the control integrated circuit (Id., Column 7, lines 40-52). Hence, the structure associated with this claim language is an appropriately programmed control integrated circuit.

3. "Means or mechanism for transferring money electronically via a telecommunication line" (Claims 11-14 of '734 patent).

Sightsound again asserts that an appropriately-configured integrated circuit is the necessary structure in claims 11-14 of the '734 patent (Docket #69 at 25). Defendants would describe the required structure thusly:

A structure equivalent to (i) a continuous hard-wired conduction path directly interconnecting portions of Control Panel 20a and Control IC 20b, (ii) telephone lines 30, and (iii) a continuous hard-wired conduction path directly interconnecting portions of Control Panel 50a and Control IC 50b.

(Docket #65 at 38). Again, the same analysis applies, and Sightsound's definition is correct.

4. "Means [or a mechanism] for playing the desired digital video or digital audio signals" (Claims 4-8 and 10 of '734 patent, and claims 12-15 of the '440 patent)

Defendants treat the phrase used in the '734 patent, "a means for playing" identically as they do the phrase used in claims 12-15 of the '440 patent, "a means or a mechanism for playing" Both, in defendants' view, require a "structure equivalent to a continuous hard-wired conduction path directly interconnecting portions of Control Panel 50a, Control IC 50b, Hard disk 60, Playback RAM Chip 50d and Stereo Speakers 80." (Docket #65 at 37, 40).

Sightsound argues that the structure is limited to an appropriately configured control integrated circuit "and a video display and/or speakers." (Docket #69 at 26).

Claim 4 of the '734 patent includes the following language in its description of the second party control unit:

a second party control unit having a second party control panel, a second memory connected to a second party control panel, and means for playing the desired digital video or digital audio signals connected to the second memory and the second party control panel, said means for playing operatively controlled by the second party control panel, said second party control unit remote from the first party control unit, said second party control unit placed by the second party at a location determined by the second party

(Docket #69, Exhibit I, Column 9, lines 54-63)²⁰. The claim expressly discloses the connection between the second memory, the second control panel and the "means" for playing the signal. Therefore, defendants' inclusion of the second party control panel and memory (hard disk and RAM), is unnecessary since that structure is expressly described in the claim. The structure which is not disclosed in the claim is the structure which, when directed by the control panel, causes the signals to be played.

The specification provides in this respect:

To play a stored song, the user types in the appropriate commands on the Control Panel 50a, and those commands are relayed to the Control Integrated Circuit 50b which retrieves the selected song from the Hard Disk 60 The Control Integrated Circuit 50b then sends the electronic output back to the Stereo Speakers 80 at a controlled rate using the Play Back Random Access Memory Chip 50d as a temporary staging point for the Digital Audio Music.

20. The language used in claim 12 of the '440 patent is identical with the addition of the words "or a mechanism" each time the work "means" is used (Id., Exhibit K, Column 10, lines 34-44).

(Id., Exhibit J, '734 Patent, column 5, lines 2-16). Thus, the structure necessary, in the context of the claims as written, is an appropriately configured control integrated circuit, connected by hard-wire electrical connection to a video display and/or stereo speakers.

5. Means or a mechanism for storing the desired digital video or digital audio signals" (Claims 11-14 of the '734 patent)

Sightsound proffers a structure consisting of "a control integrated circuit configured to effect the storing of the desired digital video or digital audio signals in the memory." (Docket #69 at 27). Defendants have it this way:

A structure equivalent to (i) a continuous hard-wired conduction path directly interconnecting portions of Control Panel 20a, Control IC 20b, and Sales RAM 20c, (ii) telephone lines 30, and (iii) a continuous hard-wired conduction path directly interconnecting portions of Control Panel 50a, Control IC 50b, Hard disk 60, and Incoming RAM 50c.

(Docket #65 at 39).

The claim language, appearing in claim 11 of the '734 patent, and incorporated in claim 12 as well, is part of "a system for transmitting desired" signals, and, in relevant part, provides for a:

means or a mechanism for storing the desired digital video or digital audio signals from the first memory in the second memory, said storing means or mechanism in electrical communication with said receiver or said transmitting means or mechanism and with said second memory.

(Docket #69, Exhibit I, Column 11, lines 33-38). Again, in the context of the claim, the elements being described are associated with the second party memory only. Thus, inclusion of telephone lines connecting the first and second memories is inappropriate, as is the inclusion of any structure on the first party side of the transaction. Further, the second memory is disclosed explicitly in the claim language, as is the connection between the "storing means" and the second memory. What is not disclosed is the structure to accomplish the "storing" in the second memory, and that is the focus of the court's inquiry.

The specification states that "[t]he Control Integrated Circuit 50b stores the replica onto the Play Back Random Access Memory Chip 50d at a high transfer rate." (Id., column 5, lines 9-12). The appropriate structure, then, is the control integrated circuit, which has been configured to effect the storing of the digital signals into the memory.

6. "Means or a mechanism for transmitting the desired digital audio signals from the first memory to the second memory" (Claims 11, 26 and 27 of the '734 patent)

Defendants assert that the language used in each cited claim requires:

A structure equivalent to (i) a continuous hard-wired conduction path directly interconnecting portions of Control Panel 20a, Control IC 20b, and Sales RAM 20c, (ii) telephone lines 30, and (iii) a

continuous hard-wired conduction path directly interconnecting portions of Control Panel 50a, Control IC 50b, Hard disk 60, and Incoming RAM 50c.

(Docket #65 at 38). Sightsound asserts that, as used in claim 11 of the '734 patent, this is not means-plus-function language. With respect to claim 26, plaintiff asserts that the "corresponding structure is a transmitter and a control integrated circuit configured to effect the transmitting of the desired digital video or digital audio signal via the transmitter." (Docket #69 at 27).

Claim 11 discloses the following:

means or a mechanism for transmitting the desired digital video or digital audio signals from the first memory to the second memory, said means or mechanism for transmitting comprising a transmitter connected to the first memory and the telecommunications lines and a receiver connected to the second memory . . .

(Id., Exhibit I, Column 11, lines 19-24) (emphasis supplied). Sightsound is correct that the structure of the "means or a mechanism for transmitting" is disclosed in the claim language, and, hence, this is not "means-plus-function" language which requires reference to the specification.

The relevant language from claim 26, which describes a "system for transferring digital audio signals," and which sets forth the elements of the first party control unit, reads as follows:

means or mechanism for transmitting the desired digital audio signals from the sales random access memory chip, said means or mechanism for transferring connected to the sales random access memory chip . . .

(Id., column 14, lines 48-51). Again, the inclusion of any structure which exists between the first and second party control units, or any structure which is part of the second party control unit, is improper because the claim is clearly limited to a description of the first party control unit. Further, the claim sets forth the existence and relationship between the transmitting means and the random access memory. Thus, inclusion of other elements of the first party control unit is unnecessary, and the court must discern the structure associated with the function of transmitting from the first party control unit.

The specification provides that the "Control Integrated Circuits 20b and 50d would be designed to control and execute the respective commands of the [parties] and regulate the electronic transfer . . ." (Id., column 4, lines 43-46). The transmitting function is clearly expressed in the specification, which discloses "a system for transmitting desired digital video or digital audio signals . . ." (Id., column 3, lines 13-14). Thus, the court cannot agree with defendants' proposed required structure. Instead, the corresponding structure is a transmitter connected to a properly programmed control integrated circuit.²¹

21. Defendants protest that the specifications of the '734 and '440 patents do not contain a description of a "transmitter." One skilled in the art, however, would not have difficulty in determining the nature of a transmitter necessary to perform the function at issue. Atmel Corp. v. Information Storage Devices, Inc., 198 F.3d 1374, 1381 (Fed.Cir. 1999) (No specific level of detail necessary in the description of structure, so long as one skilled in the art would identify the structure from the description.).

7. "Means or mechanism for connecting electronically via the telecommunications link" (Claim 11 of the '734 patent)

Once again, defendants assert that this language requires:

A structure equivalent to (i) a continuous hard-wired conduction path directly interconnecting portions of Control Panel 20a, Control IC 20b, and Sales RAM 20c, (ii) telephone lines 30, and (iii) a continuous hard-wired conduction path directly interconnecting portions of Control Panel 50a, Control IC 50b, Hard disk 60, and Incoming RAM 50c.

(Docket #65 at 38). Sightsound responds that this language is not means-plus-function as utilized in that claim, and the court must refer to that language in context to rule on this issue:

means or a mechanism for connecting electronically via the telecommunications lines the first memory with the second memory such that the desired digital video or digital audio signals can pass therebetween, . . . said connecting means or mechanism comprises a first control unit in possession and control of a first party, and a second control unit in possession and control of a second party

(Docket #69, Exhibit I, Column 10, lines 65-67; column 11, lines 1-7). The court must agree with Sightsound that the structure of the connecting means is disclosed in the claim. Therefore, there is no need to refer to the specification.

I. Order of Steps

Defendants also assert that claims which list steps (Claims 1-3 of the '573 patent, Claims 4, 26 and 28 of the '734 patent, and claim 12 of the '440 patent) should be construed to

require that those steps be performed in the order that they are listed. "Unless the steps of a method actually recite an order, the steps are not ordinarily construed to require one." Interactive Gift Express, Inc. v Compuserve, Inc., et al., 231 F.3d 859, 875 (Fed.Cir. 2000). An order may be imposed, however, if such a requirement is apparent from the claim language, Mantech Environmental Corporation v. Hudson Environmental Services, Inc., 152 F.3d 1368, 1376 (Fed.Cir. 1998), or where such a sequential order is implicit from a review of the claim, the specification and the prosecution history. Loral Fairchild Corp. v. Sony Corp., 181 F.3d 1313, 1322 (Fed. Cir. 1999).

The specification of the '573 patent implies, in two separate paragraphs, that a specific order is required in performing the steps set forth in claims 1-3 (Docket #70, Tab 51, col. 3, lines 3-19; col. 5, lines 29-45). The specification first lists the "transferring money" step and states that "then" the step of connecting electronically occurs. "Next," transmitting the desired audio signal is set forth, and "then" storing the signal in the second memory. The use of these terms clearly implies that they are to be performed in the order in which they are set forth.

Further, Claim 1 of the '573 patent does contain an implied order of at least the final three steps (i.e., the "connecting," "transmitting" and "storing" steps). Indeed, one skilled in the art would recognize that the digital audio signal cannot be transferred until a connection is made such that the signal may pass from the first memory to the second memory. In like

fashion, the signal cannot be stored on the second memory until a connection has been made and the signal has been transmitted from the first memory. Therefore, although there is no explicit language in claims 1-3 of the '573 patent which imposes an order of steps, the plain meaning of the terms used, and the process described, implies such an order. Therefore, the connecting step must precede the transmission step, and the transmission must, in turn, precede the storing on the second memory. There is, however, no such indication that the transferring money step must occur at any specific time in this process.

Claim 2, on the other hand, contains express language imposing an order on the transferring step:

2. A method as described in claim 1 including after the transferring step, the steps of searching the first memory for the desired digital audio signal; and selecting the desired digital audio signal from the first memory.

(Emphasis supplied). Plaintiff concedes that this imposes some order upon the steps. Once again, one would necessarily have to select the desired signal from the first memory prior to the first memory transmitting same. Thus, transferring money must occur, for purposes of Claim 2, prior to transmitting (and, of course, prior to storing the transmitted signal on the second memory).

Claim 3, also a dependent claim, builds upon Claim 2 and adds additional steps to be included within the "transferring step." Once again, the steps set forth in Claim 3 must necessarily occur prior to the transmitting and storing steps.

Defendants urge that the transferring of money must be the first step in the method described in claims 1-3 of the '573 patent. The court disagrees. The patentee showed himself to be entirely capable of imposing an order upon steps when he wished to do so. Further, while the specification implies that an order is required, it does not expressly state that this is so. In the court's view, beginning and ending with the language of the claim, it would rewrite Claim 1 of the '573 patent to say that this claim requires the transferring money step to occur first.²²

Nonetheless, the steps do have an order imposed by logic in light of the method which is described. Connecting electronically must be accomplished prior to the transmitting and storing steps. For similar reasons, the storing step must occur last in the context of Claim 1. The transfer of money, however, need not occur at any specific point. This, however, changes for Claims 2 and 3, which require that the transferring of money occur prior to transmission and storing, but does not impose any order on the transferring and connecting steps.

The court has reviewed Claim 4 of the '734 patent. In that claim, a system is set forth in which the "first party control unit" is described, then the "second party control unit" is described (Docket #69, Exhibit I, Claim.4). The operative language

22. The parties here have argued their claims construction cases with a clear intent to more favorably position themselves for the next stages of the case. While this is unseemly, it is probable also inevitable. The court, however, cannot indulge in it; we construe the claims and do so without regard to what may come.

in terms of imposing order is contained in the third paragraph of the claim:

telecommunications lines connected to the first party control unit and the second party control unit through which the electronic sales of the desired digital video or digital audio signals occur and through which the desired digital video or digital audio signals are electronically transferred from the sales random access memory chip to the second memory while the second memory is in possession and control of the second party and after the desired digital video or digital audio signals are sold to the second party by the first party.

(Id.) (Emphasis added). This claim clearly states that the digital audio signals are transferred only "after" they are "sold" to the second party. Hence, the only order imposed in this Claim is that the sale of the desired digital audio signal occur prior to transmission of that digital audio signal. The court is not persuaded by defendants' argument that this claim should be interpreted as requiring the electronic transfer of money prior to connecting the first memory to the second memory. The claim does not recite any order in respect to the connection between the first and second memories and the transfer of money.

Claims 26 and 28 of the '734 patent are much the same, with two paragraphs describing the composition of the first and second party control units, respectively, followed by a third paragraph, which differs slightly from claim to claim, but which in each case contains the only language that mandates any order to the steps described. The third paragraph of Claim 26 reads:

telecommunications lines connected to the first party control unit and the second party control unit through which the desired digital audio signals in

the sales random access memory are electronically transferred by the means or mechanism for transferring to the receiver while the second party is in possession and control of the second party control unit and after the desired digital audio signals of the first party's hard disk are sold to the second party by the first party with the means or mechanism for the first party to charge a fee.

(Id., Claim 26). The third paragraph of Claim 28 provides:

telecommunications lines connected to the first party control unit and the second party control unit through which the electronic sales of the desired digital video or digital audio signals occur of the first party's hard disk, and over which the desired digital video or digital audio signals of the first party's hard disk are electronically transferred from the sales random access memory chip to the second memory while the second party is in possession and control of the second memory and after the desired digital video or digital audio signals are sold to the second party by the first party.

(Id., Claim 28). In both Claims 26 and 28, therefore, the transfer of the digital audio (or video) signal is expressly said to occur after the signal has been "sold" to the second party. Otherwise, no order is expressly or implicitly imposed by the claim.

This leaves Claim 12 of the '440 patent. It is set forth in a form similar to the claims from the '734 patent, with the first two paragraphs describing a "first party control unit" and a "second party control unit," respectively. The third paragraph provides as follows:

telecommunications lines connected to the first party control unit and the second party control unit through which the electronic sales of the desired digital video or digital audio signals occur and through which the desired digital video or digital audio signals are electronically transferred from the first memory to the second memory while the second memory is in possession and control of the

second party and after the desired digital video or digital audio signals are sold to the second party by the first party.

(Docket #69, Exhibit K, Claim 12). Once again, the claim expressly states that the sale occurs, followed by the transfer, but is otherwise silent concerning the order of any further steps in the method described.

J. "Telephoning the First Party . . . by the Second Party"

The dispute between the parties with respect to this claim language is whether it requires a person-to-person telephone call. Defendants assert that it does, while Sightsound asserts that it should include any means of initiating a connection over telephone lines, including person-to-machine calls, and machine-to-machine calls.

This language appears in Claim 3 of the '573 patent, claim 1 of the '734 patent, and claims 4 and 39 of the '440 patent. The '573 patent discloses:

3. A method as described in claim 2 wherein the transferring step includes the steps of telephoning the first party controlling use of the first memory by the second party; providing a credit card number of the second party controlling the second memory to the first party controlling the first memory so the second party is charged money.

(Docket #70, Tab 51, Column 6, lines 29-36). The "transferring step" referred to in claim 3 is contained in claim 1, and reads as follows:

transferring money electronically via a telecommunication lien [sic] to the first party at a location remote from the second memory and

controlling use of the first memory from the second party financially distinct from the first party, said second party controlling use and in possession of the second memory;

(Id., at lines 8-14). The '734 patent includes the disputed language in claim 1:

1. A method for transferring desired digital video or digital audio signals comprising the steps of:

forming a connection through telecommunications lines between a first memory of a first party at a first party location and a second memory of a second party at a second party location . . .

telephoning the first party controlling use of the first memory by the second part[y];

providing a credit card number of the second party controlling the second memory to the first party . . .

(Docket #69, Exhibit I, Column 8, lines 39-59). The language is included in claims 4 and 39 of the '440 patent as a step included within the process of "charging the account" of the second party. Both claim 4 and claim 39 read as follows:

A method as described in claim [3 or 38] wherein the step of charging the account of the second party includes the steps of telephoning the first party controlling use of the first memory by the second party; providing a credit card number of the second party controlling the second memory to the first party controlling the first memory so the second party is charged money.

(Docket #69, Exhibit K, Column 9, lines 7-13; Column 14, lines 40-46).

Defendants assert that each use of the "telephoning" language requires a construction that involves "placing a telephone

call by a person at the second party location to a person at the first party location."

Plaintiffs would construe the term "telephoning" to mean "initiating a connection over a telephone line."

Defendants first note that the telephoning step as set forth in each of the claims is separate from the step of "connecting" the memories electronically by telecommunications lines step. Hence, it is argued, "telephoning the first party" must have some meaning other than forming a connection via telephone lines, and that it must not involve a computer-to-computer connection.

The court, however, notes that the telephoning step may be performed by one person to another person, while the "connecting" step necessarily involves an interaction between the machines on either end, hence the language from, e.g., claim 1 of the '734 patent, "forming a connection through telecommunications lines between a first memory of a first party at a first party location and a second memory of a second party at a second party location .

... " Thus, the obvious distinction here is not that the "telephoning" must be person-to-person, but, instead, is that the connecting step cannot be a person-to-person call, but must involve machines. The "telephoning" step, however, is the more expansive term in this respect, and could include a person placing a call, either by dialing a telephone himself, or by instructing a computer or modem to dial a number. Likewise, the receiving end of that communication could be a person, or it could be computer configured to accept the call and to record the information provided. This

type of communication was not unknown to persons of ordinary skill in the art in 1988, and is certainly commonplace today.

Also, reference to the preferred embodiment and Figure 1 of the patent specification, which is a diagram included in each patent, shows the "Control I.C." of the first party connected by "Telephone lines" to the "Control I.C." of the second party. There is no indication in the specification, or in the diagram, that a separate, person to person communication is required for the steps of the claimed invention to be performed, i.e., there are no people, or telephones depicted in Figure 1.

Plaintiff also points to the 1995 Webster's Dictionary definition of "telephoning", which includes: (1) to communicate with by telephone; (2) to call on the telephone; and (3) to transmit by telephone (Plaintiff's Exhibit H). Defendants prefer the 1986 Webster's New Collegiate Dictionary definition, which is "to send by telephone" or "to speak by telephone." In the court's view, each version of the dictionary cited could reasonably be read to include either person-to-person calls or any combination of people and machines on either end. For example, the 1995 definition explicitly states that telephoning means "to communicate" or "to transmit" by telephone, and the 1986 version includes the concept of "to send" by telephone along with "speaking." It is only this final definition, "speaking," which implies a person-to-person communication.

Defendants also note that the inventor referred to the transferring money step and noted that this could be accomplished "such as by telephoning the agent who has the hard disc over the

phone lines" (Docket #70, Tab 37 at 2). A similar comment was made during the prosecution of the '734 patent (Docket #71, Tab 10 at 2). The use of the words "such as," however, bespeaks the existence of other options for accomplishing this step. Hence, the court does not find that any limitation on the manner of "telephoning" can be read into the patent claims through the prosecution history.²³

The term "telephoning," therefore, does not include the restriction that it be a person-to-person call, and does not exclude the use of machines on either or both ends of the telephone communication. The court does not believe that further construction of this term is required.

K. CLAIMS 22, 36 AND 41 OF THE '440 PATENT

Defendants seek a ruling by this court that claims 22, 36 and 41 of the '440 patent are identical, or are so nearly so that there is no need to analyze an alleged infringing device separately under each claim. Even a cursory review of the claims establishes that they are, indeed, very similar. However, the court has not been presented with a construction question in this respect.

23. The court is also unpersuaded by the extrinsic evidence, from the inventor's deposition testimony, that an "example" of an electronic sale would be "calling up and ordering a pair of shoes from L.L. Bean." (Hair Deposition at 179-180). First, this is extrinsic evidence which is not necessary in this instance for the court to construe the claim language. Second, even if it were used, it is merely an example offered by the inventor, and does not bespeak a limit on the language used in the claims.

Instead, defendants assert that the language is so similar, "indistinguishable" in defendants' view, that "it is difficult, if not impossible, to imagine either an accused infringing product or asserted piece of prior art that contains the elements of one of these claims, but not the other two." (Docket #65 at 34).

The court understands, and shares, defendants' anticipation of a substantial narrowing of the claims asserted in this case. Nonetheless, a concern that claims with the same coverage not be asserted so as to streamline this case is not properly addressed during claim construction. There is simply no construction of these claims necessary to answer defendants' question, i.e., whether a prior art challenge or an accused infringing product could be found that reads on one claim but not the others. What is required is for the case to reach the point where such matters can be litigated.²⁴

J. "Stored replica/storing a replica/stores a replica"

Several claims in the '734 and '440 patents include the "replica" limitation²⁵. It is employed in the first step of Claim 1 of the '734 Patent, referring to the forming of a connection

24. And, of course, if the claims are as indistinguishable as defendants maintain, it would do Sightsound no good service to assert all three when a ruling on infringement is sought. The decision to assert one or more of these claims is, however, not a decision to be made by the court in the guise of claim construction.

25. It does not appear in the '573 patent.

this comprises a "complete copy of the digital audio signal that is stored at one time in the random access memory chip." Sightsound has not proposed a construction, but does not disagree that a "replica" is a copy of a digital audio signal and that it is stored in the random access memory chip of either the first or second party control unit. Sightsound maintains, however, that defendants' construction improperly imposes two limitations on the term "stores a replica," the first being a requirement that a complete copy be made first, and the second being that the complete copy would then be stored, all at one time, in the memory. Sightsound contends that a replica may be made and sent from the hard disk to the random access memory, and from there to the second memory, in portions. Indeed, the plain language of the claims set forth above does not indicate that any specific method of creating and storing the replica is required.

Defendants argue that the inventor relinquished any claim to transferring portions of the signals into and out of the sales random access memory. An inventor may, through his action in distinguishing a reference to prior art, relinquish part of what would normally be included within a claim's plain meaning. Interactive Gift, 231 F.3d at 865, quoting Elkay Manufacturing Co., 192 F.3d at 976. The '734 patent initially did not include "replica" in the first three claims, but incorporated it into the fourth:

1. A method for transferring desired digital video or digital audio signals comprising the steps of :

forming a connection through telecommunications lines between a first memory of a first party and a second memory of a second party, said first memory having said desired digital video or digital audio signals;

selling electronically by the first party to the second party through telecommunications lines, the desired digital video or digital audio signals in the first memory; and

transferring the desired digital video or digital audio signals from the first memory of the first party to the second memory of the second party through telecommunications lines while the second memory is in possession and control of the second party.

2. A method as described in Claim 1 including after the transferring step, the step of storing the desired digital video or digital audio signals in the second memory.

3. A method as described in Claim 2 including before the transferring step, the step of electronically coding the desired digital video or digital audio signals into a configuration which would prevent unauthorized reproduction of the desired digital video or digital audio signals.

4. A method as described in Claim 3 wherein the first memory includes a first party hard disk having a plurality of digital video or digital audio signals, and a sales random access memory chip which temporarily stores a replica of the desired digital video or digital audio signals purchased by the second party for subsequent transfer via telecommunications lines to the second memory of the second party; and including before the transferring step, there is the step of storing a replica of the desired digital video or digital audio signals from the hard disk in to the sales random access memory chip.

(Docket #71, tab 12 at 11-12). The first three claims were rejected, however, as being anticipated by the Freney Patent (Docket #71, Tab 15 at 1). Freney was described by the patent examiner on May 4, 1994, as follows:

Freeny, Jr. a method for transferring digital information which includes forming a connection through telecommunications lines between a first memory of a first party and a second memory of a second party, the first party having the digital signals, selling electronically by the first party to the second party through the telecommunications lines the desired digital signals, transferring the desired digital signals from the first party to the second party through said lines while the second memory is in possession and control of the second party and the step of storing the digital signals in the second memory.

(Docket #71, Tab 15 at 2). Mr. Hair responded to this rejection by cancelling claims 2-4, and rewriting claim 1 as "Claim 4 in independent form with the limitations of any intervening claims." (Id., Tab 17 at 17). In other words, Claims 1-4 as initially presented were combined into the new claim 1. The amendment caused several changes to claim 1, including adding the "store a replica" language and the language incorporating the use of a sales random access memory chip (Id., at 2-3).

Defendants assert that the addition of the "store a replica" language effectively surrendered the option of storing less than a complete copy of the desired signal at one time. The court does not agree.

An amendment to avoid a prior art rejection will surrender coverage included within the plain meaning of a term only when "a patentee takes a position before the PTO, such that a 'competitor would reasonably believe that the applicant had surrendered the relevant subject matter" Katz, 63 F.Supp.2d at 591. Here, if the rejection by the examiner in light of Freeny could be read to be premised upon the lack of a requirement that the replica be

stored and transferred at one time, then, perhaps, defendants' argument would succeed. The examiner's description of Freeny, though, does not include any mention of transferring all or only a portion of the desired digital signal at one time. Hence, there is no indication that this was the basis for the prior art rejection.

In fact, when one compares the elements lacking in the examiner's description of Freeny, and in proposed claims 1-3, with the new elements which were included in the amended claim 1, it appears that there could have been several bases for the examiner to find Freeny applicable. First, the amended claim 1 incorporates the description of "sales random access memory." Second, the concept of using a "replica" of the desired signal, rather than the signal itself, is introduced. Third, the amendment added the concept of the second party control unit being "remote" from the first party control unit. Hence, even if the lack of the term "replica" was the reason for the rejection, and the court is not convinced that it was, this would only establish that the use of the sales RAM to store such a replica prior to transfer was required to avoid Freeny. Again, the rejection and amendment do not suggest to the reasonable competitor that the inventor was surrendering coverage of a claim which includes transferring portions of the replica into and out of the sales RAM.

Therefore, the various forms of "stores a replica" will not be construed so as to require that a complete replica be stored at one time in the random access memory.

CONCLUSION

It is respectfully recommended that the claims in suit be construed in the manner set forth with more particularity above.

In accordance with the Magistrate's Act, 28 U.S.C. Section 636(b)(1)(B) and (C), and Local Rule 72.1.4 B, the parties are allowed ten (10) days from the date of service to file written objections to this report. Any party opposing the objections shall have seven (7) days from the date of service of objections to respond thereto. Failure to timely file objections may constitute a waiver of any appellate rights.



KENNETH J. BENSON
UNITED STATES MAGISTRATE JUDGE

Dated: February 8, 2002

cc: Richard F. Rinaldo, Esquire
Meyer, Unkovic & Scott
1300 Oliver Building
Pittsburgh, PA 15222

William K. Wells, Jr., Esquire
Brian S. Mudge, Esquire
Kenyon & Kenyon
1500 K Street, N.W., Suite 700
Washington, D.C. 20005-1257

Edward C. Flynn, Esquire
The Colony Building
8962 Hill Drive
North Huntingdon, PA 15642-3148

Eric Kraeutler, Esquire
Morgan, Lewis & Bockius
1701 Market Street
Philadelphia, PA 19103-2921

Irwin R. Gross, Esquire
Michael Barclay, Esquire
Wilson Sonsini Goodrich & Rosati
650 Page Mill Road
Palo Alto, CA 94304-1050

595
4/2/02

IN THE UNITED STATES DISTRICT COURT
FOR THE WESTERN DISTRICT OF PENNSYLVANIA

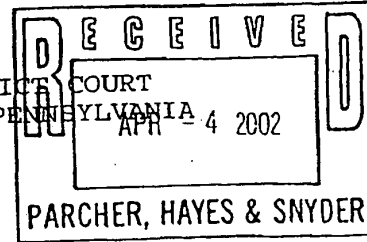

SIGHTSOUND.COM INCORPORATED,
a Pennsylvania corporation,

Plaintiff,

v.

N2K, INC., a Delaware
corporation, CDNOW, INC.,
a Pennsylvania corporation,
and CDNOW ONLINE, INC.,
a Pennsylvania corporation,

Defendants.

Civil Action No. 98-118
JUDGE DONALD J. LEE
MAGISTRATE JUDGE BENSON

MAGISTRATE JUDGE'S REPORT AND RECOMMENDATION

I. RECOMMENDATION

It is respectfully recommended that the Report and Recommendation (Docket #105) of February 8, 2002, be amended so as to clarify that no "hard-wired conduction path" limitation applies to the terms "electrical communication/electronically connected" wherever they appear.

II. REPORT

A Report and Recommendation (Docket #105) was filed in this patent case on February 8, 2002, which recommended that the claims in suit be interpreted as set out in detail therein. All parties were informed of their right to file written objections.

On February 22, 2002, plaintiff Sightsound.com, Inc. filed a Request for Clarification of (or, in the Alternative, an Objection to) One Aspect of Report and Recommendation on Claim Construction

(Docket #107). An order (Docket #108) was entered on February 25, 2002, calling for the defendant to respond to the plaintiff's request/objection by March 4, 2002. Counsel for defendant informed the court by telephone that it would not be responding to the plaintiff's request, presumably relying on their more extensive objections to the Report.

At issue is the recommended construction of the terms "electrical communication/electronically connected" appearing at pages 64-65 of the Report. The terms are used in claims 4-8, 10, 11-14 and 26 of the '734 patent and in claims 13-15 of the '440 patent.

The defendant's proffered construction of the terms at issue began by proposing a requirement of "a continuous hard-wired conduction path" As the plaintiff correctly notes, the Report recommended a construction that, in respect to nearly all the claims, rejected the proposed "hard-wired conduction path" limitation. But when discussing whether the individual components of the first and second party memories must be connected by a hard-wired conduction path, the Report departed from the approach generally taken and proposed that the court hold that "as to invention elements at the same location 'electronically connected' and 'electrical communication' each require a hard-wired conduction path." (Report and Recommendation at 65). This is the recommendation which the plaintiff requests be clarified or, in the alternative, to which it objects.

The language quoted above was preceded by this clause: "Thus, the parties are in agreement that" The plaintiff

argues vigorously and persuasively that it is not now, nor has it ever been "in agreement" that the hard-wired conduction path is a limitation on the terms to be interpreted. What the plaintiff did say, and what the undersigned took to be agreement with the defendant, was this:

"Third, with respect to the electrical connection among the invention elements that are in the same location, this [i.e., the defendant's proposed] definition repeats and adds to the language of the claims. The language of the claims specifically uses these terms to link recited elements and it does so by clear and express recitations. Accordingly, the Court should afford these terms their plain and ordinary meaning as they appear in the claims." (Docket #74 at 30).

It is clear now that it was error to interpret the plaintiff's language as expressing its agreement with the defendant's proposed construction. Moreover, neither the claims wherein the terms appear nor the specification nor the prosecution history imply that such a limitation as is proposed by the defendant is necessary or was contemplated.

It is respectfully recommended that the Report and Recommendation (Docket #105) filed on February 8, 2002, be amended so as to make clear that no "hard-wired conduction path" limitation applies to the terms "electrical communication/electronically connected" wherever they appear.

In accordance with the Magistrates Act, 28 U.S.C. Section 636(b)(1)(B) and (C), and Local Rule 72.1.4 B, the parties are allowed ten (10) days from the date of service to file written objections to this report. Any party opposing the objections shall have seven (7) days from the date of service of objections to

respond thereto. Failure to timely file objections may constitute a waiver of any appellate rights.

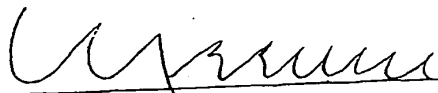
KENNETH J. BENSON
UNITED STATES MAGISTRATE JUDGE

Dated: April 2, 2002

cc: Honorable Donald J. Lee
United States District Judge

Richard F. Rinaldo, Esquire
Meyer, Unkovic & Scott
1300 Oliver Building
Pittsburgh, PA 15222

William K. Wells, Jr., Esquire
Brian S. Mudge, Esquire
Kenyon & Kenyon
1500 K Street, N.W., Suite 700
Washington, D.C. 20005-1257

Edward C. Flynn, Esquire
1808 Law & Finance Building
429 Forbes Avenue
Pittsburgh, PA 15219-1505

Eric Kraeutler, Esquire
Catharine E. Gillespie, Esquire
Morgan, Lewis & Bockius
1701 Market Street
Philadelphia, PA 19103-2921

Irwin R. Gross, Esquire
Michael Barclay, Esquire
Wilson Sonsini Goodrich & Rosati
650 Page Mill Road
Palo Alto, CA 94304-1050

Steven M. Hayes, Esquire
Neal H. Kaplan, Esquire
Jessica Givelber, Esquire
Parcher, Hayes & Snyder
500 Fifth Avenue, 38th Floor
New York, NY 10110

IN THE UNITED STATES DISTRICT COURT
FOR THE WESTERN DISTRICT OF PENNSYLVANIA

SIGHTSOUND TECHNOLOGIES, INC.,)	
)	
Plaintiff,)	
-vs-)	
)	Civil Action No. 04-1549
)	
ROXIO, INC., and NAPSTER LLC.,)	
)	
Defendants.)	

AMBROSE, Chief District Judge.

ORDER OF COURT

AND NOW, this 28th day of February, 2005, after careful consideration, and for the reasons set forth in the accompanying Opinion, the Defendants' Motion to Stay (Docket No. 22) is GRANTED. This case is stayed. The Defendants are to contact this Court immediately upon receiving any notification from the PTO regarding the outcome of the Request for Reexamination. It is further ORDERED that the preliminary injunction hearing currently scheduled for March 3, 2005 at 1:30 P.M. is canceled. The Motion for Preliminary Injunction (Docket No. 11) is denied without prejudice to reassert once the stay is lifted.

BY THE COURT:

Donetta W. Ambrose

Donetta W. Ambrose,
Chief U. S. District Judge

A- 0001

IN THE UNITED STATES DISTRICT COURT
FOR THE WESTERN DISTRICT OF PENNSYLVANIA

SIGHTSOUND TECHNOLOGIES, INC.,)	
)	
Plaintiff,)	
)	
-vs-)	
)	Civil Action No. 04-1549
)	
ROXIO, INC., and NAPSTER LLC.,)	
)	
Defendants.)	

AMBROSE, Chief District Judge.

MEMORANDUM OPINION

As the parties are well aware, Plaintiff Sightsound Technologies, Inc. ("Sightsound") alleges that Defendants Roxio, Inc. ("Roxio") and Napster, L.L.C. ("Napster") have infringed its '573 Patent, its '734 Patent and its '440 Patent. Sightsound has filed a Motion for Preliminary Injunction with respect to particular embodiments of the '734 and the '440 Patents. That Motion remains outstanding and no hearing has yet been held.

Since Sightsound filed its Motion for Preliminary Injunction, Roxio and Napster have filed with the United States Patent and Trademark Organization ("PTO") a Request for Reexamination of the '573 Patent, the '734 Patent and the '440 Patent. Roxio and Napster argue that none of the patents are valid given prior art and double patenting. In light of its Request for Reexamination, Roxio and Napster have filed with this Court a Motion to Stay the litigation pending the PTO's reexamination.

A- 0002

See Docket No. 22. Roxio and Napster allege that a stay would preserve both this Court's and the parties' resources, as reexamination may render this litigation moot or substantially altered. Sightsound opposes the stay. It argues that this Court must first rule on the request for preliminary injunctive relief.

ANALYSIS

"A motion to stay an action pending a resolution of a request for re-examination is directed to the sound discretion of the court." Lutron Electronics Co., Inc. v. Genlyte Thomas Group, L.L.C., Civ. No. 3-2702, 2004 WL 953088 at * 1 n. 2 (E.D. Pa. April 30, 2004), citing, Xerox Corp. v. 3Com Corp., 69 F. Supp.2d 404, 406 (W.D. N.Y. 1999). Staying the litigation and allowing the PTO to process the request for reexamination offers distinct benefits. First, as Congress contemplated, reexamination before the PTO would "permit efficient resolution of questions about the validity of issued patents without recourse to expensive and lengthy infringement litigation." 1980 U.S.C.C.A.N. 6460, 6462-63. Second, as Congress recognized, reexamination procedures allow courts to refer patent validity matters, which may involve complex and technical issues, to the expertise of the PTO. Id., p. 6463.

I think that Congress's purpose in providing for a reexamination procedure is well served by issuing a stay in this litigation. The three factors traditionally analyzed in determining whether to issue a stay - (1) whether a stay would unduly prejudice the non-moving party; (2) whether a stay would simplify issues for trial;

A- 0003

and (3) whether the case has progressed beyond its initial stages¹ - favor issuing the stay.

For instance, Sightsound will not suffer undue prejudice if the litigation is stayed. I recognize that Sightsound claims it will suffer immediate harm if this Court does not entertain, and grant, its request for preliminary injunctive relief. Yet Sightsound's contention is belied by the fact that it delayed seeking injunctive relief for nearly one and one half years after discovering the Defendants' alleged infringing activity. Further, while Sightsound may suffer some harm if the action is stayed, that harm is not irreparable in nature. Sightsound itself acknowledged that its sole business purpose is to secure licensing arrangements of its patents and / or to secure damages through litigation. This supports the conclusion that Sightsound can be adequately compensated by a monetary award.

A stay would also simplify issues for trial. Indeed, Sightsound does not even argue this point. The reexamination process has, in my view, three possible outcomes. First, the PTO could reject all the patents as invalid. In this case, this litigation can be dismissed. Second, the PTO could affirm all of the patents as they are currently written. In this case, Sightsound's arguments regarding validity gain immeasurable strength and the issue of prior art becomes easier. Third, the PTO could accept, reject and / or modify one or more of the patents. In this instance I would again have the benefit of an expert in the field's take on the prior art. Any

¹ See In re Laughlin Products, Inc., 265 F. Supp.2d 525, 530 (E.D. Pa. 2003) and Alloc, Inc. v. Unillum Decor N.V., Civ. No. 3-253, 2003 WL 21640372 at * 2 (D. Delaware July 11, 2003).

one of the three scenarios would likely encourage settlement.

Finally, a stay at this procedural juncture would avoid a duplication of effort by this Court and the PTO. This case has not yet proceeded beyond the initial stages of litigation. No case management order has been issued. The parties have not yet engaged in extensive discovery. I have not yet held a Markman hearing. Resources are better spent pursuing the patent validity issue first before the PTO.

Consequently, because I find that Sightsound will not suffer undue prejudice if a stay is granted, because I think that a stay would likely simplify the matters at issue, and because this case has not yet proceeded beyond the initial stage, I find that a stay is appropriate.

DATE FILED: FEBRUARY 28, 2005

PLAINTIFF'S COUNSEL: MEYER UNKOVIC & SCOTT LLP
ATTN RICHARD F RINALDO ESQ
1300 OLIVER BLDG
PITTSBURGH PA 15222

KENYON & KENYON
ATTN WILLIAM K WELLS ESQ
1500 K ST NW STE 700
WASHINGTON DC 20005

DEFENDANTS' COUNSEL: PEPPER HAMILTON
ATTN KATHRYN M KENYON
500 GRANT ST ONE MELLON 50TH FL
PITTSBURGH PA 15219

PEPPER HAMILTON
ATTN LAURENCE Z SHIEKMAN ESQ
18TH & ARCH STS
PHILADELPHIA PA 19103-2799

QUINN EMANUAL URQUHART OLIVER & HEDGES
ATTN CHARLES K VERHOEVEN ESQ
865 S FIGUEROA ST 10TH FL
LOS ANGELES CA 90017

A- 0005

IN THE UNITED STATES DISTRICT COURT
FOR THE WESTERN DISTRICT OF PENNSYLVANIA

SIGHTSOUND TECHNOLOGIES, INC.,)

Plaintiff,)

-vs-)

Civil Action No. 04-1549)

ROXIO, INC., and NAPSTER LLC.,)

Defendants.)

AMBROSE, Chief District Judge.

ORDER OF COURT

AND NOW, this 28th day of February, 2005, after careful consideration, and for the reasons set forth in the accompanying Opinion, the Defendants' Motion to Stay (Docket No. 22) is GRANTED. This case is stayed. The Defendants are to contact this Court immediately upon receiving any notification from the PTO regarding the outcome of the Request for Reexamination. It is further ORDERED that the preliminary injunction hearing currently scheduled for March 3, 2005 at 1:30 P.M. is canceled. The Motion for Preliminary Injunction (Docket No. 11) is denied without prejudice to reassert once the stay is lifted.

BY THE COURT:

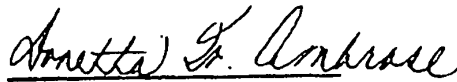

Donetta W. Ambrose,
Chief U. S. District Judge

A- 0006

**This Page is Inserted by IFW Indexing and Scanning
Operations and is not part of the Official Record**

BEST AVAILABLE IMAGES

Defective images within this document are accurate representations of the original documents submitted by the applicant.

Defects in the images include but are not limited to the items checked:

- BLACK BORDERS**
- IMAGE CUT OFF AT TOP, BOTTOM OR SIDES**
- FADED TEXT OR DRAWING**
- BLURRED OR ILLEGIBLE TEXT OR DRAWING**
- SKEWED/SLANTED IMAGES**
- COLOR OR BLACK AND WHITE PHOTOGRAPHS**
- GRAY SCALE DOCUMENTS**
- LINES OR MARKS ON ORIGINAL DOCUMENT**
- REFERENCE(S) OR EXHIBIT(S) SUBMITTED ARE POOR QUALITY**
- OTHER:**

IMAGES ARE BEST AVAILABLE COPY.

As rescanning these documents will not correct the image problems checked, please do not report these problems to the IFW Image Problem Mailbox.

12-16-08

RE-EXAM

CERTIFICATE OF MAILING BY "EXPRESS MAIL" (37 CFR 1.10)		Docket No.	
Applicant(s): Arthur R. Hair		NAPS001	

Application No. 90/007,402	Filing Date January 31, 2005	Examiner Roland G. Foster	Customer No. 23973	Group Art Unit 3992
--------------------------------------	--	-------------------------------------	------------------------------	-------------------------------

Invention:
Method for Transmitting Desired Digital Video or Digital Audio Signals

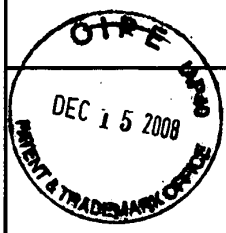

66155 U.S. PTO

 12/15/08

I hereby certify that this **Amended Brief on Appeal Under 37 C.F.R. 41.37**
(Identify type of correspondence)
 is being deposited with the United States Postal Service "Express Mail Post Office to Addressee" service under
 37 CFR 1.10 in an envelope addressed to: Director of the United States Patent and Trademark Office, P.O. Box
 1450, Alexandria, VA 22313-1450 on **December 15, 2008**
(Date)

Lorraine T. Lewis
(Typed or Printed Name of Person Mailing Correspondence)

(Signature of Person Mailing Correspondence)

EV320481168US
("Express Mail" Mailing Label Number)

Note: Each paper must have its own certificate of mailing.

Attorney's Docket No. NAPS001

Patent

IN THE UNITED STATES PATENT AND TRADEMARK OFFICE

In re Application of: Arthur R. Hair	:	Group No.: 3992
Serial No.: 90/007,402	:	Examiner: Roland G. Foster
Filed: January 31, 2005	:	Confirmation No. 2998
For: METHOD FOR TRANSMITTING A DESIRED DIGITAL VIDEO OR AUDIO SIGNAL		

CERTIFICATE OF SERVICE

The undersigned hereby certifies that a true and correct copy of the AMENDED BRIEF ON APPEAL UNDER 37 C.F.R. § 41.37, which was filed with the United States Patent & Trademark Office on December 15, 2008, in Reexamination No. 90/007,402, was served via First Class United States Mail, postage prepaid, this 15th day of December 2008, on the following:

Mr. Albert S. Penilla
Martine, Penilla, & Gencarella, LLP
710 Lakeway Drive, Suite 200
Sunnyvale, CA 94085
Attorney for Third Party Reexamination Requester

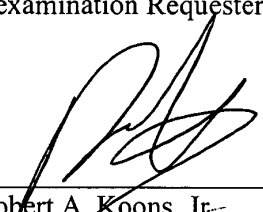
By: 
Robert A. Koons, Jr.
Attorney for Appellant (Patentee)



UNITED STATES PATENT AND TRADEMARK OFFICE

UNITED STATES DEPARTMENT OF COMMERCE
United States Patent and Trademark Office
Address: COMMISSIONER FOR PATENTS
P.O. Box 1450
Alexandria, Virginia 22313-1450
www.uspto.gov

APPLICATION NO.	FILING DATE	FIRST NAMED INVENTOR	ATTORNEY DOCKET NO.	CONFIRMATION NO.
90/007,402	01/31/2005	5191573	NAPS001	2998

23973 7590 12/31/2008

DRINKER BIDDLE & REATH
ATTN: INTELLECTUAL PROPERTY GROUP
ONE LOGAN SQUARE
18TH AND CHERRY STREETS
PHILADELPHIA, PA 19103-6996

EXAMINER

ART UNIT PAPER NUMBER

DATE MAILED: 12/31/2008

Please find below and/or attached an Office communication concerning this application or proceeding.



DO NOT USE IN PALM PRINTER

(THIRD PARTY REQUESTER'S CORRESPONDENCE ADDRESS)

Albert S. Penilla

Martine Penilla & Gencarella LLP

710 Lakeway Drive, Suite 200

Sunnyvale, CA 94085

EX PARTE REEXAMINATION COMMUNICATION TRANSMITTAL FORM

REEXAMINATION CONTROL NO. 90/007,402.

PATENT NO. 5191573.

ART UNIT 3992.

Enclosed is a copy of the latest communication from the United States Patent and Trademark Office in the above identified *ex parte* reexamination proceeding (37 CFR 1.550(f)).

Where this copy is supplied after the reply by requester, 37 CFR 1.535, or the time for filing a reply has passed, no submission on behalf of the *ex parte* reexamination requester will be acknowledged or considered (37 CFR 1.550(g)).



UNITED STATES DEPARTMENT OF COMMERCE

U.S. Patent and Trademark Office

Address : COMMISSIONER FOR PATENTS

P.O. Box 1450

Alexandria, Virginia 22313-1450

APPLICATION NO./ CONTROL NO.	FILING DATE	FIRST NAMED INVENTOR / PATENT IN REEXAMINATION	ATTORNEY DOCKET NO.
90007402	1/31/2005	5191573	NAPS001

DRINKER BIDDLE & REATH
ATTN: INTELLECTUAL PROPERTY GROUP
ONE LOGAN SQUARE
18TH AND CHERRY STREETS
PHILADELPHIA, PA 19103-6996

EXAMINER

ROLAND G.. FOSTER

ART UNIT	PAPER
-----------------	--------------

3992

20081230

DATE MAILED:

Please find below and/or attached an Office communication concerning this application or proceeding.

Commissioner for Patents

The Appellant filed an amended brief on December 15, 2008 correcting the Evidence Appendix deficiencies identified both in the Board of Patent Appeals and Interferences Order, mailed November 13, 2008 and in the resulting Notice of Non-Compliant Appeal Brief, mailed December 4, 2008.

No further action is required by the examiner and the proceeding is returned to the Board of Patent Appeals and Interferences.

ROLAND G. FOSTER
CRU EXAMINER-AU 3992



UNITED STATES PATENT AND TRADEMARK OFFICE

UNITED STATES DEPARTMENT OF COMMERCE
United States Patent and Trademark Office
Address: COMMISSIONER FOR PATENTS
P.O. Box 1450
Alexandria, Virginia 22313-1450
www.uspto.gov

APPLICATION NO.	FILING DATE	FIRST NAMED INVENTOR	ATTORNEY DOCKET NO.	CONFIRMATION NO.
-----------------	-------------	----------------------	---------------------	------------------

90/007,402	01/31/2005	5191573	NAPS001	2998
------------	------------	---------	---------	------

23973 7590 01/27/2009
 DRINKER BIDDLE & REATH
 ATTN: INTELLECTUAL PROPERTY GROUP
 ONE LOGAN SQUARE
 18TH AND CHERRY STREETS
 PHILADELPHIA, PA 19103-6996

EXAMINER

FOSTER, ROLAND G

ART UNIT	PAPER NUMBER
----------	--------------

3992

MAIL DATE	DELIVERY MODE
-----------	---------------

01/27/2009

PAPER

Please find below and/or attached an Office communication concerning this application or proceeding.

The time period for reply, if any, is set in the attached communication.



United States Patent and Trademark Office

**Under Secretary of Commerce for Intellectual Property and
Director of the United States Patent and Trademark Office**
P.O. Box 1450
Alexandria, Virginia 22313-1450
www.uspto.gov

DRINKER BIDDLE & REATH
ATTN: INTELLECTUAL PROPERTY GROUP
ONE LOGAN SQUARE
18TH AND CHERRY STREETS
PHILADELPHIA, PA 19103-6996

Appeal No: 2009-3609
Application: 90/007,402
Appellant: Arthur R. Hair

Board of Patent Appeals and Interferences Docketing Notice

Application 90/007,402 was received from the Technology Center at the Board on January 12, 2009 and has been assigned Appeal No: 2009-3609.

A review of the file indicates that the following documents have been filed by appellant:

Appeal Brief filed on: January 30, 2008
Reply Brief filed on: June 23, 2008
Request for Hearing filed on: June 23, 2008

In all future communications regarding this appeal, please include both the application number and the appeal number.

The mailing address for the Board is:

BOARD OF PATENT APPEALS AND INTERFERENCES
UNITED STATES PATENT AND TRADEMARK OFFICE
P.O. BOX 1450
ALEXANDRIA, VIRGINIA 22313-1450

The facsimile number of the Board is 571-273-0052. Because of the heightened security in the Washington D.C. area, facsimile communications are recommended. Telephone inquiries can be made by calling 571-272-9797 and should be directed to a Program and Resource Administrator.

By order of the Board of Patent Appeals and Interferences.

Third Party Requester:

Albert S. Penilla
MARTINE PENILLA & GENCARELLA, LLP
710 Lakeway Drive
Suite 200
Sunnyvale, CA 94085



UNITED STATES PATENT AND TRADEMARK OFFICE

UNITED STATES DEPARTMENT OF COMMERCE
United States Patent and Trademark Office
Address: COMMISSIONER FOR PATENTS
P.O. Box 1450
Alexandria, Virginia 22313-1450
www.uspto.gov

Table with 5 columns: APPLICATION NO., FILING DATE, FIRST NAMED INVENTOR, ATTORNEY DOCKET NO., CONFIRMATION NO.

90/007,402 01/31/2005 5191573 NAPS001 2998

23973 7590 03/12/2009
DRINKER BIDDLE & REATH
ATTN: INTELLECTUAL PROPERTY GROUP
ONE LOGAN SQUARE
18TH AND CHERRY STREETS
PHILADELPHIA, PA 19103-6996

Table with 1 column: EXAMINER

FOSTER, ROLAND G

Table with 2 columns: ART UNIT, PAPER NUMBER

3992

Table with 2 columns: MAIL DATE, DELIVERY MODE

03/12/2009 PAPER

Please find below and/or attached an Office communication concerning this application or proceeding.

The time period for reply, if any, is set in the attached communication.



UNITED STATES PATENT AND TRADEMARK OFFICE

Board of Patent Appeals and Interferences

DRINKER BIDDLE & REATH
ATTN: INTELLECTUAL
PROPERTY GROUP
ONE LOGAN SQUARE
18TH AND CHERRY STREETS
PHILADELPHIA, PA 19103-6996

Appeal No: 2009-3609
Appellant: 5191573, Sightsound.com Incorporated(Owner),
Application No: Napster, Inc.(3rd Pty. Req.), Albert S. Penilla et al.
Hearing Room: 90/007,402
Hearing Docket: A
Hearing Date: B
Hearing Time: Wednesday, June 17, 2009
Location: 10:00 AM
Madison Building - East Wing
600 Dulany Street, 9th Floor
Alexandria, Virginia 22313-1450

NOTICE OF HEARING
CONFIRMATION REQUIRED WITHIN TWENTY-ONE DAYS

Your attention is directed to 37 CFR § 41.47. The above identified appeal will be heard by the Board of Patent Appeals and Interferences on the date indicated. Hearings will commence at the time set and as soon as the argument in one appeal is concluded, the succeeding appeal will be taken up. The time allowed for argument is twenty minutes unless additional time is requested and permitted before the argument is commenced. If there are any inquiries, please contact the Clerk of the Board at 571-272-9797.

The application involved in this appeal has been published. Accordingly, the hearing in this appeal is open to the public.

CONFIRMATION OR WAIVER OF THE HEARING IS REQUIRED. This form must be completed below and facsimile transmitted to both: (1) the USPTO Central fax number (official copy), and (2) the Board of Patent Appeals and Interferences fax number (courtesy copy) within TWENTY-ONE (21) DAYS from the mailing date of this notice indicating confirmation or waiver of the hearing. A copy of this notice may be alternately filed by mail if facsimile is not available.

BPAI HEARINGS FAX No: (571) 273-0299

USPTO Central Fax No: (571) 273-8300

BPAI Mailing Address: Board of Patent Appeals and Interferences
United States Patent and Trademark Office
P.O. BOX 1450
Alexandria, Virginia 22313-1450

In all communications relating to this appeal, please identify the appeal by its number.

CHECK ONE: () HEARING ATTENDANCE CONFIRMED () HEARING ATTENDANCE WAIVED

Signature of Attorney/Agent/Appellant

Date

Registration No.

Names of other visitors expected to accompany counsel:

For information on visitor access to hearing rooms and security procedures at the USPTO Alexandria Campus, see
http://www.uspto.gov/web/offices/dcom/gcounsel/contact.htm#bpai_contacts

Albert S. Penilla
Martine, Penilla & Gencarella, LLP
710 lakeway Drive
Suite 200
Sunnyvale, CA 94085



UNITED STATES PATENT AND TRADEMARK OFFICE

UNITED STATES DEPARTMENT OF COMMERCE
United States Patent and Trademark Office
Address: COMMISSIONER FOR PATENTS
P.O. Box 1450
Alexandria, Virginia 22313-1450
www.uspto.gov

Table with 5 columns: APPLICATION NO., FILING DATE, FIRST NAMED INVENTOR, ATTORNEY DOCKET NO., CONFIRMATION NO.

90/007,402 01/31/2005 5191573 NAPS001 2998

23973 7590 07/10/2009
DRINKER BIDDLE & REATH
ATTN: INTELLECTUAL PROPERTY GROUP
ONE LOGAN SQUARE
18TH AND CHERRY STREETS
PHILADELPHIA, PA 19103-6996

Table with 1 column: EXAMINER

FOSTER, ROLAND G

Table with 2 columns: ART UNIT, PAPER NUMBER

3992

Table with 2 columns: MAIL DATE, DELIVERY MODE

07/10/2009 PAPER

Please find below and/or attached an Office communication concerning this application or proceeding.

The time period for reply, if any, is set in the attached communication.

RECORD OF ORAL HEARING
UNITED STATES PATENT AND TRADEMARK OFFICE

BEFORE THE BOARD OF PATENT APPEALS
AND INTERFERENCES

Ex Parte SIGHTSOUND.COM, INC.

Appeal 2009-3609
Application 90/007,402
Technology Center 3900

Oral Hearing Held: June 17, 2009

Before JOSEPH F. RUGGIERO, SCOTT R. BOALICK, and KEVIN F.
TURNER, *Administrative Patent Judges*.

APPEARANCES:

Examiner Roland G. Foster
TC 3900

ON BEHALF OF THE APPELLANT:

Michael R. Casey, Esquire
DAVIDSON, BERQUIST, JACKSON & GOWDEY, L.L.P.
4300 Wilson, Blvd., 7th Floor
Arlington, VA 22203

PROCEEDINGS

1
2
3
4
5
6
7
8
9
10
11
12
13
14
15
16
17
18
19
20
21
22
23
24
25

JUDGE RUGGIERO: Okay, go.

DR. CASEY: Thank you. Thank you for your indulgence, Your Honor.

Your Honor, unlike the previous two cases, this one is not a question of Yurt and Goldwasser but some other prior art. But the case does still turn, for many of the issues on appeal, on the question of are the claims supported by a filing date early enough to obviate the applied reference as an actual piece of prior art?

The first three rejections in this case that are being appealed are rejections as to whether or not Cohen is prior art -- Cohen and Bush are prior art, and Bush and Cohen are prior art. I would submit to you that Cohen, which was filed December 16th, 1988, is not prior art because the claims are supported by the originally-filed specification, and that's a June 1988 specification. As such, Cohen is not properly prior art before -- against these claims.

So that really reduces us down to the adequate written description and enablement issues that we've already discussed probably more than once. And then the remaining two issues are whether or not the claims are obvious over two combinations: one, Bush and Freeny, which we call Freeny 1; and then a second one, Akashi and Freeny, which we call Freeny 2. Unfortunately, they're two different patents with the same inventor, but hopefully we can distinguish them.

Generally, as set out in the briefs, the combination of Bush and Freeny 1 don't disclose that the end result is supposed to be a storage of audio music

1 -- digital audio or digital video, in a nonvolatile memory that's not a CD or a
2 tape. The -- as a result, the Freeny 1 is directed towards a totally different
3 kind of invention. It's a digital -- it's a voice recorder versus a message
4 recorder. And because of the area that Freeny 1 is in and the area that Bush
5 is in, there's no actual motivation to combine these references, as has been
6 described in the office action.

7 So, as described in the rejection, the motivation for combining --
8 sorry, Your Honor.

9 JUDGE BOALICK: I believe you said that the motivation involved
10 citations to Cohen as part of the rationale. Is that correct?

11 DR. CASEY: Yes, Your Honor.

12 JUDGE BOALICK: Did I understand that argument?

13 DR. CASEY: As mentioned in the Brief, the motivation to combine
14 Freeny and -- Freeny 1 and Bush is premised on Cohen providing
15 motivation, but Cohen is not actually prior art.

16 That takes us back to the original issues, one through three, as to
17 whether or not Cohen is properly applied. And as a result, absent the
18 motivation provided by Cohen, there is no evidence in the record that one of
19 ordinary skill in the art would have made the combination proposed in the
20 fifth issue -- I'm sorry, the fourth issue on appeal.

21 And then, the last issue is the combination of Akashi and Freeny.
22 Akashi already discloses a CD and a tape and Freeny discloses an output -- a
23 kiosk for outputting these physical devices, and those combinations are such
24 that the -- one who was ordinarily skilled in the art wouldn't have looked to
25 combine those two because they already had issues that were in common.

1 What was Akashi missing that Freeny was going to help fix? The
2 Office Action talks about security of hard disks and other reasons like that.
3 But there is no indication that one of ordinary skill in the art would believe
4 that Akashi was somehow deficient or that Freeny was somehow deficient,
5 that they needed to be modified. As a result, without the recognition of the
6 problem, there can be no motivation to actually try to combine these two.

7 JUDGE BOALICK: How about -- the Examiner pointed out that I
8 mean, as you've said before, that the very large hard disks were known, you
9 know, as of -- at least as of 1988, and that really this might be considered
10 under *KSR* no more than a substitution of known components with no
11 unexpected results. I mean just substituting a hard drive for an optical drive,
12 both of which had large capacities. What about that?

13 DR. CASEY: I think, Your Honor, that it misses the exact thing that
14 has kind of made this invention what it is.

15 The original specification talks about the cumbersomeness of these
16 disks, and the fact that they cause increased handling, and they require
17 people to deal with media that they don't want to deal with. Now, that
18 recognition that, hey, we can get rid of these and substitute with a hard disk,
19 was that of the Applicant? And to now, in 2009, look back 20 years, it's
20 very difficult to say, oh yeah, one of ordinary skill in the art would have said
21 these are interchangeable.

22 But looking back at the time, forward, one of ordinary in the art, when
23 he had Freeny and Akashi in his hands, wouldn't have even realized that
24 there was this market to be tapped. That there was going to be this whole
25 revolution of, God, I can free myself from CDs, and tapes, and the linear

1 problems of searching through tapes, and the optical problems of the hard
2 disk, and instead, I can use a fast, magnetic disk that's going to provide me
3 all these advantages. The one person who thought of it, unfortunately
4 thought of it many, many years too soon, and it took the copyright holders
5 many years to catch up to the importance of this invention.

6 JUDGE TURNER: Are you sort of stating that while they were
7 equivalent they wouldn't have been equivalent for this application? I'm
8 trying to summarize your argument.

9 DR. CASEY: I'm trying to say that the --

10 JUDGE TURNER: Because, certainly, hard disks and CDs would
11 have been -- I mean in the computers at the time they both would have been
12 prevalent. So that one could certainly make an argument that they're -- that
13 one would be obvious over another. It seems to me maybe you're suggesting
14 that the application of one wouldn't be applicable to the application of the
15 other?

16 DR. CASEY: I'm saying that the use of one environment versus
17 another is what's not obvious. In the computer world, you can -- you could
18 use, you know, bubble memory. You could use core memory. But there are
19 times when one thing has an actual use and would be appropriate and in
20 other areas it just isn't. And it takes understanding what that area is before
21 you can say whether or not these are equivalent. And one of the things that's
22 missing from the rejection is an analysis of why these two things would have
23 been considered equivalent in this particular area, such that we could present
24 evidence to the contrary that in fact it wouldn't have been known. The
25 motivation here just says, yeah, these things could have been interchanged

1 and there would have been these good results. But where is the evidence
2 that those are the results that one of ordinary skill in the art 21 years ago
3 would have expected from that particular modification?

4 JUDGE BOALICK: And I didn't see any, but you hadn't presented
5 any evidence showing that one of ordinary skill at that time, you know,
6 would not have thought to use a hard disk in place of a CD or a tape drive?
7 Is that correct?

8 DR. CASEY: I would have to look back at the entirety of Dr. Tygar's
9 declaration. I don't know it off the top of my head. If there was evidence,
10 that's where it would be.

11 JUDGE BOALICK: Okay.

12 DR. CASEY: But until the burden shifts to the Applicant with
13 evidence that there is some sort of known association, it's not yet the
14 Applicant's burden to counteract.

15 JUDGE TURNER: But given the fact that we're certainly within our
16 purview to make a new grounds of rejection, why couldn't we look at Akashi
17 alone and say that no computers had both, let's say, a CD-R and a hard disk,
18 and that those were known to a typical user to be equivalent? Why couldn't
19 we just say that we just say that we would substitute that known equivalent
20 into Akashi alone, even if that's not the rejection you may be fighting right
21 now. How would you respond to, let's say, a future rejection?

22 DR. CASEY: Your Honor, I'd have to look at the system that you say
23 you come up with.

24 One of the problems that I find I run into frequently is an Examiner
25 tells me, "I would have combined A and B, and I would have gotten your

1 invention." But what I don't get is, if one of ordinary skill in the art would
2 have taken A and would have taken B -- and don't tell me that you can get
3 my invention. Show me the system that would have resulted. Show me,
4 yes, I would have built this instead. And if once we have the this that could
5 be built, yeah, maybe it reads on the claim, but at least it provides an
6 evidentiary basis for me to say, okay, these are the assumptions you've
7 made, now that you've tried to put together this particular system. And,
8 unfortunately, I don't know that I can speculate on what Akashi, with a CD-
9 ROM writer would have looked like.

10 I guess I can only say that if that's the rejection that comes out, I hope
11 we'll get an opportunity to submit evidence that it wouldn't have been in the
12 form that you're now proposing. And I don't know, in reexamination, what -
13 - when there's a new grounds of rejection after a Board decision what leeway
14 there is for filing declarations, but I hope we would be permitted to do so, in
15 case that's necessary.

16 JUDGE TURNER: Okay. But you certainly would argue against it
17 now?

18 DR. CASEY: I would, Your Honor.

19 JUDGE TURNER: Okay. That's good. If we're going -- when the
20 Board asks you if we can do a new grounds of rejection you should always
21 say no, please don't.

22 DR. CASEY: Yes.

23 JUDGE TURNER: That would be bare minimum.

24 DR. CASEY: Please don't.

25 JUDGE TURNER: Okay.

1 DR. CASEY: Thank you.

2 JUDGE TURNER: I have no further questions.

3 EXAMINER FOSTER: Regarding the obviousness rejections, Cohen
4 is available as prior art. But, even if it wasn't, it would still be available as
5 evidence at that approximate time that the invention was made. And in
6 many cases I relied on explicit motivation to combine the references and
7 they're all susceptible to a *KSR* analysis, as well.

8 JUDGE TURNER: Can I stop you? Just to go back for a second, if
9 it's not available as prior art, how would it be available as motivation?

10 EXAMINER FOSTER: It's available as evidence regarding the state
11 of the art, at approximately the time the invention was made.

12 I'm sorry I can't give you an MPEP cite, but
13 non-prior art is available, even though it isn't prior art as evidence -- state of
14 the art at the approximate time the invention was made. But I do believe it is
15 prior art anyway.

16 I would like to discuss the 112 enablement rejections. And they
17 mostly concern the new video download features added by amendment.

18 The Examiner has argued that the scope and breadth of these claims
19 are not reasonably related to the scope of enablement in the original
20 specification as filed, and that they would have required undue
21 experimentation than they can use.

22 Now, the Appellant had responded by arguing, "It is clear that short
23 videos are enabled and nothing more is required." That's on page 10 of the
24 '402 Reply Brief. And here at the oral arguments they argued that it would
25

1 have enabled a digital picture telephone, and it doesn't even require real-time
2 streaming.

3 Thus, if the Board finds these Appellant arguments persuasive to
4 overcome undue experimentation, the Examiner respectfully asks the Board
5 to consider were the specification enabling nothing more than a short video
6 clip, or a digital picture telephone, or non-real-time streaming would be
7 consummate in scope with the claims, which could literally read on
8 downloaded video the size of feature-length movies, which is an
9 embodiment not sufficiently enabled. And there has been recent Federal
10 Circuit case law moving in this -- to a more strict application of the scope of
11 enablement requirement, specifically, *Lizard Tech*.

12 Nonetheless, the Examiner believes that the parent application as
13 originally filed is insufficient to allow one of ordinary skill in the art to make
14 or use the invention without undue experimentation. The Examiner
15 provided substantial extrinsic evidence to support this. And I would also
16 add that the applied prior art provides intrinsic evidence. The best prior
17 references, I believe, are the intervening patents to Cohen and Yurt. And,
18 once again, those have different dates, and they were using different --

19 JUDGE TURNER: Can I stop you, just to ask another quick
20 question? What you seem to be saying, and please correct me if I'm wrong,
21 is that in order for the claim to be enabled it would have to be enabled for all
22 the embodiments that would fall under the scope of that claim. Is that what
23 you're saying?

24 EXAMINER FOSTER: Yes. But in my -- I think the *Lizard Tech*.
25 case is a good case to look at regarding this issue. The Appellant admitted

1 in the Brief and the admitted here that it disclosed very limited
2 embodiments, like short video clips, digital picture telephones, and non-real-
3 time streaming, yet these claims literally would read on the downloading of
4 full- and true-length movies from the Internet, and that is definitely not --

5 JUDGE TURNER: That seems to be sort of --

6 EXAMINER FOSTER: -- an embodiment that's not enabled by the
7 specification.

8 JUDGE TURNER: That seems like a little bit of a moving target
9 though, isn't it? I mean in order to determine enablement, you'd have to
10 consider all possible embodiments, even embodiments that Appellant -- I
11 mean that the Applicant didn't cite?

12 EXAMINER FOSTER: There has been concern with the patent bar --
13 the Federal Circuit's strict application of scope of enablement.

14 JUDGE TURNER: Okay.

15 EXAMINER FOSTER: Okay. But I still believe that the evidence is
16 sufficient to support that -- the intrinsic evidence that I provided shows that
17 it would have been -- one of ordinary skill in the art at the time of the
18 invention would not have -- not only would it not have been beyond the
19 scope, but one could not have made it without undue experimentation.

20 And, also, the intrinsic evidence, like the Cohen and Yurt prior art.
21 Which the Appellant hasn't rebutted the merits of those -- that prior art as
22 applied to the claims. Both describe audio and video download systems in
23 much more detail. For example, consider figure 4, Cohen, figures 2-A and
24 2-B of Yurt, to figure one of the Hair patents regarding the video server
25 details.

1 Generally, the claims are broadly directed to audio and video
2 download features, and we would expect it to be backed up by a well-
3 written and specific disclosure, which is not the case here.

4 Okay, I wanted to return to the new matter rejection. I was working
5 down a list of reasons why that was not -- did not create an issue to bar the
6 current reexamination. I mentioned that the Examiner never specifically
7 gave a reason why he withdrew, so that was speculation. That reexam sort
8 of conducted on the basis of printed publications, not merely priority issues.
9 But a priority rejection -- a priority determination is distinct from a new
10 matter rejection. And another reason is that the new matter issues addressed
11 by the Examiner are a specific subset of the new matter issues that I
12 addressed in all the reexaminations proceedings regarding priority, and that's
13 illustrated in table 3 of all the Examiner's Answers. Table 3 is in all the
14 Examiner's Answers.

15 The Appellant does make an argument, an unpersuasive argument,
16 about this table. The original Examiner rejected the newly-amended claims
17 and objected to the amendment in the specification.

18 Now the amendment to this specification on December '91 was more
19 extensive than the amendment to the claim, so it's -- I guess it's in the
20 Appellant's interest to interpret this withdrawal as agreeing to the Appellant's
21 support arguments. Thus the Appellant argues, for example, on pages 20
22 and 21 of the Brief in the '402 reexamination that the original Examiner,
23 "Included an objection to the specification as containing new matter under
24 section 132," to which, "the applicant responded to and overcame the
25 objection."

1 I just want to point out there's a problem. That's not what happened.
2 The original Examiner never rejected the -- never objected to the
3 specification under 132, which governs the matter -- the introduction of new
4 matter into the disclosure. Instead, the Examiner objected under 35 U.S.C.
5 112, first paragraph, which might have been incorrect, because 112 covers
6 claim rejections, not objections to the specification, which is normally 132.

7 Thus, a section 132 new matter objection was never raised by the
8 original Examiner, contrary to the Appellant's argument. And, furthermore,
9 the Appellant failed to address the Examiner's objection to the specification,
10 whether under 112, whether that's correct, whether under 132, or otherwise,
11 again, contrary to the Appellant's statement.

12 For example, at page 10 of the June 1992 response, the Appellant
13 states "The specification is objected to under 35 U.S.C. 112, first paragraph,
14 as failing to provide support for the claimed invention." This does not object
15 -- this Appellant response does not address the Examiner's new matter --
16 objection to the new matter being added to the specification.

17 In the subsequent Appellant's arguments and declarations, evidence is
18 then provided to traverse the 112 claim rejections. Thus there is no basis for
19 concluding that a new matter introduced in the specification was ever
20 properly objected to under 132 by the Examiner. And the Appellants
21 mention that it was subjected to 132 during the oral arguments and it wasn't,
22 must less that such an objection was withdrawn in the face of Appellant's
23 argument regarding this objection.

24
25

1 Indeed, there is not a basis to conclusively determine what happened,
2 and that's going back to my original point I was making. This is a problem
3 because the Examiner never explicitly stated what he was doing.

4 JUDGE TURNER: With the patent at issue. Yes. Examiner?

5 EXAMINER FOSTER: Excuse me?

6 JUDGE TURNER: The patent at issue.

7 EXAMINER FOSTER: Yes.

8 JUDGE TURNER: So I'm assuming that was resolved at least
9 somewhat. It's not still pending. So I would -- I understand that you say that
10 the record doesn't provide evidence, but I would think a logical inference to
11 draw would be that it was resolved, at least in the Examiner's mind.

12 EXAMINER FOSTER: What was resolved, I'm sure there issues
13 resolved.

14 JUDGE TURNER: In this case, you said there was a 112 issue that
15 was raised that you said perhaps should have been --

16 EXAMINER FOSTER: Under 132.

17 JUDGE TURNER: -- done as a 132.

18 EXAMINER FOSTER: Yeah, and --

19 JUDGE TURNER: But it would seem like that would have to be
20 resolved, at least in the Examiner's mind, or else she wouldn't have issued --
21 allowed the patent to issue.

22 EXAMINER FOSTER: Well, but --

23 JUDGE BOALICK: Right. In other words, it doesn't seem like a
24 reasonable inference to say that well, the Examiner still thought there was a
25 problem, whether under 132 or 112, first paragraph, and nevertheless,

1 decided to issue the patent. I mean that just -- that doesn't seem to make a
2 lot of sense. It seems like a more reasonable inference would be that that
3 issue was resolved in the Examiner's mind before issuing the patent,
4 especially because it has explicitly been raised.

5 EXAMINER FOSTER: Okay. But I worked through the listed
6 issues, but regarding this issue, I just wanted to conclude by saying table 3 is
7 accurate. It lists -- it states that a subset of new matter issues were addressed
8 by the original Examiner. Not all the new matter issues addressed during
9 this reexamination proceedings.

10 JUDGE BOALICK: Okay.

11 EXAMINER FOSTER: But as far a priority determination.

12 And, finally, regarding the policy issue, it's unfortunate that the
13 prosecution history was unclear, but there was also Applicant behavior
14 introducing and introducing these new matter issues and the specifications
15 and continuations that in some part provoked this.

16 And I understand that Counsel here today is -- you know, were not the
17 Patent Owner and the Attorney who originally prosecuted the case.
18 However, that's what we're left with to work with. Thank you for your
19 consideration. Good day.

20 DR. CASEY: Your Honor, there was a discussion earlier about
21 whether a non-prior art can be used as evidence for motivation purposes,
22 even if it can't be used for prior art purposes.

23 My understanding about the cases where that is true is where a piece
24 of non-prior art says what happened earlier, and that can be used as evidence
25 that such an event might have occurred. But this isn't the case here. We're

1 talking about a later person discovering something that is not applicable as
2 prior art. He's not recounting what happened back in the Roman times and
3 this is a recall of something that happened and that could be a point to be
4 investigated. So my understanding is that Cohen is not properly usable as a
5 motivation in the Bush and Freeny combination.

6 The undue experimentation, it only has to be commensurate in scope
7 with the claims. It's clear that if you had to be able to enable every single
8 embodiment that fell within the scope of the claims you would have to
9 enable things that haven't yet been invented and we'd have to shut the Patent
10 Office down. Because every time somebody invented a car, if it were run on
11 a car with a fuel injector, well nobody has invented the fuel injector yet, so it
12 literally covers a car with a fuel injector. That standard won't work. It just
13 has to be a reasonable scope based on what was available and what was
14 known at the time. Inventors are entitled to broad latitude here.

15 There was a discussion about the intervening patents and that they
16 show enabled technology. Well, one of the things that is important to know
17 is that disclosures there are not some fancy new chips and entered new
18 technology that was suddenly available. It's a combination of older
19 elements. And if the Examiner is saying that these other references which
20 case shortly after were enabled, then I would submit that in fact it's evidence
21 that the claims as originally filed by Applicant prior to those claims are also
22 enabled if they're somewhere in scope.

23 There also was a discussion about whether or not the rejection of the
24 specification should have been under 112 or 132. I think that 132 is the
25 proper standard if the Examiner said 112, and that should have been used for

1 claims and people would have understood that no matter what the grounds
2 was, if it was stated and the Examiner intended it to be the 132, because
3 we're not talking about claims, and 112, first paragraph, relates to claims.
4 So I think that we can't all of a sudden throw out the baby with the bathwater
5 because of the -- the Examiner relied on the wrong section, that she wasn't
6 relying on the right -- on the right process. So trying to make sure that what
7 was in the specification or was added to the specification was in fact part of
8 the original. I think that's all I have.

9 JUDGE TURNER: Questions? Okay.

10 Thank you.

11 DR. CASEY: Thank you, Your Honor.

12 EXAMINER FOSTER: Thank you.

13 (Whereupon, the hearing concluded on June 17, 2009.)

14 Third Party Requester

15 Albert S. Penilla
16 Martine Penilla & Gencarella
17 710 Lakeway Drive
18 Suite 200
19 Sunnyvale, CA 94085

20

21

22

23

24

25



UNITED STATES PATENT AND TRADEMARK OFFICE

UNITED STATES DEPARTMENT OF COMMERCE
United States Patent and Trademark Office
Address: COMMISSIONER FOR PATENTS
P.O. Box 1450
Alexandria, Virginia 22313-1450
www.uspto.gov

Table with 5 columns: APPLICATION NO., FILING DATE, FIRST NAMED INVENTOR, ATTORNEY DOCKET NO., CONFIRMATION NO. Includes details for application 90/007,402, inventor DRINKER BIDDLE & REATH, and examiner FOSTER, ROLAND G.

Please find below and/or attached an Office communication concerning this application or proceeding.

The time period for reply, if any, is set in the attached communication.

UNITED STATES PATENT AND TRADEMARK OFFICE

BEFORE THE BOARD OF PATENT APPEALS
AND INTERFERENCES

Ex parte DMT LICENSING, LLC
Appellant and Patent Owner

Appeal 2009-003609
Reexamination Control No. 90/007,402
U.S. Patent No. 5,191,573
Technology Center 3900

Decided: September 4, 2009

Before JOSEPH F. RUGGIERO, SCOTT R. BOALICK, and
KEVIN F. TURNER, *Administrative Patent Judges*.

BOALICK, *Administrative Patent Judge*

DECISION ON APPEAL

Appeal 2009-003609
Reexamination Control No. 90/007,402
U.S. Patent No. 5,191,573

DMT Licensing, LLC¹ appeals under 35 U.S.C. §§ 134(b) and 306 from a final rejection of claims 1-6 and 44-49.² We have jurisdiction under 35 U.S.C. §§ 134(b) and 306.

We heard oral arguments on June 17, 2009, a written transcript of which is included in the record.

We REVERSE.

STATEMENT OF THE CASE

This proceeding arose from a request for *ex parte* reexamination filed by Napster, Inc. on January 31, 2005, of United States Patent 5,191,573 (the '573 patent) issued to Arthur R. Hair on March 2, 1993, based on United States Patent Application 07/586,391, filed September 18, 1990.

The instant appeal is related to appeals of two other copending reexaminations: 90/007,403 and 90/007,407. The former reexamination is made with respect to United States Patent 5,675,734 (the '734 patent, Appeal No. 2009-003457) and the latter with respect to United States Patent 5,966,440 (the '440 patent, Appeal No. 2009-003459). The relations between the issued patents and their applications are illustrated in the chart below:

¹ DMT Licensing, LLC is said to be the real party in interest and current owner of the patent under reexamination. (App. Br. 2.) DMT Licensing, LLC is said to be a wholly-owned subsidiary of GE Intellectual Property Licensing, Inc., which is said to be a wholly-owned subsidiary of General Electric Co. (App. Br. 2.)

² Claims 7-43 have been cancelled.

Appeal 2009-003609
 Reexamination Control No. 90/007,402
 U.S. Patent No. 5,191,573

Appeal No.	Filing Date	Patent No.	Relationship
07/206,497 ("Parent" application)	Jun. 13, 1988	abandoned	-
07/586,391 ("Child" application)	Sep. 18, 1990	5,191,573	Continuation of '497
08/023,398	Feb. 26, 1993	abandoned	Continuation of '391
08/471,964	Jun. 6, 1995	5,966,440	Continuation of '398
08/607,648	Feb. 27, 1996	5,675,734	Continuation of '398

Patentee's invention relates to a system and an associated method for electronic sales and distribution of digital audio or video signals ('573 patent, col. 1, ll. 9-14). A first party, having authorization to distribute digital audio or video, transfers electronically digital copies of the same to a second party for storage in a local memory after a fee has been charged (*id.* at col. 3, l. 60 to col. 6, l. 2).

Claim 1, which we deem to be representative, reads as follows:

1. A method for transmitting a desired digital audio signal stored on a first memory of a first party to a second memory of a second party comprising the steps of:

transferring money electronically via a telecommunication line to the first party at a location remote from the second memory and controlling use of the first memory from the second party financially

Appeal 2009-003609
Reexamination Control No. 90/007,402
U.S. Patent No. 5,191,573

distinct from the first party, said second party controlling use and in possession of the second memory;

connecting electronically via a telecommunications line the first memory with the second memory such that the desired digital audio signal can pass there-between;

transmitting the desired digital audio signal from the first memory with a transmitter in control and possession of the first party to a receiver having the second memory at a location determined by the second party, said receiver in possession and control of the second party; and

storing the digital signal in a non-volatile storage portion of the second memory, wherein the non-volatile storage portion is not a tape or CD.

The prior art references relied upon by the Examiner in rejecting the claims are:

Freeny ("Freeny II") ³	4,528,643	Jul. 9, 1985
Bush	4,789,863	Dec. 6, 1988 (filed Jan. 13, 1988)
Freeny ("Freeny I")	4,837,797	Jun. 6, 1989 (filed Jan. 27, 1988)
Cohen	4,949,187	Aug. 14, 1990 (filed Dec. 16, 1988)

³ The "Freeny II" and "Freeny I" designations are used by both the Examiner and the Appellant. For consistency, we adopt the same terminology.

Appeal 2009-003609
Reexamination Control No. 90/007,402
U.S. Patent No. 5,191,573

(7) Claims 1-6 and 44-49 stand rejected under 35 U.S.C. § 103(a) as being unpatentable over Akashi and Freeny II.

ISSUES

Appellant contends that the Examiner is acting outside the scope of the Examiner's authority in the review and resulting reassignment of a priority date for the instant claims and, in any event, the claims of the '573 patent find support in the earlier-filed application (App. Br. 14-25). Appellant also argues that the Examiner has applied improper and overly strict standards for both written description and enablement (App. Br. 26-29, 36-39) and that any inquiry into the written description and enablement support for the claims should be limited to newly-claimed subject matter (App. Br. 41-42). Appellant contends that, in any event, the claims find support in the Specification (App. Br. 29-36, 39-44). With respect to the prior art rejections that apply Cohen under § 102 and § 103, Appellant argues that these rejections are improper because Cohen is not prior art (App. Br. 40, 44-46). Regarding the prior art rejection over Bush and Freeny I, Appellant argues that the Examiner has not established a prima facie case of obviousness because "*Freeny I* bears no relation to the disclosure of *Bush*" (App. Br. 47) and because the Examiner cited to Cohen, which Appellant contends is not prior art, in order to show motivation to combine the references (App. Br. 46-47). Regarding the prior art rejection over Akashi and Freeny II, Appellant contends that the combined references

Appeal 2009-003609
Reexamination Control No. 90/007,402
U.S. Patent No. 5,191,573

do not teach or suggest transmitting digital audio or video signals from a first memory to a second memory and storing these signals on a non-volatile storage portion of a second memory that is not a tape or CD and that is in possession and control of a second party (App. Br. 48-50). In addition, Appellant argues that the Examiner has not provided a sufficient reason to combine the teachings of Akashi and Freeny II (App. Br. 50-51). Appellant further points to secondary considerations of non-obviousness with respect to the § 103 rejections (App. Br. 51-54).

The Examiner finds that the application of the intervening prior art is justified because the instant claims are not entitled to the benefit of a filing date of an earlier-filed application (Ans. 5-19, 40-68). The Examiner defends the application of the written description and enablement standards applied (Ans. 20-27, 64-69). The Examiner also made specific findings of support for specific claim elements in the Examiner's "Table I. New Matter Chart" (Ans. 8, 9). In addition, the Examiner defends the substance of the prior art rejections (Ans. 28-40, 69-76).

Only those arguments actually made by Appellant have been considered in this decision. Arguments which Appellant did not make in the Briefs have not been considered and are deemed to be waived. *See* 37 C.F.R. § 41.37(c)(1)(vii).

Appeal 2009-003609
Reexamination Control No. 90/007,402
U.S. Patent No. 5,191,573

The issues arising from the respective positions of Appellant and the Examiner are:

1) Has Appellant shown reversible error in the Examiner's determination that the instant claims are not entitled to the benefit of priority of a filing date of an earlier-filed application?

2) Has Appellant shown reversible error in the Examiner's determination that claims 1-6 and 44-49 are not supported under 35 U.S.C. § 112, first paragraph, in accordance with the written description requirement?

3) Has Appellant shown reversible error in the Examiner's determination that claims 4-6 and 47-49 are not supported under 35 U.S.C. § 112, first paragraph, in accordance with the enablement requirement?

4) Has Appellant shown reversible error in the Examiner's rejections of various claims as anticipated by Cohen or obvious over various combinations of Cohen and Bush?

5) Has Appellant shown reversible error in the Examiner's rejection of various claims under 35 U.S.C. § 103(a) as anticipated by the combination of Bush and Freeny I or the combination of Akashi and Freeny II?

FINDINGS OF FACT

1. The '573 patent describes a system and an associated method for electronic sales and distribution of digital audio or video signals ('573 patent, col. 1, ll. 9-14). A first party, having authorization to distribute digital audio or video stored on a first memory of the first party, transfers electronically digital copies of the same to a second party for storage in a local memory (second memory) after a fee has been charged (*id.* at col. 3, l. 60 to col. 6, l. 2; Abstract).
2. The '573 patent describes transferring money electronically via a telecommunication line to the first party at a location remote from the second memory and controlling use of the first memory from the second party, where the second party is financially distinct from the first party (*id.* at col. 2, ll. 63-67; col. 3, ll. 6-8; col. 5, ll. 32-34; Abstract).
3. The '573 patent further describes electronically connecting the first memory with the second memory via a telecommunications line such that the desired digital audio signal can pass there-between (*id.* at col. 2, ll. 51-67; col. 3, ll. 8-12; Abstract; Fig. 1).
4. The '573 patent describes transmitting the desired digital audio signal from the first memory with a transmitter that is in control

Appeal 2009-003609
Reexamination Control No. 90/007,402
U.S. Patent No. 5,191,573

and possession of the first party to a receiver having the second memory at a location determined by the second party, where the receiver is in the possession and control of the second party (*id.* at col. 2, l. 51-67; col. 3, ll. 13-19 & 60-67; col. 4, ll. 25-44; Abstract; Fig. 1).

5. The '573 patent describes storing the digital signal in a non-volatile storage portion of the second memory, where the non-volatile storage portion is not a tape or CD (*id.* at col. 2, ll. 31-35; col. 3, ll. 17-19; col. 4, ll. 41-43; Abstract).

Appeal 2009-003609
 Reexamination Control No. 90/007,402
 U.S. Patent No. 5,191,573

6. The following is a reproduction of the Examiner's "Table I. New Matter Chart" (Ans. 8-9):

Table I. New Matter Chart

Feature	Parent Appn. 07/206,497, filed 6/13/88 (Abandoned)		Child Appn. 07/586,391, filed 9/18/90 (5,191,573)	
	Date First Appearing in Claims of Parent Appn.	Date First Appearing in Spec. of Parent Appn.	Date First Appearing in Claims of Child Appn.	Date First Appearing in Spec. of Child Appn.
Hard Disk/Control Unit of Seller/User	Filing Date of the Original Application -- 6/13/88	Filing Date of the Original Application -- 6/13/88		Filing Date of the Child Application -- 9/18/90
Electronic sales and distribution of the music.				
Broad Statement at end of spec. regarding Video Applicability, Note *		Filing Date of the Original Application -- 6/13/88		Filing Date of the Child Application -- 9/18/90
Transferring Money from Second Party to a First Party (Charging a Fee)	12/22/88 (12/28/90)		Filing Date of the Child Application -- 9/18/90	12/11/91
Providing a Credit Card Number	12/22/88		Filing Date of the Child Application -- 9/18/90	
Controlling Use of First/Second Memory	12/22/88		Filing Date of the Child Application -- 9/18/90	12/11/91
Transmitting to a Location Determined by Second Party	7/28/90		Filing Date of the Child Application -- 9/18/90	12/11/91
Specific Video Download Procedures	7/28/90		Filing Date of the Child Application -- 9/18/90	12/11/91 New **
First Party in Possession of Transmitter	8/24/90, but not entered		Filing Date of the Child Application -- 9/18/90	12/11/91
Second Party in Possession of Receiver and Second Memory	8/24/90, but not entered		Filing Date of the Child Application -- 9/18/90	12/11/91

Key: Clear row means original matter present in the original Parent application. Shaded row means new matter introduced by amendment into both the Parent and Child applications subsequent to the date of the original Parent application.

Note * - The original specification also describes using a "nonverbal visual display of the user's library of songs" (page 5), however this section appears to relate to displaying category/physical information to the user regarding downloaded audio content, and not directed to the actual download, processing, and display of video content.

Appeal 2009-003609
 Reexamination Control No. 90/007,402
 U.S. Patent No. 5,191,573

7. The following is a reproduction of a chart provided by Appellant in rebuttal to the Examiner's Table I in order to demonstrate that the original Examiner had previously considered the same new matter issues during the original prosecution of the '573 patent (App. Br. 20-21).

Feature	Parent Application 07/206,497 filed June 13, 1988		Child Application 07/586,391 filed September 18, 1990		Office Action in Application 87/586,391 and response		Essence of '573 Patent
	Date First Appearing in Claims of Parent Application	Date First Appearing in Specification of Parent Application	Date First Appearing in Claims of Child Application	Date First Appearing in Specification of Child Application	Consideration by Examiner Nguyen	Response by Applicant	
Transferring Money from Second Party to a First Party (Charging a Fee)	December 22, 1988 February 28, 1990			September 18, 1990	Considered in Office Action February 24, 1992	Objection/ rejections specifically responded to in June 25, 1992 response	Claims allowed in September 21, 1992 Office Action
Providing a Credit Card Number	December 22, 1988			September 18, 1990	Considered in Office Action February 24, 1992	Objection/ rejections specifically responded to in June 25, 1992 response	Claims allowed in September 21, 1992 Office Action
Controlling Use of First/Second Memory	December 22, 1988			September 18, 1990	Considered in Office Action February 24, 1992	Objection/ rejections responded to in June 25, 1992 response	Claims allowed in September 21, 1992 Office Action

Appeal 2009-003609
 Reexamination Control No. 90/007,402
 U.S. Patent No. 5,191,573

Transmitting to a Location Determined by Second Party	February 28, 1990			September 18, 1990	Considered in Office Action February 24, 1992	Objection/ rejections responded to in June 25, 1992 response	Claims allowed in September 21, 1992 Office Action
Specific Video Download Procedures	February 28, 1990			September 18, 1990	No new matter issues were ever raised	No response was ever necessary since no issue was ever raised	Claims allowed in September 21, 1992 Office Action
First Party in Possession of Transmitter	August 24, 1990 (not entered)			September 18, 1990	Considered in Office Action February 24, 1992	Objection/ rejections responded to in June 25, 1992 response	Claims allowed in September 21, 1992 Office Action
Second Party in Possession of Receiver and Second Memory	August 24, 1990 (not entered)			September 18, 1990	Considered in Office Action February 24, 1992	Objection/ rejections specifically responded to in June 25, 1992 response	Claims allowed in September 21, 1992 Office Action

Bush

8. Bush describes a pay-per-view entertainment system where subscribers have a receiver that is capable of receiving previews of musical works and, if the subscriber wants to make a recording of the complete work, the subscriber enters appropriate data, the receiver records the desired selection, and a service charge for recording the selection is automatically charged to the subscriber. (Col. 1, ll. 9-13, 45-64.) Bush states that, although the preferred embodiment is for prerecorded musical works, the invention could also apply to video recordings. (Col. 2, ll. 23-27.) For recording

the desired selection, Bush teaches that "[t]he audio signals are recorded on a cassette recording unit." (Col. 4, ll. 7-11.) Bush also teaches that the desired digital audio may be "recorded on an audio cassette or CD at the subscriber's receiver 100." (Col. 5, ll. 25-29; Fig. 5.)

Freeny I

9. Freeny I is directed to an electronic message unit that receives incoming calls, determines whether the incoming message is machine-interpretable or a voice message, and, respectively, either outputs the machine-interpretable message without causing an audible ringing of the telephone or outputs a ring signal for voice messages. (Abstract.) In one embodiment, "the electronic message unit 10 includes a message storage 44 which is a storage device adapted to receive and store machine interpretable messages in a storage medium which may be a memory electronic chip, video tape, hard disk or floppy disk." (Col. 5, ll. 20-25; Fig. 1.)

Akashi

10. Akashi describes an automated music purchasing system that uses telephone lines to transmit recorded music data from a host computer to a recording/recording reproduction device on a personal computer. (Specification "2. Claims:"; "3. Detailed

Explanation of the Invention: (4) Means for Solving the Problems.") Akashi teaches that the recording/reproducing device (1) can use recordable optical disks or a digital audio tape recorder. (Specification "3. Detailed Explanation of the Invention: (6) Embodiment.")

Freeny II

11. Freeny II describes a system for reproducing information in material objects at a point-of-sale location where the information is provided from a remote location. (Abstract.) Freeny II teaches that an owner authorization code is provided to the point-of-sale location in response to a request to reproduce information in a material object, and that the information is reproduced in the material object in response to receiving the owner authorization code. (Abstract.) The material object is described as including a cassette tape, floppy disk, 8-track tape, reel-to-reel tape, and video disk. (Col. 4, ll. 36-55.)

12. Freeny II teaches that an information control machine 12 stores information and receives reproduction requests for the stored information at a particular information manufacturing machine (IMM) 14. (Col. 5, ll. 1-7; Fig. 1.) The IMM 14 receives encoded information via a communication link 18 or 20, stores the received

Appeal 2009-003609
Reexamination Control No. 90/007,402
U.S. Patent No. 5,191,573

encoded information, decodes information in response to receiving an authorization code, and provides decoded information to a reproduction unit 24 via an output line 22. (Col. 5, ll. 21-30; Fig. 1.) The reproduction unit 24 reproduces received information in a material object. (Col. 5, ll. 30-31; Fig. 1.)

PRINCIPLES OF LAW

Under the written description requirement of 35 U.S.C. § 112, first paragraph, the disclosure of the application relied upon must reasonably convey to the artisan that, as of the filing date of the application, the inventor had possession of the later-claimed subject matter. *Vas-Cath, Inc. v. Mahurkar*, 935 F.2d 1555, 1562-63 (Fed. Cir. 1991).

Under 35 U.S.C. § 120, "in a chain of continuing applications, a claim in a later application receives the benefit of the filing date of an earlier application so long as the disclosure in the earlier application meets the requirements of 35 U.S.C. § 112, ¶ 1, including the written description requirement, with respect to that claim." *Tech. Licensing Corp. v. Videotek, Inc.*, 545 F.3d 1316, 1326 (Fed. Cir. 2008) (citing *Transco Prods., Inc. v. Performance Contracting, Inc.*, 38 F.3d 551, 556 (Fed. Cir. 1994)). "Although § 120 incorporates the requirements of § 112 ¶ 1, these requirements and the statutory mechanism allowing the benefit of an earlier filing date are separate provisions with distinct consequences. In accordance with § 120, claims to subject matter in a later-filed application not supported

Appeal 2009-003609
Reexamination Control No. 90/007,402
U.S. Patent No. 5,191,573

by an ancestor application in terms of § 112 ¶ 1 are not invalidated; they simply do not receive the benefit of the earlier application's filing date." *Reiffin v. Microsoft Corp.*, 214 F.3d 1342, 1346 (Fed. Cir. 2000).

Under the enablement requirement of 35 U.S.C. § 112, first paragraph, the specification of a patent must enable any person skilled in the art to which it pertains to make and use the claimed invention. Although the statute does not say so, enablement requires that the specification teach those in the art to make and use the invention without "undue experimentation." *In re Wands*, 858 F.2d 731, 737 (Fed. Cir. 1988). Whether undue experimentation is required is a conclusion reached by weighing several underlying factual inquiries. *Id.*

"Section 103 forbids issuance of a patent when 'the differences between the subject matter sought to be patented and the prior art are such that the subject matter as a whole would have been obvious at the time the invention was made to a person having ordinary skill in the art to which said subject matter pertains.'" *KSR Int'l Co. v. Teleflex, Inc.*, 550 U.S. 398, 406 (2007). "[R]ejections on obviousness grounds cannot be sustained by mere conclusory statements; instead, there must be some articulated reasoning with some rational underpinning to support the legal conclusion of obviousness." *In re Kahn*, 441 F.3d 977, 988 (Fed. Cir. 2006). "To facilitate review, this analysis should be made explicit." *KSR*, 550 U.S. at 418.

Appeal 2009-003609
Reexamination Control No. 90/007,402
U.S. Patent No. 5,191,573

ANALYSIS

Rejections under 35 U.S.C. § 112, first paragraph

We begin by noting that the process of determining whether a claim for the benefit of an earlier filing date under 35 U.S.C. § 120 is proper and supported is separate from the process of determining whether claims are enabled by and have written description support in the application in which they are presented. *See Reiffin v. Microsoft Corp.*, 214 F.3d 1342, 1346 (Fed. Cir. 2000) (holding District Court erred in looking to prior application in chain of continuing applications for support under § 112 of claims granted in two later applications). While the former requires an analysis under 35 U.S.C. § 112, first paragraph, to determine whether there is adequate written description in the cited application to support claims in the subject application, the latter is divorced from considerations of an earlier filing date. In other words, claims should be analyzed to determine whether they lack written description support or enablement with respect to the originally filed application in which they are presented. Determining whether such claims can claim the benefit of an earlier filing date is a separate inquiry. *See id.*; *see also* MPEP § 201.11.

The Examiner's analysis suggests adequate written description and enablement should rest with the parent application for an individual claim in a child application to be supported under 35 U.S.C. § 112, first paragraph. The Examiner argues that the original claims of the instant child patent are not entitled to the benefit of the filing date of its parent because the written

Appeal 2009-003609
Reexamination Control No. 90/007,402
U.S. Patent No. 5,191,573

description of the parent does not support features in the instant claims of the child (Ans. 7-11). Thus, according to the Examiner, support for the instant claims would need to be found in the earlier-filed "parent" application, i.e., 07/206,497, to have adequate support under 35 U.S.C. § 112, first paragraph. We do not agree.

At Oral Hearing in a related case discussing the same issue in the present case, the Examiner responded as follows:

JUDGE BOALICK: . . . as I read the Examiner's answer, it appears that you're saying that there is no written description or enablement in the [parent application, as opposed to the particular application in which these claims arise. Is that – am I reading you answer correctly?

EXAMINER FOSTER: Yes.

(Oral Hr'g Transcript of 90/007,407, 12:14-18.)

In addition, the Examiner cites MPEP §§ 2258 and 2163.1 (Ans. 20), but those sections are directed to performing analysis for 35 U.S.C. § 112, first paragraph, under different circumstances. Any determination of whether the instant claims have support under 35 U.S.C. § 112, first paragraph, should be made with respect to the instant Specification, i.e., the '573 patent. From our review of the '573 patent Specification and claims, we find no aspect of the instant claims that is unsupported by the instant Specification in terms of written description and/or enablement (*see* FF 1-5).

Specific to new and amended claims which contain a negative limitation, e.g., claim 35 which recites "a non-volatile storage portion of the second memory . . . wherein the non-volatile storage portion is not a tape or

Appeal 2009-003609
Reexamination Control No. 90/007,402
U.S. Patent No. 5,191,573

CD", the Examiner argues that such a limitation has no basis in the original disclosure (Ans. 22-23). The Examiner makes reference to a lack of support in the "parent application" (Ans. 22), which is improper. Similarly, the Examiner's rejection for lack of enablement also discusses the "parent application," and talks about requiring undue experimentation to enable the large size files required for digital video (Ans. 23-27). Again, rejections under 35 U.S.C. § 112, first paragraph, should be made with respect to the Specification that is filed with the subject claims. As such, the Examiner's rejection of claims 1-6 and 44-49 under 35 U.S.C. § 112, first paragraph, as failing to comply with the written description requirement and the Examiner's rejection of claims 4-6 and 47-49 under 35 U.S.C. § 112, first paragraph, as failing to comply with the enablement requirement were made in error.

Claims of Priority Under 35 U.S.C. § 120

The Examiner finds, with reference to Table I (Ans. 8-9), "that a significant amount of new text (directed to various features) added in a series of amendments is not found in the Parent application as originally filed," (Ans. 7) and concludes that "Appellant failed to provide adequate support for all the new text added by the series of amendments (as identified in Table I above) to the Parent and Child applications" (Ans. 9). The Examiner's "Table I. New Matter Chart," (FF 6) looks at the presence of certain features in the "Parent" application and the "Child" application and

Appeal 2009-003609
Reexamination Control No. 90/007,402
U.S. Patent No. 5,191,573

asserts that many features claimed in the "Child" application are not supported in the "Parent" application. (FF 6.)

Appellant provides a detailed description of the original prosecution history of the '573 patent before the original Examiner (App. Br. 9-13, 19-23) and a summary chart (FF 7) in order to demonstrate that the priority date of the claims was previously considered by the original Examiner and is not a new issue. We find the Appellant's evidence and arguments to be more persuasive than the Examiner's. The fact that "a significant amount of new text" (Ans. 7) was added to the specification is not necessarily dispositive of whether new matter has been added. The Examiner points out that during the original prosecution, specifically in the Office Action mailed February 24, 1992, "[t]he original Examiner never rejected -- never objected to the specification under [35 U.S.C.] 132, which governs the matter -- the introduction of new matter into the disclosure. Instead, the [original] Examiner objected [to the Specification] under 35 U.S.C. 112, first paragraph." (Oral Hr'g Transcript 12:2-5; *see also* Ans. 56-57.) However, the Examiner also recognized that this "might have been incorrect, because 112 covers claim rejections, not objections to the specification, which is normally 132." (Oral Hr'g Transcript 12:5-6.) The original Examiner's reference to § 112, first paragraph, rather than § 132 in objecting to the Specification appears to be a typographical error, especially because the original Examiner also rejected the claims under § 112, first paragraph, "for the reasons set forth in the objection to the specification" (Office Action

Appeal 2009-003609
Reexamination Control No. 90/007,402
U.S. Patent No. 5,191,573

mailed Feb. 24, 1992, at 5-6). That the original Examiner allowed the application after the Applicant's response to the objection indicates to us that the original Examiner believed the issue to be resolved. An inference to the contrary would not be reasonable.

The Examiner also argues that descriptions of video download features are not supported by the parent application (Ans. 15-19; *see also* FF 6), specifically that the originally disclosed audio transmission features fail to imply or require any video transmission features. While the Examiner emphasizes that, circa 1988, devices capable of decoding and playing back digital video, storage for the same, and distribution channels of adequate bandwidth did not exist, we find more compelling Appellant's arguments that the Examiner is importing aspects into the claims (Reply Br. 10-15). Appellant argues correctly that the claims do not specify quality, size or bandwidth required for the video signals, and assuming the same to show inadequacy of disclosure is improper (*id.*).

In connection with the discussion above, Appellant argues that the priority date for claims in the instant patent is not a new issue related to patentability (App. Br. 19-25) because the original Examiner assigned a priority date of June 13, 1988 to the claims of the '573 Patent and the Office lacks jurisdiction to review again those issues determined by the original Examiner (*id.*). The Examiner emphasizes that where the sufficiency of the patent application has not been originally decided, the proper priority date to

Appeal 2009-003609
Reexamination Control No. 90/007,402
U.S. Patent No. 5,191,573

assign to claims is within the purview of the reexamination process
(Ans. 40-63).

Central to this issue is whether *Patlex Corp. v. Quigg*, 680 F. Supp. 33 (D.D.C. 1988), is controlling. In that case, the patent holder sought review of a Board decision affirming the rejection of claims in a reexamination proceeding. A first examiner found a "great-grandparent" application provided an enabling disclosure to a "great-grandchild" application, which issued as the patent. During the reexamination proceedings, a second examiner reconsidered the merits of the first examiner's decision in order to make a rejection based on intervening prior art. However, the court found that "the reexamination statute does not contemplate a 'reexamination' of the sufficiency of a disclosure." *Id.* at 37. The court further found that the Examiner and the Board lacked jurisdiction to reexamine the sufficiency of the specification of the "great-grandparent" application. *Id.*

The Examiner finds that *Patlex* differs from the instant case in several ways (Ans. 62-63). The Examiner finds that, in *Patlex*, the specifications of the "great-grandparent" and "great-grandchild" applications were essentially identical, and that the claims were drawn to the same invention (Ans. 63). The Examiner finds this to be in contradistinction to the instant case where a "substantial amount" of new text was added to both the Specification and the claims (Ans. 63). However, as discussed *supra*, we do not find even a substantial amount of added matter to be dispositive of whether there was proper written description for that added matter. As discussed, the Examiner

Appeal 2009-003609
Reexamination Control No. 90/007,402
U.S. Patent No. 5,191,573

has not shown that the claims, including the recitations to digital video, are not supported by adequate written description to show that the Appellant did not have possession of the same by the time of filing of the Parent application on June 13, 1988. As such, we do not find the Examiner's distinctions between *Patlex* and the instant case to be compelling.

The Examiner also cites *Ex parte Basell*, Appeal No. 2007-0111 (BPAI 2007), *aff'd on other grounds, In re Basell Poliolefine Italia S.P.A.*, 547 F.3d 1371 (Fed. Cir. 2008), as allowing for a rejection based on intervening art because the filing date of the continuation was not entitled to the filing date of the parent (90/007,403 Oral Hr'g Transcript 14:14-21). In the Board's decision, the original examiner never considered the substantive issues of patentability of the claims over a specific piece of prior art because the examiner mistakenly accorded the claims an earlier filing date sufficient to antedate the prior art reference. *Ex parte Basell*, slip op. at 46-47 (BPAI 2007), available at <http://des.uspto.gov/Foia/ReterivePdf?system=BPAI&fINm=fd2007011103-29-2007>. The Board's decision distinguished *Patlex* by saying that, in that case, the specifications were identical and that the original examiner had determined that the original disclosure enabled the subject patent's claims. *Id.*, slip op. at 54. It is on this latter basis that the panel in *Basell* distinguishes and we do not.

As Appellant has argued and we have discussed above, the original application faced a new matter rejection, which was overcome. Thus, similar to *Patlex* and distinguishable from *Basell*, the original Examiner in

Appeal 2009-003609
Reexamination Control No. 90/007,402
U.S. Patent No. 5,191,573

the application for the instant patent considered whether the added texts were new matter and subsequently concluded they were not, such that the patent was allowed to issue. As such, under 35 U.S.C. §§ 301-302, 37 C.F.R. § 1.552(a), 37 C.F.R. § 1.552(c), and MPEP § 2258, the Examiner cannot be allowed to reexamine the sufficiency of the Specification.

*Prior Art Rejections over Cohen and
Various Combinations of Cohen and Bush*

The anticipation rejection under 35 U.S.C. § 102(e) is over Cohen and two of the rejections under 35 U.S.C. § 103(a) rely on Cohen in combination with Bush. As discussed above, we find that the Examiner has not shown that the instant claims are not entitled to the benefit of the application filed June 13, 1988, i.e., the 07/206,497 application. As Appellant argues (App. Br. 40, 44-46), Cohen is not prior art because Cohen issued from an application filed December 16, 1988. Thus, Cohen cannot be considered prior art to the instant claims under 35 U.S.C. §§ 102 and 103. We find, therefore, that the prior art rejections that rely on Cohen are improper and that the Examiner erred in rejecting the claims over the same.

Prior Art Rejection over Bush and Freeny I

The Examiner finds that Bush fails to teach or suggest storing a digital signal in a non-volatile storage portion of the second memory that is not a tape or CD. (Ans. 31, 33.) The Examiner finds that "Freeny I (similarly to

Appeal 2009-003609
Reexamination Control No. 90/007,402
U.S. Patent No. 5,191,573

Bush) teaches of a device that receives and stores audio data (abstract) and that also stores the received messages on a non-volatile storage portion that is not a tape or a CD (e.g., a hard disk) (col. 5, ll. 20-25)." (Ans. 33.)

Almost identically to the rationale presented in support of the combination of Bush and Cohen (Ans. 31-32), but absent the quotations from Cohen (Ans. 31), the Examiner states that:

The suggestion/motivation for adding the hard disk as taught by Freeny I to Bush would have been to more efficiently access audio and video files because magnetic media, such as hard disk drives permit an almost unlimited number of read/write cycles. Storing data on magnetic media, such as a hard-disk, would have also increased the security and reliability of the stored data because magnetic, hard disks retain data when the power to the unit is removed (i.e., non-volatile) as would have been notoriously well-known in the art at the time the invention was made.

(Ans. 34.)

We generally agree with Appellant that the Examiner has not established a prima facie case of obviousness. We agree with Appellant that the Examiner appears to have improperly used Cohen in setting forth the rationale to combine Bush and Freeny I. At oral argument, the Examiner asserted that, in accordance with the MPEP, even if Cohen was not prior art "it would still be available as evidence at that approximate time that the invention was made." (Oral Hr'g Transcript 8:4-5.) We do not agree. MPEP § 2141.03 cites *Ex parte Erlich*, 22 USPQ 1463 (BPAI 1992) for the proposition that "[r]eferences which do not qualify as prior art because they

Appeal 2009-003609
Reexamination Control No. 90/007,402
U.S. Patent No. 5,191,573

postdate the claimed invention may be relied upon to show the level of ordinary skill in the art at or around the time the invention was made." However, *Ex parte Erlich* involved a situation where a later, non-prior art reference discussed the state of the art at a relevant, earlier, time period of the prior art. The current situation is distinguishable because the Examiner has not shown where Cohen discusses the state of the art at or prior to the time of the current invention. Thus, relying on Cohen for motivation to combine Bush and Freeny I is improper. Also, the Examiner has not shown that one of ordinary skill in the art at the time of the invention would have considered the hard disk of the answering machine of Freeny I (FF 9) to be equivalent to the audio tape and CD of the pay-per-view system of Bush (FF 8). Accordingly, we find that Appellant has shown error in this rejection.

Prior Art Rejection over Akashi and Freeny II

The Examiner finds that "Akashi discloses that the digital music data is purchased automatically but does not expressly detail how the purchase is transacted and whether the data is stored on a non-volatile storage portion of the second memory that is not a tape or a CD." (Ans. 38.) However, the Examiner finds that Freeny II cures these deficiencies, and in particular finds that "Freeny II also discloses that the received audio and video data is stored on a non-volatile storage that is not a tape or CD (e.g., a hard disk) (col. 5, l. 23-25)." (Ans. 38.)

Appeal 2009-003609
Reexamination Control No. 90/007,402
U.S. Patent No. 5,191,573

We generally agree with Appellant that the combination of Akashi and Freeny II does not teach or suggest storing the digital signal in a non-volatile portion of the second memory that is not a tape or CD, where the second memory is controlled by and in the possession of the second party. The Examiner cites (Ans. 38) the teaching in Freeny II of the IMM 14 storing encoded information received from the information control machine 12 prior to decoding this information and reproducing it in a material object using the reproduction unit 24 (FF 12). However, we agree with Appellant that the IMM 14 is under the control and in the possession of the first party, not the second party purchasing the material object. In addition, given the very different manner in which the systems of Akashi and Freeny II function (*see* FF 10-12), we agree with Appellant that the Examiner has not sufficiently articulated a rationale for modifying the system of Akashi with the teachings of Freeny II.

CONCLUSIONS

Appellant has shown that the Examiner reversibly erred in determining that:

- (1) Claims 1-6 and 44-49 fail to comply with the written description requirement of 35 U.S.C. § 112, first paragraph;
- (2) Claims 4-6 and 47-49 fail to comply with the enablement requirement of 35 U.S.C. § 112, first paragraph;

Appeal 2009-003609
Reexamination Control No. 90/007,402
U.S. Patent No. 5,191,573

(3) Claims 1-6 and 44-49 are unpatentable over Bush and Cohen under 35 U.S.C. § 103(a);

(4) Claims 1-6 and 44-49 are unpatentable over Bush and Freeny I under 35 U.S.C. § 103(a);

(5) Claims 1, 2, 4, 5, 44, 45, 47, and 48 are anticipated by Cohen under 35 U.S.C. § 102(e);

(6) Claims 3, 6, 46, and 49 are unpatentable over Cohen and Bush under 35 U.S.C. § 103(a); and

(7) Claims 1-6 and 44-49 are unpatentable over Akashi and Freeny II under 35 U.S.C. § 103(a).

DECISION

The decision of the Examiner to reject claims 1-6 and 44-49 is REVERSED.

REVERSED

bim

cc:

Appeal 2009-003609
Reexamination Control No. 90/007,402
U.S. Patent No. 5,191,573

FOR PATENT OWNER:

DRINKER BIDDLE & REATH, LLP
ATTN: INTELLECTUAL PROPERTY GROUP
ONE LOGAN SQUARE
SUITE 2000
18TH AND CHERRY STREETS
PHILADELPHIA, PA 19103-6996

FOR THIRD PARTY REQUESTER:

ALBERT S. PENILLA
MARTINE PENILLA & GENCARELLA, LLP
710 LAKEWAY DRIVE, SUITE 200
SUNNYVALE, CA 94085

Litigation Search Report CRU 3999

Reexam Control No. 90/007,402

TO: Foster, Roland
Location: CRU
Art Unit: 3992
Date: 02/17/10

From: Sharon S. Hoppe
Location: CRU 3999
MDW 7C84
Phone: (571) 272-1586

Case Serial Number: 90/007,402

Sharon.hoppe@uspto.gov

Search Notes

U.S. Patent No. 5,191,573

- 1) I performed a KeyCite Search in Westlaw, which retrieves all history on the patent including any litigation.
- 2) I performed a search on the patent in Lexis CourtLink for any open dockets or closed cases.
- 3) I performed a search in Lexis in the Federal Courts and Administrative Materials databases for any cases found.
- 4) I performed a search in Lexis in the IP Journal and Periodicals database for any articles on the patent.
- 5) I performed a search in Lexis in the news databases for any articles about the patent or any articles about litigation on this patent.

Litigation was found.

2:04cv1549 Closed



Date of Printing: Feb 17, 2010

KEYCITE

H US PAT 5191573 METHOD FOR TRANSMITTING A DESIRED DIGITAL VIDEO OR AUDIO SIGNAL, (Mar 02, 1993)

History**Direct History**

- => 1 **METHOD FOR TRANSMITTING A DESIRED DIGITAL VIDEO OR AUDIO SIGNAL**, US PAT 5191573, 1993 WL 1138260 (U.S. PTO Utility Mar 02, 1993) (NO. 07/586391)
Construed by
- H** 2 SightSound.Com Inc. v. N2K, Inc., 185 F.Supp.2d 445, 2002 Markman 229872 (W.D.Pa. Feb 08, 2002) (NO. CIV.A.98-CV-118) (Markman Order Version)
AND Ruled Valid by
- H** 3 Sightsound.com Inc. v. N2K, Inc., 391 F.Supp.2d 321 (W.D.Pa. Oct 24, 2003) (NO. CIV.A. 98-CV-118)
- H** 4 **SYSTEM FOR TRANSMITTING DESIRED DIGITAL VIDEO OR AUDIO SIGNALS**, US PAT 5675734, 1997 WL 1488819 (U.S. PTO Utility Oct 07, 1997) (NO. 08/607648)
Construed by
- H** 5 SightSound.Com Inc. v. N2K, Inc., 185 F.Supp.2d 445, 2002 Markman 229872 (W.D.Pa. Feb 08, 2002) (NO. CIV.A.98-CV-118) (Markman Order Version)
AND Ruled Valid by
- H** 6 Sightsound.com Inc. v. N2K, Inc., 391 F.Supp.2d 321 (W.D.Pa. Oct 24, 2003) (NO. CIV.A. 98-CV-118)
- H** 7 **SYSTEM AND METHOD FOR TRANSMITTING DESIRED DIGITAL VIDEO OR DIGITAL AUDIO SIGNALS**, US PAT 5966440, 1999 WL 1731614 (U.S. PTO Utility Oct 12, 1999) (NO. 08/471964)
Construed by
- H** 8 SightSound.Com Inc. v. N2K, Inc., 185 F.Supp.2d 445, 2002 Markman 229872 (W.D.Pa. Feb 08, 2002) (NO. CIV.A.98-CV-118) (Markman Order Version)
AND Ruled Valid by
- H** 9 Sightsound.com Inc. v. N2K, Inc., 391 F.Supp.2d 321 (W.D.Pa. Oct 24, 2003) (NO. CIV.A. 98-CV-118)

Court Documents

© 2010 Thomson Reuters. All rights reserved.

Trial Court Documents (U.S.A.)

W.D.Pa. Expert Testimony

- 10 SIGHTSOUND.COM INCORPORATED, a Pennsylvania corporation, Plaintiff, v. N2K, INC., a Delaware corporation, Cdnw, Inc., a Pennsylvania corporation, and Cdnw Online, Inc., a Pennsylvania corporation, Defendants., 1998 WL 34373758 (Expert Report and Affidavit) (W.D.Pa. 1998) **Opening Expert Report of James A. Moorer** (NO. 98-0118)
- 11 SIGHTSOUND.COM INCORPORATED, A Pennsylvania corporation, Plaintiff, v. N2K, INC., a Delaware corporation CDNOW, Inc., A Pennsylvania corporation, and CDNOW Online, Inc., a Pennsylvania corporation, Defendants., 2001 WL 34891529 (Expert Deposition) (W.D.Pa. Apr. 19, 2001) **Proceedings** (NO. 98-118)
- 12 SIGHTSOUND.COM INCORPORATED, a Pennsylvania corporation, Plaintiff, v. N2K, INC., a Delaware Corporation, CDNOW, INC., a CDNOW Online, Inc., a Pennsylvania corporation, Defendants., 2002 WL 32994569 (Expert Report and Affidavit) (W.D.Pa. Dec. 24, 2002) **Expert Report of Michael Ian Shamos, Ph.D., J.D.** (NO. 98-118)
- 13 SIGHTSOUND.COM INCORPORATED, Plaintiff, v. N2K, INC., CDNow, Inc., and CDNow Online, Inc., Defendants., 2003 WL 24288805 (Expert Report and Affidavit) (W.D.Pa. Jan. 21, 2003) **Expert Report of Justin Douglas Tygar, Ph.D.** (NO. 98-0118)
- 14 SIGHTSOUND.COM INCORPORATED, a Pennsylvania corporation, Plaintiff, v. N2K, INC., a Delaware corporation, Cdnw, Inc., a Pennsylvania corporation, and Cdnw Online, Inc., a Pennsylvania corporation, Defendants., 2003 WL 24288806 (Expert Report and Affidavit) (W.D.Pa. Feb. 19, 2003) **Rebuttal Expert Report of James A. Moorer to Opening Report of Professor Tygar** (NO. 98-0118)
- 15 SIGHTSOUND.COM INCORPORATED a Pennsylvania corporation, Plaintiff, v. N2K, INC., a Delaware Corporation, Cdnw, Inc., a Pennsylvania corporation, and Cdnw Online, Inc., a Pennsylvania corporation, Defendants., 2003 WL 24288804 (Expert Report and Affidavit) (W.D.Pa. Feb. 20, 2003) **Rebuttal Report of Michael Ian Shamos, Ph.D., J.D.** (NO. 98-118)
- 16 SIGHTSOUND.COM INCORPORATED, Plaintiff, v. N2K, INC., CDnow, Inc., and CDnow Online, Inc., Defendants., 2003 WL 24289706 (Expert Report and Affidavit) (W.D.Pa. Feb. 20, 2003) **Rebuttal Expert Report of Justin Douglas Tygar, Ph.D.** (NO. 98-0118)
- 17 SIGHTSOUND.COM INCORPORATED, a Pennsylvania corporation, Plaintiff, v. N2K, INC., a Delaware corporation, Cdnw, Inc., a Pennsylvania corporation, and Cdnw Online, Inc., a Pennsylvania corporation, Defendants., 2003 WL 24309949 (Partial Expert Testimony) (W.D.Pa. Mar. 3, 2003) **(Partial Testimony)** (NO. 98-0118)
- 18 SIGHTSOUND.COM, INCORPORATED, Plaintiff, v. N2K, INC., Cdnw, Inc., and Cdnw Online, Inc., Defendants., 2003 WL 24309947 (Partial Expert Testimony) (W.D.Pa. Mar. 9, 2003) **Deposition of Justin Douglas Tygar, Ph.D.** (NO. 98-0118)
- 19 SIGHTSOUND.COM INCORPORATED, a Pennsylvania corporation, Plaintiff, v. N2K, INC., a Delaware corporation, Cdnw, Inc., a Pennsylvania corporation, and Cdnw Online, Inc., a Pennsylvania corporation, Defendants., 2003 WL 24309950 (Expert Deposition) (W.D.Pa. Mar. 11, 2003) **(Deposition)** (NO. 98-0118)
- 20 In the Matter of: SIGHTSOUBD.COM INC., v. N2K, INC. et al., 2003 WL 24309948 (Partial

- Expert Testimony) (W.D.Pa. Mar. 12, 2003) (**Partial Testimony**) (NO. 98-0118)
- 21 SIGHTSOUND.COM, INC., a Pennsylvania corporation, Plaintiff, v. N2K, INC., a Delaware corporation, Cdnw, Inc., a Pennsylvania corporation, and Cdnw Online, Inc., a Pennsylvania corporation, Defendants., 2003 WL 24288807 (Expert Report and Affidavit) (W.D.Pa. Apr. 23, 2003) **Declaration by James A. Moorero in Support of Defendants' Motion for Summary Judgment** (NO. 98-0118)
- 22 SIGHTSOUND.COM, INC., a Pennsylvania corporation, Plaintiff and, Counterdefendants, v. N2K, INC., a Delaware corporation, CDNOW, Inc., a Pennsylvania corporation, and Cdnw Online, INC., a Pennsylvania corporation, Defendants and Counterclaimants., 2004 WL 3735168 (Expert Report and Affidavit) (W.D.Pa. Jan. 27, 2004) **Declaration of Michael Ian Shamos in Support of Defendants' Motion for Summary Judgment** (NO. 98-0118)

W.D.Pa. Trial Motions, Memoranda And Affidavits

- 23 SIGHTSOUND.COM INC., Plaintiff, v. N2K, INC., Cdnw, Inc., and CDnow Online, Inc., Defendants., 2004 WL 3742179 (Trial Motion, Memorandum and Affidavit) (W.D.Pa. Jan. 12, 2004) **Sightsound's Motion in Limine to Preclude Certain Testimony of James A. Moorero, Ph. D.** (NO. 98-0118)
- 24 SIGHTSOUND.COM INC., Plaintiff, v. N2K, INC., CDnow, Inc., and CDnow Online, Inc., Defendants., 2004 WL 3742180 (Trial Motion, Memorandum and Affidavit) (W.D.Pa. Jan. 12, 2004) **Sightsound's Motion in Limine to Preclude Certain Testimony of Michael Ian Shamos, Ph.D., J.D.** (NO. 98-0118)
- 25 SIGHTSOUND.COM INC., Plaintiff, v. N2K, INC., CDnow, Inc., and CDnow Online, Inc., Defendants., 2004 WL 3742181 (Trial Motion, Memorandum and Affidavit) (W.D.Pa. Jan. 27, 2004) **Defendants' Opposition to Plaintiff's Motion in Limine to Preclude Certain Testimony of James A. Moorero, Ph.D** (NO. 98-0118)
- 26 SIGHTSOUND.COM INC., Plaintiff, v. N2K, INC., Cdnw, Inc., and CDnow Online, Inc., Defendants., 2004 WL 3742182 (Trial Motion, Memorandum and Affidavit) (W.D.Pa. Jan. 27, 2004) **Defendants' Opposition to Plaintiff's Motion in Limine to Preclude Certain Testimony of Michael Shamos, Ph.D, JD.** (NO. 98-0118)

Dockets (U.S.A.)

W.D.Pa.

- 27 SIGHTSOUND.COM INC. v. N2K, INC., ET AL, NO. 2:98cv00118 (Docket) (W.D.Pa. Jan. 16, 1998)

Expert Court Documents (U.S.A.)

W.D.Pa. Expert Testimony

- 28 SIGHTSOUND.COM INCORPORATED, a Pennsylvania corporation, Plaintiff, v. N2K, INC., a Delaware corporation, Cdnw, Inc., a Pennsylvania corporation, and Cdnw Online, Inc., a Pennsylvania corporation, Defendants., 1998 WL 34373758 (Expert Report and Affidavit)

- (W.D.Pa. 1998) **Opening Expert Report of James A. Moorer** (NO. 98-0118)
- 29 SIGHTSOUND.COM INCORPORATED, A Pennsylvania corporation, Plaintiff, v. N2K, INC., a Delaware corporation CDNOW, Inc., A Pennsylvania corporation, and CDNOW Online, Inc., a Pennsylvania corporation, Defendants., 2001 WL 34891529 (Expert Deposition) (W.D.Pa. Apr. 19, 2001) **Proceedings** (NO. 98-118)
- 30 SIGHTSOUND.COM INCORPORATED, a Pennsylvania corporation, Plaintiff, v. N2K, INC., a Delaware Corporation, CDNOW, INC., a CDNOW Online, Inc., a Pennsylvania corporation, Defendants., 2002 WL 32994569 (Expert Report and Affidavit) (W.D.Pa. Dec. 24, 2002) **Expert Report of Michael Ian Shamos, Ph.D., J.D.** (NO. 98-118)
- 31 SIGHTSOUND.COM INCORPORATED, Plaintiff, v. N2K, INC., CDNow, Inc., and CDNow Online, Inc., Defendants., 2003 WL 24288805 (Expert Report and Affidavit) (W.D.Pa. Jan. 21, 2003) **Expert Report of Justin Douglas Tygar, Ph.D.** (NO. 98-0118)
- 32 SIGHTSOUND.COM INCORPORATED, a Pennsylvania corporation, Plaintiff, v. N2K, INC., a Delaware corporation, Cdnw, Inc., a Pennsylvania corporation, and Cdnw Online, Inc., a Pennsylvania corporation, Defendants., 2003 WL 24288806 (Expert Report and Affidavit) (W.D.Pa. Feb. 19, 2003) **Rebuttal Expert Report of James A. Moorer to Opening Report of Professor Tygar** (NO. 98-0118)
- 33 SIGHTSOUND.COM INCORPORATED a Pennsylvania corporation, Plaintiff, v. N2K, INC., a Delaware Corporation, Cdnw, Inc., a Pennsylvania corporation, and Cdnw Online, Inc., a Pennsylvania corporation, Defendants., 2003 WL 24288804 (Expert Report and Affidavit) (W.D.Pa. Feb. 20, 2003) **Rebuttal Report of Michael Ian Shamos, Ph.D., J.D.** (NO. 98-118)
- 34 SIGHTSOUND.COM INCORPORATED, Plaintiff, v. N2K, INC., CDnow, Inc., and CDnow Online, Inc., Defendants., 2003 WL 24289706 (Expert Report and Affidavit) (W.D.Pa. Feb. 20, 2003) **Rebuttal Expert Report of Justin Douglas Tygar, Ph.D.** (NO. 98-0118)
- 35 SIGHTSOUND.COM INCORPORATED, a Pennsylvania corporation, Plaintiff, v. N2K, INC., a Delaware corporation, Cdnw, Inc., a Pennsylvania corporation, and Cdnw Online, Inc., a Pennsylvania corporation, Defendants., 2003 WL 24309949 (Partial Expert Testimony) (W.D.Pa. Mar. 3, 2003) **(Partial Testimony)** (NO. 98-0118)
- 36 SIGHTSOUND.COM INCORPORATED, Plaintiff, v. N2K, INC., Cdnw, Inc., and Cdnw Online, Inc., Defendants., 2003 WL 24309947 (Partial Expert Testimony) (W.D.Pa. Mar. 9, 2003) **Deposition of Justin Douglas Tygar, Ph.D.** (NO. 98-0118)
- 37 SIGHTSOUND.COM INCORPORATED, a Pennsylvania corporation, Plaintiff, v. N2K, INC., a Delaware corporation, Cdnw, Inc., a Pennsylvania corporation, and Cdnw Online, Inc., a Pennsylvania corporation, Defendants., 2003 WL 24309950 (Expert Deposition) (W.D.Pa. Mar. 11, 2003) **(Deposition)** (NO. 98-0118)
- 38 In the Matter of: SIGHTSOUBD.COM INC., v. N2K, INC. et al., 2003 WL 24309948 (Partial Expert Testimony) (W.D.Pa. Mar. 12, 2003) **(Partial Testimony)** (NO. 98-0118)
- 39 SIGHTSOUND.COM, INC., a Pennsylvania corporation, Plaintiff, v. N2K, INC., a Delaware corporation, Cdnw, Inc., a Pennsylvania corporation, and Cdnw Online, Inc., a Pennsylvania corporation, Defendants., 2003 WL 24288807 (Expert Report and Affidavit) (W.D.Pa. Apr. 23, 2003) **Declaration by James A. Moorer in Support of Defendants' Motion for Summary Judgment** (NO. 98-0118)

- 40 SIGHTSOUND.COM, INC., a Pennsylvania corporation, Plaintiff and, Counterdefendants, v. N2K, INC., a Delaware corporation, CDNOW, Inc., a Pennsylvania corporation, and Cdnw Online, INC., a Pennsylvania corporation, Defendants and Counterclaimants., 2004 WL 3735168 (Expert Report and Affidavit) (W.D.Pa. Jan. 27, 2004) **Declaration of Michael Ian Shamos in Support of Defendants' Motion for Summary Judgment** (NO. 98-0118)

W.D.Pa. Trial Motions, Memoranda And Affidavits

- 41 SIGHTSOUND.COM INC., Plaintiff, v. N2K, INC., Cdnw, Inc., and CDnow Online, Inc., Defendants., 2004 WL 3742179 (Trial Motion, Memorandum and Affidavit) (W.D.Pa. Jan. 12, 2004) **Sightsound's Motion in Limine to Preclude Certain Testimony of James A. Moorer, Ph. D.** (NO. 98-0118)
- 42 SIGHTSOUND.COM INC., Plaintiff, v. N2K, INC., CDnow, Inc., and CDnow Online, Inc., Defendants., 2004 WL 3742180 (Trial Motion, Memorandum and Affidavit) (W.D.Pa. Jan. 12, 2004) **Sightsound's Motion in Limine to Preclude Certain Testimony of Michael Ian Shamos, Ph.D., J.D.** (NO. 98-0118)
- 43 SIGHTSOUND.COM INC., Plaintiff, v. N2K, INC., CDnow, Inc., and CDnow Online, Inc., Defendants., 2004 WL 3742181 (Trial Motion, Memorandum and Affidavit) (W.D.Pa. Jan. 27, 2004) **Defendants' Opposition to Plaintiff's Motion in Limine to Preclude Certain Testimony of James A. Moorer, Ph.D** (NO. 98-0118)
- 44 SIGHTSOUND.COM INC., Plaintiff, v. N2K, INC., Cdnw, Inc., and CDnow Online, Inc., Defendants., 2004 WL 3742182 (Trial Motion, Memorandum and Affidavit) (W.D.Pa. Jan. 27, 2004) **Defendants' Opposition to Plaintiff's Motion in Limine to Preclude Certain Testimony of Michael Shamos, Ph.D, JD.** (NO. 98-0118)

W.D.Pa.

- 45 SIGHTSOUND.COM INC. v. N2K, INC., ET AL, NO. 2:98cv00118 (Docket) (W.D.Pa. Jan. 16, 1998)

Patent Family

- 46 TRANSMITTING DESIRED DIGITAL VIDEO OR AUDIO SIGNAL - TRANSFERRING MONEY VIA TELECOMMUNICATIONS LINE, CONNECTING ELECTRONICALLY FIRST MEMORY WITH SECOND MEMORY AND TRANSMITTING SIGNAL WITH TRANSMITTER IN CONTROL OF FIRST, Derwent World Patents Legal 1993-093541

Assignments

- 47 Action: ASSIGNMENT OF ASSIGNORS INTEREST (SEE DOCUMENT FOR DETAILS). Number of Pages: 006, (DATE RECORDED: Dec 27, 2005)
- 48 ACTION: NOTICE OF GRANT OF SECURITY INTEREST NUMBER OF PAGES: 006, (DATE RECORDED: Oct 24, 2001)
- 49 ACTION: CHANGE OF NAME (SEE DOCUMENT FOR DETAILS). NUMBER OF PAGES: 016, (DATE RECORDED: May 03, 2000)
- 50 ASSIGNEE(S): PARSEC SIGHT/SOUND,

INC., (DATE RECORDED: Oct 02, 1995)

Patent Status Files

- .. Request for Re-Examination, (OG DATE: Mar 29, 2005)
- .. Patent Suit(See LitAlert Entries),
- .. Certificate of Correction, (OG DATE: Dec 21, 1993)

Docket Summaries

- 54 "SIGHTSOUND TECH v. ROXIO, INC., ET AL", (W.D.PA. Oct 08, 2004) (NO. 2:04CV01549), (35 USC 271 PATENT INFRINGEMENT)

Litigation Alert

- 55 Derwent LitAlert P1998-06-59 (1999) Action Taken: A complaint was filed.

Prior Art (Coverage Begins 1976)

- ▶ 56 AUTOMATIC INFORMATION, GOODS AND SERVICES DISPENSING SYSTEM, US PAT 4567359 (U.S. PTO Utility 1986)
- ◐ 57 COIN-OPERATED RECORDING MACHINE, US PAT 3990710 (U.S. PTO Utility 1976)
- ◐ 58 SOFTWARE VENDING SYSTEM, US PAT 4654799 Assignee: Brother Kogyo Kabushiki Kaisha, (U.S. PTO Utility 1987)
- ◐ 59 VENDING SYSTEM FOR REMOTELY ACCESSIBLE STORED INFORMATION, US PAT 3718906 Assignee: Lightner R, (U.S. PTO Utility 1973)
- ◐ 60 VIDEO CASSETTE SELECTION MACHINE, US PAT 4647989 (U.S. PTO Utility 1987)

US District Court Civil Docket

**U.S. District - Pennsylvania Western
(Pittsburgh)**

2:04cv1549

Sightsound Tech v. Roxio, Inc, et al

This case was retrieved from the court on Monday, August 04, 2008

Date Filed: 10/08/2004	Class Code: CLOSED
Assigned To: Chief Judge Donetta W Ambrose	Closed: Yes
Referred To:	Statute: 35:271
Nature of suit: Patent (830)	Jury Demand: Both
Cause: Patent Infringement	Demand Amount: \$0
Lead Docket: None	NOS Description: Patent
Other Docket: Dkt in other court: 05-01277	
Dkt in other court: Related, 2:98-cv-118	
Jurisdiction: Federal Question	

Litigants

Sightsound Technologies, Inc A Delaware Corporation
Plaintiff

Attorneys

Brian S Mudge
[COR LD NTC]
Kenyon & Kenyon
1500 K Street, NW
Suite 700
Washington , DC 20005-1257
USA
(202) 220-4200
Fax: (202) 220-4201
Email: BMUDGE@KENYON.COM

Clyde E Findley
[COR LD NTC]
[Term: 04/28/2006]
Kenyon & Kenyon
1500 K Street, NW
Suite 700
Washington , DC 20005-1257
USA
(202) 220-4200

Duncan L Williams
[COR LD NTC]
Kenyon & Kenyon
1500 K Street, NW
Suite 700
Washington , DC 20005-1257
USA
(202) 220-4200
Email: Dlwilliams@kenyon.com

Richard F Rinaldo
[COR LD NTC]
Williams Coulson
One Gateway Center
420 Fort Duquesne Boulevard, 16TH Floor

Pittsburgh , PA 15222
USA
(412) 454-0259
Fax: (412) 281-6622
Email: RRINALDO@WILLIAMSCOULSON.COM

William K Wells
[COR LD NTC]
Kenyon & Kenyon
1500 K Street, NW
Suite 700
Washington , DC 20005-1257
USA
(202) 220-4200
Email: Wwells@kenyon.com

Roxio, Inc A Delaware Corporation
Defendant

Charles K Verhoeven
[COR LD NTC]
Quinn, Emanuel, Urquhart, Oliver & Hedges
50 California Street
22ND Floor
San Francisco , CA 94111
USA
(415) 875-6600
Email: Charlesverhoeven@quinnemanuel.com

Kathryn M Kenyon
[COR LD NTC]
Pietragallo Gordon Alfano Bosick & Raspanti, LLP
38TH Floor, One Oxford Centre
301 Grant Street
Pittsburgh , PA 15219
USA
(412) 263-1837
Fax: (412) 263-2001
Email: KMK@PIETRAGALLO.COM

Kevin P Allen
[COR LD NTC]
[Term: 01/11/2005]
Thorp, Reed & Armstrong
301 Grant Street
One Oxford Centre, 14TH Floor
Pittsburgh , PA 15219-1425
USA
(412) 394-2366
Email: Kallen@thorpreed.com

Laurence Z Shiekman
[COR LD NTC]
Pepper Hamilton Eighteenth & Arch Streets
3000 Two Logan Square
Philadelphia , PA 19103-2799
USA
(215) 981-4000
Email: Shiekmanl@pepperlaw.com

Michael E Williams
[COR LD NTC]
Quinn, Emanuel, Urquhart, Oliver & Hedges
865 South Figueroa Street
10TH Floor
Los Angeles , CA 90017
USA
(213) 443-3000
Email: Michaelwilliams@quinnemanuel.com

Napster, Llc A Delaware Limited Liability Company
Defendant

Tigran Guledjian
[COR LD NTC]
Quinn, Emanuel, Urquhart, Oliver & Hedges
865 South Figueroa Street
10TH Floor
Los Angeles , CA 90017
USA
(213) 443-3000
Email: Tigranguledjian@quinnemanuel.com

William M Wycoff
[COR LD NTC]
[Term: 01/11/2005]
Thorp, Reed & Armstrong
301 Grant Street
One Oxford Centre, 14TH Floor
Pittsburgh , PA 15222-4895
USA
394-7782
Email: Wwycoff@thorpreed.com

Charles K Verhoeven
[COR LD NTC]
Quinn, Emanuel, Urquhart, Oliver & Hedges
50 California Street
22ND Floor
San Francisco , CA 94111
USA
(415) 875-6600
Email: Charlesverhoeven@quinnemanuel.com

Kathryn M Kenyon
[COR LD NTC]
Pietragallo Gordon Alfano Bosick & Raspanti, LLP
38TH Floor, One Oxford Centre
301 Grant Street
Pittsburgh , PA 15219
USA
(412) 263-1837
Fax: (412) 263-2001
Email: KMK@PIETRAGALLO.COM

Kevin P Allen
[COR LD NTC]
[Term: 01/11/2005]
Thorp, Reed & Armstrong
301 Grant Street
One Oxford Centre, 14TH Floor
Pittsburgh , PA 15219-1425
USA
(412) 394-2366
Email: Kallen@thorpreed.com

Laurence Z Shiekman
[COR LD NTC]
Pepper Hamilton Eighteenth & Arch Streets
3000 Two Logan Square
Philadelphia , PA 19103-2799
USA
(215) 981-4000
Email: Shiekmanl@pepperlaw.com

Michael E Williams
[COR LD NTC]
Quinn, Emanuel, Urquhart, Oliver & Hedges

865 South Figueroa Street
10TH Floor
Los Angeles , CA 90017
USA
(213) 443-3000
Email: Michaelwilliams@quinnemanuel.com

Michael T Zeller
[COR LD NTC]
Quinn Emanuel Urquhart Oliver & Hedges
865 S Figueroa Street, 10TH Floor
Los Angeles , CA 90017
USA
(213) 443-3000
Email: Michaelzeller@quinnemanuel.com

Tigran Guledjian
[COR LD NTC]
Quinn, Emanuel, Urquhart, Oliver & Hedges
865 South Figueroa Street
10TH Floor
Los Angeles , CA 90017
USA
(213) 443-3000
Email: Tigranguledjian@quinnemanuel.com

William M Wycoff
[COR LD NTC]
[Term: 01/11/2005]
Thorp, Reed & Armstrong
301 Grant Street
One Oxford Centre, 14TH Floor
Pittsburgh , PA 15222-4895
USA
394-7782
Email: Wwycoff@thorpreed.com

Scott Sander
Counter Defendant

Brian S Mudge
[COR LD NTC]
Kenyon & Kenyon
1500 K Street, NW
Suite 700
Washington , DC 20005-1257
USA
(202) 220-4200
Fax: (202) 220-4201
Email: BMUDGE@KENYON.COM

Richard F Rinaldo
[COR LD NTC]
Williams Coulson
One Gateway Center
420 Fort Duquesne Boulevard, 16TH Floor
Pittsburgh , PA 15222
USA
(412) 454-0259
Fax: (412) 281-6622
Email: RRINALDO@WILLIAMSCOULSON.COM

William K Wells
[COR LD NTC]
Kenyon & Kenyon
1500 K Street, NW
Suite 700
Washington , DC 20005-1257
USA

(202) 220-4200
Email: Wwells@kenyon.com

Date	#	Proceeding Text
10/08/2004	1	COMPLAINT with summons issued; jury demand Filing Fee \$ 150.00 Receipt # 05000126 (tt) (Entered: 10/08/2004)
10/08/2004	2	DISCLOSURE statement by SIGHTSOUND TECH (tt) (Entered: 10/08/2004)
10/08/2004	--	COPY of Complaint and Docket Entries mailed to the Commissioner of Patents and Trademarks. (tt) (Entered: 10/08/2004)
11/08/2004	3	RETURN OF SERVICE executed as to ROXIO, INC. 11/5/04 Answer due on 11/26/04 for ROXIO, INC. (tt) (Entered: 11/09/2004)
11/08/2004	4	RETURN OF SERVICE executed as to NAPSTER, L.L.C. 11/5/04 Answer due on 11/26/04 for NAPSTER, L.L.C. (tt) (Entered: 11/09/2004)
11/24/2004	5	ANSWER to Complaint; jury demand and COUNTERCLAIM by ROXIO, INC., NAPSTER, L.L.C. (Attorney William M. Wycoff, Kevin P. Allen, Charles K. Verhoeven, Michael E. Williams) against SIGHTSOUND TECH (tt) Modified on 03/11/2005 (Entered: 11/24/2004)
11/24/2004	6	DISCLOSURE statement by ROXIO, INC., NAPSTER, L.L.C. (tt) (Entered: 11/24/2004)
11/24/2004	7	NOTICE Opting Out of Arbitration by ROXIO, INC., NAPSTER, L.L.C. (tt) (Entered: 11/24/2004)
12/15/2004	8	ANSWER by SIGHTSOUND TECH to [5-2] counterclaims by NAPSTER, L.L.C., ROXIO, INC. (tt) (Entered: 12/16/2004)
12/17/2004	9	Case Management Conference set for 9:15 1/11/05 (tt) (Entered: 12/17/2004)
01/10/2005	10	INITIAL Case Scheduling Conference Statement by ROXIO, INC., NAPSTER, L.L.C. (tt) (Entered: 01/10/2005)
01/10/2005	11	MOTION by SIGHTSOUND TECH for Preliminary Injunction , with Proposed Order. (tt) (Entered: 01/11/2005)
01/10/2005	12	EXHIBITS by SIGHTSOUND TECH to [11-1] motion for Preliminary Injunction (tt) (Entered: 01/11/2005)
01/10/2005	13	BRIEF by SIGHTSOUND TECH in support of [11-1] motion for Preliminary Injunction by SIGHTSOUND TECH (tt) (Entered: 01/11/2005)
01/10/2005	14	DECLARATION of Justin Douglas Tygar, Ph.D. concerning the Operation of Roxio/Napster Re: [11-1] motion for Preliminary Injunction by SIGHTSOUND TECH (tt) (Entered: 01/11/2005)
01/11/2005	15	MOTION by ROXIO, INC., NAPSTER, L.L.C. to Substitute Attorney , with Proposed Order. (tt) (Entered: 01/11/2005)
01/11/2005	16	MOTION by ROXIO, INC., NAPSTER, L.L.C. for Charles K. Verhoeven to Appear Pro Hac Vice ; Filing Fee \$ 40.00 Receipt # 05001581 , with Proposed Order. (tt) (Entered: 01/11/2005)
01/11/2005	17	MOTION by ROXIO, INC., NAPSTER, L.L.C. for Tigran Guledjian to Appear Pro Hac Vice ; Filing Fee \$ 40.00 Receipt # 05001581 , with Proposed Order. (tt) (Entered: 01/11/2005)
01/11/2005	18	MOTION by ROXIO, INC., NAPSTER, L.L.C. for Michael E. Williams to Appear Pro Hac Vice ; Filing Fee \$ 40.00 Receipt # 05001581 , with Proposed Order. (tt) (Entered: 01/11/2005)
01/11/2005	19	Status Conference held 1/11/05 before Chief Judge Donetta W. Ambrose [Reporter: none] (tt) (Entered: 01/11/2005)
01/11/2005	--	Deadline updated; Response to Motion set to 2/11/05 for [11-1] motion for Preliminary Injunction ; Reply to Response to Motion set to 2/21/05 for [11-1] motion for Preliminary Injunction ; Motion Hearing set for 1:30 3/3/05 for [11-1] motion for Preliminary Injunction (tt) (Entered: 01/11/2005)
01/11/2005	20	RESPONSE by SIGHTSOUND TECH to defts' [10-1] Initial Case Scheduling Conference Statement. (tt) (Entered: 01/11/2005)
01/11/2005	--	ORDER upon motion granting [15-1] motion to Substitute Attorney ; terminated attorney William M. Wycoff for ROXIO, INC., attorney Kevin P. Allen for ROXIO, INC., attorney William M. Wycoff for NAPSTER, L.L.C., attorney Kevin P. Allen for NAPSTER, L.L.C. and added Laurence Z. Shiekman, Kathryn M. Kenyon for defts. (signed by Chief Judge Donetta W. Ambrose on 1/11/05) CM all parties of record. (tt) (Entered: 01/12/2005)
01/11/2005	--	ORDER upon motion granting [16-1] motion for Charles K. Verhoeven to Appear Pro Hac Vice on

behalf of defts. (signed by Chief Judge Donetta W. Ambrose on 1/11/05) CM all parties of record. (tt) (Entered: 01/12/2005)

01/11/2005 -- ORDER upon motion granting [17-1] motion for Tigran Guledjian to Appear Pro Hac Vice on behalf of defts. (signed by Chief Judge Donetta W. Ambrose on 1/11/05) CM all parties of record. (tt) (Entered: 01/12/2005)

01/11/2005 -- ORDER upon motion granting [18-1] motion for Michael E. Williams to Appear Pro Hac Vice on behalf of defts. (signed by Chief Judge Donetta W. Ambrose on 1/11/05) CM all parties of record. (tt) (Entered: 01/12/2005)

01/18/2005 21 Status Conference via phone held 1/18/05 before Chief Judge Donetta W. Ambrose [Reporter: none] ; Deft wants leave to amend counterclaims related to press release. Pltf doesn't object to motion for leave to amend. Leave granted orally by the Court; Amended counterclaim due 1/25/05. Deft to file a Motion to Stay Case pending outcome of application to Patent & Trademark Office, response due w/in 10 days. (tt) (Entered: 01/19/2005)

01/21/2005 22 MOTION by ROXIO, INC., NAPSTER, L.L.C. to Stay Pending Reexamination of Patents in Suit with Proposed Order. (jsp) (Entered: 01/24/2005)

01/21/2005 23 BRIEF by ROXIO, INC., NAPSTER, L.L.C. in support of [22-1] motion to Stay Pending Reexamination of Patents in Suit by NAPSTER, L.L.C., ROXIO, INC. (jsp) (Entered: 01/24/2005)

01/25/2005 24 FIRST AMENDED ANSWER to Complaint by ROXIO, INC., NAPSTER, L.L.C. amends: [5-1] answer by NAPSTER, L.L.C., ROXIO, INC. and COUNTERCLAIMS against SIGHTSOUND TECH (tt) (Entered: 01/26/2005)

01/27/2005 25 MOTION by SIGHTSOUND TECH to Extend Time w/in which to respond to defts' motion to stay pending receipt of defts' request for re-examination of patents and prior art which defts intend to submit to the Patent and Trademark Office , with Proposed Order. (tt) (Entered: 01/28/2005)

01/28/2005 26 RESPONSE by ROXIO, INC., NAPSTER, L.L.C. to pltf's [25-1] motion to Extend Time w/in which to respond to defts' motion to stay (tt) (Entered: 01/28/2005)

01/28/2005 27 ACCEPTANCE OF SERVICE of First Amended Answer and Counterclaim as to Scott Sander executed 1/26/05 (tt) (Entered: 01/28/2005)

01/28/2005 28 BRIEF by SIGHTSOUND TECH in support of [25-1] motion to Extend Time w/in which to respond to defts' motion to stay (tt) (Entered: 01/31/2005)

02/02/2005 29 Status Conference via phone held 1/31/05 before Chief Judge Donetta W. Ambrose [Reporter: none] ; Pltf's response to motion to stay due 2/11/05 ; Defts' reply due 2/16/05 ; Preliminary injunction date will be scheduled via order on motion to stay ; Defts do not have to file answer to preliminary injunction by March. (tt) (Entered: 02/02/2005)

02/02/2005 -- ORDER upon motion granting [25-1] motion to Extend Time w/in which to respond to defts' motion to stay pending receipt of defts' request for re-examination of patents and prior art which defts intend to submit to the Patent and Trademark Office. Defts shall serve on counsel for pltf by overnight delivery sent no later than 2/1/05 any request for re-examination of the patents in suit which defts intend to file with the PTO, including all prior art on which defts plan to rely in such request for re-examination ; Pltf's Response to Motion set to 2/11/05 for defts' [22-1] motion to Stay Pending Reexamination of Patents in Suit ; Defts' Reply Brief due 2/16/05 ; Defts are not required to file an answer to pltf's motion for preliminary injunction until further order of court. (signed by Chief Judge Donetta W. Ambrose on 1/31/05) CM all parties of record. (tt) (Entered: 02/02/2005)

02/03/2005 30 MOTION by SIGHTSOUND TECH for Brian S. Mudge to Appear Pro Hac Vice ; Filing Fee \$ 40.00 Receipt # 05001943 , with Proposed Order. (tt) (Entered: 02/04/2005)

02/03/2005 31 MOTION by SIGHTSOUND TECH for William K. Wells to Appear Pro Hac Vice ; Filing Fee \$ 40.00 Receipt # 05001943 , with Proposed Order. (tt) (Entered: 02/04/2005)

02/03/2005 32 MOTION by SIGHTSOUND TECH for Duncan L. Williams to Appear Pro Hac Vice ; Filing Fee \$ 40.00 Receipt # 05001943 , with Proposed Order. (tt) (Entered: 02/04/2005)

02/03/2005 33 MOTION by SIGHTSOUND TECH for Clyde E. Findley to Appear Pro Hac Vice ; Filing Fee \$40.00 05001943 Receipt # 05001943 , with Proposed Order. (tt) (Entered: 02/04/2005)

02/04/2005 34 NOTICE of Lodging of Pending Requests for Reexamination by ROXIO, INC., NAPSTER, L.L.C. (tt) (Entered: 02/04/2005)

02/04/2005 35 EXHIBITS (VOLUME I) by ROXIO, INC., NAPSTER, L.L.C. to [34-1] notice of lodging of pending requests for reexamination. (tt) (Entered: 02/04/2005)

02/04/2005 36 EXHIBITS (VOLUME II) by ROXIO, INC., NAPSTER, L.L.C. to [34-1] notice of lodging of pending requests for reexamination. (tt) (Entered: 02/04/2005)

02/04/2005 37 EXHIBITS (VOLUME III) by ROXIO, INC., NAPSTER, L.L.C. to [34-1] notice of lodging of pending requests for reexamination. (tt) (Entered: 02/04/2005)

02/07/2005 -- ORDER upon motion granting [30-1] motion for Brian S. Mudge to Appear Pro Hac Vice on behalf of pltf. (signed by Chief Judge Donetta W. Ambrose on 2/4/05) CM all parties of record. (tt) (Entered: 02/07/2005)

02/07/2005 -- ORDER upon motion granting [31-1] motion for William K. Wells to Appear Pro Hac Vice on behalf of pltf. (signed by Chief Judge Donetta W. Ambrose on 2/4/05) CM all parties of record. (tt) (Entered: 02/07/2005)

02/07/2005 -- ORDER upon motion granting [32-1] motion for Duncan L. Williams to Appear Pro Hac Vice on behalf of pltf. (signed by Chief Judge Donetta W. Ambrose on 2/4/05) CM all parties of record. (tt) (Entered: 02/07/2005)

02/07/2005 -- ORDER upon motion granting [33-1] motion for Clyde E. Findley to Appear Pro Hac Vice on behalf of pltf. (signed by Chief Judge Donetta W. Ambrose on 2/4/05) CM all parties of record. (tt) (Entered: 02/07/2005)

02/11/2005 38 REPLY by SIGHTSOUND TECH to [24-2] First Amended Counterclaims by NAPSTER, L.L.C., ROXIO, INC. (tt) (Entered: 02/14/2005)

02/11/2005 39 BRIEF by SIGHTSOUND TECH in opposition to Napster's [22-1] motion to Stay Pending Reexamination of Patents in Suit (tt) (Entered: 02/14/2005)

02/11/2005 40 MOTION by SIGHTSOUND TECH, SCOTT SANDER to Dismiss defts' Amended Counterclaims 4-9 . (tt) (Entered: 02/14/2005)

02/11/2005 41 BRIEF by SIGHTSOUND TECH, SCOTT SANDER in support of their [40-1] motion to Dismiss defts' Amended Counterclaims 4-9 (tt) (Entered: 02/14/2005)

02/16/2005 42 REPLY by ROXIO, INC., NAPSTER, L.L.C. in support of their Motion to Stay pending Reexamination of the Patents-In-Suit (tt) (Entered: 02/17/2005)

02/16/2005 43 DECLARATION of William E. Growney (tt) Modified on 02/18/2005 (Entered: 02/17/2005)

02/16/2005 44 MOTION by ROXIO, INC., NAPSTER, L.L.C. to Seal [43-1] Declaration , with Proposed Order. (tt) (Entered: 02/17/2005)

02/17/2005 45 OPPOSITION by SIGHTSOUND TECH to defts' [44-1] motion to Seal [43-1] Declaration (tt) (Entered: 02/18/2005)

02/17/2005 46 NOTICE OF FILING: Supplemental Declaration of Christopher Reese by SIGHTSOUND TECH (FILED UNDER SEAL) (tt) Modified on 02/28/2005 (Entered: 02/18/2005)

02/17/2005 47 REQUEST by SIGHTSOUND TECH for Oral Argument on Motion to Stay . (tt) (Entered: 02/18/2005)

02/18/2005 -- ORDER upon motion denying [44-1] motion to Seal [43-1] Declaration. The declaration speaks only of vague, unsuccessful attempts & no dollar values are set forth. I see no risk of confidential information being disclosed. (signed by Chief Judge Donetta W. Ambrose on 2/18/05) CM all parties of record. (tt) (Entered: 02/18/2005)

02/18/2005 -- ORDER upon motion denying [47-1] motion for Oral Argument on Motion to Stay. The parties have clearly represented their respective positions in the briefs and declarations filed. (signed by Chief Judge Donetta W. Ambrose on 2/18/05) CM all parties of record. (tt) (Entered: 02/18/2005)

02/23/2005 48 MOTION by ROXIO, INC., NAPSTER, L.L.C. to Seal Supplemental Declaration of Christopher Reese , with Proposed Order. (tt) (Entered: 02/23/2005)

02/23/2005 49 OPPOSITION by SIGHTSOUND TECH to defts' [48-1] motion to Seal Supplemental Declaration of Christopher Reese (tt) (Entered: 02/24/2005)

02/28/2005 -- ORDER upon motion granting [48-1] motion to Seal Supplemental Declaration of Christopher Reese. The Supplemental Declaration of Christopher Reese filed 2/17/05 shall be placed under seal. (signed by Chief Judge Donetta W. Ambrose on 2/28/05) CM all parties of record. (tt) (Entered: 02/28/2005)

02/28/2005 50 MEMORANDUM OPINION & ORDER granting defts' [22-1] motion to Stay. The defts are to contact this Court immediately upon receiving any notification from the PTO regarding the outcome of the Request for Reexamination. The preliminary injunction hearing scheduled for 3/3/05 is cancelled . The [11-1] motion for Preliminary Injunction is denied without prejudice to reassert once the stay is lifted. (signed by Chief Judge Donetta W. Ambrose on 2/28/05) CM all parties of record. (tt) (Entered: 02/28/2005)

03/03/2005 51 NOTICE OF APPEAL by SIGHTSOUND TECH from [50-1] memorandum opinion dated 2/28/05

- FILING FEE \$ 255 RECEIPT # 2394 TPO issued. (lck) (Entered: 03/07/2005)
- 03/03/2005 -- Certified copy of Notice of Appeal [51-1] appeal by SIGHTSOUND TECH , certified copy of docket, certified copy of order dated 2/28/05 mailed to USCA; copy of Notice of Appeal and information sheet to ROXIO, INC., NAPSTER, L.L.C. and judge. Copy of information sheet to appellant. (lck) (Entered: 03/07/2005)
- 03/11/2005 52 Transcript Purchase order re: [51-1] appeal by SIGHTSOUND TECH indicating that no transcript is being ordered. (tt) (Entered: 03/11/2005)
- 03/21/2005 -- Text not available. (Entered: 03/21/2005)
- 04/04/2005 53 NOTICE of PTO's Order granting ex parte Reexamination by ROXIO, INC., NAPSTER, L.L.C. (tt) (Entered: 04/04/2005)
- 07/21/2005 54 MOTION for Relief from Stay with Respect to Defamation Counterclaims by SIGHTSOUND TECHNOLOGIES, INC., SCOTT SANDER. (Attachments: # 1 Proposed Order)(jsp) (Entered: 07/21/2005)
- 07/21/2005 55 BRIEF in Support re 54 MOTION for Relief from Stay with Respect to Defamation Counterclaims filed by SIGHTSOUND TECHNOLOGIES, INC., SCOTT SANDER. (Attachments: # 1 Part 2 of Brief)(jsp) (Entered: 07/21/2005)
- 07/22/2005 56 NOTICE: re 54 MOTION for Relief from Stay with Respect to Defamation Counterclaims:Response due on or before 8/4/05. (jlh) (Entered: 07/22/2005)
- 08/04/2005 57 NOTICE by ROXIO, INC., NAPSTER, L.L.C. of PTO's Issuance of Office Actions in Ex Parte Reexamination (Attachments: # 1 # 2 # 3)(Helmsen, Joseph) (Entered: 08/04/2005)
- 08/04/2005 58 MOTION for attorney Michael T. Zeller to Appear Pro Hac Vice by ROXIO, INC., NAPSTER, L.L.C.. (Attachments: # 1 Proposed Order)(Kenyon, Kathryn) (Entered: 08/04/2005)
- 08/04/2005 59 NOTICE by ROXIO, INC., NAPSTER, L.L.C. re 57 Notice (Other) Letter Notice of Prior Filing. (Kenyon, Kathryn) (Entered: 08/04/2005)
- 08/04/2005 60 BRIEF in Opposition re 54 MOTION for Relief from Stay with Respect to Defamation Counterclaims filed by ROXIO, INC., NAPSTER, L.L.C.. (Attachments: # 1 Exhibit A# 2 Exhibit B# 3 Exhibit C# 4 Exhibit D# 5 Exhibit E# 6 Exhibit F# 7 Exhibit G# 8 Exhibit H)(Kenyon, Kathryn) (Entered: 08/04/2005)
- 08/04/2005 -- Pro Hac Vice Fees received in the amount of \$ 40 receipt # 4877 re 58 Motion to Appear Pro Hac Vice (ept) (Entered: 08/05/2005)
- 08/08/2005 61 ORDER granting 58 Motion to Appear Pro Hac Vice . Signed by Judge Donetta W. Ambrose on 8/8/05. (jlh) (Entered: 08/08/2005)
- 09/01/2005 62 ORDER denying 54 Motion for Relief from Stay . Signed by Judge Donetta W. Ambrose on 8/31/05. (jlh) (Entered: 09/01/2005)
- 09/06/2005 63 NOTICE by SIGHTSOUND TECHNOLOGIES, INC., SCOTT SANDER NOTICE OF FILING TO SUPPLEMENT RECORD (Kerr, Benjamin) (Entered: 09/06/2005)
- 09/07/2005 64 Minute Entry for proceedings held before Judge Donetta W. Ambrose : Status Conference held on 9/7/2005. Parties to keep Court informed of PTO Action. (jlh) (Entered: 09/07/2005)
- 11/02/2005 65 NOTICE by ROXIO, INC., NAPSTER, L.L.C. of PTO's Issuance of Second Office Actions in Ex Parte Reexamination (Attachments: # 1 Exhibit A# 2 Exhibit B# 3 Exhibit C)(Kenyon, Kathryn) (Entered: 11/02/2005)
- 11/14/2005 66 MANDATE of USCA for the Federal Circuit as to 51 Notice of Appeal filed by SIGHTSOUND TECHNOLOGIES, INC., that the appeal is dismissed, with each party to bear its own costs. (jsp) (Entered: 11/15/2005)
- 03/02/2006 67 MOTION by Clyde E. Findley to Withdraw as Attorney by SIGHTSOUND TECHNOLOGIES, INC. (jsp) (Entered: 03/02/2006)
- 05/10/2006 68 NOTICE by ROXIO, INC., NAPSTER, L.L.C. Defendants' Notice of PTO's Issuance of Final Office Actions in Ex Parte Reexamination and Request for Status Conference (Attachments: # 1 Exhibit A)(Kenyon, Kathryn) (Entered: 05/10/2006)
- 05/10/2006 69 EXHIBITS in Support of 68 Notice (Other) by ROXIO, INC., NAPSTER, L.L.C.. (Kenyon, Kathryn) (Entered: 05/10/2006)
- 05/10/2006 70 EXHIBITS in Support of 68 Notice (Other) by ROXIO, INC., NAPSTER, L.L.C.. (Kenyon, Kathryn) (Entered: 05/10/2006)
- 05/10/2006 -- MOTION (Request) for Status Conference by ROXIO, INC., NAPSTER, L.L.C..(with Document 68) (jsp) (Entered: 05/11/2006)

05/11/2006 -- CLERK'S OFFICE QUALITY CONTROL MESSAGE. re 68 Notice (Other) ERROR: Document should have been filed as two separate documents. CORRECTION: Attorney advised in future that documents of that nature are to be filed as separate documents. Clerk of Court docketed Request for Status Conference. This message is for informational purposes only. (jsp) (Entered: 05/11/2006)

05/31/2006 71 Minute Entry for proceedings held before Judge Donetta W. Ambrose : Telephone Conference held on 5/31/2006. (Court Reporter none) (jlh) (Entered: 05/31/2006)

05/31/2006 72 ORDER FOR ADMINISTRATIVE CLOSING.Signed by Judge Donetta W. Ambrose on 5/31/06. (jlh) (Entered: 05/31/2006)

06/02/2006 73 NOTICE by SIGHTSOUND TECHNOLOGIES, INC. Notice of Filing by Sightsound Technologies, Inc. of Sua Sponte Decisions of United States Patent and Trademark Office Vacating Previous Final Office Actions (Rinaldo, Richard) (Entered: 06/02/2006)

Copyright © 2010 LexisNexis CourtLink, Inc. All rights reserved.
*** THIS DATA IS FOR INFORMATIONAL PURPOSES ONLY ***



Switch Client | Preferences | Sign Out | Help

My Lexis™ Search Research Tasks Get a Document Shepard's® Alerts Total Litigator Transactional A

FOCUS™ Terms patno= 5191573

Search Within Original Results (1 - 1)

Using

Semantic Concepts What's this? Advanced...

Source: [Command Searching > Utility, Design and Plant Patents](#)

Terms: **patno= 5191573** ([Edit Search](#) | [Suggest Terms for My Search](#))

586391 (07) 5191573 March 2, 1993 ,

UNITED STATES PATENT AND TRADEMARK OFFICE GRANTED PATENT

5191573

[Access PDF of Official Patent *](#)

[Order Patent File History / Wrapper from REEDFAX®](#)

[Link to Claims Section](#)

March 2, 1993 ,

Method for transmitting a desired , , digital , , video or , , audio signal

REEXAM-LITIGATE:

Reexamination requested January 31, 2005 by Napster, Inc., Los Angeles, CA; c/o Albert S. Penilla, Martine, Penilla & Gencarella, LLP, Sunnyvale, CA, Reexamination No. 90/007,402 (O.G. March 29, 2005) Ex. Gp.: 2655 January 31, 2005

Reexamination requested January 31, 2005 by Napster, Inc., Los Angeles, CA; c/o Albert S. Penilla, Martine, Penilla & Gencarella, LLP, Sunnyvale, CA, Reexamination No. 90/007,402 (O.G. March 29, 2005) Ex. Gp.: 2655 January 31, 2005

INVENTOR: Hair, Arthur R. - 301 Oaklawn Dr., Pittsburgh, United States of America (US)

CERT-CORRECTION:

December 21, 1993 - a Certificate of Correction was issued for this Patent ,

APPL-NO: 586391 (07)

FILED-DATE: September 18, 1990

GRANTED-DATE: March 2, 1993 ,

PRIORITY: June 13, 1988 - 07206497, United States of America (US)

ASSIGNEE-AT-ISSUE:

HAIR; ARTHUR R., United States of America (US)

ASSIGNEE-AFTER-ISSUE:

October 2, 1995 - ASSIGNMENT OF ASSIGNORS INTEREST (SEE DOCUMENT FOR DETAILS)., PARSEC SIGHT/SOUND, INC. 1518 ALLISON DRIVE UPPER ST. CLAIR, PENNSYLVANIA, 15241, Reel and Frame Number: 007656/0701

May 3, 2000 - CHANGE OF NAME (SEE DOCUMENT FOR DETAILS)., SIGHTSOUND.COM

INCORPORATED 733 WASHINGTON ROAD, SUITE 400MT. LEBANON, PENNSYLVANIA, 15228,
Reel and Frame Number: 010776/0703

October 24, 2001 - NOTICE OF GRANT OF SECURITY INTEREST, KENYON & KENYON
ONE BROADWAYNEW YORK, NEW YORK, 10004, SCHWARTZ, ANSEL M. ONE STERLING
PLAZA 201 N. CRAIG STREET, SUITE 304PITTSBURGH, PENNSYLVANIA, 15213, WATERVIEW
PARTNERS, LLP ONE STERLING PLAZA 152 WEST 57TH STREET, 46TH FLOORNEW YORK,
NEW YORK, 10019, D&DF WATERVIEW PARTNERS, L.P. ONE STERLING PLAZA 152
WEST 57TH STREET, 46TH FLOORNEW YORK, NEW YORK, 10019, Reel and Frame Number:
012506/0415

December 27, 2005 - ASSIGNMENT OF ASSIGNORS INTEREST (SEE DOCUMENT FOR
DETAILS)., DMT LICENSING, LLC ONE INDEPENDENCE WAY PRINCETON NEW JERSEY 08540,
ONE INDEPENDENCE WAY, PRINCETON, NEW JERSEY, UNITED STATES OF AMERICA (US),
08540, Reel and Frame Number: 017555/0149

LEGAL-REP: Schwartz, Ansel M.

PUB-TYPE: March 2, 1993 - Patent (A)

PUB-COUNTRY: United States of America (US)

LEGAL-STATUS:

December 21, 1993 - CERTIFICATE OF CORRECTION October 2, 1995 - ASSIGNMENT OF
ASSIGNOR'S INTEREST October 2, 1995 - ASSIGNMENT OF ASSIGNOR'S INTEREST October
2, 1995 - ASSIGNMENT May 3, 2000 - ASSIGNMENT May 3, 2000 - ASSIGNMENT October
24, 2001 - ASSIGNMENT October 24, 2001 - ASSIGNMENT October 24, 2001 - ASSIGNMENT
October 24, 2001 - ASSIGNMENT October 24, 2001 - ASSIGNMENT October 24, 2001 -
ASSIGNMENT October 24, 2001 - ASSIGNMENT October 24, 2001 - ASSIGNMENT October
24, 2001 - ASSIGNMENT March 29, 2005 - REQUEST FOR REEXAMINATION FILED December
27, 2005 - ASSIGNMENT

FILING-LANG: English (EN) (ENG)

PUB-LANG: English (EN) (ENG)

REL-DATA:

Continuation of Ser. No. 206497 , June 13, 1988 , ABANDONED , September 18, 1990

US-MAIN-CL: 369#84 ,

US-ADDL-CL: 235#380 , , 235#381 , , 348#E07.071 , , 369#15 , , 369#85 , ,
G9B#20.002 , , G9B#27.002 , , G9B#27.012 , , G9B#27.019 , , G9B#27.051 ,

CL: 369 , , 235 , , 348 , , G9B ,

SEARCH-FLD: 235#375 , , 235#380 , , 235#381 , , 364#410 , , 364#479 , , 369#13 , ,
369#15 , , 369#33 , , 369#34 , , 369#84 , , 369#85 ,

IPC-MAIN-CL: [7] G11B 005#86

IPC-MAIN-CL: [8] G07F 017#00 (20060101) Core Inventive 20051008 (C I R M EP)

IPC-ADDL-CL: [7] G11B 007#00

IPC-ADDL-CL: [7] G11B 011#00

- IPC-ADDL-CL:** [8] G07F 017#16 (20060101) Advanced Inventive 20051008 (A I R M EP)
- IPC-ADDL-CL:** [8] G11B 020#00 (20060101) Core Inventive 20051008 (C I R M EP)
- IPC-ADDL-CL:** [8] G11B 020#00 (20060101) Advanced Inventive 20051008 (A I R M EP)
- IPC-ADDL-CL:** [8] G11B 027#00 (20060101) Core Inventive 20051008 (C I R M EP)
- IPC-ADDL-CL:** [8] G11B 027#00 (20060101) Advanced Inventive 20051008 (A I R M EP)
- IPC-ADDL-CL:** [8] G11B 027#31 (20060101) Core Inventive 20051008 (C I R M EP)
- IPC-ADDL-CL:** [8] G11B 027#34 (20060101) Advanced Inventive 20051008 (A I R M EP)
- IPC-ADDL-CL:** [8] G11B 027#10 (20060101) Core Inventive 20051008 (C I R M EP)
- IPC-ADDL-CL:** [8] G11B 027#10 (20060101) Advanced Inventive 20051008 (A I R M EP)
- IPC-ADDL-CL:** [8] G11B 027#34 (20060101) Core Inventive 20051008 (C I R M EP)
- IPC-ADDL-CL:** [8] G11B 027#34 (20060101) Advanced Inventive 20051008 (A I R M EP)
- IPC-ADDL-CL:** [8] H04H 001#02 (20060101) Core Inventive 20051008 (C I R M EP)
- IPC-ADDL-CL:** [8] H04H 001#02 (20060101) Advanced Inventive 20051008 (A I R M EP)
- IPC-ADDL-CL:** [8] H04N 007#173 (20060101) Core Inventive 20051008 (C I R M EP)
- IPC-ADDL-CL:** [8] H04N 007#173 (20060101) Advanced Inventive 20051008 (A I R M EP)

PRIM-EXMR: Nguyen; Hoa

REF-CITED:

3718906, February 27, 1973, Lightner, United States of America (US), 235#381
3990710, November 9, 1976, Hughes, United States of America (US), 369#34
4567359, January 28, 1986, Lockwood, United States of America (US), 235#381
4647989, March 3, 1987, Geddes, United States of America (US), 235#381
4654799, March 31, 1987, Ogaki et al., United States of America (US), 364#479

CORE TERMS: digital, music, audio, user, memory, song, electronically, hard disk, stored, hardware, video, electronic, playback, methodology, integrated, compact, display, random, disc, telecommunications, transmitting, additionally, tape, telephone lines, receiver, stereo, randomly, album, audio signal, random access memory

ENGLISH-ABST:

The present invention is a method for transmitting a desired digital video or audio signal stored on a first memory of a first party to a second memory of a second party. The method comprises the steps of transferring money via a telecommunications line to the first party from the second party. Additionally, the method comprises the step of then connecting electronically via a telecommunications line the first memory with the second memory such that the desired signal can pass therebetween. Next, there is the step of transmitting the desired digital signal from the first memory with a transmitter in control and in possession of the first party to a receiver having the second memory at a location determined by the second party. The receiver is in possession and in control of the second party. There is also

the step of then storing the digital signal in the second memory.

NO-OF-CLAIMS: 6

NO-OF-FIGURES: 2

PARENT-PAT-INFO:

This is a continuation of copending application Ser. No. 07/206,497 filed on Jun. 13, 1988, now abandoned.

SUMMARY:

FIELD OF THE INVENTION

The present invention is related to a method for the electronic sales and distribution of digital audio or video signals, and more particularly, to a method which a user may purchase and receive digital audio or video signal from any location which the user has access to a telecommunications line.

BACKGROUND OF THE INVENTION

The three basic mediums (hardware units) of music: records, tapes, and compact discs, greatly restricts the transferability of music and results in a variety of inefficiencies. CAPACITY: The individual hardware units as cited above are limited as to the amount of music that can be stored on each. MATERIALS: The materials used to manufacture the hardware units are subject to damage and deterioration during normal operations, handling, and exposure to the elements. SIZE: The physical size of the hardware units imposes constraints on the quantity of hardware units which can be housed for playback in confined areas such as in automobiles, boats, planes, etc. RETRIEVAL: Hardware units limit the ability to play, in a sequence selected by the user, songs from different albums. For example, if the user wants to play one song from ten different albums, the user would spend an inordinate amount of time handling, sorting, and cueing the ten different hardware units. SALES AND DISTRIBUTION: Prior to final purchase, hardware units need to be physically transferred from the manufacturing facility to the wholesale warehouse to the retail warehouse to the retail outlet, resulting in lengthy, lag time between music creation and music marketing, as well as incurring unnecessary and inefficient transfer and handling costs. Additionally, tooling costs required for mass production of the hardware units and the material cost of the hardware units themselves, further drives up the cost of music to the end user. QUALITY: Until the recent invention of Digital Audio Music, as used on Compact Discs, distortion free transfer from the hardware units to the stereo system was virtually impossible. Digital Audio Music is simply music converted into a very basic computer language known as binary. A series of commands known as zeros or ones encode the music for future playback. Use of laser retrieval of the binary commands results in distortion free transfer of the music from the compact disc to the stereo system. Quality Digital Audio Music is defined as the binary structure of the Digital Audio Music. Conventional analog tape recording of Digital Audio Music is not to be considered quality inasmuch as the binary structure itself is not recorded. While Digital Audio Music on compact discs is a technological breakthrough in audio quality, the method by which the music is sold, distributed, stored, manipulated, retrieved, played and protected from copyright infringements remains as inefficient as with records and tapes. COPYRIGHT PROTECTION: Since the invention of tape recording devices, strict control and enforcement of copyright laws have proved difficult and

impossible with home recorders. Additionally, the recent invention of Digital Audio Tape Recorders now jeopardizes the electronic copyright protection of quality Digital Audio Music on Compact Discs or Digital Audio Tapes. If music exists on hardware units, it can be copied. Accordingly, it is an objective of this invention is to provide a new and improved methodology/system to electronically sell and distribute Digital Audio Music. A further objective of this invention to provide a new and improved methodology/system to electronically store and retrieve Digital Audio Music. Another objective of this invention is to provide a new and improved methodology/system to electronically manipulate, i.e., sort, cue, and select, Digital Audio Music for playback. Still another objective of this invention is to offer a new and improved methodology/system which can prevent unauthorized electronic copying of quality Digital Audio Music.

SUMMARY OF THE INVENTION

Briefly, this invention accomplishes the above cited objectives by providing a new and improved methodology/system of electronic sales, distribution, storage, manipulation, retrieval, playback, and copyright protection of Digital Audio Music. The high speed transfer of Digital Audio Music as prescribed by this invention is stored onto one piece of hardware, a hard disk, thus eliminating the need to unnecessarily handle records, tapes, or compact discs on a regular basis. This invention recalls stored music for playback as selected/programmed by the user. This invention can easily and electronically sort stored music based on many different criteria such as, but not limited to, music category, artist, album, user's favorite songs, etc. An additional feature of this invention is the random playback of songs, also based on the user's selection. For example, the user could have this invention randomly play all jazz songs stored on the user's hard disk, or randomly play all songs by a certain artist, or randomly play all of the user's favorite songs which the user previously electronically "tagged" as favorites. Further, being more specific, the user can electronically select a series of individual songs from different albums for sequential playback. This invention can be configured to either accept direct input of Digital Audio Music from the digital output of a Compact Disc, such transfer would be performed by the private user, or this invention can be configured to accept Digital Audio Music from a source authorized by the copyright holder to sell and distribute the copyrighted materials, thus guaranteeing the protection of such copyrighted materials. Either method of electronically transferring Digital Audic Music by means of this invention is intended to comply with all copyright laws and restrictions and any such transfer is subject to the appropriate authorization by the copyright holder. Inasmuch as Digital Audio Music is software an this invention electronically transfers and stores such music, electronic sales and distribution of the music can take place via telephone lines onto a hard disk. This new methodology/system of music sales and distribution will greatly reduce the cost of goods sold and will reduce the lag time between music creation and music marketing from weeks down to hours. The present invention is a method for transmitting a desired digital video or audio signal stored on a first memory of a first party to a second memory of a second party. The method comprises the steps of transferring money via a telecommunications line to the first party from the second party. Additionally, the method comprises the step of then connecting electronically via a telecommunications line the first memory with the second memory such that the desired digital signal can pass therebetween. Next, there is the step of transmitting the desired digital signal from the first memory with a transmitter in control and in possession of the first party to a receiver having the second memory at a location determined by the second party. The receiver is in possession and in control of the second party. There is also the step of then storing the digital signal in the second memory. Further objectives and advantages of this invention will become apparent as the following description proceeds and the particular features of novelty which characterize this invention will be pointed out in the claims annexed to and forming a part of this declaration.

DRWDESC:

BRIEF DESCRIPTION OF THE SEVERAL VIEWS OF DRAWINGS

For a better understanding of this invention, reference should be made to the following detailed description, taken in conjunction with the accompanying drawings, in which: FIG. 1 is a pictorial flow chart which may be used in carrying out the teachings of this invention for the purposes of electronic sales, distribution, storage, manipulation, retrieval, playback, and copyright protection of Digital Audio Music; and FIG. 2 is a pictorial flow chart which may be used in carrying out the teachings of this invention for the purposes of electronic storage, manipulation, retrieval, and playback of Digital Audio Music.

DETDESC:**DESCRIPTION OF THE PREFERRED EMBODIMENT**

Referring now to the FIG. 1, this invention is comprised of the following: 10 Hard Disk of the copyright holder 20 Control Unit of the copyright holder 20a Control Panel 20b Control Integrated Circuit 20c Sales Random Access Memory Chip 30 Telephone Lines/Input Transfer 50 Control Unit of the user 50a Control Panel 50b Control Integrated circuit 50c Incoming Random Access Memory Chip 50d Play Back Random Access Memory Chip 60 Hard Disk of the user 70 Video Display Unit 80 Stereo Speakers. The Hard Disk 10 of the agent authorized to electronically sell and distribute the copyrighted Digital Audio Music is the originating source of music in the configuration as outlined in FIG. 1. The Control Unit 20 of the authorized agent is the means by which the electronic transfer of the Digital Audio Music from the agent's Hard Disk 10 via the Telephone Lines 30 to the user's Control Unit 50 is possible. The user's Control Unit would be comprised of a Control Panel 50a, a Control Integrated Circuit 50b, an Incoming Random Access Memory Chip 50c, and a Play Back Random Access Memory Chip 50d. Similarly, the authorized agent's Control Unit 20 would have a control panel and control integrated circuit similar to that of the user's Control Unit 50. The authorized agent's Control Unit 20, however, would only require the Sales Random Access Memory Chip 20c. The other components in FIG. 1 include a Hard Disk 60, a Video (display Unit 70, and a set of Stereo Speakers 80. Referring now to FIG. 2, with the exception of a substitution of a Compact Disc Player 40 (as the initial source of Digital Audio Music) for the agent's Hard Disk 10, the agent's Control Unit 20, and the Telephone Lines 30 in FIG. 1, FIG. 2 is the same as FIG. 1. In FIG. 1 and FIG. 2, the following components are already commercially available: the agent's Hard Disk 10, the Telephone Lines 30, the Compact Disc Player 40, the user's Hard Disk 60, the Video Display Unit 70, and the Stereo Speakers 80. The Control Units 20 and 50, however, would be designed specifically to meet the teachings of this invention. The design of the control units would incorporate the following functional features: 1) the Control Panels 20a and 50a would be designed to permit the agent and user to program the respective Control Integrated Circuits 20b and 50b, 2) the Control Integrated Circuits 20b and 50b would be designed to control and execute the respective commands of the agent and user and regulate the electronic transfer of Digital Audio Music throughout the system, additionally, the sales Control Integrated Circuit 20b could electronically code the Digital Audio Music in a configuration which would prevent unauthorized reproductions of the copyrighted material, 3) the Sales Random Access Memory Chip 20c would be designed to temporarily store user purchased Digital Audio Music for subsequent electronic transfer via telephone lines to the user's Control Unit 50, 4) the Incoming Random Access Memory Chip 50c would be designed to temporarily store Digital Audio Music for subsequent electronic storage to the user's Hard Disk 60, 5) the Play Back Random Access Memory Chip 50d would be designed to temporarily store Digital Audio Music for sequential playback. The foregoing description of the Control Units 20 and 50 is intended as an example only and thereby is not

restrictive with respect to the exact number of components and/or its actual design. Once the Digital Audio Music has been electronically stored onto the user's Hard Disk 60, having the potential to store literally thousands of songs, the user is free to perform the many functions of this invention. To play a stored song, the user types in the appropriate commands on the Control Panel 50a, and those commands are relayed to the Control Integrated Circuit 50b which retrieves the selected song from the Hard Disk 60. When a song is retrieved from the Hard Disk 60 only a replica of the permanently stored song is retrieved. The permanently stored song remains intact on the Hard Disk 60, thus allowing repeated playback. The Control Integrated Circuit 50b stores the replica onto the Play Back Random Access Memory Chip 50d at a high transfer rate. The Control Integrated Circuit 50b then sends the electronic output to the Stereo Speakers 80 at a controlled rate using the Play Back Random Access Memory Chip 50d as a temporary staging point for the Digital Audio Music. Unique to this invention is that the Control Unit 50 also serves as the user's personal disk jockey. The user may request specific songs to be electronically cued for playback, or may request the Control Unit 50 to randomly select songs based on the user's criteria. All of these commands are electronically stored in random access memory enabling the control unit to remember prior commands while simultaneously performing other tasks requested by the user and, at the same time, continuing to play songs previously cued. Offering a convenient visual display of the user's library of songs is but one more new and improved aspect of this invention. As the Control Unit 50 is executing the user's commands to electronically sort, select, randomly play, etc., the Video Display Screen 70 is continually providing feedback to the user. The Video Display Screen 70 can list/scroll all songs stored on the Hard Disk 60, list/scroll all cued songs, display the current command function selected by the user, etc. Further expanding upon the improvements this invention has to offer, the Video Display Screen 70 can display the lyrics of the song being played, as well as the name of the song, album, artist, recording company, date of recording, duration of song, etc. This is possible if the lyrics and other incidental information are electronically stored to the Hard Disk 60 with the Digital Audio Music. The present invention is a method for transmitting a desired digital video or audio signal stored on a first memory of a first party to a second memory of a second party. The method comprises the steps of transferring money via a telecommunications line to the first party from the second party. Additionally, the method comprises the step of then connecting electronically via a telecommunications line the first memory with the second memory such that the desired digital signal can pass therebetween. Next, there is the step of transmitting the desired digital signal from the first memory with a transmitter in control and in possession of the first party to a receiver having the second memory at a location determined by the second party. The receiver is in possession and in control of the second party. There is also the step of then storing the digital signal in the second memory. In summary, there has been disclosed a new and improved methodology/system by which Digital Audio Music can be electronically sold, distributed, transferred, and stored. Further, there has been disclosed a new and improved methodology/system by which Digital Audio Music can be electronically manipulated, i.e., sorted, cued, and selected for playback. Further still, there has been disclosed a new and improved methodology/system by which the electronic manipulation of Digital Audio Music can be visually displayed for the convenience of the user. Additionally, there has been disclosed a new and improved methodology/system by which electronic copyright protection of quality Digital Audio Music is possible through use of this invention. Since numerous changes may be made in the above described process and apparatus and different embodiments of the invention may be made without departing from the spirit thereof, it is intended that all matter contained in the foregoing description or shown in the accompanying drawings shall be interpreted as illustrative, and not in a limiting sense. Further, it is intended that this invention is not to be limited to Digital Audio Music and can include Digital Video, Digital Commercials, and other applications of digital information.

ENGLISH-CLAIMS:

[Return to Top of Patent](#)

1. A method for transmitting a desired digital audio signal stored on a first memory of a first party to a second memory of a second party comprising the steps of: transferring money electronically via a telecommunication lien to the first party at a location remote from the second memory and controlling use of the first memory from the second party financially distinct from the first party, said second party controlling use and in possession of the second memory; connecting electronically via a telecommunications line the first memory with the second memory such that the desired digital audio signal can pass therebetween; transmitting the desired digital audio signal from the first memory with a transmitter in control and possession of the first party to a receiver having the second memory at a location determined by the second party, said receiver in possession and control of the second party; and storing the digital signal in the second memory.

2. A method as described in claim 1 including after the transferring step, the steps of searching the first memory for the desired digital audio signal; and selecting the desired digital audio signal from the first memory.

3. A method as described in claim 2 wherein the transferring step includes the steps of telephoning the first party controlling use of the first memory by the second party; providing a credit card number of the second party controlling the second memory to the first party controlling the first memory so the second party is charged money.

4. A method for transmitting a desired digital video signal stored on a first memory of a first party to a second memory of a second party comprising the steps of: transferring money electronically via a telecommunications line to the first party at a location remote from the second memory and controlling use of the first memory, from a second party financially distinct from the first party, said second party in control and in possession of the second memory; connecting electronically via a telecommunications line the first memory with the second memory such that the desired digital video signal can pass therebetween; transmitting the desired digital video signal from the first memory with a transmitter in control and possession of the first party to a receiver having the second memory at a location determined by the second party, said receiver in possession and control of the second party; and storing the digital signal in the second memory.

5. A method as described in claim 4 including after the transferring money step, the step of searching the first memory for the desired digital signal and selecting the desired digital signal from the first memory.

6. A method as described in claim 5 wherein the transferring step includes the steps of telephoning the first party controlling use of the first memory by the second party controlling the second memory; providing a credit card number of the second party controlling the second memory to the first party controlling the first memory so the second party controlling the second memory is charged money.

LOAD-DATE: November 17, 2009

Source: [Command Searching > Utility, Design and Plant Patents](#) 

Terms: **patno= 5191573** ([Edit Search](#) | [Suggest Terms for My Search](#))

View: Full

Date/Time: Wednesday, February 17, 2010 - 1:12 PM EST

[My Lexis™](#) | [Search](#) | [Research Tasks](#) | [Get a Document](#) | [Shepard's®](#) | [Alerts](#) | [Total Litigator](#) | [Transactional Advisor](#) | [Counsel Selector](#)

[History](#) | [Delivery Manager](#) | [Switch Client](#) | [Preferences](#) | [Sign Out](#) | [Help](#)



LexisNexis® [About LexisNexis](#) | [Terms & Conditions](#) | [Contact Us](#)
Copyright © 2010 LexisNexis, a division of Reed Elsevier Inc. All rights reserved.

FOCUS™ Terms 5191573 or 5,191,573

Search Within Original Results (1 - 2)



Advanced...

Source: [Command Searching](#) > **Patent Cases from Federal Courts and Administrative Materials**

Terms: **5191573 or 5,191,573** ([Edit Search](#) | [Suggest Terms for My Search](#))

Select for FOCUS™ or Delivery

- 1. [Sightsound.com, Inc. v. N2K, Inc.](#), Civil Action No. 98-0118 , UNITED STATES DISTRICT COURT FOR THE WESTERN DISTRICT OF PENNSYLVANIA, 391 F. Supp. 2d 321; 2003 U.S. Dist. LEXIS 25503, October 23, 2003, Decided

OVERVIEW: Defendant was denied summary judgment on claims of patent invalidity; earlier patent described only "possibility" of use of unit in way that anticipated use of patent-in-suit, not the required "necessity," and fact question existed as to obviousness.

CORE TERMS: patent, digital, sightsound, invention, music, summary judgment, signal, prior art, license, consumer ...

... United States Patent No. **5,191,573** ("the '573 Patent") ...

- 2. [Sightsound.com Inc. v. N2k, Inc.](#), Civil Action No. 98-118 , UNITED STATES DISTRICT COURT FOR THE WESTERN DISTRICT OF PENNSYLVANIA, 185 F. Supp. 2d 445; 2002 U.S. Dist. LEXIS 6828, February 8, 2002, Decided

OVERVIEW: In an action involving patents which were directed to commercially-acceptable systems and methods for selling music and video in digital form over telecommunications lines, the judge made several recommendations regarding claim construction.

CORE TERMS: digital, memory, telecommunication, electronically, patent, audio signals, signal, specification, desired, transferring ...

... S. Patent Nos. **5,191,573** ("the '573 Patent"), 5,675,734 ("the '734 Patent") ...

Source: [Command Searching](#) > **Patent Cases from Federal Courts and Administrative Materials**

Terms: **5191573 or 5,191,573** ([Edit Search](#) | [Suggest Terms for My Search](#))

View: Cite

Date/Time: Wednesday, February 17, 2010 - 1:15 PM EST

* Signal Legend:

- Warning: Negative treatment is indicated
- Questioned: Validity questioned by citing refs
- Caution: Possible negative treatment
- Positive treatment is indicated
- Citing Refs. With Analysis Available
- Citation information available

* Click on any *Shepard's* signal to *Shepardize*® that case.

[My Lexis™](#) | [Search](#) | [Research Tasks](#) | [Get a Document](#) | [Shepard's®](#) | [Alerts](#) | [Total Litigator](#) | [Transactional Advisor](#) | [Counsel Selector](#)
[History](#) | [Delivery Manager](#) | [Switch Client](#) | [Preferences](#) | [Sign Out](#) | [Help](#)



LexisNexis®

[About LexisNexis](#) | [Terms & Conditions](#) | [Contact Us](#)
[Copyright © 2010 LexisNexis](#), a division of Reed Elsevier Inc. All rights reserved.

No Documents Found

No documents were found for your search terms

"5191573 or 5,191,573"

Click "Save this search as an Alert" to schedule your search to run in the future.

- OR -

Click "Edit Search" to return to the search form and modify your search.

Suggestions:

- Check for spelling errors .
 - Remove some search terms.
 - Use more common search terms, such as those listed in "Suggested Words and Concepts"
 - Use a less restrictive date range.
-

Save this Search as an Alert



LexisNexis®

[About LexisNexis](#) | [Terms & Conditions](#) | [Contact Us](#)

Copyright © 2010 LexisNexis, a division of Reed Elsevier Inc. All rights reserved.

LexisNexis® Total Research System

Switch Client | Preferences | Sign Out | ? Help

My Lexis™ Search Research Tasks Get a Document Shepard's® Alerts Total Litigator Transactional A

FOCUS™ Terms 5191573 or 5,191,573

Search Within Original Results (1 - 16)



Advanced...

Source: [Command Searching](#) > [News, All \(English, Full Text\)](#) ⓘTerms: **5191573** or **5,191,573** ([Edit Search](#) | [Suggest Terms for My Search](#))

☑ Select for FOCUS™ or Delivery

- 1. [Intellectual Property Today](#), April, 2004, INTERNETINFO.COLUMN; Pg. 49, 718 words, Will the Price of Music Downloads Include Patent License Fees?, BY W. SCOTT PETTY; Scott Petty, a Patent Attorney with King & Spalding, focuses on intellectual property issues for computer software, telecommunications and e-commerce companies. Scott can be contacted by telephone at 404.572.2888 or via e-mail at spetty@kslaw.com.
... U.S. Patent Nos. **5,191,573** and 5,675,734, which date back to ...
- 2. [Rutgers Computer & Technology Law Journal](#), March 22, 2002, Pg. 61 (60), 84020686, 24304 words, The multiple unconstitutionality of business method patents: common sense, congressional consideration, and constitutional history., Pollack, Malla
... (41.) You may feel uncomfortable with the wrapping method claim because it seems obvious -- as do many currently issued business patents. See, e.g., 146 CONG. REC. E1659 (daily ed. of Oct. 4, 2000) (statement of Rep. Berman) (criticizing recent grant of obvious business patents including U.S. Patent No. **5,191,573** (issued Mar. 2 1993) for a method of selling audiovisual products over the internet and U.S. Patent No. 5,825,651 (issued Oct. 20, 1998) for a method of allowing internet car purchasers to choose options), available at ...
- 3. [Canadian Press Newswire](#), September 4, 2001, Pg. S 4'01, 5191573, 77 words, Trio of alleged drug-smugglers from Montreal elect trial by judge alone
- 4. [Canadian Press Newswire](#), September 4, 2001, Pg. S 4'01, 5191573, 77 words, Trio of alleged drug-smugglers from Montreal elect trial by judge alone (Record in progress)
- 5. [The Toronto Sun](#), May 19, 2000, Friday,, Final EDITION, NEWS,, Pg. 32, 174 words, KILLER INSULTS VICTIM'S KIN, ALAN CAIRNS, TORONTO SUN, BARRIE
- 6. [Technology Review \(Cambridge, Mass.\)](#), March 1, 2000, Pg. 68, 60121150, 4534 words, Software Patents Tangle the Web; Industry Trend or Event, SHULMAN, SETH
... Sightsound.com **5,191,573** music downloads ...
- 7. [Mondaq Business Briefing - Hale and Dorr LLP, US](#), November 3, 1999, 02275027, 2050 words, US: Business Methods Patents - The Effects Of State Street On Electronic Commerce And The Internet, Alter, Scott M
... 7. Patent number **5,191,573** and 5,675,734 ...
- 8. [Mondaq Business Briefing](#), November 3, 1999, 2275027, 2043 words, US: Business Methods Patents - The Effects Of State Street On Electronic Commerce And The Internet SO[Hale and Dorr LLP, US] SO, Alter, Scott M
... 7. Patent number **5,191,573** and 5,675,734 8. Unlike ...
- 9. [Salon.com](#), March 9, 1999 Tuesday, Feature, 2469 words, How can they patent that?, By Peter Wayner

... eyes. Or consider patents **5191573** and 5675734, created by ...
... N2K, is evaluating what patents **5191573** and 5675734 mean to his
company's ...

- 10. Business Wire, May 19, 1998, Tuesday, 867 words, Digital Sight/Sound Rolls Out First Patented Method for Sale of Digital Audio/Video Over the Internet, LOS ANGELES
... United States Patents **5,191,573** and 5,675,734. "A2B is a ...

Source: [Command Searching > News, All \(English, Full Text\)](#) 

Terms: **5191573** or **5,191,573** ([Edit Search](#) | [Suggest Terms for My Search](#))

View: Cite

Date/Time: Wednesday, February 17, 2010 - 1:16 PM EST

[My Lexis™](#) | [Search](#) | [Research Tasks](#) | [Get a Document](#) | [Shepard's®](#) | [Alerts](#) | [Total Litigator](#) | [Transactional Advisor](#) | [Counsel Selector](#)
[History](#) | [Delivery Manager](#) | [Switch Client](#) | [Preferences](#) | [Sign Out](#) | [Help](#)



LexisNexis®

[About LexisNexis](#) | [Terms & Conditions](#) | [Contact Us](#)

Copyright © 2010 LexisNexis, a division of Reed Elsevier Inc. All rights reserved.



UNITED STATES PATENT AND TRADEMARK OFFICE

UNITED STATES DEPARTMENT OF COMMERCE
United States Patent and Trademark Office
Address: COMMISSIONER FOR PATENTS
P.O. Box 1450
Alexandria, Virginia 22313-1450
www.uspto.gov

APPLICATION NO.	FILING DATE	FIRST NAMED INVENTOR	ATTORNEY DOCKET NO.	CONFIRMATION NO.
90/007,402	01/31/2005	5191573	NAPS001	2998

23973 7590 03/25/2010

DRINKER BIDDLE & REATH
ATTN: INTELLECTUAL PROPERTY GROUP
ONE LOGAN SQUARE, SUITE 2000
PHILADELPHIA, PA 19103-6996

EXAMINER

ART UNIT PAPER NUMBER

DATE MAILED: 03/25/2010

Please find below and/or attached an Office communication concerning this application or proceeding.



UNITED STATES PATENT AND TRADEMARK OFFICE

Commissioner for Patents
United States Patent and Trademark Office
P.O. Box 1450
Alexandria, VA 22313-1450
www.uspto.gov

DO NOT USE IN PALM PRINTER

(THIRD PARTY REQUESTER'S CORRESPONDENCE ADDRESS)

Albert S. Penilla
Martine Penilla & Gencarella, LLP
710 Lakeway Drive, Suite 200
Sunnyvale, CA 94085

MAILED

MAR 25 2010

CENTRAL REEXAMINATION UNIT

EX PARTE REEXAMINATION COMMUNICATION TRANSMITTAL FORM

REEXAMINATION CONTROL NO. 90/007,402.

PATENT NO. 5191573.

ART UNIT 3992.

Enclosed is a copy of the latest communication from the United States Patent and Trademark Office in the above identified *ex parte* reexamination proceeding (37 CFR 1.550(f)).

Where this copy is supplied after the reply by requester, 37 CFR 1.535, or the time for filing a reply has passed, no submission on behalf of the *ex parte* reexamination requester will be acknowledged or considered (37 CFR 1.550(g)).

Office Action in Ex Parte Reexamination	Control No. 90/007,402	Patent Under Reexamination 5191573	
	Examiner ROLAND G. FOSTER	Art Unit 3992	

-- The MAILING DATE of this communication appears on the cover sheet with the correspondence address --

- a Responsive to the communication(s) filed on 15 December 2008. b This action is made FINAL.
c A statement under 37 CFR 1.530 has not been received from the patent owner.

A shortened statutory period for response to this action is set to expire 2 month(s) from the mailing date of this letter. Failure to respond within the period for response will result in termination of the proceeding and issuance of an *ex parte* reexamination certificate in accordance with this action. 37 CFR 1.550(d). **EXTENSIONS OF TIME ARE GOVERNED BY 37 CFR 1.550(c)**. If the period for response specified above is less than thirty (30) days, a response within the statutory minimum of thirty (30) days will be considered timely.

Part I THE FOLLOWING ATTACHMENT(S) ARE PART OF THIS ACTION:

1. Notice of References Cited by Examiner, PTO-892. 3. Interview Summary, PTO-474.
2. Information Disclosure Statement, PTO/SB/08. 4. _____.

Part II SUMMARY OF ACTION

- 1a. Claims 1-6 are subject to reexamination.
1b. Claims _____ are not subject to reexamination.
2. Claims _____ have been canceled in the present reexamination proceeding.
3. Claims _____ are patentable and/or confirmed.
4. Claims 1-6 are rejected.
5. Claims _____ are objected to.
6. The drawings, filed on _____ are acceptable.
7. The proposed drawing correction, filed on _____ has been (7a) approved (7b) disapproved.
8. Acknowledgment is made of the priority claim under 35 U.S.C. § 119(a)-(d) or (f).
a) All b) Some* c) None of the certified copies have
1 been received.
2 not been received.
3 been filed in Application No. _____.
4 been filed in reexamination Control No. _____.
5 been received by the International Bureau in PCT application No. _____.
* See the attached detailed Office action for a list of the certified copies not received.
9. Since the proceeding appears to be in condition for issuance of an *ex parte* reexamination certificate except for formal matters, prosecution as to the merits is closed in accordance with the practice under *Ex parte* Quayle, 1935 C.D. 11, 453 O.G. 213.
10. Other: _____

cc: Requester (if third party requester)

DETAILED ACTION

Prosecution Reopened

Claims 1-6 and 44-49 were pending in the present reexamination proceeding. Specifically, original, independent claims (claims 1 and 4) were amended, new claims 44-49 were added during this reexamination proceeding, and the remaining new claims cancelled. The rejection of these claims was appealed to the Board of Patent Appeals and Interferences (the "Board"), who rendered a decision on September 4, 2009.

The subject patent under reexamination however, U.S. Patent No. 5,191,573 (the "Hair" patent), issued March 2, 1993 based on United States Application 07/586,391, filed September 18, 1990. The Hair patent also claimed entitlement to the filing date June 13, 1988. Thus, the Hair patent under reexamination was enforceable until March 2, 2010. 35 USC § 154.

During a reexamination proceeding, no amendment may be proposed for entry in an expired patent. 37 C.F.R. §1.530(j). Furthermore, amendments are not effective until the reexamination certificate is used and published. 37 C.F.F. §1.530(k). See also MPEP § 2250.

Thus, the Board's decision decided the propriety of claim rejections subject to amendments effectively withdrawn on March 2, 2010 by the mandatory expiration of the Hair patent term. The original **claims 1-6** however stood rejected before the now (effectively) withdrawn amendments. See the Office action, mailed September 29, 2006. Thus, in accordance with 37 C.F.R. §1.198, prosecution is reopened and a new grounds of rejection is

Art Unit: 3992

made (below) to the originally granted **claims 1-6** as they existed prior to the mandatory withdrawal of all amendments. See also MPEP § 1214.04.

Irem Yucel
TC Director

Claim Interpretation

As discussed above, the Hair patent under reexamination appears to have expired on March 2, 2010. Regarding reexamination of expired patent, MPEP § 2258.I.G states:

In a reexamination proceeding involving claims of an expired patent, claim construction pursuant to the principle set forth by the court in *Phillips v. AWH Corp.*, 415 F.3d 1303, 1316, 75 USPQ2d 1321, 1329 (Fed. Cir. 2005) (words of a claim “are generally given their ordinary and customary meaning” as understood by a person of ordinary skill in the art in question at the time of the invention) should be applied since the expired claim are not subject to amendment.

Regarding “ordinary and customary meaning,” MPEP § 2111.01.III states:

The ordinary and customary meaning of a claim term is the meaning that the term would have to a person of ordinary skill in the art in question at the time of the invention, i.e., as of the effective filing date of the patent application.” *Phillips v. AWH Corp.*, 415 F.3d 1303, 1313, 75 USPQ2d 1321, 1326 (Fed. Cir. 2005) (en banc).

....
The ordinary and customary meaning of a term may be evidenced by a variety of sources, including “the words of the claims themselves, the remainder of the specification, the prosecution history, and extrinsic evidence concerning relevant scientific principles, the meaning of technical terms, and the state of the art.” *Phillips v. AWH Corp.*, 415 F.3d at 1314, 75 USPQ2d at 1327.

In the present Office action, the claims are given their ordinary and customary meaning. The meaning of each claim term in the office actions is the meaning that the term would have to

Art Unit: 3992

a person of ordinary skill in the art in question at the time of the invention. The ordinary and customary meaning given to the claim terms in the office action are evidenced by the claims themselves and the remainder of the specification. For example, the examiner applies prior art, such as Bush to teach the digital transfer of digital audio and video files via "telecommunication lines" in a manner consistent with the meaning the claim terms would have to one of ordinary skill in the art based on the specification of the Hair patent under reexamination. See the rejection of claim 1 for additional details.

Claim Rejections Based on Bush

35 USC § 102

The following is a quotation of the appropriate paragraphs of 35 U.S.C. 102 that form the basis for the rejections under this section made in this Office action:

A person shall be entitled to a patent unless –

(e) the invention was described in (1) an application for patent, published under section 122(b), by another filed in the United States before the invention by the applicant for patent or (2) a patent granted on an application for patent by another filed in the United States before the invention by the applicant for patent, except that an international application filed under the treaty defined in section 351(a) shall have the effects for purposes of this subsection of an application filed in the United States only if the international application designated the United States and was published under Article 21(2) of such treaty in the English language.

Claims 1-6 are rejected under 35 U.S.C. 102(e) as being anticipated by U.S. Patent No. 4,789,863 ("Bush"), of record.

Regarding **claim 1**,

A method for transmitting a desired digital audio signal stored on a first memory of a first party to a second memory of a second party comprising the steps of:

Bush teaches transmitting a desired digital, audio or video signal (col. 2, ll. 18-29 and col. 3, ll. 26 - 35). The digital audio or video signals are stored on compact disc machines 41-46 (first memory) of a pay per view entertainment system provider associated with source 10 (first party) (Figs. 1, 4 and col. 2, ll. 19-47). The digital signals are transmitted via a network to the consumer's receiver 14 (Fig. 1) (also illustrated as receiver 100 in Fig. 5, see also col. 3, ll. 14-17). The signals are stored on cassette recording unit and an associated cassette tape (second memory) (Fig. 5 and col. 4, ll. 1-11). Note that the second memory is also a compact disc recorder (col. 10, claim 14) and thus the second memory may also be a CD.

transferring money electronically via a telecommunication line to the first party at a location remote from the second memory and controlling use of the first memory from the second party financially distinct from the first party, said second party controlling use and in possession of the second memory;

Bush teaches that money is electronically transferred via a telephone line (telecommunications line) and clearing house 200 to the source 10 (first party) by way of a credit card transaction (Fig. 3 and col. 2, ll. 58-63, col. 4, ll. 44-47, col. 5, ll. 1-3, col. 6, ll. 25-28, and ll. 45-48). The first party's location (source 10) is remote via a network from the consumer (Fig. 1). The second party (consumer) commands the download of audio/video from the memories of the first party (source 10) (Fig. 7, col. 1, ll. 59-64, and col. 6, ll. 11-48). Thus, the first memory is controlled from the second party. Clearly, the second party (consumer) is financially distinct from the first party (source 10). The second party (consumer) also controls the use and also

Art Unit: 3992

possesses the second memory, such as by the ability to determine what contents are stored in the second memory (col. 6, ll. 11-48)

connecting electronically via a telecommunications line the first memory with the second memory such that the desired digital audio signal can pass therebetween;

The limitation again broadly recites "a telecommunications line," which lacks antecedent basis to the previous recitation of a telecommunications line. Thus, the claim is reasonably interpreted to include one or more telecommunication lines. The examiner interprets a "telecommunications line" to mean transmission of a signal over lines over a distance. The interpretation is consistent with the specification of the Hair patent under reexamination, which provides few details of a telecommunication line, only describing a telephone line as a particular embodiment of a telecommunication line. Fig. 1. See also the Hair U.S. Patent No. 5,675,734, which is claimed by the patent owner to be a continuation of the current patent under reexamination. In that patent, the patent owner states the "telecommunications lines are preferably telephone lines." Col. 7, ll. 52 & 53. Thus, telecommunications lines are reasonably interpreted to not be limited to the preferred embodiment -- telephone lines. This interpretation is also consistent with the interpretation preferred by the patent owner, who argues "telecommunication lines" requires electronic mediums for communicating between computers, which requires end-to-end connectivity. Sightsound.com Inc. v. NSK, Inc. Cdnow, Inc., and Cdnow Online, Inc., Civil Action No. 98-118, pp. 50 and 57 (District Court for the Western District of Pennsylvania, Feb. 2002). Here, Bush teaches of a cable system (electronic medium) that provides end-to-end communications between computer at the central cable system

Art Unit: 3992

associated with source 10 and the consumer's computer (Figs. 1, 2 and 5). The audio and video files are downloaded via the telecommunications line and thus connect the first and second memories, as discussed above.

transmitting the desired digital audio signal from the first memory with a transmitter in control and possession of the first party to a receiver having the second memory at a location determined by the second party, said receiver in possession and control of the second party; and

The desired digital audio or video signal is transmitted from the first memory as discussed above using a transmitter (Fig. 4, CADA transceiver 40) in control (col. 2, ll. 18-21) and possession of the first party, such as when the first party (source 10) determines what contents are stored in the first memory (col. 2, ll. 30-42). The second party (consumer) determines the location to which the audio/video data is transmitted as broadly recited by the claims, such as the consumer operates the invention by turning on the television and interacts with the pay per view channel at a location (e.g., consumer's home) determined by the consumer. The receiver 14 includes a cassette tape (or CD) (as discussed above) that is in possession and control of the second party (col. 1, ll. 59-64).

storing the digital signal in the second memory.

The received audio/video digital signal is stored in the second memory (cassette tape or CD) associated with the second party (consumer) as discussed above. See also col. 5, ll. 24-52.

Art Unit: 3992

Claim 4 differs substantively from claim 1 in that claim 4 recites that digital "video" signal is transmitted (downloaded) as opposed to the audio signal in claim 1. However, the claim 1 rejection clearly explained how Bush teaches that both audio and video digital signals are downloaded. Therefore, see the claim 1 rejection for additional details.

Regarding **claims 2 and 5**, after the money transfer step, the home user searches for a recording signal from the remote library (e.g., forward and reverse roll commands) and then for a subsequent video/audio file from the remote library for the purposes of recording, where the video/audio file is stored in the first memory, as discussed above (col. 5, ll. 35-44 and col. 6, ll. 23-48).

Regarding **claims 3 and 6**, Bush teaches a system for downloading audio and video files from a central library to a user, where the user pays for the audio files and stores the audio files (abstract and Figs. 1 and 6). Bush also teaches that the user provides a credit card number to the second party (library) (col. 4, ll. 44-47, col. 5, ll. 1-3, col. 6, ll. 25-28, and ll. 45-48). Indeed, Bush further teaches "[f]unds deposited into the central receiving account [of the first party] will also carry the following information" including a credit card transaction type and the card number for that transaction (col. 6, ll. 49-64).

Claim Rejections Based on Gallagher

35 USC § 103

The following is a quotation of 35 U.S.C. 103(a) which forms the basis for all obviousness rejections set forth in this Office action:

(a) A patent may not be obtained though the invention is not identically disclosed or described as set forth in section 102 of this title, if the differences between the subject matter sought to be patented and the prior art are such that the subject matter as a whole would have been obvious at the time the invention was made to a person having ordinary skill in the art to which said subject matter pertains. Patentability shall not be negated by the manner in which the invention was made.

Claims 1-6 are rejected under 35 U.S.C. 103(a) as being unpatentable over UK Patent Application Publication No. GB 2 178 275 A ("Gallagher") in view of U.S. Patent No. 4,528,643 ("Freeny"), both of which are of record.

Regarding **claim 1**,

A method for transmitting a desired digital audio signal stored on a first memory of a first party to a second memory of a second party comprising the steps of:

Gallagher teaches transmitting audio and visual signals (page 1, ll. 5-10 and 84-92) stored on a first memory (Fig. 2, which illustrates a "database" comprising storage 23, see also page 1, ll. 60 & 61) of a first party (record company) (page 1, ll. 39-54) to a second memory (Fig. 3, storage medium 32) of a second party (household user).

connecting electronically via a telecommunications line the first memory with the second memory such that the desired digital audio signal can pass therebetween;

Art Unit: 3992

Gallagher teaches connecting via an electronic, telephone line (telecommunications line) (page 1, ll. 28-32) the first memory (database storage 23) with the second memory (storage medium 32) such that the digital audio (music and music information) passes therebetween (page 1, ll. 39-54).

transmitting the desired digital audio signal from the first memory with a transmitter in control and possession of the first party to a receiver having the second memory at a location determined by the second party, said receiver in possession and control of the second party;

The desired digital audio or video signal is transmitted from the first memory as discussed above using a transmitter (database comprising transmitter/receiver 20) (Fig. 2 and page 1, ll. 68-86) in control and possession of the first party (record company) because the database "belong[s]" to the record company and because the record company controls the unit by choosing what data to transfer to the unit for "sale" to the general public. Page 1, ll. 44-54. The receiver (user unit comprising receiver 30) (Fig. 3) is in possession and control of the second party because the second party (user) determines the location to which the audio/video data is transmitted as broadly recited by the claims, such as the user at home logs onto the user unit, selects the desired data, "buys" the data, and downloads the data to the user's home. Page 1, ll. 87-92 & 100-107 and page 2, l. 92.

transferring money electronically via a telecommunication line to the first party at a location remote from the second memory and controlling use of the first memory from the second party financially distinct from the first party, said second party controlling use and in possession of the second memory;

As discussed above, Gallagher teaches that the digital music data is: 1) "purchased" by the household user (second party) automatically via the telecommunications line (telephone line) and thus the first and second party are financially distinct, 2) the first party is at a location (host) remote from second party (house), and 3) the first party (record company) controls the first memory and the second party (household user) controls and possesses the second memory, Gallagher however fails to specifically detail how the purchase is transacted (e.g., by transferring money electronically via the telecommunication line).

Freeny discloses a method of electronically distributing and selling audio and video data from remote, information control machines 14 (first party) to information control machines 12 (second party) (abstract, col. 4, ll. 35-60, col. 5, ll. 10-15, col. 7, l. 50 - col. 8, l. 28, and col. 11, ll. 10-58) also known as "point of sales" locations (col. 4, ll. 35-60), which include a "consumer's home (point of sale location)" (col. 3, ll. 64-68) by way of having the requesting user transmit a consumer credit card number along with their request for the audio and video data (col. 13, lines 25-29).

The suggestion/motivation for combining Gallagher with Freeny would have been because Freeny's method of electronic sale allows the selling party to more reliably and receive compensation (increase revenue) for the sale of product because the "owner of the information receives directly the compensation for each sale of a recording and such compensation is received before the reproduction is authorized." Col. 13, lines 36-39. In addition, revenue would have been increased by merely supporting the use of credit card transactions. For

Art Unit: 3992

example, credit cards permit customers to make purchases in cases where they do not have cash on hand, as would have been notoriously well known in the art. Furthermore, providing support for credit card transactions would have increased the speed and efficiency of the financial transaction by eliminating the steps of separately mailing payment to the seller, processing the payment, and then sending the purchased good to the buyer.

In addition, combining prior art elements according to known methods to yield predictable results is obvious. *KSR v. Teleflex*, 550 U.S. 395, 417 (2007). The above analysis establishes that the prior art (Gallagher and Freeny) includes each element claimed, but just not in one single prior art reference. One of ordinary skill in the art at the time the invention was made however would have recognized that in combination, Gallagher and Freeny predictably perform their respective functions as they would have separately. For example, in combination Gallagher still transfers digital audio music to the user after purchase and Freeny still teaches allowing the seller of digital audio and video data to directly receive compensation for sale before transferring the data, such as by supporting credit card transactions. One of ordinary skill in the art would have also recognized that the results of the combination were predictable. For example, even when the second party was in possession of the second memory at the second party's house as clearly taught by Gallagher, the advantage of receiving compensation, and particularly a credit card transaction, from the second party before transferring data (Freeny) would have predictably been the same -- to increase revenue due to more reliable compensation for the sold product and to increased sales due to customers purchasing on credit, to increase

Art Unit: 3992

sales due to customers at home purchasing on credit, and to advantageously increase the speed and efficiency of the financial transaction.

Therefore, it would have been obvious to one of ordinary skill in the art at the time the invention was made to have the requesting user's of Gallagher transmit a consumer credit card number along with their request for the digital audio and video data so that the source unit could approve and charge the sale of the digital data to the consumer credit card before the product (digital audio or video) is released, thereby "transferring money electronically via a telecommunication line" as recited.

Claim 4 differs substantively from claim 1 in that claim 4 recites that digital "video" signal is transmitted (downloaded) as opposed to the audio signal in claim 1. However, the claim 1 rejection clearly explained how Gallagher teaches that both audio and video digital signals are downloaded. Therefore, see the claim 1 rejection for additional details.

Regarding **claims 2 and 5**, Gallagher teaches searching the first memory for the desired digital audio and video signals via a menu selection process (page 1, ll. 102-107). In the claim 1 rejection, from which these claims depend, Freeny was relied upon to teach the obvious addition of transmitting a consumer credit card number along with the request for the audio and video data thereby resulting in the host memory being searched after the transfer of money in order to receive "compensation...before the reproduction is authorized." See also page 13, ll. 25-48.

Regarding **claims 3 and 6**, Gallagher teaches that second party (household user) initiates a connection with the first party via a telephone modem link to initiate the data transfer (i.e., log on, make a selection, and download). Page 1, ll. 28-30 & ll. 101-107. In the claim 1 rejection, from which these claims depend, Freeny was relied upon to teach the obvious addition of transmitting a consumer credit card for charging money.

Claim Rejections Based on Akashi

35 USC § 103

The following is a quotation of 35 U.S.C. 103(a) which forms the basis for all obviousness rejections set forth in this Office action:

(a) A patent may not be obtained though the invention is not identically disclosed or described as set forth in section 102 of this title, if the differences between the subject matter sought to be patented and the prior art are such that the subject matter as a whole would have been obvious at the time the invention was made to a person having ordinary skill in the art to which said subject matter pertains. Patentability shall not be negated by the manner in which the invention was made.

Claims 1-6 are rejected under 35 U.S.C. 103(a) as being unpatentable over Japanese Patent Application No. 62-284496 ("Akashi") using the English translation of record, in view of Freeny.

Regarding **claim 1**,

A method for transmitting a desired digital audio signal stored on a first memory of a first party to a second memory of a second party comprising the steps of:

Akashi teaches transmitting audio signals (digital music) stored on a first memory (recorded music and information stored on a "data base 14" in the host computer) of a first party

Art Unit: 3992

(host or record company) to a second memory (recordable optical discs or digital audio tape in recording/reproducing device (1)) of a second party (household user). Translation, pages 2 & 3, sections (3)-(6). The transfer occurs as a result of the household user's desire to "purchase desired music from home." Page 4, section (7).

connecting electronically via a telecommunications line the first memory with the second memory such that the desired digital audio signal can pass therebetween;

Akashi teaches connecting via an electronic, telephone line (telecommunications line) the first memory (recorded music on host computer) with the second memory (recordable discs or tape in the recording/reproducing device) such that the digital audio (music and music information) can pass therebetween. Translation, page 2, section (4).

transmitting the desired digital audio signal from the first memory with a transmitter in control and possession of the first party to a receiver having the second memory at a location determined by the second party, said receiver in possession and control of the second party;

The desired digital audio or video signal is transmitted from the first memory as discussed above using a transmitter (host computer 14) (Fig. 4 and translation, page 3, section (6)) in control and possession of the first party (host or record company) maintains" the recorded music it wishes to sell. Page 4, section (7). The receiver (recording/reproducing device 1 comprising modem 3) (translation, page 3, section (6)) is in possession and control of the second party (household user) because the second party determines the location to which the audio/video

Art Unit: 3992

data is transmitted as broadly recited by the claims, such as deciding to "set up as terminals in each user's household" and "purchase desired music from home" which also establishes that said terminal is "in possession and control of the second party." Translation, page 3, section (6); and page 4, section (7).

transferring money electronically via a telecommunication line to the first party at a location remote from the second memory and controlling use of the first memory from the second party financially distinct from the first party, said second party controlling use and in possession of the second memory;

As discussed above, Akashi teaches that the digital music data is: 1) "purchased" by the household user (second party) automatically via the telecommunications line (telephone line) and thus the first and second party are financially distinct, 2) the first party is at a location (host) remote from second party (house), and 3) the first party (host or record company) controls the first memory and the second party (household user) controls and possesses the second memory, Akashi however fails to specifically detail how the purchase is transacted (e.g., by transferring money electronically via the telecommunication line).

Freeny discloses a method of electronically distributing and selling audio and video data from remote, information control machines 14 (first party) to information control machines 12 (second party) (abstract, col. 4, ll. 35-60, col. 5, ll. 10-15, col. 7, l. 50 - col. 8, l. 28, and col. 11, ll. 10-58) also known as "point of sales" locations (col. 4, ll. 35-60), which include a "consumer's home (point of sale location)" (col. 3, ll. 64-68) by way of having the requesting user transmit a

Art Unit: 3992

consumer credit card number along with their request for the audio and video data (col. 13, lines 25-29).

The suggestion/motivation for combining Akashi with Freeny would have been because Freeny's method of electronic sale allows the selling party to more reliably and receive compensation (increase revenue) for the sale of product because the "owner of the information receives directly the compensation for each sale of a recording and such compensation is received before the reproduction is authorized." Col. 13, lines 36-39. In addition, revenue would have been increased by merely supporting the use of credit card transactions. For example, credit cards permit customers to make purchases in cases where they do not have cash on hand, as would have been notoriously well known in the art.

In addition, combining prior art elements according to known methods to yield predictable results is obvious. *KSR v. Teleflex*, 550 U.S. 395, 417 (2007). See the Gallagher in view of Freeny rejection of claim 1 above for further details regarding the *KSR* analysis based upon predictable results. Said *KSR* analysis has not been copied from that rejection, but applies here to the combination of Akashi in view of Freeny for the same reasons. Thus, the analysis will not be repeated here for the sake of brevity.

Therefore, it would have been obvious to one of ordinary skill in the art at the time the invention was made to have the requesting user's of Akashi transmit a consumer credit card number along with their request for the digital audio and video data so that the source unit could

Art Unit: 3992

approve and charge the sale of the digital data to the consumer credit card before the product (digital audio or video) is released, thereby "transferring money electronically via a telecommunication line" as recited.

Claim 4 differs substantively from claim 1 in that claim 4 recites the transfer of a digital video signal. As discussed above in the claim 1 rejection, the combination of Akashi in view of Freeny obviously teaches "transferring money electronically via a telecommunications line to the first party at a location remote from a second party." More specifically however, the combination teaches transmission of a credit card number and the transmission of digital audio and video data. That is, Freeny teaches both the concept and advantages as transferring video data for money. For example, Freeny teaches digital video information is transferred to the point of sale device for the creation of "video discs" (col. 4, ll. 35-60, col. 21, ll. 44-55, col. 24, ll. 20-30, col. 34, ll. 39-46).

As an initial matter, the suggestion/motivation for combining Akashi with the audio and video transmission teachings of Freeny would have been same as discussed above in the claim 1 rejection, specifically, Freeny teaches the obvious addition of "transferring money electronically via a telecommunications line" for the sale of both audio and video. Nonetheless, the addition of video transmission would have also been obvious because the transmission of video to a point of sale device, which includes the consumer's home (col. 3, ll. 65-67) would have increased revenue and efficiency by avoiding the need for "manufacturing facilities for reproducing the information in material objects and a distribution network for distributing the material objects to

Art Unit: 3992

the various point of sale locations for sale to the consumer (col. 1, ll. 19-26), where such information includes "motion pictures" and the like (col. 1, ll. 10-14). Finally, the claims do not specify quality, size, or bandwidth required for video signals...." Page 22, Board decision (September 4, 2009). Thus, the addition of even a minimal video capability (highly limited bandwidth) requiring very little structural change to Akashi would still meet the claim language.

Therefore, it would have been obvious to one of ordinary skill in the art at the time the invention was made to ability the transmit video as taught by Freeny to the audio transmission system taught by Akashi.

Regarding **claims 2 and 5**, Akashi discloses that personal computer contains a CPU (Figure 1). The personal computer sends an access signal to the host computer, and the host computer returns a response signal that contains menu data displayed at the personal computer. Translation, page 3, paragraph (6). Using the monitor screen, the user chooses desired data using a control unit and sending the selection data to the host computer in the same way the initial transmission was sent. Translation, page 4, paragraph (6). Such teachings meet the limitation of the steps of searching the first memory for the desired digital audio signal and selecting the desired digital audio signal from the first memory. In the claim 1 rejection, from which these claims depend, Freeny was relied upon to teach the obvious addition of transmit a consumer credit card number along with the request for the audio and video data thereby resulting in the host memory being searched after the transfer of money in order to receive "compensation...before the reproduction is authorized." See also col. 13, ll. 25-48.

Regarding **claims 3 and 6**, the Akashi base reference teaches that the second party telephones the first party to initiate the transfer. Translation, page 3 , paragraph (6), "Operation procedures...." The combination of Akashi in view of Freeny, as discussed in the claim 1 rejection above, teaches transferring money electronically in the form of providing a credit card number.

Double Patenting

The nonstatutory double patenting rejection is based on a judicially created doctrine grounded in public policy (a policy reflected in the statute) so as to prevent the unjustified or improper timewise extension of the "right to exclude" granted by a patent and to prevent possible harassment by multiple assignees. See *In re Goodman*, 11 F.3d 1046, 29 USPQ2d 2010 (Fed. Cir. 1993); *In re Longi*, 759 F.2d 887, 225 USPQ 645 (Fed. Cir. 1985); *In re Van Ornum*, 686 F.2d 937, 214 USPQ 761 (CCPA 1982); *In re Vogel*, 422 F.2d 438, 164 USPQ 619 (CCPA 1970); and *In re Thorington*, 418 F.2d 528, 163 USPQ 644 (CCPA 1969).

Claims 1-6 of the instant Hair patent under reexamination are rejected under the judicially created doctrine of obviousness-type double patenting as being unpatentable over claims 1-34 of U.S. Patent No. 5,675,734 (the "'734" patent).¹

Although the conflicting claims are not identical, they are not patentably distinct from each other because the claims in the instant Hair patent under reexamination are broader than the claims in the '573 patent. See *Van Ornum*, where broad claims in continuation applications were rejected as obvious double patenting over previously patented narrow claims. For example, independent claims 1 and 4 of the instant Hair patent are similar to independent claim 16 of the '734 patent, except that limitations directed to a first control panel, first control integrated circuit,

¹ The instant Hair patent under reexamination appears to have expired March 2, 2010 while the 5,675,734 patent appears to have expired June 13, 2008. Thus the policy of improper timewise extension of a "right to exclude" is at issue regarding the instant, double patenting rejection.

Art Unit: 3992

sales random access memory, incoming random access memory, and playback random access memory are not present in claims 1 and 4 of the instant patent. In addition, no "video" limitations are present in claim 1 of the instant patent. Furthermore, although instant claims 1 and 4 recite the first party and second party are "financially distinct," this limitation fails to patentably distinguish over claim 11 of '734 patent because claim 11 recites money is transferred between first party and second party. Although the parties may belong to the same overall entity (e.g., different divisions of a corporation), if money is actually "transferred" between them, they are financially distinct, otherwise no "transfer" of money would be required in the first place. Finally, claims 1 and 4 of the instant Hair patent are method claims while claim 11 of the '734 patent is an apparatus claim. It would have been obvious however to one of ordinary skill in the art at the time the invention was made to use the apparatus in claim 11 to perform the functions recited in the method of instant claim 1 because the apparatus performs those very same functions.

Claims 1 and 4 of the instant Hair patent are merely broader than claim 1 of the '734 patent as well. Although claims 1 and 4 of the instant Hair patent recite "transferring money" while claim 1 of the '734 patent recites "telephoning the first party" and "providing a credit card number," the "transferring money" limitation is still merely broader. As evidence for this conclusion, see dependent claims 3 and 6 of the instant Hair patent, which recite the "transferring money" step of independent claims 1 and 4 include the "telephoning" and "credit card number" steps.

Art Unit: 3992

Claims 1 and 4 of the instant Hair patent are merely broader than the remaining independent claims of the '734 patent for similar reasons.

Thus, all independent claims of the instant Hair patent are merely broader than all independent claims of the '734 patent.

Conclusion

In order to ensure full consideration of any amendments, affidavits or declarations, or other documents as evidence of patentability, such documents must be submitted in response to this Office action. Submissions after the next Office action, which is intended to be a final action, will be governed by the requirements of 37 CFR 1.116, after final rejection and 37 CFR 41.33 after appeal, which will be strictly enforced.

Extensions of time under 37 CFR 1.136(a) will not be permitted in these proceedings because the provisions of 37 CFR 1.136 apply only to "an applicant" and not to parties in a reexamination proceeding. Additionally, 35 U.S.C. 305 requires that reexamination proceedings "will be conducted with special dispatch" (37 CFR 1.550(a)). Extension of time in *ex parte* reexamination proceedings are provided for in 37 CFR 1.550(c).

The patent owner is reminded of the continuing responsibility under 37 CFR 1.565(a) to apprise the Office of any litigation activity, or other prior or concurrent proceeding, involving the Hair patent throughout the course of this reexamination proceeding. The third party requester is also reminded of the ability to similarly apprise the Office of any such activity or proceeding throughout the course of this reexamination proceeding. See MPEP §§ 2207, 2282 and 2286.

Art Unit: 3992

All correspondence relating to this *ex parte* reexamination proceeding should be directed as follows:

By EFS: Registered users may submit via the electronic filing system EFS-Web, at <https://sportal.uspto.gov/authenticate/authenticateuserlocalepf.html>.

By Mail to: Mail Stop *Ex Parte* Reexam
Central Reexamination Unit
Commissioner for Patents
P.O. Box 1450
Alexandria, VA 22313-1450

By FAX to: (571) 273-9900
Central Reexamination Unit

By hand to: Customer Service Window
Randolph Building
401 Dulany St.
Alexandria, VA 22314

For EFS-Web transmission, 37 CFR 1.8(a)(1)(i) (C) and (ii) states that correspondence (except for a request for reexamination and a corrected or replacement request for reexamination) will be considered timely if (a) it is transmitted via the Office's electronic filing system in accordance with 37 CFR 1.6(a)(4), and (b) includes a certificate of transmission for each piece of correspondence stating the date of transmission, which is prior to the expiration of the set period of time in the Office action.

Any inquiry concerning this communication should be directed to Roland Foster at telephone number 571-272-7538.

Signed:

/Roland G. Foster/
Roland G. Foster
Central Reexamination Unit, Primary Examiner
Electrical Art Unit 3992
(571) 272-7538

Conferees:

ESK

Reexamination 	Application/Control No. 90007402	Applicant(s)/Patent Under Reexamination 5191573
	Certificate Date	Certificate Number

Requester Correspondence Address:	<input type="checkbox"/> Patent Owner	<input checked="" type="checkbox"/> Third Party
Albert S. Penilla Martine Penilla & Gencarella, LLP 710 Lakeway Drive, Suite 200 Sunnyvale, CA 94085		

LITIGATION REVIEW <input checked="" type="checkbox"/>	r.g.f. (examiner initials)	03/15/2010 (date)
Case Name		Director Initials
2:04cv1549, closed.		<i>Penilla Head to GM</i>

COPENDING OFFICE PROCEEDINGS	
TYPE OF PROCEEDING	NUMBER
1. None.	

--	--

Search Notes 	Application/Control No. 90007402	Applicant(s)/Patent Under Reexamination 5191573
	Examiner ROLAND G FOSTER	Art Unit 3992

SEARCHED			
Class	Subclass	Date	Examiner

SEARCH NOTES		
Search Notes	Date	Examiner
East text search - see attached search history.	3/15/2010	r.g.f.

INTERFERENCE SEARCH			
Class	Subclass	Date	Examiner

--	--

90/067402
ATTACH TO PAPER NO. 20100304 SEARCH NOTES REE
PAGE 1 OF 1
EAST Search History (Prior Art)

Ref #	Hits	Search Query	DBs	Default Operator	Plurals	Time Stamp
L1	9632	(hard adj1 (disk or drive)) same (buffer or cache)	USPAT	OR	OFF	2010/03/15 13:55
L2	55	1 and @ad<"19880101"	USPAT	OR	OFF	2010/03/15 13:56

IN THE UNITED STATES PATENT AND TRADEMARK OFFICE

In re Re-Examination of PATENT:
5,191,573
Control No.: 90/007,402
Filing Date: 01/31/2005

Confirmation No.: 2998
Attorney Docket: NAPS001
Group Art Unit: 3992
Examiner: Foster, R.
Date: May 25, 2010

RESPONSE

Hon. Commissioner of Patents
P.O. Box 1450
Alexandria, VA 22313-1450

Sir:

In response to the Office Action dated March 25, 2010, Applicant respectfully submits the Remarks/Arguments beginning on page 2 of this paper.

Re-Exam Control No. 90/007,402
Filed: 01/31/2005
Reply to Office Action of March 25, 2010

REMARKS/ARGUMENTS

Favorable reconsideration of the claims undergoing re-examination, in light of the following discussions, is respectfully requested.

Claims 1-6 are currently undergoing re-examination. No changes have been made to the claims herewith. However, as specified in the Office Action, all previous amendments have now been withdrawn in light of the expiration of the patent.

In the outstanding Office Action, the previous grounds for rejection for the previously pending claims were withdrawn, and several new grounds for rejection have been made. The outstanding rejections are as follows:

(1) Claims 1-6 have been rejected under 35 U.S.C. § 102(e) as being unpatentable over U.S. Patent No. 4,789,863 (hereinafter “the ‘863 patent”);

(2) Claims 1-6 have been rejected under 35 U.S.C. § 103(a) as being unpatentable over U.K. Patent Application Publication No. GB2178275 (hereinafter “Gallagher”) in view of U.S. Patent No. 4,528,643 (hereinafter “the ‘643 patent”);

(3) Claims 1-6 have been rejected under 35 U.S.C. § 103(a) as being unpatentable over Japanese Patent Application No. 62-284496 (hereinafter “Akashi”) in view of the ‘643 patent and the ‘434 patent; and

(4) Claims 1-6 have been rejected under the judicially created doctrine of obviousness-type double patenting as being unpatentable over claims 1-34 of U.S. Patent No. 5,675,734.

The Rejection of Claims 1-6 under 35 U.S.C. § 102(a) over the ‘863 Patent

Claim 1

Claim 1 recites “storing the digital signal in the second memory.” In light of the specification, it is respectfully submitted that such a limitation is not taught by the ‘863 patent. With respect to the step of “storing the digital signal in the second memory,” the Office Action

Re-Exam Control No. 90/007,402
Filed: 01/31/2005
Reply to Office Action of March 25, 2010

alleges that the '863 patent teaches this limitation by citing the cassette tape and CD of the '863 patent and by referring to their discussion in col. 5, lines 24-52. However, cassette tapes and CDs are not "second memories" according to the claims and specification. The specification utilizes a special phrase, "hardware units," when referring to such removable media. The first paragraph of the Background of the Invention in col. 1 expressly describes those media when it states "The three basic mediums (hardware units) of music: records, tapes, and compact discs, greatly restricts the transferability of music and results in a variety of inefficiencies." These hardware units are further described in the specification as containing drawbacks in light of their removable nature and their physical distribution (when compared with a hard disk acting as an internal, non-volatile storage device), and it is those drawbacks that the patented invention seeks to overcome. The Background describes the materials of the hardware units as being a disadvantage when it states "The materials used to manufacture the hardware units are subject to damage and deterioration during normal operations, handling, and exposure to the elements." The Background likewise states that hardware units have retrieval and distribution drawbacks when its states "Hardware units limit the ability to play, in a sequence selected by the user, songs from different albums" and "the material cost of the hardware units themselves, further drives up the cost of music to the end user." Further, the Summary of the Invention describes the invention as "eliminating the need to unnecessarily handle records, tapes, or compact discs on a regular basis." Thus, attempting to read the claimed second memories on exactly the type of media that the specification describes as deficient is a misinterpretation of the scope of the claims. See *SciMed Life Systems, Inc. v. Advanced Cardiovascular Systems, Inc.*, 242 F.3d 1337 (Fed. Cir. 2001).

As a result, claim 1 is not anticipated by the '863 patent, and dependent claims 2 and 3 are patentable for at least the reasons set forth for the patentability of claim 1 from which they depend. Claim 4 also recites the same "storing the digital signal in the second memory." As was described with respect to claim 1, such a limitation is not taught by the '863 patent. Therefore, the patentability of claim 4 and claims 5 and 6 should be indicated as confirmed for at least the reasons set forth above with respect to claim 1.

Re-Exam Control No. 90/007,402
Filed: 01/31/2005
Reply to Office Action of March 25, 2010

The Rejection of Claims 1-6 under 35 U.S.C. § 103(a) as being unpatentable over Gallagher in view of the '643 patent

The Office Action alleges that the combination of Gallagher and the '643 patent renders obvious the recitation of "storing the digital signal in the second memory" as claimed in claim 1. In support of this allegation, the Office Action cites to the storage medium 32 in Gallagher. However, the storage medium 32 is expressly described in the specification, page 1, ll. 89-90, as "a storage medium 32 such as a video tape or optical disk." As was discussed above with respect to the '863 patent, the specification defines such media as "hardware units" and, as would be understood by those of ordinary skill in the art in light of the specification, such "hardware units" are not "second memories." As a result, Gallagher does not teach the step of "storing the digital signal in the second memory."

The '643 patent is not alleged to cure this deficiency of Gallagher, and, therefore, there is no evidence that the combination of references renders obvious the same step not taught by the references individually. As a result, claim 1 is not rendered obvious by the proposed combination of references, and dependent claims 2 and 3 are patentable for at least the reasons set forth for the patentability of claim 1 from which they depend. Claim 4 also recites the same "storing the digital signal in the second memory." As was described with respect to claim 1, such a limitation is not rendered obvious by the proposed combination of references. Therefore, the patentability of claim 4 and claims 5 and 6 should be indicated as confirmed for at least the reasons set forth above with respect to claim 1.

The Rejection of Claims 1-6 under 35 U.S.C. § 103(a) as being unpatentable over Akashi in view of the '643 patent

The Office Action alleges that the combination of Akashi and the '643 patent renders obvious the recitation of "storing the digital signal in the second memory" as claimed in claim 1. In support of this allegation, the Office Action cites to the "recordable optical discs or digital audio tape in recording/reproducing device (1)" in Akashi. As was discussed above with respect to the '863 patent, the specification defines such media as "hardware units" and, as would be

Re-Exam Control No. 90/007,402
Filed: 01/31/2005
Reply to Office Action of March 25, 2010

understood by those of ordinary skill in the art in light of the specification, such “hardware units” are not are “second memories.” As a result, Akashi does not teach the step of “storing the digital signal in the second memory.”

The ‘643 patent is not alleged to cure this deficiency of Akashi, and, therefore, there is no evidence that the combination of references renders obvious the same step not taught by the references individually. As a result, claim 1 is not rendered obvious by the proposed combination of references, and dependent claims 2 and 3 are patentable for at least the reasons set forth for the patentability of claim 1 from which they depend. Claim 4 also recites the same “storing the digital signal in the second memory.” As was described with respect to claim 1, such a limitation is not rendered obvious by the proposed combination of references. Therefore, the patentability of claim 4 and claims 5 and 6 should be indicated as confirmed for at least the reasons set forth above with respect to claim 1.

The Rejection of Claims 1-6 under the Judicially Created Doctrine of Obviousness-Type Double Patenting

The Office Action alleges that claims 1-6 are unpatentable over claims 1-34 of U.S. Patent No. 5,675,734. The Office Action alleges that the rejection is proper in light of the “policy of improper timewise extension of a ‘right to exclude.’” However, the patent undergoing re-examination is the first patent in the patent family both to be filed and to issue. Thus, the term of the patent undergoing re-examination is the patent by which all other patents are measured to determine if there has been an “improper timewise extension.” The Office Action cites *In re Van Ornum*, 686 F.2d 937, 214 USPQ 761 (CCPA 1982) as supporting the Office Action’s rationale for the rejection. However, as can be seen from the date of the decision -- 1982 --, that decision was rendered at a time when patents were each given their own term of 17 years from issue. In such a case, the term of the later issued patent would extend beyond that of the originally issued patent. Here, however, because of the transition to patent terms of 20 years from the earliest filing date, the reverse is true -- the later issued patent expired before the patent undergoing re-examination. Thus, there is no “extension” at all, and the rejection should be withdrawn.

Re-Exam Control No. 90/007,402
Filed: 01/31/2005
Reply to Office Action of March 25, 2010

Consequently, in light of the above discussions, the outstanding grounds for rejection are believed to have been overcome and the patentability of all claims should be confirmed. An early and favorable action to that effect is respectfully requested.

CHARGE STATEMENT: Deposit Account No. 501860, order no. 2689-0001 .
The Commissioner is hereby authorized to charge any fee specifically authorized hereafter, or any missing or insufficient fee(s) filed, or asserted to be filed, or which should have been filed herewith or concerning any paper filed hereafter, and which may be required under Rules 16-18 (<u>missing or insufficiencies only</u>) now or hereafter relative to this application and the resulting Official Document under Rule 20, or credit any overpayment, to our Accounting/ Order Nos. shown above, for which purpose a <u>duplicate</u> copy of this sheet is attached.
This CHARGE STATEMENT <u>does not authorize charge of the issue fee until/unless an issue fee transmittal sheet is filed.</u>

CUSTOMER NUMBER 42624	Respectfully submitted, By: / Michael R. Casey / _____ Michael R. Casey, Ph.D. Registration No.: 40,294
Davidson Berquist Jackson & Gowdey LLP 4300 Wilson Blvd., 7th Floor, Arlington, Virginia 22203 Main: (703) 894-6400 • FAX: (703) 894-6430	

IN THE UNITED STATES PATENT AND TRADEMARK OFFICE

In re Re-Examination of PATENT:		Confirmation No.:	2998
5,191,573		Attorney Docket:	NAPS001
Control No.:	90/007,402	Group Art Unit:	3992
Filing Date:	01/31/2005	Examiner:	Foster, R.
		Date:	May 25, 2010

INFORMATION DISCLOSURE STATEMENT

Hon. Commissioner of Patents
P.O. Box 1450
Alexandria, VA 22313-1450

Sir:

Pursuant to 37 C.F.R. § 1.56, the attention of the Patent and Trademark Office is hereby directed to the reference(s) listed on the attached PTO-1449. One copy of each non-U.S. Patent reference is attached. It is respectfully requested that the information be expressly considered during the prosecution of this application, and that the reference(s) be made of record therein and appear among the "References Cited" on any patent to issue therefrom.

The submission of any document herewith, which is not a statutory bar, is not intended that any such document constitutes prior art against any of the claims of the present application or is considered to be material to patentability as defined in 37 C.F.R. § 1.56(b). Applicants do not waive any rights to take any action which would be appropriate to antedate or otherwise remove as a competent reference against the claims of the present application.

In re Patent: 5,191,573
Control No.: 90/007,402
Page 2 of 2

CHARGE STATEMENT: Deposit Account No. 501860, order no. 2689-0001.
The Commissioner is hereby authorized to charge any fee specifically authorized hereafter, or any missing or insufficient fee(s) filed, or asserted to be filed, or which should have been filed herewith or concerning any paper filed hereafter, and which may be required under Rules 16-18 (missing or insufficiencies only) now or hereafter relative to this application and the resulting Official Document under Rule 20, or credit any overpayment, to our Accounting/Order Nos. shown above, for which purpose a duplicate copy of this sheet is attached
This CHARGE STATEMENT does not authorize charge of the issue fee until/unless an issue fee transmittal sheet is filed.

CUSTOMER NUMBER
42624

Davidson Berquist Jackson & Gowdey LLP
4300 Wilson Blvd., 7th Floor,
Arlington Virginia 22203
Main: (703) 894-6400 • FAX: (703) 894-6430

Respectfully submitted,

By: / Michael R. Casey /

Michael R. Casey
Registration No.: 40,294

INFORMATION DISCLOSURE STATEMENT BY APPLICANT FORM PTO-1449 (modified) Sheet 1 of 2	Reexam number	90/007,402
	First Named Inventor	5,191,573
	Patent Under Re-Exam	5,191,573
	Issue Date	
	Group Art Unit	3992
	Examiner Name	Foster, R.
	Attorney Docket No.	NAPS001
	Confirmation No.	2998

NON-PATENT REFERENCES			
Examiner Initials*	Cite No.	Non-patent Reference bibliographic information, where available	Notes
	1-1	Apple Inc., Form 10-Q, April 21, 2010.	
	1-2	Blockbuster Changes Course of In-store Duplication Plans, Multimedia & Videodisc Monitor, Vol. 12, No. 6, June 1, 1994 (1 page)	
	1-3	Blockbuster Reaffirms Video Retailing Roots, Video Week, Vol. 14, No. 19, May 17, 1993 (2 pages)	
	1-4	Blockbuster To Test Videogame Downloads In Summer, Audio Week, Vol. 6, No. 12, March 28, 1994 (2 pages)	
	1-5	IBM, Blockbuster join forces on CD venture; Associated Press, May 12, 1993 (2 pages)	
	1-6	Magistrate's Report and Recommendation (Amending Claim Construction), Sightsound.com v. NSK et al., Civil Action No. 98-118, April 2, 2002	
	1-7	Magistrate's Report and Recommendation (on Claim Construction), Sightsound.com v. NSK et al., Civil Action No. 98-118, February 8, 2002	

Examiner Signature		Date Considered	
--------------------	--	-----------------	--

*Examiner: Initial if reference was considered, whether or not citation is in conformance with MPEP 609. Draw a line through citation if not in conformance and not considered. Include a copy of this form with next communication to applicant. Notes: If identified, the following is provided: EA = English Abstract, T = Translation, PT = Partial Translation, SOR = Statement of Relevancy, PF = Patent Family.

INFORMATION DISCLOSURE STATEMENT BY APPLICANT FORM PTO-1449 (modified)	Reexam number	90/007,402
	First Named Inventor	5,191,573
	Patent Under Re-Exam	5,191,573
	Issue Date	
	Group Art Unit	3992
	Examiner Name	Foster, R.
	Attorney Docket No.	NAPS001
	Confirmation No.	2998
Sheet 2 of 2		

NON-PATENT REFERENCES			
Examiner Initials*	Cite No.	Non-patent Reference bibliographic information, where available	Notes
	2-1	Memorandum Order of Court (adopting amended claim construction recommendation), Sightsound.com v. NSK et al., Civil Action No. 98-118, November 27, 2002	
	2-2	Music burning kiosks: On the right track; Self Service and Kiosk Association, April 9, 2007 (4 pages)	
	2-3	Sony Music Plans to Test Use of In-Store Digital Kiosks, New York Times, June 10, 1999	
	2-4	Starbucks shuts down its Hear Music kiosks, May 2006 (http://brandautopsy.typepad.com/brandautopsy/2006/05/starbucks_shuts.html)	
	2-5	Turning Over New Leaf, Consumer Electronics, February 13, 1995 (1 page)	
	2-6		
	2-7		

Examiner Signature		Date Considered	
--------------------	--	-----------------	--

*Examiner: Initial if reference was considered, whether or not citation is in conformance with MPEP 609. Draw a line through citation if not in conformance and not considered. Include a copy of this form with next communication to applicant. Notes: If identified, the following is provided: EA = English Abstract, T = Translation, PT = Partial Translation, SOR = Statement of Relevancy, PF = Patent Family.

Electronic Acknowledgement Receipt

EFS ID:	7682991
Application Number:	90007402
International Application Number:	
Confirmation Number:	2998
Title of Invention:	METHOD FOR TRANSMITTING A DESIRED DIGITAL VIDEO OR AUDIO SIGNAL
First Named Inventor/Applicant Name:	5191573
Customer Number:	23973
Filer:	Michael R. Casey
Filer Authorized By:	
Attorney Docket Number:	NAPS001
Receipt Date:	25-MAY-2010
Filing Date:	31-JAN-2005
Time Stamp:	14:51:11
Application Type:	Reexam (Third Party)

Payment information:

Submitted with Payment	no
------------------------	----

File Listing:

Document Number	Document Description	File Name	File Size(Bytes)/ Message Digest	Multi Part /.zip	Pages (if appl.)
1	Amendment/Req. Reconsideration-After Non-Final Reject	20100525_573_Response_Cover.pdf	69533 b7bad9de90b92fad11d7de4343a332efc8a4b13e	no	1

Warnings:

Information:

2	Applicant Arguments/Remarks Made in an Amendment	20100525_573_Response_Remarks.pdf	144974 b093ab07faa2462aa710882859b9e2b61974ddaa	no	5
Warnings:					
Information:					
3	Transmittal Letter	20100525_IDS.pdf	120716 f49df2f90d0de9bd5e55a1e8338a76c7ef32764	no	2
Warnings:					
Information:					
4	Information Disclosure Statement (IDS) Filed (SB/08)	20100525_1449.pdf	297531 82787619f6a9c57d66c176b0f1a0a6a7343dc68b	no	2
Warnings:					
Information:					
This is not an USPTO supplied IDS fillable form					
5	NPL Documents	NP0000.pdf	579968 7e117128031fde3a7ccb79d3e501d567acb617	no	60
Warnings:					
Information:					
6	NPL Documents	NP0001.pdf	45694 da5e8c0bfad4184505262c5a0bf454b44ed54863	no	1
Warnings:					
Information:					
7	NPL Documents	NP0002.pdf	57196 0a6dabc551e64555bae1c8a38be13ea515a1bb13	no	2
Warnings:					
Information:					
8	NPL Documents	NP0003.pdf	68295 a5ea754f8a00accf642ba1db33d9530996c08cd	no	2
Warnings:					
Information:					
9	NPL Documents	NP0004.pdf	48161 c7c388b816aab2256c4a30ba1c07720c7df3789e	no	2
Warnings:					
Information:					
10	NPL Documents	NP0005.pdf	168074 d541afc4be6d56375b8bb3dee93247171730dece	no	4

Warnings:					
Information:					
11	NPL Documents	NP0006.pdf	900445	no	97
			44b4fba7db6d90a36e8dafd4d89e3048eeba3f7		
Warnings:					
Information:					
12	NPL Documents	NP0007.pdf	73907	no	3
			c3adc1fd11e0a66213ef8ceff03ec09b4b8655		
Warnings:					
Information:					
13	NPL Documents	NP0008.pdf	67216	no	4
			c95b743b6202435e51a6976fce864376ecb8e980		
Warnings:					
Information:					
14	NPL Documents	NP0009.pdf	44335	no	2
			1376c507f3a7fb2f629fdbb6f15fea3dbe8ae03		
Warnings:					
Information:					
15	NPL Documents	NP0010.pdf	58514	no	1
			ce3ce0a64d662ec1ecd256c1ec00be74fd23e6cf		
Warnings:					
Information:					
16	NPL Documents	NP0011.pdf	55825	no	1
			ff10f5f2c05887a999b5affa47b813774599192		
Warnings:					
Information:					
17	Reexam Certificate of Mailing	20100525_COS.pdf	39400	no	1
			6a4a8542a42aa311674596350b90bfc0e4b7785a		
Warnings:					
Information:					
Total Files Size (in bytes):			2839784		

This Acknowledgement Receipt evidences receipt on the noted date by the USPTO of the indicated documents, characterized by the applicant, and including page counts, where applicable. It serves as evidence of receipt similar to a Post Card, as described in MPEP 503.

New Applications Under 35 U.S.C. 111

If a new application is being filed and the application includes the necessary components for a filing date (see 37 CFR 1.53(b)-(d) and MPEP 506), a Filing Receipt (37 CFR 1.54) will be issued in due course and the date shown on this Acknowledgement Receipt will establish the filing date of the application.

National Stage of an International Application under 35 U.S.C. 371

If a timely submission to enter the national stage of an international application is compliant with the conditions of 35 U.S.C. 371 and other applicable requirements a Form PCT/DO/EO/903 indicating acceptance of the application as a national stage submission under 35 U.S.C. 371 will be issued in addition to the Filing Receipt, in due course.

New International Application Filed with the USPTO as a Receiving Office

If a new international application is being filed and the international application includes the necessary components for an international filing date (see PCT Article 11 and MPEP 1810), a Notification of the International Application Number and of the International Filing Date (Form PCT/RO/105) will be issued in due course, subject to prescriptions concerning national security, and the date shown on this Acknowledgement Receipt will establish the international filing date of the application.

Under the Paperwork Reduction Act of 1995, no persons are required to respond to a collection of information unless it displays a valid OMB control number.

REVOCAION OF POWER OF ATTORNEY WITH NEW POWER OF ATTORNEY AND CHANGE OF CORRESPONDENCE ADDRESS	Application Number:	90/007,402
	Filing Date:	January 31, 2005
	First Named Inventor:	5,191,573
	Group Art Unit:	3992
	Examiner Name:	FOSTER, Roland G.
	Attorney Docket No.:	2689-0010

I hereby revoke all previous powers of attorney given in the above-identified application			
<input type="checkbox"/> A Power of Attorney is submitted herewith.			
OR			
<input checked="" type="checkbox"/> I hereby appoint the practitioners associated with the Customer Number: <u>42624</u>			
<input checked="" type="checkbox"/> Please change the correspondence address for the above-identified application to:			
<input checked="" type="checkbox"/> The address associated with Customer Number: <u>42624</u>			
OR			
<input type="checkbox"/>	Firm or Individual Name		
Address Line 1			
Address Line 2			
City		State	
Country			
Telephone		Fax	
I am the:			
<input type="checkbox"/> Applicant / Inventor			
<input checked="" type="checkbox"/> Assignee of record of the entire interest. See 37 CFR 3.71. <i>Statement under 37 CFR 3.73(b) is enclosed. (Form PTO/SB/96)</i>			
SIGNATURE of Applicant or Assignee of Record			
Name	Ken Glick <i>Assistant Secretary, DMT Licensing, LLC</i>		
Signature			
Date	<i>6/23/2010</i>	Telephone	<i>609-936-6022</i>
NOTE: Signatures of all the inventors or assignees of record of the entire interest or their representative(s) are required. Submit multiple forms if more than one signature is required, see below*.			

This collection of information is required by 37 CFR 1.36. The information is required to obtain or retain a benefit by the public which is to file (and by the USPTO to process) an application. Confidentiality is governed by 35 U.S.C. 122 and 37 CFR 1.14. This collection is estimated to take 3 minutes to complete, including gathering, preparing, and submitting the completed application form to the USPTO. Time will vary depending upon the individual case. Any comments on the amount of time you require to complete this form and/or suggestions for reducing this burden, should be sent to the Chief Information Officer, U.S. Patent and Trademark Office, U.S. Department of Commerce, P.O. Box 1450, Alexandria, VA 22313-1450. DO NOT SEND FEES OR COMPLETED FORMS TO THIS ADDRESS. SEND TO: Commissioner for Patents, P.O. Box 1450, Alexandria, VA 22313-1450.

STATEMENT UNDER 37 CFR 3.73(B)

Applicant / Patent Owner: HAIR, Arthur R.

Docket No. 2689-0010

Application No. / Patent No. 90/007,402

Filed / Issued Date: January 31, 2005

Entitled: METHOD FOR TRANSMITTING A DESIRED DIGITAL VIDEO OR AUDIO SIGNAL

Assignee: DMT LICENSING, LLC

A corporation

(Name of assignee)

(Type of Assignee: corporation, partnership, university, government agency, etc.)

States that it is:

- 1. the assignee of the entire right, title, and interest; or
- 2. an assignee of less than the entire right, title and interest.
(The extent (by percentage) of its ownership interest is %)

in the patent application / patent identified above by virtue of either:

- A. An assignment from the inventor(s) of the patent application / patent identified above. The assignment was recorded in the United States Patent and Trademark Office at Reel , Frame , or for which a copy thereof is attached.

OR

- B. A chain of title from the inventor(s), of the patent application / patent identified above, to the current assignee shown below:

1.	From: <u>Arthur R. Hair</u> To: <u>PARSEC SIGHT/SOUND, INC.</u> The document was recorded in the United States Patent and Trademark Office at Reel <u>007656</u> Frame <u>0701</u> , or for which a copy thereof is attached.
2.	From: <u>PARSEC SIGHT/SOUND, INC.</u> To: <u>SIGHTSOUND.COM INCORPORATED</u> The document was recorded in the United States Patent and Trademark Office at Reel <u>010776</u> Frame <u>0703</u> , or for which a copy thereof is attached.
3.	From: <u>SIGHTSOUND TECHNOLOGIES, INC.</u> To: <u>DMT LICENSING, LLC</u> The document was recorded in the United States Patent and Trademark Office at Reel <u>017555</u> Frame <u>0149</u> , or for which a copy thereof is attached.

- Additional documents in the chain of title are listed on a supplemental sheet.
- Copies of assignments or other documents in the chain of title are attached.

As required by 37 CFR 3.73(b)(1)(i), the documentary evidence of the chain of title from the original owner to the assignee was, or concurrently is being, submitted for recordation pursuant to 37 CFR 3.11.

[Note: A separate copy (i.e., a true copy of the original assignment document(s)) must be submitted to Assignment Division in accordance with 37 CFR Part 3, if the assignment is to be recorded in the records of the USPTO. See MPEP 302.08]

The undersigned (whose title is supplied below) is authorized to act on behalf of the assignee.



Signature

June 28, 2010

Date

Michael R. Casey, Ph.D.

Printed or Typed Name

703.894.6400

Telephone Number

Attorney, Registration No. 40,294
Title: _____

Electronic Acknowledgement Receipt

EFS ID:	7904017
Application Number:	90007402
International Application Number:	
Confirmation Number:	2998
Title of Invention:	METHOD FOR TRANSMITTING A DESIRED DIGITAL VIDEO OR AUDIO SIGNAL
First Named Inventor/Applicant Name:	5191573
Customer Number:	23973
Filer:	Michael R. Casey
Filer Authorized By:	
Attorney Docket Number:	NAPS001
Receipt Date:	28-JUN-2010
Filing Date:	31-JAN-2005
Time Stamp:	14:11:31
Application Type:	Reexam (Third Party)

Payment information:

Submitted with Payment	no
------------------------	----

File Listing:

Document Number	Document Description	File Name	File Size(Bytes)/ Message Digest	Multi Part /.zip	Pages (if appl.)
1	Miscellaneous Incoming Letter	Transmittal_06-28-10_2689-00 10.pdf	140328 <small>a73253456e7c6ddfb3fff64a5686e71c1fbcb 78e</small>	no	1

Warnings:

Information:

2	Power of Attorney	POA_06-28-10_2689-0010.pdf	157749 ce0b7129fac1b78b16159d24c0b5f357c6e05a79	no	1
Warnings:					
Information:					
3	Assignee showing of ownership per 37 CFR 3.73(b).	StatementUnder37CFR_06-28-10_2689-0010.pdf	183854 82ccdca2bb3eb56af6b24f3cca2f17dfcd805bc	no	1
Warnings:					
Information:					
4	Reexam Certificate of Service	20100628_CERTIFICATE_OF_SERVICE.pdf	40084 c987d91c4d4c79536b83b5b3a2fb481769d5032f	no	1
Warnings:					
Information:					
Total Files Size (in bytes):			522015		
<p>This Acknowledgement Receipt evidences receipt on the noted date by the USPTO of the indicated documents, characterized by the applicant, and including page counts, where applicable. It serves as evidence of receipt similar to a Post Card, as described in MPEP 503.</p> <p><u>New Applications Under 35 U.S.C. 111</u> If a new application is being filed and the application includes the necessary components for a filing date (see 37 CFR 1.53(b)-(d) and MPEP 506), a Filing Receipt (37 CFR 1.54) will be issued in due course and the date shown on this Acknowledgement Receipt will establish the filing date of the application.</p> <p><u>National Stage of an International Application under 35 U.S.C. 371</u> If a timely submission to enter the national stage of an international application is compliant with the conditions of 35 U.S.C. 371 and other applicable requirements a Form PCT/DO/EO/903 indicating acceptance of the application as a national stage submission under 35 U.S.C. 371 will be issued in addition to the Filing Receipt, in due course.</p> <p><u>New International Application Filed with the USPTO as a Receiving Office</u> If a new international application is being filed and the international application includes the necessary components for an international filing date (see PCT Article 11 and MPEP 1810), a Notification of the International Application Number and of the International Filing Date (Form PCT/RO/105) will be issued in due course, subject to prescriptions concerning national security, and the date shown on this Acknowledgement Receipt will establish the international filing date of the application.</p>					

IN THE UNITED STATES PATENT AND TRADEMARK OFFICE

In re Patent Application of:		Confirmation No.: 2998
5,191,573		Atty. Docket No.: 2689-0010
Appln. No.:	90/007,402	Art Unit: 3992
Filed:	January 31, 2005	Examiner: FOSTER, Roland
Title:	METHOD FOR TRANSMITTING A DESIRED DIGITAL VIDEO OR AUDIO SIGNAL	Date: June 28, 2010

TRANSMITTAL

Hon. Commissioner of Patents
P.O. Box 1450
Alexandria, VA 22313-1450

Sir:

Attached please find the following documents, submitted for filing in connection with the above-identified application:

- Revocation of Power of Attorney with New Power of Attorney and Change in Correspondence Address
- Statement Under 37 CFR 3.73(b)

Our Deposit Account No.: 501860

Our Order No. (Client-Matter No.): 2689-0010

CHARGE STATEMENT: The Commissioner is hereby authorized to charge any fee specifically authorized hereafter, or any missing or insufficient fee(s) filed, or asserted to be filed, or which should have been filed herewith or concerning any paper filed hereafter, and which may be required under Rules 16-18 (missing or insufficiencies only) now or hereafter relative to this application and the resulting Official document under Rule 20, or credit any overpayment, to our Account/Order Nos. (or Attorney Docket No.) shown in the heading hereof for which purpose a duplicate copy of this paper is attached.

This Charge Statement does not authorize charge of the issue fee until/unless an issue fee transmittal form is filed.

<p>CUSTOMER NUMBER 42624</p>
--

Respectfully submitted,

By:

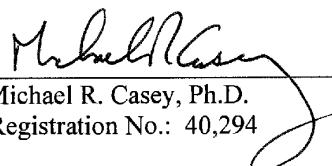
Michael R. Casey, Ph.D.
Registration No.: 40,294

Davidson Berquist Jackson & Gowdey LLP
4300 Wilson Boulevard, 7th Floor
Arlington, VA 22203
Main: (703) 894-6400
FAX: (703) 894-6430

<p align="center">INFORMATION DISCLOSURE STATEMENT BY APPLICANT FORM PTO-1449 (modified)</p> <p align="center">Sheet 1 of 2</p>	Reexam number	90/007,402
	First Named Inventor	5,191,573
	Patent Under Re-Exam	5,191,573
	Issue Date	
	Group Art Unit	3992
	Examiner Name	Foster, R.
	Attorney Docket No.	NAPS001
	Confirmation No.	2998

NON-PATENT REFERENCES			
Examiner Initials*	Cite No.	Non-patent Reference bibliographic information, where available	Notes
/R.F./	1-1	Apple Inc., Form 10-Q, April 21, 2010.	
	1-2	Blockbuster Changes Course of In-store Duplication Plans, Multimedia & Videodisc Monitor, Vol. 12, No. 6, June 1, 1994 (1 page)	
	1-3	Blockbuster Reaffirms Video Retailing Roots, Video Week, Vol. 14, No. 19, May 17, 1993 (2 pages)	
	1-4	Blockbuster To Test Videogame Downloads In Summer, Audio Week, Vol. 6, No. 12, March 28, 1994 (2 pages)	
	1-5	IBM, Blockbuster join forces on CD venture; Associated Press, May 12, 1993 (2 pages)	
	1-6	Magistrate's Report and Recommendation (Amending Claim Construction), Sightsound.com v. NSK et al., Civil Action No. 98-118, April 2, 2002	
	1-7	Magistrate's Report and Recommendation (on Claim Construction), Sightsound.com v. NSK et al., Civil Action No. 98-118, February 8, 2002	

Examiner Signature	/Roland Foster/	Date Considered	08/11/2010
--------------------	-----------------	-----------------	------------

*Examiner: Initial if reference was considered, whether or not citation is in conformance with MPEP 609. Draw a line through citation if not in conformance and not considered. Include a copy of this form with next communication to applicant. Notes: If identified, the following is provided: EA = English Abstract, T = Translation, PT = Partial Translation, SOR = Statement of Relevancy, PF = Patent Family.

<p align="center">INFORMATION DISCLOSURE STATEMENT BY APPLICANT FORM PTO-1449 (modified)</p> <p align="center">Sheet 2 of 2</p>	Reexam number	90/007,402
	First Named Inventor	5,191,573
	Patent Under Re-Exam	5,191,573
	Issue Date	
	Group Art Unit	3992
	Examiner Name	Foster, R.
	Attorney Docket No.	NAPS001
	Confirmation No.	2998

NON-PATENT REFERENCES			
Examiner Initials*	Cite No.	Non-patent Reference bibliographic information, where available	Notes
/R.F./	2-1	Memorandum Order of Court (adopting amended claim construction recommendation), Sightsound.com v. NSK et al., Civil Action No. 98-118, November 27, 2002	
	2-2	Music burning kiosks: On the right track; Self Service and Kiosk Association, April 9, 2007 (4 pages)	
	2-3	Sony Music Plans to Test Use of In-Store Digital Kiosks, New York Times, June 10, 1999	
	2-4	Starbucks shuts down its Hear Music kiosks, May 2006 (http://brandautopsy.typepad.com/brandautopsy/2006/05/starbucks_shuts.html)	
	2-5	Turning Over New Leaf, Consumer Electronics, February 13, 1995 (1 page)	
	2-6		
	2-7		

Examiner Signature	/Roland Foster/	Date Considered	08/11/2010
--------------------	-----------------	-----------------	------------

*Examiner: Initial if reference was considered, whether or not citation is in conformance with MPEP 609. Draw a line through citation if not in conformance and not considered. Include a copy of this form with next communication to applicant. Notes: If identified, the following is provided: EA = English Abstract, T = Translation, PT = Partial Translation, SOR = Statement of Relevancy, PF = Patent Family.

Issue Classification 	Application/Control No. 90007402	Applicant(s)/Patent Under Reexamination 5191573
	Examiner ROLAND G FOSTER	Art Unit 3992

ORIGINAL						INTERNATIONAL CLASSIFICATION									
CLASS			SUBCLASS			CLAIMED			NON-CLAIMED						
369			84			G	1	1	B	27 / 34 (2006.01.01)					
CROSS REFERENCE(S)						G	0	7	F	17 / 00 (2006.01.01)					
						G	1	1	B	27 / 031 (2006.01.01)					
CLASS	SUBCLASS (ONE SUBCLASS PER BLOCK)					G	0	7	F	17 / 16 (2006.01.01)					
235	380	381				G	1	1	B	27 / 034 (2006.01.01)					
348	E7.071					G	1	1	B	27 / 00 (2006.01.01)					
369	15	84	85			G	1	1	B	27 / 10 (2006.01.01)					
G6B	26.002	27.002	27.012	27.019	27.031	G	1	1	B	20 / 00 (2006.01.01)					
						H	0	4	N	7 / 173 (2006.01.01)					

<input checked="" type="checkbox"/> Claims renumbered in the same order as presented by applicant <input type="checkbox"/> CPA <input type="checkbox"/> T.D. <input type="checkbox"/> R.1.47															
Final	Original	Final	Original	Final	Original	Final	Original	Final	Original	Final	Original	Final	Original	Final	Original

None		Total Claims Allowed:	
		6	
(Assistant Examiner)	(Date)		
/ROLAND G FOSTER/ Examiner, Art Unit 3992	8/11/2010	O.G. Print Claim(s)	O.G. Print Figure
(Primary Examiner)	(Date)	1	2

Search Notes 	Application/Control No. 90007402	Applicant(s)/Patent Under Reexamination 5191573
	Examiner ROLAND G FOSTER	Art Unit 3992

SEARCHED			
Class	Subclass	Date	Examiner

SEARCH NOTES		
Search Notes	Date	Examiner
Search not updated.	8/1/2010	r.g.f.

INTERFERENCE SEARCH			
Class	Subclass	Date	Examiner

--	--

Litigation Search Report CRU 3999

Reexam Control No. 90/007,402

TO: Foster, Roland
Location: CRU
Art Unit: 3992
Date: 08/12/09

From: Sharon S. Hoppe
Location: CRU 3999
MDW 7C69
Phone: (571) 272-1586

Case Serial Number: 90/007,402

Sharon.hoppe@uspto.gov

Search Notes

U.S. Patent No 5,191,573

- 1) I performed a KeyCite Search in Westlaw, which retrieves all history on the patent including any litigation.
- 2) I performed a search on the patent in Lexis CourtLink for any open dockets or closed cases.
- 3) I performed a search in Lexis in the Federal Courts and Administrative Materials databases for any cases found.
- 4) I performed a search in Lexis in the IP Journal and Periodicals database for any articles on the patent.
- 5) I performed a search in Lexis in the news databases for any articles about the patent or any articles about litigation on this patent.

Litigation was found.

2:04cv1549 Closed

KEYCITE**H US PAT 5191573 METHOD FOR TRANSMITTING A DESIRED DIGITAL VIDEO OR AUDIO SIGNAL, (Mar 02, 1993)****History****Direct History**

- => **1 METHOD FOR TRANSMITTING A DESIRED DIGITAL VIDEO OR AUDIO SIGNAL, US PAT 5191573, 1993 WL 1138260 (U.S. PTO Utility Mar 02, 1993) (NO. 07/586391)**
Construed by
- H** **2 SightSound.Com Inc. v. N2K, Inc., 185 F.Supp.2d 445, 2002 Markman 229872 (W.D.Pa. Feb 08, 2002) (NO. CIV.A.98-CV-118) (Markman Order Version)**
AND Ruled Valid by
- H** **3 Sightsound.com Inc. v. N2K, Inc., 391 F.Supp.2d 321 (W.D.Pa. Oct 24, 2003) (NO. CIV.A. 98-CV-118)**
- H** **4 SYSTEM FOR TRANSMITTING DESIRED DIGITAL VIDEO OR AUDIO SIGNALS, US PAT 5675734, 1997 WL 1488819 (U.S. PTO Utility Oct 07, 1997) (NO. 08/607648)**
Construed by
- H** **5 SightSound.Com Inc. v. N2K, Inc., 185 F.Supp.2d 445, 2002 Markman 229872 (W.D.Pa. Feb 08, 2002) (NO. CIV.A.98-CV-118) (Markman Order Version)**
AND Ruled Valid by
- H** **6 Sightsound.com Inc. v. N2K, Inc., 391 F.Supp.2d 321 (W.D.Pa. Oct 24, 2003) (NO. CIV.A. 98-CV-118)**
- H** **7 SYSTEM AND METHOD FOR TRANSMITTING DESIRED DIGITAL VIDEO OR DIGITAL AUDIO SIGNALS, US PAT 5966440, 1999 WL 1731614 (U.S. PTO Utility Oct 12, 1999) (NO. 08/471964)**
Construed by
- H** **8 SightSound.Com Inc. v. N2K, Inc., 185 F.Supp.2d 445, 2002 Markman 229872 (W.D.Pa. Feb 08, 2002) (NO. CIV.A.98-CV-118) (Markman Order Version)**
AND Ruled Valid by
- H** **9 Sightsound.com Inc. v. N2K, Inc., 391 F.Supp.2d 321 (W.D.Pa. Oct 24, 2003) (NO. CIV.A. 98-CV-118)**

Court Documents

Trial Court Documents (U.S.A.)

W.D.Pa. Expert Testimony

- 10 SIGHTSOUND.COM INCORPORATED, a Pennsylvania corporation, Plaintiff, v. N2K, INC., a Delaware corporation, Cdnw, Inc., a Pennsylvania corporation, and Cdnw Online, Inc., a Pennsylvania corporation, Defendants., 1998 WL 34373758 (Expert Report and Affidavit) (W.D.Pa. 1998) **Opening Expert Report of James A. Moorer** (NO. 98-0118)
- 11 SIGHTSOUND.COM INCORPORATED, A Pennsylvania corporation, Plaintiff, v. N2K, INC., a Delaware corporation CDNOW, Inc., A Pennsylvania corporation, and CDNOW Online, Inc., a Pennsylvania corporation, Defendants., 2001 WL 34891529 (Expert Deposition) (W.D.Pa. Apr. 19, 2001) **Proceedings** (NO. 98-118)
- 12 SIGHTSOUND.COM INCORPORATED, a Pennsylvania corporation, Plaintiff, v. N2K, INC., a Delaware Corporation, CDNOW, INC., a CDNOW Online, Inc., a Pennsylvania corporation, Defendants., 2002 WL 32994569 (Expert Report and Affidavit) (W.D.Pa. Dec. 24, 2002) **Expert Report of Michael Ian Shamos, Ph.D., J.D.** (NO. 98-118)
- 13 SIGHTSOUND.COM INCORPORATED, Plaintiff, v. N2K, INC., CDNow, Inc., and CDNow Online, Inc., Defendants., 2003 WL 24288805 (Expert Report and Affidavit) (W.D.Pa. Jan. 21, 2003) **Expert Report of Justin Douglas Tygar, Ph.D.** (NO. 98-0118)
- 14 SIGHTSOUND.COM INCORPORATED, a Pennsylvania corporation, Plaintiff, v. N2K, INC., a Delaware corporation, Cdnw, Inc., a Pennsylvania corporation, and Cdnw Online, Inc., a Pennsylvania corporation, Defendants., 2003 WL 24288806 (Expert Report and Affidavit) (W.D.Pa. Feb. 19, 2003) **Rebuttal Expert Report of James A. Moorer to Opening Report of Professor Tygar** (NO. 98-0118)
- 15 SIGHTSOUND.COM INCORPORATED a Pennsylvania corporation, Plaintiff, v. N2K, INC., a Delaware Corporation, Cdnw, Inc., a Pennsylvania corporation, and Cdnw Online, Inc., a Pennsylvania corporation, Defendants., 2003 WL 24288804 (Expert Report and Affidavit) (W.D.Pa. Feb. 20, 2003) **Rebuttal Report of Michael Ian Shamos, PH.D., J.D.** (NO. 98-118)
- 16 SIGHTSOUND.COM INCORPORATED, Plaintiff, v. N2K, INC., CDnow, Inc., and CDnow Online, Inc., Defendants., 2003 WL 24289706 (Expert Report and Affidavit) (W.D.Pa. Feb. 20, 2003) **Rebuttal Expert Report of Justin Douglas Tygar, Ph.D.** (NO. 98-0118)
- 17 SIGHTSOUND.COM INCORPORATED, a Pennsylvania corporation, Plaintiff, v. N2K, INC., a Delaware corporation, Cdnw, Inc., a Pennsylvania corporation, and Cdnw Online, Inc., a Pennsylvania corporation, Defendants., 2003 WL 24309949 (Partial Expert Testimony) (W.D.Pa. Mar. 3, 2003) **(Partial Testimony)** (NO. 98-0118)
- 18 SIGHTSOUND.COM INCORPORATED, Plaintiff, v. N2K, INC., Cdnw, Inc., and Cdnw Online, Inc., Defendants., 2003 WL 24309947 (Partial Expert Testimony) (W.D.Pa. Mar. 9, 2003) **Deposition of Justin Douglas Tygar, Ph.D.** (NO. 98-0118)
- 19 SIGHTSOUND.COM INCORPORATED, a Pennsylvania corporation, Plaintiff, v. N2K, INC., a Delaware corporation, Cdnw, Inc., a Pennsylvania corporation, and Cdnw Online, Inc., a Pennsylvania corporation, Defendants., 2003 WL 24309950 (Expert Deposition) (W.D.Pa. Mar. 11, 2003) **(Deposition)** (NO. 98-0118)
- 20 In the Matter of: SIGHTSOUBD.COM INC., v. N2K, INC. et al., 2003 WL 24309948 (Partial

- Expert Testimony) (W.D.Pa. Mar. 12, 2003) **(Partial Testimony)** (NO. 98-0118)
- 21 SIGHTSOUND.COM, INC., a Pennsylvania corporation, Plaintiff, v. N2K, INC., a Delaware corporation, Cdnw, Inc., a Pennsylvania corporation, and Cdnw Online, Inc., a Pennsylvania corporation, Defendants., 2003 WL 24288807 (Expert Report and Affidavit) (W.D.Pa. Apr. 23, 2003) **Declaration by James A. Moorer in Support of Defendants' Motion for Summary Judgment** (NO. 98-0118)
- 22 SIGHTSOUND.COM, INC., a Pennsylvania corporation, Plaintiff and, Counterdefendants, v. N2K, INC., a Delaware corporation, CDNOW, Inc., a Pennsylvania corporation, and Cdnw Online, INC., a Pennsylvania corporation, Defendants and Counterclaimants., 2004 WL 3735168 (Expert Report and Affidavit) (W.D.Pa. Jan. 27, 2004) **Declaration of Michael Ian Shamos in Support of Defendants' Motion for Summary Judgment** (NO. 98-0118)

W.D.Pa. Trial Motions, Memoranda And Affidavits

- 23 SIGHTSOUND.COM INC., Plaintiff, v. N2K, INC., Cdnw, Inc., and CDnow Online, Inc., Defendants., 2004 WL 3742179 (Trial Motion, Memorandum and Affidavit) (W.D.Pa. Jan. 12, 2004) **Sightsound's Motion in Limine to Preclude Certain Testimony of James A. Moorer, Ph. D.** (NO. 98-0118)
- 24 SIGHTSOUND.COM INC., Plaintiff, v. N2K, INC., CDnow, Inc., and CDnow Online, Inc., Defendants., 2004 WL 3742180 (Trial Motion, Memorandum and Affidavit) (W.D.Pa. Jan. 12, 2004) **Sightsound's Motion in Limine to Preclude Certain Testimony of Michael Ian Shamos, Ph.D., J.D.** (NO. 98-0118)
- 25 SIGHTSOUND.COM INC., v. N2K, INC., et al., 2004 WL 5855261 (Trial Motion, Memorandum and Affidavit) (W.D.Pa. Jan. 12, 2004) **Sightsound's Motion in Limine to Preclude the Testimony of Gerald Mossinghoff** (NO. 98CV00118)
- 26 SIGHTSOUND.COM INC., Plaintiff, v. N2K, INC., CDnow, Inc., and CDnow Online, Inc., Defendants., 2004 WL 3742181 (Trial Motion, Memorandum and Affidavit) (W.D.Pa. Jan. 27, 2004) **Defendants' Opposition to Plaintiff's Motion in Limine to Preclude Certain Testimony of James A. Moorer, Ph.D** (NO. 98-0118)
- 27 SIGHTSOUND.COM INC., Plaintiff, v. N2K, INC., Cdnw, Inc., and CDnow Online, Inc., Defendants., 2004 WL 3742182 (Trial Motion, Memorandum and Affidavit) (W.D.Pa. Jan. 27, 2004) **Defendants' Opposition to Plaintiff's Motion in Limine to Preclude Certain Testimony of Michael Shamos, Ph.D, JD.** (NO. 98-0118)
- 28 SIGHTSOUND.COM INC., v. N2K, INC., et al., 2004 WL 5855262 (Trial Motion, Memorandum and Affidavit) (W.D.Pa. Jan. 27, 2004) **Defendants' Memorandum in Opposition to Sightsound's Motion in Limine to Preclude the Testimony of Gerald Mossinghoff** (NO. 98CV00118)

Dockets (U.S.A.)

W.D.Pa.

- 29 SIGHTSOUND.COM INC. v. N2K, INC., ET AL, NO. 2:98cv00118 (Docket) (W.D.Pa. Jan. 16, 1998)

Expert Court Documents (U.S.A.)

W.D.Pa. Expert Testimony

- 30 SIGHTSOUND.COM INCORPORATED, a Pennsylvania corporation, Plaintiff, v. N2K, INC., a Delaware corporation, Cdnw, Inc., a Pennsylvania corporation, and Cdnw Online, Inc., a Pennsylvania corporation, Defendants., 1998 WL 34373758 (Expert Report and Affidavit) (W.D.Pa. 1998) **Opening Expert Report of James A. Moorer** (NO. 98-0118)
- 31 SIGHTSOUND.COM INCORPORATED, A Pennsylvania corporation, Plaintiff, v. N2K, INC., a Delaware corporation CDNOW, Inc., A Pennsylvania corporation, and CDNOW Online, Inc., a Pennsylvania corporation, Defendants., 2001 WL 34891529 (Expert Deposition) (W.D.Pa. Apr. 19, 2001) **Proceedings** (NO. 98-118)
- 32 SIGHTSOUND.COM INCORPORATED, a Pennsylvania corporation, Plaintiff, v. N2K, INC., a Delaware Corporation, CDNOW, INC., a CDNOW Online, Inc., a Pennsylvania corporation, Defendants., 2002 WL 32994569 (Expert Report and Affidavit) (W.D.Pa. Dec. 24, 2002) **Expert Report of Michael Ian Shamos, Ph.D., J.D.** (NO. 98-118)
- 33 SIGHTSOUND.COM INCORPORATED, Plaintiff, v. N2K, INC., CDNow, Inc., and CDNow Online, Inc., Defendants., 2003 WL 24288805 (Expert Report and Affidavit) (W.D.Pa. Jan. 21, 2003) **Expert Report of Justin Douglas Tygar, Ph.D.** (NO. 98-0118)
- 34 SIGHTSOUND.COM INCORPORATED, a Pennsylvania corporation, Plaintiff, v. N2K, INC., a Delaware corporation, Cdnw, Inc., a Pennsylvania corporation, and Cdnw Online, Inc., a Pennsylvania corporation, Defendants., 2003 WL 24288806 (Expert Report and Affidavit) (W.D.Pa. Feb. 19, 2003) **Rebuttal Expert Report of James A. Moorer to Opening Report of Professor Tygar** (NO. 98-0118)
- 35 SIGHTSOUND.COM INCORPORATED a Pennsylvania corporation, Plaintiff, v. N2K, INC., a Delaware Corporation, Cdnw, Inc., a Pennsylvania corporation, and Cdnw Online, Inc., a Pennsylvania corporation, Defendants., 2003 WL 24288804 (Expert Report and Affidavit) (W.D.Pa. Feb. 20, 2003) **Rebuttal Report of Michael Ian Shamos, PH.D., J.D.** (NO. 98-118)
- 36 SIGHTSOUND.COM INCORPORATED, Plaintiff, v. N2K, INC., CDnow, Inc., and CDnow Online, Inc., Defendants., 2003 WL 24289706 (Expert Report and Affidavit) (W.D.Pa. Feb. 20, 2003) **Rebuttal Expert Report of Justin Douglas Tygar, Ph.D.** (NO. 98-0118)
- 37 SIGHTSOUND.COM INCORPORATED, a Pennsylvania corporation, Plaintiff, v. N2K, INC., a Delaware corporation, Cdnw, Inc., a Pennsylvania corporation, and Cdnw Online, Inc., a Pennsylvania corporation, Defendants., 2003 WL 24309949 (Partial Expert Testimony) (W.D.Pa. Mar. 3, 2003) **(Partial Testimony)** (NO. 98-0118)
- 38 SIGHTSOUND.COM INCORPORATED, Plaintiff, v. N2K, INC., Cdnw, Inc., and Cdnw Online, Inc., Defendants., 2003 WL 24309947 (Partial Expert Testimony) (W.D.Pa. Mar. 9, 2003) **Deposition of Justin Douglas Tygar, Ph.D.** (NO. 98-0118)
- 39 SIGHTSOUND.COM INCORPORATED, a Pennsylvania corporation, Plaintiff, v. N2K, INC., a Delaware corporation, Cdnw, Inc., a Pennsylvania corporation, and Cdnw Online, Inc., a Pennsylvania corporation, Defendants., 2003 WL 24309950 (Expert Deposition) (W.D.Pa. Mar. 11, 2003) **(Deposition)** (NO. 98-0118)

- 40 In the Matter of: SIGHTSOUBD.COM INC., v. N2K, INC. et al., 2003 WL 24309948 (Partial Expert Testimony) (W.D.Pa. Mar. 12, 2003) (**Partial Testimony**) (NO. 98-0118)
- 41 SIGHTSOUND.COM, INC., a Pennsylvania corporation, Plaintiff, v. N2K, INC., a Delaware corporation, Cdnow, Inc., a Pennsylvania corporation, and Cdnow Online, Inc., a Pennsylvania corporation, Defendants., 2003 WL 24288807 (Expert Report and Affidavit) (W.D.Pa. Apr. 23, 2003) **Declaration by James A. Moorer in Support of Defendants' Motion for Summary Judgment** (NO. 98-0118)
- 42 SIGHTSOUND.COM, INC., a Pennsylvania corporation, Plaintiff and, Counterdefendants, v. N2K, INC., a Delaware corporation, CDNOW, Inc., a Pennsylvania corporation, and Cdnow Online, INC., a Pennsylvania corporation, Defendants and Counterclaimants., 2004 WL 3735168 (Expert Report and Affidavit) (W.D.Pa. Jan. 27, 2004) **Declaration of Michael Ian Shamos in Support of Defendants' Motion for Summary Judgment** (NO. 98-0118)

W.D.Pa. Trial Motions, Memoranda And Affidavits

- 43 SIGHTSOUND.COM INC., Plaintiff, v. N2K, INC., Cdnow, Inc., and CDnow Online, Inc., Defendants., 2004 WL 3742179 (Trial Motion, Memorandum and Affidavit) (W.D.Pa. Jan. 12, 2004) **Sightsound's Motion in Limine to Preclude Certain Testimony of James A. Moorer, Ph. D.** (NO. 98-0118)
- 44 SIGHTSOUND.COM INC., Plaintiff, v. N2K, INC., CDnow, Inc., and CDnow Online, Inc., Defendants., 2004 WL 3742180 (Trial Motion, Memorandum and Affidavit) (W.D.Pa. Jan. 12, 2004) **Sightsound's Motion in Limine to Preclude Certain Testimony of Michael Ian Shamos, Ph.D., J.D.** (NO. 98-0118)
- 45 SIGHTSOUND.COM INC., Plaintiff, v. N2K, INC., CDnow, Inc., and CDnow Online, Inc., Defendants., 2004 WL 3742181 (Trial Motion, Memorandum and Affidavit) (W.D.Pa. Jan. 27, 2004) **Defendants' Opposition to Plaintiff's Motion in Limine to Preclude Certain Testimony of James A. Moorer, Ph.D** (NO. 98-0118)
- 46 SIGHTSOUND.COM INC., Plaintiff, v. N2K, INC., Cdnow, Inc., and CDnow Online, Inc., Defendants., 2004 WL 3742182 (Trial Motion, Memorandum and Affidavit) (W.D.Pa. Jan. 27, 2004) **Defendants' Opposition to Plaintiff's Motion in Limine to Preclude Certain Testimony of Michael Shamos, Ph.D, JD.** (NO. 98-0118)

W.D.Pa.

- 47 SIGHTSOUND.COM INC. v. N2K, INC., ET AL, NO. 2:98cv00118 (Docket) (W.D.Pa. Jan. 16, 1998)

Patent Family

- 48 TRANSMITTING DESIRED DIGITAL VIDEO OR AUDIO SIGNAL - TRANSFERRING MONEY VIA TELECOMMUNICATIONS LINE, CONNECTING ELECTRONICALLY FIRST MEMORY WITH SECOND MEMORY AND TRANSMITTING SIGNAL WITH TRANSMITTER IN CONTROL OF FIRST, Derwent World Patents Legal 1993-093541

Assignments

- 49 Action: ASSIGNMENT OF ASSIGNORS INTEREST (SEE DOCUMENT FOR DETAILS). Number of Pages: 006, (DATE RECORDED: Dec 27, 2005)
- 50 ACTION: NOTICE OF GRANT OF SECURITY INTEREST NUMBER OF PAGES: 006, (DATE RECORDED: Oct 24, 2001)
- 51 ACTION: CHANGE OF NAME (SEE DOCUMENT FOR DETAILS). NUMBER OF PAGES: 016, (DATE RECORDED: May 03, 2000)
- 52 ASSIGNEE(S): PARSEC SIGHT/SOUND, INC., (DATE RECORDED: Oct 02, 1995)

Patent Status Files

- .. Request for Re-Examination, (OG DATE: Mar 29, 2005)
- .. Patent Suit(See LitAlert Entries),
- .. Certificate of Correction, (OG DATE: Dec 21, 1993)

Docket Summaries

- 56 "SIGHTSOUND TECH v. ROXIO, INC., ET AL", (W.D.PA. Oct 08, 2004) (NO. 2:04CV01549), (35 USC 271 PATENT INFRINGEMENT)

Litigation Alert

- 57 Derwent LitAlert P1998-06-59 (1999) Action Taken: A complaint was filed.

Prior Art (Coverage Begins 1976)

- ▶ 58 AUTOMATIC INFORMATION, GOODS AND SERVICES DISPENSING SYSTEM, US PAT 4567359 (U.S. PTO Utility 1986)
- C 59 COIN-OPERATED RECORDING MACHINE, US PAT 3990710 (U.S. PTO Utility 1976)
- C 60 SOFTWARE VENDING SYSTEM, US PAT 4654799Assignee: Brother Kogyo Kabushiki Kaisha, (U.S. PTO Utility 1987)
- C 61 VENDING SYSTEM FOR REMOTELY ACCESSIBLE STORED INFORMATION, US PAT 3718906Assignee: Lightner R, (U.S. PTO Utility 1973)
- C 62 VIDEO CASSETTE SELECTION MACHINE, US PAT 4647989 (U.S. PTO Utility 1987)

US District Court Civil Docket

**U.S. District - Pennsylvania Western
(Pittsburgh)**

2:04cv1549

Sightsound Tech v. Roxio, Inc, et al

This case was retrieved from the court on Monday, August 04, 2008

Date Filed: 10/08/2004	Class Code: CLOSED
Assigned To: Chief Judge Donetta W Ambrose	Closed: Yes
Referred To:	Statute: 35:271
Nature of suit: Patent (830)	Jury Demand: Both
Cause: Patent Infringement	Demand Amount: \$0
Lead Docket: None	NOS Description: Patent
Other Docket: Dkt in other court: 05-01277	
Dkt in other court: Related, 2:98-cv-118	
Jurisdiction: Federal Question	

Litigants

Sightsound Technologies, Inc A Delaware Corporation
Plaintiff

Attorneys

Brian S Mudge
[COR LD NTC]
Kenyon & Kenyon
1500 K Street, NW
Suite 700
Washington , DC 20005-1257
USA
(202) 220-4200
Fax: (202) 220-4201
Email: BMUDGE@KENYON.COM

Clyde E Findley
[COR LD NTC]
[Term: 04/28/2006]
Kenyon & Kenyon
1500 K Street, NW
Suite 700
Washington , DC 20005-1257
USA
(202) 220-4200

Duncan L Williams
[COR LD NTC]
Kenyon & Kenyon
1500 K Street, NW
Suite 700
Washington , DC 20005-1257
USA
(202) 220-4200
Email: Dlwilliams@kenyon.com

Richard F Rinaldo
[COR LD NTC]
Williams Coulson
One Gateway Center
420 Fort Duquesne Boulevard, 16TH Floor

Roxio, Inc A Delaware Corporation
Defendant

Pittsburgh , PA 15222
USA
(412) 454-0259
Fax: (412) 281-6622
Email: RRINALDO@WILLIAMSCOULSON.COM

William K Wells
[COR LD NTC]
Kenyon & Kenyon
1500 K Street, NW
Suite 700
Washington , DC 20005-1257
USA
(202) 220-4200
Email: Wwells@kenyon.com

Charles K Verhoeven
[COR LD NTC]
Quinn, Emanuel, Urquhart, Oliver & Hedges
50 California Street
22ND Floor
San Francisco , CA 94111
USA
(415) 875-6600
Email: Charlesverhoeven@quinnemanuel.com

Kathryn M Kenyon
[COR LD NTC]
Pietragallo Gordon Alfano Bosick & Raspanti, LLP
38TH Floor, One Oxford Centre
301 Grant Street
Pittsburgh , PA 15219
USA
(412) 263-1837
Fax: (412) 263-2001
Email: KMK@PIETRAGALLO.COM

Kevin P Allen
[COR LD NTC]
[Term: 01/11/2005]
Thorp, Reed & Armstrong
301 Grant Street
One Oxford Centre, 14TH Floor
Pittsburgh , PA 15219-1425
USA
(412) 394-2366
Email: Kallen@thorpreed.com

Laurence Z Shiekman
[COR LD NTC]
Pepper Hamilton Eighteenth & Arch Streets
3000 Two Logan Square
Philadelphia , PA 19103-2799
USA
(215) 981-4000
Email: Shiekmanl@pepperlaw.com

Michael E Williams
[COR LD NTC]
Quinn, Emanuel, Urquhart, Oliver & Hedges
865 South Figueroa Street
10TH Floor
Los Angeles , CA 90017
USA
(213) 443-3000
Email: Michaelwilliams@quinnemanuel.com

Tigran Guledjian
[COR LD NTC]
Quinn, Emanuel, Urquhart, Oliver & Hedges
865 South Figueroa Street
10TH Floor
Los Angeles , CA 90017
USA
(213) 443-3000
Email: Tigranguledjian@quinnemanuel.com

William M Wycoff
[COR LD NTC]
[Term: 01/11/2005]
Thorp, Reed & Armstrong
301 Grant Street
One Oxford Centre, 14TH Floor
Pittsburgh , PA 15222-4895
USA
394-7782
Email: Wwycoff@thorpreed.com

Napster, Llc A Delaware Limited Liability Company
Defendant

Charles K Verhoeven
[COR LD NTC]
Quinn, Emanuel, Urquhart, Oliver & Hedges
50 California Street
22ND Floor
San Francisco , CA 94111
USA
(415) 875-6600
Email: Charlesverhoeven@quinnemanuel.com

Kathryn M Kenyon
[COR LD NTC]
Pietragallo Gordon Alfano Bosick & Raspanti, LLP
38TH Floor, One Oxford Centre
301 Grant Street
Pittsburgh , PA 15219
USA
(412) 263-1837
Fax: (412) 263-2001
Email: KMK@PIETRAGALLO.COM

Kevin P Allen
[COR LD NTC]
[Term: 01/11/2005]
Thorp, Reed & Armstrong
301 Grant Street
One Oxford Centre, 14TH Floor
Pittsburgh , PA 15219-1425
USA
(412) 394-2366
Email: Kallen@thorpreed.com

Laurence Z Shiekman
[COR LD NTC]
Pepper Hamilton Eighteenth & Arch Streets
3000 Two Logan Square
Philadelphia , PA 19103-2799
USA
(215) 981-4000
Email: Shiekmanl@pepperlaw.com

Michael E Williams
[COR LD NTC]
Quinn, Emanuel, Urquhart, Oliver & Hedges

865 South Figueroa Street
10TH Floor
Los Angeles , CA 90017
USA
(213) 443-3000
Email: Michaelwilliams@quinnemanuel.com

Michael T Zeller
[COR LD NTC]
Quinn Emanuel Urquhart Oliver & Hedges
865 S Figueroa Street, 10TH Floor
Los Angeles , CA 90017
USA
(213) 443-3000
Email: Michaelzeller@quinnemanuel.com

Tigran Guledjian
[COR LD NTC]
Quinn, Emanuel, Urquhart, Oliver & Hedges
865 South Figueroa Street
10TH Floor
Los Angeles , CA 90017
USA
(213) 443-3000
Email: Tigranguledjian@quinnemanuel.com

William M Wycoff
[COR LD NTC]
[Term: 01/11/2005]
Thorp, Reed & Armstrong
301 Grant Street
One Oxford Centre, 14TH Floor
Pittsburgh , PA 15222-4895
USA
394-7782
Email: Wwycoff@thorpreed.com

Scott Sander
Counter Defendant

Brian S Mudge
[COR LD NTC]
Kenyon & Kenyon
1500 K Street, NW
Suite 700
Washington , DC 20005-1257
USA
(202) 220-4200
Fax: (202) 220-4201
Email: BMUDGE@KENYON.COM

Richard F Rinaldo
[COR LD NTC]
Williams Coulson
One Gateway Center
420 Fort Duquesne Boulevard, 16TH Floor
Pittsburgh , PA 15222
USA
(412) 454-0259
Fax: (412) 281-6622
Email: RRINALDO@WILLIAMSCOULSON.COM

William K Wells
[COR LD NTC]
Kenyon & Kenyon
1500 K Street, NW
Suite 700
Washington , DC 20005-1257
USA

Date	#	Proceeding Text
10/08/2004	1	COMPLAINT with summons issued; jury demand Filing Fee \$ 150.00 Receipt # 05000126 (tt) (Entered: 10/08/2004)
10/08/2004	2	DISCLOSURE statement by SIGHTSOUND TECH (tt) (Entered: 10/08/2004)
10/08/2004	--	COPY of Complaint and Docket Entries mailed to the Commissioner of Patents and Trademarks. (tt) (Entered: 10/08/2004)
11/08/2004	3	RETURN OF SERVICE executed as to ROXIO, INC. 11/5/04 Answer due on 11/26/04 for ROXIO, INC. (tt) (Entered: 11/09/2004)
11/08/2004	4	RETURN OF SERVICE executed as to NAPSTER, L.L.C. 11/5/04 Answer due on 11/26/04 for NAPSTER, L.L.C. (tt) (Entered: 11/09/2004)
11/24/2004	5	ANSWER to Complaint; jury demand and COUNTERCLAIM by ROXIO, INC., NAPSTER, L.L.C. (Attorney William M. Wycoff, Kevin P. Allen, Charles K. Verhoeven, Michael E. Williams) against SIGHTSOUND TECH (tt) Modified on 03/11/2005 (Entered: 11/24/2004)
11/24/2004	6	DISCLOSURE statement by ROXIO, INC., NAPSTER, L.L.C. (tt) (Entered: 11/24/2004)
11/24/2004	7	NOTICE Opting Out of Arbitration by ROXIO, INC., NAPSTER, L.L.C. (tt) (Entered: 11/24/2004)
12/15/2004	8	ANSWER by SIGHTSOUND TECH to [5-2] counterclaims by NAPSTER, L.L.C., ROXIO, INC. (tt) (Entered: 12/16/2004)
12/17/2004	9	Case Management Conference set for 9:15 1/11/05 (tt) (Entered: 12/17/2004)
01/10/2005	10	INITIAL Case Scheduling Conference Statement by ROXIO, INC., NAPSTER, L.L.C. (tt) (Entered: 01/10/2005)
01/10/2005	11	MOTION by SIGHTSOUND TECH for Preliminary Injunction , with Proposed Order. (tt) (Entered: 01/11/2005)
01/10/2005	12	EXHIBITS by SIGHTSOUND TECH to [11-1] motion for Preliminary Injunction (tt) (Entered: 01/11/2005)
01/10/2005	13	BRIEF by SIGHTSOUND TECH in support of [11-1] motion for Preliminary Injunction by SIGHTSOUND TECH (tt) (Entered: 01/11/2005)
01/10/2005	14	DECLARATION of Justin Douglas Tygar, Ph.D. concerning the Operation of Roxio/Napster Re: [11-1] motion for Preliminary Injunction by SIGHTSOUND TECH (tt) (Entered: 01/11/2005)
01/11/2005	15	MOTION by ROXIO, INC., NAPSTER, L.L.C. to Substitute Attorney , with Proposed Order. (tt) (Entered: 01/11/2005)
01/11/2005	16	MOTION by ROXIO, INC., NAPSTER, L.L.C. for Charles K. Verhoeven to Appear Pro Hac Vice ; Filing Fee \$ 40.00 Receipt # 05001581 , with Proposed Order. (tt) (Entered: 01/11/2005)
01/11/2005	17	MOTION by ROXIO, INC., NAPSTER, L.L.C. for Tigran Guledjian to Appear Pro Hac Vice ; Filing Fee \$ 40.00 Receipt # 05001581 , with Proposed Order. (tt) (Entered: 01/11/2005)
01/11/2005	18	MOTION by ROXIO, INC., NAPSTER, L.L.C. for Michael E. Williams to Appear Pro Hac Vice ; Filing Fee \$ 40.00 Receipt # 05001581 , with Proposed Order. (tt) (Entered: 01/11/2005)
01/11/2005	19	Status Conference held 1/11/05 before Chief Judge Donetta W. Ambrose [Reporter: none] (tt) (Entered: 01/11/2005)
01/11/2005	--	Deadline updated; Response to Motion set to 2/11/05 for [11-1] motion for Preliminary Injunction ; Reply to Response to Motion set to 2/21/05 for [11-1] motion for Preliminary Injunction ; Motion Hearing set for 1:30 3/3/05 for [11-1] motion for Preliminary Injunction (tt) (Entered: 01/11/2005)
01/11/2005	20	RESPONSE by SIGHTSOUND TECH to defts' [10-1] Initial Case Scheduling Conference Statement. (tt) (Entered: 01/11/2005)
01/11/2005	--	ORDER upon motion granting [15-1] motion to Substitute Attorney ; terminated attorney William M. Wycoff for ROXIO, INC., attorney Kevin P. Allen for ROXIO, INC., attorney William M. Wycoff for NAPSTER, L.L.C., attorney Kevin P. Allen for NAPSTER, L.L.C. and added Laurence Z. Shiekman, Kathryn M. Kenyon for defts. (signed by Chief Judge Donetta W. Ambrose on 1/11/05) CM all parties of record. (tt) (Entered: 01/12/2005)
01/11/2005	--	ORDER upon motion granting [16-1] motion for Charles K. Verhoeven to Appear Pro Hac Vice on

behalf of defts. (signed by Chief Judge Donetta W. Ambrose on 1/11/05) CM all parties of record. (tt) (Entered: 01/12/2005)

01/11/2005 -- ORDER upon motion granting [17-1] motion for Tigran Guledjian to Appear Pro Hac Vice on behalf of defts. (signed by Chief Judge Donetta W. Ambrose on 1/11/05) CM all parties of record. (tt) (Entered: 01/12/2005)

01/11/2005 -- ORDER upon motion granting [18-1] motion for Michael E. Williams to Appear Pro Hac Vice on behalf of defts. (signed by Chief Judge Donetta W. Ambrose on 1/11/05) CM all parties of record. (tt) (Entered: 01/12/2005)

01/18/2005 21 Status Conference via phone held 1/18/05 before Chief Judge Donetta W. Ambrose [Reporter: none] ; Deft wants leave to amend counterclaims related to press release. Pltf doesn't object to motion for leave to amend. Leave granted orally by the Court; Amended counterclaim due 1/25/05. Deft to file a Motion to Stay Case pending outcome of application to Patent & Trademark Office, response due w/in 10 days. (tt) (Entered: 01/19/2005)

01/21/2005 22 MOTION by ROXIO, INC., NAPSTER, L.L.C. to Stay Pending Reexamination of Patents in Suit with Proposed Order. (jsp) (Entered: 01/24/2005)

01/21/2005 23 BRIEF by ROXIO, INC., NAPSTER, L.L.C. in support of [22-1] motion to Stay Pending Reexamination of Patents in Suit by NAPSTER, L.L.C., ROXIO, INC. (jsp) (Entered: 01/24/2005)

01/25/2005 24 FIRST AMENDED ANSWER to Complaint by ROXIO, INC., NAPSTER, L.L.C. amends: [5-1] answer by NAPSTER, L.L.C., ROXIO, INC. and COUNTERCLAIMS against SIGHTSOUND TECH (tt) (Entered: 01/26/2005)

01/27/2005 25 MOTION by SIGHTSOUND TECH to Extend Time w/in which to respond to defts' motion to stay pending receipt of defts' request for re-examination of patents and prior art which defts intend to submit to the Patent and Trademark Office , with Proposed Order. (tt) (Entered: 01/28/2005)

01/28/2005 26 RESPONSE by ROXIO, INC., NAPSTER, L.L.C. to pltf's [25-1] motion to Extend Time w/in which to respond to defts' motion to stay (tt) (Entered: 01/28/2005)

01/28/2005 27 ACCEPTANCE OF SERVICE of First Amended Answer and Counterclaim as to Scott Sander executed 1/26/05 (tt) (Entered: 01/28/2005)

01/28/2005 28 BRIEF by SIGHTSOUND TECH in support of [25-1] motion to Extend Time w/in which to respond to defts' motion to stay (tt) (Entered: 01/31/2005)

02/02/2005 29 Status Conference via phone held 1/31/05 before Chief Judge Donetta W. Ambrose [Reporter: none] ; Pltf's response to motion to stay due 2/11/05 ; Defts' reply due 2/16/05 ; Preliminary injunction date will be scheduled via order on motion to stay ; Defts do not have to file answer to preliminary injunction by March. (tt) (Entered: 02/02/2005)

02/02/2005 -- ORDER upon motion granting [25-1] motion to Extend Time w/in which to respond to defts' motion to stay pending receipt of defts' request for re-examination of patents and prior art which defts intend to submit to the Patent and Trademark Office. Defts shall serve on counsel for pltf by overnight delivery sent no later than 2/1/05 any request for re-examination of the patents in suit which defts intend to file with the PTO, including all prior art on which defts plan to rely in such request for re-examination ; Pltf's Response to Motion set to 2/11/05 for defts' [22-1] motion to Stay Pending Reexamination of Patents in Suit ; Defts' Reply Brief due 2/16/05 ; Defts are not required to file an answer to pltf's motion for preliminary injunction until further order of court. (signed by Chief Judge Donetta W. Ambrose on 1/31/05) CM all parties of record. (tt) (Entered: 02/02/2005)

02/03/2005 30 MOTION by SIGHTSOUND TECH for Brian S. Mudge to Appear Pro Hac Vice ; Filing Fee \$ 40.00 Receipt # 05001943 , with Proposed Order. (tt) (Entered: 02/04/2005)

02/03/2005 31 MOTION by SIGHTSOUND TECH for William K. Wells to Appear Pro Hac Vice ; Filing Fee \$ 40.00 Receipt # 05001943 , with Proposed Order. (tt) (Entered: 02/04/2005)

02/03/2005 32 MOTION by SIGHTSOUND TECH for Duncan L. Williams to Appear Pro Hac Vice ; Filing Fee \$ 40.00 Receipt # 05001943 , with Proposed Order. (tt) (Entered: 02/04/2005)

02/03/2005 33 MOTION by SIGHTSOUND TECH for Clyde E. Findley to Appear Pro Hac Vice ; Filing Fee \$40.00 05001943 Receipt # 05001943 , with Proposed Order. (tt) (Entered: 02/04/2005)

02/04/2005 34 NOTICE of Lodging of Pending Requests for Reexamination by ROXIO, INC., NAPSTER, L.L.C. (tt) (Entered: 02/04/2005)

02/04/2005 35 EXHIBITS (VOLUME I) by ROXIO, INC., NAPSTER, L.L.C. to [34-1] notice of lodging of pending requests for reexamination. (tt) (Entered: 02/04/2005)

02/04/2005 36 EXHIBITS (VOLUME II) by ROXIO, INC., NAPSTER, L.L.C. to [34-1] notice of lodging of pending requests for reexamination. (tt) (Entered: 02/04/2005)

02/04/2005 37 EXHIBITS (VOLUME III) by ROXIO, INC., NAPSTER, L.L.C. to [34-1] notice of lodging of pending requests for reexamination. (tt) (Entered: 02/04/2005)

02/07/2005 -- ORDER upon motion granting [30-1] motion for Brian S. Mudge to Appear Pro Hac Vice on behalf of pltf. (signed by Chief Judge Donetta W. Ambrose on 2/4/05) CM all parties of record. (tt) (Entered: 02/07/2005)

02/07/2005 -- ORDER upon motion granting [31-1] motion for William K. Wells to Appear Pro Hac Vice on behalf of pltf. (signed by Chief Judge Donetta W. Ambrose on 2/4/05) CM all parties of record. (tt) (Entered: 02/07/2005)

02/07/2005 -- ORDER upon motion granting [32-1] motion for Duncan L. Williams to Appear Pro Hac Vice on behalf of pltf. (signed by Chief Judge Donetta W. Ambrose on 2/4/05) CM all parties of record. (tt) (Entered: 02/07/2005)

02/07/2005 -- ORDER upon motion granting [33-1] motion for Clyde E. Findley to Appear Pro Hac Vice on behalf of pltf. (signed by Chief Judge Donetta W. Ambrose on 2/4/05) CM all parties of record. (tt) (Entered: 02/07/2005)

02/11/2005 38 REPLY by SIGHTSOUND TECH to [24-2] First Amended Counterclaims by NAPSTER, L.L.C., ROXIO, INC. (tt) (Entered: 02/14/2005)

02/11/2005 39 BRIEF by SIGHTSOUND TECH in opposition to Napster's [22-1] motion to Stay Pending Reexamination of Patents in Suit (tt) (Entered: 02/14/2005)

02/11/2005 40 MOTION by SIGHTSOUND TECH, SCOTT SANDER to Dismiss defts' Amended Counterclaims 4-9 . (tt) (Entered: 02/14/2005)

02/11/2005 41 BRIEF by SIGHTSOUND TECH, SCOTT SANDER in support of their [40-1] motion to Dismiss defts' Amended Counterclaims 4-9 (tt) (Entered: 02/14/2005)

02/16/2005 42 REPLY by ROXIO, INC., NAPSTER, L.L.C. in support of their Motion to Stay pending Reexamination of the Patents-In-Suit (tt) (Entered: 02/17/2005)

02/16/2005 43 DECLARATION of William E. Growney (tt) Modified on 02/18/2005 (Entered: 02/17/2005)

02/16/2005 44 MOTION by ROXIO, INC., NAPSTER, L.L.C. to Seal [43-1] Declaration , with Proposed Order. (tt) (Entered: 02/17/2005)

02/17/2005 45 OPPOSITION by SIGHTSOUND TECH to defts' [44-1] motion to Seal [43-1] Declaration (tt) (Entered: 02/18/2005)

02/17/2005 46 NOTICE OF FILING: Supplemental Declaration of Christopher Reese by SIGHTSOUND TECH (FILED UNDER SEAL) (tt) Modified on 02/28/2005 (Entered: 02/18/2005)

02/17/2005 47 REQUEST by SIGHTSOUND TECH for Oral Argument on Motion to Stay . (tt) (Entered: 02/18/2005)

02/18/2005 -- ORDER upon motion denying [44-1] motion to Seal [43-1] Declaration. The declaration speaks only of vague, unsuccessful attempts & no dollar values are set forth. I see no risk of confidential information being disclosed. (signed by Chief Judge Donetta W. Ambrose on 2/18/05) CM all parties of record. (tt) (Entered: 02/18/2005)

02/18/2005 -- ORDER upon motion denying [47-1] motion for Oral Argument on Motion to Stay. The parties have clearly represented their respective positions in the briefs and declarations filed. (signed by Chief Judge Donetta W. Ambrose on 2/18/05) CM all parties of record. (tt) (Entered: 02/18/2005)

02/23/2005 48 MOTION by ROXIO, INC., NAPSTER, L.L.C. to Seal Supplemental Declaration of Christopher Reese , with Proposed Order. (tt) (Entered: 02/23/2005)

02/23/2005 49 OPPOSITION by SIGHTSOUND TECH to defts' [48-1] motion to Seal Supplemental Declaration of Christopher Reese (tt) (Entered: 02/24/2005)

02/28/2005 -- ORDER upon motion granting [48-1] motion to Seal Supplemental Declaration of Christopher Reese. The Supplemental Declaration of Christopher Reese filed 2/17/05 shall be placed under seal. (signed by Chief Judge Donetta W. Ambrose on 2/28/05) CM all parties of record. (tt) (Entered: 02/28/2005)

02/28/2005 50 MEMORANDUM OPINION & ORDER granting defts' [22-1] motion to Stay. The defts are to contact this Court immediately upon receiving any notification from the PTO regarding the outcome of the Request for Reexamination. The preliminary injunction hearing scheduled for 3/3/05 is cancelled . The [11-1] motion for Preliminary Injunction is denied without prejudice to reassert once the stay is lifted. (signed by Chief Judge Donetta W. Ambrose on 2/28/05) CM all parties of record. (tt) (Entered: 02/28/2005)

03/03/2005 51 NOTICE OF APPEAL by SIGHTSOUND TECH from [50-1] memorandum opinion dated 2/28/05

FILING FEE \$ 255 RECEIPT # 2394 TPO issued. (lck) (Entered: 03/07/2005)

03/03/2005 -- Certified copy of Notice of Appeal [51-1] appeal by SIGHTSOUND TECH , certified copy of docket, certified copy of order dated 2/28/05 mailed to USCA; copy of Notice of Appeal and information sheet to ROXIO, INC., NAPSTER, L.L.C. and judge. Copy of information sheet to appellant. (lck) (Entered: 03/07/2005)

03/11/2005 52 Transcript Purchase order re: [51-1] appeal by SIGHTSOUND TECH indicating that no transcript is being ordered. (tt) (Entered: 03/11/2005)

03/21/2005 -- Text not available. (Entered: 03/21/2005)

04/04/2005 53 NOTICE of PTO's Order granting ex parte Reexamination by ROXIO, INC., NAPSTER, L.L.C. (tt) (Entered: 04/04/2005)

07/21/2005 54 MOTION for Relief from Stay with Respect to Defamation Counterclaims by SIGHTSOUND TECHNOLOGIES, INC., SCOTT SANDER. (Attachments: # 1 Proposed Order)(jsp) (Entered: 07/21/2005)

07/21/2005 55 BRIEF in Support re 54 MOTION for Relief from Stay with Respect to Defamation Counterclaims filed by SIGHTSOUND TECHNOLOGIES, INC., SCOTT SANDER. (Attachments: # 1 Part 2 of Brief)(jsp) (Entered: 07/21/2005)

07/22/2005 56 NOTICE: re 54 MOTION for Relief from Stay with Respect to Defamation Counterclaims:Response due on or before 8/4/05. (jlh) (Entered: 07/22/2005)

08/04/2005 57 NOTICE by ROXIO, INC., NAPSTER, L.L.C. of PTO's Issuance of Office Actions in Ex Parte Reexamination (Attachments: # 1 # 2 # 3)(Helmsen, Joseph) (Entered: 08/04/2005)

08/04/2005 58 MOTION for attorney Michael T. Zeller to Appear Pro Hac Vice by ROXIO, INC., NAPSTER, L.L.C.. (Attachments: # 1 Proposed Order)(Kenyon, Kathryn) (Entered: 08/04/2005)

08/04/2005 59 NOTICE by ROXIO, INC., NAPSTER, L.L.C. re 57 Notice (Other) Letter Notice of Prior Filing (Kenyon, Kathryn) (Entered: 08/04/2005)

08/04/2005 60 BRIEF in Opposition re 54 MOTION for Relief from Stay with Respect to Defamation Counterclaims filed by ROXIO, INC., NAPSTER, L.L.C.. (Attachments: # 1 Exhibit A# 2 Exhibit B# 3 Exhibit C# 4 Exhibit D# 5 Exhibit E# 6 Exhibit F# 7 Exhibit G# 8 Exhibit H)(Kenyon, Kathryn) (Entered: 08/04/2005)

08/04/2005 -- Pro Hac Vice Fees received in the amount of \$ 40 receipt # 4877 re 58 Motion to Appear Pro Hac Vice (ept) (Entered: 08/05/2005)

08/08/2005 61 ORDER granting 58 Motion to Appear Pro Hac Vice . Signed by Judge Donetta W. Ambrose on 8/8/05. (jlh) (Entered: 08/08/2005)

09/01/2005 62 ORDER denying 54 Motion for Relief from Stay . Signed by Judge Donetta W. Ambrose on 8/31/05. (jlh) (Entered: 09/01/2005)

09/06/2005 63 NOTICE by SIGHTSOUND TECHNOLOGIES, INC., SCOTT SANDER NOTICE OF FILING TO SUPPLEMENT RECORD (Kerr, Benjamin) (Entered: 09/06/2005)

09/07/2005 64 Minute Entry for proceedings held before Judge Donetta W. Ambrose : Status Conference held on 9/7/2005. Parties to keep Court informed of PTO Action. (jlh) (Entered: 09/07/2005)

11/02/2005 65 NOTICE by ROXIO, INC., NAPSTER, L.L.C. of PTO's Issuance of Second Office Actions in Ex Parte Reexamination (Attachments: # 1 Exhibit A# 2 Exhibit B# 3 Exhibit C)(Kenyon, Kathryn) (Entered: 11/02/2005)

11/14/2005 66 MANDATE of USCA for the Federal Circuit as to 51 Notice of Appeal filed by SIGHTSOUND TECHNOLOGIES, INC., that the appeal is dismissed, with each party to bear its own costs. (jsp) (Entered: 11/15/2005)

03/02/2006 67 MOTION by Clyde E. Findley to Withdraw as Attorney by SIGHTSOUND TECHNOLOGIES, INC. (jsp) (Entered: 03/02/2006)

05/10/2006 68 NOTICE by ROXIO, INC., NAPSTER, L.L.C. Defendants' Notice of PTO's Issuance of Final Office Actions in Ex Parte Reexamination and Request for Status Conference (Attachments: # 1 Exhibit A)(Kenyon, Kathryn) (Entered: 05/10/2006)

05/10/2006 69 EXHIBITS in Support of 68 Notice (Other) by ROXIO, INC., NAPSTER, L.L.C.. (Kenyon, Kathryn) (Entered: 05/10/2006)

05/10/2006 70 EXHIBITS in Support of 68 Notice (Other) by ROXIO, INC., NAPSTER, L.L.C.. (Kenyon, Kathryn) (Entered: 05/10/2006)

05/10/2006 -- MOTION (Request) for Status Conference by ROXIO, INC., NAPSTER, L.L.C..(with Document 68) (jsp) (Entered: 05/11/2006)

05/11/2006 -- CLERK'S OFFICE QUALITY CONTROL MESSAGE. re 68 Notice (Other) ERROR: Document should have been filed as two separate documents. CORRECTION: Attorney advised in future that documents of that nature are to be filed as separate documents. Clerk of Court docketed Request for Status Conference. This message is for informational purposes only. (jsp) (Entered: 05/11/2006)

05/31/2006 71 Minute Entry for proceedings held before Judge Donetta W. Ambrose : Telephone Conference held on 5/31/2006. (Court Reporter none) (jlh) (Entered: 05/31/2006)

05/31/2006 72 ORDER FOR ADMINISTRATIVE CLOSING.Signed by Judge Donetta W. Ambrose on 5/31/06. (jlh) (Entered: 05/31/2006)

06/02/2006 73 NOTICE by SIGHTSOUND TECHNOLOGIES, INC. Notice of Filing by Sightsound Technologies, Inc. of Sua Sponte Decisions of United States Patent and Trademark Office Vacating Previous Final Office Actions (Rinaldo, Richard) (Entered: 06/02/2006)

Copyright © 2010 LexisNexis CourtLink, Inc. All rights reserved.
*** THIS DATA IS FOR INFORMATIONAL PURPOSES ONLY ***

Source: [Command Searching](#) > Utility, Design and Plant PatentsTerms: patno= 5191573 ([Edit Search](#))

586391 (07) 5191573 March 2, 1993

UNITED STATES PATENT AND TRADEMARK OFFICE GRANTED PATENT

5191573

[Access PDF of Official Patent *](#)[Order Patent File History / Wrapper from REEDFAX@](#)[Link to Claims Section](#)

March 2, 1993

Method for transmitting a desired digital video or audio signal

REEXAM-LITIGATE:

Reexamination requested January 31, 2005 by Napster, Inc., Los Angeles, CA; c/o Albert S. Penilla, Martine, Penilla & Gencarella, LLP, Sunnyvale, CA, Reexamination No. 90/007,402 (O.G. March 29, 2005) Ex. Gp.: 2655 January 31, 2005

Reexamination requested January 31, 2005 by Napster, Inc., Los Angeles, CA; c/o Albert S. Penilla, Martine, Penilla & Gencarella, LLP, Sunnyvale, CA, Reexamination No. 90/007,402 (O.G. March 29, 2005) Ex. Gp.: 2655 January 31, 2005

INVENTOR: Hair, Arthur R. - 301 Oaklawn Dr., Pittsburgh, United States of America (US)**CERT-CORRECTION:**

December 21, 1993 - a Certificate of Correction was issued for this Patent

APPL-NO: 586391 (07)**FILED-DATE:** September 18, 1990**GRANTED-DATE:** March 2, 1993**PRIORITY:** June 13, 1988 - 07206497, United States of America (US)**ASSIGNEE-AT-ISSUE:**

HAIR; ARTHUR R., United States of America (US)

ASSIGNEE-AFTER-ISSUE:

October 2, 1995 - ASSIGNMENT OF ASSIGNORS INTEREST (SEE DOCUMENT FOR DETAILS)., PARSEC SIGHT/SOUND, INC. 1518 ALLISON DRIVE UPPER ST. CLAIR, PENNSYLVANIA, 15241, Reel and Frame Number: 007656/0701

May 3, 2000 - CHANGE OF NAME (SEE DOCUMENT FOR DETAILS)., SIGHTSOUND.COM INCORPORATED 733 WASHINGTON ROAD, SUITE 400 MT. LEBANON, PENNSYLVANIA, 15228, Reel and Frame Number: 010776/0703

October 24, 2001 - NOTICE OF GRANT OF SECURITY INTEREST, KENYON & KENYON ONE BROADWAY NEW YORK, NEW YORK, 10004, SCHWARTZ, ANSEL M. ONE STERLING PLAZA 201 N. CRAIG STREET, SUITE 304 PITTSBURGH, PENNSYLVANIA, 15213, WATERVIEW PARTNERS, LLP ONE STERLING PLAZA 152 WEST 57TH STREET, 46TH FLOOR NEW YORK, NEW YORK, 10019, D&DF WATERVIEW PARTNERS, L.P. ONE STERLING PLAZA 152 WEST 57TH STREET, 46TH FLOOR NEW YORK, NEW YORK, 10019, Reel and Frame Number: 012506/0415

December 27, 2005 - ASSIGNMENT OF ASSIGNORS INTEREST (SEE DOCUMENT FOR DETAILS)., DMT LICENSING, LLC ONE INDEPENDENCE WAY PRINCETON NEW JERSEY 08540, ONE INDEPENDENCE WAY, PRINCETON, NEW JERSEY, UNITED STATES OF AMERICA (US), 08540, Reel and Frame Number: 017555/0149

LEGAL-REP: Schwartz, Ansel M.**PUB-TYPE:** March 2, 1993 - Patent (A)**PUB-COUNTRY:** United States of America (US)**LEGAL-STATUS:**

December 21, 1993 - CERTIFICATE OF CORRECTION October 2, 1995 - ASSIGNMENT OF ASSIGNOR'S INTEREST October 2, 1995 - ASSIGNMENT OF ASSIGNOR'S INTEREST October 2, 1995 - ASSIGNMENT May 3, 2000 - ASSIGNMENT May 3, 2000 - ASSIGNMENT October 24, 2001 - ASSIGNMENT October 24, 2001 - ASSIGNMENT October 24, 2001 - ASSIGNMENT October 24, 2001 - ASSIGNMENT October 24, 2001 - ASSIGNMENT October 24, 2001 - ASSIGNMENT October 24, 2001 - ASSIGNMENT October 24, 2001 - ASSIGNMENT March 29, 2005 - REQUEST FOR REEXAMINATION FILED December 27, 2005 - ASSIGNMENT

FILING-LANG: English (EN) (ENG)

PUB-LANG: English (EN) (ENG)

REL-DATA:

Continuation of Ser. No. 206497, June 13, 1988, ABANDONED, September 18, 1990

US-MAIN-CL: 369#84

US-ADDL-CL: 235#380, 235#381, 348#E07.071, 369#15, 369#85, G9B#20.002, G9B#27.002, G9B#27.012, G9B#27.019, G9B#27.051

CL: 369, 235, 348, G9B

SEARCH-FLD: 235#375, 235#380, 235#381, 364#410, 364#479, 369#13, 369#15, 369#33, 369#34, 369#84, 369#85

IPC-MAIN-CL: [7] G11B 005#86

IPC-MAIN-CL: [8] G07F 017#00 (20060101) Core Inventive 20051008 (C I R M EP)

IPC-ADDL-CL: [7] G11B 007#00

IPC-ADDL-CL: [7] G11B 011#00

IPC-ADDL-CL: [8] G07F 017#16 (20060101) Advanced Inventive 20051008 (A I R M EP)

IPC-ADDL-CL: [8] G11B 020#00 (20060101) Core Inventive 20051008 (C I R M EP)

IPC-ADDL-CL: [8] G11B 020#00 (20060101) Advanced Inventive 20051008 (A I R M EP)

IPC-ADDL-CL: [8] G11B 027#00 (20060101) Core Inventive 20051008 (C I R M EP)

IPC-ADDL-CL: [8] G11B 027#00 (20060101) Advanced Inventive 20051008 (A I R M EP)

IPC-ADDL-CL: [8] G11B 027#31 (20060101) Core Inventive 20051008 (C I R M EP)

IPC-ADDL-CL: [8] G11B 027#34 (20060101) Advanced Inventive 20051008 (A I R M EP)

IPC-ADDL-CL: [8] G11B 027#10 (20060101) Core Inventive 20051008 (C I R M EP)

IPC-ADDL-CL: [8] G11B 027#10 (20060101) Advanced Inventive 20051008 (A I R M EP)

IPC-ADDL-CL: [8] G11B 027#34 (20060101) Core Inventive 20051008 (C I R M EP)

IPC-ADDL-CL: [8] G11B 027#34 (20060101) Advanced Inventive 20051008 (A I R M EP)

IPC-ADDL-CL: [8] H04H 001#02 (20060101) Core Inventive 20051008 (C I R M EP)

IPC-ADDL-CL: [8] H04H 001#02 (20060101) Advanced Inventive 20051008 (A I R M EP)

IPC-ADDL-CL: [8] H04N 007#173 (20060101) Core Inventive 20051008 (C I R M EP)

IPC-ADDL-CL: [8] H04N 007#173 (20060101) Advanced Inventive 20051008 (A I R M EP)

PRIM-EXMR: Nguyen; Hoa

REF-CITED:

3718906, February 27, 1973, Lightner, United States of America (US), 235#381
3990710, November 9, 1976, Hughes, United States of America (US), 369#34
4567359, January 28, 1986, Lockwood, United States of America (US), 235#381
4647989, March 3, 1987, Geddes, United States of America (US), 235#381
4654799, March 31, 1987, Ogaki et al., United States of America (US), 364#479

CORE TERMS: digital, music, audio, user, memory, song, electronically, hard disk, stored, hardware, video, electronic, playback, methodology, integrated, compact, display, random, disc, telecommunications, transmitting, additionally, tape, telephone lines, receiver, stereo, randomly, album, audio signal, random access memory

ENGLISH-ABST:

The present invention is a method for transmitting a desired digital video or audio signal stored on a first memory of a first party to a second memory of a second party. The method comprises the steps of transferring money via a telecommunications line to the first party from the second party. Additionally, the method comprises the step of then connecting electronically via a telecommunications line the first memory with the second memory such that the desired signal can pass therebetween. Next,

there is the step of transmitting the desired digital signal from the first memory with a transmitter in control and in possession of the first party to a receiver having the second memory at a location determined by the second party. The receiver is in possession and in control of the second party. There is also the step of then storing the digital signal in the second memory.

NO-OF-CLAIMS: 6

NO-OF-FIGURES: 2

PARENT-PAT-INFO:

This is a continuation of copending application Ser. No. 07/206,497 filed on Jun. 13, 1988, now abandoned.

SUMMARY:

FIELD OF THE INVENTION

The present invention is related to a method for the electronic sales and distribution of digital audio or video signals, and more particularly, to a method which a user may purchase and receive digital audio or video signal from any location which the user has access to a telecommunications line.

BACKGROUND OF THE INVENTION

The three basic mediums (hardware units) of music: records, tapes, and compact discs, greatly restricts the transferability of music and results in a variety of inefficiencies. **CAPACITY:** The individual hardware units as cited above are limited as to the amount of music that can be stored on each. **MATERIALS:** The materials used to manufacture the hardware units are subject to damage and deterioration during normal operations, handling, and exposure to the elements. **SIZE:** The physical size of the hardware units imposes constraints on the quantity of hardware units which can be housed for playback in confined areas such as in automobiles, boats, planes, etc. **RETRIEVAL:** Hardware units limit the ability to play, in a sequence selected by the user, songs from different albums. For example, if the user wants to play one song from ten different albums, the user would spend an inordinate amount of time handling, sorting, and cueing the ten different hardware units. **SALES AND DISTRIBUTION:** Prior to final purchase, hardware units need to be physically transferred from the manufacturing facility to the wholesale warehouse to the retail warehouse to the retail outlet, resulting in lengthy, lag time between music creation and music marketing, as well as incurring unnecessary and inefficient transfer and handling costs. Additionally, tooling costs required for mass production of the hardware units and the material cost of the hardware units themselves, further drives up the cost of music to the end user. **QUALITY:** Until the recent invention of Digital Audio Music, as used on Compact Discs, distortion free transfer from the hardware units to the stereo system was virtually impossible. Digital Audio Music is simply music converted into a very basic computer language known as binary. A series of commands known as zeros or ones encode the music for future playback. Use of laser retrieval of the binary commands results in distortion free transfer of the music from the compact disc to the stereo system. Quality Digital Audio Music is defined as the binary structure of the Digital Audio Music. Conventional analog tape recording of Digital Audio Music is not to be considered quality inasmuch as the binary structure itself is not recorded. While Digital Audio Music on compact discs is a technological breakthrough in audio quality, the method by which the music is sold, distributed, stored, manipulated, retrieved, played and protected from copyright infringements remains as inefficient as with records and tapes. **COPYRIGHT PROTECTION:** Since the invention of tape recording devices, strict control and enforcement of copyright laws have proved difficult and impossible with home recorders. Additionally, the recent invention of Digital Audio Tape Recorders now jeopardizes the electronic copyright protection of quality Digital Audio Music on Compact Discs or Digital Audio Tapes. If music exists on hardware units, it can be copied. Accordingly, it is an objective of this invention is to provide a new and improved methodology/system to electronically sell and distribute Digital Audio Music. A further objective of this invention to provide a new and improved methodology/system to electronically store and retrieve Digital Audio Music. Another objective of this invention is to provide a new and improved methodology/system to electronically manipulate, i.e., sort, cue, and select, Digital Audio Music for playback. Still another objective of this invention is to offer a new and improved methodology/system which can prevent unauthorized electronic copying of quality Digital Audio Music.

SUMMARY OF THE INVENTION

Briefly, this invention accomplishes the above cited objectives by providing a new and improved methodology/system of electronic sales, distribution, storage, manipulation, retrieval, playback, and copyright protection of Digital Audio Music. The high speed transfer of Digital Audio Music as prescribed by this invention is stored onto one piece of hardware, a hard disk, thus eliminating the need to unnecessarily handle records, tapes, or compact discs on a regular basis. This invention recalls stored music for playback as selected/programmed by the user. This invention can easily and electronically sort stored music based on many different criteria such as, but not limited to, music category, artist, album, user's favorite songs, etc. An additional feature of this invention is the random playback of songs, also based on the user's selection. For example, the user could have this invention randomly play all jazz songs stored on the user's hard disk, or randomly play all songs by a certain artist, or randomly play all of the user's favorite songs which the user previously electronically "tagged" as favorites. Further, being more specific, the user can electronically select a series of individual songs from different albums for sequential playback. This invention can be configured to either accept direct input of Digital Audio Music from the digital output of a Compact Disc, such transfer would be performed by the private user, or this invention can be configured to accept Digital Audio Music from a source authorized by the copyright holder to sell and distribute the copyrighted materials, thus guaranteeing the protection of such copyrighted materials. Either method of electronically transferring Digital Audio Music by means of this invention is intended to comply with all copyright laws and restrictions and any such transfer is subject to the appropriate authorization by the copyright holder. Inasmuch as Digital Audio Music is software on this invention electronically transfers and stores such music, electronic sales and distribution of the music can take place via telephone lines onto a hard disk. This new methodology/system of music sales and distribution

will greatly reduce the cost of goods sold and will reduce the lag time between music creation and music marketing from weeks down to hours. The present invention is a method for transmitting a desired digital video or audio signal stored on a first memory of a first party to a second memory of a second party. The method comprises the steps of transferring money via a telecommunications line to the first party from the second party. Additionally, the method comprises the step of then connecting electronically via a telecommunications line the first memory with the second memory such that the desired digital signal can pass therebetween. Next, there is the step of transmitting the desired digital signal from the first memory with a transmitter in control and in possession of the first party to a receiver having the second memory at a location determined by the second party. The receiver is in possession and in control of the second party. There is also the step of then storing the digital signal in the second memory. Further objectives and advantages of this invention will become apparent as the following description proceeds and the particular features of novelty which characterize this invention will be pointed out in the claims annexed to and forming a part of this declaration.

DRWDESC:

BRIEF DESCRIPTION OF THE SEVERAL VIEWS OF DRAWINGS

For a better understanding of this invention, reference should be made to the following detailed description, taken in conjunction with the accompanying drawings, in which: FIG. 1 is a pictorial flow chart which may be used in carrying out the teachings of this invention for the purposes of electronic sales, distribution, storage, manipulation, retrieval, playback, and copyright protection of Digital Audio Music; and FIG. 2 is a pictorial flow chart which may be used in carrying out the teachings of this invention for the purposes of electronic storage, manipulation, retrieval, and playback of Digital Audio Music.

DETDESC:

DESCRIPTION OF THE PREFERRED EMBODIMENT

Referring now to the FIG. 1, this invention is comprised of the following: 10 Hard Disk of the copyright holder 20 Control Unit of the copyright holder 20a Control Panel 20b Control Integrated Circuit 20c Sales Random Access Memory Chip 30 Telephone Lines/Input Transfer 50 Control Unit of the user 50a Control Panel 50b Control Integrated circuit 50c Incoming Random Access Memory Chip 50d Play Back Random Access Memory Chip 60 Hard Disk of the user 70 Video Display Unit 80 Stereo Speakers The Hard Disk 10 of the agent authorized to electronically sell and distribute the copyrighted Digital Audio Music is the originating source of music in the configuration as outlined in FIG. 1. The Control Unit 20 of the authorized agent is the means by which the electronic transfer of the Digital Audio Music from the agent's Hard Disk 10 via the Telephone Lines 30 to the user's Control Unit 50 is possible. The user's Control Unit would be comprised of a Control Panel 50a, a Control Integrated Circuit 50b, an Incoming Random Access Memory Chip 50c, and a Play Back Random Access Memory Chip 50d. Similarly, the authorized agent's Control Unit 20 would have a control panel and control integrated circuit similar to that of the user's Control Unit 50. The authorized agent's Control Unit 20, however, would only require the Sales Random Access Memory Chip 20c. The other components in FIG. 1 include a Hard Disk 60, a Video (display Unit 70, and a set of Stereo Speakers 80. Referring now to FIG. 2, with the exception of a substitution of a Compact Disc Player 40 (as the initial source of Digital Audio Music) for the agent's Hard Disk 10, the agent's Control Unit 20, and the Telephone Lines 30 in FIG. 1, FIG. 2 is the same as FIG. 1. In FIG. 1 and FIG. 2, the following components are already commercially available: the agent's Hard Disk 10, the Telephone Lines 30, the Compact Disc Player 40, the user's Hard Disk 60, the Video Display Unit 70, and the Stereo Speakers 80. The Control Units 20 and 50, however, would be designed specifically to meet the teachings of this invention. The design of the control units would incorporate the following functional features: 1) the Control Panels 20a and 50a would be designed to permit the agent and user to program the respective Control Integrated Circuits 20b and 50b, 2) the Control Integrated Circuits 20b and 50b would be designed to control and execute the respective commands of the agent and user and regulate the electronic transfer of Digital Audio Music throughout the system, additionally, the sales Control Integrated Circuit 20b could electronically code the Digital Audio Music in a configuration which would prevent unauthorized reproductions of the copyrighted material, 3) the Sales Random Access Memory Chip 20c would be designed to temporarily store user purchased Digital Audio Music for subsequent electronic transfer via telephone lines to the user's Control Unit 50, 4) the Incoming Random Access Memory Chip 50c would be designed to temporarily store Digital Audio Music for subsequent electronic storage to the user's Hard Disk 60, 5) the Play Back Random Access Memory Chip 50d would be designed to temporarily store Digital Audio Music for sequential playback. The foregoing description of the Control Units 20 and 50 is intended as an example only and thereby is not restrictive with respect to the exact number of components and/or its actual design. Once the Digital Audio Music has been electronically stored onto the user's Hard Disk 60, having the potential to store literally thousands of songs, the user is free to perform the many functions of this invention. To play a stored song, the user types in the appropriate commands on the Control Panel 50a, and those commands are relayed to the Control Integrated Circuit 50b which retrieves the selected song from the Hard Disk 60. When a song is retrieved from the Hard Disk 60 only a replica of the permanently stored song is retrieved. The permanently stored song remains intact on the Hard Disk 60, thus allowing repeated playback. The Control Integrated Circuit 50b stores the replica onto the Play Back Random Access Memory Chip 50d at a high transfer rate. The Control Integrated Circuit 50b then sends the electronic output to the Stereo Speakers 80 at a controlled rate using the Play Back Random Access Memory Chip 50d as a temporary staging point for the Digital Audio Music. Unique to this invention is that the Control Unit 50 also serves as the user's personal disk jockey. The user may request specific songs to be electronically cued for playback, or may request the Control Unit 50 to randomly select songs based on the user's criteria. All of these commands are electronically stored in random access memory enabling the control unit to remember prior commands while simultaneously performing other tasks requested by the user and, at the same time, continuing to play songs previously cued. Offering a convenient visual display of the user's library of songs is but one more new and improved aspect of this invention. As the Control Unit 50 is executing the user's commands to electronically sort, select, randomly play, etc., the Video Display Screen 70 is continually providing feedback to the user. The Video Display Screen 70 can list/scroll all songs stored on the Hard Disk 60, list/scroll all cued songs, display the current command function selected by the user, etc. Further expanding upon the improvements this invention has to offer, the Video Display Screen 70 can display the lyrics of the song being played, as well as the name of the song, album, artist, recording company, date of recording, duration of song, etc. This is possible if the lyrics and other incidental information are electronically

stored to the Hard Disk 60 with the Digital Audio Music. The present invention is a method for transmitting a desired digital video or audio signal stored on a first memory of a first party to a second memory of a second party. The method comprises the steps of transferring money via a telecommunications line to the first party from the second party. Additionally, the method comprises the step of then connecting electronically via a telecommunications line the first memory with the second memory such that the desired digital signal can pass therebetween. Next, there is the step of transmitting the desired digital signal from the first memory with a transmitter in control and in possession of the first party to a receiver having the second memory at a location determined by the second party. The receiver is in possession and in control of the second party. There is also the step of then storing the digital signal in the second memory. In summary, there has been disclosed a new and improved methodology/system by which Digital Audio Music can be electronically sold, distributed, transferred, and stored. Further, there has been disclosed a new and improved methodology/system by which Digital Audio Music can be electronically manipulated, i.e., sorted, cued, and selected for playback. Further still, there has been disclosed a new and improved methodology/system by which the electronic manipulation of Digital Audio Music can be visually displayed for the convenience of the user. Additionally, there has been disclosed a new and improved methodology/system by which electronic copyright protection of quality Digital Audio Music is possible through use of this invention. Since numerous changes may be made in the above described process and apparatus and different embodiments of the invention may be made without departing from the spirit thereof, it is intended that all matter contained in the foregoing description or shown in the accompanying drawings shall be interpreted as illustrative, and not in a limiting sense. Further, it is intended that this invention is not to be limited to Digital Audio Music and can include Digital Video, Digital Commercials, and other applications of digital information.

ENGLISH-CLAIMS:

[Return to Top of Patent](#)

1. A method for transmitting a desired digital audio signal stored on a first memory of a first party to a second memory of a second party comprising the steps of: transferring money electronically via a telecommunication lien to the first party at a location remote from the second memory and controlling use of the first memory from the second party financially distinct from the first party, said second party controlling use and in possession of the second memory; connecting electronically via a telecommunications line the first memory with the second memory such that the desired digital audio signal can pass therebetween; transmitting the desired digital audio signal from the first memory with a transmitter in control and possession of the first party to a receiver having the second memory at a location determined by the second party, said receiver in possession and control of the second party; and storing the digital signal in the second memory.

2. A method as described in claim 1 including after the transferring step, the steps of searching the first memory for the desired digital audio signal; and selecting the desired digital audio signal from the first memory.

3. A method as described in claim 2 wherein the transferring step includes the steps of telephoning the first party controlling use of the first memory by the second party; providing a credit card number of the second party controlling the second memory to the first party controlling the first memory so the second party is charged money.

4. A method for transmitting a desired digital video signal stored on a first memory of a first party to a second memory of a second party comprising the steps of: transferring money electronically via a telecommunications line to the first party at a location remote from the second memory and controlling use of the first memory, from a second party financially distinct from the first party, said second party in control and in possession of the second memory; connecting electronically via a telecommunications line the first memory with the second memory such that the desired digital video signal can pass therebetween; transmitting the desired digital video signal from the first memory with a transmitter in control and possession of the first party to a receiver having the second memory at a location determined by the second party, said receiver in possession and control of the second party; and storing the digital signal in the second memory.

5. A method as described in claim 4 including after the transferring money step, the step of searching the first memory for the desired digital signal and selecting the desired digital signal from the first memory.

6. A method as described in claim 5 wherein the transferring step includes the steps of telephoning the first party controlling use of the first memory by the second party controlling the second memory; providing a credit card number of the second party controlling the second memory to the first party controlling the first memory so the second party controlling the second memory is charged money.

LOAD-DATE: November 17, 2009

Source: [Command Searching > Utility, Design and Plant Patents](#) 

Terms: [patno= 5191573](#) ([Edit Search](#))

View: Full

Date/Time: Thursday, August 12, 2010 - 8:58 AM EDT

[My Lexis™](#) | [Search](#) | [Research Tasks](#) | [Get a Document](#) | [Shepard's®](#) | [Alerts](#) | [Total Litigator](#) | [Transactional Advisor](#) | [Counsel Selector](#)
[History](#) | [Delivery Manager](#) | [Switch Client](#) | [Preferences](#) | [Sign Out](#) | [Help](#)



LexisNexis®

[About LexisNexis](#) | [Terms & Conditions](#) | [Contact Us](#)

Copyright © 2010 LexisNexis, a division of Reed Elsevier Inc. All rights reserved.

FOCUS™ Terms

Search Within Original Results (1 - 2)

Go → Advanced...

Source: [Command Searching](#) > Patent Cases from Federal Courts and Administrative MaterialsTerms: 5191573 or 5,191,573 ([Edit Search](#))

Select for FOCUS™ or Delivery

- A** 1. [Sightsound.com Inc. v. N2k, Inc.](#), Civil Action No. 98-118 , UNITED STATES DISTRICT COURT FOR THE WESTERN DISTRICT OF PENNSYLVANIA, 185 F. Supp. 2d 445; 2002 U.S. Dist. LEXIS 6828, February 8, 2002, Decided

OVERVIEW: In an action involving patents which were directed to commercially-acceptable systems and methods for selling music and video in digital form over telecommunications lines, the judge made several recommendations regarding claim construction.

CORE TERMS: digital, memory, telecommunication, electronically, patent, audio signals, signal, specification, desired, transferring ...

... multiple claims of U. S. Patent Nos. **5,191,573** ("the '573 Patent"), 5,675,734 ("the '734 Patent"), ...

- ◆** 2. [Sightsound.com, Inc. v. N2K, Inc.](#), Civil Action No. 98-0118 , UNITED STATES DISTRICT COURT FOR THE WESTERN DISTRICT OF PENNSYLVANIA, 391 F. Supp. 2d 321; 2003 U.S. Dist. LEXIS 25503, October 23, 2003, Decided

OVERVIEW: Defendant was denied summary judgment on claims of patent invalidity; earlier patent described only "possibility" of use of unit in way that anticipated use of patent-in-suit, not the required "necessity," and fact question existed as to obviousness.

CORE TERMS: patent, digital, sightsound, invention, music, summary judgment, signal, prior art, license, consumer ...







... Office ("PTO") issued United States Patent No. **5,191,573** ("the '573 Patent") to Mr. Hair who ...

Source: [Command Searching](#) > Patent Cases from Federal Courts and Administrative MaterialsTerms: 5191573 or 5,191,573 ([Edit Search](#))

View: Cite

Date/Time: Thursday, August 12, 2010 - 8:59 AM EDT

* Signal Legend:

-  - Warning: Negative treatment is indicated
-  - Questioned: Validity questioned by citing refs
-  - Caution: Possible negative treatment
-  - Positive treatment is indicated
-  - Citing Refs. With Analysis Available
-  - Citation information available

* Click on any *Shepard's* signal to *Shepardize* that case.

No Documents Found

No documents were found for your search terms

"5191573 or 5,191,573"

Click "Edit Search" to return to the search form and modify your search.

Suggestions:

- Check for spelling errors .
 - Remove some search terms.
 - Use more common search terms, such as those listed in "Suggested Words and Concepts"
 - Use a less restrictive date range.
-

[Edit Search](#)



[About LexisNexis](#) | [Terms & Conditions](#) | [Contact Us](#)
[Copyright ©](#) 2010 LexisNexis, a division of Reed Elsevier Inc. All rights reserved.

FOCUS™ Terms

Search Within Original Results (1 - 16)



Advanced...

Source: [Command Searching](#) > News, All (English, Full Text) Terms: 5191573 or 5,191,573 ([Edit Search](#)) Select for FOCUS™ or Delivery

1. [Canadian Press Newswire](#), September 4, 2001, Pg. S 4'01, 5191573, 77 words, Trio of alleged drug-smugglers from Montreal elect trial by judge alone
2. [Canadian Press Newswire](#), September 4, 2001, Pg. S 4'01, 5191573, 77 words, Trio of alleged drug-smugglers from Montreal elect trial by judge alone(Record in progress)
3. [The Toronto Sun](#), May 19, 2000, Friday,, Final EDITION, NEWS,, Pg. 32, 174 words, KILLER INSULTS VICTIM'S KIN, ALAN CAIRNS, TORONTO SUN, BARRIE
4. [Salon.com](#), March 9, 1999 Tuesday, Feature, 2469 words, How can they patent that?, By Peter Wayner ... card account numbers from prying eyes. Or consider patents **5191573** and 5675734, created by Arthur Hair when he lived in ...
... Milne, an engineer for N2K, is evaluating what patents **5191573** and 5675734 mean to his company's plans for selling music ...
5. [Business Wire](#), May 19, 1998, Tuesday, 867 words, Digital Sight/Sound Rolls Out First Patented Method for Sale of Digital Audio/Video Over the Internet, LOS ANGELES
- CORE TERMS:** A2B, Sight, Internet, recordings, download, audio, protection, Sander, Scott, Hair, licensee, patent
... enjoy patent protection under United States Patents **5,191,573** and 5,675,734. "A2B is a superb platform for the download ...
6. [Business Wire](#), May 18, 1998, Monday, 867 words, Digital Sight/Sound Rolls Out First Patented Method for Sale of Digital Audio/Video Over the Internet, LOS ANGELES
- CORE TERMS:** A2B, Sight, Internet, recordings, download, audio, protection, Sander, Scott, Hair, licensee, patent
... enjoy patent protection under United States Patents **5,191,573** and 5,675,734. "A2B is a superb platform for the download ...
7. [Business Wire](#), May 19, 1998, B0IE0BHBYTWR, 839 words, DIGITAL SIGHT/SOUND ROLLS OUT FIRST PATENTED METHOD FOR SALE OF DIGITAL AUDIO/VIDEO OVER THE INTERNET
- CORE TERMS:** Hair, A2B, sight, Internet, audio, recording, download, Sander, Scott, Web, programming, protection, engineer, patent, Microshows, Arthur, EJs, sightsound, digitally, focused, licensee, recorded, fashion, concept, medium, www, com
... enjoy patent protection under United States Patents **5,191,573** and 5,675,734. "A2B is a superb platform for the download ...
8. [Business Wire](#), May 19, 1998, B0IETBZAM6WR, 844 words, DIGITAL SIGHT/SOUND ROLLS OUT FIRST PATENTED METHOD FOR SALE OF DIGITAL
- CORE TERMS:** Hair, A2B, sight, Internet, audio, recording, download, Sander, Scott, Web, programming, protection, engineer, patent, Microshows, Arthur, EJs, sightsound, digitally, focused, licensee, recorded, fashion, concept, medium, www, com
... enjoy patent protection under United States Patents **5,191,573** and 5,675,734. "A2B is a superb platform for the download ...
9. [Business Wire](#), May 18, 1998, B0IE0BHABEWR, 839 words, DIGITAL SIGHT/SOUND ROLLS OUT FIRST PATENTED METHOD FOR SALE OF DIGITAL AUDIO/VIDEO OVER THE INTERNET
- CORE TERMS:** Hair, A2B, sight, Internet, audio, recording, download, Sander, Scott, Web, programming, protection, engineer, patent, Microshows, Arthur, EJs, sightsound, digitally, focused, licensee, recorded, fashion, concept, medium, www, com
... enjoy patent protection under United States Patents **5,191,573** and 5,675,734. "A2B is a superb platform for the download ...
10. [Business Wire](#), May 18, 1998, B0IESBSA2JWR, 844 words, DIGITAL SIGHT/SOUND ROLLS OUT FIRST PATENTED METHOD FOR SALE OF DIGITAL
- CORE TERMS:** Hair, A2B, sight, Internet, audio, recording, download, Sander, Scott, Web, programming, protection, engineer, patent, Microshows, Arthur, EJs, sightsound, digitally, focused, licensee, recorded, fashion, concept, medium, www, com

... enjoy patent protection under United States Patents **5,191,573** and 5,675,734. "A2B is a superb platform for the download ...

Source: [Command Searching > News, All \(English, Full Text\)](#) 

Terms: **5191573** or **5,191,573** ([Edit Search](#))

View: [Cite](#)

Date/Time: Thursday, August 12, 2010 - 9:00 AM EDT

[My Lexis™](#) | [Search](#) | [Research Tasks](#) | [Get a Document](#) | [Shepard's®](#) | [Alerts](#) | [Total Litigator](#) | [Transactional Advisor](#) | [Counsel Selector](#)
[History](#) | [Delivery Manager](#) | [Switch Client](#) | [Preferences](#) | [Sign Out](#) | [Help](#)



[About LexisNexis](#) | [Terms & Conditions](#) | [Contact Us](#)
Copyright © 2010 LexisNexis, a division of Reed Elsevier Inc. All rights reserved.

Patent Assignment Abstract of Title

Total Assignments: 4

Application #: 07586391

Filing Dt: 09/18/1990

Patent #: 5191573

Issue Dt: 03/02/1993

PCT #: NONE

Publication #: NONE

Pub Dt:

Inventor: ARTHUR R. HAIR

Title: METHOD FOR TRANSMITTING A DESIRED DIGITAL VIDEO OR AUDIO SIGNAL

Assignment: 1

Reel/Frame: 007656 / 0701

Received: 10/20/1995

Recorded: 10/02/1995

Mailed: 02/21/1996

Pages: 4

Conveyance: ASSIGNMENT OF ASSIGNORS INTEREST (SEE DOCUMENT FOR DETAILS).

Assignor: HAIR, ARTHUR R.

Exec Dt: 09/20/1995

Assignee: PARSEC SIGHT/SOUND, INC.

1518 ALLISON DRIVE
UPPER ST. CLAIR, PENNSYLVANIA 15241

Correspondent: ANSEL M. SCHWARTZ
425 N. CRAIG STREET
PITTSBURGH, PA 15123

Assignment: 2

Reel/Frame: 010776 / 0703

Received: 05/16/2000

Recorded: 05/03/2000

Mailed: 07/14/2000

Pages: 16

Conveyance: CHANGE OF NAME (SEE DOCUMENT FOR DETAILS).

Assignor: PARSEC SIGHT/SOUND, INC.

Exec Dt: 04/26/2000

Assignee: SIGHTSOUND.COM INCORPORATED

733 WASHINGTON ROAD, SUITE 400
MT. LEBANON, PENNSYLVANIA 15228

Correspondent: ANSEL M. SCHWARTZ
ONE STERLING PLAZA
201 N. CRAIG STREET, SUITE 304
PITTSBURGH, PA 15213

Assignment: 3

Reel/Frame: 012506 / 0415

Received: 01/30/2002

Recorded: 10/24/2001

Mailed: 04/25/2002

Pages: 6

Conveyance: NOTICE OF GRANT OF SECURITY INTEREST

Assignor: SIGHTSOUND TECHNOLOGIES, INC.

Exec Dt: 10/01/2001

Assignees: KENYON & KENYON

ONE BROADWAY
NEW YORK, NEW YORK 10004
SCHWARTZ, ANSEL M.
ONE STERLING PLAZA
201 N. CRAIG STREET, SUITE 304
PITTSBURGH, PENNSYLVANIA 15213

WATERVIEW PARTNERS, LLP
ONE STERLING PLAZA
152 WEST 57TH STREET, 46TH FLOOR
NEW YORK, NEW YORK 10019
D&DF WATERVIEW PARTNERS, L.P.
ONE STERLING PLAZA
152 WEST 57TH STREET, 46TH FLOOR
NEW YORK, NEW YORK 10019

Correspondent: PAUL, WEISS, RIFKIND, WHARTON & GARRISON
DEBORAH HARTNETT
1285 AVENUE OF THE AMERICAS
NEW YORK, NY 10019

Assignment: 4

Reel/Frame: 017555 / 0149

Received: 12/30/2005

Recorded: 12/27/2005

Mailed: 05/01/2006

Pages: 6

Conveyance: ASSIGNMENT OF ASSIGNORS INTEREST (SEE DOCUMENT FOR DETAILS).

Assignor: SIGHTSOUND TECHNOLOGIES, INC.

Exec Dt: 11/10/2005

Assignee: DMT LICENSING, LLC

ONE INDEPENDENCE WAY
PRINCETON, NEW JERSEY 08540

Correspondent: MATTHEW P. MCWILLIAMS

DRINKER BIDDLE & REATH LLP
ONE LOGAN SQUARE
18TH AND CHERRY STREETS
PHILADELPHIA, PA 19103-6996

Search Results as of: 08/13/2010 04:07 PM

If you have any comments or questions concerning the data displayed, contact PRD / Assignments at 571-272-3350.
Web interface last modified: October 18, 2008 v.2.0.1



UNITED STATES PATENT AND TRADEMARK OFFICE

UNITED STATES DEPARTMENT OF COMMERCE
 United States Patent and Trademark Office
 Address: COMMISSIONER FOR PATENTS
 P.O. Box 1450
 Alexandria, Virginia 22313-1450
 www.uspto.gov



Bib Data Sheet

CONFIRMATION NO. 2998

SERIAL NUMBER 90/007,402	FILING OR 371(c) DATE 01/31/2005 RULE	CLASS 369	GROUP ART UNIT 2655	ATTORNEY DOCKET NO. NAPS001	
APPLICANTS 5191573, Residence Not Provided; SightSound.com Incorporated (Owner), Mt. Lebanon, PA, DMT Licensing, LLC (Owner), Napster, Inc. (3rd Pty. Req.), Los Angeles, CA; Princeton, NJ Albert S. Penilla, Sunnyvale, CA					
** CONTINUING DATA ***** This application is a REX of 07/586,391 09/18/1990 PAT 5,191,573 <i>BC</i> which is a CON of 07/208,497 08/13/1988 ABN					
** FOREIGN APPLICATIONS ***** NONE <i>BC</i>					
Foreign Priority claimed <input type="checkbox"/> yes <input checked="" type="checkbox"/> no		STATE OR COUNTRY	SHEETS DRAWING	TOTAL CLAIMS 6	INDEPENDENT CLAIMS 2
35 USC 119 (a-d) conditions met <input type="checkbox"/> yes <input checked="" type="checkbox"/> no <input type="checkbox"/> Met after					
Verified and Acknowledged		Examiner's Signature <i>Allowance</i>	Initials <i>BC</i>		
ADDRESS Ansel M. Schwartz 425 N. Craig Street Suite 301 Pittsburgh, PA 15213					
TITLE METHOD FOR TRANSMITTING A DESIRED DIGITAL VIDEO OR AUDIO SIGNAL					
FILING FEE RECEIVED 2520	FEES: Authority has been given in Paper No. _____ to charge/credit DEPOSIT ACCOUNT No. _____ for following:		<input type="checkbox"/> All Fees <input type="checkbox"/> 1.16 Fees (Filing) <input type="checkbox"/> 1.17 Fees (Processing Ext. of time) <input type="checkbox"/> 1.18 Fees (Issue) <input type="checkbox"/> Other _____ <input type="checkbox"/> Credit		

Reexamination 	Application/Control No. 90007402	Applicant(s)/Patent Under Reexamination 5191573
	Certificate Date	Certificate Number <i>02 C1</i>

Requester Correspondence Address:	<input type="checkbox"/> Patent Owner	<input checked="" type="checkbox"/> Third Party
Albert S. Penilla Martine Penilla & Gencarella, LLP 710 Lakeway Drive, Suite 200 Sunnyvale, CA 94085		

LITIGATION REVIEW <input checked="" type="checkbox"/>	r.g.f. (examiner initials)	08/11/2010 (date)
Case Name		Director Initials
2:04cv1549, closed.		<i>Ein Heard for GM</i>

COPENDING OFFICE PROCEEDINGS	
TYPE OF PROCEEDING	NUMBER
1. None.	

--	--



UNITED STATES PATENT AND TRADEMARK OFFICE

UNITED STATES DEPARTMENT OF COMMERCE
United States Patent and Trademark Office
Address: COMMISSIONER FOR PATENTS
P.O. Box 1450
Alexandria, Virginia 22313-1450
www.uspto.gov

APPLICATION NO.	FILING DATE	FIRST NAMED INVENTOR	ATTORNEY DOCKET NO.	CONFIRMATION NO.
90/007,402	01/31/2005	5191573	NAPS001	2998

42624 7590 08/16/2010

DAVIDSON BERQUIST JACKSON & GOWDEY LLP
4300 WILSON BLVD., 7TH FLOOR
ARLINGTON, VA 22203

EXAMINER

ART UNIT PAPER NUMBER

DATE MAILED: 08/16/2010

Please find below and/or attached an Office communication concerning this application or proceeding.



UNITED STATES PATENT AND TRADEMARK OFFICE

Commissioner for Patents
United States Patent and Trademark Office
P. O. Box 1450
Alexandria, VA 22313-1450
www.uspto.gov

DO NOT USE IN PALM PRINTER

(THIRD PARTY REQUESTER'S CORRESPONDENCE ADDRESS)

Albert S. Penilla
Martine Penilla & Gencarella, LLP
710 Lakeway Drive, Suite 200
Sunnyvale, CA 94085

MAILED

AUG 16 2000

CENTRAL REEXAMINATION UNIT

EX PARTE REEXAMINATION COMMUNICATION TRANSMITTAL FORM

REEXAMINATION CONTROL NO. 90/007,402.

PATENT NO. 5191573.

ART UNIT 3992.

Enclosed is a copy of the latest communication from the United States Patent and Trademark Office in the above identified *ex parte* reexamination proceeding (37 CFR 1.550(f)).

Where this copy is supplied after the reply by requester, 37 CFR 1.535, or the time for filing a reply has passed, no submission on behalf of the *ex parte* reexamination requester will be acknowledged or considered (37 CFR 1.550(g)).

**Notice of Intent to Issue
Ex Parte Reexamination Certificate**

Control No. 90/007,402	Patent Under Reexamination 5191573	
Examiner ROLAND G. FOSTER	Art Unit 3992	

-- The MAILING DATE of this communication appears on the cover sheet with the correspondence address --

1. Prosecution on the merits is (or remains) closed in this *ex parte* reexamination proceeding. This proceeding is subject to reopening at the initiative of the Office or upon petition. Cf. 37 CFR 1.313(a). A Certificate will be issued in view of

- (a) Patent owner's communication(s) filed: 25 May 2010.
- (b) Patent owner's late response filed: _____.
- (c) Patent owner's failure to file an appropriate response to the Office action mailed: _____.
- (d) Patent owner's failure to timely file an Appeal Brief (37 CFR 41.31).
- (e) Other: _____.

Status of *Ex Parte* Reexamination:

- (f) Change in the Specification: Yes No
- (g) Change in the Drawing(s): Yes No
- (h) Status of the Claim(s):

- (1) Patent claim(s) confirmed: 1-6.
- (2) Patent claim(s) amended (including dependent on amended claim(s)): _____
- (3) Patent claim(s) cancelled: _____.
- (4) Newly presented claim(s) patentable: _____.
- (5) Newly presented cancelled claims: _____.
- (6) Patent claim(s) previously currently disclaimed: _____
- (7) Patent claim(s) not subject to reexamination: _____.

2. Note the attached statement of reasons for patentability and/or confirmation. Any comments considered necessary by patent owner regarding reasons for patentability and/or confirmation must be submitted promptly to avoid processing delays. Such submission(s) should be labeled: "Comments On Statement of Reasons for Patentability and/or Confirmation."

3. Note attached NOTICE OF REFERENCES CITED (PTO-892).

4. Note attached LIST OF REFERENCES CITED (PTO/SB/08 or PTO/SB/08 substitute.).

5. The drawing correction request filed on _____ is: approved disapproved.

6. Acknowledgment is made of the priority claim under 35 U.S.C. § 119(a)-(d) or (f).

- a) All b) Some* c) None of the certified copies have
 - been received.
 - not been received.
 - been filed in Application No. _____.
 - been filed in reexamination Control No. _____.
 - been received by the International Bureau in PCT Application No. _____.

* Certified copies not received: _____.

7. Note attached Examiner's Amendment.

8. Note attached Interview Summary (PTO-474).

9. Other: _____.

cc: Requester (if third party requester)

U.S. Patent and Trademark Office
PTOL-469 (Rev.6-06)

Notice of Intent to Issue Ex Parte Reexamination Certificate

Part of Paper No 20100809

NOTICE OF INTENT TO ISSUE EX PARTE REEXAMINATION CERTIFICATE

Summary

Claims 1-6 of U.S. Patent No. 5,191,573 (the "Hair" patent) are currently under reexamination in this proceeding.

Patentable Claims

Claims 1-6 are confirmed.

Reasons for Patentability

Double Patenting Rejection Withdrawn

As an initial matter, the patent owner arguments regarding the double patenting rejection are persuasive. Specifically, there is no improper extension of a right to exclude due to a transition of patent terms from 17 years from issue to 20 years from the earliest filing date. See p. 5 of the response, filed on May 25, 2010 (the "Response"). Thus, the double patenting rejection is withdrawn.

Claim Interpretation During Reexamination of an Expired Patent

As discussed in the last Office action mailed March 25, 2010, the Hair patent under reexamination expired and thus the claims are interpreted according to their ordinary and customary meaning. MPEP § 2111.01.III and 2258.I.G. In a reexamination proceeding in which the PTO is considering the patentability of claims of an expired patent which are not subject to amendment, a policy of liberal claim construction should be applied.

Art Unit: 3992

Ex parte Papst-Motoren, 1 USPQ2d 1655, 1656 (BPAI 1986). Even so, the plain language of the claim is the primary determinant of patentability.

In the present Office action, the claims are given their ordinary and customary meaning. The meaning of each claim term in the office actions is the meaning that the term would have to a person of ordinary skill in the art in question at the time of the invention. The ordinary and customary meaning given to the claim terms in the office action are evidenced by the claims themselves and the remainder of the specification.

The patent owner argues with respect to the step of "storing the digital signal in the second memory" (independent claims 1 and 4) that "cassette tapes and CDs [as taught by the prior art] are not 'second memories' according to the claims and specification." Particularly, the patent owner refers to the background section and summary of the invention to support this argument. Response, p. 3. The "Summary of the Invention describes the invention as 'eliminating the need to unnecessarily handle records, tapes, or compact discs on a regular basis.'" *Id.* The patent owner then relates the specification to the scope of the claims by stating "attempting to read the claimed second memories on exactly the type of media that the specification describes as deficient is a misinterpretation of the scope of the claims. See *SciMed Life Systems, Inc. v. Advanced Cardiovascular Systems, Inc.* 242 F.3d 1337 (Fed. Cir. 2001)."

In addition, throughout the prosecution of this reexamination proceeding, the patent owner has repeatedly argued that the second memories are not cassette tapes and CD(s). Indeed,

Art Unit: 3992

before the patent expired and all amendments made during the reexamination proceeding were withdrawn (in accordance with the Office action mailed March 20, 2010), the patent owner amended the claims to explicitly recite that the second memory is not a cassette tape or CD. See, e.g., the amendment to independent claims 1 and 4, filed on November 29, 2006.

The Claimed Invention Distinguishes Over the Bush, Gallagher, Freeny, Akashi Prior Art

In view of patent expiration, the specification, and the repeated patent owner statements and actions discussed above, the examiner interprets the ordinary and customary meaning of "second memories" as not including cassette tapes, CDs and the like. The prior art "base references" applied in the last Office action mailed March 25, 2010, namely Akashi, Bush and Gallagher, relied upon a second memory in the form of a tape and/or CD. Thus, any combination based upon these references fails to teach the claimed invention.

The Claimed Invention Distinguishes Over other Art of Record for the Reasons Set Forth in the Board Decision

Thus, the original claims have essentially the same scope as the amended, original claims did when they were reviewed by the Board of Patent Appeals and Interferences (the "Board") in a decision, mailed September 4, 2009.

In the decision, the Board held most of the prior art relied upon the examiner was not "prior" art. Regarding the issue of priority of those claims features described in Table I (FF 6) under 35 U.S.C. § 120, the Board found the "priority date of the claims was previously considered by the original Examiner and is not a new issue." P. 21. Although the original

Art Unit: 3992

Examiner never objected to the specification under 35 U.S.C. 132, which governs the introduction of new matter into the disclosure, the Board held that this "appears to be a typographical error." *Id.* As for those video download limitations not listed in Table I, the Board noted the examiner's written description analysis that the "original disclosed audio transmission features fail to imply or require any video transmission features." P. 22. To this point, the Board found "more compelling" the Appellant's enablement analysis. *Id.*

One prior art combination relied upon by the examiner, specifically Bush in view of Freeny I, was "prior" art regardless of any 35 U.S.C. § 120 priority issue. The Board however held the Examiner failed to establish a *prima facie* case of obviousness. Specifically, the Board found the suggestion/motivation relied upon by the examiner to add a hard disk (to increase the security and reliability of stored data because hard disks retain data when the power to the unit is removed) was an advantage specific to Cohen (which the Board held not to be prior art) rather than a notoriously well-known advantage of hard disk drives generally. P. 26.

Any comments considered necessary by the Patent Owner regarding the above statement must be submitted promptly to avoid processing delays. Such submission by the Patent Owner should be labeled: "Comments on Statement of Reasons for Patentability and/or Confirmation" and will be placed in the reexamination file.

Conclusion

Extensions of time under 37 CFR 1.136(a) will not be permitted in these proceedings because the provisions of 37 CFR 1.136 apply only to "an applicant" and not to parties in a reexamination proceeding. Additionally, 35 U.S.C. 305 requires that reexamination proceedings "will be conducted with special dispatch" (37 CFR 1.550(a)). Extension of time in *ex parte* reexamination proceedings are provided for in 37 CFR 1.550(c).

The patent owner is reminded of the continuing responsibility under 37 CFR 1.565(a) to apprise the Office of any litigation activity, or other prior or concurrent proceeding, involving the Hair patent throughout the course of this reexamination proceeding. The third party requester is also reminded of the ability to similarly apprise the Office of any such activity or proceeding throughout the course of this reexamination proceeding. See MPEP §§ 2207, 2282 and 2286.

Art Unit: 3992

All correspondence relating to this *ex parte* reexamination proceeding should be directed as follows:

By EFS: Registered users may submit via the electronic filing system EFS-Web, at <https://sportal.uspto.gov/authenticate/authenticateuserlocalepf.html>.

By Mail to: Mail Stop *Ex Parte* Reexam
Central Reexamination Unit
Commissioner for Patents
P.O. Box 1450
Alexandria, VA 22313-1450

By FAX to: (571) 273-9900
Central Reexamination Unit

By hand to: Customer Service Window
Randolph Building
401 Dulany St.
Alexandria, VA 22314

For EFS-Web transmission, 37 CFR 1.8(a)(1)(i) (C) and (ii) states that correspondence (except for a request for reexamination and a corrected or replacement request for reexamination) will be considered timely if (a) it is transmitted via the Office's electronic filing system in accordance with 37 CFR 1.6(a)(4), and (b) includes a certificate of transmission for each piece of correspondence stating the date of transmission, which is prior to the expiration of the set period of time in the Office action.

Any inquiry concerning this communication should be directed to Roland Foster at telephone number 571-272-7538.

Signed:

Conferees:

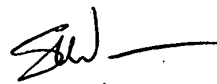
ESK

/Roland G. Foster/
Roland G. Foster
Central Reexamination Unit, Primary Examiner
Electrical Art Unit 3992
(571) 272-7538



US005191573C1

(12) **EX PARTE REEXAMINATION CERTIFICATE** (7888th)
United States Patent
Hair (10) **Number:** **US 5,191,573 C1**
(45) **Certificate Issued:** **Nov. 30, 2010**

(54) **METHOD FOR TRANSMITTING A DESIRED DIGITAL VIDEO OR AUDIO SIGNAL**

(75) **Inventor:** **Arthur R. Hair**, Pittsburgh, PA (US)

(73) **Assignee:** **DMT Licensing, LLC**, Princeton, NJ (US)

Reexamination Request:
No. 90/007,402, Jan. 31, 2005

Reexamination Certificate for:
Patent No.: **5,191,573**
Issued: **Mar. 2, 1993**
Appl. No.: **07/586,391**
Filed: **Sep. 18, 1990**

Certificate of Correction issued Dec. 21, 1993.

Related U.S. Application Data

(63) Continuation of application No. 07/206,497, filed on Jun. 13, 1988, now abandoned.

- (51) **Int. Cl.**
- G11B 27/34* (2006.01)
- G11B 27/031* (2006.01)
- G11B 27/034* (2006.01)
- G11B 27/00* (2006.01)
- G11B 27/10* (2006.01)
- G11B 20/00* (2006.01)
- G07F 17/00* (2006.01)
- G07F 17/16* (2006.01)
- H04N 7/173* (2006.01)

(52) **U.S. Cl.** **369/84**; 235/380; 235/381; 348/E7.071; 369/15; 369/84; 369/85

(58) **Field of Classification Search** None
See application file for complete search history.

(56) **References Cited**

U.S. PATENT DOCUMENTS

- 3,244,809 A 4/1966 Fuller et al.
- 3,602,891 A 8/1971 Clark et al.

- 3,696,297 A 10/1972 Otero
- 3,718,906 A 2/1973 Lightner
- 3,824,597 A 7/1974 Berg
- 3,947,882 A 3/1976 Lightner
- 3,990,710 A 11/1976 Hughes
- 4,028,733 A 6/1977 Ulicki
- 4,045,776 A 8/1977 Wheelwright et al.
- 4,108,365 A 8/1978 Hughes
- 4,124,773 A 11/1978 Elkins
- 4,300,040 A 11/1981 Gould et al.
- 4,335,809 A 6/1982 Wain
- 4,359,223 A 11/1982 Baer et al.
- 4,370,649 A 1/1983 Fuerle

(Continued)

FOREIGN PATENT DOCUMENTS

- GB 2 178 275 A 2/1987
- JP 62-284496 6/1986
- JP 62-284496 12/1987

OTHER PUBLICATIONS

"The History of Recordings", Recording Industry of Association, retrieved from <http://www.riaa.com/issues/audio/hisotry.asp> on Sep. 19, 2006.*

(Continued)

Primary Examiner—Roland G Foster

(57) **ABSTRACT**

The present invention is a method for transmitting a desired digital video or audio signal stored on a first memory of a first party to a second memory of a second party. The method comprises the step of transferring money via a telecommunications line to the first party from the second party. Additionally, the method comprises the step of then connecting electronically via a telecommunications line the first memory with the second memory such that the desired digital signal can pass therebetween. Next, there is the step of transmitting the desired digital signal from the first memory with a transmitter in control and in possession of the first party to a receiver having the second memory at a location determined by the second party. The receiver is in possession and in control of the second party. There is also the step of then storing the digital signal in the second memory.

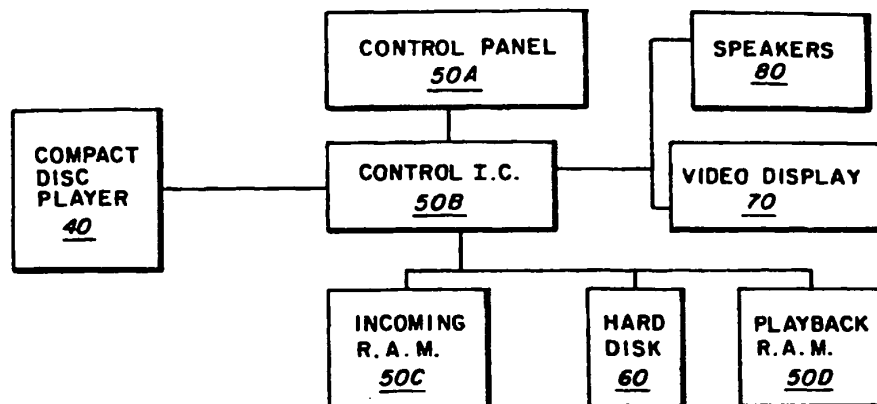

U.S. PATENT DOCUMENTS

4,422,093	A	12/1983	Pargee	
4,472,747	A	9/1984	Schwartz	
4,499,568	A	2/1985	Gremillet	
4,506,387	A	3/1985	Walter	
4,520,404	A	5/1985	Von Kohorn	
4,521,806	A	6/1985	Abraham	
4,521,857	A	6/1985	Reynolds, III	
4,528,643	A	7/1985	Freeny, Jr.	
4,533,948	A	8/1985	McNamara et al.	
4,536,856	A	8/1985	Hiroishi	
4,538,176	A	8/1985	Nakajimo et al.	
4,559,570	A	12/1985	Schwartz	
4,567,359	A	1/1986	Lockwood	
4,567,512	A	1/1986	Abraham	
4,605,973	A	8/1986	Von Kohorn	
4,636,876	A	1/1987	Schwartz	
4,647,989	A	3/1987	Geddes	
4,648,037	A	3/1987	Valentino	
4,654,799	A	3/1987	Ogaki	
4,658,093	A	4/1987	Hellman	
4,667,802	A	5/1987	Verduin et al.	
4,672,613	A	6/1987	Foxworthy et al.	
4,674,055	A	6/1987	Ogaki	
4,675,904	A	6/1987	Silverman	
4,682,248	A	7/1987	Schwartz	
4,688,105	A	8/1987	Bloch et al.	
4,703,465	A	10/1987	Parker	
4,725,977	A	2/1988	Izumi et al.	
4,739,510	A	4/1988	Jeffers et al.	
4,754,483	A	6/1988	Weaver	
4,755,872	A	7/1988	Bestler et al.	
4,755,889	A	7/1988	Schwartz	
4,758,908	A	7/1988	James	
4,759,060	A	7/1988	Hayashi et al.	
4,761,684	A	8/1988	Clark et al.	
4,763,317	A	8/1988	Lehman et al.	
4,766,581	A	8/1988	Korn et al.	
4,787,050	A	11/1988	Suzuki	
4,787,073	A	* 11/1988	Masaki	369/178.01
4,789,863	A	12/1988	Bush	
4,792,849	A	12/1988	McCalley et al.	
4,797,918	A	1/1989	Lee et al.	
4,829,372	A	5/1989	McCalley et al.	
4,855,979	A	* 8/1989	Kimura et al.	369/98
4,870,515	A	* 9/1989	Stokes	360/72.2
4,894,789	A	1/1990	Yee	
4,918,588	A	4/1990	Barrett et al.	
4,949,187	A	8/1990	Cohen	
4,949,257	A	8/1990	Orbach	
4,999,806	A	3/1991	Chemow et al.	
5,003,384	A	3/1991	Durdan et al.	
5,019,900	A	5/1991	Clark et al.	
5,041,921	A	5/1991	Skerker et al.	
5,089,885	A	2/1992	Clark	
5,099,422	A	3/1992	Foresman et al.	
5,130,792	A	7/1992	Tindell et al.	
5,132,992	A	7/1992	Yurt et al.	
5,191,193	A	3/1993	Le Roux	
5,191,410	A	3/1993	McCalley et al.	
5,191,573	A	3/1993	Hair	
5,241,428	A	* 8/1993	Goldwasser et al.	386/109
5,307,456	A	4/1994	MacKay	
5,428,606	A	6/1995	Moskowitz	
RE35,184	E	3/1996	Walker	
5,535,137	A	* 7/1996	Rossmere et al.	358/537
5,675,734	A	10/1997	Hair	
5,966,440	A	10/1999	Hair	

OTHER PUBLICATIONS

"History of CD Technology", citing as a source "The compact Disc Handbook, 2nd Edition," by Ken C. Pohlmann, retrieved from <http://www.oneoffcd.com/info/hisotrycd.com> on Sep.19, 2006.*

"History of MPEG". University of California, Berkeley, School of Information Management and Systems, retrieved from <http://www2.sims.berkeley.edu/courses/is224/s99/GroupG/report1.html> on Sep. 19, 2006.*

"IBM HDD Evolution" chart, by Ed Grochowski at Almaden, retrieved from http://www.soragereview.com/guidelImages/z_ibm_sorageevolution.gif on Sep. 19, 2006.*

Apple Inc., Form 10-Q, Apr. 21, 2010.

Blockbuster Changes Course of In-store Duplication Plans, *Multimedia & Videodisc Monitor*, vol. 12, No. 6, Jun. 1, 1994 (1 page).

Blockbuster Reaffirms Video Retailing Roots, *Video Week*, vol. 14, No. 19, May 17, 1993 (2 pages).

Blockbuster To Test Videogame Downloads In Summer, *Audio Week*, vol. 6, No. 12, Mar. 28, 1994 (2 pages).

IBM, Blockbuster join forces on CD venture; Associated Press, May 12, 1993 (2 pages).

Magistrate's Report and Recommendation (Amending Claim Construction), *Sightsound.com v. NSK et al.*, Civil Action No. 98-118, Apr. 2, 2002.

Magistrate's Report and Recommendation (on Claim Construction), *Sightsound.com v. NSK et al.*, Civil Action No. 98-118, Feb. 8, 2002.

Memorandum Order of Court (adopting amended claim construction recommendation), *Sightsound.com v. NSK et al.*, Civil Action No. 98-118, Nov. 27, 2002.

Music burning kiosks: On the right track; Self Service and Kiosk Association, Apr. 9, 2007 (4 pages).

Sony Music Plans to Test Use of In-Store Digital Kiosks, *New York Times*, Jun. 10, 1999.

Starbucks shuts down its Hear Music kiosks, May 2006 (http://brandautopsy.typepad.com/brandautopsy/2006/05/starbucks_shuts.html).

Turning Over New Leaf, *Consumer Electronics*, Feb. 13, 1995 (1 page).

Jordan, Larry E. and Churchill, Bruce. *Communications and Networking for the IBM PC*. Robert J. Brady Co., Bowie, MD (1983).

W. Rosch, "ComNet for the PC." *PC Magazine*, Aug. 1983, pp. 225-228.

E. Ferrarini, "Direct Connections for Software Selections." *Business Computer Systems*, Feb. 1984, pp. 35+ (4 pages total).

P. Elmer-DeWitt, "Calling up an on-line cornucopia; computer networks are supermarkets of services and information." *Time*, Apr. 7, 1986 (two-page electronic version obtained at <http://www.highbeam.com>).

From the newS desk, D. Needle, *Info World*, May 11, 1984.

Computer system organization: Problems of the 1980's, H. Apfelbaum, et al., *Computer Sep.* 1978, vol. II, No. 9.

System for capturing, storing and playing back large data bases at home, D.C. Gazis S.S. Soo, *IBM Technical Disclosure Bulletin*, vol. 23, No. 2, p. 856, Jul. 1980.

Jimmy Bowen: Music Row's Prophet of change, *L. Chapell, Advantage*, vol. 9, No. 10, p. 38, Oct. 1986.

Rock Around the Database, L. Dotto, *Information Technal.*, vol. 57, No. 9, pp. 128-135, Sep. 1984.

- Home (computer) terminal musical program selection, P.L. Rosenfeld, IBM Technical Disclosure Bulletin, vol. 23, No. 78, p. 3440.
- A Harmonious Musical Interface, S. Cunningham, Network World, Inc., Sep. 8, 1986.
- Electronic Orchestra in your livingroom, S. Mace, InfoWorld, Mar. 25, 1985, p. 29.
- Cable Scan, No Author, Oct. 1983.
- A review of digital audio techniques, M. Willocks, Journal of the Audio Engineering Society, vol. 26, No. 12, pp. 56, 58, 60, 62, 64, Jan.-Feb. 1978.
- Digital Music Will Launch the Home Music Store, G. Gulick, Satellite News, 81-11-09, pp. 7.
- Telecommunications in the coming decades, S.B. Weinstein, IEE Spectrum, Nov. 19??, p. 62.
- Electronic Banking Goes to Market, T.S. Perry, IEE Spectrum, Feb. 19??, p. 46.
- Gordon Bell calls for a U.S. Research Network, G. Gordon Bell, IEEE Spectrum, p. 54.
- As Patents Multiply, Web Sites Find Lawsuits Are a Click Away, S. Hansell, New York Times, Dec. 11, 1999, A1.
- The Tony Basile Home Page, The PAN Network, The PAN Network, Dec. 12, 1999.
- Tele computing—Direct Connections for Software Selections, E. Ferrarini, Business computer systems, Feb. 1984.
- Young Arcadians Come Home, D.N., Info World, vol. 5, No. 27.
- Two way Cable System Using Residential CATV Facilities, Semir Sirazi, et al, ICCE 84, Jun. 7, 1984, LaSalle III—Digest of Technical Papers.
- News, D. Caruso, InfoWorld, Apr. 16, 1984.
- Pay Per View Entertainment System, PTO, US Patent and Trademark Office, Patent Bibliographic Database, Jan. 26, 2000.
- Software Distribution System, PTO, US Patent and Trademark Office, patent Bibliographic Database, Jan. 26, 2000.
- Dig-Music: An On Demand Digital Music Selection System utilizing CATV Facilities, Y. Want G.M. Campbell, IEEE Transactions on Consumer Electronics, vol. CE 28, No. 3, Aug. 1982, p. x vii.
- Transmission of Musical Info. in a teletext multiplexed broadcasting system, Y. Sugimori, et al., IEEE International Conference on Consumer Electronics, 1985—Digest of Technical Papers.
- An Encrypted Digital Audio System for Conventional Cable System, K. Kitagawa, et al., IEEE International Conference on Consumer Electronics, 1985—Digest of Technical Papers.
- Telephone computers—a look at the one per Desk Telecomputer, D. Pountain, Byte U.K., Jun. 1985.
- Music Software for the Apple Macintosh, C. Yavelow, Computer Music Journal, vol. 9, No. 3, Fall 1985.
- NAPLPS Videotex Frame Creation System with Automatic Encoding of Input Images, T. Fujimori, IEEE Transactions on Consumer Electronics, vol. CE-31, No. 3, Aug. 1985.
- Picture Transmission for Videotex, K. Ngan, et al., IEEE Transactions on Consumer Electronics, vol. CE-31, No. 3, Aug. 1985.
- A System for Transmitting Electronic Photographs, N. Kihara, et al., IEEE Transactions on Consumer electronics, vol. CE-28, No. 3, Aug. 1982.
- A Low cost High Performance Picture Display for Photovideotex, G.P. Hudson C.P. Arbuthnot, IEEE Transactions on Consumer Electronics, vol. CE-32, Aug. 1986.
- The Coding of Graphics Animation in a Videotext Terminal, C. Pabousctsidis, 1986 IEEE International Conference on Consumer Electronics, Digest of technical Papers, Jun. 1986.
- Videotext Programs Videorecorder (VPV), U. Bensch, 1984, IEEE International Conference on Consumer Electronics, Digest of technical Papers, Jun. 1984.
- Picture Transmission for Videotex, H. Weng Cheong N. King Ngi, 1988, IEEE International Conference on Consumer Electronics, Digest of technical Papers Jun. 1988.
- Digital Still Picture Recorder Utilizing an Ordinary Audio Cassette Deck, S. Kageyama, et al. 1985 IEEE International Conference on Consumer Electronics, Digest of technical Papers, Jun. 1985.
- Digital Still Picture Recorder Utilizing an Ordinary Audio Cassette Deck, S. Kageyama, et al., 1985 IEEE International Conference on Consumer Electronics, Digest of Technical Papers, Jun. 1985.
- A New digital Audio and Data Transmission System Using the CATV Network, Y. Kojima, et al., IEEE Transactions on Consumer Electronics, vol. CE-30, No. 3, Aug. 1984.
- A Simple Technique for Video Image Transmission, N.D. Jotwani, K.L. Mong, IEEE Transactions on Consumer Electronics, vol. CE-33, No. 1, Feb. 1987.
- Third Party Profile: Control Video Corporation, no author, Control Video Corp. Web Site.
- Dial-A-Game-GameLine module links WCS with Game Bank, D. Burns, Digital Antic, vol. 2, No. 4, Jul. 1983, p. 82.
- Remembering the Gameline, D. Skelton, <http://ccwf.cutexas.edu>.
- Digitalized Voice Comes of Age Part 1—Trade Offs, B. Occhiogrosso, Data Communications, Mar. 1978.
- A New Digital Audio and Data Transmission System Using the CATV Network, Y. Kojima, et al., IEEE Transactions on Consumer Electronics, vol. CE-30, No. 3, Aug. 1984.
- A Packet Video/Audio System Using the Asynchronous Transfer Mode Technique, H.J. Chao, et al., IEEE Transactions on Consumer Electronics, vol. 35, No. 2, May 1989.
- Digital Audio Data Transmission in a Coaxial Cable Environment, R. Scheuerer, et al, IEEE Transactions on Consumer Electronics, vol. 35, No. 2, May 1989?.
- Transmission of Musical info, in a Teletext Multiplexed Broadcasting system, Y. Sugimori, et al, IEEE Transactions on Consumer Electronics, vol. CE-29, No. 3, Aug. 1983.
- 4004 Futures for Teletext and Videotex in the US, R.P. Plummer, et al, IEEE Transactions on Consumer Electronics, vol. CE-25, No. 3, Jul. 1979.
- Teletext/Viewdata LSI, B. Harden, et al., IEEE Transactions on Consumer Electronics, vol. CE-25, No. 3, Jul. 1979.
- Prestel—the World's First Public View data Service, R.D. Bright, et al., IEEE Transactions on Consumer Electronics, vol. CE-25, No. 3, Jul.
- Teletext and Viewdata (costs as Applied to the US Market, G.O. Crowther, IEEE Transactions on Consumer Electronics, vol. CE-25, No. 3, Jul. 1979.
- Telidon—A Review, H. Brown W. Sawchuk, IEEE Communications Magazine, Jan. 1981.
- Videotex Services: Network and Terminal Alternatives, J.M. Costa A.M. Chitnis, IEEE Transactions on Consumer Electronics, vol. CE-25, No. 3, Jul. 1979.
- System and Hardware Considerations of Home Terminals With Telephone Computer Access, J. Blank, IEEE Transactions on Consumer Electronics, vol. CE-25, No. 3, Jul. 1979.

- Profile—Career Update. Key board News. Apr. 1985.
- Telecommunications—Let Your Telephone Do the Sampling. B. Tolinski. KSC. Apr. 1986.
- PAN: Meeting Place for the Industry. P. Leopold, Electronic Musician. Sep. 1986.
- A Harmonious Musical Interface—Instrument Connectivity is Music to Composer's ears. S. Cunningham, Network World. Sep. 8, 1986 (vol. 3, No. 27).
- Teaching Computers to Emulate Bach. J.S. Newton, The New York Times, Sunday, Mar. 1, 1987.
- Getting Into PAN. S. Lloyd, Sonics (nothing else appears).
- MIDI By Modem: The Future in Now. P. Leopold, Conference Paper—Music and Digital Technology.
- The Information Source of the Future is Online now: Electronic Bulletin Boards. G. Armbruster. Keyboard Magazine. Dec. 1985.
- MIDI—Musical Instrument Digital Interface. J. Aikin. Keyboard Magazine. Jan. 1986.
- Mind Over MIDI—Diary of a Mad MIDI Specialist. J. Cooper. Keyboard Magazine. Jun. 1986.
- Cover of the Keyboard Magazine and Advertisement from Hybrid Acts, Inc., Keyboard Magazine. Jul. 1986.
- What is Musical Property?—The Ethics of Sampling. S. Alvaro. Keyboard Magazine. Oct. 1986.
- Collection of MIDI Stereo Advertisements. Electronic Musician, vol. 5, No. 2, Feb. 1989.
- In the Public Eye: Free Atari Software. J. Johnson, Electronic Musician, vol. 5, No. 10, Oct. 1989.
- Going Online—A Guide to elec. Bulletin board System. M. Rivers, Electronic Musician, vol. 6, No. 11, Nov. 1990.
- Page of EM Classifieds. Electronic Musician, Nov. 1989.
- Advertisements. Electronic Musician, Aug. 1989.
- EM Classifieds. Electronic Musician, Jul. 1989.
- Advertisements. Electronic Musician, Jul. 1989.
- Start Me Up?—the Music Biz Meets the personal computer. B. Krepack R. Firestone, Published by Medioc Press, Copyright 1986.
- A Harmonious Musical Interface. S. Cunningham, 1986 Network world. Sep. 8, 1986.
- Synth—Bank, USPTO, USPTO—Trademark Text and Database.
- Managing the Intellectual Property Lifecycle. B. Bell A. Brown, Jr., A excerpt from an article available at Synthbank.com 1998, Synthbank. Inc.
- List of E—Bulletin Boards with an attached EM page of ads, ON—line Resources/Electronic Bulletin Boards.
- An Upbeat Way to Order; worth watching. G. Charlish, 1988 The Financial Times (Lexis—Nexis).
- Musicnet, USPTO, USPTO—Trademark.
- PC Forum Attendees Call for Cooperation with Government. S. Higgins. Westlaw, Monday, Mar. 1, 1993.
- Data Highways . . . Can we get there from here?. J. Burgess, The Washington Post, May 2, 1993 (Lexis—Nexis).
- MNI Interactive to Revolutionize the Way Consumers Select and Purchase Entertainment Products. PR Newswire Association. Jan. 17, 1994.
- The Interactive Age—Can The Exalted Vision Become a Reality?. M. W. Miller, The Wall Street Journal, Thursday, Oct. 14, 1993.
- Music Net Let's Consumer's Fingers do the Walking. J. McCullaugh, Billboard, Saturday, Oct. 16, 1993 (Westlaw).
- "Rolling Stone" Takes Music to The Phone. S. Donaton A. Z. Cuneo, Advertising Age. Jul. 11, 1994 (Lexis—Nexis).
- Most Silicon Valley Ventures Beat the Odds. S. Herhold. Knight—Ridder Tribune Business News. Feb. 14, 1999.
- Entire Sep. Issue. Electronic Musician. Sep. 1986.
- Digit Download—Guidelines for the Architecture of Audio Technical Facilities at an Online Music Retail Site. Preliminary White Paper Version 1.0 Mar. 2, 1999 (CDN 03994-004038).
- USPTO Certificate of Correction—Patent No. 4,528,643, System for Reproducing information in material objects at a point at sale location. USPTO.
- The Telharmonium: An Early Breakthrough in Electronic Music. T. Holmes, Gyrofrog Communications Electronic and Experimental Music 1996.
- Free Music Downloads. CDNow, CDNow Web Site (CDN 000078-85).
- Gameline—the Incredible New Way to Play Video Games. Gameline brochure.
- Downloading and Tele-delivery of Computer Software. Music and Video. International Resource Development, Inc. (DN 021217-021432).
- Downloading and Tele-delivery of Computer Software. Music and Video. International Resource Development, Inc. Jul. 1983 (CDN 021433-021664).
- The Development of a Commercial Tele software Service. A. Sweet. Tele software Cavendish Conference Center Sep. 27-28, 1984. Publication No. 60 [61] Institution of Electronic and Radio Engineers.
- Tele software—The Computer in Your TV set. J. Hedger. New Electronics, vol. 13, No. 245, Dec. 9, 1980.
- Tele Software: Adding Intelligence to Teletext. R. Eason J. Hedger. Proceedings IEEE, vol. 126, No. 12, Dec. 1979.
- Receiving Tele Software With CCT. J.R. Kinghorn, Tele software Cavendish Conference Center Sep. 27-28, 1984. Publication No. 60 [61] Institution of Electronic and Radio Engineers.
- Games Tele Software on Cable. T.J Havelock. Tele software Cavendish Conference Center Sep. 27-28, 1984. Publication No. 60 [61] Institution of Electronic and Radio Engineers.
- Broadcast Tele Software Exerience With ORACLE. J. Hedges, View data and Videotext. 1980-1981: A Worldwide Report.
- The UK Teletext Standard for Tele Software Transmissions. D.J. Rayer. View data and Videotext, 1980-1981: A Worldwide Report.
- Music from the skies promised by firm serving cable users. S. Chase, The Washington Post, Oct. 19, 1981.
- Abstract—L. Landro, The Wall Street Journal, Oct. 14, 1981.
- Abstract—No author listed, UPI—Oct. 13, 1981.
- Hi—Tech do—Dads for the man of the house, No author listed, Trends.
- New Products Programmed for Consumers, No author listed, Computer Report.
- Electronics show had variety of new home equipment, No author listed, Hi—Fi News and Record Reviews, 1985.
- New Telerecording Method for Audio, No author listed, BM/E, Oct. 1985.
- Cable TV Moves To The Music, A.L. Yarrow, NY Times, Jul. 4, 1982.
- What is Stalling the Record Business? No author listed, Business Week, Nov. 30, 1981.
- Labels Gear Up For Home Music Store, No author listed, Billboard Magazine, Apr. 6, 1991.

- The Record Shop of the Future May Be In Your Parlour, Hans Fantel, NY Times, Nov. 22, 1981.
- The Latest Technology, R. Harrington, Washington Post, Jun. 28, 1981.
- Thaddeus Cahill and the Telharmonium (electric instrument), No author listed, <http://nicemusic4.music.niu.edu>.
- Thaddeus Cahill's Dynamophone/Telharmonium (1897), No author listed, <http://www.obsolete.com>.
- Book Review: Magic Music From The Telharmonium, P. Hertz, <http://www.obsolete.com>.
- Telharmonium, No author listed, <http://www.britannica.com>.
- Keyboard and Tactile Interfaces, No author listed, In The Third Person, Oct. 1999.
- No Time To Shop For Software, J. Paioff, InfoWorld, Aug. 20, 1984.
- Warner Amex QUBE Cable Communications, No author listed, <http://www.electricblue.com>.
- A Blast From The Past, P. Conger, <http://www.cableworld.com>, Mar. 28, 1998.
- Where Is Everyone Now, No author listed, <http://www.electricblue.com>.
- Juke Box History 1934 thru 1951, Gert Almind, <http://www.wl.jukebox.dk>.
- The Shyvers Multiphone, No author listed, <http://www.dyz.com>.
- Dead Medium: Telephonic Jukeboxes: The Shyvers Multiphone . . . , B. Sterling, <http://www.wps.com>.
- Downloading and Teledelivery of computer software, games, music, and video, Int'l. Resource Dev. Inc., US Copyright Application, Registration 1-243-407.
- Compusonics Digitizes Phone Lines, No author listed, Digital Audio, Sep. 1985.
- AT&T Demo, No author listed, Pro Sound News, Sep. 9, 1985.
- Videogames and Electronic Toys, Int'l Resources Dev. Inc., May 1983.
- Compusonics Eyes Options: Will Flagship Computer Make Direct CD Copies?, M. Harrington, Information Access Co., Mar. 30, 1987.
- Direct Broadcast's Potential For Delivering Data Service, E. Holmes, Data Communications, Sep. 1984.
- Sonus Music Products, C. Roads, Computer Music Journal, Spring 1987.
- Advertisement: Gameline package, <http://www.geocities.com>.
- Computer Music Networks, C. Roads, Computer Music Journal, Fall 1986.
- Announcements, C. Roads, Computer Music Journal, Sep. 1986.
- CVC Gameline Master Module, No author listed, <http://ccwf.cc.utexas.edu>.
- Oregon Corporate Records, Re: Synth-Bank, Oregon Secretary of State.
- Lexis Search Manual (Entire Manual).
- Affidavit of Edgar Magnin and Exhibits, US Dist Ct for the Southern Dist. Of New York.
- Transcript: Max Conference, Feb. 27, 1993.
- Exhibits To Compuserve's Brief On Claim Interpretation, Jones, Day, Reavis & Pogue, Filed in US Dist. Ct. For The Southern Dist. Of New York.
- AES Presentations, AES Preprints.
- Brochure: Overview articles, etc on PAN, PAN Network.
- Brochure: NERAC.
- CompuSonics DSP—1000 World's First DARPS, CompuSonics Advertisement.
- We Mean Business, C.S. Kaplan, Con. Elec. Daily, May 10, 1984.
- Letter to Shareholders, D. Schwartz, CompuSound, Inc. Jan. 6, 1984.
- Letter to Shareholders, D.Schwartz, CompuSound, Inc. Apr. 6, 1984.
- Letter to Shareholders, D.Schwartz, CompuSound, Inc., Jul. 16, 1984.
- Letter to Shareholders, D. Schwartz, CompuSound, Inc., May 31, 1985.
- Manufacturing Update, Audio Video Inter. Jun. 1984.
- CompuSonics Fuses Computer, Audio Into "Worlds First" HDR, M. Golden, CES Trade News Daily, Jun. 4, 1984.
- Digital Sound Now on Computer Disks, S. Booth, Consumer Elec. Daily, Jun. 3, 1984.
- CompuSonics Readies Floppy disc to record . . . , HFS Newspaper, Jun. 4, 1984.
- Floppy disc may be the next music Makers, Business Week, May 28, 1984.
- CompuSonics: Another Digital Audio St., N. Weinstock, MIX, Aug. 1984.
- The State of RCA, TV Digest, May 21, 1984.
- CompuSonics DSP-1000 . . . , CES Exhibition—D&E, 1984.
- Optical—Disk based Digital Audio System, B. Robinson, Electronic Engineering Times, Sep. 1, 1986.
- Brochure—CompuSonics DSP-1000, CompuSonics Corp. Business Plan Overview, CompuSonics, Corp., Jun. 14, 1984.
- Compusonics Corp. Corporate Profile, Audio Video International.
- Toward Electronic Delivery of Music, J.P. Stautner, CompuSonics Corp.
- Company sees Future in Digital, J. Hendon, Rocky MountainNews, Jul. 22, 1984.
- Floppy-Disk Audio System, A. Mereson, Science Digest, Nov. 1984.
- Recording Music on Floppy Discs, A. Zuckerman, High Technology, May 1984.
- Digital Recording System Uses floppy-discs, Audio Times, May 1984.
- Brochure, Compusonics Corp.
- Hi-Fi Floppy, Cades, P.C. World, Apr. 1985.
- New Hi-Fi Horizons, D. Canada, Stereo Review, Dec. 1984.
- Specs. And Implem.of computer Audio console for Digital Mixing and Recording, D. Schwartz, AES 76th Convention, NYC, Jun. 20, 1984.
- A High Speed Telecommunications Interface for Digital Audio Transmission and Reception, H. H. Sohn, Compusonics Corp.
- The Audio Computer and its applications, Schwartz & Stautner, Compusonics Corp.
- Engineering Your Own Digital Audio Broadcast System, D. Schwartz, Compusonics Corp.
- Memo: To Mr. Kapp; from D. Schwartz, D. Schwartz, CompuSonics Corp., Apr. 26, 1990.
- CompuSonics DSP 2002—Preliminary User Manual, CES, Jun. 1984.
- Digital Mark. Corp. Video Real Estate System, JPS, CompuSonics Corporation.
- Memo: to Holmbraker et al., D. Schwartz, CompuSonics Corporation.

- Assembly Procedure for DS 1500. CompuSonics Corporation.
- Application Notes: CSX Digital Signaling Processing. CompuSonics Corporation.
- DMS Lecture. CompuSonics Corporation, 1991.
- Application Notes: DSP 1000 Digital Audio Disc Recorder. CompuSonics Corporation.
- Letter to E. Kraeutler, Esq. Re: CDNews/Liquid Auto, I. Gross, Wilson, Sonsini, Goodrich and Rosati—Apr. 14, 2000.
- Patent License Agreement. Schoen & Hooban, Ergon Technology Associates Corp.
- The Home Terminal. IRD, Inc., Aug. 1978.
- RoIm Plugs CBX Into. EMMS—May 2, 1983.
- Employee Non-Competition Agreement, CDNow, Inc.
- Letter to D. Berl, Esq., K.J. Choi, Lucent Technologies.
- Video Explosion on the way for buyers, M. Galligan, US News and World Report, Jun. 18, 1984.
- Hi-Fi in the '80's: Not only Alive and Well . . . , L. Feldman, Information Access Co., Jul. 1984.
- The Search for the Digital Recorder, B. Dumaine, Time, Inc., Nov. 12, 1984.
- Ultimate Integration: Putting Software theory into . . . , J. Balga, Information Access Co., Feb. 12, 1985.
- Technology Review, R. Welch, The American Banker, Dec. 12, 1986.
- Remembering the Gameline, D. Skelton, www.mindspring.com.
- Gameline Module links with game bank, D. Burns, www.atarimagazines.com.
- Allison 7 Video, Allison, EE 380 Feb. 18, 1987.
- Telesoftware—Value Added Teletext, J. Hedger, IEEE Transactions on Consumer Electronics; Feb. 1980, vol. CE-26.
- Telesoftware: Home Computing Via Broadcast Teletext, J. Hedger, IEEE Transactions on Consumer Electronics; Jul. 1999, vol. CE-25, No. 3.
- The Future of Television as The Home Communications Terminal. International Resource Development Inc., Aug. 1981 (CDN 23101-23109).
- Videogames & Electronic Toys, note, International Resource Development, Inc May 1983 (CDN 023054).
- Telepaly vs. Videodisc, International Resource Development Inc., Sep. 1982 (CDN 023068).
- Health, Wealth & Self-Improvement Home Software, International Resource Development Inc., Sep. 1985 (CDN 023091).
- Telecommunications Market Opportunities, International Resource Development Inc., Nov. 1985 (CDN 023110-023138).
- VideoPrint (Contents), Jun. 22, 1983 (CDN 023139-23142).
- CompSonics/Carts, Sep. 9, 1985 (CDN 023143).
- Current Samples (CompuSonics Digitizes Phone Lines), Sep. 1985 (CDN 023144).
- (BME) Station Automation (New Telerecording Method for Audio, Oct. 1985 (CDN 023145-23146).
- High-Tech do-Dads for the man of the house (Sound Investments), (CDN 023147-23150).
- New Software (Delivery over the phone), Telephone Software Connection Inc. Oct., 1982 (CDN 023151).
- Communications (No time to shop for software), Jessica Paioff, Aug. 20, 1984 (CDN023152).
- Warner Amex QUBE Cable Communications, Peggy Conger, (CDN 023153-023157).
- Warner Amex QUBE Cable Communications (Articles), (CDN 023158).
- QUBE-ists (Where is everyone now?), (CDN 023159-23160).
- The Shyvers Multiphone, (CDN023161-23162).
- Dead medium: Telephonic Jukeboxes: The Shyvers Multiphone (Multiphone), (CDN 023163-23166).
- Jukebox History 1934-1951, (CDN 023167-23173).
- New Music Box (Keyboard and Tactile Interfaces), Oct. 1999 (CDN 023174-23180).
- Britannica.com (telharmonium), (CDN 023181).
- Book Review (Magic Music from the Telharmonium), Paul Hertz, The Scarecrow Press, Inc., (CDN 023182).
- Thaddeus Cahill (Dynamophone/Telharmonium) 1897, (CDN 023183-23186).
- Thaddeus Cahill and the Telharmonium (electric instrument), (CDN 023187-23189).
- Style (The Latest Technology), Richard Harrington, Jun. 28, 1981 (CDN 023190-23191).
- Financial, Oct. 13, 1981 (Tuesday) (CDN 023192).
- Labels Gear Up For "Home Music Store", Earl Paige Ken Terry Bill Holland, Apr. 6, 1991 (CDN 023193-23194).
- Abstract (Home Music Store), Laura Landro, Oct. 14, 1981 (Wednesday) (CDN 023195).
- Washington Business (Music From the Skies Promised By Firm Serving Cable Users), Scott Chase, Oct. 19, 1981 (Monday) (CDN 023196).
- Arts and Leisure Desk (Sounds: The Record Shop Of The Future May In Your Parlor), Hans Fantel, Nov. 22, 1981 (Sunday) (CDN 023197-23199).
- Media & Advertising (What is stalling the record business), Nov. 30, 1981. (Industrial Edition) (CDN 023200-23202).
- Financial Desk (Cable TV Moves to the Music, Andrew L. Yarrow, Jul. 4, 1982 (L. City Final Edition) (CDN 023203-23204).
- TSC Write-Ups, (CDN 023552).
- Telephone Software Connection, Inc. (The Hayes Micromodem II), (CDN 023553-23554).
- TSC Bibliography (Call-Apple), (CDN 023556-23567).
- Computers (Telephone Software Connection), (CDN 023559).
- Article References (Now Your Home), Popular Mechanics, Mar. 1981. (CDN 023555-23568).
- Buyers Guide (Branch Centers), (CDN 023569-23570).
- News Link (Software delivery now at 2400 baud), Dec. 1985. (CDN 023571).
- Telephone Software Connection, (CDN 023572-23573).
- Software (Online Tip), (CDN 023574).
- Telecommunicating (PC-Talk.III), (CDN 023575).
- Poll (Adults believe children know more about computers), Lawrence Kilman, Oct. 16, 1985 (CDN 023576).
- Electronic Mall (Telephone Software Connection), (CDN 023577).
- Data Communications (Protecting Your Network Data), Elisabeth Horwitt, (CDN 023578).
- To Catch A Thief (Microcomputer), Jul. 1985. (CDN 023579-23583).
- Caller Response (Services) (Shopping for software at home, by phone), (CDN 023584).
- On Line Consulting (Planning, Programming & Training), (CDN 023585).
- Entry (Entry goes on line!), (CDN 023586).
- Unique (2000 New Articles Screened Each Day), (CDN 023587).

- Entry (Entry Magazine), (CDN 023588).
- Satin and lace, and a message base (A board is a board), Dru Simon, (CDN 023589).
- Reflections (on the videotex industry), Carole Houze Gerber, (CDN 023590).
- Software Online (Help for Disabled Computer Users), (CDN 023591).
- Telescan Analyzer & Telescan Database, Dec. 1984, (CDN 023592).
- Reader Service (Phone secretary II), Dec. 1984, (CDN 023593-23595).
- Communications Software (Software Communications Inc.), Nov. 1984 (CDN 023596-023601).
- Communications (No time to shop for software?), Jessica Paioff, Aug. 20, 1984 (023602).
- Link (Telephone Software), May 1984, (CDN 023603-23621).
- Sample of Available Graphics Programs (Manufacturer), Oct. 1984 (CDN 023607).
- RAM Required, Oct. 1984 (CDN 023608).
- Telecommunicating, Art Kleiner, Spring 1984, (CDN 023610-23611).
- Whole Earth Recommended Telecommunication Tools (Terminal Programs), Feb. 1984 (CDN 023612-23613).
- Mite (Finding Mite), Spring 1984 (CDN 023614-23618).
- Electronic Mail Programs (MCI Mail), Spring 1984 (CDN 023619).
- Computer Conferencing Systems (CompuServe Special Interest Groups (SIGs), Spring 1984 (CDN 023620).
- Uncorrected Page Proof (How RO Get Free Software), Alfred Glossbrenner, (CDN 023622).
- The Treasure Trove (Comments:Diversi-DOS), DSR.Inc (CDN 023623-23630).
- In Search of the Consummate Time Manager (Effective Management), Margaret P. Ezell, (CDN 023631-23632).
- Display (meet, report,sell, plan), (CDN 023633).
- Turning Point (Time is Money), (CDN 023634).
- Lecture, May 1984 (CDN 023635-23636).
- Getting on Communi (Providers and Consumers), Ed Magnin, Telephone Software Connection, Inc. Mar. 1984 (CDN 023637-23638).
- Telecommunications (A Software Vending Machine), Ed Magnin, Telephone Software Connection, Inc. Mar. 1984 (CDN 023639).
- Telecommunications (Auto Modem), Michael J. O'Neil, Mar. 1984 (CDN023640).
- Micro Software Distribution (Now,Software Is Distributed By Wire, Ronald R. Cooke, Nov. 1983 (CDN 023642).
- References: Offices and Numbers. 1984 (CDN 023643-23660).
- Softalk (SubLogic), Dec. 1983 (CDN 023661-23676).
- The TRS Connection, Nov. 1983 9CDN 023677-023679).
- Display (The Access Unlimited Micro Shopping Center), Nov. 1983 (CDN 023680).
- Telecommunications (Telecommunications Adviser), Ed Magnin, Telephone Software Connection Inc. Nov. 1983 (CDN 023681-23682).
- Communications (Special Delivery Software), Lisa B. Stahr, Oct. 1983 (CDN 023683-23686).
- Plumb (Employment Want Ads Go Online), Jun. 1983 (CDN 23688-23695).
- Apple's New Image, (CDN 023696).
- Tech (Lisa And Software Writers—No Love At First Byte?), Jessica Schwartz, (CDN 023697-23698).
- Display (Datamost), (CDN 023699).
- Cider (What's New This Month), Jun. 1983 (CDN 023700-23701).
- Display (2nd Generation Spreadsheet), (CDN 023702).
- Telecommunications (Telecommunications Adviser), Ed Magnin, Telephone Software Connection Inc. Jun. 1983 (CDN 023703-23704).
- Cider Book Shelf, Jun. 1983 (CDN 023705-23706).
- Telecommunications (Telecommunications Adviser) "Acoustic", Ed Magnin, Telephone Software Connection Inc. Jun. 1983 (CDN 023707-23709).
- Downloader's Supermarket, Jun. 1983 (CDN 023710).
- Letters (Krell Responds to review of LOGO), (CDN 023711).
- Display (Apple Orchard) Peelings II responds. Nov. 2, 1983 (CDN 023712-23713).
- Display (Nibble is Terrific), (CDN 023714).
- Technology (Electronic Software Delivery Threatens Mail And Store Sales), William M. Bulkeley, Apr. 11, 1983 (CDN 023716-23717) The Wall Street Journal.
- ET Phones Office (Electronic Transfer), Apr. 1983 (CDN 023718-23721) The Digest.
- Western Union's Easylink Gets Direct Telex-To-PC Connection, Mar. 21, 1983 (CDN 023722)Information System News.
- The Book Of Software, 1983 (CDN 02723-23725).
- Softalk Classified Advertising (The Predictor), Apr. 1983 (CDN023726-23729 Softalk.
- Programs boogie with-o-tech (Sales styles and marking strategies: A hard look at software), Joanne Cleaver, (CDN023730-23731) Home Computer.
- Marketing Moves (Information services move modems), Deborah de Peyster, Mar. 7, 1983 (CDN 023733) ISO World.
- Computer-Based Business Files (Available file transfer software), Mar./Apr. 1983 (CDN 023734-23735).
- Chapter II Using Your Thunderclock Plus (Applications Software Packages Supporting the Thunderclock Plus), (CDN 023736).
- Thunderclock Plus (User's Guide), (CDN 023737).
- Pinball wizardry's gone electronic (the home computer), Duane Sandul, (CDN 023738).
- Programmed to trim that waistline (the home computer), Duane Sandul, Feb. 5, 1983 (CDN 023739).
- High adventure (the home computer), Duane Sandul, (CDN 023740).
- Variation on a Theme, Dec. 1982 (CDN 023742).
- Programmers Library, Paul Leighton, Dec. 1982 (CDN 023743-23744).
- The Arcade Machine (Introduction), Chris Jochumson Doug Carlston, (CDN 023745).
- Telephone Transfer II (Introduction), Leifhton Paul Ed Magnin, Nov. 1982 (CDN 023746).
- Printographer (Introduction), Stephen Billard (CDN023747).
- Connecting Your Computer to a Modem: Where to Start, Bill Chalgren (CDN 023748-23756).
- L.I.S.A. (Laser Systems Interactive Sybolic Assembler) V. 1.5, (CDN 023757-23758).
- Recent Computer Science Books, (CDN 023759-23763).
- Modifying Your Monitor Program, Leighton Paul, (CDN023764-23765).
- Modems: Hooking your Computer to the World, Stan Miastkowski George Stewart, Dec. 1982 (CDN 023766-23772).

- Business (Telephone Software Connection), Dec. 1982 (CDN 023774-23787).
- Displays (COOSOL Computer Products), Dec. 1982 (CDN 023788).
- Displays: Apple (Amper-Magic), Dec. 1982 (CDN 023789).
- Tomorrow's Apples Today (Telephone Transfer II), Nov. 1982 (CDN 023790-23792).
- Display: (Music Maker Etc.), (CDN 023793).
- A Guide to Communication Software Packages (Cutting line cost), Oct. 1982 (CDN 023794-23807).
- Data Communication Professionals:(Engineering Department Manager-Software, Oct. 1982 (CDN 023808).
- Modems and the Micromodem II, Athol H. Cohen, (CDN 023809-23818).
- Software (Arcade Math), Sep./Oct. 1982 (CDN 023819-23821).
- Marketing (Makers Transform the Ways Computer Programs Are Sold), Susan Chace, Aug. 26, 1982 (CDN 023822).
- Letter Perfect Data Perfect Edit 6502 (Letter Perfect), (CDN023823-23826).
- Patching DOS The Easy Way, Leighton Paul, (CDN 023827).
- Display: Together,Locksmith, the Inspector and Watson, (CDN 023828).
- Electronic Mail System Enhances Delphi Method, Bernard S. Husbands, 1982 (CDN 023829-23832).
- New Products (Save Civilization in Your Spare Time), May 1982 (CDN 023833-23843).
- Just a Call Away (Dial Up Software Service), (CDN 023844).
- Display: Radio & Records, (CDN 023845).
- Display: She's No Stranger Now, (CDN 023846).
- Radio & Records: Letter to Ed Magnin, Pam Bellamy, Apr. 22, 1982 (CDN 023847).
- How to buy a personal computer (Here We Go Again), (CDN 023849-23850).
- What's New? (Overlay Compiler, Mar. 1982 (CDN 023851-23852).
- Display: Pure Power, Feb. 1982 (CDN 023854).
- New Products: Not Just Another Chess Game (Championship chess), Feb. 1982 (CDN 023855).
- New Electronic Mail Service On-Line, (CDN 023856).
- Display: Arithmetic Teacher (Problems for Solving Fractions), (CDN 023857).
- A Guide to Personal Computers (Personal-Computer Hardware), Steve Ditlea, Dec. 14, 1981 (CDN 02386223870) New York.
- A Line on Friendly Utilities, Theron Fuller, (CDN 023871-23874).
- Conferences Goes On-Line (Ethernet Online), (CDN 023875-23881).
- Terminal Data, Jeffrey Mazur, Sep. 1981 (CDN 023882-23885).
- Dataloop: Smartmodem announced at NCC '81, Jul. 2, 1981 (CDN 023886-23893).
- Research: George Bond, Jul. 7, 1981 (CDN 023894-23896).
- Market Charter, Jun. 1981 (CDN 023897-23901).
- Telephone Software Connectin (Phone Log), Feb. 1981 (CDN 023902).
- Display: Faster Than a Speeding Typist, (CDN 023903).
- Marketalk News (Multi-Media Video), Jan. 1981 (CDN 023904-23905).
- Dial-Yo Directory (Talking Terminals, Frank J. Derfler, Jr., Jan. 1981 (CDN 023906-23907).
- Apple Cart (Books), Chuck Carpenter, (CDN 023908-23910).
- Display: Space War and Invasion, (CDN 023911).
- Marketalk News (Hardhat Software), Nov. 1980 (CDN 023912-23913).
- Admin.:Hello CBS News (Letter to Ed), (CDN 023915-23916).
- Display: Advanced Electronics, (CDN 023918).
- Novation Premieres New Exhibit at Two Los Angeles Shows, (CDN 023919-23923).
- Microprocessor Newsletter: Microprocessor Training Center, Jun. 5, 1980 (CDN 023924-23932).
- The Telephone Software Experience a Review (of Sorts), Val J. Golding, May 1980 (CDN 023933-23935).
- Bibliography (hand notes), (CDN 023917-23732).
- Display:Our Records of Growth, May 1979 (CDN 023937).
- Display: Purchase and Receive Software, (CDN 023953).
- Letter from License Department to Edgar&Marilyn Magnin, Jul. 19, 1979 (CDN 023938).
- Copy of Business License (Business License Application), Edgar & Marilyn Magnin, (CDN 023939-23940).
- Letter from J. Walker Owens Re: New Business Operator (Welcome), J. Walker Owens, Aug. 9, 1979 (CDN 023941-23944).
- Software for the Apple II (Dynamaze.Ultra Blockade Games), (CDN 023945-23946).
- Display: Telephone Software Connection (Many Thanks for Your Recent Order), (CDN 023947).
- Price Log (Answering Machines, Write-Edit&Send), (CDN 023951-23952).
- Display: Advertisement (Desk Calculator II), Jul. 1980 (CDN 023950).
- Instructions: Computer with header, (CDN 023954).
- Microsoft Consumer Products Continuing the Microsoft Tradition (Announcing Microsoft Consumer Products), (CDN 023955).
- The Apple Orchard (Computer World Printer INIT Routine), Mar./Apr. 1980 (CDN 023956).
- Volume Table of Contents (\$11,0), Jul./Aug. 1980 (CDN 023957-23959).
- Sup'r Terminal (Specifications), (CDN 023960).
- Call-Apple (functions, remin.), Mar./Apr. 1980 (CDN 023961).
- Call-Apple (Stock Market Data Retrieval One the Source), Hersch Pilloff, Mar./Apr. 1980 (CDN 023962).
- CBS News Crew From Walter Cronkite, David Dow, Sep 9, 1980 (CDN 023963-23965).
- Telephone Software Connection (Phone Log), (CDN 023966-23969).
- Advertising for quicker shopping over computer (Go-Moku), (CDN 023970-23971).
- Advertising for Pet and Apple II Users (PASCAL), Nov./Dec. 1980 (CDN 023973).
- Letter from Telephone software Connection (Regarding the Electronic Communication Service), Mar. (CDN 023977).
- Letter (Offering Introduction), (CDN 023979-23983).
- Letter from Ed Magnin Ref: TSC/Telemail User), Ed Magnin, Feb. 8, 1982 (CDN 023984).
- Now Your Home Computer Can Call Other Computers One the Telephone, Neil Shapiro, Mar. 1981 (CDN 023985-23987).

- Advertising (Shape Builder, Terminal Programs, Double DOS, Math Tutor), Mar. 1981 (CDN 023988-23990).
Softalk (Micromate's Micronet—It Plugs in the Game Port), May (CDN 023991).
Voided Blank Check #1513, May (CDN 023998).
Corvus Controlling 3 Apples (We Have New Phone Numbers), May 18, 1981 (CDN 023999).
Predicting the Future With Electronic Mail (The Telenet Way), Bernard S. Husbands, Oct. 1981 (CDN 024000-24001).
Program Shopping by Phone: Software Co. Downloads Programs, Michael Swaine, Oct. 19, 1981 (CDN 024002).
Telephone Software Connection, Inc. (The Hayes Micromodem II: I've Never Brought a Better Slave, Jul. 1981 (CDN 024003).
Advertising (Shape Builder), CDN 024006-24008).
Advertising (Telephone Transfer II), (CDN 024009).
Display: The FP Report, (CDN 024018) Telephone Software Connection, Inc.
Display: Order Via Modem, (CDN 024019).
Price Log, Jun. 2, 1982 (CDN 02492023422).
Price Log Cont., Oct. 21, 1982 (CDN 024023).
Display: Telephone Software Connection (Address Postage), (CDN 024024-24025).
Telephone Software Connection (Letter to Apple Dealer), Ed Magnin, (CDN 024026).
Display (Mr. Smartypants), (CDN 024028-24030).
Display (Disk-Cryption), (CDN 024031-24032).
Display (Video Librarian, (CDN 024033-24035).
Display (World Currency Trader), (CDN 024036-24037).
Display (Working Model of Telephone Software), (CDN 024038).
Telephone Software Connection (Letter to AppleCat Owner), Ed Magnin, (CDN 024039-24040).
Telephone Software Connection : The Hayes Micromodem II (I've never bought better slave), May 1980 (CDN 024041-24042).
Special Memo to Educators, Ed Magnin, (CDN 024043-24044).
Telephone Software Connection (Background Piece, (CDN 024045-24049).
Display: Vend-O-Disk, (CDN 024050-24052).
Letter to Programmer, Ed Magnin, (CDN 024053-24054).
News From T.S.C., Apr. 1983 (CDN 024055-24058).
News From T.S.C., Jun. 1983 (CDN 024059-24062).
What is Voicemail?, (CDN 024063-24065).
Telephone Software Connection (Introduction), Ed Magnin, (CDN 024066-24067).
News From T.S.C., Oct. 1983 (CDN 024068-240710).
How to Order: Modem, 024072-24077).
Telecommunication (Teledelivery), (CDN 024084).
News From T.S.C., Jun. 1984, (CDN 024085-24088).
PlumbLine (Base Computers), (CDN 024089-24090).
News From T.S.C., Dec. 1984 (CDN 024091-24094).
News From T.S.C., Mar. 1985 (CDN 024095-24098).
Display: Phone Secretary, (CDN 024099-24100).
Telephone Software Connection (Background Pieces), (CDN 024101-24106).
Telephone Software Connection (Top Secret) Displays, (CDN 02410724113).
Display (Before 1984), (CDN 024114).
Display: If You Have an Apple (phone list), (CDN 024115-24117).
Display (The FP Report), (CDN 024118-24119).
The Haye's Micromodem II, CDN 024120-24121).
Price Log, (CDN 024122-24123).
News From T.S.C., Oct. 1983 (CDN 024124).
Display: Instructions on Software Delevery), (CDN 024125).
Price Log, (CDN 024126-24127).
News From T.S.C., Jun. 1983 (CDN 024128-24129).
Price Log, (CDN 024130-24131).
News From T.S.C., (CDN 024132-24133).
Display (Phone Secretary II (54), CDN 024134).
Letter to Programmer, Ed Magnin, (CDN 024135).
Programmers' Pipeline (Description Slip), (CDN 024136-24137).
Display: World Currency Trader, (CDN 024138).
Price Log, (CDN 024139-24140).
Display: Order Via Modem, (CDN 024141).
Display: Six Great Ways to Add to Your Summer Fun!, CDN 024142).
Phone Log, (CDN 024143-24144).
News From T.S.C. (Recent Offerings), Mar. 1985 (CDN 024145).
Spotlight on Graphics (Shape Builder), CDN 024146-24148).
Disk. Labelmaker (#73), CDN 024149).
News From T.S.C. (Terminal Program II), (CDN 024150-24152).
Free Update to Desk Calendar II, (CDN 024153).
News From T.S.C., Jun. 1984 (CDN 024154-24156).
Display: (Disk-Cryption), (CDN 024157-24158).
Display: (Phone Secretary) (#54), (CDN 024159-24160).
Communication (Terminal Program), (CDN 024161-24168).
Dialing Instructions, (CDN 024169).
Telecommunications Adviser, Ed Magnin, Nov. 1983 (CDN 024170-24171).
Getting On Communi (Providers and Consumers), Ed Magnin, Mar. 1983 (CDN 021417224173).
Online Tips, (CDN 024174).
Display: List (Software Sales), Apr. 11, 1983 (CDN 024175).
A Software Vending Machine, Ed Magnin, Mar. 1984 (CDN 024176).
Marketing (Makers Transform the Ways Computer Programs Are Sold), Susan Chace, Aug. 26, 1982 (CDN 024177) The Wall Street Journal.
Technology (Electronic Software Delivery Threatens Mail and Store Sales), May 6, 1983 (CDN 024178).
Western Union: Mailgram (Letter to Microcomputer User), (CDN 024179).
Apple//c Baud Rate Problem (Dialing Instructions), (CDN 024180).
Display: Recent Offerings, Mar. 1985 (CDN 024181-24184).
Letter ti Prometheus Modem Owner, Ed Magnin, (CDN 024185).
Display: Phone Secretary// (54), (CDN 024186-24187).
Future Developments in Telecommunication, (CDN 024188).
Responses (Future Developments in Telecommunication), (CDN 024189).
Charts (Uses for Telecommunication Links), (CDN 024190-24192).
Prologue (The Communication Satellite), (CDN 024193-24194).

- Analog Versus Digital Transmission. (CDN 024195-24206).
 Cable Television and Its Potential. (CDN 024207-24209).
 Display: Qube gets you into the action. (CDN 024210).
 Terminals in the Home. (CDN 024211-24223).
 A Future Scenario. (CDN 024224-24246).
 Signal Compression. (CDN 024247-24261).
 Letter from Ed Magnin (Monthly Rental), Ed Magnin. (CDN 024262-24264).
 Jitters. Jul. 29, 1996 (CDN 024265) Business Week.
 E-Commerce: Who Owns the Rights?. Jul. 29, 1996 (CDN 02466-24267).
 A pilot has to believe in his equipment. (Rolex). (CDN 024268).
 Retailers cheer end of patent challenge. Dan Goodin. Apr. 2, 1999 (CDN 024269-24271).
 Patently Offensive, Shoshana Berger. (CDN 024272).
 Magnin & Associates (Video Game, Film & TV), (CDN 024273-24274).
 Documents (Appendix F: Decimal Tokens for Keywords), (CDN 024275-24276).
 Appendix F: Decimal Tokens For Key words. (CDN 024277).
 Private People (Easing the way for libel suits), (CDN 024278).
 May the Source Be With You, Christopher Bryon. (CDN 024279).
 Information Services: Modems, (CDN 024280).
 A Source of Riches. Alfred Grossbrenner, Aug. 1983 (CDN 024281-24284).
 Electronic Jackpot, Alfred Grossbrenner, Sep. 1983 (CDN 024285-24287).
 Consumer and Specialized On-Line Services, (CDN 024288-24290).
 Calculation Programs. (CDN 024291-24293).
 What Is Viewdata. CDN 024294-24302).
 PM Electronics Monitor, Neil Shapiro, (CDN 024303).
 Dial-Up Software Networks. Jules H. Gilder, May 1980 (CDN 024304-24306).
 Software and Data Via Telephone, Oct. 1980 (CDN 024307-24310).
 Dial-Up Software Networks, Herb Friedman, Oct. 1992 (024311-24314).
 Documents (Ticketmaster to Lick Competition by Buying It), (CDN 024315-24316).
 Ticketmaster (memo), Alan Citron Michael Cieply, Feb. 26, 1991 (CDN 024317-24318) Los Angeles Times.
 Ticketmaster: 20 Years (Industry's #1 Has a Ticket to Rule), Adam Sandler, (CDN 024319-24321).
 Electronic Life, Michael Crichto, 1983 (CDN 024322).
 The Naked Computer (Telesoftware ?), Rochester, Gantz, William Marrow + Co., (CDN 024323).
 Computers for Everybody (Downloading Programs), Jerry Willis, 1984 (CDN 024324-24328).
 Telecommunications in the Information Age (Videotext Chapter 12), Singleton, 1983 (CDN 024329-24340).
 United States Patent (Lockwood), May 3, 1994 (CDN 024341-24343).
 United States Patent (Yuris, et al.), Jan. 27, 1981 (CDN 024344).
 United States Patent (Kelly, et al.), May 15, 1984 (CDN 024345).
 United States Patent (Hellman), Apr. 14, 1987 (CDN 024346-24347).
 Documents (The Wired Society), James Martin, (CDN 02434824349).
 New Use of Television (Viewdata). (CDN 024350).
 News (Do-It-Yourself Newspapers), (CDN 024351).
 Spider Webs (Pierre Teilhard de Chardin. (CDN 024352-24353).
 Instant Mail (Digitized Messages). (CDN 024354).
 Information Deluge. (CDN 024355).
 Satellite Age (Chapter Fourteen Home). CDN 024356-24366).
 James Martin & Co. Executive Profiles (James Martin, Oct. 25, 1996 (CDN 024367-24368) JM & Co.
 2. News (Dow Jones News/ Retrieval's Free-Text Search), 1985 (CDN 024369-24383).
 Computers (Telesun), (CDN 024384-24387).
 16 Full-Service (The Source), (CDN 024388-24408).
 Article 49 of 88 PatNews : Another reason why the E-Data patent is invalid, Gregory Atharonian, Oct. 16, 1996 (CDN 024409-24410) Deja News.
 Article 1 of 25 PatNews: Mor PTO gossip on Zache.Edata, Hyatt, Gregory Atharonian. Oct. 18, 1996 (CDN 024411-24412).
 Display: TSC Review. (CDN 024413).
 United States Postal Service (Documents & Letters), (CDN 024414-24423).
 The Home Accountant, Revisited (Responds to reviews), (CDN 024424-24426).
 DFX (Introductions), Graeme Scott, (CDN 024427-24442).
 Peelings Review (Introductions), Nov. 12, 1982 (CDN 024443).
 Pellings II (Programmers Library), Nov. 10, 1982 (CDN 02444-24454).
 Letter (Trial Termial), K.F. Moseley, Mar. 10, 1981 (CDN 024455).
 K.F. Moseley's TVInterface 8 Evaluation (Time and Money Meter, Ed Magnin. (CDN 024456-24457).
 A.D.A.M. II Newsletter (Acknowledgement), May 13, 1981 (CDN 024458-24465).
 Peelings II (Publication of Apple Software Reviews), Aug. 6, 1980 (CDN 024467-24500).
 Apple-Cart (Input From Readers), Chuck Carpenter, (CDN 024501-24503) Creative Computing.
 Call-Apple (The Telephone Software Experience a Reivew (of Sort), Val Golding, (CDN 024504).
 Softalk (Peachy Writer), Sep. 1982 (CDN 024505).
 Softalk (Preformer Printer Format Board), (CDN 024506).
 Extra Copy RE: KM, (CDN 024507-24508).
 Marketing (Makers Transform Ways Computer Programs Are Sold), Susan Chace, Aug. 26, 1982 (CDN 024509) The Wall Street Journal.
 Marketing (Some Computer Junkies), Susan Chace, Aug. 26, 1982 (CDN 024510) The Wall Street Journal.
 Extra (CDN 024511).
 New Products (Save Civilization in Your Spare Time), May 1982 (CDN 024512) Popular Computing.
 Extra (CDN 024513).
 What's New? (Overlay Compiler), March 1982 (CDN 024514).
 The Information Directory Says It All! (Subject Index), (CDN 024515).
 Tap New Markets! (Information Directory), (CDN 024516).
 The 21st Century Library (Information Directory), Anne M. Helfrich, Mar. 16, 1982 (CDN 024517-24524).

- Electronic Mail (Applications for Management), (CDN 024525-244534).
- InfoWorld (AVL Eagle), Oct. 19, 1981.
- TSC (Microcomputing), Oct. 15, 1981 (CDN 024536).
- Electronic Distribution (Trial Builder), (CDN 024537-24546).
- Music (Honey, They're Downloading Our Song), Patrick M. Reilly, (CDN 024547-24548).
- Who's News (Foundation Health Names Malik Hasan As CEO and President), May 13, 1997 (CDN 024549).
- Industry Focus (Middlemen Find Ways to Survive Cyberspace Shopping), David Bank, (Dec. 12, 1996 (CDN 024550)).
- Egghead Inc. Ships Software Over Internet (Ingram Micro Inc.), David Bannk, Nov. 8, 1996 (CDN 024551).
- Tom Clancy, Virtus Start Firm for On-Line Games, Nov. 13, 1996 (CDN 024552).
- N2K Hires Phil Ramone to Start Up A Music Label Linked to the Internet, Patrick M. Reilly, Nov. 18, 1996 (CDN 024553).
- Business Briefs (AT&T Unveils a Services to Help Businesses Set Up Shop on Internet), James Sanberg, Oct. 9, 1996 (CDN 024554).
- Technology & Health (Industry Net Customers to Be Offered On-Line Payment Services From PNC), Raju Nariseti, Sep. 25, 1996 (CDN024555).
- Vague New World (Digital Media Business Takes Form as a Battle Of Complex Alliances) (CDN 024556-24558).
- Music Firms Vow to Block New CD System, Meg Cox, May 14, 1993 (CDN 024559-24560).
- Business (Blockbuster plans to stock CDs electronically, May 12, 1993 (CDN 024561).
- Technology&Health (Bellcore to Demonstrate System For Delivering Movies By Phone, Mary Lu Carnevale, Nov. 9, 1992 (CDN 024562).
- Technology (IBM Commits More Than \$100 Million on Venture to Relay Video, Other Data), Michael W. Miller, Sep. 16, 1992 (CDN 024563-24564).
- IBM to Unveil Plan to Skip Disks. Send Software By Satellite (GM's Hughes Network Joins Big Blue Alliance to Serve Retailers and Corporations), Bart Ziegler, Nov. 1, 1994 (CDN 024565-24566).
- Software Industry Bulletin (SIB Third Quarter 1985 Software Employment Survey), Oct. 14, 1985 (CDN 024567-24568).
- Download (Vendors Kick Off Fall Season With Teledelivery Ventures, Sep. 1985 (CDN 024569-24583).
- Speed>s (Electronic Delivery of Software), (CDN 024584-24595).
- Phone Memo, Apr. 19, 1985 (CDN 024596-24600).
- Letter to Nathaniel Forbes (MCI Mail Letter), Ed Magnin, Apr. 8, 1985 (CDN 024601-24607).
- Speed>s (The Inside Story), Apr. 8, 1985 (CDN 024608-24623).
- Document: Letter to Nathaniel Forbes (Express Mail), Ed Magnin, Mar. 29, 1985 (CDN 024624-24630).
- Gimcrax, Inc (The leader in electronic delivery of software), Dec. 5, 1984 (CDN 024631-24636).
- Speed>s (New Edition of Speed<s disk Now Available), (CDN 024637).
- Speed>s (Postage), (CDN 024638).
- Speed>s (Over 50 Lotus 1-2-3 templates to be available exclusively on Speed<s!, (CDN 024639).
- Speed>s (Postage), (CDN 024640).
- Speed>s (Open An Electronic Library for Your Company Software), (CDN 024641).
- Speed>s (Postage), Jan. 27, 1986 (CDN 024642).
- Gimcrax Launches File Delivery Service, Dec. 23, 1985 (CDN 24643).
- Speed>s (What Modem Should I Buy), Nov. 22, 1985 (CDN 024644).
- Display (Speed>s), Dec. 2, 1985 (CDN 024645).
- Speed>s (Now! Try Speed<s Electronic Delivery!), Oct. 21, 1985 (CDN 024646).
- Speed>s (Your First Issue on the Speed<s Password!), (CDN 024647).
- International Videotex Teletext News (Gimcrax to Download), Aug. 1984 (CDN 024648).
- Speed>s (Speed>s Mean Business), (CDN 024649-24652).
- News From the Source (Nat Forbes Promoted to Director of Sales for STC), (CDN 024653-24654).
- Speed>s (Speed>s Mean Business), (CDN 024655-24658).
- Handwritten Notes, (CDN 024659-24665).
- Handwritten Notes (Nat Forbes), Mar. 28, 1985 (CDN 24666-24668).
- Net to Transmit Videotex, Games to 12 Million User, Jim Bartimo, Jun. 13, 1983 (CDN 024669) Computer World.
- Vending machines for software: What will Japan think up next? (Games only), Jun. 1985 (CDN 024670) Data Communications.
- Electronic Software Distributor To Show System to Retailers, Rory J. O'Connor, May 30, 1983 (CDN 024671).
- Software Industry Bulletin (Electronic Software Distributors), (CDN 024672-24675).
- Software (Why try to stock software like physical goods? Why not just reproduce it as needed), (CDN 0924676-24683).
- Mr. Download: An Interview with William von Meister, (CDN 024684-24693).
- Letter to Bob Peyser (Telephone Software Connections), Ed Magnin, Mar. 25, 1985 (CDN 02469424700).
- Direct-Net (Micro Marketworld Readers), Bill James, Feb. 1, 1985 (CDN 024701-24702).
- Cutting Out the Middleman (Looking to expand their customer base), Myron Berger, (CDN 024703-24708).
- Shop by Modem (Software Without Manuals), (CDN 024709).
- Speak the Universal Lanaguage (Powerhouse), (CDN 024710).
- Letter to Ed Magnin (Software Author Royalty Agreement), Fannie Clifton, Oct. 17, 1983 (CDN 024711-24733).
- Buy Software Via Modem (Define the Need), Elizabeth Ferrarini, (CDN 024734-24745).
- ABC Video Enterprises Telefirst Project Had Boosters & Doubters, May 1, 1984 (CDN 024746).
- Download (Micropro & Adapso Sue American Brands, Allege Software Piracy), Feb. 1985 (CDN 024747-24762).
- Coleco, AT&T Unit to Form Joint Venture To Distribute Video Games By Telephone, Bob Davis, (CDN 024763).
- Electronic (Pulling the Plug on Electronic Publishing), (CDN 024764-24766).
- Software (Software Directories Go On-Line, Joanne Gamlin (CDN 024767-24780).
- Say It With Remote Rom Software Delivery (Looking Ahead With Software News), (CDN 024781).
- It's Not The Same Old 'Help' Anymore (Buzz Word), Mary-Beth Santarelli, (CDN 024782).

- Are You Getting Ready for Electronic Software Delivery?, Richard Lewis, Feb. 1984 (CDN 024783-24788).
- Hammerly files suit against PC TeleMart, (CDN 024789).
- Micro Software Today (Education: Entertainment), (CDN 024790).
- Distribution & Retailing (Xante to Distribute Software Electronically to Mass Merchandisers), (CDN 024791).
- Systems : Software Engineering (Letter from Phil Klamm), Phil Klamm, Jan. 20, 1984 (CDN 024792).
- ROM-Labs (Electronic Software Distribution System), Jan. 3, 1984 (CDN 024793-24802).
- Van Diver's (The Most Resourceful Directories for the IBM PC), (CDN 024803).
- Software Distribution: Smooth Going Now : Rocky Road Ahead, Steve Burke, (CDN 024804).
- Romox is hoping to have system in 3,000 stores by end of '84, (CDN 024805).
- Display (Soft Touch), Jan. 12, 1984 (CDN 024806).
- Bugs in Electronic Software Distribution Not Worked Out (Electronic Distribution), Lisa Raleigh, (CDN 024807-24809).
- Announcing a New In-Depth Study and Analysis of (Downloading & Teledelivery of Computer Software, Music & Video), Nancy L. Stocker, Mar. 11, 1986 (CDN 024810-24824).
- Certificate of Copy Registration (Time and Money Meter), Edgar J. Magnin, Mar. 8, 1982 (CDN 024825-24840).
- Certificate of Copy Registration (Quick Clock Adjust), Edgar J. Magnin, (CDN 024841-24847).
- Certificate of Copy Registration (Math Tutor), Edgar J. Magnin, Jul. 18, 1981 (CDN 024848-24864).
- Document: Delivery Notice (Certified), (CDN 024865).
- Document: Postal Receipt (Certified) From : Ed & Marilyn Magnin, Mar. 27, 1981 (CDN 024866).
- Receipt for Certified Mail #288727, Mar. 6, 1981 (CDN 024867).
- Instructions :Certified Mail Fee, Optional Services, (CDN 024868).
- Letter from Edgar J. Magnin (Copyrights Registration: Terminal Programs, Edgar J. Magnin, Mar. 5, 1981 (CDN 024869-24889).
- Receipt (Register of Copyrights), Nov. 4, 1980 (CDN 024890-24905).
- Receipt (Register of Copyrights: Library of Congress, Sep. 3, 1980 (CDN 024906-24927).
- Certificate of Copyright Registration (Phone Secretary), Edgar J. Magnin, Nov. 4, 1980 (CDN 024929-24934).
- Letter from Edgar J. Magnin (Copyright Registration: Phone Secretary), Edgar J. Magnin, Aug. 27, 1980 (CDN 024935-24946).
- Letter from Edgar J. Magnin (Call TSC, Picture Transfer, Go-Moku, Chess Connection, Edgar J. Magnin, May 30, 1980 (CDN 024947-24951).
- Certificate of Copyright Registration (Go-Moku), Edgar J. Magnin, Jun. 9, 1980 (CDN 024952-24960).
- Certificate of Copyright Registration (Chess Connection), Craig Crossman, (CDN 024961-24971).
- Certificate of Copyright Registration (Go-Moku), Edgar J. Magnin, (CDN 024972-24981).
- Certificate of Copyright Registration (Call TSC), Edgar J. Magnin, (CDN 024982-24986).
- Certificate of Copyright Registration (Picture Transfer Program), Edgar J. Magnin, (CDN 024987-25002) Apr. 1980.
- Letter from Edgar J. Magnin :Applications for Copyright (Answering Machine, Write-Edit & Send, Telephone Transfer Program, Edgar J. Magnin, Mar. 28, 1980 (CDN 025003-25007).
- Certificate of Copyright Registration (Write-Edit & Send, Edgar J. Magnin, (CDN 025008-25018).
- Certificate of Copyright Registration (Telephone Transfer Program), Edgar J. Magnin, (CDN 025019-25033).
- Certificate of Copyright Registration (Answering Machine), Edgar J. Magnin, (CDN 025035-25046).
- Certified Receipts: Certificate of Copyright Registration (Telephone Transfer II, Leighton Paul, Oct. (CDN 025047-25095).
- Certificate of Copyright Registration (Telegammon), Anton Dabhura, Jr., (CDN 025096-25139).
- Letter to Mr. Ledbetter RE: Correspondence of Mar. 12, 1982 control #2-054-0414(M), Edgar J. Magnin, Oct. 4, 1982 (CDN 025140-25212).
- Certificate of Copyright Registration (Phone Secretary II), Edgar J. Magnin, Sep. 6, 1983 (CDN 025213-25253).
- Certificate of Copyright Registration (Fifteen, Puzzle), Edgar J. Magnin, 7,1985 (CDN 025254-25313).
- Letter to Mr. Magnin: RE: Fraction Tutor (TX 1 384 355) sand Typing Speed Builder (Certificate of Copyright Registration (Fraction Tutor), Edgar J. Magnin Larry M. Schultz, Jan. 4, 1985 (CDN 025314-25344).
- Receipt for Certified Mail (Certificate of Copyright Registration (Picture Puzzle Programs), Edgar J. Magnin, (CDN 25345-25380).
- Certificate of Copyright Registration (Quick Compare), Leighton Paul, (CDN 025381-25405).
- Telephone Software Connection, Inc. (Program Listing), (CDN 025406-25408).
- Serial Listing, (CDN 025409).
- Serial Listing (con't), (CDN 025410).
- Copyright Status (Programs,Copyright Notice Etc.), (CDN 02541125412731).
- Receipts for Certified Mail : Letter from Edgar J. Magnin to Register of Copyrights (Instant Menu) Certified of Copyright Registration, Edgar J. Magnin, (Jun. 6/11, 1985 (CDN 025413-25448).
- Receipts for Certified Mail: Letter from Edgar J. Magnin to Register of Coping (Certified of Copyright Registration) : Mortgage Analyzer, Edgar J. Magnin, (CDN 025449-25475).
- CompuSonics Version 1.05 (The Drive Event Control Loop for the DSP-1000), Jul. 17, 1987 (CDN 025476-255545).
- Documents (Routing for the Machine, Routines Required to Read and to the Front Panes), Mar. 11, 1987 (CDN 025546-25667).
- CompuSonics D S P 2002 version 1.00 (Preliminary User Manual, Aug 28, 1985 (CDN 025668-25707).
- Audio Computer Owners Guide (Advertising), (CDN 025708).
- Quick Reference Card (Operations), (CDN 025709-25767).
- An Algorithm and Architecture for Constant-Q Spectrum Analysis (Abstract), Gary W. Schwede, Apr. 1983 (CDN 025768-25771).
- AES (Presented at the 76th Convention Oct. 8-11, 1984 New York, (CDN 025772-025775).
- Command and Status Registers (Receive Data Count Register), (CDN 025776-25786).

- Letter to David M. Schwartz (RE: The Preprints From the AES 78th Convention), Patricia M. Maclonald, Nov. 18, 1985 (CDN 25787-25817).
- Efficient Data Reduction for Digital Audio Using a Digital Filter Array (Purpose), John P. Stautner David M. Horowitz, 1986 (CDN 025818-25821).
- AES (Presented at the 83rd Convention Oct. 16-19, 1987 New York), David M. Schwartz, (CDN 025822-25829).
- AES (Presented at the 83rd Conventin Oct. 16-19, 1987 New York, John Stautner Sriram Jayasimba, (CDN 025830-25836).
- AES (Presented at the 84th Convention Mar. 1-4, 1988 Paris, J.P. Stautner, (CDN 025837-25854).
- The Digital Audio Cartridge Disk Recorder, Reproducer and Editor for Broadcast Use, David M. Schwartz, (CDN 025855-25866).
- Towards Electronic Delivery of Music(1.0 Introduction, John P. Stautner, (CDN 025867-25873).
- Architecture of a Real Time Digital Filterbank Processor for Tempered, Auditory, and Critical-Band Analysis/Synthesis, Gary W. Schwede, (CDN 025874-25875).
- A Functional Overview of the Compusonics DSP-2000 Series, (CDN 025876-25877).
- Musical Recording, Editing and Production Using the Compusonics DSP-2004, John P. Stautner, (CDN 025878-25879).
- Strategies for the Representation and Data Reduction of Digital Music Signals (Work Performed and Methods Employed), John P. Stautner, Jun. 20, 1984 (CDN 025880-25881).
- Analysis and Synthesis of Music Using the Auditory Transform, J. Stautner, Submitted to Dept. of Electrical Engineering and Computer Science, Massachusetts Institute of Technology May 1983 CDN025895.
- Algorithms and Architectures for Constant-Q Fourier Spectrum Analysis, G. Schwede, Dissertation submitted to University of California, Berkeley Nov. 28, 1983 CDN026097.
- Letter to Shareholders, D. Schwartz, CompuSonics CDN026261.
- From the News Desk, Info World Newsweekly, Jun 4, 1984 vol. 6, Issue 23 CDN026263.
- Manufacturing Update, International Audio Video, Jun. 1984 CDN026264.
- Compusonics Pro Equipment & Services, Cover of Billboard Newspaper CDN026265.
- Compusonics Fuses Computer, Audio Into "World's First" Home Digital Recorder, M. Golden, CES Trade News Daily, p. 10 Jun. 4, 1984 CDN026266.
- Digital Sound Now On Computer Disks, S. Booth, Consumer Electronics Show Daily Jun. 3, 1984 CDN026267.
- CompuSonics Readies Floppy Disk to Record and Play Back Music, HFD—The Weekly Home Furnishings Newspaper Jun. 4, 1984 CDN026268.
- Technology Awards to CompuSonics, CDN026269.
- CompuSonics DSP 1000 Digital Audio Disk Recorder Specifications, CompuSonics Corporation CDN026270.
- CompuSonic Bows Totally Digital, Pro Sound News, New York, NY Jun. 8, 1984.
- Floppy Disks May Be the Next Music Makers, Business Week May 28, 1984 CDN026272.
- Studio Design Special, Mix—The Recording Industry Magazine Aug. 1984.
- CompuSonics: Another Digital Audio Standard, N. Weinstein, Mix, vol. 8, No. 8, p. 24 CDN026274.
- CompuSonics: Another Digital Audio Standard, N. Weinstein, Mix, vol. 8, No. 8, p. 26 CDN026275.
- CompuSonics Readies Floppy Disk to Record and Play Back Music, HFD, Electronics, Section 1 Jun. 4, 1984 CDN026276.
- The State of RCA, TV Digest, p. 14 May 21, 1984 CDN026277.
- Display—CompuSonics Photographs, CDN026278.
- Display—CES Exhibition Design and Engineering 1984, CDN026280.
- Specifications—CompuSonics DSP 1000 Digital Disk Recorder/Player, CompuSonics Corporation CDN026281.
- Article—Watch Out Digital Discs: Here Comes Floppy Audio, Unknown.
- Specifications—CompuSonics DSP 1000 Digital Disk Recorder/Player, CompuSonics Corporation.
- Optical-Disk-Digital Audio System Premieres, B. Robinson, Electronic Engineering Times, Issue 397 Sep. 1, 1986 CDN026284.
- Specifications—CompuSonics DSP 1000 Digital Disk Recorder/Player, CompuSonics Corporation.
- CompuSonics Business Plan Overview, Jun. 14, 1984 CDN026286.
- Cover—Fortune Magazine, Nov. 12, 1984 CDN026289.
- Advertisement—CompuSonics Corporate Profile, D. Schwartz, Audio Video International CDN026290.
- Toward Electronic Delivery of Music: Sending and Receiving High Fidelity Digital Music, J. Stautner, CompuSonics Corporation CDN026291.
- Company Sees Future in Digital Recorders, J. Hendon, Rocky Mountain News Jul. 22, 1984.
- Floppy-Disk Audio System, A. Mereson, Science Digest Nov. 1984 CDN026299.
- Recording Music on Floppy Disks, A. Zuckerman, High Technology May 1986 CDN026300.
- Article—Sound is Big at Consumer Show, L. Mortwaki, Seattle, Washington Times Jun. 8, 1984 CDN026301.
- Digital Recording System Uses Floppy Disks, Audio Times, vol. 26, No. 5 May 1984 CDN026302.
- CompuSonics Advertisement, CDN026304.
- Advertisement—MicroPro's WordStar 2000, CDN026305.
- Hi-Fi Floppy, K. Yates, PC World, vol. 3, Issue 4 CDN026306.
- The Digitization of Music, K. Yates, PC World, vol. 3, Issue 4 CDN026308.
- A Sonic Glossary, K. Yates, PC World, vol. 3, Issue 4 CDN026311.
- New Hi-Fi Horizons, D. Ranada, Stereo Review, Dec. 1984 CDN026313.
- Specifications and Implementation of a Computer Audio Console for Digital Mixing and Recording, D. Schwartz, AES 76th Convention, NYC Jun. 20, 1984 CDN026317.
- A High Speed Telecommunications Interface for Digital Audio Transmission and Reception, H. Sohn, Abstract CDN026319.
- The Audio Computer and Its Applications, D. Schwartz; J. Stautner, CompuSonics Corporation CDN026332.
- Engineering Your Own Digital Audio Broadcast System, D. Schwartz, CompuSonics Corporation CDN026343.
- Tab—Pay 2 Tape '90, CDN026362.
- Fax Cover Sheet to Michael Kapp from D. Schwartz, D. Schwartz, Apr. 26, 1990 CDN026363.
- Fax Memo to Michael Kapp from D. Schwartz, D. Schwartz, Apr. 26, 1990.

- Pay Per Listen Cable Audio System—Notes to Viewgraph Presentation, CompuSonics, CDN026365.
- Pay Per Listen Cable Audio System—System Payback Analysis, CompuSonics, CDN026366.
- Pay Per Listen Cable Audio System—Provide the In-Home Music Taper with a Wide Variety of Source Material, CompuSonics, CDN026367.
- Pay Per Listen Cable Audio System—Provide the In-Home Music Taper with a Wide Variety of Source Material, CompuSonics, CDN026368.
- Pay Per Listen Cable Audio System—Audio Database Format Options, CompuSonics, CDN026374.
- Pay Per Listen Cable Audio System—Billboard Top 100 LPS Format, CompuSonics, CDN026375.
- Pay Per Listen Cable Audio System—Program Publication Options, CompuSonics, CDN026379.
- Letter to Shareholder from D. Schwartz, D. Schwartz, Nov. 21, 1984 CDN026381.
- Letter to Shareholder from D. Schwartz, D. Schwartz, Oct. 10, 1985 CDN026382.
- Display Photograph, CDN026384.
- Display Photograph, CDN026385.
- CompuSonics DSP2002 Preliminary User Manual, CDN026386.
- Display—Hardware Spec, CDN026387.
- Internal Data, CDN026388.
- DSP-1000 Series, CDN026389.
- Digital Marketing Corporation Video Real Estate System, Jun. 7, 1986 CDN026390.
- Agenda for Jun. 7, 1988 Meeting, CDN026393.
- Agenda for May 31, 1988 Meeting, CompuSonics, CDN026394.
- Advertisement—Digilist Video Multiple Listing Service, Digital Marketing Corporation, CDN026395.
- Advertisement—Digilist Video Multiple Listing Service, Digital Marketing Corporation, CDN026396.
- Advertisement—Digilist Video Multiple Listing Service, Digital Marketing Corporation, CDN026398.
- Memo to B. Holmbraker, B. Alderfer, R. Dahl, H. Fong from D. Schwartz, D. Schwartz, CompuSonics Financial/Technical Status Jan. 12, 1987 CDN026399.
- Manual—Assembly Procedure for the DSP1500, CDN026401.
- Specifications—CompuSonic DSP 1000, CDN026440.
- DSP 1000 Digital Audio Disk Recorder Application Notes, CDN026489.
- The Home Terminal, International Resource Development, pp. 149-158 Aug. 1978 CDN026745.
- Rolm Plugs CBX Into IBM World, Electronic Mail & Message Systems vol. 7, No. 9 May 2, 1983 CDN026768.
- Control Video Enters Downline Loading Business, Electronic Mail & Message Systems vol. 7, No. 11 Jun. 1, 1983 CDN026771.
- EMMS Article, Electronic Mail & Message Systems vol. 7, No. 14, p. 17 Jul. 15, 1983 CDN026775.
- The Other Half of the IBM PC, Electronic Mail & Message Systems vol. 7, No. 16 Aug. 15, 1983 CDN026776.
- Electronic Message Systems and the Home Terminal, Electronic Mail & Message Systems vol. 3, No. 12 Jun. 15, 1979 CDN026779.
- EMMS Article, Electronic Mail & Message Systems vol. 3, No. 15, p. 13 Aug. 1, 1979 CDN026784.
- EMMS Article, Electronic Mail & Message Systems vol. 6, No. 11, p. 20 Jun. 1, 1982 CDN026785.
- EMMS Article, Electronic Mail & Message Systems vol. 6, No. 15, p. 14 Aug. 2, 1982 CDN026786.
- EMMS Article, Electronic Mail & Message Systems vol. 6, No. 23 Dec. 1, 1982 CDN026789.
- Fiber-Optics Will Shake the Utilities, Electronic Mail & Message Systems vol. 9, No. 20 Nov. 1, 1985 CDN026792.
- British Telecom Offers Free Electronic Mail Services, Electronic Mail & Message Systems vol. 10, No. 7 Apr. 1, 1986 CDN026797.
- Profit Protection—Risky Business, Electronic Mail & Message Systems vol. 12, No. 16 Aug. 15, 1988 CDN026801.
- EMMS Article, Electronic Mail & Message Systems vol. 12, No. 21 Nov. 1, 1988 CDN026811.
- CompuSonics to Bow Digital Audio Floppy Disk Player/Recorder: CD Rival?, C. Kaplan, Consumer Electronics Daily, vol. VIII, No. 5, Issue 8 May 10, 1984 CDN026255.
- Home Telecommunications in the 1980's, International Resource Development, Inc. Apr. 1980, Report 150 CDN026812.
- The Future of Television, International Resource Development, Inc. Aug. 1981, Report 176 CDN026914.
- Health, Wealth & Self-Improvement Home Software, International Resource Development, Inc. Sep. 1985, Report 670 CDN026935.
- Telecommunications Market Opportunities, International Resource Development, Inc. Nov. 1985, Report 676 CDN026955.
- Teletyp vs. Videodisc, International Resource Development, Inc. Sep. 1982, Report 510 CDN027013.
- Videogames & Electronic Toys, International Resource Development, Inc. May 1983, Report 550 CNDN027034.
- Payments Received for Report #558 Downloading and Tele-delivery of Computer Software, Games & Music, Kenneth G. Bosomworth, Jan. 9, 2001 CDN027138.
- Article—CompuSonics/Carts AT&T Demo, Pro Sound News Sep. 9, 1985 CDN027183.
- Intentionally Omitted Documents
CDN027190—CDN027734, Mar. 13, 2001 Letter to N. Bigas from R. Gruwell Mar. 9, 2001 Letter M. Neblett from N. Bigas Mar. 5, 2001 Letter to M. Neblett from N. Bigas
Transcription of Videotape, EE 280—Feb. 18 1987—Allison 7 CDN027735.
- The Digital Audio Processing Station: A New Concept in Audio Postproduction, J. Moorer: C. Abbott; Peter Nye et al., Journal of Audio Engineering Society, vol. 34, No. 6, Jun. 1986, pp. 454-464 CDN027783.
- On Digital I/O Format, T. Doi, Sony Corporation Presented at AES Digital Audio Technical Committee, Hamburg, West Germany Mar. 16, 1981 CDN027794.
- PCM Program Transmission and Communication Network for the Norwegian Broadcasting Corporation, R. Andersen: K. Ronning, Journal of the Audio Engineering Society vol. 28, No. 4 Apr. 1980.
- A Fibre Optic Multi-Channel Communication Link Developed for Remote Interconnection in a Digital Audio Console, P. Lidbetter S. Douglas, Presented at the 80th Convention, Audio Engineering Society Reprint (Preprint 2330 D6) Mar. 4-7, 1986 CDN 027830.
- BBC Digital Audio—A Decade of On-Air Operation, D. Stripp, BBC, London, United Kingdom Collected Papers from the Audio Engineering Society Premiere Conference, Rye, New York Jun. 3-6, 1982 CDN027846.

- Processing Systems for the Digital Audio Studio, M. Jones, Neve Electronics International Limited, Royston, Hertfordshire, United Kingdom Collected Papers from the Audio Engineering Society Premiere Conference, Rye, New York Jun. 3-6, 1982 CDN027852.
- Large Scale Acoustics, D. Hawkins, Studio Sound and Broadcast Engineering Mar. 1985.
- BBC Digital Control Vehicle 12 Months On, K. Spencer-Allen, Diary-Diary, Studio Sound, p. 32-33 Nov. 1986.
- WDR NEVE DSP Now in Use, Diary-Diary, Studio Sound, p. 18 Aug. 1986.
- Digital Mastering Tape One, Studio Sound, pp. 36, 38, 40 Aug. 1986.
- Digital Sound Signals: The Present BBC Distribution System and a Proposal for Bit-Rate Reduction by Digital Compressing, M. Croll; D. Osborne; C. Spicer, International Broadcasting Convention Sep. 23-27, 1974.
- Audio Engineering Handbook, K. Benson, Audio Engineering Handbook All-Digital Studio, pp. 4.37-4.38 Transmission Systems, pp. 4.57 Stereo with Television, p. 4.59 © 1988 CDN027884.
- Handbook of Recording Engineering, J. Eargle, The All-Digital Studio, pp. 373-375 © 1986 CDN027892.
- Routing of Digital Audio Signals in a Radio Broadcasting Centre, N. Gilchrist; G. Crowe G. Legg, Eleventh International Broadcasting Convention Sep. 19-23, 1986 CDN027897.
- Signal Routing in a Digital Sound Studio, G. Roe; C. Caine, Eleventh International Broadcasting Convention Sep. 19-23, 1986 CDN027902.
- Multi-Purpose Radio Links System for News Coverage, P. Marchant; I. Buffham, International Broadcasting Convention Sep. 18-21, 1982 CDN027907.
- DOCAT—Digital, Optical CATV Trunk System, G. Mogensen; B. Petersen; H. Steffensen, International Broadcasting Convention Sep. 18-21, 1982 CDN027913.
- Digital Transmission System for Television, Sound and Associated Data, A. Jones; D. Kitson, Tenth International Broadcasting Convention Sep. 21-25, 1984 CDN027918.
- Digital Sound Mixing in the Analogue Studio, M. Jones; D. Langford; D. Tilsley, Tenth International Broadcasting Convention Sep. 21-25, 1984 CDN027923.
- Digital Speech Networks, B. Gold, Proceedings of the IEEE, vol. 65, No. 12 Dec. 1977 CDN027939.
- The Digital Coding of High-Quality Musical Sound, J. Moorer, Journal of the Audio Engineering Society vol. 27, No. 9, pp. 657-666 Sep. 1979 CDN027962.
- Digital Audio for Cable Television, C. Robbins, 1986 NCTA Technical Papers, pp. 21-24 CDN028131.
- Speech Understanding Systems, Massachusetts Inst. of Technology, Lincoln Lab., U.S. Department of Commerce, National Technical Information Service May 31, 1973 CDN028138.
- Speech Understanding Systems, Massachusetts Inst. of Technology, Lincoln Lab., U.S. Department of Commerce, National Technical Information Service Jan. 15, 1974 CDN028166.
- Information Processing Techniques Program, vol. I. Packet Speech/Acoustic Convolvers, Massachusetts Inst. of Technology, Lincoln Lab., U.S. Department of Commerce, National Technical Information Service Jun. 30, 1976 CDN028198.
- Speech Analysis Synthesis and Perception, J. Flanagan, Bell Laboratories Channel Vocoders, pp.323-405 CDN028247.
- Digitization of Audio: A Comprehensive Examination of Theory, Implementation and Current Practice, B. Blesser, Journal of the Audio Engineering Society vol. 26, No. 10 Oct. 1978 CDN028268.
- Personal Computers and Music: The State of the Art, C. Yavelow, Journal of the Audio Engineering Society vol. 35, No. 3 Mar. 1987 CDN028301.
- MIDI: Musical Instrument Digital Interface, B. Moog, Journal of the Audio Engineering Society vol. 34, No. 5 May 1986 CDN028325.
- How Does a Computer Make Music?, J. Moorer, Computer Music Journal, vol. II, No. 1 pp.32-37 CDN028357.
- Lossless Coding for Audio Discs, P. Craven M. Gerzon, Journal of the Audio Engineering Society vol. 44, No. 9 Sep. 1996 CDN028342.
- AC-3: Flexible Perceptual Coding for Audio Transmission and Storage, C. Todd; G. Davidson; M. Davis, et al., Paper presented at the 96th Convention of the Audio Engineering Society, Feb. 26-Mar. 1, 1994 Dolby Laboratories, San Francisco CDN028365.
- Masterline Software by Phone, Apple II User's Manual KH000015.
- Masterline Software by Phone, Commodore 64 User's Manual KH000017.
- Masterline Software by Phone, Commodore Software Edition for the Bellsouth Master Module KH000028.
- Electronic Games Magazine, Jun. 1983 KH000055.
- Gameline Magazine, Oct. 1983 KH0000181.
- Masterline Software by Phone, Issue Two, Apple Software Edition for the Bellsouth Master Module KH000209.
- Electronic Games Magazine, Oct. 1983 KH000245.
- Apple II Reference Manual; N2K04850.
- VAX/VMS Accounting Utility Reference Manual, Sep. 1984 N2K05242.

* cited by examiner

US 5,191,573 C1

1
EX PARTE
REEXAMINATION CERTIFICATE
ISSUED UNDER 35 U.S.C. 307

NO AMENDMENTS HAVE BEEN MADE TO
THE PATENT

2
AS A RESULT OF REEXAMINATION, IT HAS BEEN
DETERMINED THAT:

5 The patentability of claims 1-6 is confirmed.

* * * * *