

# EXHIBIT AU

8029986

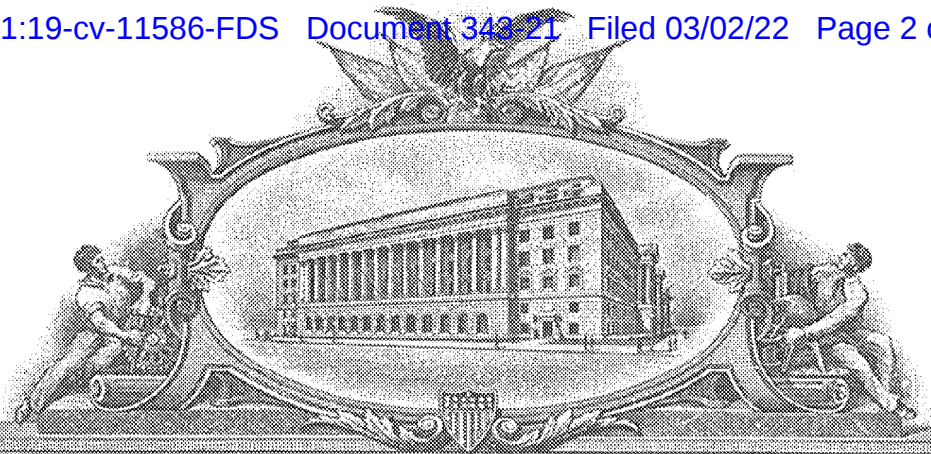

# THE UNITED STATES OF AMERICA

**TO ALL TO WHOM THESE PRESENTS SHALL COME:**

UNITED STATES DEPARTMENT OF COMMERCE  
United States Patent and Trademark Office

*January 06, 2020*

**THIS IS TO CERTIFY THAT ANNEXED IS A TRUE COPY FROM THE RECORDS OF THIS OFFICE OF THE FILE WRAPPER AND CONTENTS OF:**

**APPLICATION NUMBER:** *12/211,033*  
**FILING DATE:** *September 15, 2008*  
**PATENT NUMBER:** *8277377*  
**ISSUE DATE:** *October 02, 2012*



Certified by

Under Secretary of Commerce  
for Intellectual Property  
and Director of the United States  
Patent and Trademark Office

Docket No. 00125/002005

TITLE OF THE INVENTION

Method and Apparatus for Health and Disease Management  
Combining Patient Data Monitoring with Wireless Internet Connectivity

CROSS-REFERENCE TO RELATED APPLICATIONS

[0001] This is a continuation of U.S. Patent Application Serial No. 11/649,703, filed January 3, 2007, entitled “Method and Apparatus for Health and Disease Management Combining Patient Data Monitoring with Wireless Internet Connectivity,” which is a continuation of U.S. Patent Application Serial No. 11/184,274, filed July 18, 2005, entitled “Method and Apparatus for Health and Disease Management Combining Patient Data Monitoring with Wireless Internet Connectivity,” now U.S. Patent No. 7,156,808, which is a continuation of U.S. Patent Application Serial No. 10/418,845, filed April 18, 2003, now U.S. Patent No. 6,936,007, which is a continuation of U.S. Patent Application Serial No. 09/738,270, filed December 15, 2000, now U.S. Patent No. 6,602,191, which is a conversion of U.S. Provisional Application Serial No. 60/172,486, filed December 17, 1999. The disclosure of each of the prior applications is incorporated herein by reference in its entirety.

REFERENCE TO GOVERNMENTAL SUPPORT

(none)

REFERENCE TO MICROFICHE APPENDIX

(none)

FIELD OF THE INVENTION

[0002] The present invention relates to monitoring of living subjects, and more particularly to health-monitoring of persons where measured or input health data is communicated by a wireless device to and from a software application running on an

Docket No. 00125/002005

internet-connected server and where the same may be studied and processed by the software application, a health professional, or the subject.

#### BACKGROUND OF THE INVENTION

**[0003]** Several attempts have been made in the past to achieve efficient interactive communication of medical or health information between a subject or patient and a reviewer or provider of that information. In particular, communication of consumer physiological information has been a subject of such attempts. It is noted that in this regard the “reviewer or provider of medical or health information” is understood to include not only a physician but also a software application or algorithm that may analyze the information.

**[0004]** Medical or health information has been made available on a D-ROM accessible by a home computer system. This passive approach had certain disadvantages. First, although the personal computer is prevalent in the United States, it is generally too expensive for a consumer physiological monitoring system and there are many people who find it too complicated to set up and use for that purpose. High-risk, chronically ill patients, responsible for more than half of health care costs in the United States and forming the fastest growing segment of those requiring health care, are indeed the most likely not to be able to afford or use a system built around a personal computer. In addition, such systems are limited in their interactivity to the information stored on the CD.

**[0005]** Previous patents by the Inventor addressed both of these disadvantages, as well as the need to reduce health care costs through providing educational health care information and interactive physiological monitoring in the home environment by means of a user-friendly, interactive system (see, e.g., U.S. Patent Nos. 5,601,435, 6,144,837, and continuations thereof).

**[0006]** These previous patents were based on a video game console, or a multimedia player using a conventional television screen as the display device to achieve a system which is simpler to use than systems based on a personal computer. An initial embodiment of the previous patents utilized a compact disc to provide interactive information for disease management.

Docket No. 00125/002005

[0007] Even with the advantages provided, these systems limited the user to location in which the device was located. Even where devices are portable, as in the case of a laptop computer with a modem, an ordinary POTS phone line must be found and used. Where the user's computer employs a broadband connection, such as DSL or satellite, the choices of location are even more limited.

[0008] Attempts have been made to remedy this deficiency. For example, many telemetry systems allow a "wireless" distance to be placed between a health measuring unit and a remote monitoring system. However, such systems are limited in their range.

[0009] Other systems have used cellular telephone technology to increase the wireless health monitoring range. However, these systems have several deficiencies, such as requiring significant modification of the mobile phone. For example, U.S. Patent No. 5,772,586, issued June 30, 1998 to Heinonon et al., discloses a method for monitoring the health of a patient. This system uses a specialized connection between the patient health measuring unit and the cellular phone, however. The patient health measuring unit is located in the battery space of the mobile phone and is connected to a communication bus of the mobile phone. Other systems have been proposed, but these suffer from similar deficiencies in that they are not designed to be used with "off-the-shelf" wireless devices or health measuring equipment.

[0010] The deployment of the above systems also currently lacks employment of full back-end server functionality with which to provide a wide range of interactive communication with the patient. Instead, such systems, if internet-enabled, are often limited to mere one-way non-interactive data transfer via a modem. While some systems are more enhanced, including that disclosed in U.S. Patent No. 5,357,427, issued October 18, 1994 to Langen, et al., and entitled "Remote Monitoring of High-Risk Patients using Artificial Intelligence", these systems are limited by the wired telecommunications infrastructure.

#### SUMMARY OF THE INVENTION

[0011] Embodiments of the present invention overcome one or more of the

Docket No. 00125/002005

disadvantages of the prior art by providing a full-feature health-monitoring system that may wirelessly connect to a back-end server application via the internet. The invention allows wireless access to and from a wide variety of present medical or health-related instruments and devices, while maintaining the capability of connecting to future such devices.

[0012] In particular, the invention may be embodied in several systems. Two complementary such systems are described herein, although extensions to other such systems can be envisioned. First, an embodiment of the invention may be employed to manage the disease state or condition of a patient. In this embodiment, the patient may employ a health monitoring device (“HMD”), in particular a medical device, and a wireless connection provides data from the medical device for processing via the internet including a review by a physician or other health care professional if required.

[0013] In the second embodiment, a health or lifestyle management plan may be implemented. Various health parameters, such as those relating to nutrition or exercise, may be entered into a health monitoring device, in this instance termed an “exercise machine”, and the same may be wireless communicated to a server. An application may process and store the health parameters, and a health specialist may optionally review the same.

[0014] Wireless internet connectivity has many advantages. For example, in the first embodiment, a diabetic could connect a blood glucose meter to an internet-enabled wireless web device (“WWD”) away from home and download data to a Diabetes Management Company's server and, in response, receive guidance displayed on the screen (or by voice) about choices for the next meal.

[0015] Alternatively, in the second embodiment, a person interested in tracking an exercise program may take the WWD to the local health club and attach the same to an exercise machine, send data output from various exercise machines over the Internet, and receive a personalized response from the server of a company specializing in Health & Lifestyle Management. The individual may input caloric content of foods eaten, and may further input caloric content of exercise performed. In this way, e.g., a person in a weight-loss program may see in great detail whether they are expending more calories in the form of exercise than the same individual is consuming in the form of food.

Docket No. 00125/002005

[0016] In general, in the health management embodiment, the system may be employed to monitor the physiologic status of a healthy subject while eating, exercising, or performing other activities. For clarity, such devices are termed herein “exercise machines”. These may include an electronic body weight scale, a body fat gauge, biofeedback devices, physiotherapy or chiropractic equipment, blood pressure recorders, or the like, or any type of exercise machine or monitor, including a heart rate monitor, treadmill, rowing machine, stepper, or the like.

[0017] In more detail, the present invention provides a method and system for assisting patients to manage a disease or maintain healthy lifestyle by collecting health-related data and providing information in response to those data by means of a WWD designed to display interactive information through a connection to the Internet. The present invention may be connected to various HMDs, both medical and exercise-related in nature, and may communicate information via a wireless connection such as a wireless Internet connection.

[0018] A major advantage of embodiments of the invention is that the same frees the patient from the constraints of wired systems. The same allows users with consumer “off-the-shelf” wireless devices to significantly extend the range of connectivity over that of wired computer, television, or even wireless telemetry systems.

[0019] In a first embodiment of the present invention, the WWD is a web-enabled cellular phone. Here it is noted that the term “web” or “internet” are used interchangeably to refer to the internet in general. In a second embodiment, the WWD is a palm, handheld, or laptop computer, or a PDA, equipped with a wireless modem. In a third embodiment, the WWD may be a hybrid device that combines the functions of a computer, PDA and telephone.

[0020] An adaptor is used if necessary to convert the output signal of the medical monitoring device to a suitable input signal for the WWD. The adaptor allows connection of the WWD to a medical device, exercise machine or other variety of health care equipment, and the connection may be made via several techniques. As for wired techniques, a standard

Docket No. 00125/002005

parallel bus or serial cable may be used if the input/output ports between the HMD and the WWD are appropriate. Otherwise, a suitable separate adaptor may be employed.

[0021] The connection may also be an input such as a disk drive or other media input for input of data, a USB port or phone jack or other such wired input, again employing an adaptor if required.

[0022] As for wireless techniques, infrared (IR), microwaves, radio frequency (RF), e.g., Bluetooth® or 802.11 protocols, optical techniques including lasers, and other such techniques may be used. The patient or subject may also input data manually, such as by a stylus, keypad, synchronization from a PC, or by various other techniques discussed below.

[0023] A major advantage of the invention is that by use of an optional adaptor, the system is compatible with current and prior HMDs as well as maintaining a capability of adapting to future such systems.

[0024] Other advantages of the invention may include one or more of the following. An embodiment of the invention may be used when a patient is traveling or otherwise away from their “wired” means of communication. The invention allows wireless health-monitoring to the level of accuracy previously achieved only by desktop so-called “wired” computer systems. The invention is protocol-independent.

[0025] The interaction between a WWD and a back-end server may provide a major additional advantage in certain embodiments of the invention. In particular, the relatively small amount of memory currently provided on a WWD as compared to a back-end server severely limits the functionality of applications running on the WWD, especially in terms of computing capacity, processing power, and user interface. By providing significant application functionality on the back-end, less memory and processing capabilities become necessary on the WWD (i.e., on the “front-end”). Thus, memory may be used in the WWD for an enhanced user interface or for other purposes, according to the user requirements.

[0026] In a method according to an embodiment of the invention, the patient connects to a specific Internet site and a software program, resident on a remote server located on the Internet, downloads an interactive user interface for that patient and an



Docket No. 00125/002005

application for the measurement of the physiological data. The software may also be downloaded to the WWD from a personal computer via a synchronization operation in known fashion. The software provides a personalized display for the user and configures the WWD to control and monitor devices connected via a generic input/output port to the WWD. The software may be designed to suit the constraints of the small display screens of WWDs. The software, as well as inputs from the patient or other inputs, can control the manner, content, and display of information presented to the patient, and measured or input data can be stored for review by a health care provider or by a software algorithm or application. The algorithm may be of varying complexity, from a simple program that merely acknowledges receipt of information to an artificial intelligence algorithm, such as an expert system, collaborative filtering system, rules based system, case-based reasoning system, or other such artificial intelligence application.

**[0027]** Further information may be provided to or from the patient, including information entered manually. The patient may input this information via a personal computer, which then may download the input information to the WWD via a synchronization operation using standard protocols, such as those for Palm PDA devices.

**[0028]** The user may also input supplemental information via a PC connected independently to the server via the internet. Such supplemental information may include data that is difficult or inconvenient to input on the WWD. In this way, the patient may be afforded a more convenient environment in which to manipulate data to supplement the data input to the WWD. The deployment of voice processing technology may be used to enable an even more convenient user interface: i.e., one to which patients can talk.

**[0029]** In all of these respects, the portable aspect of the WWD is important: to wit, the user may conveniently carry the WWD on their person wherever they may go, allowing data entry at the time needed.

**[0030]** Other aspects, features, and advantages will be apparent from the summary above, as well as from the description that follows, including the figures and the claims.

Docket No. 00125/002005

#### BRIEF DESCRIPTION OF THE DRAWINGS

[0031] FIG. 1 illustrates a general embodiment of a wireless health-monitoring system according to the present invention;

[0032] FIG. 2 illustrates an embodiment of a wireless health-monitoring apparatus according to the present invention, showing the system of FIG. 1 up to a point of a wireless antenna;

[0033] FIG. 3 illustrates an embodiment of a back end of a health-monitoring system according to the present invention;

[0034] FIG. 4 illustrates a data flow diagram according to an embodiment of the present invention;

[0035] FIG. 5 illustrates an embodiment of a method of use for a wireless application and a server application according to the present invention, in which the same is implemented for disease and patient management;

[0036] FIG. 6 illustrates an embodiment of a method of use for a wireless application and a server application according to the present invention, in which the same is implemented for health management;

[0037] FIG. 7 illustrates an embodiment of a wired connection between a HMD and a WWD, also showing an optional adaptor; and

[0038] FIG. 8 illustrates an embodiment of a wireless connection between a HMD and a WWD, also showing an optional adaptor.

#### DETAILED DESCRIPTION OF THE PREFERRED EMBODIMENTS

[0039] Various acronyms are used for clarity herein. Definitions are given below.

[0040] The term “HMD” may encompass not only devices with physiologic sensors but also devices with a keypad, keyboard, mouse, pointer, pressure sensor, or other such inputs that the patient or user may employ to perform data entry of the desired parameters. In general, HMDs include some means for determining a health parameter.

[0041] In a disease management embodiment, an HMD may be a blood glucose

Docket No. 00125/002005

monitor, a blood pressure monitor, an ambulatory ECG recorder, a respiratory monitor, a temperature or heart rate monitor, and so on.

**[0042]** In a healthy lifestyle management embodiment, an HMD may be an exercise machine, including treadmills, rowers, steppers, exercise cycles, or other aerobic or anaerobic exercisers, or a monitor, include monitors for temperature, heart rate, blood pressure, amount of work or rate of work performed, etc.

**[0043]** The term “subject” as used herein primarily indicates a human subject. The same may be a medical patient under physician care, a person interested in maintaining health via accurate recording of nutrition and exercise, and so on. The term “user” is generally used to refer to the user of the device, which may be synonymous with the subject or may alternatively be a caregiver of the subject, etc. The term “patient” is used, in addition to a person under the care of a physician, to also refer to a “normal” or healthy individual who is interested in maintaining a healthy physiologic balance.

**[0044]** The term “signal communication” is used to mean any type of connection between components where the connection is, e.g., electromagnetic, and where the connection allows information to be passed from one component to another. This term may be used in a similar fashion as “coupled”, “connected”, “information communication”, “data communication”, etc. The following are examples of signal communication schemes. As for wired techniques, a standard bus or serial cable may be used if the input/output ports are compatible and an optional adaptor may be employed if they are not. As for wireless techniques, IR, microwaves, RF, e.g., Bluetooth® or 802.11 protocols, optical techniques including lasers, and other such techniques may be used. The patient or subject may even input data manually, such as by a stylus or keypad or by various other techniques discussed above and below.

**[0045]** The term “generic input/output port” is used to mean any type of convention, standard, universal, stock, consumer, or “off-the-shelf” type of port for data input and output. These may include both wired and wireless ports. A further description is given below.

**[0046]** Various embodiments of the invention are now described in more detail.

Docket No. 00125/002005

[0047] Referring to FIG. 1, a system of the present invention is shown for monitoring health data from a patient or subject 38. The system includes a wireless health-monitoring apparatus (“WHMA”) 10 described in further detail below. WHMA 10 is linked in a wireless fashion to a wireless connection point of presence (“POP”) 19, the same including at least a base station antenna 15 coupled to a server 17. Server 17 is in turn connected to the wired, or even a wireless (not shown) Internet 21, which may include the World Wide Web.

[0048] Referring to FIG. 2, an first embodiment of WHMA 10 is shown. WHMA 10 includes an HMD 11, which may include an optional monitor screen 40, coupled via an optional adaptor 42 to a WWD 12. WWD 12 connects wirelessly via an antenna 60 to base station 15 (see FIG. 1). One function of WWD 12 is to provide the user interface; other functions are described below.

[0049] As noted above, HMD 11 may include a physiologic sensor 24 or may include a manual system 36 for input of physiologic data via a connection 34. Manual system 36 may also be used to input data directly into WWD 12 via a connection 32. Manual system 36 may include, e.g., a keyboard 30, a mouse 26, a pen-type device 28, and may also employ a separate monitor (not shown). Of course, the user may also view information on monitor 40 or on a screen 41 of WWD 12. In many embodiments, the stylus-based system employed by many current PDA’s, such as the Palm®, may be preferred for such manual data input.

[0050] Data may also be input via entry on a computer 37. This data may then be synchronized to WWD 12 in known fashion. Alternatively, computer 37, or another computer (see computer 37’ in FIG. 4) may be used to connect to a server using the wired internet. This use may be particularly advantageous when entering a large amount of data, such as a patient’s medical history. As noted above, in this way the patient may be afforded a more convenient environment in which to manipulate data to supplement the data input to the WWD.

[0051] It will be clear to one of skill in the art given this teaching that cable 32, as

Docket No. 00125/002005

well as cables 34 and 44, may be replaced with wireless circuitry to communicate signals wirelessly.

[0052] For medical devices and applications, physiologic sensor 24 may include, e.g., a sensor appropriate for measuring blood glucose levels, blood pressure, heart rate, or any other desired parameter as required by the physician. Sensor 24 may connect via an optional cable 44 to subject 38. Alternatively, sensor 24 may be distal of HMD 11, i.e., at or within subject 38. In other words, if cable 44 is employed, sensor 24 may be proximal or distal of cable 44. If a wireless communications capability is added, sensor 24 need not physically connect with HMD 11 or WWD 12 at all. That is, the same may measure a health parameter and may communicate the same to wireless health-monitoring apparatus 10 wirelessly. The short range wireless communications schemes which may be employed include infrared, radio frequency including Bluetooth or 802.11, or other such schemes.

[0053] As examples of sensor types, to measure blood glucose levels, sensor 24 may be a sensor that accepts a drop of blood, e.g., via a finger-prick. To measure heart rate, sensor 24 may be placed via an adhesive sensor disposed on the chest. Other health monitors may also be employed so long as the measured data may either be transferred to WWD 12, e.g., via optional adaptor 42, described in further detail below, or by being read by a user, e.g., from a display, and manually input to WWD 12. Alternatively, the measured data may be transferred to WWD 12 via wireless communication schemes, such as RF includes Bluetooth® or 802.11, infrared, optical, microwaves, etc., directly from sensor 24 or from HMD 11 as described in greater detail below.

[0054] The user, who may or may not be the same person as subject 38, may input data to WWD 12 from history or experience. For example, in a health or exercise device, if subject 38 consumes a known number of calories, this information may be entered via manual system 36 directly into WWD 12 or into HMD 11. Further, the user, the subject, and the sensor are not necessarily the sole sources of information. Data stored on the server, or on a separate server operated for health management may also be employed to result in a health benefit to subject 38.

[0055] Referring to FIG. 3, WHMA 10 is shown communicating wirelessly with

Docket No. 00125/002005

the Internet. In doing so, WHMA 10 generally sends a wireless signal to a base station 14 (in known fashion) that is connected to a server 18 that is in signal communication (in known fashion) with the internet. Server 18 communicates via a protocol (in known fashion) to Internet 20, which also communicates via a protocol (in known fashion) to a server 22 running an application 62. Server 22 may be accessed (in known fashion) by a client computer 44 through a connection 64.

[0056] As noted, the protocols for data communication are known. However, they currently vary amongst known techniques. The present invention is not limited to any particular protocols, and may be implemented in any languages supported by the WWD and server. Of course, as computing capabilities continue to increase, it is expected that the capabilities of WHMA 10, servers 18 and 22, as well as application 62 and client 44, and other components, will correspondingly increase.

[0057] Application 62 running on server 22 may interact with WHMA 10 in a number of ways. Referring to FIG. 4, WHMA 10 is shown in signal communication with server 22 via a connection 72. Connection 72 schematically represents the wireless Internet connection and intervening pathways. WHMA 10 includes an application that may be viewed as having two components: a base wireless or device application 70 and an application presentation layer or user interface 68. User interface 68 is employed to, e.g., present a menu of options to the user, to allow the user to choose inputs, and to generally operate the device. User interface 68 may vary widely in sophistication, e.g., from a simple data entry field to a full graphical user interface. These applications may accept as inputs data from a sensor 24 as well as from a manual input 36.

[0058] Server 22 has a base server application 62 with which the same calculates or provides a response based at least in part on data from WHMA 10. Application 62 may include an algorithm 63 for analyzing data from the HMD, and either application 62 or algorithm 63 may optionally access data from an external data source 74 and may further consult an artificial intelligence system 76.

[0059] External data source 74 may be a memory or disk or other such storage

Docket No. 00125/002005

that stores health data, such as healthy and unhealthy weight/height ranges, healthy and unhealthy cholesterol counts, the patient's or subject's prior medical or health history, healthy and unhealthy blood pressure values, information corresponding to the caloric and other nutritional content of foods, information corresponding to the caloric expenditure values of various exercises, algorithms for calculating various health parameters, etc. In general, any data that may benefit the health of a subject or patient may be stored in external data source 74. External data source 74 may also include online access of health information from external web sites, ftp servers, or other sources.

**[0060]** Due to the current relatively small amount of memory and storage available on current WWDs, such external application processing as by application 62 and external data storage as by external data 74 may be particularly important.

**[0061]** As noted, application 62 or algorithm 63 may also consult AI system 76 for suggestions as to health benefits. AI system 76 may even interact with external data source 74 to extract useful information from the same. AI system 76 may employ, e.g., case-based reasoning, rules-based systems, collaborative filtering, neural networks, expert systems, or other such systems as are known.

**[0062]** It should also be noted that each of application 62, algorithm 63, external data source 74, or AI system 76, may physically reside on more than one server, e.g., on an array of servers for, e.g., storage or multiple processing purposes. Each of application 62, algorithm 63, external data source 74, or AI system 76, or combinations of each, may also respectively reside on different servers.

**[0063]** The extent to which server application 62 interacts with wireless application 70 depends on the use to which the system is put. For example, in a less interactive embodiment, device application 70 may act to measure a diabetic patient's blood glucose level and report the same to server application 62. In this case, a physician may simply review the measured value and send the patient an email reporting that the value is acceptable or not. In a highly interactive embodiment, a patient may have numerous HMDs 11 connected via optional adaptors to a WWD 12, and wireless application 70 may correspondingly send a large amount of health data to server application 62. The physician,

Docket No. 00125/002005

accessing server application 62, may in turn send detailed care plans to a caregiver via connection 72. The received data may be analyzed using algorithm 63, external data source 74, and AI system 76. In this sense, the two applications may be highly interactive.

**[0064]** It is noted that an Application Service Provider (ASP) may operate application 62. That is, application 62 may be leased by an ASP to the health care provider, and the ASP may perform all necessary upgrades and maintenance to application 62 and its associated components.

**[0065]** To initialize the system, the program starts and a wireless application is loaded into the WWD. The loading of the wireless application may occur via synchronization from a desktop or via downloading from a server over the internet. The server application may be loaded into an appropriate internet-connected server. Subject data may be loaded into the WWD or into the server. In the latter case, the subject information may later be transferred to the WWD or transferred to the server from the WWD, as called for by the application. The initialization scheme then ends.

**[0066]** The wireless application may access the server and server application, or vice-versa, as determined by the respective program instructions. Examples are now given for (1) a system of disease and patient management and (2) a system for health management employing an exercise machine.

#### EXAMPLE EMPLOYING SYSTEM FOR DISEASE MANAGEMENT

**[0067]** Referring to FIG. 5, an example is given for a system of disease and patient management. In this figure, as well as in FIG. 6, boxes in dotted lines may generally be considered optional.

**[0068]** In FIG. 5, a medical device may determine health parameters and an optional physician review is provided. Health parameters may also be determined by user manual input.

**[0069]** The program is started (step 142) and a sensor measures a health parameter (step 116). The sensor may send the parameter to a medical device (step 118). The medical device then sends the parameter to the WWD (step 120). The WWD then wirelessly



Docket No. 00125/002005

communicates the parameter to the application server (step 122), e.g., via the wireless web. The application server processes the parameter (step 124), and calculates or provides a response (step 126) based at least in part on the parameter. The application server may optionally employ algorithm 63 (step 125), external data (step 132) or an AI system (step 134) in the calculation. The application server then sends the response to the WWD (step 128), where the response is displayed (step 130).

[0070] It should be noted that the term “response” here is used generally may simply be an acknowledgement that the parameter was received by the application server. The term “calculate” is also used generally, and may entail a simple calculation as well as a complex one. A result may, e.g., be the result of a calculation.

[0071] As noted above, the sensor may connect to any type of medical device or other such device in which information pertaining to a patient’s disease or condition may be ascertained. The parameter may be any value corresponding to such information.

[0072] The method may also use a manual input as shown. In this case, after the start (step 142) of the application, the user may interact with the WWD (step 140). The interact may be a data input, a command to read data from a medical device, a response to a physician question or statement, an acknowledgement of physician notification, etc. Calculations by the application server may further take into account supplemental data sent by the user to the server, e.g., in a wired fashion directly over the internet (step 141).

[0073] FIG. 5 also shows a physician review and notification. In this option, the responses are displayed on a client computer (step 136) in signal communication with the application server. A physician may then review the response on the client computer, and notify the patient of the responses (step 138). For example, the physician may notify the patient of positive or negative responses. Of course, it should be noted that the “client computer” may simply be a pager, PDA, WWD, or other such device, as well as a more typical desktop or laptop computer.

[0074] In one implementation, a diabetic may keep a database on a server of a dietary history and a blood glucose history. With this data at-hand wirelessly, the diabetic may choose whether to eat a particular food by entering nutritional information about the

Docket No. 00125/002005

food into a WWD, transmitting the same wirelessly to the server, and receiving a recommendation from the server. The recommendation may be based on the food and also on data or information that had previously been transmitted wirelessly, including data from a blood glucose monitor, data input manually, if any, as well as data from algorithm 63, external data source 74, and AI system 76.

#### EXAMPLE EMPLOYING SYSTEM FOR HEALTH MANAGEMENT USING A GENERAL EXERCISE MACHINE

[0075] Referring to FIG. 6, an example is given for a system of health, nutrition, and/or exercise management. In this example, the HMD is an exercise machine as that termed has been defined above.

[0076] The program is started (step 242) and a sensor measures a health parameter (step 216), where the health parameter corresponds to health, fitness, nutrition, exercise, etc. The sensor may send the parameter to the exercise machine (step 218). It is understood here that the “sensor” may be, e.g., a blood pressure monitor, but may also be a simple device connected to an aerobic exerciser that tracks miles ran, work performed, etc.

[0077] The exercise machine then sends the parameter to the WWD (step 220). The WWD wirelessly communicates the parameter to the application server (step 222), e.g., via the wireless web.

[0078] An alternative and complementary way of entering the parameter is by user input (step 248). For example, the user may enter the parameter into the exercise machine or into the WWD. This parameter may correspond to an amount of exercise performed, an amount of food consumed, etc.

[0079] Calculations by the application server may also take into account supplemental data sent by the user to the server, e.g., in a wired fashion directly over the internet (step 241).

[0080] The application server processes the parameter (step 224 and optionally step 225), and calculates a response (step 226) based at least in part on the parameter. The application server may optionally employ external data (step 232) or an AI system (step 234)

Docket No. 00125/002005

in the calculation. The application server then sends the response to the WWD (step 228), where the response is displayed.

[0081] The same definitional statements regarding the terms “response”, “calculate”, “sensor”, etc., as given before, apply in this embodiment as well.

[0082] As an optional step, a health specialist may notify the patient or subject of the response (step 238) after having the same displayed on their client computer (step 236). The health specialist may be replaced in this example by an application that may also include an algorithm.

#### ADAPTOR HARDWARE

[0083] A description is given below of a particular type of adaptor hardware. As noted above, the adaptor may optionally be used to connect a HMD to a WWD.

[0084] In general, a connection is necessary between a HMD 11 and a WWD. The nature of this connection may vary. For example, the connection may be wired or wireless. For wired systems, the connection may be direct or an adaptor may be employed, either on one or both ends of the direct wired connection, to adapt the signal appropriately. In the same way, for wireless systems, the connection may be direct, if both HMD and WWD employ the same wireless protocol, or an adaptor may be involved to modify the signal of one or both devices. These connections, all of which are encompassed by the present invention, are discussed in more detail below.

[0085] Referring to FIG. 7, an embodiment of the connection is shown. In this figure, a hardware (or “wired”) connection is shown, i.e., an adaptor 168, disposed between a HMD 160 and a WWD 162. In most circumstances, it is assumed that the varieties of HMDs will vary more widely than the varieties of WWDs. Accordingly, HMD 160 will likely have one of a variety of types of connectors for input/output purposes, here shown as a connector 164. Connector 164 mates with a connector 172 of adaptor 168. At another point on adaptor 168 is a connector 172' for connecting to a generic input/output port 164' on WWD 162. A cable 170 is disposed between the two connectors, cable 170 capable of including adaptor circuitry if desired.

Docket No. 00125/002005

[0086] Of course, the use and structure of adaptor 168, between HMD 160 and WWD 162, depends on factors such as the prevalence of an industry standard for such communications. In other words, if the output of HMD 160 is readily acceptable to WWD 162, then the same may be directly connected or may be connected via a simple cable, the same basically extending from pin-to-pin. For example, a standard parallel bus or serial cable may be used if the input/output ports between the HMD and the WWD, which may be, e.g., RS232, are compatible. Otherwise, a suitable adaptor circuit as noted above may be employed. The connection may also be an input such as a disk drive or other media input for input of data, a USB port or phone jack or other such wired input, again employing an adaptor circuit if required.

[0087] It is noted as exemplary that several of the most prevalent PDA's currently employs the Palm® operating system. The same may be connected to the Internet in a wireless fashion using one of several available networks. In one version of a Palm® device, a 10-pin RS-232 serial port is provided. In this version of the Palm®, port 164' can be used to communicate with HMD 160 and connector 164 via the optional adaptor 168 according to the following pin-out:

Pin Name	Function
1 DTR	Data Terminal Ready signal
2 VCC	3.3 Volts
3 RD (in)	Receive data
4 RTS (out)	Request to send
5 TD (out)	Transmit data
6 CTS (in)	Clear to send
7 GP1 (in)	Interrupt line
8 GP2 (in)	modem sync
9	unused unused
10 GND	signal ground

Docket No. 00125/002005

[0088] On the other side of optional adaptor 168, i.e., HMD 160, connector 164 may vary more widely. It is noted that certain exercise machines are equipped with DB9 or DB25 RS232 serial connectors. In this case, the pin-outs are (for a DB25):

Pin	Name	Function
1	-	Protective/shielded ground
2	TD	Transmit Data (a.k.a TxD, Tx)
3	RD	Receive Data (a.k.a RxD, Rx)
4	RTS	Request To Send
5	CTS	Clear To Send
6	DSR	Data Set Ready
7	SGND	Signal Ground
8	CD	Carrier Detect (a.k.a DCD)
		Reserved for data set testing
		Reserved for data set testing
		Unassigned
12	SDCD	Secondary Carrier Detect
13	SCTS	Secondary Clear to send
14	STD	Secondary Transmit Data
15	DB	Transmit Clock (a.k.a TCLK, TxCLK)
16	SRD	Secondary Receive Data
17	DD	Receive Clock (a.k.a. RCLK)
18	LL	Local Loopback
19	SRTS	Secondary Request to Send
20	DTR	Data Terminal Ready
21	RL/SQ	Signal Quality Detector/Remote loopback
22	RI	Ring Indicator (DCE raises when incoming call detected used for auto answer applications)
23	CH/CI	Signal Rate selector
24	DA	Auxiliary Clock (a.k.a. ACLK)

Docket No. 00125/002005

Unassigned

[0089] A connection may simply be made by providing optional adaptor 168 with adaptor circuitry, such as within cable 170 or within a circuit box therein, so as to match up the appropriate or complementary pins.

[0090] In other embodiments, such as for devices connected to proprietary connectors, a less standard and perhaps proprietary pin-out may be required.

[0091] Referring to FIG. 8, an embodiment of a wireless implementation of the WHMA 10 is shown. In FIG. 8, a wireless connection is shown between HMD 160 and WWD 162. HMD 160 may have an integral wireless modulator/demodulator disposed within (not shown). More likely, however, is that HMD 160 has an adaptor 154 connectable thereto which performs these functions. Adaptor 154 may plug into a connector 165 on HMD 160. WWD 162 may have an integral wireless modulator/demodulator (not shown), although an adaptor can also be used in this context. If an adaptor is used, the same may plug into generic input/output port 164'.

[0092] While the device shown in FIG. 8 is described in the context of general wireless communications, various protocols may be employed. For radio frequency communications, protocols such as Bluetooth® or 802.11 may be advantageously employed. Other techniques employing a similar configuration include those employing IR, microwaves, optical techniques including lasers, and so on.

[0093] It should be understood that the above is merely exemplary, and that the form of the adaptor may vary widely between HMDs and WWDs.

[0094] It will be understood that the above description of a “Method and Apparatus for Health and Disease Management Combining Patient Data Monitoring with Wireless Internet Connectivity” has been with respect to particular embodiments of the invention. While this description is fully capable of attaining the objects of the invention, it is understood that the same is merely representative of the broad scope of the invention envisioned, and that numerous variations of the above embodiments may be known or may become known or are obvious or may become obvious to one of ordinary skill in the art, and

Docket No. 00125/002005

these variations are fully within the broad scope of the invention. For example, while certain wireless technologies have been described herein, other such wireless technologies may also be employed. Furthermore, while various types of medical devices have been mentioned, numerous other types may also be used in the embodiments of the invention, including pulse oximeters, syringe drivers, infusion pumps, spirometers, ventilators, anesthesia monitors, and so on. Accordingly, the scope of the invention is to be limited only by the claims appended hereto, and equivalents thereof. In these claims, a reference to an element in the singular is not intended to mean “one and only one” unless explicitly stated. Rather, the same is intended to mean “one or more”. All structural and functional equivalents to the elements of the above-described preferred embodiment that are known or later come to be known to those of ordinary skill in the art are expressly incorporated herein by reference and are intended to be encompassed by the present claims. Moreover, it is not necessary for a device or method to address each and every problem sought to be solved by the present invention, for it to be encompassed by the present claims. Furthermore, no element, component, or method step in the present invention is intended to be dedicated to the public regardless of whether the element, component, or method step is explicitly recited in the claims. No claim element herein is to be construed under the provisions of 35 U.S.C. §§112, 6, unless the element is expressly recited using the phrase “means for”.

Docket No. 00125/002005

What Is Claimed Is:

1. A method for interactive exercise monitoring, the method comprising the steps of:
  - a. coupling a web-enabled wireless phone to a device which provides health-related information;
  - b. rendering a user interface-on the web-enabled wireless phone;
  - c. receiving health-related information in the web-enabled wireless phone, wherein the health-related information includes physiological data and exercise data, and wherein at least one of the physiological data and exercise data is received from the device which provides health-related information;
  - d. sending the health-related information to an internet server via a wireless network;
  - e. receiving a calculated response from a server, the response associated with a calculation performed by the server based on the health-related information; and
  - f. displaying the response.
  
2. The method of claim 1, where the physiological data is received from a physiological monitoring device or from an exercise machine.
  
3. The method of claim 1, where the exercise data is received from an exercise machine or from a physiological monitoring device.
  
4. The method of claim 1, wherein the web-enabled wireless phone receives health-related information over a transmission medium, the transmission medium including: a wired connection, an RS-232 connection, an infrared connection, or a radio frequency connection.



Docket No. 00125/002005

5. The method of claim 1, wherein the receiving health-related information includes receiving data input by a patient.
6. The method of claim 1, wherein the web-enabled wireless phone receives data via an adapter to convert a signal from the device to a suitable input for the wireless phone.
7. The method of claim 1, where the device which provides health-related information is selected from the group consisting of: an electronic scale, a body fat gauge, a biofeedback device, any type of physiological monitoring device, and any type of exercise machine.
8. A computer-readable medium, containing instructions for performing an interactive method of exercise monitoring, the method comprising the steps of:
  - a. displaying a user interface;
  - b. receiving health-related information, wherein the health-related information includes physiological data and exercise data;
  - c. sending the health-related information to an internet server;
  - d. receiving a calculated response from a server, the response associated with a calculation performed by the server based on the health-related information; and
  - e. displaying an indication of the response.
9. The medium of claim 8, wherein the instructions further cause the web-enabled wireless phone to receive data over a transmission medium, the transmission medium including: a wired connection, an RS-232 connection, an infrared connection, or a radio frequency connection.

Docket No. 00125/002005

10. The medium of claim 8, wherein the instructions further cause the web-enabled wireless phone to receive data from a keyboard.
11. The medium of claim 8, wherein the instructions further cause the web-enabled wireless phone to receive the health-related information via an adapter, the adaptor to convert a received data signal to a suitable input for the web-enabled wireless phone.
12. The medium of claim 8, wherein the health-related information is received from a physiological monitoring device which is selected from the group consisting of: an electronic scale, a body fat gauge, a biofeedback device, any physiological monitoring device, and any exercise machine.

#### ABSTRACT

Embodiments of the invention provide a method and apparatus for a wireless health monitoring system for interactively monitoring a disease or health condition of a patient by connecting an internet-enabled wireless web device (“WWD”) to a health monitoring device which may be a medical device or other health related device such as an exercise machine. The WWD may be connected to the health monitoring device directly by a wired connection to a generic input/output port of the WWD using an optional adaptor if necessary. Alternatively, the WWD may be wirelessly connected to the health monitoring device, such as via an infrared or radio frequency connection, including using protocols such as Bluetooth or 802.11. The wireless connection may also employ an adaptor if necessary. The user may also input data to the WWD manually, such as by a keypad, keyboard, stylus, or optionally by voice command.

The health related data is transmitted from the WWD to a server using standard internet protocols. The server calculates a response using a software program which may include an algorithm or artificial intelligence system, and may further provide for review by a physician or health specialist. The user may interact with the server. For example, the server transmits a response to the WWD, and the user may answer the response or provide other information.

Express Mail Label No.

Page 1 of 3

Docket No. 00125/002001
----------------------------

## Declaration and Power of Attorney For Patent Application

### English Language Declaration

As a below named inventor, I hereby declare that:

My residence, post office address and citizenship are as stated below next to my name,

I believe I am the original, first and sole inventor (if only one name is listed below) or an original, first and joint inventor (if plural names are listed below) of the subject matter which is claimed and for which a patent is sought on the invention entitled

**Method and Apparatus for Health and Disease Management Combining Patient Data Monitoring with Wireless Internet Connectivity**

the specification of which

(check one)

is attached hereto.

was filed on December 15, 2000 as United States Application No. or PCT International Application Number 09/738,270 and was amended on \_\_\_\_\_

(if applicable)

I hereby state that I have reviewed and understand the contents of the above identified specification, including the claims, as amended by any amendment referred to above.

I acknowledge the duty to disclose to the United States Patent and Trademark Office all information known to me to be material to patentability as defined in Title 37, Code of Federal Regulations, Section 1.56.

I hereby claim foreign priority benefits under Title 35, United States Code, Section 119(a)-(d) or Section 365(b) of any foreign application(s) for patent or inventor's certificate, or Section 365(a) of any PCT International application which designated at least one country other than the United States, listed below and have also identified below, by checking the box, any foreign application for patent or inventor's certificate or PCT International application having a filing date before that of the application on which priority is claimed.

Prior Foreign Application(s)	Priority Not Claimed		
(Number)	(Country)	(Day/Month/Year Filed)	<input type="checkbox"/>
(Number)	(Country)	(Day/Month/Year Filed)	<input type="checkbox"/>
(Number)	(Country)	(Day/Month/Year Filed)	<input type="checkbox"/>

I hereby claim the benefit under 35 U.S.C. Section 119(e) of any United States provisional application(s) listed below:

60/172,486	12/17/99
(Application Serial No.)	(Filing Date)
_____	_____
(Application Serial No.)	(Filing Date)
_____	_____
(Application Serial No.)	(Filing Date)

I hereby claim the benefit under 35 U. S. C. Section 120 of any United States application(s), or Section 365(c) of any PCT International application designating the United States, listed below and, insofar as the subject matter of each of the claims of this application is not disclosed in the prior United States or PCT International application in the manner provided by the first paragraph of 35 U.S.C. Section 112, I acknowledge the duty to disclose to the United States Patent and Trademark Office all information known to me to be material to patentability as defined in Title 37, C. F. R., Section 1.56 which became available between the filing date of the prior application and the national or PCT International filing date of this application:

(Application Serial No.)	(Filing Date)	(Status) (patented, pending, abandoned)
_____	_____	_____
(Application Serial No.)	(Filing Date)	(Status) (patented, pending, abandoned)
_____	_____	_____
(Application Serial No.)	(Filing Date)	(Status) (patented, pending, abandoned)

I hereby declare that all statements made herein of my own knowledge are true and that all statements made on information and belief are believed to be true; and further that these statements were made with the knowledge that willful false statements and the like so made are punishable by fine or imprisonment, or both, under Section 1001 of Title 18 of the United States Code and that such willful false statements may jeopardize the validity of the application or any patent issued thereon.

POWER OF ATTORNEY: As a named inventor, I hereby appoint the following attorney(s) and/or agent(s) to prosecute this application and transact all business in the Patent and Trademark Office connected therewith. *(list name and registration number)*

Mark D. Wiczorek, Reg. No. 37,966

Send Correspondence to: Mark D. Wiczorek  
5038 Saratoga Ave.  
San Diego, CA 92107

Direct Telephone Calls to: *(name and telephone number)*  
Mark D. Wiczorek, 619/223-7210

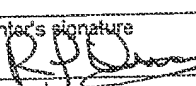
Full name of sole or first inventor	Roger J. Quy	
Sole or first inventor's signature		Date
	12   20   20	
Residence	14 Topside Way, Mill Valley, CA 94941	
Citizenship	Great Britain	
Post Office Address	c/o Technology Partners, 550 University Ave., Palo Alto, CA 94301	

Full name of second inventor, if any	
Second inventor's signature	Date
Residence	
Citizenship	
Post Office Address	

Under the Paperwork Reduction Act of 1995, no persons are required to respond to a collection of information unless it contains a valid OMB control number.

<b>Application Data Sheet 37 CFR 1.76</b>		Attorney Docket Number	00125/002005
		Application Number	
Title of Invention	METHOD AND APPARATUS FOR HEALTH AND DISEASE MANAGEMENT COMBINING PATIENT DATA MONITORING WITH WIRELESS INTERNET CONNECTIVITY		
The application data sheet is part of the provisional or nonprovisional application for which it is being submitted. The following form contains the bibliographic data arranged in a format specified by the United States Patent and Trademark Office as outlined in 37 CFR 1.76. This document may be completed electronically and submitted to the Office in electronic format using the Electronic Filing System (EFS) or the document may be printed and included in a paper filed application.			

### Secrecy Order 37 CFR 5.2

Portions or all of the application associated with this Application Data Sheet may fall under a Secrecy Order pursuant to 37 CFR 5.2 (Paper filers only. Applications that fall under Secrecy Order may not be filed electronically.)

### Applicant Information:

<b>Applicant 1</b>					<input type="button" value="Remove"/>
<b>Applicant Authority</b>		<input checked="" type="radio"/> Inventor		<input type="radio"/> Legal Representative under 35 U.S.C. 117	
				<input type="radio"/> Party of Interest under 35 U.S.C. 118	
<b>Prefix</b>	<b>Given Name</b>	<b>Middle Name</b>	<b>Family Name</b>	<b>Suffix</b>	
	Roger	J.	Quy		
<b>Residence Information (Select One)</b> <input checked="" type="radio"/> US Residency <input type="radio"/> Non US Residency <input type="radio"/> Active US Military Service					
<b>City</b>	Mill Valley	<b>State/Province</b>	CA	<b>Country of Residence i</b>	US
<b>Citizenship under 37 CFR 1.41(b) i</b>		GB			
<b>Mailing Address of Applicant:</b>					
<b>Address 1</b>	14 Topside Way				
<b>Address 2</b>					
<b>City</b>	Mill Valley	<b>State/Province</b>	CA		
<b>Postal Code</b>	94941	<b>Countryi</b>	US		
All Inventors Must Be Listed - Additional Inventor Information blocks may be generated within this form by selecting the <b>Add</b> button.					
					<input type="button" value="Add"/>

### Correspondence Information:

Enter either Customer Number or complete the Correspondence Information section below. For further information see 37 CFR 1.33(a).			
<input type="checkbox"/> An Address is being provided for the correspondence information of this application.			
<b>Customer Number</b>	27774		
<b>Email Address</b>		<input type="button" value="Add Email"/>	<input type="button" value="Remove Email"/>

### Application Information:

<b>Title of the Invention</b>	METHOD AND APPARATUS FOR HEALTH AND DISEASE MANAGEMENT COMBINING PATIENT DATA MONITORING WITH WIRELESS INTERNET CONNECTIVITY		
<b>Attorney Docket Number</b>	00125/002005	<b>Small Entity Status Claimed</b> <input type="checkbox"/>	
<b>Application Type</b>	Nonprovisional		
<b>Subject Matter</b>	Utility		
<b>Suggested Class (if any)</b>		<b>Sub Class (if any)</b>	
<b>Suggested Technology Center (if any)</b>			
<b>Total Number of Drawing Sheets (if any)</b>	8	<b>Suggested Figure for Publication (if any)</b>	1

Under the Paperwork Reduction Act of 1995, no persons are required to respond to a collection of information unless it contains a valid OMB control number.

<b>Application Data Sheet 37 CFR 1.76</b>	Attorney Docket Number	00125/002005
	Application Number	
Title of Invention	METHOD AND APPARATUS FOR HEALTH AND DISEASE MANAGEMENT COMBINING PATIENT DATA MONITORING WITH WIRELESS INTERNET CONNECTIVITY	

**Publication Information:**

Request Early Publication (Fee required at time of Request 37 CFR 1.219)

**Request Not to Publish.** I hereby request that the attached application not be published under 35 U.S.C. 122(b) and certify that the invention disclosed in the attached application has not and will not be the subject of an application filed in another country, or under a multilateral international agreement, that requires publication at eighteen months after filing.

**Representative Information:**

Representative information should be provided for all practitioners having a power of attorney in the application. Providing this information in the Application Data Sheet does not constitute a power of attorney in the application (see 37 CFR 1.32). Enter either Customer Number or complete the Representative Name section below. If both sections are completed the Customer Number will be used for the Representative Information during processing.

Please Select One:  Customer Number  US Patent Practitioner  Limited Recognition (37 CFR 11.9)

Customer Number: 27774

**Domestic Benefit/National Stage Information:**

This section allows for the applicant to either claim benefit under 35 U.S.C. 119(e), 120, 121, or 365(c) or indicate National Stage entry from a PCT application. Providing this information in the application data sheet constitutes the specific reference required by 35 U.S.C. 119(e) or 120, and 37 CFR 1.78(a)(2) or CFR 1.78(a)(4), and need not otherwise be made part of the specification.

Prior Application Status	Pending	<a href="#">Remove</a>	
Application Number	Continuity Type	Prior Application Number	Filing Date (YYYY-MM-DD)
	Continuation of	11649703	2007-01-03

Additional Domestic Benefit/National Stage Data may be generated within this form by selecting the [Add](#) button.

**Foreign Priority Information:**

This section allows for the applicant to claim benefit of foreign priority and to identify any prior foreign application for which priority is not claimed. Providing this information in the application data sheet constitutes the claim for priority as required by 35 U.S.C. 119(b) and 37 CFR 1.55(a).

<a href="#">Remove</a>			
Application Number	Country <sup>i</sup>	Parent Filing Date (YYYY-MM-DD)	Priority Claimed
			<input type="radio"/> Yes <input checked="" type="radio"/> No

Additional Foreign Priority Data may be generated within this form by selecting the [Add](#) button.

**Assignee Information:**

Providing this information in the application data sheet does not substitute for compliance with any requirement of part 3 of Title 37 of the CFR to have an assignment recorded in the Office.

Assignee 1	<a href="#">Remove</a>
------------	------------------------



Under the Paperwork Reduction Act of 1995, no persons are required to respond to a collection of information unless it contains a valid OMB control number.

<b>Application Data Sheet 37 CFR 1.76</b>		Attorney Docket Number	00125/002005	
		Application Number		
Title of Invention	METHOD AND APPARATUS FOR HEALTH AND DISEASE MANAGEMENT COMBINING PATIENT DATA MONITORING WITH WIRELESS INTERNET CONNECTIVITY			

If the Assignee is an Organization check here. <input type="checkbox"/>				
Prefix	Given Name	Middle Name	Family Name	Suffix
<b>Mailing Address Information:</b>				
Address 1				
Address 2				
City		State/Province		
Country	US		Postal Code	
Phone Number		Fax Number		
Email Address				
Additional Assignee Data may be generated within this form by selecting the Add button.				<input type="button" value="Add"/>

**Signature:**

A signature of the applicant or representative is required in accordance with 37 CFR 1.33 and 10.18. Please see 37 CFR 1.4(d) for the form of the signature.					
Signature	/Mark Wieczorek/		Date (YYYY-MM-DD)	2008-09-15	
First Name	Mark D.	Last Name	Wieczorek	Registration Number	37966

This collection of information is required by 37 CFR 1.76. The information is required to obtain or retain a benefit by the public which is to file (and by the USPTO to process) an application. Confidentiality is governed by 35 U.S.C. 122 and 37 CFR 1.14. This collection is estimated to take 23 minutes to complete, including gathering, preparing, and submitting the completed application data sheet form to the USPTO. Time will vary depending upon the individual case. Any comments on the amount of time you require to complete this form and/or suggestions for reducing this burden, should be sent to the Chief Information Officer, U.S. Patent and Trademark Office, U.S. Department of Commerce, P.O. Box 1450, Alexandria, VA 22313-1450. DO NOT SEND FEES OR COMPLETED FORMS TO THIS ADDRESS. **SEND TO: Commissioner for Patents, P.O. Box 1450, Alexandria, VA 22313-1450.**

## Privacy Act Statement

The Privacy Act of 1974 (P.L. 93-579) requires that you be given certain information in connection with your submission of the attached form related to a patent application or patent. Accordingly, pursuant to the requirements of the Act, please be advised that: (1) the general authority for the collection of this information is 35 U.S.C. 2(b)(2); (2) furnishing of the information solicited is voluntary; and (3) the principal purpose for which the information is used by the U.S. Patent and Trademark Office is to process and/or examine your submission related to a patent application or patent. If you do not furnish the requested information, the U.S. Patent and Trademark Office may not be able to process and/or examine your submission, which may result in termination of proceedings or abandonment of the application or expiration of the patent.

The information provided by you in this form will be subject to the following routine uses:

1. The information on this form will be treated confidentially to the extent allowed under the Freedom of Information Act (5 U.S.C. 552) and the Privacy Act (5 U.S.C. 552a). Records from this system of records may be disclosed to the Department of Justice to determine whether the Freedom of Information Act requires disclosure of these records.
2. A record from this system of records may be disclosed, as a routine use, in the course of presenting evidence to a court, magistrate, or administrative tribunal, including disclosures to opposing counsel in the course of settlement negotiations.
3. A record in this system of records may be disclosed, as a routine use, to a Member of Congress submitting a request involving an individual, to whom the record pertains, when the individual has requested assistance from the Member with respect to the subject matter of the record.
4. A record in this system of records may be disclosed, as a routine use, to a contractor of the Agency having need for the information in order to perform a contract. Recipients of information shall be required to comply with the requirements of the Privacy Act of 1974, as amended, pursuant to 5 U.S.C. 552a(m).
5. A record related to an International Application filed under the Patent Cooperation Treaty in this system of records may be disclosed, as a routine use, to the International Bureau of the World Intellectual Property Organization, pursuant to the Patent Cooperation Treaty.
6. A record in this system of records may be disclosed, as a routine use, to another federal agency for purposes of National Security review (35 U.S.C. 181) and for review pursuant to the Atomic Energy Act (42 U.S.C. 218(c)).
7. A record from this system of records may be disclosed, as a routine use, to the Administrator, General Services, or his/her designee, during an inspection of records conducted by GSA as part of that agency's responsibility to recommend improvements in records management practices and programs, under authority of 44 U.S.C. 2904 and 2906. Such disclosure shall be made in accordance with the GSA regulations governing inspection of records for this purpose, and any other relevant (i.e., GSA or Commerce) directive. Such disclosure shall not be used to make determinations about individuals.
8. A record from this system of records may be disclosed, as a routine use, to the public after either publication of the application pursuant to 35 U.S.C. 122(b) or issuance of a patent pursuant to 35 U.S.C. 151. Further, a record may be disclosed, subject to the limitations of 37 CFR 1.14, as a routine use, to the public if the record was filed in an application which became abandoned or in which the proceedings were terminated and which application is referenced by either a published application, an application open to public inspections or an issued patent.
9. A record from this system of records may be disclosed, as a routine use, to a Federal, State, or local law enforcement agency, if the USPTO becomes aware of a violation or potential violation of law or regulation.

## Electronic Patent Application Fee Transmittal

<b>Application Number:</b>				
<b>Filing Date:</b>				
<b>Title of Invention:</b>	METHOD AND APPARATUS FOR HEALTH AND DISEASE MANAGEMENT COMBINING PATIENT DATA MONITORING WITH WIRELESS INTERNET CONNECTIVITY			
<b>First Named Inventor/Applicant Name:</b>	Roger J. Quy			
<b>Filer:</b>	Mark K. Young/Marjorie Scariati			
<b>Attorney Docket Number:</b>	00125/002005			
Filed as Large Entity				
<b>Utility under 35 USC 111(a) Filing Fees</b>				
<b>Description</b>	<b>Fee Code</b>	<b>Quantity</b>	<b>Amount</b>	<b>Sub-Total in USD(\$)</b>
<b>Basic Filing:</b>				
Utility application filing	1011	1	310	310
Utility Search Fee	1111	1	510	510
Utility Examination Fee	1311	1	210	210
<b>Pages:</b>				
<b>Claims:</b>				
<b>Miscellaneous-Filing:</b>				
<b>Petition:</b>				
<b>Patent-Appeals-and-Interference:</b>				

Description	Fee Code	Quantity	Amount	Sub-Total in USD(\$)
<b>Post-Allowance-and-Post-Issuance:</b>				
<b>Extension-of-Time:</b>				
<b>Miscellaneous:</b>				
<b>Total in USD (\$)</b>				<b>1030</b>

**Electronic Acknowledgement Receipt**

<b>EFS ID:</b>	3946803
<b>Application Number:</b>	12211033
<b>International Application Number:</b>	
<b>Confirmation Number:</b>	7693
<b>Title of Invention:</b>	METHOD AND APPARATUS FOR HEALTH AND DISEASE MANAGEMENT COMBINING PATIENT DATA MONITORING WITH WIRELESS INTERNET CONNECTIVITY
<b>First Named Inventor/Applicant Name:</b>	Roger J. Quy
<b>Customer Number:</b>	27774
<b>Filer:</b>	Mark K. Young/Marjorie Scariati
<b>Filer Authorized By:</b>	Mark K. Young
<b>Attorney Docket Number:</b>	00125/002005
<b>Receipt Date:</b>	15-SEP-2008
<b>Filing Date:</b>	
<b>Time Stamp:</b>	21:02:57
<b>Application Type:</b>	Utility under 35 USC 111(a)

**Payment information:**

Submitted with Payment	no
------------------------	----

**File Listing:**

Document Number	Document Description	File Name	File Size(Bytes)/ Message Digest	Multi Part /.zip	Pages (if appl.)
1		00125_002005_spec.pdf	188603 7315db66f90142e5cf2a4b24750b248f4cbd5e56	yes	25

## Multipart Description/PDF files in .zip description

Multipart Description/PDF files in .zip description					
Document Description			Start	End	
Specification			1	21	
Claims			22	24	
Abstract			25	25	
<b>Warnings:</b>					
<b>Information:</b>					
2	Drawings-only black and white line drawings	00125_002005_figs.pdf	431238	no	8
			6a6844a8f2027cc702b528934d75f5ef06e8ea90		
<b>Warnings:</b>					
<b>Information:</b>					
3	Oath or Declaration filed	00125_002005_Dec.pdf	128288	no	3
			b57acfe1f1198d625e6b1e6c4fa6626ca8984c087		
<b>Warnings:</b>					
<b>Information:</b>					
4	Application Data Sheet	00125_002005_ADS.pdf	968059	no	4
			df4ab926efbd16c6984d92ae7d734254b4a53799		
<b>Warnings:</b>					
<b>Information:</b>					
5	Fee Worksheet (PTO-06)	fee-info.pdf	33152	no	2
			634c8d2b2f9b8400c5aac9a59c5f7b6d52cc915e		
<b>Warnings:</b>					
<b>Information:</b>					
<b>Total Files Size (in bytes):</b>			1749340		

This Acknowledgement Receipt evidences receipt on the noted date by the USPTO of the indicated documents, characterized by the applicant, and including page counts, where applicable. It serves as evidence of receipt similar to a Post Card, as described in MPEP 503.

**New Applications Under 35 U.S.C. 111**

If a new application is being filed and the application includes the necessary components for a filing date (see 37 CFR 1.53(b)-(d) and MPEP 506), a Filing Receipt (37 CFR 1.54) will be issued in due course and the date shown on this Acknowledgement Receipt will establish the filing date of the application.

**National Stage of an International Application under 35 U.S.C. 371**

If a timely submission to enter the national stage of an international application is compliant with the conditions of 35 U.S.C. 371 and other applicable requirements a Form PCT/DO/EO/903 indicating acceptance of the application as a national stage submission under 35 U.S.C. 371 will be issued in addition to the Filing Receipt, in due course.

**New International Application Filed with the USPTO as a Receiving Office**

If a new international application is being filed and the international application includes the necessary components for an international filing date (see PCT Article 11 and MPEP 1810), a Notification of the International Application Number and of the International Filing Date (Form PCT/RO/105) will be issued in due course, subject to prescriptions concerning national security, and the date shown on this Acknowledgement Receipt will establish the international filing date of the application.

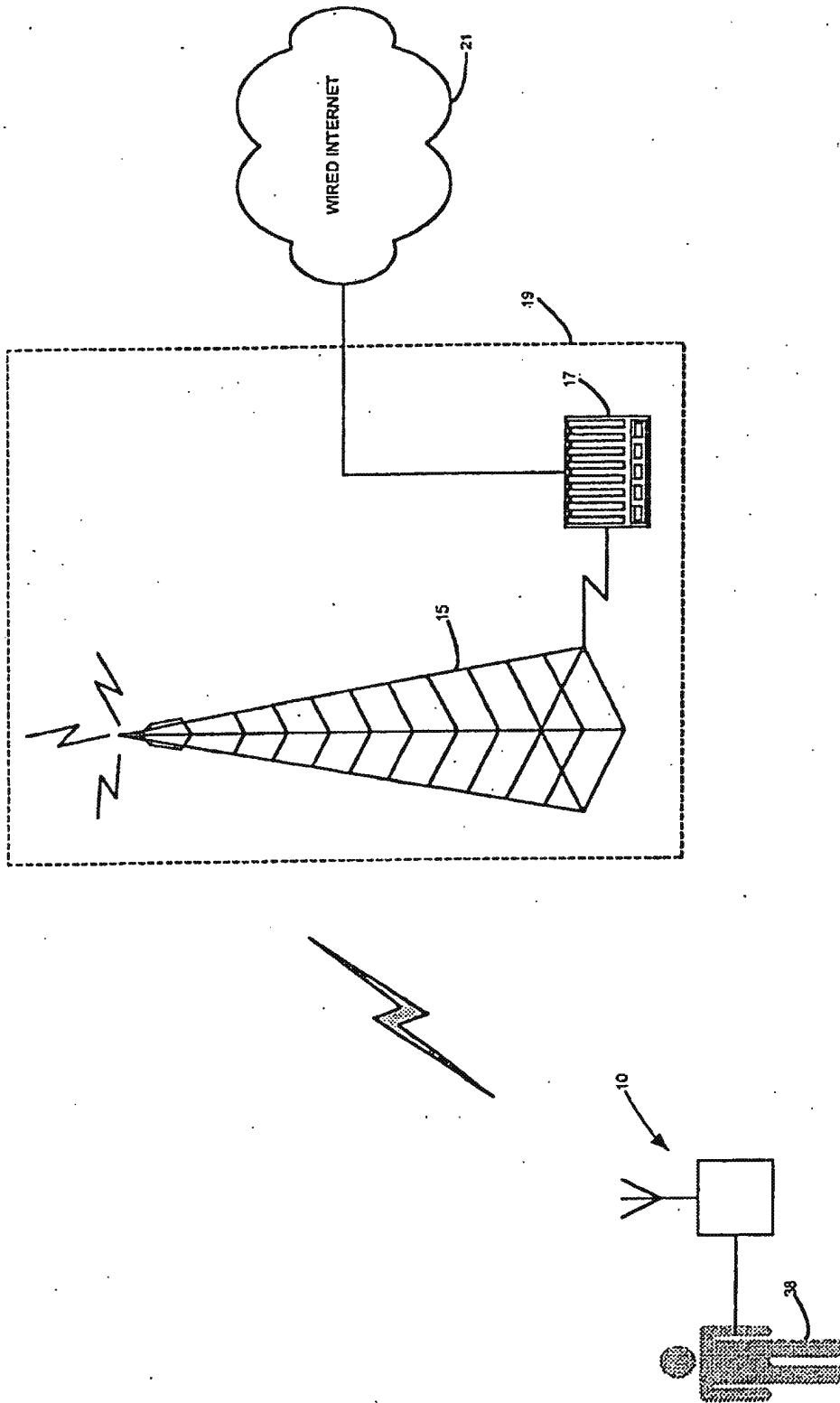

FIG. 1



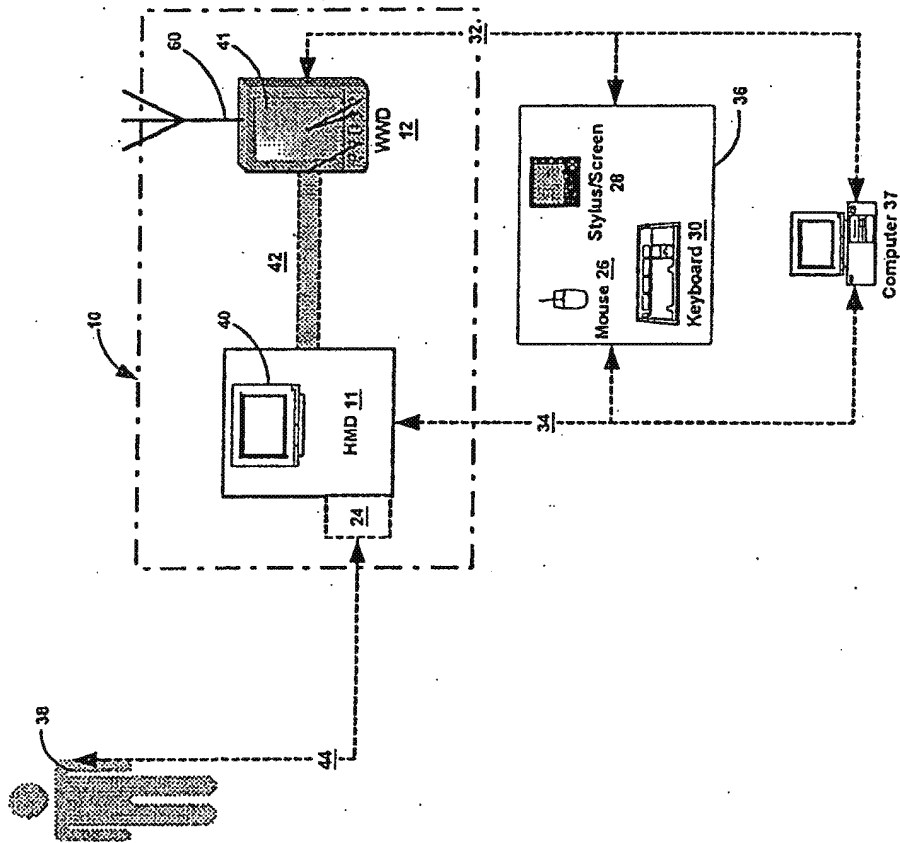

FIG. 2

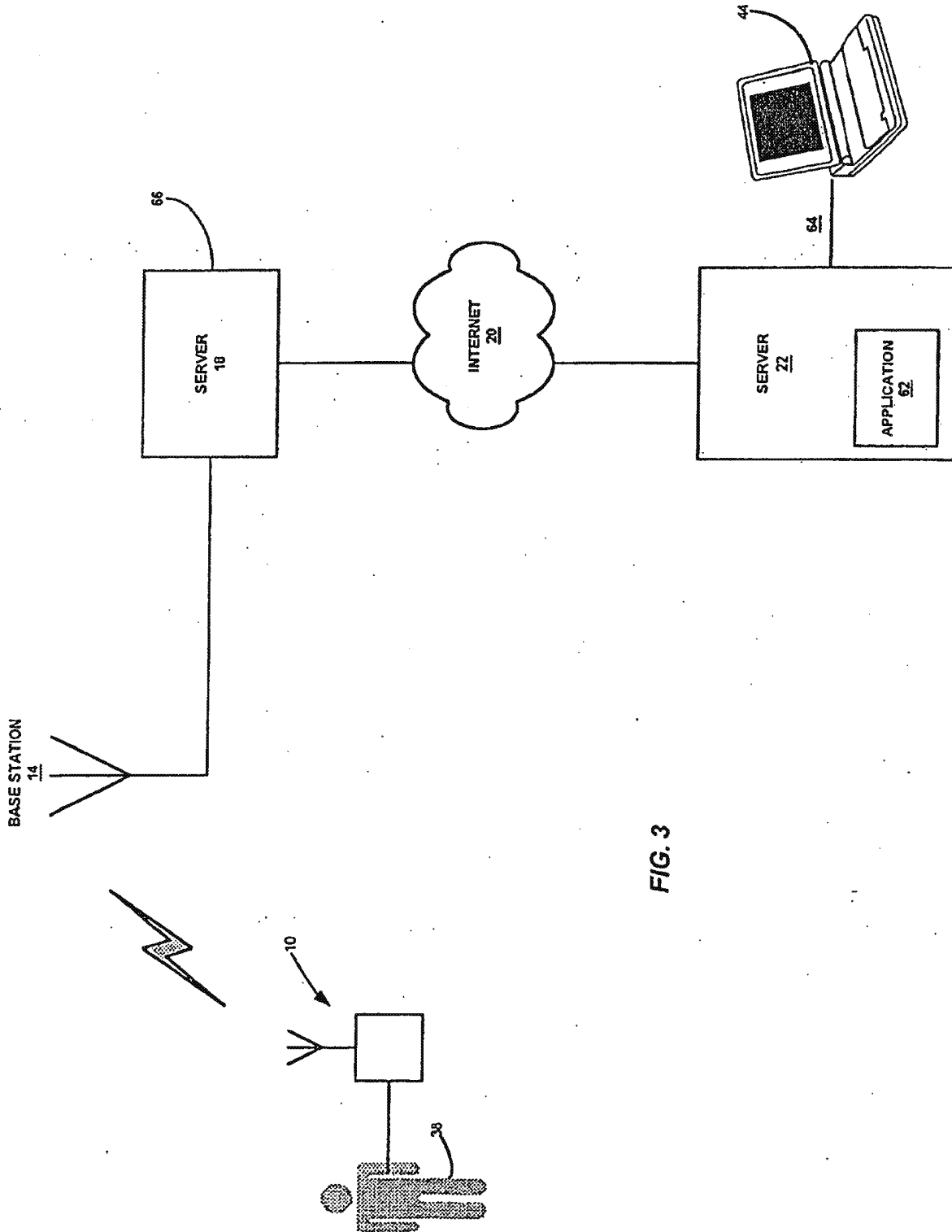

FIG. 3

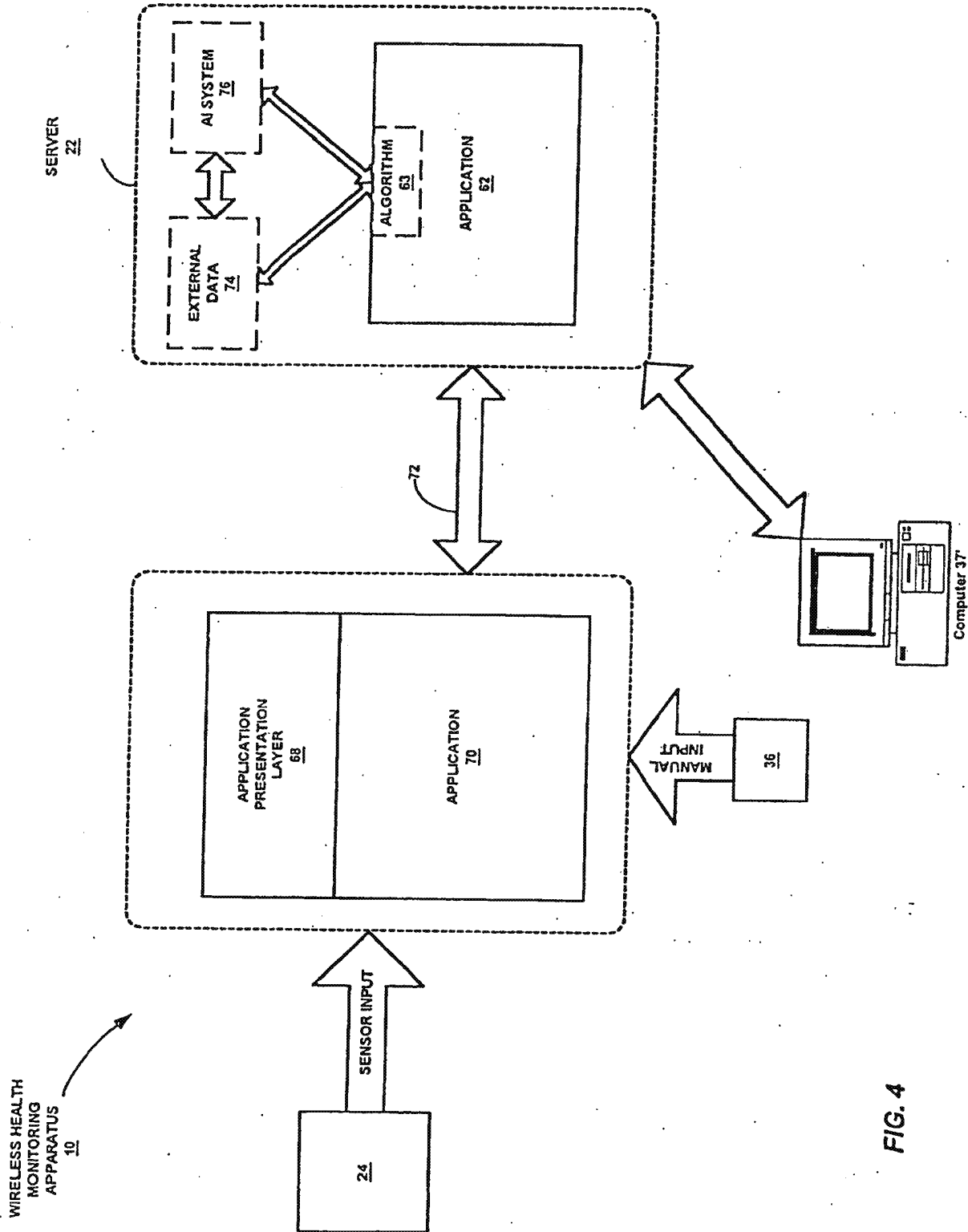

FIG. 4

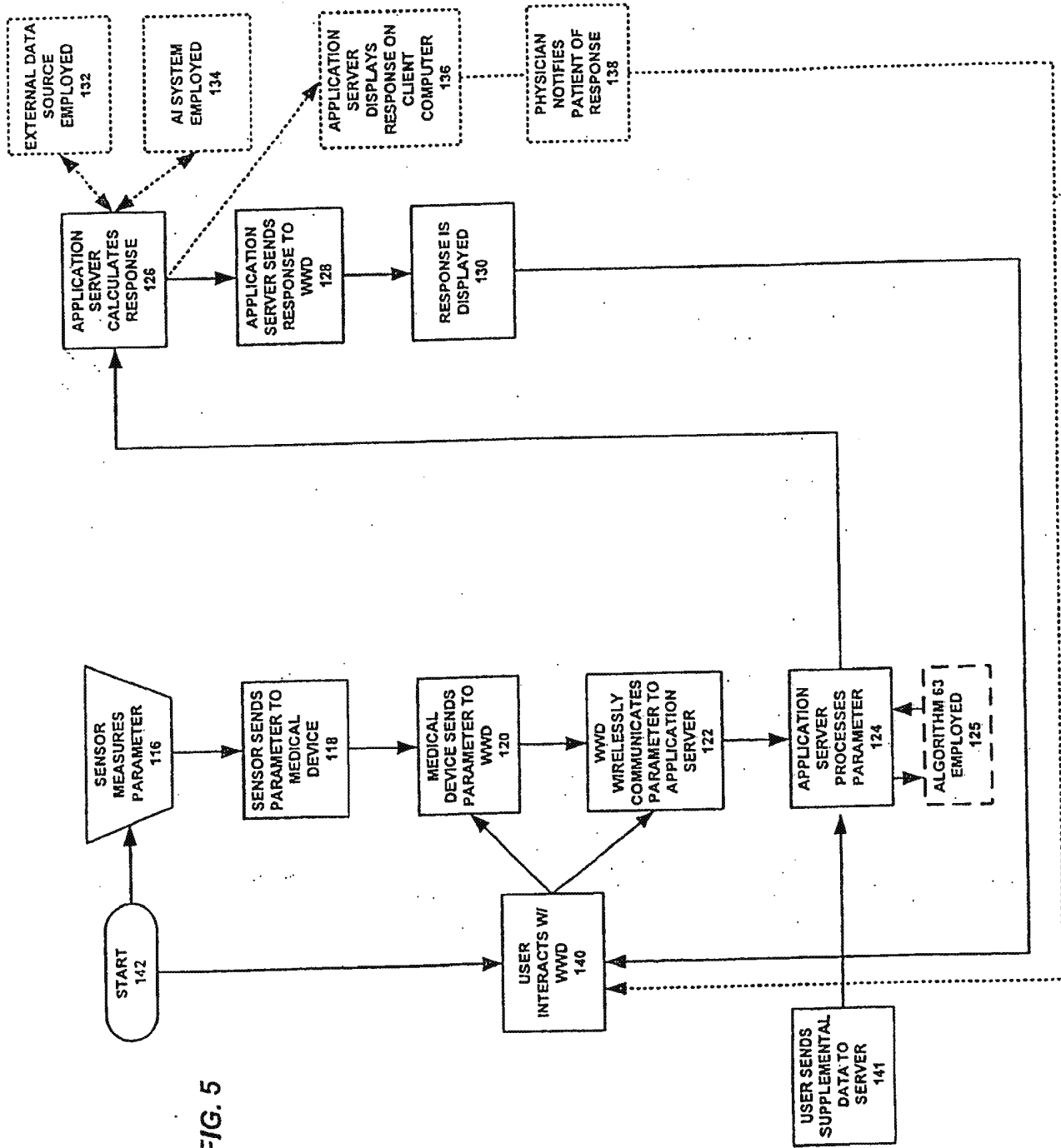

FIG. 5

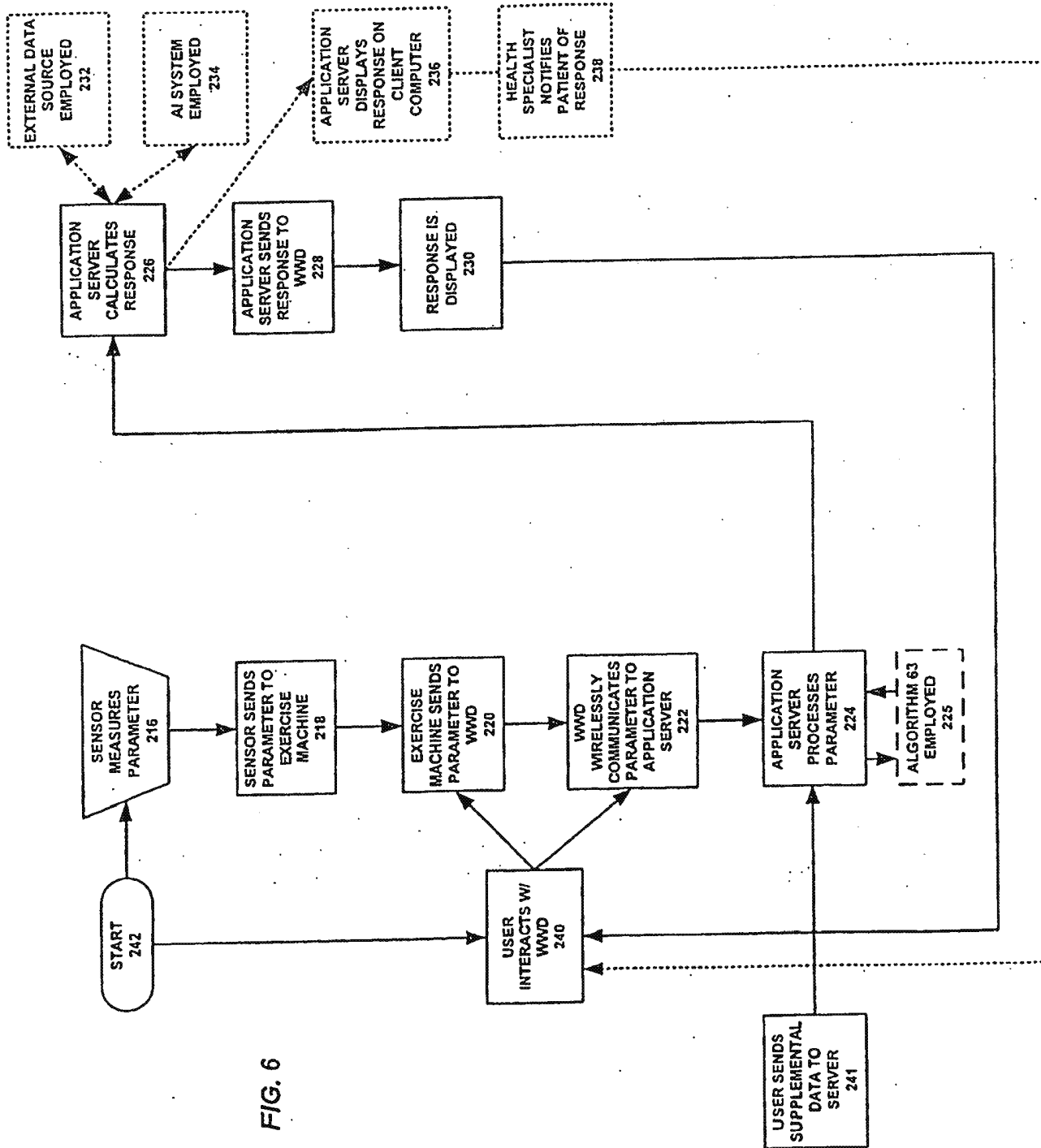

FIG. 6

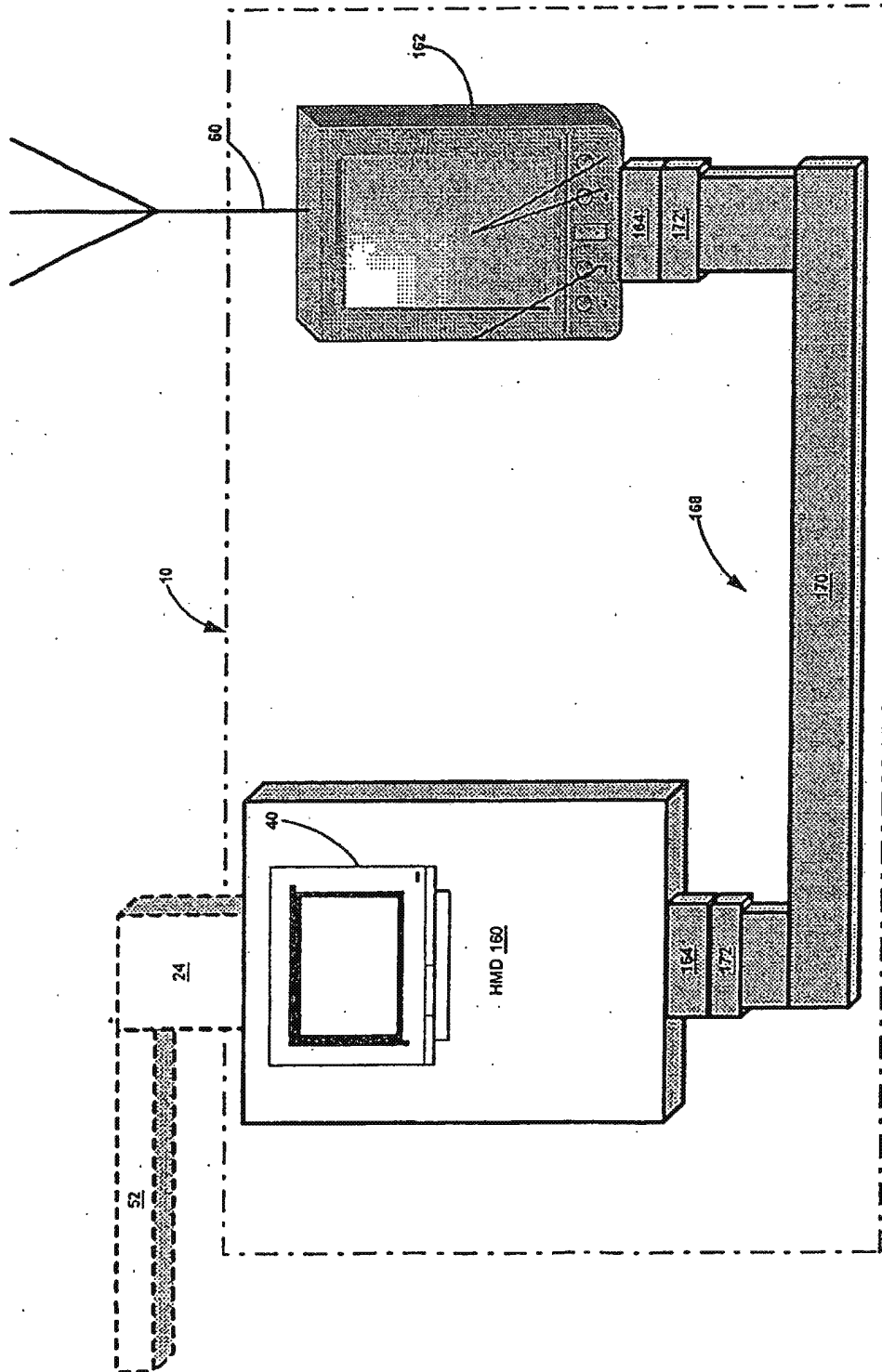

FIG. 7

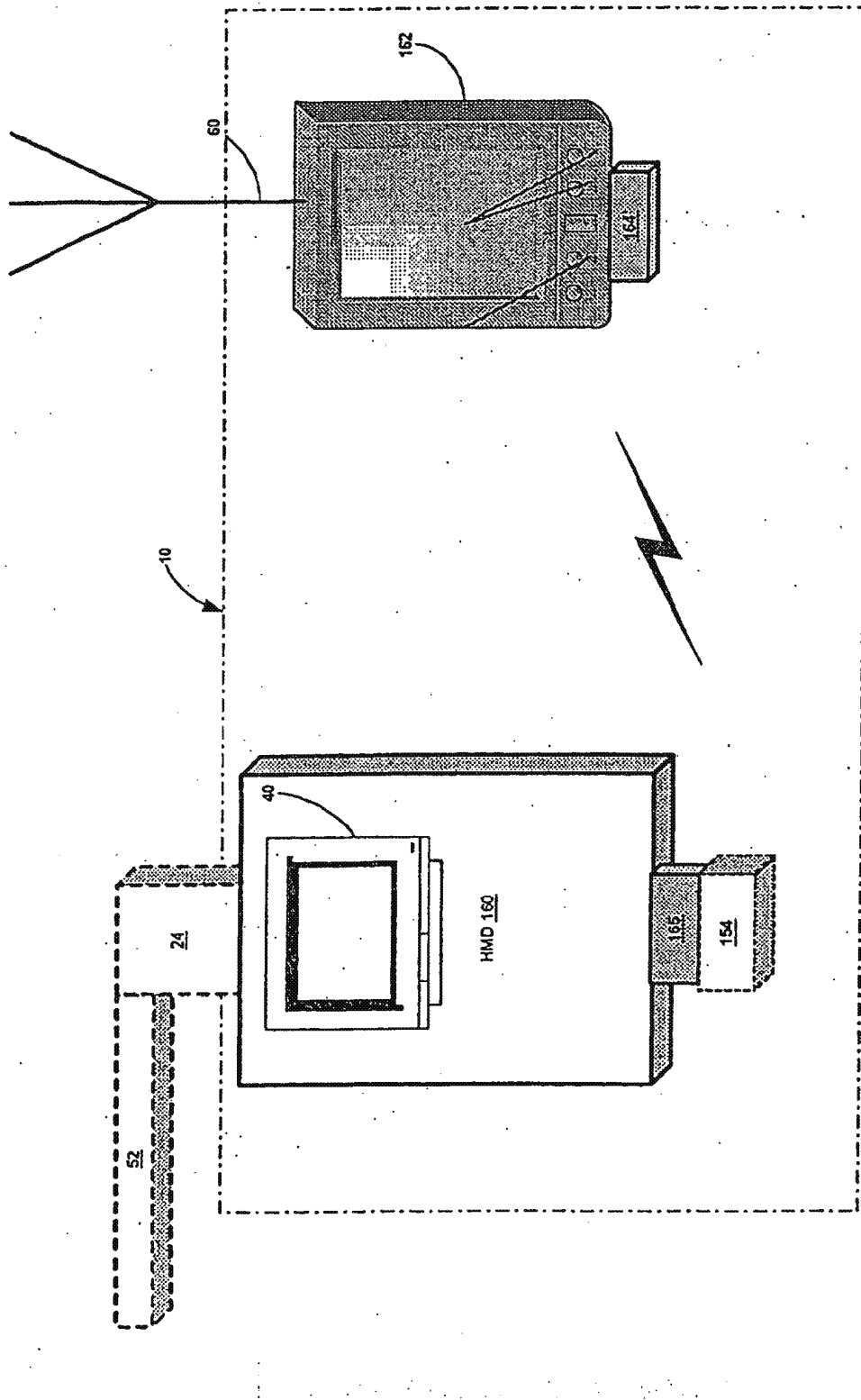

FIG. 8

DocCode - SCORE

## SCORE Placeholder Sheet for IFW Content

Application Number: 12211033 Document Date: 9/15/2008

The presence of this form in the IFW record indicates that the following document type was received in paper and is scanned and stored in the SCORE database.

- Design Drawings

The original paper documents are in the physical artifact folder. The original documents are scanned using a higher quality capture process and stored in SCORE. A copy of these documents are scanned in IFW using the standard quality scanning process. Defects visible in both IFW and SCORE are indicative of defects in the original paper documents.

To access the documents in the SCORE database, refer to instructions developed by SIRA.

At the time of document entry (noted above):

- Examiners may access SCORE content via the eDAN interface.
- Other USPTO employees can bookmark the current SCORE URL (<http://es/ScoreAccessWeb/>).
- External customers may access SCORE content via the Public and Private PAIR interfaces.

Form Revision Date: October 12, 2006



Filing Date: 09/15/08

Approved for use through 7/31/2006. OMB 0651-0032

U.S. Patent and Trademark Office; U.S. DEPARTMENT OF COMMERCE

Under the Paperwork Reduction Act of 1995, no persons are required to respond to a collection of information unless it displays a valid OMB control number.

PATENT APPLICATION FEE DETERMINATION RECORD					Application or Docket Number	
Substitute for Form PTO-875					12/211,033	
<b>APPLICATION AS FILED – PART I</b>						
(Column 1)		(Column 2)			SMALL ENTITY	
OR					OTHER THAN SMALL ENTITY	
FOR	NUMBER FILED	NUMBER EXTRA			RATE (\$)	FEE (\$)
BASIC FEE (37 CFR 1.16(a), (b), or (c))	N/A	N/A			N/A	N/A
SEARCH FEE (37 CFR 1.16(k), (l), or (m))	N/A	N/A			N/A	310
EXAMINATION FEE (37 CFR 1.16(o), (p), or (q))	N/A	N/A			N/A	510
TOTAL CLAIMS (37 CFR 1.16(i))	12	minus 20 =			X\$ 25	X\$50
INDEPENDENT CLAIMS (37 CFR 1.16(h))	2	minus 3 = *			X\$105	X\$210
APPLICATION SIZE FEE (37 CFR 1.16(s))	If the specification and drawings exceed 100 sheets of paper, the application size fee due is \$260 (\$130 for small entity) for each additional 50 sheets or fraction thereof. See 35 U.S.C. 41(a)(1)(G) and 37 CFR					
MULTIPLE DEPENDENT CLAIM PRESENT (37 CFR 1.16(j))						
					185	370
					TOTAL	TOTAL 1030
* If the difference in column 1 is less than zero, enter "0" in column 2.						
<b>APPLICATION AS AMENDED – PART II</b>						
(Column 1)		(Column 2)		(Column 3)		
OR				SMALL ENTITY		
OR				OTHER THAN SMALL ENTITY		
AMENDMENT A	CLAIMS REMAINING AFTER AMENDMENT	HIGHEST NUMBER PREVIOUSLY PAID FOR	PRESENT EXTRA			
	Total (37 CFR 1.16(i))	*	Minus **	=		
	Independent (37 CFR 1.16(h))	*	Minus ***	=		
	Application Size Fee (37 CFR 1.16(s))					
	FIRST PRESENTATION OF MULTIPLE DEPENDENT CLAIM (37 CFR 1.16(j))					
				RATE (\$)	ADDITIONAL FEE (\$)	
				X =		
				X =		
				N/A		
				TOTAL	TOTAL	
				ADD'T FEE	ADD'T FEE	
(Column 1)		(Column 2)		(Column 3)		
OR				SMALL ENTITY		
OR				OTHER THAN SMALL ENTITY		
AMENDMENT B	CLAIMS REMAINING AFTER AMENDMENT	HIGHEST NUMBER PREVIOUSLY PAID FOR	PRESENT EXTRA			
	Total (37 CFR 1.16(i))	*	Minus **	=		
	Independent (37 CFR 1.16(h))	*	Minus ***	=		
	Application Size Fee (37 CFR 1.16(s))					
	FIRST PRESENTATION OF MULTIPLE DEPENDENT CLAIM (37 CFR 1.16(j))					
				RATE (\$)	ADDITIONAL FEE (\$)	
				X =		
				X =		
				N/A		
				TOTAL	TOTAL	
				ADD'T FEE	ADD'T FEE	
* If the entry in column 1 is less than the entry in column 2, write "0" in column 3.						
** If the "Highest Number Previously Paid For" IN THIS SPACE is less than 20, enter "20".						
*** If the "Highest Number Previously Paid For" IN THIS SPACE is less than 3, enter "3".						
The "Highest Number Previously Paid For" (Total or Independent) is the highest number found in the appropriate box in column 1.						

This collection of information is required by 37 CFR 1.16. The information is required to obtain or retain a benefit by the public which is to file (and by the USPTO to process) an application. Confidentiality is governed by 35 U.S.C. 122 and 37 CFR 1.14. This collection is estimated to take 12 minutes to complete, including gathering, preparing, and submitting the completed application form to the USPTO. Time will vary depending upon the individual case. Any comments on the amount of time you require to complete this form and/or suggestions for reducing this burden, should be sent to the Chief Information Officer, U.S. Patent and Trademark Office, U.S. Department of Commerce, P.O. Box 1450, Alexandria, VA 22313-1450. DO NOT SEND FEES OR COMPLETED FORMS TO THIS ADDRESS. SEND TO: Commissioner for Patents, P.O. Box 1450, Alexandria, VA 22313-1450.

If you need assistance in completing the form, call 1-800-PTO-9199 and select option 2.



## UNITED STATES PATENT AND TRADEMARK OFFICE

UNITED STATES DEPARTMENT OF COMMERCE  
**United States Patent and Trademark Office**  
 Address: COMMISSIONER FOR PATENTS  
 P.O. Box 1450  
 Alexandria, Virginia 22313-1450  
 www.uspto.gov

APPLICATION NUMBER	FILING or 371(c) DATE	GRP ART UNIT	FIL FEE REC'D	ATTY. DOCKET NO	TOT CLAIMS	IND CLAIMS
12/211,033	09/15/2008	3736	0.00	00125/002005	12	2

CONFIRMATION NO. 7693

## FILING RECEIPT



27774  
 MAYER & WILLIAMS PC  
 251 NORTH AVENUE WEST  
 2ND FLOOR  
 WESTFIELD, NJ 07090

Date Mailed: 09/26/2008

Receipt is acknowledged of this non-provisional patent application. The application will be taken up for examination in due course. Applicant will be notified as to the results of the examination. Any correspondence concerning the application must include the following identification information: the U.S. APPLICATION NUMBER, FILING DATE, NAME OF APPLICANT, and TITLE OF INVENTION. Fees transmitted by check or draft are subject to collection. Please verify the accuracy of the data presented on this receipt. **If an error is noted on this Filing Receipt, please submit a written request for a Filing Receipt Correction. Please provide a copy of this Filing Receipt with the changes noted thereon. If you received a "Notice to File Missing Parts" for this application, please submit any corrections to this Filing Receipt with your reply to the Notice. When the USPTO processes the reply to the Notice, the USPTO will generate another Filing Receipt incorporating the requested corrections**

**Applicant(s)**

Roger J. Quy, Mill Valley, CA;

**Power of Attorney:**

Mark Wieczorek--37966

**Domestic Priority data as claimed by applicant**

This application is a CON of 11/649,703 01/03/2007  
 which is a CON of 10/418,845 04/18/2003 PAT 6,936,007  
 which is a CON of 09/738,270 12/15/2000 PAT 6,602,191  
 which claims benefit of 60/172,486 12/17/1999

**Foreign Applications****If Required, Foreign Filing License Granted:** 09/24/2008

The country code and number of your priority application, to be used for filing abroad under the Paris Convention, is **US 12/211,033**

**Projected Publication Date:** To Be Determined - pending completion of Missing Parts**Non-Publication Request:** No**Early Publication Request:** No

**Title**

METHOD AND APPARATUS FOR HEALTH AND DISEASE MANAGEMENT COMBINING PATIENT DATA MONITORING WITH WIRELESS INTERNET CONNECTIVITY

**Preliminary Class**

600

**PROTECTING YOUR INVENTION OUTSIDE THE UNITED STATES**

Since the rights granted by a U.S. patent extend only throughout the territory of the United States and have no effect in a foreign country, an inventor who wishes patent protection in another country must apply for a patent in a specific country or in regional patent offices. Applicants may wish to consider the filing of an international application under the Patent Cooperation Treaty (PCT). An international (PCT) application generally has the same effect as a regular national patent application in each PCT-member country. The PCT process **simplifies** the filing of patent applications on the same invention in member countries, but **does not result** in a grant of "an international patent" and does not eliminate the need of applicants to file additional documents and fees in countries where patent protection is desired.

Almost every country has its own patent law, and a person desiring a patent in a particular country must make an application for patent in that country in accordance with its particular laws. Since the laws of many countries differ in various respects from the patent law of the United States, applicants are advised to seek guidance from specific foreign countries to ensure that patent rights are not lost prematurely.

Applicants also are advised that in the case of inventions made in the United States, the Director of the USPTO must issue a license before applicants can apply for a patent in a foreign country. The filing of a U.S. patent application serves as a request for a foreign filing license. The application's filing receipt contains further information and guidance as to the status of applicant's license for foreign filing.

Applicants may wish to consult the USPTO booklet, "General Information Concerning Patents" (specifically, the section entitled "Treaties and Foreign Patents") for more information on timeframes and deadlines for filing foreign patent applications. The guide is available either by contacting the USPTO Contact Center at 800-786-9199, or it can be viewed on the USPTO website at <http://www.uspto.gov/web/offices/pac/doc/general/index.html>.

For information on preventing theft of your intellectual property (patents, trademarks and copyrights), you may wish to consult the U.S. Government website, <http://www.stopfakes.gov>. Part of a Department of Commerce initiative, this website includes self-help "toolkits" giving innovators guidance on how to protect intellectual property in specific countries such as China, Korea and Mexico. For questions regarding patent enforcement issues, applicants may call the U.S. Government hotline at 1-866-999-HALT (1-866-999-4158).

**LICENSE FOR FOREIGN FILING UNDER**

**Title 35, United States Code, Section 184**

**Title 37, Code of Federal Regulations, 5.11 & 5.15**

**GRANTED**

The applicant has been granted a license under 35 U.S.C. 184, if the phrase "IF REQUIRED, FOREIGN FILING LICENSE GRANTED" followed by a date appears on this form. Such licenses are issued in all applications where

the conditions for issuance of a license have been met, regardless of whether or not a license may be required as set forth in 37 CFR 5.15. The scope and limitations of this license are set forth in 37 CFR 5.15(a) unless an earlier license has been issued under 37 CFR 5.15(b). The license is subject to revocation upon written notification. The date indicated is the effective date of the license, unless an earlier license of similar scope has been granted under 37 CFR 5.13 or 5.14.

This license is to be retained by the licensee and may be used at any time on or after the effective date thereof unless it is revoked. This license is automatically transferred to any related applications(s) filed under 37 CFR 1.53(d). This license is not retroactive.

The grant of a license does not in any way lessen the responsibility of a licensee for the security of the subject matter as imposed by any Government contract or the provisions of existing laws relating to espionage and the national security or the export of technical data. Licensees should apprise themselves of current regulations especially with respect to certain countries, of other agencies, particularly the Office of Defense Trade Controls, Department of State (with respect to Arms, Munitions and Implements of War (22 CFR 121-128)); the Bureau of Industry and Security, Department of Commerce (15 CFR parts 730-774); the Office of Foreign Assets Control, Department of Treasury (31 CFR Parts 500+) and the Department of Energy.

**NOT GRANTED**

No license under 35 U.S.C. 184 has been granted at this time, if the phrase "IF REQUIRED, FOREIGN FILING LICENSE GRANTED" DOES NOT appear on this form. Applicant may still petition for a license under 37 CFR 5.12, if a license is desired before the expiration of 6 months from the filing date of the application. If 6 months has lapsed from the filing date of this application and the licensee has not received any indication of a secrecy order under 35 U.S.C. 181, the licensee may foreign file the application pursuant to 37 CFR 5.15(b).



## UNITED STATES PATENT AND TRADEMARK OFFICE

UNITED STATES DEPARTMENT OF COMMERCE  
 United States Patent and Trademark Office  
 Address: COMMISSIONER FOR PATENTS  
 P.O. Box 1450  
 Alexandria, Virginia 22313-1450  
 www.uspto.gov

APPLICATION NUMBER	FILING OR 371(C) DATE	FIRST NAMED APPLICANT	ATTY. DOCKET NO./TITLE
12/211,033	09/15/2008	Roger J. Quy	00125/002005

CONFIRMATION NO. 7693

## FORMALITIES LETTER



27774  
 MAYER & WILLIAMS PC  
 251 NORTH AVENUE WEST  
 2ND FLOOR  
 WESTFIELD, NJ 07090

Date Mailed: 09/26/2008

## NOTICE TO FILE MISSING PARTS OF NONPROVISIONAL APPLICATION

FILED UNDER 37 CFR 1.53(b)

*Filing Date Granted***Items Required To Avoid Abandonment:**

An application number and filing date have been accorded to this application. The item(s) indicated below, however, are missing. Applicant is given **TWO MONTHS** from the date of this Notice within which to file all required items and pay any fees required below to avoid abandonment. Extensions of time may be obtained by filing a petition accompanied by the extension fee under the provisions of 37 CFR 1.136(a).

- The statutory basic filing fee is missing.  
*Applicant must submit \$310 to complete the basic filing fee for a non-small entity. If appropriate, applicant may make a written assertion of entitlement to small entity status and pay the small entity filing fee (37 CFR 1.27).*

The application is informal since it does not comply with the regulations for the reason(s) indicated below.

The required item(s) identified below must be timely submitted to avoid abandonment:

- Replacement drawings in compliance with 37 CFR 1.84 and 37 CFR 1.121(d) are required. The drawings submitted are not acceptable because:
  - The drawings must be reasonably free from erasures and must be free from alterations, overwriting, interlineations, folds, and copy marks. See Figure(s) 1-8.
  - Numbers, letters, and reference characters on the drawings must measure at least 0.32 cm (1/8 inch) in height. See Figure(s) 1-8.

Applicant is cautioned that correction of the above items may cause the specification and drawings page count to exceed 100 pages. If the specification and drawings exceed 100 pages, applicant will need to submit the required application size fee.

The applicant needs to satisfy supplemental fees problems indicated below.

The required item(s) identified below must be timely submitted to avoid abandonment:

- To avoid abandonment, a surcharge (for late submission of filing fee, search fee, examination fee or oath or declaration) as set forth in 37 CFR 1.16(f) of **\$130** for a non-small entity, must be submitted with the missing items identified in this notice.

**SUMMARY OF FEES DUE:**

Total additional fee(s) required for this application is **\$1160** for a non-small entity

- **\$310** Statutory basic filing fee.
- **\$130** Surcharge.
- The application search fee has not been paid. Applicant must submit **\$510** to complete the search fee.
- The application examination fee has not been paid. Applicant must submit **\$210** to complete the examination fee for a non-small entity.

Replies should be mailed to:

Mail Stop Missing Parts  
Commissioner for Patents  
P.O. Box 1450  
Alexandria VA 22313-1450

Registered users of EFS-Web may alternatively submit their reply to this notice via EFS-Web.

<https://portal.uspto.gov/authenticate/AuthenticateUserLocalEPF.html>

For more information about EFS-Web please call the USPTO Electronic Business Center at **1-866-217-9197** or visit our website at <http://www.uspto.gov/ebc>.

If you are not using EFS-Web to submit your reply, you must include a copy of this notice.

/mkibret/

---

Office of Data Management, Application Assistance Unit (571) 272-4000, or (571) 272-4200, or 1-888-786-0101

**Response To Notice To File Missing Parts Of Application  
Filing Date Granted (PTO-1533)(Small Entity)**

Docket No.  
00125/002005

In Re Application Of: **Roger Quy**

Application No.	Filing Date	Examiner	Customer No.	Group Art Unit	Confirmation No.
12/211,033	09/15/2008	Unassigned	27774	3736	7693

Invention: **METHOD AND APPARATUS FOR HEALTH AND DISEASE MANAGEMENT COMBINING PATIENT DATA MONITORING WITH WIRELESS INTERNET CONNECTIVITY**

Mail Stop Missing Parts

COMMISSIONER FOR PATENTS:

This is a response to the Notice to File Missing Parts of Application - Filing Date Granted (PTO-1533) mailed on 09/26/2008.  
*Date*

Enclosed herewith for filing are the following:

- A copy of the Notice to File Missing Parts of Application - Filing Date Granted (PTO-1533). **(REQUIRED)**
- An oath or declaration in compliance with 37 CFR 1.63, including residence information and identifying the application by the above Application Number and Filing Date.
- A properly signed oath or declaration in compliance with 37 CFR 1.63.
- An oath or declaration in compliance with 37 CFR 1.63 listing the names of all inventors and signed by the omitted inventor(s), identifying this application by the above Application Number and Filing Date.
- A verified English translation of the non-English language application papers as originally filed. It is requested that this translation be used as the copy for examination purposes in the United States Patent and Trademark Office.
- see below verified small entity declaration(s)
  - is/are attached.
  - was/were filed on \_\_\_\_\_
- A separate request for refund.
- Other (list):

**8 Sheets Replacement Drawings  
Supplemental Application Data Sheet, noting claim of small entity status**

<b>Response To Notice To File Missing Parts Of Application Filing Date Granted (PTO-1533)(Small Entity)</b>					Docket No. <b>00125/002005</b>
In Re Application Of: <p style="text-align: center;"><b>Roger Quy</b></p>					
Application No. <b>12/211,033</b>	Filing Date <b>09/15/2008</b>	Examiner <b>Unassigned</b>	Customer No. <b>27774</b>	Group Art Unit <b>3736</b>	Confirmation No. <b>7693</b>
Invention: <b>METHOD AND APPARATUS FOR HEALTH AND DISEASE MANAGEMENT COMBINING PATIENT DATA MONITORING WITH WIRELESS INTERNET CONNECTIVITY</b>					
<u>TO THE COMMISSIONER FOR PATENTS:</u> <u>Mail Stop Missing Parts</u>					
<input checked="" type="checkbox"/> Completion of application fees as calculated below:					
<input checked="" type="checkbox"/> Utility application basic fee				<u>\$82.00</u>	
<input type="checkbox"/> Design application basic fee					
<input checked="" type="checkbox"/> Search Fee				<u>\$270.00</u>	
<input checked="" type="checkbox"/> Examination Fee				<u>\$110.00</u>	
<input checked="" type="checkbox"/> Total number of independent claims = <u>2</u>					
<input checked="" type="checkbox"/> Total number of claims = <u>12</u>					
<input type="checkbox"/> Multiple dependent claims					
<input checked="" type="checkbox"/> Surcharge for late payment of filing fee and/or late filing of original declaration or oath				<u>\$65.00</u>	
<input type="checkbox"/> Petition and fee for filing by other than all the inventors or a person not the inventor					
<input type="checkbox"/> Fee for processing an application filed with a non-English language specification					
<input type="checkbox"/> Fee for processing and retention of application					
Total completion of application fees				<u>\$527.00</u>	
This is a request under the provisions of 37 CFR 1.136(a) to extend the period for filing a response to the above-identified Notice to File Missing Parts of Application. The requested extension is as follows (check time period desired). If an additional time extension is required, please consider this a petition therefor.					
<input type="checkbox"/> One month	<input type="checkbox"/> Two months	<input type="checkbox"/> Three months	<input type="checkbox"/> Four months	<input type="checkbox"/> Five months	
from: _____	<i>Date</i>	until: _____	<i>Date</i>		
				Total time extension fees	_____
				Total fees due	<u>\$527.00</u>



**Response To Notice To File Missing Parts Of Application  
Filing Date Granted (PTO-1533) (Small Entity)**

Docket No.  
00125/002005

In Re Application Of: **Roger Quy**

Application No.	Filing Date	Examiner	Customer No.	Group Art Unit	Confirmation No.
12/211,033	09/15/2008	Unassigned	27774	3736	7693

Invention: **METHOD AND APPARATUS FOR HEALTH AND DISEASE MANAGEMENT COMBINING PATIENT DATA MONITORING WITH WIRELESS INTERNET CONNECTIVITY**

TO THE COMMISSIONER FOR PATENTS:

Mail Stop Missing Parts

The fee of **\$527.00** is to be paid as follows:

- A check in the amount of the fee is enclosed.
- The Director is hereby authorized to charge any fees which may be required, or credit any overpayment, to Deposit Account No. **50-1047**
- If an additional extension of time is required, please consider this a petition therefor and charge any additional fees which may be required to Deposit Account No. **50-1047**
- Payment by credit card. Form PTO-2038 is attached.

**WARNING: Information on this form may become public. Credit card information should not be included on this form. Provide credit card information and authorization on PTO-2038.**

/Mark Wieczorek/

*Signature*

**Mark D. Wieczorek  
Mayer & Williams PC  
251 North Ave. West, 2nd Floor  
Westfield, NJ 07090**

**Tel.: 619-818-4615**

Dated: **11/26/2008**

I hereby certify that this correspondence is being deposited with the United States Postal Service with sufficient postage as first class mail in an envelope addressed to "Commissioner for Patents, P.O. Box 1450, Alexandria, VA 22313-1450" [37 CFR 1.8(a)] on

**11/26/2008**

*(Date)*

/Marjorie Scariati/

*Signature of Person Mailing Correspondence*

**Marjorie Scariati**

*Typed or Printed Name of Person Mailing Correspondence*

cc:

## Electronic Patent Application Fee Transmittal

<b>Application Number:</b>	12211033			
<b>Filing Date:</b>	15-Sep-2008			
<b>Title of Invention:</b>	METHOD AND APPARATUS FOR HEALTH AND DISEASE MANAGEMENT COMBINING PATIENT DATA MONITORING WITH WIRELESS INTERNET CONNECTIVITY			
<b>First Named Inventor/Applicant Name:</b>	Roger J. Quy			
<b>Filer:</b>	Mark K. Young/Marjorie Scariati			
<b>Attorney Docket Number:</b>	00125/002005			
Filed as Small Entity				
<b>Utility under 35 USC 111(a) Filing Fees</b>				
<b>Description</b>	<b>Fee Code</b>	<b>Quantity</b>	<b>Amount</b>	<b>Sub-Total in USD(\$)</b>
<b>Basic Filing:</b>				
Utility filing Fee (Electronic filing)	4011	1	82	82
Utility Search Fee	2111	1	270	270
Utility Examination Fee	2311	1	110	110
<b>Pages:</b>				
<b>Claims:</b>				
<b>Miscellaneous-Filing:</b>				
Late filing fee for oath or declaration	2051	1	65	65
<b>Petition:</b>				

Description	Fee Code	Quantity	Amount	Sub-Total in USD(\$)
<b>Patent-Appeals-and-Interference:</b>				
<b>Post-Allowance-and-Post-Issuance:</b>				
<b>Extension-of-Time:</b>				
<b>Miscellaneous:</b>				
<b>Total in USD (\$)</b>				<b>527</b>

**Electronic Acknowledgement Receipt**

<b>EFS ID:</b>	4365917
<b>Application Number:</b>	12211033
<b>International Application Number:</b>	
<b>Confirmation Number:</b>	7693
<b>Title of Invention:</b>	METHOD AND APPARATUS FOR HEALTH AND DISEASE MANAGEMENT COMBINING PATIENT DATA MONITORING WITH WIRELESS INTERNET CONNECTIVITY
<b>First Named Inventor/Applicant Name:</b>	Roger J. Quy
<b>Customer Number:</b>	27774
<b>Filer:</b>	Mark K. Young/Marjorie Scariati
<b>Filer Authorized By:</b>	Mark K. Young
<b>Attorney Docket Number:</b>	00125/002005
<b>Receipt Date:</b>	26-NOV-2008
<b>Filing Date:</b>	15-SEP-2008
<b>Time Stamp:</b>	19:57:47
<b>Application Type:</b>	Utility under 35 USC 111(a)

**Payment information:**

Submitted with Payment	yes
Payment Type	Deposit Account
Payment was successfully received in RAM	\$527
RAM confirmation Number	7176
Deposit Account	501047
Authorized User	

The Director of the USPTO is hereby authorized to charge indicated fees and credit any overpayment as follows:

Charge any Additional Fees required under 37 C.F.R. Section 1.16 (National application filing, search, and examination fees)

**File Listing:**

Document Number	Document Description	File Name	File Size(Bytes)/ Message Digest	Multi Part /.zip	Pages (if appl.)
1	Application Data Sheet	00125_002005_Supp_ADS.pdf	968662 e0225496d27dc57caef188f8468706c621fae80a	no	4
<b>Warnings:</b>					
<b>Information:</b>					
2	Drawings-only black and white line drawings	00125-002005-replacement-figures.pdf	553860 6fa6c9149e93514e6b87484245fe19f6ba85768c	no	8
<b>Warnings:</b>					
<b>Information:</b>					
3	Applicant Response to Pre-Exam Formalities Notice	00125-002005-missing-parts-response.pdf	155993 24a8600af23a286bec684fc895e51abd41ce4fb5	no	3
<b>Warnings:</b>					
<b>Information:</b>					
4	Fee Worksheet (PTO-06)	fee-info.pdf	37394 3448c360a56bcb093b6aeef208fab661a6228860	no	2
<b>Warnings:</b>					
<b>Information:</b>					
<b>Total Files Size (in bytes):</b>			1715909		

This Acknowledgement Receipt evidences receipt on the noted date by the USPTO of the indicated documents, characterized by the applicant, and including page counts, where applicable. It serves as evidence of receipt similar to a Post Card, as described in MPEP 503.

**New Applications Under 35 U.S.C. 111**

If a new application is being filed and the application includes the necessary components for a filing date (see 37 CFR 1.53(b)-(d) and MPEP 506), a Filing Receipt (37 CFR 1.54) will be issued in due course and the date shown on this Acknowledgement Receipt will establish the filing date of the application.

**National Stage of an International Application under 35 U.S.C. 371**

If a timely submission to enter the national stage of an international application is compliant with the conditions of 35 U.S.C. 371 and other applicable requirements a Form PCT/DO/EO/903 indicating acceptance of the application as a national stage submission under 35 U.S.C. 371 will be issued in addition to the Filing Receipt, in due course.

**New International Application Filed with the USPTO as a Receiving Office**

If a new international application is being filed and the international application includes the necessary components for an international filing date (see PCT Article 11 and MPEP 1810), a Notification of the International Application Number and of the International Filing Date (Form PCT/RO/105) will be issued in due course, subject to prescriptions concerning national security, and the date shown on this Acknowledgement Receipt will establish the international filing date of the application.

Under the Paperwork Reduction Act of 1995, no persons are required to respond to a collection of information unless it contains a valid OMB control number.

<b>Application Data Sheet 37 CFR 1.76</b>		Attorney Docket Number	00125/002005
		Application Number	
Title of Invention	METHOD AND APPARATUS FOR HEALTH AND DISEASE MANAGEMENT COMBINING PATIENT DATA MONITORING WITH WIRELESS INTERNET CONNECTIVITY		
The application data sheet is part of the provisional or nonprovisional application for which it is being submitted. The following form contains the bibliographic data arranged in a format specified by the United States Patent and Trademark Office as outlined in 37 CFR 1.76. This document may be completed electronically and submitted to the Office in electronic format using the Electronic Filing System (EFS) or the document may be printed and included in a paper filed application.			

### Secrecy Order 37 CFR 5.2

Portions or all of the application associated with this Application Data Sheet may fall under a Secrecy Order pursuant to 37 CFR 5.2 (Paper filers only. Applications that fall under Secrecy Order may not be filed electronically.)

### Applicant Information:

<b>Applicant 1</b>					<input type="button" value="Remove"/>
<b>Applicant Authority</b>		<input checked="" type="radio"/> Inventor		<input type="radio"/> Legal Representative under 35 U.S.C. 117	
				<input type="radio"/> Party of Interest under 35 U.S.C. 118	
<b>Prefix</b>	<b>Given Name</b>	<b>Middle Name</b>	<b>Family Name</b>	<b>Suffix</b>	
	Roger	J.	Quy		
<b>Residence Information (Select One)</b>					
		<input checked="" type="radio"/> US Residency		<input type="radio"/> Non US Residency	
				<input type="radio"/> Active US Military Service	
<b>City</b>	Mill Valley	<b>State/Province</b>	CA	<b>Country of Residence i</b>	US
<b>Citizenship under 37 CFR 1.41(b) i</b>		GB			
<b>Mailing Address of Applicant:</b>					
<b>Address 1</b>	14 Topside Way				
<b>Address 2</b>					
<b>City</b>	Mill Valley	<b>State/Province</b>	CA		
<b>Postal Code</b>	94941	<b>Countryi</b>	US		
All Inventors Must Be Listed - Additional Inventor Information blocks may be generated within this form by selecting the <b>Add</b> button.					
					<input type="button" value="Add"/>

### Correspondence Information:

Enter either Customer Number or complete the Correspondence Information section below. For further information see 37 CFR 1.33(a).	
<input type="checkbox"/> An Address is being provided for the correspondence information of this application.	
<b>Customer Number</b>	27774
<b>Email Address</b>	<input type="button" value="Add Email"/> <input type="button" value="Remove Email"/>

### Application Information:

<b>Title of the Invention</b>	METHOD AND APPARATUS FOR HEALTH AND DISEASE MANAGEMENT COMBINING PATIENT DATA MONITORING WITH WIRELESS INTERNET CONNECTIVITY		
<b>Attorney Docket Number</b>	00125/002005	<b>Small Entity Status Claimed</b> <input checked="" type="checkbox"/>	
<b>Application Type</b>	Nonprovisional		
<b>Subject Matter</b>	Utility		
<b>Suggested Class (if any)</b>		<b>Sub Class (if any)</b>	
<b>Suggested Technology Center (if any)</b>	3736		
<b>Total Number of Drawing Sheets (if any)</b>	8	<b>Suggested Figure for Publication (if any)</b>	1

Under the Paperwork Reduction Act of 1995, no persons are required to respond to a collection of information unless it contains a valid OMB control number.

<b>Application Data Sheet 37 CFR 1.76</b>	Attorney Docket Number	00125/002005
	Application Number	
Title of Invention	METHOD AND APPARATUS FOR HEALTH AND DISEASE MANAGEMENT COMBINING PATIENT DATA MONITORING WITH WIRELESS INTERNET CONNECTIVITY	

**Publication Information:**

Request Early Publication (Fee required at time of Request 37 CFR 1.219)

**Request Not to Publish.** I hereby request that the attached application not be published under 35 U.S.C. 122(b) and certify that the invention disclosed in the attached application has not and will not be the subject of an application filed in another country, or under a multilateral international agreement, that requires publication at eighteen months after filing.

**Representative Information:**

Representative information should be provided for all practitioners having a power of attorney in the application. Providing this information in the Application Data Sheet does not constitute a power of attorney in the application (see 37 CFR 1.32). Enter either Customer Number or complete the Representative Name section below. If both sections are completed the Customer Number will be used for the Representative Information during processing.

Please Select One:  Customer Number  US Patent Practitioner  Limited Recognition (37 CFR 11.9)

Customer Number: 27774

**Domestic Benefit/National Stage Information:**

This section allows for the applicant to either claim benefit under 35 U.S.C. 119(e), 120, 121, or 365(c) or indicate National Stage entry from a PCT application. Providing this information in the application data sheet constitutes the specific reference required by 35 U.S.C. 119(e) or 120, and 37 CFR 1.78(a)(2) or CFR 1.78(a)(4), and need not otherwise be made part of the specification.

Prior Application Status	Abandoned		<a href="#">Remove</a>		
Application Number	Continuity Type	Prior Application Number	Filing Date (YYYY-MM-DD)		
	Continuation of	11649703	2007-01-03		
Prior Application Status	Patented		<a href="#">Remove</a>		
Application Number	Continuity Type	Prior Application Number	Filing Date (YYYY-MM-DD)	Patent Number	Issue Date (YYYY-MM-DD)
11649703	Continuation of	10418845	2003-04-18	6936007	2005-08-30
Prior Application Status	Patented		<a href="#">Remove</a>		
Application Number	Continuity Type	Prior Application Number	Filing Date (YYYY-MM-DD)	Patent Number	Issue Date (YYYY-MM-DD)
10418845	Continuation of	09738270	2000-12-15	6602191	2003-08-05
Prior Application Status	Expired		<a href="#">Remove</a>		
Application Number	Continuity Type	Prior Application Number	Filing Date (YYYY-MM-DD)		
09738270	non provisional of	60172486	1999-12-17		
Additional Domestic Benefit/National Stage Data may be generated within this form by selecting the <b>Add</b> button.					<a href="#">Add</a>

**Foreign Priority Information:**

Under the Paperwork Reduction Act of 1995, no persons are required to respond to a collection of information unless it contains a valid OMB control number.

<b>Application Data Sheet 37 CFR 1.76</b>		Attorney Docket Number	00125/002005
		Application Number	
Title of Invention	METHOD AND APPARATUS FOR HEALTH AND DISEASE MANAGEMENT COMBINING PATIENT DATA MONITORING WITH WIRELESS INTERNET CONNECTIVITY		

This section allows for the applicant to claim benefit of foreign priority and to identify any prior foreign application for which priority is not claimed. Providing this information in the application data sheet constitutes the claim for priority as required by 35 U.S.C. 119(b) and 37 CFR 1.55(a).

<input type="button" value="Remove"/>			
Application Number	Country <sup>i</sup>	Parent Filing Date (YYYY-MM-DD)	Priority Claimed
			<input type="radio"/> Yes <input checked="" type="radio"/> No
Additional Foreign Priority Data may be generated within this form by selecting the <b>Add</b> button.			<input type="button" value="Add"/>

### Assignee Information:

Providing this information in the application data sheet does not substitute for compliance with any requirement of part 3 of Title 37 of the CFR to have an assignment recorded in the Office.

<input type="button" value="Remove"/>			
<b>Assignee 1</b>			
If the Assignee is an Organization check here. <input checked="" type="checkbox"/>			
Organization Name	Q-Tec Systems LLC		
<b>Mailing Address Information:</b>			
Address 1	1220 N. Market Street, Suite 606		
Address 2			
City	Wilmington	State/Province	DE
Country <sup>i</sup>	US	Postal Code	19801
Phone Number		Fax Number	
Email Address			
Additional Assignee Data may be generated within this form by selecting the <b>Add</b> button.			<input type="button" value="Add"/>

### Signature:

A signature of the applicant or representative is required in accordance with 37 CFR 1.33 and 10.18. Please see 37 CFR 1.4(d) for the form of the signature.

Signature	/Mark Wieczorek/		Date (YYYY-MM-DD)	2008-11-26	
First Name	Mark D.	Last Name	Wieczorek	Registration Number	37966

This collection of information is required by 37 CFR 1.76. The information is required to obtain or retain a benefit by the public which is to file (and by the USPTO to process) an application. Confidentiality is governed by 35 U.S.C. 122 and 37 CFR 1.14. This collection is estimated to take 23 minutes to complete, including gathering, preparing, and submitting the completed application data sheet form to the USPTO. Time will vary depending upon the individual case. Any comments on the amount of time you require to complete this form and/or suggestions for reducing this burden, should be sent to the Chief Information Officer, U.S. Patent and Trademark Office, U.S. Department of Commerce, P.O. Box 1450, Alexandria, VA 22313-1450. DO NOT SEND FEES OR COMPLETED FORMS TO THIS ADDRESS. **SEND TO: Commissioner for Patents, P.O. Box 1450, Alexandria, VA 22313-1450.**



## Privacy Act Statement

The Privacy Act of 1974 (P.L. 93-579) requires that you be given certain information in connection with your submission of the attached form related to a patent application or patent. Accordingly, pursuant to the requirements of the Act, please be advised that: (1) the general authority for the collection of this information is 35 U.S.C. 2(b)(2); (2) furnishing of the information solicited is voluntary; and (3) the principal purpose for which the information is used by the U.S. Patent and Trademark Office is to process and/or examine your submission related to a patent application or patent. If you do not furnish the requested information, the U.S. Patent and Trademark Office may not be able to process and/or examine your submission, which may result in termination of proceedings or abandonment of the application or expiration of the patent.

The information provided by you in this form will be subject to the following routine uses:

1. The information on this form will be treated confidentially to the extent allowed under the Freedom of Information Act (5 U.S.C. 552) and the Privacy Act (5 U.S.C. 552a). Records from this system of records may be disclosed to the Department of Justice to determine whether the Freedom of Information Act requires disclosure of these records.
2. A record from this system of records may be disclosed, as a routine use, in the course of presenting evidence to a court, magistrate, or administrative tribunal, including disclosures to opposing counsel in the course of settlement negotiations.
3. A record in this system of records may be disclosed, as a routine use, to a Member of Congress submitting a request involving an individual, to whom the record pertains, when the individual has requested assistance from the Member with respect to the subject matter of the record.
4. A record in this system of records may be disclosed, as a routine use, to a contractor of the Agency having need for the information in order to perform a contract. Recipients of information shall be required to comply with the requirements of the Privacy Act of 1974, as amended, pursuant to 5 U.S.C. 552a(m).
5. A record related to an International Application filed under the Patent Cooperation Treaty in this system of records may be disclosed, as a routine use, to the International Bureau of the World Intellectual Property Organization, pursuant to the Patent Cooperation Treaty.
6. A record in this system of records may be disclosed, as a routine use, to another federal agency for purposes of National Security review (35 U.S.C. 181) and for review pursuant to the Atomic Energy Act (42 U.S.C. 218(c)).
7. A record from this system of records may be disclosed, as a routine use, to the Administrator, General Services, or his/her designee, during an inspection of records conducted by GSA as part of that agency's responsibility to recommend improvements in records management practices and programs, under authority of 44 U.S.C. 2904 and 2906. Such disclosure shall be made in accordance with the GSA regulations governing inspection of records for this purpose, and any other relevant (i.e., GSA or Commerce) directive. Such disclosure shall not be used to make determinations about individuals.
8. A record from this system of records may be disclosed, as a routine use, to the public after either publication of the application pursuant to 35 U.S.C. 122(b) or issuance of a patent pursuant to 35 U.S.C. 151. Further, a record may be disclosed, subject to the limitations of 37 CFR 1.14, as a routine use, to the public if the record was filed in an application which became abandoned or in which the proceedings were terminated and which application is referenced by either a published application, an application open to public inspections or an issued patent.
9. A record from this system of records may be disclosed, as a routine use, to a Federal, State, or local law enforcement agency, if the USPTO becomes aware of a violation or potential violation of law or regulation.

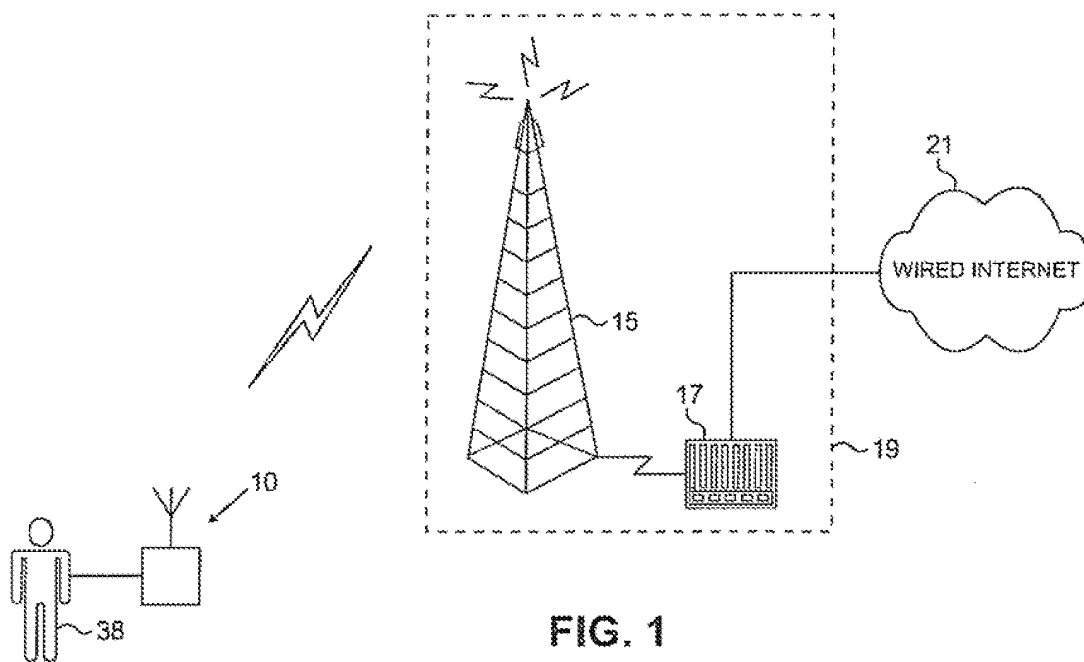

FIG. 1

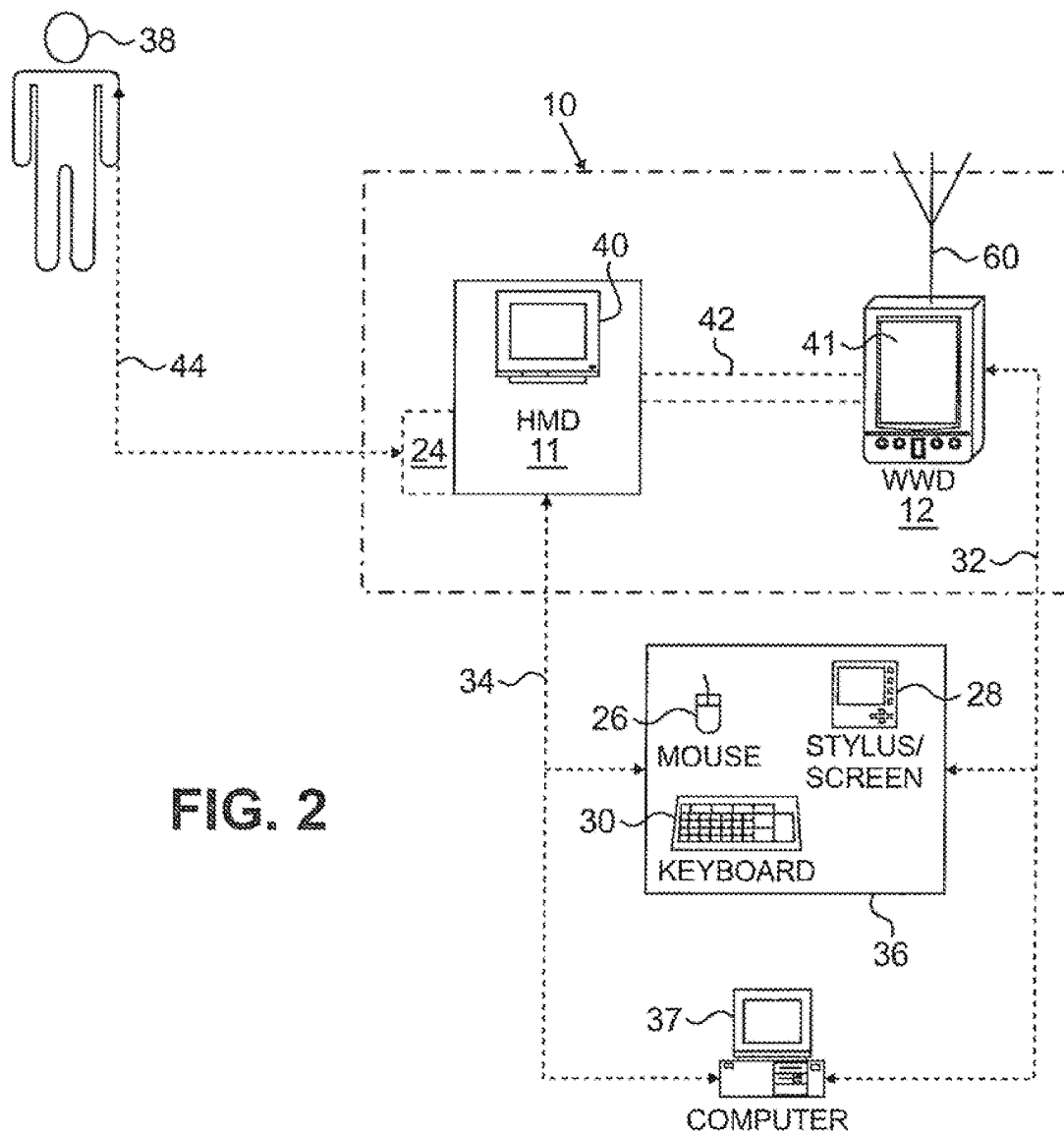

FIG. 2

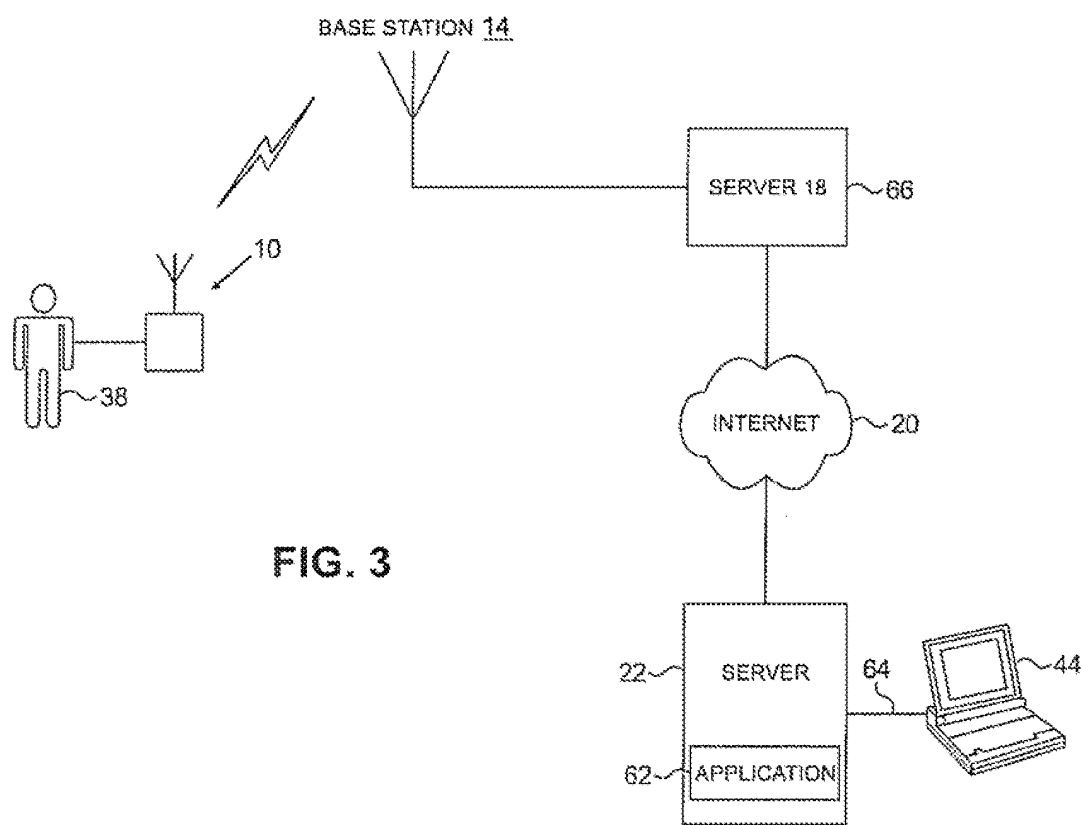

FIG. 3

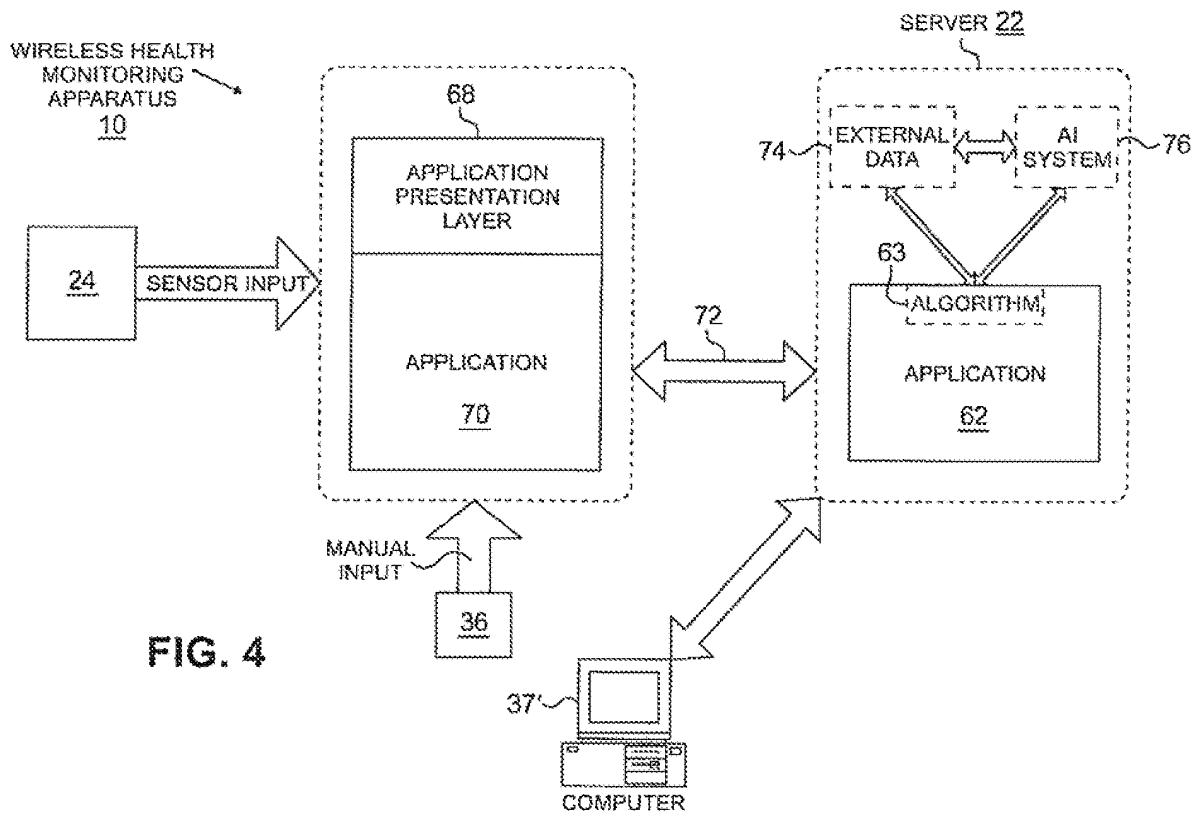

FIG. 4

FIG. 6

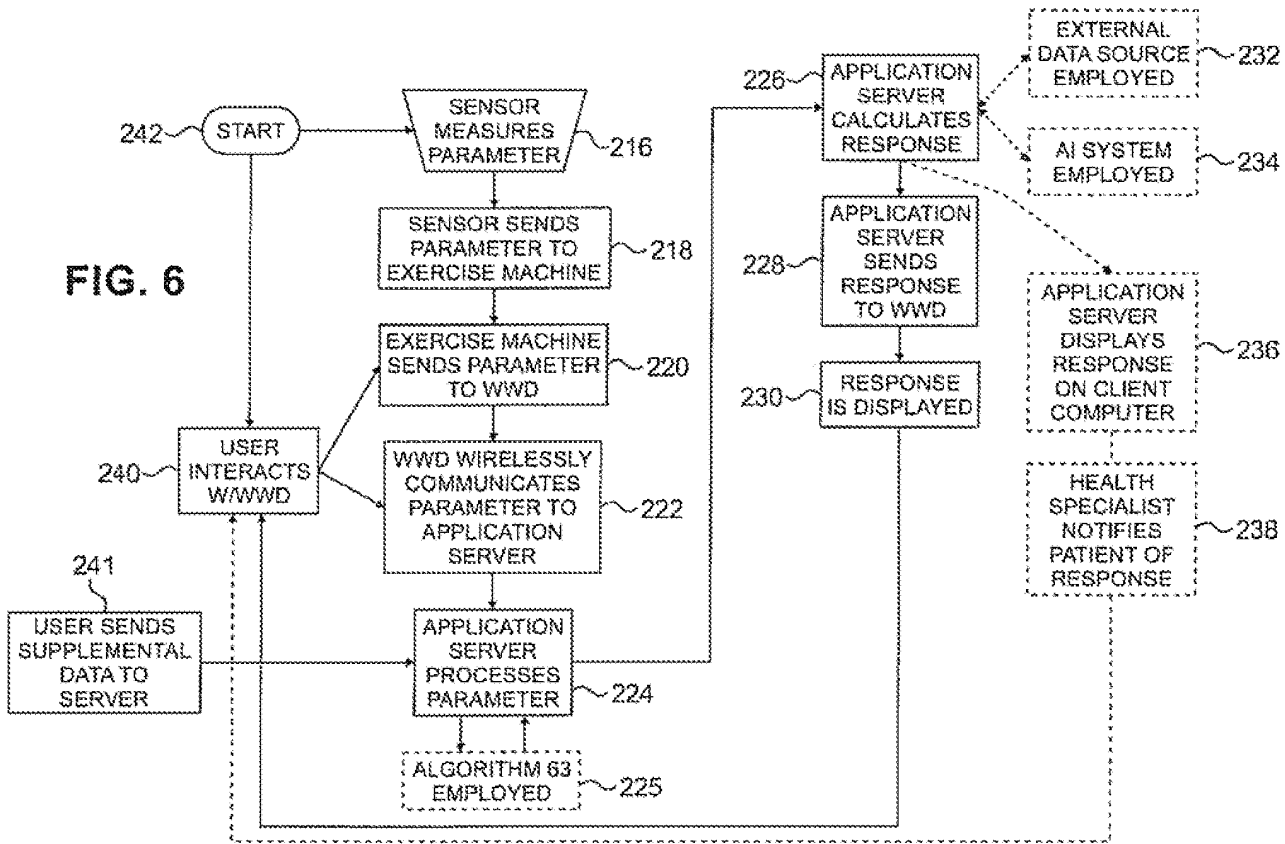
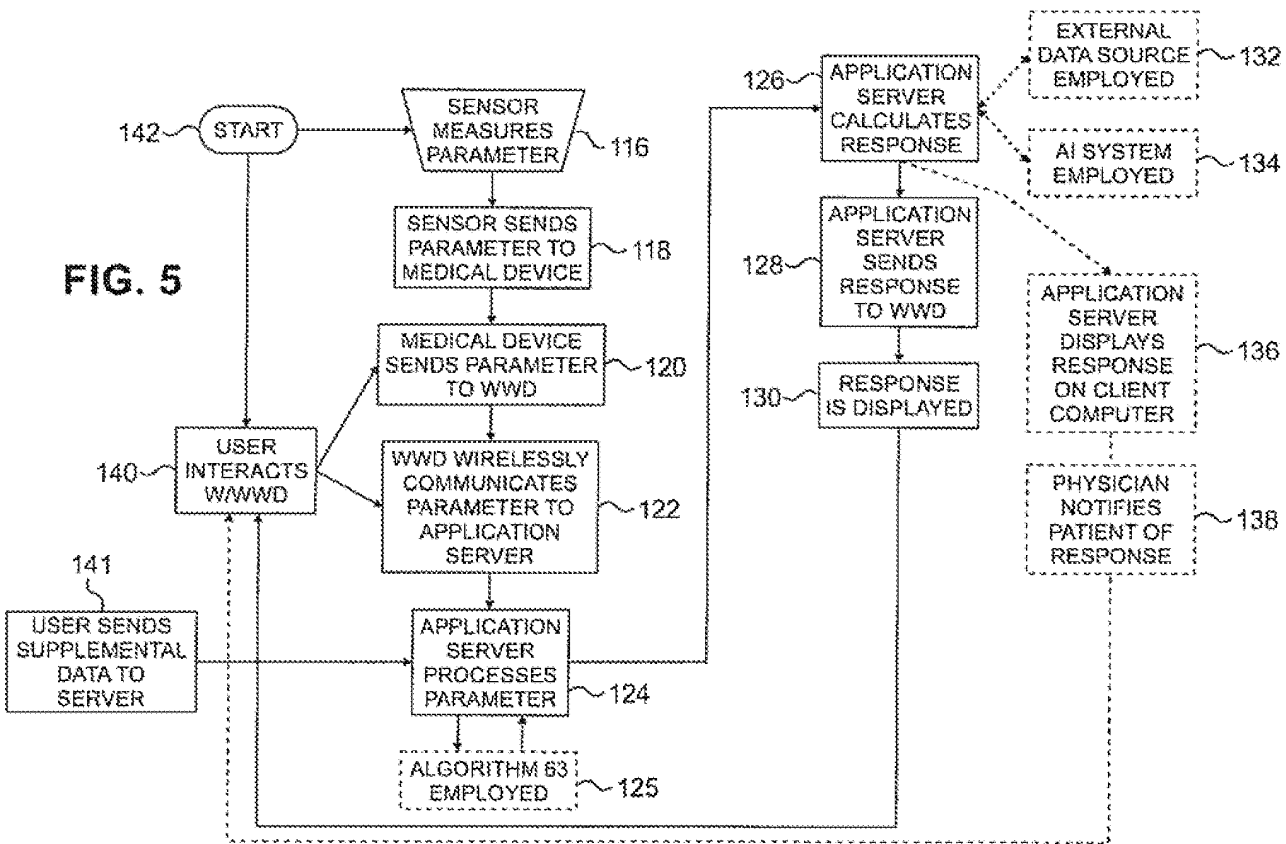

FIG. 5



7/8

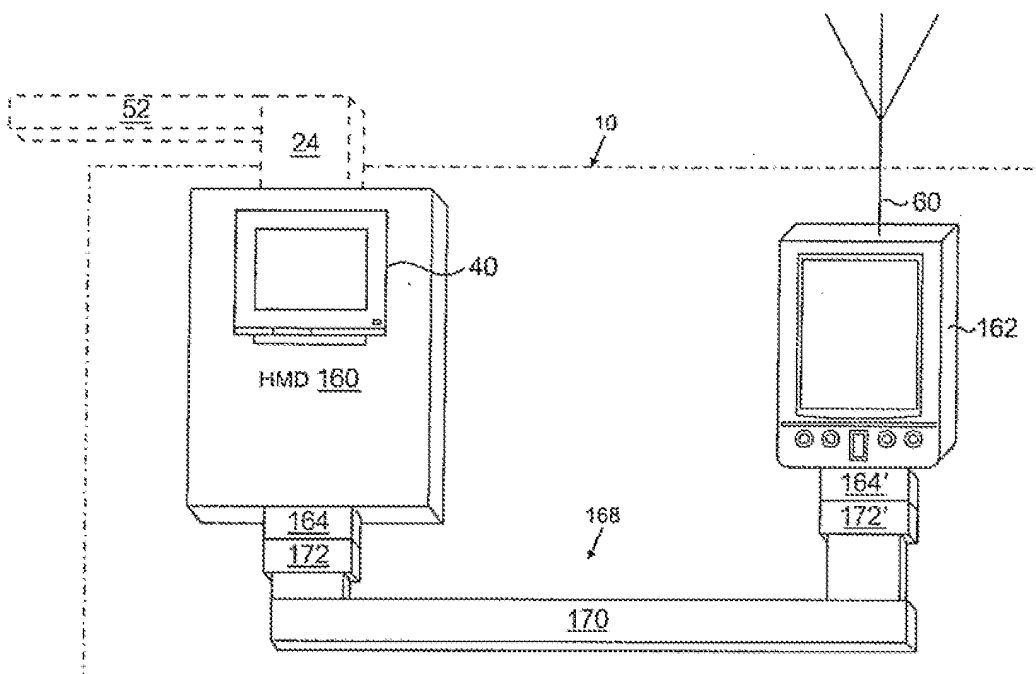

FIG. 7



8/8

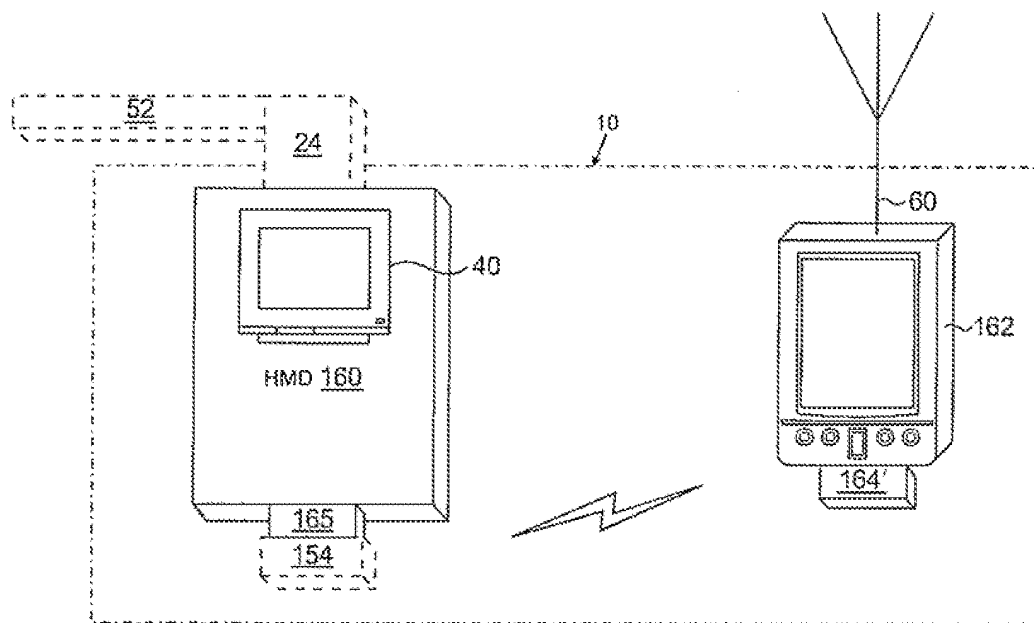

FIG. 8



## UNITED STATES PATENT AND TRADEMARK OFFICE

UNITED STATES DEPARTMENT OF COMMERCE  
**United States Patent and Trademark Office**  
 Address: COMMISSIONER FOR PATENTS  
 P.O. Box 1450  
 Alexandria, Virginia 22313-1450  
 www.uspto.gov

APPLICATION NUMBER	FILING or 371(c) DATE	GRP ART UNIT	FIL FEE REC'D	ATTY. DOCKET NO	TOT CLAIMS	IND CLAIMS
12/211,033	09/15/2008	3736	527	00125/002005	12	2

CONFIRMATION NO. 7693

UPDATED FILING RECEIPT



27774  
 MAYER & WILLIAMS PC  
 251 NORTH AVENUE WEST  
 2ND FLOOR  
 WESTFIELD, NJ 07090

Date Mailed: 12/04/2008

Receipt is acknowledged of this non-provisional patent application. The application will be taken up for examination in due course. Applicant will be notified as to the results of the examination. Any correspondence concerning the application must include the following identification information: the U.S. APPLICATION NUMBER, FILING DATE, NAME OF APPLICANT, and TITLE OF INVENTION. Fees transmitted by check or draft are subject to collection. Please verify the accuracy of the data presented on this receipt. **If an error is noted on this Filing Receipt, please submit a written request for a Filing Receipt Correction. Please provide a copy of this Filing Receipt with the changes noted thereon. If you received a "Notice to File Missing Parts" for this application, please submit any corrections to this Filing Receipt with your reply to the Notice. When the USPTO processes the reply to the Notice, the USPTO will generate another Filing Receipt incorporating the requested corrections**

**Applicant(s)**

Roger J. Quy, Mill Valley, CA;

**Assignment For Published Patent Application**

Q-Tec Systems LLC, Wilmington, DE

**Power of Attorney:**

Mark Wiczorek--37966

**Domestic Priority data as claimed by applicant**

This application is a CON of 11/649,703 01/03/2007 ABN  
 which is a CON of 10/418,845 04/18/2003 PAT 6,936,007  
 which is a CON of 09/738,270 12/15/2000 PAT 6,602,191  
 which claims benefit of 60/172,486 12/17/1999

**Foreign Applications**

If Required, Foreign Filing License Granted: 09/24/2008

The country code and number of your priority application, to be used for filing abroad under the Paris Convention, is **US 12/211,033**

Projected Publication Date: 03/12/2009

Non-Publication Request: No

Early Publication Request: No

**\*\* SMALL ENTITY \*\***

**Title**

METHOD AND APPARATUS FOR HEALTH AND DISEASE MANAGEMENT COMBINING PATIENT DATA MONITORING WITH WIRELESS INTERNET CONNECTIVITY

**Preliminary Class**

600

**PROTECTING YOUR INVENTION OUTSIDE THE UNITED STATES**

Since the rights granted by a U.S. patent extend only throughout the territory of the United States and have no effect in a foreign country, an inventor who wishes patent protection in another country must apply for a patent in a specific country or in regional patent offices. Applicants may wish to consider the filing of an international application under the Patent Cooperation Treaty (PCT). An international (PCT) application generally has the same effect as a regular national patent application in each PCT-member country. The PCT process **simplifies** the filing of patent applications on the same invention in member countries, but **does not result** in a grant of "an international patent" and does not eliminate the need of applicants to file additional documents and fees in countries where patent protection is desired.

Almost every country has its own patent law, and a person desiring a patent in a particular country must make an application for patent in that country in accordance with its particular laws. Since the laws of many countries differ in various respects from the patent law of the United States, applicants are advised to seek guidance from specific foreign countries to ensure that patent rights are not lost prematurely.

Applicants also are advised that in the case of inventions made in the United States, the Director of the USPTO must issue a license before applicants can apply for a patent in a foreign country. The filing of a U.S. patent application serves as a request for a foreign filing license. The application's filing receipt contains further information and guidance as to the status of applicant's license for foreign filing.

Applicants may wish to consult the USPTO booklet, "General Information Concerning Patents" (specifically, the section entitled "Treaties and Foreign Patents") for more information on timeframes and deadlines for filing foreign patent applications. The guide is available either by contacting the USPTO Contact Center at 800-786-9199, or it can be viewed on the USPTO website at <http://www.uspto.gov/web/offices/pac/doc/general/index.html>.

For information on preventing theft of your intellectual property (patents, trademarks and copyrights), you may wish to consult the U.S. Government website, <http://www.stopfakes.gov>. Part of a Department of Commerce initiative, this website includes self-help "toolkits" giving innovators guidance on how to protect intellectual property in specific countries such as China, Korea and Mexico. For questions regarding patent enforcement issues, applicants may call the U.S. Government hotline at 1-866-999-HALT (1-866-999-4158).

**LICENSE FOR FOREIGN FILING UNDER**

**Title 35, United States Code, Section 184**

**Title 37, Code of Federal Regulations, 5.11 & 5.15**

**GRANTED**

The applicant has been granted a license under 35 U.S.C. 184, if the phrase "IF REQUIRED, FOREIGN FILING LICENSE GRANTED" followed by a date appears on this form. Such licenses are issued in all applications where

the conditions for issuance of a license have been met, regardless of whether or not a license may be required as set forth in 37 CFR 5.15. The scope and limitations of this license are set forth in 37 CFR 5.15(a) unless an earlier license has been issued under 37 CFR 5.15(b). The license is subject to revocation upon written notification. The date indicated is the effective date of the license, unless an earlier license of similar scope has been granted under 37 CFR 5.13 or 5.14.

This license is to be retained by the licensee and may be used at any time on or after the effective date thereof unless it is revoked. This license is automatically transferred to any related applications(s) filed under 37 CFR 1.53(d). This license is not retroactive.

The grant of a license does not in any way lessen the responsibility of a licensee for the security of the subject matter as imposed by any Government contract or the provisions of existing laws relating to espionage and the national security or the export of technical data. Licensees should apprise themselves of current regulations especially with respect to certain countries, of other agencies, particularly the Office of Defense Trade Controls, Department of State (with respect to Arms, Munitions and Implements of War (22 CFR 121-128)); the Bureau of Industry and Security, Department of Commerce (15 CFR parts 730-774); the Office of Foreign Assets Control, Department of Treasury (31 CFR Parts 500+) and the Department of Energy.

**NOT GRANTED**

No license under 35 U.S.C. 184 has been granted at this time, if the phrase "IF REQUIRED, FOREIGN FILING LICENSE GRANTED" DOES NOT appear on this form. Applicant may still petition for a license under 37 CFR 5.12, if a license is desired before the expiration of 6 months from the filing date of the application. If 6 months has lapsed from the filing date of this application and the licensee has not received any indication of a secrecy order under 35 U.S.C. 181, the licensee may foreign file the application pursuant to 37 CFR 5.15(b).



## UNITED STATES PATENT AND TRADEMARK OFFICE

UNITED STATES DEPARTMENT OF COMMERCE  
**United States Patent and Trademark Office**  
 Address: COMMISSIONER FOR PATENTS  
 P.O. Box 1450  
 Alexandria, Virginia 22313-1450  
[www.uspto.gov](http://www.uspto.gov)

APPLICATION NUMBER	FILING OR 371(C) DATE	FIRST NAMED APPLICANT	ATTY. DOCKET NO./TITLE
12/211,033	09/15/2008	Roger J. Quy	00125/002005

**CONFIRMATION NO. 7693****PUBLICATION NOTICE**

27774  
 MAYER & WILLIAMS PC  
 251 NORTH AVENUE WEST  
 2ND FLOOR  
 WESTFIELD, NJ 07090

**Title:**METHOD AND APPARATUS FOR HEALTH AND DISEASE MANAGEMENT COMBINING PATIENT DATA MONITORING WITH WIRELESS INTERNET CONNECTIVITY

**Publication No.**US-2009-0069643-A1

**Publication Date:**03/12/2009

**NOTICE OF PUBLICATION OF APPLICATION**

The above-identified application will be electronically published as a patent application publication pursuant to 37 CFR 1.211, et seq. The patent application publication number and publication date are set forth above.

The publication may be accessed through the USPTO's publically available Searchable Databases via the Internet at [www.uspto.gov](http://www.uspto.gov). The direct link to access the publication is currently <http://www.uspto.gov/patft/>.

The publication process established by the Office does not provide for mailing a copy of the publication to applicant. A copy of the publication may be obtained from the Office upon payment of the appropriate fee set forth in 37 CFR 1.19(a)(1). Orders for copies of patent application publications are handled by the USPTO's Office of Public Records. The Office of Public Records can be reached by telephone at (703) 308-9726 or (800) 972-6382, by facsimile at (703) 305-8759, by mail addressed to the United States Patent and Trademark Office, Office of Public Records, Alexandria, VA 22313-1450 or via the Internet.

In addition, information on the status of the application, including the mailing date of Office actions and the dates of receipt of correspondence filed in the Office, may also be accessed via the Internet through the Patent Electronic Business Center at [www.uspto.gov](http://www.uspto.gov) using the public side of the Patent Application Information and Retrieval (PAIR) system. The direct link to access this status information is currently <http://pair.uspto.gov/>. Prior to publication, such status information is confidential and may only be obtained by applicant using the private side of PAIR.

Further assistance in electronically accessing the publication, or about PAIR, is available by calling the Patent Electronic Business Center at 1-866-217-9197.

Office of Data Management, Application Assistance Unit (571) 272-4000, or (571) 272-4200, or 1-888-786-0101



UNITED STATES PATENT AND TRADEMARK OFFICE

UNITED STATES DEPARTMENT OF COMMERCE  
 United States Patent and Trademark Office  
 Address: COMMISSIONER FOR PATENTS  
 P.O. Box 1450  
 Alexandria, Virginia 22313-1450  
 www.uspto.gov

APPLICATION NO.	FILING DATE	FIRST NAMED INVENTOR	ATTORNEY DOCKET NO.	CONFIRMATION NO.
12/211,033	09/15/2008	Roger J. Quy	00125/002005	7693
2774	7590	05/04/2009	EXAMINER ASTORINO, MICHAEL C	
MAYER & WILLIAMS PC 251 NORTH AVENUE WEST 2ND FLOOR WESTFIELD, NJ 07090			ART UNIT	PAPER NUMBER
			3769	
			MAIL DATE	DELIVERY MODE
			05/04/2009 PAPER	

**Please find below and/or attached an Office communication concerning this application or proceeding.**

The time period for reply, if any, is set in the attached communication.

<b>Office Action Summary</b>	<b>Application No.</b> 12/211,033	<b>Applicant(s)</b> QUY, ROGER J.	
	<b>Examiner</b> Michael C. Astorino	<b>Art Unit</b> 3769	

-- The MAILING DATE of this communication appears on the cover sheet with the correspondence address --

### Period for Reply

A SHORTENED STATUTORY PERIOD FOR REPLY IS SET TO EXPIRE 3 MONTH(S) OR THIRTY (30) DAYS, WHICHEVER IS LONGER, FROM THE MAILING DATE OF THIS COMMUNICATION.

- Extensions of time may be available under the provisions of 37 CFR 1.136(a). In no event, however, may a reply be timely filed after SIX (6) MONTHS from the mailing date of this communication.
- If NO period for reply is specified above, the maximum statutory period will apply and will expire SIX (6) MONTHS from the mailing date of this communication.
- Failure to reply within the set or extended period for reply will, by statute, cause the application to become ABANDONED (35 U.S.C. § 133). Any reply received by the Office later than three months after the mailing date of this communication, even if timely filed, may reduce any earned patent term adjustment. See 37 CFR 1.704(b).

### Status

- 1)  Responsive to communication(s) filed on 15 September 2008.
- 2a)  This action is **FINAL**.                      2b)  This action is non-final.
- 3)  Since this application is in condition for allowance except for formal matters, prosecution as to the merits is closed in accordance with the practice under *Ex parte Quayle*, 1935 C.D. 11, 453 O.G. 213.

### Disposition of Claims

- 4)  Claim(s) 1-12 is/are pending in the application.
- 4a) Of the above claim(s) \_\_\_\_\_ is/are withdrawn from consideration.
- 5)  Claim(s) \_\_\_\_\_ is/are allowed.
- 6)  Claim(s) 1-12 is/are rejected.
- 7)  Claim(s) \_\_\_\_\_ is/are objected to.
- 8)  Claim(s) \_\_\_\_\_ are subject to restriction and/or election requirement.

### Application Papers

- 9)  The specification is objected to by the Examiner.
- 10)  The drawing(s) filed on \_\_\_\_\_ is/are: a)  accepted or b)  objected to by the Examiner.  
Applicant may not request that any objection to the drawing(s) be held in abeyance. See 37 CFR 1.85(a).  
Replacement drawing sheet(s) including the correction is required if the drawing(s) is objected to. See 37 CFR 1.121(d).
- 11)  The oath or declaration is objected to by the Examiner. Note the attached Office Action or form PTO-152.

### Priority under 35 U.S.C. § 119

- 12)  Acknowledgment is made of a claim for foreign priority under 35 U.S.C. § 119(a)-(d) or (f).
- a)  All    b)  Some \*    c)  None of:
1.  Certified copies of the priority documents have been received.
  2.  Certified copies of the priority documents have been received in Application No. \_\_\_\_\_.
  3.  Copies of the certified copies of the priority documents have been received in this National Stage application from the International Bureau (PCT Rule 17.2(a)).

\* See the attached detailed Office action for a list of the certified copies not received.

### Attachment(s)

- |  |   |
|--|---|
| 1) <input checked="" type="checkbox"/> Notice of References Cited (PTO-892)                                | 4) <input type="checkbox"/> Interview Summary (PTO-413)<br>Paper No(s)/Mail Date. _____ |
| 2) <input type="checkbox"/> Notice of Draftsperson's Patent Drawing Review (PTO-948)                       | 5) <input type="checkbox"/> Notice of Informal Patent Application                       |
| 3) <input type="checkbox"/> Information Disclosure Statement(s) (PTO/SB/08)<br>Paper No(s)/Mail Date _____ | 6) <input type="checkbox"/> Other: _____  |

Application/Control Number: 12/211,033  
Art Unit: 3769

Page 2

## DETAILED ACTION

### *Specification*

The abstract of the disclosure is objected to because the abstract should be generally limited to a single paragraph on a separate sheet within the range of **50 to 150 words**.

Correction is required. See MPEP § 608.01(b).

### *Double Patenting*

The nonstatutory double patenting rejection is based on a judicially created doctrine grounded in public policy (a policy reflected in the statute) so as to prevent the unjustified or improper timewise extension of the "right to exclude" granted by a patent and to prevent possible harassment by multiple assignees. See *In re Goodman*, 11 F.3d 1046, 29 USPQ2d 2010 (Fed. Cir. 1993); *In re Longi*, 759 F.2d 887, 225 USPQ 645 (Fed. Cir. 1985); *In re Van Ornum*, 686 F.2d 937, 214 USPQ 761 (CCPA 1982); *In re Vogel*, 422 F.2d 438, 164 USPQ 619 (CCPA 1970); and, *In re Thorington*, 418 F.2d 528, 163 USPQ 644 (CCPA 1969).

A timely filed terminal disclaimer in compliance with 37 CFR 1.321(c) may be used to overcome an actual or provisional rejection based on a nonstatutory double patenting ground provided the conflicting application or patent is shown to be commonly owned with this application. See 37 CFR 1.130(b).

Effective January 1, 1994, a registered attorney or agent of record may sign a terminal disclaimer. A terminal disclaimer signed by the assignee must fully comply with 37 CFR 3.73(b).

Claims *1-12* are rejected under the judicially created doctrine of obviousness-type double patenting as being unpatentable over *claims 3-6, and 33-43* of U.S. Patent No. *6,602,191*.



Application/Control Number: 12/211,033  
Art Unit: 3769

Page 3

Although the conflicting claims are not identical, they are not patentably distinct from each other because it would have been obvious to one of ordinary skill in the art at the time of the invention to implement the method of the patent in the manner set forth in the instant application since the claims of the instant application are merely different renditions of the patented method and computer readable medium.

The Applicant is invited to explain, to make the record clear, reasons that the double patenting rejection does not apply.

***Claim Rejections - 35 USC § 112***

The following is a quotation of the second paragraph of 35 U.S.C. 112:

The specification shall conclude with one or more claims particularly pointing out and distinctly claiming the subject matter which the applicant regards as his invention.

**Claims 1-12 are rejected under 35 U.S.C. 112, second paragraph, as being indefinite for failing to particularly point out and distinctly claim the subject matter which applicant regards as the invention.**

The examiner cannot discern based on the specification the distinction between physiological data and exercise data. In fact, often times the two overlap. For example, heart rate could be "physiological data" and "exercise data". The broadest reasonable limitation of both terms cannot be discerned and as such the terms are indefinite.

The Applicant is invited to explain, to make the record clear, reasons that the rejection under 35 U.S.C. 112, second paragraph does not apply.

Application/Control Number: 12/211,033  
Art Unit: 3769

Page 4

***Claim Rejections - 35 USC § 102***

The following is a quotation of the appropriate paragraphs of 35 U.S.C. 102 that form the basis for the rejections under this section made in this Office action:

A person shall be entitled to a patent unless –

(e) the invention was described in (1) an application for patent, published under section 122(b), by another filed in the United States before the invention by the applicant for patent or (2) a patent granted on an application for patent by another filed in the United States before the invention by the applicant for patent, except that an international application filed under the treaty defined in section 351(a) shall have the effects for purposes of this subsection of an application filed in the United States only if the international application designated the United States and was published under Article 21(2) of such treaty in the English language.

**Claims 1-12 are rejected under 35 U.S.C. 102(b) as being anticipated by Brown US**

**Patent Number 5,997,476.**

Brown teaches the use of a remote apparatus (26/28) with a communication network (24, Internet) workstation (20) to remotely monitor a patient/user, (figure 1). The remote apparatus is disclosed as being on a cellular/wireless network, i.e. a cellular/wireless phone (column 4, lines 36-63). The remote apparatus includes many different types of monitoring devices including weight scales and heart rate/pulse rate (column 5, lines 3-6) with an RS-232 connection (column 6, lines 44-46). Brown's remote apparatus further includes a keyboard/buttons to input data regarding how people feel (see fig. 7).

**The Applicant is invited to request an interview to discuss suggestions to overcome the applied prior art.**

Application/Control Number: 12/211,033  
Art Unit: 3769

Page 5

***Conclusion***

Any inquiry concerning this communication or earlier communications from the examiner should be directed to Michael C. Astorino whose telephone number is (571)272-4723. The examiner can normally be reached on Monday-Friday, 8:30AM to 3:30PM.

If attempts to reach the examiner by telephone are unsuccessful, the examiner's supervisor, Henry Johnson can be reached on 571-272-4726. The fax phone number for the organization where this application or proceeding is assigned is 571-273-8300.

Information regarding the status of an application may be obtained from the Patent Application Information Retrieval (PAIR) system. Status information for published applications may be obtained from either Private PAIR or Public PAIR. Status information for unpublished applications is available through Private PAIR only. For more information about the PAIR system, see <http://pair-direct.uspto.gov>. Should you have questions on access to the Private PAIR system, contact the Electronic Business Center (EBC) at 866-217-9197 (toll-free). If you would like assistance from a USPTO Customer Service Representative or access to the automated information system, call 800-786-9199 (IN USA OR CANADA) or 571-272-1000.

/Michael C. Astorino/  
Primary Examiner, Art Unit 3769

May 3, 2009

<b>Notice of References Cited</b>	Application/Control No. 12/211,033	Applicant(s)/Patent Under Reexamination QUY, ROGER J.	
	Examiner Michael C. Astorino	Art Unit 3769	Page 1 of 1

**U.S. PATENT DOCUMENTS**

*	Document Number Country Code-Number-Kind Code	Date MM-YYYY	Name	Classification
*	A US-5,997,476	12-1999	Brown, Stephen J.	600/300
B	US-			
C	US-			
D	US-			
E	US-			
F	US-			
G	US-			
H	US-			
I	US-			
J	US-			
K	US-			
L	US-			
M	US-			

**FOREIGN PATENT DOCUMENTS**

*	Document Number Country Code-Number-Kind Code	Date MM-YYYY	Country	Name	Classification
N					
O					
P					
Q					
R					
S					
T					

**NON-PATENT DOCUMENTS**

*	Include as applicable: Author, Title Date, Publisher, Edition or Volume, Pertinent Pages)
U	
V	
W	
X	

\*A copy of this reference is not being furnished with this Office action. (See MPEP § 707.05(a).)  
 Dates in MM-YYYY format are publication dates. Classifications may be US or foreign.

<p><b>Search Notes</b></p> 	<p><b>Application/Control No.</b></p> <p>12211033</p>	<p><b>Applicant(s)/Patent Under Reexamination</b></p> <p>QUY, ROGER J.</p>
	<p><b>Examiner</b></p> <p>Michael C Astorino</p>	<p><b>Art Unit</b></p> <p>3769</p>

<b>SEARCHED</b>			
<b>Class</b>	<b>Subclass</b>	<b>Date</b>	<b>Examiner</b>
600	300-301 (text)	5/09	MA

<b>SEARCH NOTES</b>		
<b>Search Notes</b>	<b>Date</b>	<b>Examiner</b>
East search (class/subclass, inventor, parent cases backwards search)	5/09	MA

<b>INTERFERENCE SEARCH</b>			
<b>Class</b>	<b>Subclass</b>	<b>Date</b>	<b>Examiner</b>

--	--

## EAST Search History

Ref #	Hits	Search Query	DBs	Default Operator	Plurals	Time Stamp
L1	21	((ROGER) near2 (QY)).INV.	US-PGPUB; USPAT	OR	ON	2009/05/03 10:13
L2	2703446	method.clm.	US-PGPUB; USPAT; USOCR	OR	ON	2009/05/03 10:13
L3	18	method.clm. and 1	US-PGPUB; USPAT; USOCR	OR	ON	2009/05/03 10:14
L4	11	(internet).clm. and 3	US-PGPUB; USPAT; USOCR	OR	ON	2009/05/03 10:14
L5	4	(exercise).clm. and 3	US-PGPUB; USPAT; USOCR	OR	ON	2009/05/03 10:15
L6	3	(machine).clm. and 5	US-PGPUB; USPAT; USOCR	OR	ON	2009/05/03 10:16
S1	56	600/300-301.ccls. and (palm near2 pilot)	US-PGPUB; USPAT; JPO; DERWENT	OR	ON	2009/04/29 21:17
S2	49	600/300-301.ccls. and (palm near2 pilot) and (web internet)	US-PGPUB; USPAT; JPO; DERWENT	OR	ON	2009/04/29 21:19
S3	2	"6936007".pn.	US-PGPUB; USPAT; JPO; DERWENT	OR	ON	2009/05/02 16:30
S4	46	"6602191"	US-PGPUB; USPAT; JPO; DERWENT	OR	ON	2009/05/02 16:30
S5	3	"6602191".pn.	US-PGPUB; USPAT; JPO; DERWENT	OR	ON	2009/05/02 16:30
S6	4	S3 S5	US-PGPUB; USPAT; JPO; DERWENT	OR	ON	2009/05/02 16:31
S7	2	S6 and web\$.clm.	US-PGPUB; USPAT; JPO; DERWENT	OR	ON	2009/05/02 16:31
S8	2	S6 and web\$.clm. and method.clm.	US-PGPUB; USPAT; JPO; DERWENT	OR	ON	2009/05/02 16:41

S9	61	("20020016719"   "20020019584"   "20020026223"   "20020072785"   "20020082480"   "20020120310"   "20030004554"   "20030072424"   "20030139785"   "4282883"   "5307263"   "5357427"   "5434611"   "5544649"   "5544661"   "5549117"   "5553609"   "5601435"   "5626144"   "5678562"   "5704366"   "5724025"   "5732709"   "5735285"   "5752917"   "5772586"   "5791342"   "5933136"   "5935060"   "5941829"   "5951300"   "5959533"   "5964701"   "5967975"   "5987352"   "5987519"   "5997476"   "6022315"   "6024699"   "6050940"   "6055506"   "6057758"   "6059692"   "6083156"   "6101478"   "6144837"   "6160478"   "6168563"   "6190324"   "6266645"   "6319199"   "6336900"   "6375614"   "6386882"   "6416471"   "6418346"   "6440068"   "6450955"   "6458080"   "6529771"   "6602191").PN.	US-PGPUB; USPAT; USOCR	OR	ON	2009/05/02 16:42
----	----	--	---------------------------	----	----	---------------------

S10	36	("20020019584"   "4282883"   "5307263"   "5357427"   "5544661"   "5549117"   "5601435"   "5626144"   "5678562"   "5704366"   "5724025"   "5732709"   "5735285"   "5752917"   "5772586"   "5791342"   "5933136"   "5935060"   "5951300"   "5964701"   "5987519"   "5997476"   "6022315"   "6055506"   "6057758"   "6059692"   "6083156"   "6101478"   "6144837"   "6168563"   "6319199"   "6336900"   "6416471"   "6440068"   "6450955"   "6458080").PN.	US-PGPUB; USPAT; USOCR	OR	ON	2009/05/02 16:43
S11	62	S8 S9	US-PGPUB; USPAT; USOCR	OR	ON	2009/05/02 16:43
S12	1	S11 and heinonen.in.	US-PGPUB; USPAT; USOCR	OR	ON	2009/05/02 16:43
S13	0	S11 and heinonen.in. and (www intranet internet web)	US-PGPUB; USPAT; USOCR	OR	ON	2009/05/02 16:44
S14	1	S11 and linberg.in. and (www intranet internet web)	US-PGPUB; USPAT; USOCR	OR	ON	2009/05/02 16:44
S15	2	S11 and Nelson.in. and (www intranet internet web)	US-PGPUB; USPAT; USOCR	OR	ON	2009/05/02 16:44
S16	0	S11 and layson.in. and (www intranet internet web)	US-PGPUB; USPAT; USOCR	OR	ON	2009/05/02 16:44
S17	3	S14 S15	US-PGPUB; USPAT; USOCR	OR	ON	2009/05/02 16:44
S18	3	S14 S15 and (activity walk jog jogging run running basketball exercise)	US-PGPUB; USPAT; USOCR	OR	ON	2009/05/02 16:45



S19	3	S14 S15 and (activity walk jog jogging run running basketball exercise) and ((cell cellular wireless mobile) near3 (phone telephone))	US-PGPUB; USPAT; USOCR	OR	ON	2009/05/02 16:47
S20	1	phipps.in. and astorino.xa.	US-PGPUB; USPAT; USOCR	OR	ON	2009/05/02 16:52
S21	1	S5 and fat	US-PGPUB; USPAT; USOCR	OR	ON	2009/05/02 16:54
S22	49	600/300-301.ccls. and (palm near2 pilot) and (web internet)	US-PGPUB; USPAT; JPO; DERWENT	OR	ON	2009/05/02 16:57
S23	0	"5997476".pn. and S22	US-PGPUB; USPAT; USOCR	OR	ON	2009/05/02 16:57
S24	56	600/300-301.ccls. and (palm near2 pilot)	US-PGPUB; USPAT; JPO; DERWENT	OR	ON	2009/05/02 16:57
S25	0	"5997476".pn. and S24	US-PGPUB; USPAT; USOCR	OR	ON	2009/05/02 16:57
S26	0	"5997476".pn. and rs	US-PGPUB; USPAT; USOCR	OR	ON	2009/05/02 16:57
S27	1	"5997476".pn.	US-PGPUB; USPAT; USOCR	OR	ON	2009/05/02 16:58

5/ 3/ 09 10:33:49 AM

C:\ Documents and Settings\ mastorino\ My Documents\ EAST\ Workspaces\ 12211033.wsp

## Electronic Patent Application Fee Transmittal

<b>Application Number:</b>	12211033			
<b>Filing Date:</b>	15-Sep-2008			
<b>Title of Invention:</b>	METHOD AND APPARATUS FOR HEALTH AND DISEASE MANAGEMENT COMBINING PATIENT DATA MONITORING WITH WIRELESS INTERNET CONNECTIVITY			
<b>First Named Inventor/Applicant Name:</b>	Roger J. Quy			
<b>Filer:</b>	Karin L. Williams/Hellier Kelly			
<b>Attorney Docket Number:</b>	00125/002005			
Filed as Large Entity				
<b>Utility under 35 USC 111(a) Filing Fees</b>				
<b>Description</b>	<b>Fee Code</b>	<b>Quantity</b>	<b>Amount</b>	<b>Sub-Total in USD(\$)</b>
<b>Basic Filing:</b>				
<b>Pages:</b>				
<b>Claims:</b>				
<b>Miscellaneous-Filing:</b>				
<b>Petition:</b>				
<b>Patent-Appeals-and-Interference:</b>				
<b>Post-Allowance-and-Post-Issuance:</b>				
<b>Extension-of-Time:</b>				

Description	Fee Code	Quantity	Amount	Sub-Total in USD(\$)
<b>Miscellaneous:</b>				
Submission- Information Disclosure Stmt	1806	1	180	180
<b>Total in USD (\$)</b>				<b>180</b>

**Electronic Acknowledgement Receipt**

<b>EFS ID:</b>	5308461
<b>Application Number:</b>	12211033
<b>International Application Number:</b>	
<b>Confirmation Number:</b>	7693
<b>Title of Invention:</b>	METHOD AND APPARATUS FOR HEALTH AND DISEASE MANAGEMENT COMBINING PATIENT DATA MONITORING WITH WIRELESS INTERNET CONNECTIVITY
<b>First Named Inventor/Applicant Name:</b>	Roger J. Quy
<b>Customer Number:</b>	27774
<b>Filer:</b>	Karin L. Williams/Hellier Kelly
<b>Filer Authorized By:</b>	Karin L. Williams
<b>Attorney Docket Number:</b>	00125/002005
<b>Receipt Date:</b>	11-MAY-2009
<b>Filing Date:</b>	15-SEP-2008
<b>Time Stamp:</b>	12:58:17
<b>Application Type:</b>	Utility under 35 USC 111(a)

**Payment information:**

Submitted with Payment	yes
Payment Type	Deposit Account
Payment was successfully received in RAM	\$ 180
RAM confirmation Number	7780
Deposit Account	501047
Authorized User	

The Director of the USPTO is hereby authorized to charge indicated fees and credit any overpayment as follows:

Charge any Additional Fees required under 37 C.F.R. Section 1.16 (National application filing, search, and examination fees)

Charge any Additional Fees required under 37 C.F.R. Section 1.17 (Patent application and reexamination processing fees)

Charge any Additional Fees required under 37 C.F.R. Section 1.19 (Document supply fees)

Charge any Additional Fees required under 37 C.F.R. Section 1.20 (Post Issuance fees)

Charge any Additional Fees required under 37 C.F.R. Section 1.21 (Miscellaneous fees and charges)

**File Listing:**

Document Number	Document Description	File Name	File Size(Bytes)/ Message Digest	Multi Part /.zip	Pages (if appl.)
1	Transmittal Letter	205114C4_00125_002005_Transmittal.pdf	113760 <small>fcf54252681d893f5b3659067da6c2fd9c04e7b1</small>	no	3

**Warnings:****Information:**

2	Information Disclosure Statement (IDS) Filed (SB/08)	205114C4_00125_002005_IDS.pdf	4496210 <small>3841805214b5fa9a83d3f1f55a2e686c560e98b5</small>	no	12
---	--	-------------------------------	--	----	----

**Warnings:****Information:**

This is not an USPTO supplied IDS fillable form

3	Fee Worksheet (PTO-875)	fee-info.pdf	30680 <small>296e09d298a1bbfa48ceac0e8c2d0e5291c69a67</small>	no	2
---	-------------------------	--------------	--	----	---

**Warnings:****Information:**

<b>Total Files Size (in bytes):</b>	4640650
-------------------------------------	---------

This Acknowledgement Receipt evidences receipt on the noted date by the USPTO of the indicated documents, characterized by the applicant, and including page counts, where applicable. It serves as evidence of receipt similar to a Post Card, as described in MPEP 503.

**New Applications Under 35 U.S.C. 111**

If a new application is being filed and the application includes the necessary components for a filing date (see 37 CFR 1.53(b)-(d) and MPEP 506), a Filing Receipt (37 CFR 1.54) will be issued in due course and the date shown on this Acknowledgement Receipt will establish the filing date of the application.

**National Stage of an International Application under 35 U.S.C. 371**

If a timely submission to enter the national stage of an international application is compliant with the conditions of 35 U.S.C. 371 and other applicable requirements a Form PCT/DO/EO/903 indicating acceptance of the application as a national stage submission under 35 U.S.C. 371 will be issued in addition to the Filing Receipt, in due course.

**New International Application Filed with the USPTO as a Receiving Office**

If a new international application is being filed and the international application includes the necessary components for an international filing date (see PCT Article 11 and MPEP 1810), a Notification of the International Application Number and of the International Filing Date (Form PCT/RO/105) will be issued in due course, subject to prescriptions concerning national security, and the date shown on this Acknowledgement Receipt will establish the international filing date of the application.

Docket No.: 00125/002005

IN THE UNITED STATES PATENT AND TRADEMARK OFFICE

Applicants: Roger J. Quy
Application No.: 12/211,033
Date Filed: 09/15/2008
Title: METHOD AND APPARATUS FOR HEALTH AND DISEASE MANAGEMENT COMBINING PATIENT DATA MONITORING WITH WIRELESS INTERNET CONNECTIVITY
Group Art Unit.: 3769
Confirmation No.: 7693
Atty. Docket No.: 00125/002005

INFORMATION DISCLOSURE STATEMENT (IDS)

VIA EFS WEB
Mail Stop Amendment
Commissioner for Patents
P.O. Box 1450
Alexandria, VA 22313-1450

SIR:

In accordance with 37 C.F.R. §1.56 and in compliance with 37 C.F.R. §§1.97 and 1.98, the references listed on attached Form PTO/SB/08 and/or subsequently identified herein, are being submitted herewith for consideration by the United States Patent and Trademark Office.

I. COPIES

- a. [ ] A legible copy of (i) each foreign patent; (ii) each publication or that portion which caused it to be listed; and (iii) all other information or that portion which caused it to be listed, is included herewith.
b. [X] Any patents, publications or other information which are listed on PTO/SB/08 which are not enclosed herewith were previously cited by or submitted to the PTO in one of the following applications which has been relied upon for an earlier filing date under 35 U.S.C. §120:

Table with 3 columns: U.S. Serial Number, U.S. Filing Date, Status. Rows include 11/649,703 (Abandoned), 10/418,845 (now U.S. Pat. No. 6,936,007), 09/738,270 (now U.S. Pat. No. 6,602,191), and 11/184,274 (now U.S. Pat. No. 7,156,808).

II. CONCISE EXPLANATION OF THE RELEVANCE (check at least one box)

- a. [X] Except as may be indicated below in (b) of this section, all of the patents, publications or other information are in the English language (concise explanation not required).
b. [ ] A concise explanation of the relevance of all patents, publications or other information listed that is not in the English language is as follows:
c. [ ] The following additional information is provided for the Examiner's consideration:

III. [ ] CROSS REFERENCE TO RELATED APPLICATION(S)

The Examiner is advised that the following co-pending application(s) contain(s) subject matter that may be related to the present application. By bringing this (these) applications to the Examiner's attention, Applicant(s) does (do) not waive the confidentiality provisions of 35 U.S.C. §122.

Serial No. Filing Date Art Unit

Docket No.: 00125/002005

**FEES**

- IV.  THIS IDS IS BEING FILED UNDER 37 C.F.R. §1.97(b): (check one box)
- a.  within three months of the filing date of a national application other than a continued prosecution application under § 1.53(d) (37 C.F.R. §1.97(b)(1)). No fee or statement is required.
- b.  within three months of the date of entry of the national stage as set forth in § 1.491 in an international application (37 C.F.R. §1.97(b)(2)). No fee or statement is required.
- c.  before the mailing date of a first Office Action on the merits (37 C.F.R. §1.97(b)(3)). No fee or statement is required.
- d.  before the mailing date of a first Office Action after the filing of a request for continued examination under § 1.114 (37 C.F.R. § 1.97(b)(4)). No fee or statement is required.
- V.  THIS IDS IS BEING FILED UNDER 37 C.F.R. §1.97(c): (check one box)  
before the mailing date of any of a Final Office Action under 37 C.F.R. §1.113, a Notice of Allowance under 37 C.F.R. §1.311, or an action that otherwise closes prosecution in the application (See 37 C.F.R. §1.97(c)).
- a.  No statement; therefore, charge deposit account 50-1047 the fee set forth in 37 C.F.R. §1.17(p).
- b.  See the statement below. No fee is required.
- VI.  THIS IDS IS BEING FILED UNDER 37 C.F.R. §1.97(d):  
on or before payment of the issue fee and is accompanied by the following:
- 1) a statement under 37 C.F.R. §1.97(e) as provided below; and
- 2) charge deposit account 50-1047 the petition fee set forth in §1.17(p).
- VII.  STATEMENT UNDER 37 C.F.R. §1.97(e) (check only one box, if applicable)  
The undersigned hereby states that
- a.  each item of information contained in the IDS was cited in a communication from a foreign Patent Office in a counterpart foreign application not more than three months prior to the filing of IDS; or
- b.  no item of information contained in the IDS was cited in a communication from a foreign Patent Office in a counterpart foreign application, and to knowledge of the person signing the statement after making reasonable inquiry, no item of information contained in the IDS was known to any individual designated in 37 C.F.R. 1.56(c) more than three months prior to the filing of this statement, or
- c.  some of the items of information contained in the IDS were cited in a communication from a foreign Patent Office. As to this information, the undersigned states that each item of information contained in the IDS was cited in a communication from a foreign Patent Office in a counterpart foreign application not more than three months prior to the filing of this IDS. As to the remaining information, the undersigned hereby states that no item of this remaining information contained in the IDS was cited in a communication from a foreign Patent Office in a counterpart foreign application or, to the knowledge of the person signing the statement after making reasonable inquiry, no item of information contained in the IDS was known to any individual designated in 37 C.F.R. 1.56(c) more than three months prior to the filing of this statement.
- VIII. PAYMENT OF FEES
- A check in the amount of \_\_\_\_\_ is enclosed for the above-identified fee(s).
- Please charge Deposit Account No. 50-1047 in the amount of \$180.00 for the above-indicated fee(s).
- If Applicant has overlooked any additional fees, or if any overpayment has been made, the Commissioner is hereby authorized to credit or debit Deposit Account 50-1047.
- Two Copies of this paper are attached for Deposit Account charges and debits.

Docket No.: 00125/002005

It is Applicant(s)' opinion that the claims presently on file patently distinguish the present invention from each of these references. The above references are being cited only in the interests of candor and without any admission that they constitute statutory prior art or contain matter which anticipates the invention or which would render the same obvious, either singly or in a combination, to a person of ordinary skill in the art.

If the Examiner has any questions concerning this IDS, he/she is requested to contact the undersigned. If it is determined that this IDS has been filed under the wrong rule, the PTO is requested to consider this IDS under the proper rule (with a petition if necessary) and charge the appropriate fee to Deposit Account No. 50-1047.

Respectfully submitted,

/Mark Wieczorek/

MAYER & WILLIAMS PC  
Customer Number 27774

Mark D. Wieczorek  
Attorney for Applicant(s)  
Reg. No. 37,966  
Tel.: 619-818-4615  
Fax: 908-518-7795

Enclosures:  PTO/SB/08  
 References  
 Foreign Search Report  
 Other:

**Certificate of Electronic Filing Under**  
**37 C.F.R. §1.8**

I certify that this correspondence and any document reference herein is being electronically deposited with the USPTO via EFS-Web on 05/11/2009.

Hellier Kelly  
(Printed Name of Person Mailing  
Correspondence)  
/Hellier Kelly/  
(Signature)



Docket No.: 00125/002005

**IN THE UNITED STATES PATENT AND TRADEMARK OFFICE**

Applicants: Roger J. Quy  
 Application No.: 12/211,033  
 Date Filed: 09/15/2008  
 Title: METHOD AND APPARATUS FOR HEALTH AND DISEASE  
 MANAGEMENT COMBINING PATIENT DATA MONITORING WITH  
 WIRELESS INTERNET CONNECTIVITY  
 Group Art Unit.: 3769  
 Confirmation No.: 7693  
 Atty. Docket No.: 00125/002005

**INFORMATION DISCLOSURE STATEMENT (IDS)**

VIA EFS WEB  
 Mail Stop Amendment  
 Commissioner for Patents  
 P.O. Box 1450  
 Alexandria, VA 22313-1450

SIR:

In accordance with 37 C.F.R. §1.56 and in compliance with 37 C.F.R. §§1.97 and 1.98, the references listed on attached Form PTO/SB/08 and/or subsequently identified herein, are being submitted herewith for consideration by the United States Patent and Trademark Office.

I. COPIES

- a.  A legible copy of (i) each foreign patent; (ii) each publication or that portion which caused it to be listed; and (iii) all other information or that portion which caused it to be listed, is included herewith.
- b.  Any patents, publications or other information which are listed on PTO/SB/08 which are not enclosed herewith were previously cited by or submitted to the PTO in one of the following applications which has been relied upon for an earlier filing date under 35 U.S.C. §120:

<u>U.S. Serial Number</u>	<u>U.S. Filing Date</u>	<u>Status</u>
11/649,703	01/03/2007	Abandoned
10/418,845	04/18/2003	now U.S. Pat. No. 6,936,007
09/738,270	12/15/2000	now U.S. Pat. No. 6,602,191
11/184,274	07/18/2005	now U.S. Pat. No. 7,156,808

II. CONCISE EXPLANATION OF THE RELEVANCE (check at least one box)

- a.  Except as may be indicated below in (b) of this section, all of the patents, publications or other information are in the English language (concise explanation not required).
- b.  A concise explanation of the relevance of all patents, publications or other information listed that is not in the English language is as follows:
- c.  The following additional information is provided for the Examiner's consideration:

III.  CROSS REFERENCE TO RELATED APPLICATION(S)

The Examiner is advised that the following co-pending application(s) contain(s) subject matter that may be related to the present application. By bringing this (these) applications to the Examiner's attention, Applicant(s) does (do) not waive the confidentiality provisions of 35 U.S.C. §122.

<u>Serial No.</u>	<u>Filing Date</u>	<u>Art Unit</u>
-------------------	--------------------	-----------------

Docket No.: 00125/002005

**FEES**

- IV.  THIS IDS IS BEING FILED UNDER 37 C.F.R. §1.97(b): (check one box)
- a.  within three months of the filing date of a national application other than a continued prosecution application under § 1.53(d) (37 C.F.R. §1.97(b)(1)). No fee or statement is required.
- b.  within three months of the date of entry of the national stage as set forth in § 1.491 in an international application (37 C.F.R. §1.97(b)(2)). No fee or statement is required.
- c.  before the mailing date of a first Office Action on the merits (37 C.F.R. §1.97(b)(3)). No fee or statement is required.
- d.  before the mailing date of a first Office Action after the filing of a request for continued examination under § 1.114 (37 C.F.R. § 1.97(b)(4)). No fee or statement is required.
- V.  THIS IDS IS BEING FILED UNDER 37 C.F.R. §1.97(c): (check one box)  
before the mailing date of any of a Final Office Action under 37 C.F.R. §1.113, a Notice of Allowance under 37 C.F.R. §1.311, or an action that otherwise closes prosecution in the application (See 37 C.F.R. §1.97(c)).
- a.  No statement; therefore, charge deposit account 50-1047 the fee set forth in 37 C.F.R. §1.17(p).
- b.  See the statement below. No fee is required.
- VI.  THIS IDS IS BEING FILED UNDER 37 C.F.R. §1.97(d):  
on or before payment of the issue fee and is accompanied by the following:
- 1) a statement under 37 C.F.R. §1.97(e) as provided below; and
- 2) charge deposit account 50-1047 the petition fee set forth in §1.17(p).
- VII.  STATEMENT UNDER 37 C.F.R. §1.97(e) (check only one box, if applicable)  
The undersigned hereby states that
- a.  each item of information contained in the IDS was cited in a communication from a foreign Patent Office in a counterpart foreign application not more than three months prior to the filing of IDS; or
- b.  no item of information contained in the IDS was cited in a communication from a foreign Patent Office in a counterpart foreign application, and to knowledge of the person signing the statement after making reasonable inquiry, no item of information contained in the IDS was known to any individual designated in 37 C.F.R. 1.56(c) more than three months prior to the filing of this statement, or
- c.  some of the items of information contained in the IDS were cited in a communication from a foreign Patent Office. As to this information, the undersigned states that each item of information contained in the IDS was cited in a communication from a foreign Patent Office in a counterpart foreign application not more than three months prior to the filing of this IDS. As to the remaining information, the undersigned hereby states that no item of this remaining information contained in the IDS was cited in a communication from a foreign Patent Office in a counterpart foreign application or, to the knowledge of the person signing the statement after making reasonable inquiry, no item of information contained in the IDS was known to any individual designated in 37 C.F.R. 1.56(c) more than three months prior to the filing of this statement.
- VIII. PAYMENT OF FEES
- A check in the amount of \_\_\_\_\_ is enclosed for the above-identified fee(s).
- Please charge Deposit Account No. 50-1047 in the amount of \$180.00 for the above-indicated fee(s).
- If Applicant has overlooked any additional fees, or if any overpayment has been made, the Commissioner is hereby authorized to credit or debit Deposit Account 50-1047.
- Two Copies of this paper are attached for Deposit Account charges and debits.

Docket No.: 00125/002005

It is Applicant(s)' opinion that the claims presently on file patently distinguish the present invention from each of these references. The above references are being cited only in the interests of candor and without any admission that they constitute statutory prior art or contain matter which anticipates the invention or which would render the same obvious, either singly or in a combination, to a person of ordinary skill in the art.

If the Examiner has any questions concerning this IDS, he/she is requested to contact the undersigned. If it is determined that this IDS has been filed under the wrong rule, the PTO is requested to consider this IDS under the proper rule (with a petition if necessary) and charge the appropriate fee to Deposit Account No. 50-1047.

Respectfully submitted,

/Mark Wieczorek/

MAYER & WILLIAMS PC  
Customer Number 27774

Mark D. Wieczorek  
Attorney for Applicant(s)  
Reg. No. 37,966  
Tel.: 619-818-4615  
Fax: 908-518-7795

Enclosures:  PTO/SB/08  
 References  
 Foreign Search Report  
 Other:

**Certificate of Electronic Filing Under**  
**37 C.F.R. §1.8**

I certify that this correspondence and any document reference herein is being electronically deposited with the USPTO via EFS-Web on 05/11/2009.

Hellier Kelly  
(Printed Name of Person Mailing  
Correspondence)  
/Hellier Kelly/  
(Signature)

PTO/SB/08a (05-07)

Approved for use through 11/30/2007. OMB 0651-0031  
 U.S. Patent and Trademark Office; U.S. DEPARTMENT OF COMMERCE

Under the Paperwork Reduction Act of 1995, no persons are required to respond to a collection of information unless it contains a valid OMB control number.

<b>INFORMATION DISCLOSURE                  STATEMENT BY APPLICANT</b> ( Not for submission under 37 CFR 1.99)	Application Number	12211033
	Filing Date	2008-09-15
	First Named Inventor	Roger J. Quy
	Art Unit	3769
	Examiner Name	Michael C. Astorino
	Attorney Docket Number	00125/002005

U.S.PATENTS						
Examiner Initial*	Cite No	Patent Number	Kind Code <sup>1</sup>	Issue Date	Name of Patentee or Applicant of cited Document	Pages, Columns, Lines where Relevant Passages or Relevant Figures Appear
	1	5576952		1996-11-19	Stutman et al.	
	2	6093146		2000-07-25	Filangeri	
	3	6478736		2002-11-12	Mault	
	4	6610012	B2	2003-08-26	Mault	
	5	6856832		2005-02-15	Matsumura et al.	
	6	6936007	B2	2005-08-30	Quy	
	7	6976958	B2	2005-12-20	Quy	

If you wish to add additional U.S. Patent citation information please click the Add button.

**U.S.PATENT APPLICATION PUBLICATIONS**

**INFORMATION DISCLOSURE  
STATEMENT BY APPLICANT**  
( Not for submission under 37 CFR 1.99)

Application Number		12211033
Filing Date		2008-09-15
First Named Inventor	Roger J. Quy	
Art Unit	3769	
Examiner Name	Michael C. Astorino	
Attorney Docket Number	00125/002005	

U.S. PATENT DOCUMENTS						
Examiner Initials <sup>1</sup>	Cite No. <sup>1</sup>	U.S. Patent Document		Name of Patentee or Applicant of Cited Document	Date of Publications of Cited document MM-DD-YYYY	Pages, Column, Lines, Where Relevant Passages or Relevant Figures Appear
		Number	Kind Code <sup>2</sup> (if known)			
	AA	60/264,739		Posa et al.	01/2001	
	AB	4,282,883		Yerushalmy	08/1981	
	AC	5,012,814		Mills et al.	05/1991	
	AD	5,307,263		Brown	04/1994	
	AE	5,357,427		Langen et al.	10/1994	
	AF	5,434,611		Tamura	07/1995	
	AG	5,441,047		David et al.	08/1995	
	AH	5,544,649		David et al.	09/1996	
	AJ	5,544,661		Davis et al.	08/1996	
	AJ	5,549,117		Tacklind et al.	08/1996	
	AK	5,553,609		Chen et al.	09/1996	
	AL	5,601,435		Quy	02/1997	
	AM	5,626,144		Tacklind et al.	05/1997	
	AN	5,678,562		Sellers	10/1997	
	AO	5,701,904		Simmons et al.	12/1997	
	AP	5,704,366		Tacklind, et al	01/1998	
	AQ	5,724,025		Tavori	03/1998	
	AR	5,732,709		Tacklind, et al	03/1998	
	AS	5,735,285		Albert, et al.	04/1998	
	AT	5,752,917		Fuchs	05/1998	
	AU	5,772,586		Heinonen, et al.	06/1998	
	AV	5,791,342		Woodard	09/1998	
	AW	5,931,791		Saltzstein et al.	08/1999	
	AX	5,933,136		Brown	08/1999	
	AY	5,935,060		Iliff	08/1999	
	AZ	5,941,829		Saltzstein et al.	08/1999	
	BA	5,951,300		Brown	09/1999	
	BB	5,959,533		Layson et al.	09/1999	
	BC	5,964,701		Asada, et al.	10/1999	
	BD	5,967,975		Ridgeway, Donald G.	10/1999	
	BE	5,987,352		Klein et al.	11/1999	
	BF	5,987,519		Peifer, et al.	10/1999	
	BG	5,997,476		Brown	12/1999	
	BH	6,022,315		Iliff	02/2000	
	BI	6,024,699		Surwit et al.	02/2000	
	BJ	6,050,940		Braun et al.	04/2000	
	BK	6,055,506		Frasca, Jr.	04/2000	
	BL	6,057,758		Dempsey, et al.	05/2000	

Examiner Signature	Date Considered
--------------------	-----------------

<sup>1</sup>EXAMINER: Initial if reference considered, whether or not citation is in conformance with MPEP 609. Draw line through citation if not in conformance and not considered. Include copy of this form with next communication to applicant.  
<sup>2</sup>Unique citation designation number. <sup>3</sup>Applicant is to place a check mark here if English language translation is attached.  
 Burden Hour Statement: This form is estimated to take 2.0 hours to complete. Time will vary depending upon the needs of the individual case. Any comments on the amount of time you are required to complete this form should be sent to the Chief Information Officer, Patent and trademark Office, Washington, DC 20231.

<b>INFORMATION DISCLOSURE STATEMENT BY APPLICANT</b> ( Not for submission under 37 CFR 1.99)	Application Number		12211033
	Filing Date		2008-09-15
	First Named Inventor	Roger J. Quy	
	Art Unit	3769	
	Examiner Name	Michael C. Astorino	
	Attorney Docket Number	00125/002005	

U.S. PATENT DOCUMENTS						
Examiner Initials <sup>1</sup>	Cite No. <sup>1</sup>	U.S. Patent Document		Name of Patentee or Applicant of Cited Document	Date of Publications of Cited document MM-DD-YYYY	Pages, Column, Lines, Where Relevant Passages or Relevant Figures Appear
		Number	Kind Code <sup>2</sup> (if known)			
	BM	6,059,692		Hickman	05/2000	
	BN	6,083,156		Leselcki	07/2000	
	BO	6,101,478		Brown	08/2000	
	BP	6,144,837		Quy	11/2000	
	BQ	6,160,478		Jacobsen et al.	12/2000	
	BR	6,168,563		Brown	01/2001	
	BS	6,190,324		Kleval et al.	02/2001	
	BT	6,266,645		Simpson	07/2001	
	BU	6,319,199		Sheehan et al.	11/2001	
	BV	6,336,900		Alleckson et al.	01/2001	
	BW	6,375,614		Braun et al.	04/2002	
	BX	6,386,882		Lindberg	05/2002	
	BY	6,416,471		Kumar et al.	07/2002	
	BZ	6,418,346		Nelson et al.	07/2002	
	CA	6,440,068		Brown et al.	08/2002	
	CB	6,450,955		Brown et al.	09/2002	
	CC	6,458,080		Brown et al.	10/2002	
	CD	6,529,771		Kieval et al.	03/2003	
	CE	6,602,191		Quy	08/2003	
	CF	20020016719		Nemeth et al.	02/2002	
	CG	20020019584		Schultze et al.	02/2002	
	CH	20020026223		Riff et al.	02/2002	
	CI	20020072785		Nelson et al.	06/2002	
	CJ	20020082480		Riff et al.	06/2002	
	CK	20020120310		Linden et al.	08/2002	
	CL	20030004554		Riff et al.	01/2003	
	CM	20030072424		Evans et al.	04/2003	
	CN	20030139785		Riff et al.	07/2003	
	CO	20030204413		Riff	10/2003	

FOREIGN PATENT DOCUMENTS							
Examiner Initials <sup>1</sup>	Cite No. <sup>1</sup>	Foreign Patent Document		Name of Patentee or Applicant of Cited Document	Date of Publications of Cited document MM-DD-YYYY	Pages, Column, Lines, Where Relevant Passages or Relevant Figures Appear	T <sup>3</sup>
		Office <sup>3</sup>	Number <sup>3</sup>				
	CP		WO 95/32480	ENACT PRODUCTS	11/1995		
	CQ		WO 97/28736	NOKIA MOBILE PHONES LTD	08/1997		

Examiner Signature		Date Considered	
--------------------	--	-----------------	--

<sup>1</sup>EXAMINER: Initial if reference considered, whether or not citation is in conformance with MPEP 609. Draw line through citation if not in conformance and not considered. Include copy of this form with next communication to applicant.

<sup>2</sup>Unique citation designation number. <sup>3</sup>Applicant is to place a check mark here if English language Translation is attached.

Burden Hour Statement: This form is estimated to take 2.0 hours to complete. Time will vary depending upon the needs of the individual case. Any comments on the amount of time you are required to complete this form should be sent to the Chief Information Officer, Patent and trademark Office, Washington, DC 20231.

**INFORMATION DISCLOSURE STATEMENT BY APPLICANT**  
( Not for submission under 37 CFR 1.99)

Application Number	12211033
Filing Date	2008-09-15
First Named Inventor	Roger J. Quy
Art Unit	3769
Examiner Name	Michael C. Astorino
Attorney Docket Number	00125/002005

FOREIGN PATENT DOCUMENTS								
Examiner Initials <sup>1</sup>	Cite No. <sup>2</sup>	Office <sup>3</sup>	Number <sup>4</sup>	Kind Code <sup>5</sup> ( If known)	Name of Patentee or Applicant of Cited Document	Date of Publications of Cited document MM-DD-YYYY	Pages, Column, Lines, Where Relevant Passages or Relevant Figures Appear	T <sup>6</sup>
	CR		WO 97/28737		NOKIA MOBILE PHONES LTD	08/1997		
	CS		WO 98/24358		ENACT HEALTH MANAGEMENT SYSTEMS	06/1998		
	CT		WO 98/38909		INFORMEDIX, INC	09/1998		
	CU		WO 99/04687		OPTS, INC	02/1999		
	CV		WO 99/14882		GEORGIA TECH RESEARCH CORPORATION	03/1999		
	CW		WO 99/41682		SOUTHERN RESEARCH INSTITUTE	08/1999		
	CX		WO 99/44494		CARD GUARD SCIENTIFIC SURVIVAL LTD	09/1999		
	CY		WO 99/46718		HEALTHWARE CORPORATION	09/1999		
	CZ		WO 00/36900		FOURIE, Louise	06/2000		
	DA		WO 00/40145		CRITICARE SYSTEMS	07/2000		
	DB		WO 00/54205		AC PROPERTIES B.V.	09/2000		
	DC		WO 00/54206		AC PROPERTIES B.V.	09/2000		
	DD		WO 00/62662		CARDIOCOM	10/2000		
	DE		WO 01/24038		Imetrikus, Inc.	04/2001		

OTHER PRIOR ART--NON-PATENT LITERATURE DOCUMENTS			
Examiner Initials <sup>1</sup>	Cite No. <sup>2</sup>	Include name of the author (in CAPITAL LETTERS), title of the article (when appropriate), title of the item (book, magazine, journal, serial, symposium, catalog, etc.), date, page(s), volume-issue number(s), publisher, city and/or country where published.	T <sup>3</sup>
	DF	Jyrki Oraskari ; "Bluetooth versus WLAN IEEE 802.11x" ; Helsinki University of Technology (Department of Computer Science and Engineering) November, 2000	
	DG	Jack Smith ; Your Personal Health Buddy; ABCNews.com; <a href="http://abcnews.go.com/sections/tech/CuttingEdge/cuttingedge990225.html">http://abcnews.go.com/sections/tech/CuttingEdge/cuttingedge990225.html</a> ; 3 pages (November 24, 2000)	
	DH	The Health Hero Communications Platform ; The Health Hero Network Online Services ; <a href="http://www.hhn.com/products/index.html">http://www.hhn.com/products/index.html</a> ; 2 pages (November 24, 2000)	

Examiner Signature	Date Considered
--------------------	-----------------

<sup>1</sup>EXAMINER: Initial if reference considered, whether or not citation is in conformance with MPEP 609. Draw line through citation if not in conformance and not considered. Include copy of this form with next communication to applicant.  
<sup>2</sup>Unique citation designation number. <sup>3</sup>Applicant is to place a check mark here if English language Translation is attached.  
 Burden Hour Statement: This form is estimated to take 2.0 hours to complete. Time will vary depending upon the needs of the individual case. Any comments on the amount of time you are required to complete this form should be sent to the Chief Information Officer, Patent and Trademark Office, Washington, DC 20231.

<b>INFORMATION DISCLOSURE STATEMENT BY APPLICANT</b> ( Not for submission under 37 CFR 1.99)	Application Number		12211033	
	Filing Date		2008-09-15	
	First Named Inventor	Roger J. Quy		
	Art Unit	3769		
	Examiner Name	Michael C. Astorino		
	Attorney Docket Number	00125/002005		

Examiner Initials*	Cite No. <sup>1</sup>	U.S. Patent Document		Name of Patentee or Applicant of Cited Document	Issue Date MM-DD-YYYY
		Number	Class/Subclass		

Examiner Initials*	Cite No. <sup>1</sup>	U.S. Patent Publication		Name of Patentee or Applicant of Cited Document	Date of Publication of Cited Document MM-DD-YYYY
		Number	Class/Subclass		

Examiner Initials*	Cite No. <sup>1</sup>	Foreign Patent Document			Name of Patentee or Applicant of Cited Document	Date of Publication of Cited Document MM-DD-YYYY	T
		Office <sup>2</sup>	Number	Class/ Subclass			
	1.	JP	11259783 English Abstract Included	A61B5/00	Seiko Precision KK, et al.	09/24/1999	X
	2.	JP	11122369 English Abstract Included	H04Q7/38	NEC Saitama Ltd	04/30/1999	X
	3.	JP	11047101 English Abstract Included	A61B5/00	TOTO Ltd	02/23/1999	X
	4.	JP	9224917 English Abstract Included	G08C19/00	Yoshida Masao	09/02/1997	X
	5.	JP	2002/344660 A English Abstract only	A61 B5/00	Nec Fielding Ltd.	11-29-2002	X

OTHER PRIOR ART - NON PATENT LITERATURE DOCUMENTS			
Examiner Initials*	Cite No. <sup>1</sup>	Include name of the author (in CAPITAL LETTERS), title of the article (when appropriate), title of the item (book, magazine, journal, serial, symposium, catalog, etc.), date, page(s), volume-issue number(s), publisher, city and/or country where published.	T <sup>2</sup>
	1.	"Cell Phones Cameras Put Doctors in the Picture", February 21, 2005, 1 page, <a href="http://news.healingwell.com/index.php?p=news1&amp;id=524118">http://news.healingwell.com/index.php?p=news1&amp;id=524118</a>	

Examiner Signature	Date Considered
--------------------	-----------------

\*EXAMINER: Initial if reference considered, whether or not citation is in conformance with MPEP 609. Draw line through citation if not in conformance and not considered. Include copy of this form with next communication to applicant.

<sup>1</sup>Unique citation designation number. <sup>2</sup>Applicant is to place a check mark here if English language Translation is attached.  
Burden Hour Statement: This form is estimated to take 2.0 hours to complete. Time will vary depending upon the needs of the individual case. Any comments on the amount of time you are required to complete this form should be sent to the Chief Information Officer, Patent and trademark Office, Washington, DC 20231. DO NOT SEND FEES OR COMPLETED FORMS TO THIS ADDRESS. SEND TO: Assistant Commissioner for Patents, Washington, DC 20231.



**INFORMATION DISCLOSURE  
STATEMENT BY APPLICANT**  
( Not for submission under 37 CFR 1.99)

Application Number	12211033
Filing Date	2008-09-15
First Named Inventor	Roger J. Quy
Art Unit	3769
Examiner Name	Michael C. Astorino
Attorney Docket Number	00125/002005

		OTHER PRIOR ART—NON-PATENT LITERATURE DOCUMENTS	
Examiner Initials <sup>1</sup>	Cite No. <sup>1</sup>	Include name of the author (in CAPITAL LETTERS), title of the article (when appropriate), title of the item (book, magazine, journal, serial, symposium, catalog, etc.), date, page(s), volume-issue number(s), publisher, city and/or country where published.	T <sup>2</sup>
	DI	Painless Blood-Glucose Monitoring ; Kumertrix Technology Overview ; <a href="http://www.kumertrix.com/technology.html">http://www.kumertrix.com/technology.html</a> ; 2 pages; November 24, 2000	
	DJ	Technology & Clinical Results-Simple Solutions Through Technology-Progression of Glucose Monitoring Technology ; Amira ; <a href="http://amira.com/tech/tc_tech.htm">http://amira.com/tech/tc_tech.htm</a> ; 2 pages; November 24, 2000	
	DK	Wired for Wellness ; LifeChart.com ; <a href="http://www.lifechart.com">http://www.lifechart.com</a> ; 2 pages ; November 24, 2000	
	DL	About Data Critical Corporation ; Yahoo—Data Critical to Provide Mallincrod with Wireless Connectivity for Ventilators ; <a href="http://biz.yahoo.com/pmews/001012/mo_mallinc.html">http://biz.yahoo.com/pmews/001012/mo_mallinc.html</a> ; 1 page; November 24, 2000	
	DM	Bluetooth wireless technology-bridging the gap between computing and communication; Bluetooth Technology; <a href="http://www.intell.commobile/bluetooth/">http://www.intell.commobile/bluetooth/</a> ; 2 pages; November 28, 2000	
	DN	Bluetooth resource center ; What is Bluetooth ?; palowireless.com; <a href="http://www.palowireless.com/infotooth/walis.asp">http://www.palowireless.com/infotooth/walis.asp</a> ; 3 pages; November 28, 2000	
	DO	Bluetooth Tutorial ; palowireless.com—bluetooth resource center ; <a href="http://www.palowireless.com/infotooth/tutorial.asp">http://www.palowireless.com/infotooth/tutorial.asp</a> ; 4 pages; November 28, 2000	
	DP	Bluetooth Profiles; palowireless.com—bluetooth resource center; <a href="http://www.palowireless.com/infotooth/tutorial/profiles.asp">http://www.palowireless.com/infotooth/tutorial/profiles.asp</a> ; 4 pages; November 28, 2000	
	DQ	Nick Hunt ; Bluetooth Venus 802.11 ; TDK Systems ; <a href="http://www.cellular.com.za/bluetooth_versus_802.htm">http://www.cellular.com.za/bluetooth_versus_802.htm</a> ; 4 pages; November 28, 2000	
	DR	Bluetooth vs. Airport (802.11 Network); palowireless.com—Bluetooth resource center; <a href="http://www.palowireless.com/infotooth/knowledge/othemetworks/15.asp">http://www.palowireless.com/infotooth/knowledge/othemetworks/15.asp</a> ; 3 pages; November 28, 2000	
	DS	Personal Digital Assistants; A2 Anytime/Anywhere—A Weekly on Wireless Infrastructure and Data Services; Thomas Weisel Partners (Merchant Banking); 5 pages; November 29, 2000	
	DT	Ashlee Vance; Ericsson and Intel Make Bluetooth Pact; InfoWorld.com; <a href="http://www.infoworld.com/articles/hn/xml/00/12/04/001204hnericintel.xml?T.../printarticle.htm">http://www.infoworld.com/articles/hn/xml/00/12/04/001204hnericintel.xml?T.../printarticle.htm</a> ; 1 page; December 4, 2000	

Examiner Signature	Date Considered
--------------------	-----------------

<sup>1</sup>AMINER: Initial if reference considered, whether or not citation is in conformance with MPEP 609. Draw line through citation if not in conformance and not considered. Include copy of this form with next communication to applicant.  
<sup>2</sup>Unique citation designation number. <sup>3</sup>Applicant is to place a check mark here if English language Translation is attached.  
 Ten Hour Statement: This form is estimated to take 2.0 hours to complete. Time will vary depending upon the needs of the individual case. Any comments on amount of time you are required to complete this form should be sent to the Chief Information Officer, Patent and Trademark Office, Washington, DC 20231.  
 NOT SEND FEES OR COMPLETED FORMS TO THIS ADDRESS. SEND TO: Assistant Commissioner for Patents, Washington, DC 20231

<b>INFORMATION DISCLOSURE STATEMENT BY APPLICANT</b> ( Not for submission under 37 CFR 1.99)	Application Number	12211033
	Filing Date	2008-09-15
	First Named Inventor	Roger J. Quy
	Art Unit	3769
	Examiner Name	Michael C. Astorino
	Attorney Docket Number	00125/002005

OTHER PRIOR ART--NON-PATENT LITERATURE DOCUMENTS		
Examiner Initials <sup>1</sup>	Cite No. <sup>1</sup>	Include name of the author (In CAPITAL LETTERS), title of the article (when appropriate), title of the item (book, magazine, journal, serial, symposium, catalog, etc.), date, page(s), volume-issue number(s), publisher, city and/or country where published.
	DU	Personal Portable Office; Nokia 9000ii digital; <a href="http://www.nokiausa.com/9000ii">http://www.nokiausa.com/9000ii</a> ; 4 pages; December 7, 2000
	DV	Pui-Wing Tam; Handspring Homes; Article from the Wall Street Journal; Section B; November 2000
	DW	Author unknown; Articles on Phones and New Technologies; Article from the Wall Street Journal; November 2000
	DX	David Pringle; Sagen to Launch Hand-held Computer that Doubles as Top-End Mobile Phone; Article from the Wall Street Journal; November 2000
	DY	Svensson, Peter; "Cisco Launches WiFi Phone" Article from Australian IT; April 29, 2003
	DZ	"Breakthrough Devices Shown At ADA" published in Diabetes News for July 1, 2001 at <a href="http://www.diabetesnet.com/news/news070101.php">http://www.diabetesnet.com/news/news070101.php</a>
	EA	"iMetrikus" published at <a href="http://www.qualcomm.com/qwbs/resource/resource/lib_casestdy.shtml">http://www.qualcomm.com/qwbs/resource/resource/lib_casestdy.shtml</a>
	EB	"Applications of MedStar" published on April 27, 2003 by Cybemet Medical, 16 pages
	EC	"HIPAA & WiFi: Regulatory Tangles for Wireless Health Care Networks Analyzed" published at <a href="http://www.hipaadvisory.com/tech/wireless.htm">http://www.hipaadvisory.com/tech/wireless.htm</a>
	ED	"Medtronic CareLink Network, How it Works" published at <a href="http://www.medtronic.com/carelink/features.html">http://www.medtronic.com/carelink/features.html</a>
	EE	"FDA Approves Medtronic CareLink™ Monitor and Software, Opening a New Chapter in Patient Management Using Internet Technology", Medtronic News Release dated 01/02/02
	EF	"The MedStar System, How the MedStar System Works" brochure published by Cybemet Medical.

Examiner Signature	Date Considered
--------------------	-----------------

<sup>1</sup>AMINER: Initial if reference considered, whether or not citation is in conformance with MPEP 609. Draw line through citation if not in conformance and not considered. Include copy of this form with next communication to applicant.  
<sup>2</sup>Applicant is to place a check mark here if English language Translation is attached.  
 Don Hour Statement: This form is estimated to take 2.0 hours to complete. Time will vary depending upon the needs of the individual case. Any comments on amount of time you are required to complete this form should be sent to the Chief Information Officer, Patent and Trademark Office, Washington, DC 20231

<b>INFORMATION DISCLOSURE STATEMENT BY APPLICANT</b> ( Not for submission under 37 CFR 1.99)	Application Number		12211033
	Filing Date		2008-09-15
	First Named Inventor	Roger J. Quy	
	Art Unit	3769	
	Examiner Name	Michael C. Astorino	
	Attorney Docket Number	00125/002005	

OTHER PRIOR ART—NON-PATENT LITERATURE DOCUMENTS			
Examiner Initials <sup>2</sup>	Cite No. <sup>1</sup>	Include name of the author (In CAPITAL LETTERS), title of the article (when appropriate), title of the item (book, magazine, journal, serial, symposium, catalog, etc.), date, page(s), volume-issue number(s), publisher, city and/or country where published.	T <sup>2</sup>
	EG	"iMetrikus Mobile Solutions" brochure by iMetrikus, Inc.	
	EH	"Instromedix – Products" published at <a href="http://www.instromedix.com/pages/products/products.asp">www.instromedix.com/pages/products/products.asp</a> . 7 Pages	

Examiner Signature		Date Considered	
--------------------	--	-----------------	--

<sup>1</sup>EXAMINER: Initial if reference considered, whether or not citation is in conformance with MPEP 609. Draw line through citation if not in conformance and not considered. Include copy of this form with next communication to applicant.  
<sup>2</sup>Unique citation designation number. <sup>3</sup>Applicant is to place a check mark here if English language Translation is attached.  
 Burden Hour Statement: This form is estimated to take 2.0 hours to complete. Time will vary depending upon the needs of the individual case. Any comments on

<b>INFORMATION DISCLOSURE STATEMENT BY APPLICANT</b> ( Not for submission under 37 CFR 1.99)	Application Number	12211033
	Filing Date	2008-09-15
	First Named Inventor	Roger J. Quy
	Art Unit	3769
	Examiner Name	Michael C. Astorino
	Attorney Docket Number	00125/002005

OTHER PRIOR ART - NON PATENT LITERATURE DOCUMENTS			
Examiner Initials*	Cite No. <sup>1</sup>	Include name of the author (in CAPITAL LETTERS), title of the article (when appropriate), title of the item (book, magazine, journal, serial, symposium, catalog, etc.), date, page(s), volume-issue number(s), publisher, city and/or country where published.	T <sup>2</sup>
	1.	EFI Framework Draft Version 0.8 (03-June-2000); External Functionality Interface Framework; pp, 1-35.	
	2.	Internet Press Release: New York Business Wire (Sept. 25, 2000); MedSearch Technologies, Inc. Develops a Revolutionary Home-Care Wireless Technology Utilizing PSA's-Personal Organizers-as Patient Monitors	

Examiner Signature		Date Considered	
--------------------	--	-----------------	--

EXAMINER: Initial if reference considered, whether or not citation is in conformance with MPEP 609. Draw line through citation, if not in conformance and not considered. Include copy of this form with next communication to applicant.

<sup>1</sup> Unique citation designation number. <sup>2</sup> Enter Office that issued the document, by the two-letter code (WIPO Standard ST.3). <sup>3</sup> For Japanese patent documents, the indication of the year of the reign of the Emperor must precede the serial number of the patent document. <sup>4</sup> Kind of document by the appropriate symbols as indicated on the document under WIPO Standard ST. 16 if possible. <sup>5</sup> Applicant is to place a check mark here if English Language Translation is attached.

<b>INFORMATION DISCLOSURE STATEMENT BY APPLICANT</b> ( Not for submission under 37 CFR 1.99)	Application Number		12211033
	Filing Date		2008-09-15
	First Named Inventor	Roger J. Quy	
	Art Unit	3769	
	Examiner Name	Michael C. Astorino	
	Attorney Docket Number	00125/002005	

If you wish to add additional Foreign Patent Document citation information please click the Add button

**NON-PATENT LITERATURE DOCUMENTS**

Examiner Initials*	Cite No	Include name of the author (in CAPITAL LETTERS), title of the article (when appropriate), title of the item (book, magazine, journal, serial, symposium, catalog, etc), date, pages(s), volume-issue number(s), publisher, city and/or country where published.	T <sup>5</sup>
	1	JOSEPH FINKELSTEIN, et al., "Web-Based Monitoring of Asthma Severity: A New Approach to Ambulatory Management", Proc. 1998 IEEE Int'l Conf. on Info Tech. Applications in Biomedicine, 1998, pp. 139-143.	<input type="checkbox"/>

If you wish to add additional non-patent literature document citation information please click the Add button

**EXAMINER SIGNATURE**

Examiner Signature		Date Considered	
--------------------	--	-----------------	--

\*EXAMINER: Initial if reference considered, whether or not citation is in conformance with MPEP 609. Draw line through a citation if not in conformance and not considered. Include copy of this form with next communication to applicant.

<sup>1</sup> See Kind Codes of USPTO Patent Documents at [www.USPTO.GOV](http://www.USPTO.GOV) or MPEP 901.04. <sup>2</sup> Enter office that issued the document, by the two-letter code (WIPO Standard ST.3). <sup>3</sup> For Japanese patent documents, the indication of the year of the reign of the Emperor must precede the serial number of the patent document. <sup>4</sup> Kind of document by the appropriate symbols as indicated on the document under WIPO Standard ST.16 if possible. <sup>5</sup> Applicant is to place a check mark here if English language translation is attached.

<b>INFORMATION DISCLOSURE STATEMENT BY APPLICANT</b> ( Not for submission under 37 CFR 1.99)	Application Number	12211033
	Filing Date	2008-09-15
	First Named Inventor	Roger J. Quy
	Art Unit	3769
	Examiner Name	Michael C. Astorino
	Attorney Docket Number	00125/002005

	2.	YAN XIAO, PhD. et al., "Design and Evaluation of a Real-Time Mobile Telemedicine System for Ambulance Transport", <i>Proceedings of the 1998 American Medical Informatics Association Annual Fall Symposium</i> , 1998, pp. 1102-1103.	
	3.	YAN XIAO, PhD. et al., "Design and Evaluation of a Real-Time Mobile Telemedicine System for Ambulance Transport", <i>The Journal of High Speed Networks</i> , 2000, vol. 9 (1), pp. 47-56.	

Examiner Signature		Date Considered	
--------------------	--	-----------------	--

\*EXAMINER: Initial if reference considered, whether or not citation is in conformance with MPEP 609. Draw line through citation if not in conformance and not considered. Include copy of this form with next communication to applicant.

<sup>1</sup>Unique citation designation number. <sup>2</sup>Applicant is to place a check mark here if English language translation is attached.  
 Burden Hour Statement: This form is estimated to take 2.0 hours to complete. Time will vary depending upon the needs of the individual case. Any comments on the amount of time you are required to complete this form should be sent to the Chief Information Officer, Patent and trademark Office, Washington, DC 20231. DO NOT SEND FEES OR COMPLETED FORMS TO THIS ADDRESS. SEND TO: Assistant Commissioner for Patents, Washington, DC 20231.

<b>INFORMATION DISCLOSURE STATEMENT BY APPLICANT</b> ( Not for submission under 37 CFR 1.99)	Application Number		12211033
	Filing Date		2008-09-15
	First Named Inventor	Roger J. Quy	
	Art Unit	3769	
	Examiner Name	Michael C. Astorino	
	Attorney Docket Number	00125/002005	

OTHER PRIOR ART - NON PATENT LITERATURE DOCUMENTS			
Examiner Initials <sup>6</sup>	Cite No. <sup>1</sup>	Include name of the author (in CAPITAL LETTERS), title of the article (when appropriate), title of the item (book, magazine, journal, serial, symposium, catalog, etc.), date, page(s), volume-issue number(s), publisher, city and/or country where published.	T <sup>7</sup>
	1.	EFI Framework Draft Version 0.8 (03-June-2000); External Functionality Interface Framework; pp, 1-35.	
	2.	Internet Press Release: New York Business Wire (Sept. 25, 2000); MedSearch Technologies, Inc. Develops a Revolutionary Home-Care Wireless Technology Utilizing PSA's-Personal Organizers-as Patient Monitors	

Examiner Signature		Date Considered	
--------------------	--	-----------------	--

EXAMINER: Initial if reference considered, whether or not citation is in conformance with MPEP 609. Draw line through citation, if not in conformance and not considered. Include copy of this form with next communication to applicant.

<sup>1</sup> Unique citation designation number. <sup>2</sup> Enter Office that issued the document, by the two-letter code (WIPO Standard ST.3). <sup>3</sup> For Japanese patent documents, the indication of the year of the reign of the Emperor must precede the serial number of the patent document. <sup>4</sup> Kind of document by the appropriate symbols as indicated on the document under WIPO Standard ST. 16 if possible. <sup>5</sup> Applicant is to place a check mark here if English Language Translation is attached.

Serial No. 12/211,033

**IN THE UNITED STATES PATENT AND TRADEMARK OFFICE**

Applicant: Roger J. Quy

Application No.: 12/211,033

Filing Date: 09/15/2008

Title: METHOD AND APPARATUS FOR HEALTH AND DISEASE  
MANAGEMENT COMBINING PATIENT DATA MONITORING WITH  
WIRELESS INTERNET CONNECTIVITY

Art Unit: 3769

Examiner: Michael C. Astorino

Conf. No.: 7693

Docket No.: 00125/002005

**VIA EFS WEB**

U.S. Patent and Trademark Office  
Office of Initial Patent Examination  
Filing Receipts Corrections

**LETTER**

Sir:

This is in response to the Filing Receipt dated September 26, 2008.

Applicant's attorney notes that because of an inadvertent error made on the Application Data Sheet filed September 15, 2008, the Domestic Benefit/National Stage Information is incorrect. Please correct the Domestic Benefit/National Stage Information to read:

This application is a CON of 11/649,703 01/03/2007  
**which is a CON of 11/184,274 07/18/2005 PAT 7,156,808**  
which is a CON of 10/418,845 04/18/2003 PAT 6,936,007  
which is a CON of 09/738,270 12/15/2000 PAT 6,602,191  
which claims benefit of 60/172,486 12/17/1999



Serial No. 12/211,033

This correction is indicated on the attached copy of the Filing Receipt. A revised Application Data Sheet with the corrected Domestic Benefit/National Stage Information is attached as well.

It is respectfully requested that a corrected Filing Receipt be promptly issued that properly reflects the correct Domestic Benefit/National Stage Information.

Date: July 1, 2009

Attorney for Applicant  
Mayer & Williams PC  
251 North Avenue West, 2<sup>nd</sup> Floor  
Westfield, NJ 07090  
Tel: (619) 818-4615  
Fax: (908) 518-7795

Respectfully submitted,

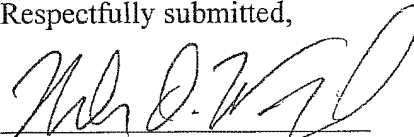
  
Mark D. Wiczorek  
Registration No. 37,966

<p align="center"><b><u>Certificate of Electronic Transmission</u></b> <b><u>Under 37 C.F.R. §1.8</u></b></p> <p>I hereby certify that this correspondence and any document referenced herein are being electronically deposited with the USPTO via EFS-Web on <u>7/31/09</u></p> <p align="center"><u>Hellier Kelly.</u> (Printed Name of Person Sending Correspondence)</p> <p align="center"><u>Hellier Kelly</u> (Signature)</p>
--



UNITED STATES PATENT AND TRADEMARK OFFICE

UNITED STATES DEPARTMENT OF COMMERCE  
 United States Patent and Trademark Office  
 Address: COMMISSIONER FOR PATENTS  
 P.O. Box 1450  
 Alexandria, Virginia 22313-1450  
 www.uspto.gov

APPLICATION NUMBER	FILING or 371(c) DATE	GRP ART UNIT	FIL FEE REC'D	ATTY.DOCKET.NO	TOT CLAIMS	IND CLAIMS
12/211,033	09/15/2008	3736	0.00	00125/002005	12	2

CONFIRMATION NO. 7693

FILING RECEIPT



27774  
 MAYER & WILLIAMS PC  
 251 NORTH AVENUE WEST  
 2ND FLOOR  
 WESTFIELD, NJ 07090

Date Mailed: 09/26/2008

Receipt is acknowledged of this non-provisional patent application. The application will be taken up for examination in due course. Applicant will be notified as to the results of the examination. Any correspondence concerning the application must include the following identification information: the U.S. APPLICATION NUMBER, FILING DATE, NAME OF APPLICANT, and TITLE OF INVENTION. Fees transmitted by check or draft are subject to collection. Please verify the accuracy of the data presented on this receipt. **If an error is noted on this Filing Receipt, please submit a written request for a Filing Receipt Correction. Please provide a copy of this Filing Receipt with the changes noted thereon. If you received a "Notice to File Missing Parts" for this application, please submit any corrections to this Filing Receipt with your reply to the Notice. When the USPTO processes the reply to the Notice, the USPTO will generate another Filing Receipt incorporating the requested corrections**

Applicant(s)

Roger J. Quy, Mill Valley, CA;

Power of Attorney:

Mark Wiczorek--37966

Domestic Priority data as claimed by applicant

This application is a CON of 11/649,703 01/03/2007  
 which is a CON of 10/418,845 04/18/2003 PAT 6,936,007  
 which is a CON of 09/738,270 12/15/2000 PAT 6,602,191  
 which claims benefit of 60/172,486 12/17/1999

*which is a CON of 11/184,274 07/18/2005 PAT 7,156,808*

Foreign Applications

If Required, Foreign Filing License Granted: 09/24/2008

The country code and number of your priority application, to be used for filing abroad under the Paris Convention, is **US 12/211,033**

Projected Publication Date: To Be Determined - pending completion of Missing Parts

Non-Publication Request: No

Early Publication Request: No

**Title**

METHOD AND APPARATUS FOR HEALTH AND DISEASE MANAGEMENT COMBINING PATIENT DATA MONITORING WITH WIRELESS INTERNET CONNECTIVITY

**Preliminary Class**

600

**PROTECTING YOUR INVENTION OUTSIDE THE UNITED STATES**

Since the rights granted by a U.S. patent extend only throughout the territory of the United States and have no effect in a foreign country, an inventor who wishes patent protection in another country must apply for a patent in a specific country or in regional patent offices. Applicants may wish to consider the filing of an international application under the Patent Cooperation Treaty (PCT). An international (PCT) application generally has the same effect as a regular national patent application in each PCT-member country. The PCT process **simplifies** the filing of patent applications on the same invention in member countries, but **does not result** in a grant of "an international patent" and does not eliminate the need of applicants to file additional documents and fees in countries where patent protection is desired.

Almost every country has its own patent law, and a person desiring a patent in a particular country must make an application for patent in that country in accordance with its particular laws. Since the laws of many countries differ in various respects from the patent law of the United States, applicants are advised to seek guidance from specific foreign countries to ensure that patent rights are not lost prematurely.

Applicants also are advised that in the case of inventions made in the United States, the Director of the USPTO must issue a license before applicants can apply for a patent in a foreign country. The filing of a U.S. patent application serves as a request for a foreign filing license. The application's filing receipt contains further information and guidance as to the status of applicant's license for foreign filing.

Applicants may wish to consult the USPTO booklet, "General Information Concerning Patents" (specifically, the section entitled "Treaties and Foreign Patents") for more information on timeframes and deadlines for filing foreign patent applications. The guide is available either by contacting the USPTO Contact Center at 800-786-9199, or it can be viewed on the USPTO website at <http://www.uspto.gov/web/offices/pac/doc/general/index.html>.

For information on preventing theft of your intellectual property (patents, trademarks and copyrights), you may wish to consult the U.S. Government website, <http://www.stopfakes.gov>. Part of a Department of Commerce initiative, this website includes self-help "toolkits" giving innovators guidance on how to protect intellectual property in specific countries such as China, Korea and Mexico. For questions regarding patent enforcement issues, applicants may call the U.S. Government hotline at 1-866-999-HALT (1-866-999-4158).

**LICENSE FOR FOREIGN FILING UNDER**

**Title 35, United States Code, Section 184**

**Title 37, Code of Federal Regulations, 5.11 & 5.15**

**GRANTED**

The applicant has been granted a license under 35 U.S.C. 184, if the phrase "IF REQUIRED, FOREIGN FILING LICENSE GRANTED" followed by a date appears on this form. Such licenses are issued in all applications where

the conditions for issuance of a license have been met, regardless of whether or not a license may be required as set forth in 37 CFR 5.15. The scope and limitations of this license are set forth in 37 CFR 5.15(a) unless an earlier license has been issued under 37 CFR 5.15(b). The license is subject to revocation upon written notification. The date indicated is the effective date of the license, unless an earlier license of similar scope has been granted under 37 CFR 5.13 or 5.14.

This license is to be retained by the licensee and may be used at any time on or after the effective date thereof unless it is revoked. This license is automatically transferred to any related applications(s) filed under 37 CFR 1.53(d). This license is not retroactive.

The grant of a license does not in any way lessen the responsibility of a licensee for the security of the subject matter as imposed by any Government contract or the provisions of existing laws relating to espionage and the national security or the export of technical data. Licensees should apprise themselves of current regulations especially with respect to certain countries, of other agencies, particularly the Office of Defense Trade Controls, Department of State (with respect to Arms, Munitions and Implements of War (22 CFR 121-128)); the Bureau of Industry and Security, Department of Commerce (15 CFR parts 730-774); the Office of Foreign Assets Control, Department of Treasury (31 CFR Parts 500+) and the Department of Energy.

**NOT GRANTED**

No license under 35 U.S.C. 184 has been granted at this time, if the phrase "IF REQUIRED, FOREIGN FILING LICENSE GRANTED" DOES NOT appear on this form. Applicant may still petition for a license under 37 CFR 5.12, if a license is desired before the expiration of 6 months from the filing date of the application. If 6 months has lapsed from the filing date of this application and the licensee has not received any indication of a secrecy order under 35 U.S.C. 181, the licensee may foreign file the application pursuant to 37 CFR 5.15(b).

Under the Paperwork Reduction Act of 1995, no persons are required to respond to a collection of information unless it contains a valid OMB control number.

<b>Application Data Sheet 37 CFR 1.76</b>		Attorney Docket Number	00125/002005
		Application Number	
Title of Invention	METHOD AND APPARATUS FOR HEALTH AND DISEASE MANAGEMENT COMBINING PATIENT DATA MONITORING WITH WIRELESS INTERNET CONNECTIVITY		
The application data sheet is part of the provisional or nonprovisional application for which it is being submitted. The following form contains the bibliographic data arranged in a format specified by the United States Patent and Trademark Office as outlined in 37 CFR 1.76. This document may be completed electronically and submitted to the Office in electronic format using the Electronic Filing System (EFS) or the document may be printed and included in a paper filed application.			

**Secrecy Order 37 CFR 5.2**

<input type="checkbox"/>	Portions or all of the application associated with this Application Data Sheet may fall under a Secrecy Order pursuant to 37 CFR 5.2 (Paper filers only. Applications that fall under Secrecy Order may not be filed electronically.)
--------------------------	---

**Applicant Information:**

<b>Applicant 1</b>				
<b>Applicant Authority</b> <input checked="" type="radio"/> Inventor		<input type="radio"/> Legal Representative under 35 U.S.C. 117		<input type="radio"/> Party of Interest under 35 U.S.C. 118
<b>Prefix</b>	<b>Given Name</b>	<b>Middle Name</b>	<b>Family Name</b>	<b>Suffix</b>
	Roger	J.	Quy	
<b>Residence Information (Select One)</b> <input checked="" type="radio"/> US Residency <input type="radio"/> Non US Residency <input type="radio"/> Active US Military Service				
<b>City</b>	Mill Valley	<b>State/Province</b>	CA	<b>Country of Residence</b> US
<b>Citizenship under 37 CFR 1.41(b)</b>		GB		
<b>Mailing Address of Applicant:</b>				
<b>Address 1</b>		14 Topside Way		
<b>Address 2</b>				
<b>City</b>	Mill Valley	<b>State/Province</b>	CA	
<b>Postal Code</b>	94941	<b>Country</b>	US	
All Inventors Must Be Listed - Additional Inventor Information blocks may be generated within this form by selecting the <b>Add</b> button. <span style="float: right;"><input type="button" value="Add"/></span>				

**Correspondence Information:**

Enter either Customer Number or complete the Correspondence Information section below. For further information see 37 CFR 1.33(a).	
<input type="checkbox"/> An Address is being provided for the correspondence information of this application.	
<b>Customer Number</b>	27774
<b>Email Address</b>	<input type="button" value="Add Email"/> <input type="button" value="Remove Email"/>

**Application Information:**

<b>Title of the Invention</b>	METHOD AND APPARATUS FOR HEALTH AND DISEASE MANAGEMENT COMBINING PATIENT DATA MONITORING WITH WIRELESS INTERNET CONNECTIVITY		
<b>Attorney Docket Number</b>	00125/002005	<b>Small Entity Status Claimed</b> <input checked="" type="checkbox"/>	
<b>Application Type</b>	Nonprovisional		
<b>Subject Matter</b>	Utility		
<b>Suggested Class (if any)</b>		<b>Sub Class (if any)</b>	
<b>Suggested Technology Center (if any)</b>	3736		
<b>Total Number of Drawing Sheets (if any)</b>	8	<b>Suggested Figure for Publication (if any)</b>	1

Under the Paperwork Reduction Act of 1995, no persons are required to respond to a collection of information unless it contains a valid OMB control number.

<b>Application Data Sheet 37 CFR 1.76</b>		Attorney Docket Number	00125/002005
		Application Number	
Title of Invention	METHOD AND APPARATUS FOR HEALTH AND DISEASE MANAGEMENT COMBINING PATIENT DATA MONITORING WITH WIRELESS INTERNET CONNECTIVITY		

**Publication Information:**

Request Early Publication (Fee required at time of Request 37 CFR 1.219)

**Request Not to Publish.** I hereby request that the attached application not be published under 35 U.S.C. 122(b) and certify that the invention disclosed in the attached application **has not and will not** be the subject of an application filed in another country, or under a multilateral international agreement, that requires publication at eighteen months after filing.

**Representative Information:**

Representative information should be provided for all practitioners having a power of attorney in the application. Providing this information in the Application Data Sheet does not constitute a power of attorney in the application (see 37 CFR 1.32). Enter either Customer Number or complete the Representative Name section below. If both sections are completed the Customer Number will be used for the Representative Information during processing.

Please Select One:  Customer Number  US Patent Practitioner  Limited Recognition (37 CFR 11.9)

Customer Number: 27774

**Domestic Benefit/National Stage Information:**

This section allows for the applicant to either claim benefit under 35 U.S.C. 119(e), 120, 121, or 365(c) or indicate National Stage entry from a PCT application. Providing this information in the application data sheet constitutes the specific reference required by 35 U.S.C. 119(e) or 120, and 37 CFR 1.78(a)(2) or CFR 1.78(a)(4), and need not otherwise be made part of the specification.

Prior Application Status	Abandoned	<a href="#">Remove</a>			
Application Number	Continuity Type	Prior Application Number	Filing Date (YYYY-MM-DD)		
	Continuation of	11649703	2007-01-03		
Prior Application Status	Patented	<a href="#">Remove</a>			
Application Number	Continuity Type	Prior Application Number	Filing Date (YYYY-MM-DD)	Patent Number	Issue Date (YYYY-MM-DD)
11649703	Continuation of	11184274	2005-07-18	7156808	2007-01-02
Prior Application Status	Patented	<a href="#">Remove</a>			
Application Number	Continuity Type	Prior Application Number	Filing Date (YYYY-MM-DD)	Patent Number	Issue Date (YYYY-MM-DD)
11184274	Continuation of	10418845	2003-04-18	6936007	2005-08-30
Prior Application Status	Patented	<a href="#">Remove</a>			
Application Number	Continuity Type	Prior Application Number	Filing Date (YYYY-MM-DD)	Patent Number	Issue Date (YYYY-MM-DD)
10418845	Continuation of	09738270	2000-12-15	6602191	2003-08-05
Prior Application Status	Expired	<a href="#">Remove</a>			
Application Number	Continuity Type	Prior Application Number	Filing Date (YYYY-MM-DD)		
09738270	non provisional of	60172486	1999-12-17		

PTO/SB/14 (07-07)  
 Approved for use through 06/30/2010. OMB 0651-0032  
 U.S. Patent and Trademark Office; U.S. DEPARTMENT OF COMMERCE

Under the Paperwork Reduction Act of 1995, no persons are required to respond to a collection of information unless it contains a valid OMB control number.

<b>Application Data Sheet 37 CFR 1.76</b>		Attorney Docket Number	00125/002005
		Application Number	
Title of Invention	METHOD AND APPARATUS FOR HEALTH AND DISEASE MANAGEMENT COMBINING PATIENT DATA MONITORING WITH WIRELESS INTERNET CONNECTIVITY		

Additional Domestic Benefit/National Stage Data may be generated within this form by selecting the **Add** button.

**Foreign Priority Information:**

This section allows for the applicant to claim benefit of foreign priority and to identify any prior foreign application for which priority is not claimed. Providing this information in the application data sheet constitutes the claim for priority as required by 35 U.S.C. 119(b) and 37 CFR 1.55(a).

Application Number	Country <sup>1</sup>	Parent Filing Date (YYYY-MM-DD)	Priority Claimed
			<input type="radio"/> Yes <input checked="" type="radio"/> No

Additional Foreign Priority Data may be generated within this form by selecting the **Add** button.

**Assignee Information:**

Providing this information in the application data sheet does not substitute for compliance with any requirement of part 3 of Title 37 of the CFR to have an assignment recorded in the Office.

**Assignee 1**

If the Assignee is an Organization check here.

Organization Name: Q-Tec Systems LLC

**Mailing Address Information:**

Address 1: 1220 N. Market Street, Suite 606

Address 2:

City: Wilmington State/Province: DE

Country: US Postal Code: 19801

Phone Number: Fax Number:

Email Address:

Additional Assignee Data may be generated within this form by selecting the **Add** button.

**Signature:**

A signature of the applicant or representative is required in accordance with 37 CFR 1.33 and 10.18. Please see 37 CFR 1.4(d) for the form of the signature.

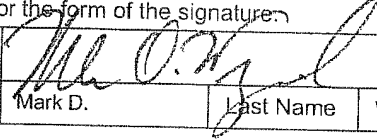
Signature			Date (YYYY-MM-DD)	2009-07-01	
First Name	Mark D.	Last Name	Wieczorek	Registration Number	37966

Under the Paperwork Reduction Act of 1995, no persons are required to respond to a collection of information unless it contains a valid OMB control number.

<b>Application Data Sheet 37 CFR 1.76</b>		Attorney Docket Number	00125/002005
		Application Number	
Title of Invention	METHOD AND APPARATUS FOR HEALTH AND DISEASE MANAGEMENT COMBINING PATIENT DATA MONITORING WITH WIRELESS INTERNET CONNECTIVITY		

This collection of information is required by 37 CFR 1.76. The information is required to obtain or retain a benefit by the public which is to file (and by the USPTO to process) an application. Confidentiality is governed by 35 U.S.C. 122 and 37 CFR 1.14. This collection is estimated to take 23 minutes to complete, including gathering, preparing, and submitting the completed application data sheet form to the USPTO. Time will vary depending upon the individual case. Any comments on the amount of time you require to complete this form and/or suggestions for reducing this burden, should be sent to the Chief Information Officer, U.S. Patent and Trademark Office, U.S. Department of Commerce, P.O. Box 1450, Alexandria, VA 22313-1450. **DO NOT SEND FEES OR COMPLETED FORMS TO THIS ADDRESS. SEND TO: Commissioner for Patents, P.O. Box 1450, Alexandria, VA 22313-1450.**



**Electronic Acknowledgement Receipt**

<b>EFS ID:</b>	5806016
<b>Application Number:</b>	12211033
<b>International Application Number:</b>	
<b>Confirmation Number:</b>	7693
<b>Title of Invention:</b>	METHOD AND APPARATUS FOR HEALTH AND DISEASE MANAGEMENT COMBINING PATIENT DATA MONITORING WITH WIRELESS INTERNET CONNECTIVITY
<b>First Named Inventor/Applicant Name:</b>	Roger J. Quy
<b>Customer Number:</b>	27774
<b>Filer:</b>	Karin L. Williams/Hellier Kelly
<b>Filer Authorized By:</b>	Karin L. Williams
<b>Attorney Docket Number:</b>	00125/002005
<b>Receipt Date:</b>	31-JUL-2009
<b>Filing Date:</b>	15-SEP-2008
<b>Time Stamp:</b>	11:10:13
<b>Application Type:</b>	Utility under 35 USC 111(a)

**Payment information:**

Submitted with Payment	no
------------------------	----

**File Listing:**

Document Number	Document Description	File Name	File Size(Bytes)/ Message Digest	Multi Part /.zip	Pages (if appl.)
1	Request for Corrected Filing Receipt	00125_002005_Request_to_Correct_Filing_Receipt.pdf	284245 4e79bfff62d65c2e35dcab62c26eb943118e59d7	no	5

**Warnings:**

The page size in the PDF is too large. The pages should be 8.5 x 11 or A4. If this PDF is submitted, the pages will be resized upon entry into the Image File Wrapper and may affect subsequent processing

**Information:**

2	Application Data Sheet	00125_002005_ADS.pdf	293854	no	4
			3af15efa540adbdec1f8b0734b760f47a6b883c8		

**Warnings:**

**Information:**

This is not an USPTO supplied ADS fillable form

The page size in the PDF is too large. The pages should be 8.5 x 11 or A4. If this PDF is submitted, the pages will be resized upon entry into the Image File Wrapper and may affect subsequent processing

<b>Total Files Size (in bytes):</b>	578099
-------------------------------------	--------

**This Acknowledgement Receipt evidences receipt on the noted date by the USPTO of the indicated documents, characterized by the applicant, and including page counts, where applicable. It serves as evidence of receipt similar to a Post Card, as described in MPEP 503.**

**New Applications Under 35 U.S.C. 111**

**If a new application is being filed and the application includes the necessary components for a filing date (see 37 CFR 1.53(b)-(d) and MPEP 506), a Filing Receipt (37 CFR 1.54) will be issued in due course and the date shown on this Acknowledgement Receipt will establish the filing date of the application.**

**National Stage of an International Application under 35 U.S.C. 371**

**If a timely submission to enter the national stage of an international application is compliant with the conditions of 35 U.S.C. 371 and other applicable requirements a Form PCT/DO/EO/903 indicating acceptance of the application as a national stage submission under 35 U.S.C. 371 will be issued in addition to the Filing Receipt, in due course.**

**New International Application Filed with the USPTO as a Receiving Office**

**If a new international application is being filed and the international application includes the necessary components for an international filing date (see PCT Article 11 and MPEP 1810), a Notification of the International Application Number and of the International Filing Date (Form PCT/RO/105) will be issued in due course, subject to prescriptions concerning national security, and the date shown on this Acknowledgement Receipt will establish the international filing date of the application.**



## UNITED STATES PATENT AND TRADEMARK OFFICE

UNITED STATES DEPARTMENT OF COMMERCE  
**United States Patent and Trademark Office**  
 Address: COMMISSIONER FOR PATENTS  
 P.O. Box 1450  
 Alexandria, Virginia 22313-1450  
 www.uspto.gov

APPLICATION NUMBER	FILING or 371(c) DATE	GRP ART UNIT	FIL FEE REC'D	ATTY. DOCKET NO	TOT CLAIMS	IND CLAIMS
12/211,033	09/15/2008	3769	527	00125/002005	12	2

CONFIRMATION NO. 7693

CORRECTED FILING RECEIPT



27774  
 MAYER & WILLIAMS PC  
 251 NORTH AVENUE WEST  
 2ND FLOOR  
 WESTFIELD, NJ 07090

Date Mailed: 08/04/2009

Receipt is acknowledged of this non-provisional patent application. The application will be taken up for examination in due course. Applicant will be notified as to the results of the examination. Any correspondence concerning the application must include the following identification information: the U.S. APPLICATION NUMBER, FILING DATE, NAME OF APPLICANT, and TITLE OF INVENTION. Fees transmitted by check or draft are subject to collection. Please verify the accuracy of the data presented on this receipt. **If an error is noted on this Filing Receipt, please submit a written request for a Filing Receipt Correction. Please provide a copy of this Filing Receipt with the changes noted thereon. If you received a "Notice to File Missing Parts" for this application, please submit any corrections to this Filing Receipt with your reply to the Notice. When the USPTO processes the reply to the Notice, the USPTO will generate another Filing Receipt incorporating the requested corrections**

**Applicant(s)**

Roger J. Quy, Mill Valley, CA;

**Assignment For Published Patent Application**

Q-Tec Systems LLC, Wilmington, DE

**Power of Attorney:**

Mark Wiczorek--37966

**Domestic Priority data as claimed by applicant**

This application is a CON of 11/649,703 01/03/2007 ABN  
 which is a CON of 11/184,274 07/18/2005 PAT 7,156,808  
 which is a CON of 10/418,845 04/18/2003 PAT 6,936,007  
 which is a CON of 09/738,270 12/15/2000 PAT 6,602,191  
 which claims benefit of 60/172,486 12/17/1999

**Foreign Applications****If Required, Foreign Filing License Granted:** 09/24/2008

The country code and number of your priority application, to be used for filing abroad under the Paris Convention, is **US 12/211,033**

**Projected Publication Date:** Not Applicable**Non-Publication Request:** No**Early Publication Request:** No**\*\* SMALL ENTITY \*\***

**Title**

METHOD AND APPARATUS FOR HEALTH AND DISEASE MANAGEMENT COMBINING PATIENT DATA MONITORING WITH WIRELESS INTERNET CONNECTIVITY

**Preliminary Class**

600

**PROTECTING YOUR INVENTION OUTSIDE THE UNITED STATES**

Since the rights granted by a U.S. patent extend only throughout the territory of the United States and have no effect in a foreign country, an inventor who wishes patent protection in another country must apply for a patent in a specific country or in regional patent offices. Applicants may wish to consider the filing of an international application under the Patent Cooperation Treaty (PCT). An international (PCT) application generally has the same effect as a regular national patent application in each PCT-member country. The PCT process **simplifies** the filing of patent applications on the same invention in member countries, but **does not result** in a grant of "an international patent" and does not eliminate the need of applicants to file additional documents and fees in countries where patent protection is desired.

Almost every country has its own patent law, and a person desiring a patent in a particular country must make an application for patent in that country in accordance with its particular laws. Since the laws of many countries differ in various respects from the patent law of the United States, applicants are advised to seek guidance from specific foreign countries to ensure that patent rights are not lost prematurely.

Applicants also are advised that in the case of inventions made in the United States, the Director of the USPTO must issue a license before applicants can apply for a patent in a foreign country. The filing of a U.S. patent application serves as a request for a foreign filing license. The application's filing receipt contains further information and guidance as to the status of applicant's license for foreign filing.

Applicants may wish to consult the USPTO booklet, "General Information Concerning Patents" (specifically, the section entitled "Treaties and Foreign Patents") for more information on timeframes and deadlines for filing foreign patent applications. The guide is available either by contacting the USPTO Contact Center at 800-786-9199, or it can be viewed on the USPTO website at <http://www.uspto.gov/web/offices/pac/doc/general/index.html>.

For information on preventing theft of your intellectual property (patents, trademarks and copyrights), you may wish to consult the U.S. Government website, <http://www.stopfakes.gov>. Part of a Department of Commerce initiative, this website includes self-help "toolkits" giving innovators guidance on how to protect intellectual property in specific countries such as China, Korea and Mexico. For questions regarding patent enforcement issues, applicants may call the U.S. Government hotline at 1-866-999-HALT (1-866-999-4158).

**LICENSE FOR FOREIGN FILING UNDER**

**Title 35, United States Code, Section 184**

**Title 37, Code of Federal Regulations, 5.11 & 5.15**

**GRANTED**

The applicant has been granted a license under 35 U.S.C. 184, if the phrase "IF REQUIRED, FOREIGN FILING LICENSE GRANTED" followed by a date appears on this form. Such licenses are issued in all applications where

the conditions for issuance of a license have been met, regardless of whether or not a license may be required as set forth in 37 CFR 5.15. The scope and limitations of this license are set forth in 37 CFR 5.15(a) unless an earlier license has been issued under 37 CFR 5.15(b). The license is subject to revocation upon written notification. The date indicated is the effective date of the license, unless an earlier license of similar scope has been granted under 37 CFR 5.13 or 5.14.

This license is to be retained by the licensee and may be used at any time on or after the effective date thereof unless it is revoked. This license is automatically transferred to any related applications(s) filed under 37 CFR 1.53(d). This license is not retroactive.

The grant of a license does not in any way lessen the responsibility of a licensee for the security of the subject matter as imposed by any Government contract or the provisions of existing laws relating to espionage and the national security or the export of technical data. Licensees should apprise themselves of current regulations especially with respect to certain countries, of other agencies, particularly the Office of Defense Trade Controls, Department of State (with respect to Arms, Munitions and Implements of War (22 CFR 121-128)); the Bureau of Industry and Security, Department of Commerce (15 CFR parts 730-774); the Office of Foreign Assets Control, Department of Treasury (31 CFR Parts 500+) and the Department of Energy.

**NOT GRANTED**

No license under 35 U.S.C. 184 has been granted at this time, if the phrase "IF REQUIRED, FOREIGN FILING LICENSE GRANTED" DOES NOT appear on this form. Applicant may still petition for a license under 37 CFR 5.12, if a license is desired before the expiration of 6 months from the filing date of the application. If 6 months has lapsed from the filing date of this application and the licensee has not received any indication of a secrecy order under 35 U.S.C. 181, the licensee may foreign file the application pursuant to 37 CFR 5.15(b).

Serial No.: 12/211,033

**IN THE UNITED STATES PATENT AND TRADEMARK OFFICE**

Applicant: Roger J. Quy

Serial No.: 12/211,033

Filed: 09/15/2008

Title: METHOD AND APPARATUS FOR HEALTH AND DISEASE  
MANAGEMENT COMBINING PATIENT DATA MONITORING WITH  
WIRELESS INTERNET CONNECTIVITY

Art Unit: 3769

Examiner: Michael C. Astorino

Confirmation No.: 7693

Docket No.: 00125/002005

**Via EFS Web**

Mail Stop Amendment  
Commissioner for Patents  
P.O. Box 1450  
Alexandria, VA 22313-1450

**AMENDMENT AND RESPONSE TO OFFICE ACTION**

Sir:

In response to the Office Action mailed May 4, 2009, kindly amend the above-identified application as follows:

**Certificate of Electronic Filing Under**  
**37 C.F.R. §1.8**  
I certify that this correspondence and any document reference  
herein is being electronically deposited with the USPTO via EFS-  
Web on 08/04/2009.

Nancy Joyce simmons  
(Printed Name of Person Mailing Correspondence)  
/nancy joyce simmons/  
(Signature)

Serial No.: 12/211,033

**Amendments to the Claims:**

1. (Currently Amended) A method for interactive exercise monitoring, the method comprising the steps of:
  - a. coupling a web-enabled wireless phone to a device which provides ~~health~~exercise-related information;
  - b. rendering a user interface on the web-enabled wireless phone;
  - c. receiving ~~health~~exercise-related information in the web-enabled wireless phone, wherein the ~~health~~exercise-related information includes physiological data and data indicating an amount of exercise performed data, and wherein at least one of the physiological data and the data indicating an amount of exercise performed data is received from the device which provides ~~health~~exercise-related information;
  - d. sending the ~~health~~exercise-related information to an internet server via a wireless network;
  - e. receiving a calculated response from a the server, the response associated with a calculation performed by the server based on the ~~health~~exercise-related information; and
  - f. running an application in the web-enabled wireless phone for receiving the exercise-related information and displaying the response.
  
2. (Currently Amended) The method of claim 1, where the receiving exercise-related information including physiological data ~~is~~ includes receiving data received from a physiological monitoring device or from an exercise machine.
  
3. (Currently Amended) The method of claim 1, where the receiving exercise-related information including data indicating an amount of exercise performed data is received includes receiving data from an exercise machine or from a physiological monitoring device.
  
4. (Currently Amended) The method of claim 1, wherein the web-enabled wireless phone receives ~~health~~exercise-related information over a transmission medium, the transmission medium including: a wired connection, ~~an RS-232 connection, an infrared connection,~~ or a radio frequency wireless connection.

Serial No.: 12/211,033

5. (Currently Amended) The method of claim 1, wherein the receiving ~~health~~exercise-related information includes receiving data input by a patient.

6. (Original) The method of claim 1, wherein the web-enabled wireless phone receives data via an adapter to convert a signal from the device to a suitable input for the wireless phone.

7. (Currently Amended) The method of claim 1, where the device which provides ~~health~~exercise-related information is selected from the group consisting of: an electronic body weight scale, a body fat gauge, a pedometer, a biofeedback device, a treadmill, a stepper, an exercise cycle, an accelerometer, a rowing machine, physiotherapy equipment, an aerobic or anaerobic exercise device, a temperature monitor, a heart rate monitor, a blood pressure monitor, a respiratory monitor, and a device that monitors an amount of work or rate of work performed ~~any type of physiological monitoring device, and any type of exercise machine.~~

8. (Currently Amended) A computer-readable medium, containing instructions for performing an interactive method of exercise monitoring, the method comprising the steps of:

- a. ~~displaying a user interface;~~
- b. receiving ~~health~~exercise-related information from a web-enabled wireless phone, wherein the ~~health~~exercise-related information includes physiological data and data indicating an amount of exercise performed data;
- c. sending calculating a response based on the ~~health~~exercise-related information to an internet server;
- d. ~~receiving a~~ transmitting the ~~calculated response to the web-enabled wireless phone from a server, the response associated with a calculation performed by the server based on the health-related information; and~~
- e. ~~displaying an indication of the response .~~

9. (Currently Amended) The medium of claim 8, wherein the method further comprises:

- a. enabling the web-enabled wireless phone to receive exercise-related information from a device; and



Serial No.: 12/211,033

b. transmitting to the web-enabled wireless phone an application including a user interface on which the calculated response may be rendered

~~instructions further cause the web-enabled wireless phone to receive data over a transmission medium, the transmission medium including: a wired connection, an RS-232 connection, an infrared connection, or a radio frequency connection.~~

10. (Currently Amended) The medium of claim 8, wherein the calculating a response includes calculating a response to assist a person in monitoring calorie expenditure, losing weight, or maintaining a healthy lifestyle ~~instructions further cause the web-enabled wireless phone to receive data from a keyboard.~~

11. (Currently Amended) The medium of claim 8, wherein the instructions further cause the web-enabled wireless phone to receive the ~~health~~exercise-related information via an adapter, the adapter to convert a received data signal to a suitable input for the web-enabled wireless phone.

12. (Currently Amended) The medium of claim 8, wherein the ~~health~~exercise-related information is received from a physiological monitoring device which is selected from the group consisting of: an electronic body weight scale, a body fat gauge, a pedometer, a biofeedback device, a treadmill, a stepper, an exercise cycle, an accelerometer, a rowing machine, physiotherapy equipment, an aerobic or anaerobic exercise device, a temperature monitor, a heart rate monitor, a blood pressure monitor, a respiratory monitor, and a device that monitors an amount of work or rate of work performed ~~any physiological monitoring device, and any exercise machine.~~

13. (New) The medium of claim 8, wherein the receiving exercise-related information includes receiving exercise-related information over a wireless or a wired connection.

14. (New) A web-enabled wireless phone, containing a computer-readable medium, the computer-readable medium comprising instructions for causing a processor in the web-enabled wireless phone to perform the method of claim 1.

Serial No.: 12/211,033

15. (New) A computer-readable medium , containing instructions for causing a processor in a web-enabled wireless phone to perform the method of claim 1.

16. (New) The method of claim 1, further comprising downloading the application to the web-enabled wireless phone from a server.

17. (New) The method of claim 4, wherein the wireless connection includes an infrared connection or a radio frequency communication protocol including Bluetooth® or 802.11.

18. (New) The method of claim 4, wherein the wired connection includes a USB connection, a cable, or a docking station.

Serial No.: 12/211,033

**Amendments to the Abstract:**

Please amend the abstract as follows:

~~Embodiments of the invention provide a~~ A method and apparatus are provided for a wireless health monitoring of exercise, fitness, or nutrition, system for interactively monitoring a disease or health condition of a patient by connecting an ~~internet~~web-enabled wireless ~~web~~ device (“WWD”) to a health monitoring device which may be a medical device or other health related device such as an ~~health monitoring device which may be a medical device or other health related device such as an~~ provides exercise-related information, including physiological data and data indicating an amount of exercise performed machine. The WWD may be connected to the health monitoring device directly by a wired connection to a generic input/output port of the WWD using an optional adaptor if necessary. Alternatively, the ~~connection~~ WWD may be by way of a wirelessly connected to the health monitoring device, such as via an infrared or radio frequency connection, including ~~connection~~ using protocols such as Bluetooth® or 802.11, or by way of a wired connection. ~~The wireless connection may also employ an~~ An optional adaptor may be included if necessary. An application for receiving the exercise-related information and providing a user interface may be downloaded to the web-enabled wireless phone from an internet server. The user may also input data to the WWD manually, such as by a keypad, keyboard, stylus, or optionally by voice command.

~~The health~~ exercise-related data information may be ~~is~~ transmitted from the WWD to an ~~internet~~ server using standard internet protocols. ~~The , and the server may calculates and return a~~ response using a software program which may include an algorithm or artificial intelligence system, and may further provide for review by a physician or health specialist. The user may interact with the server. For example, the server transmits a response to the WWD, and the user may answer the response or provide other information.

Attached to this Amendment is a replacement Abstract sheet.

Serial No.: 12/211,033

**Replacement Abstract:**

A method and apparatus are provided for wireless monitoring of exercise, fitness, or nutrition by connecting a web-enabled wireless phone to a device which provides exercise-related information, including physiological data and data indicating an amount of exercise performed. The connection may be by way of a wireless connection using protocols such as Bluetooth® or 802.11, or by way of a wired connection. An optional adaptor may be included if necessary. An application for receiving the exercise-related information and providing a user interface may be downloaded to the web-enabled wireless phone from an internet server. The exercise-related information may be transmitted to an internet server, and the server may calculate and return a response.

Serial No.: 12/211,033

In the Title:

Please amend the title as follows:

METHOD AND APPARATUS FOR ~~HEALTH AND DISEASE MANAGEMENT~~  
~~COMBINING PATIENT DATA MONITORING~~ EXERCISE WITH WIRELESS INTERNET  
CONNECTIVITY

Replacement Title:

METHOD AND APPARATUS FOR MONITORING EXERCISE WITH WIRELESS  
INTERNET CONNECTIVITY

Serial No.: 12/211,033

**REMARKS**

Claims 1-12 were pending in this application. Claims 13-18 have been added and claims 1-5 and 7-12 have been amended. Claims 1-18 are pending. Reconsideration and allowance of all pending claims are respectfully requested.

Applicant has modified the Abstract and Title to more succinctly describe the subject matter of the invention.

**Rejections Under 35 U.S.C. §112**

The Examiner has rejected claims 1-12 under 35 U.S.C. 112, second paragraph, as being indefinite for failing to particularly point out and distinctly claim the subject matter which Applicant regards as the invention. Specifically, the Examiner has indicated that one cannot discern based on the specification the distinction between “physiological data” and “exercise data” and as such the term is indefinite. Applicant has obviated the rejection by way of amendment. In particular, the claims now recite receiving exercise-related information including physiological data and data indicating an amount of exercise performed. Physiological information is clear from the specification at, e.g., paragraph [0018] as describing devices that “monitor the physiologic status of a healthy subject” and data indicating an amount of exercise performed is described in the specification at, e.g., paragraph [0044]. It is respectfully submitted that the rejections have been obviated and should be withdrawn.

**Rejections Under 35 U.S.C. §102**

Claims 1-12 stand rejected under 35 U.S.C. 102(e) as being allegedly anticipated by Brown (US Patent 5,997,476). These rejections are traversed with respect to the amended independent claims 1 and 8 (and corresponding CRM claims 14 and 15) as follows.

Brown discloses a networked system for communication of information to an individual and for remotely monitoring the individual, including a server and a workstation connected to the server through a communication system, where the workstation functions as a remote interface for entering server messages and queries to be communicated to the patients, or script information (column 4, lines 46-48), as well as displaying patient reports generated by the server (column 8, lines 46-51). The server includes a script generator designed to generate script programs from the script information entered through the workstation (column 6, lines 56-58)

Serial No.: 12/211,033

and a database for storing the script programs (column 5, lines 15-16). The system also includes a programmable apparatus (corresponding to elements 26 or 32) which executes the script program to communicate queries and messages to a patient, receive responses to the queries, collect monitoring device measurements, and transmit responses and measurements to the server (column 5, lines 16-20). In some embodiments, the system of Brown also includes a monitoring device for measuring and recording a physiological condition of the patient, and transmitting the measurements to the patient's remotely programmable apparatus (column 4, line 64 to column 5, line 3). Brown notably fails to disclose any substantial teaching of how to take patient monitoring "into the field", i.e. to make it work wherever the patient is as long as there is a standard wireless connection.

Applicant submits that Brown does not disclose each and every element of the presently claimed invention, and thus is deficient as an anticipatory reference.

First, the present invention and current claims require a web-enabled wireless phone. Brown does not disclose this. Reviewing the devices Brown does disclose, one can see a remotely programmable apparatus and a workstation. The remotely programmable apparatus is a proprietary piece of hardware as described in Figs. 3 and 4. Nowhere does Brown teach that its functionality could be implemented on a web-enabled wireless phone. For example, the Brown apparatus does not run a typical web browser or mobile phone application; rather the displays and input buttons operate according to a simple scripting language that provides a set of commands assigned to each patient. If the workstation is submitted to meet the limitation of a web-enabled wireless phone, yet another element of claim 1 is lacking, since the workstation of Brown is not disclosed to have a wireless connection.

Moreover, although Brown mentions that the apparatus may be placed in communication with the server via wireless or cellular networks, this is done with a modem (86/66) and telephone jack (22) for the means of transmission. The apparatus is clearly not a web-enabled wireless phone. This aspect is made even more clear in Brown by the embodiment for communicating script commands audibly to the patient in Figs. 13-15, where the scripts are made audible through speech synthesis and recognition functionality.

Besides the lack of a web-enabled wireless phone, Brown is further deficient as an anticipatory reference as the same fails to disclose receiving exercise-related information, as required by the independent claims.

Serial No.: 12/211,033

Applicant has noted advantages of the use of a web-enabled wireless phone at paragraphs [0015]-[0022], including specific advantages with respect to exercise-related information. As a simple illustration, a person could not do with Brown's device that which is intended by the claimed invention: for example, a cyclist could not take Brown's device on a bike ride to monitor heart rate and miles traveled.

Even more differences are apparent with respect to the dependent claims. For example, with respect to claim 17, the physiological data being monitored in Brown is transmitted to the apparatus through a standard connection cable (30); Brown does not disclose any wireless connection to a health monitoring or exercise device.

Numerous other distinctions will be apparent. For example, Brown does not disclose coupling a web-enabled wireless phone to a device which provides exercise-related information including physiological data and data indicating an amount of exercise performed, nor receiving such information. This aspect of including multiple types of data is mentioned in various locations in the specification, e.g., paragraphs [0015], [0017], and [0055]. Paragraph [0015] notes that "Various health parameters, such as those relating to nutrition or exercise, may be entered into a health monitoring device." Paragraph [0017] notes that "[what may be sent includes] data output from various exercise machines over the Internet..." And paragraph [0055] notes that, following a discussion of a blood glucose sensor, "Other health monitors may also be employed..."

[0015] In the second embodiment, a health or lifestyle management plan may be implemented. Various health parameters, such as those relating to nutrition or exercise, may be entered into a health monitoring device, in this instance termed an "exercise machine", and the same may be wireless communicated to a server. An application may process and store the health parameters, and a health specialist may optionally review the same.

[0017] Alternatively, in the second embodiment, a person interested in tracking an exercise program may take the WWD to the local health club and attach the same to an exercise machine, send data output from various exercise machines over the Internet, and receive a personalized response from the server of a company specializing in Health & Lifestyle Management. The individual may input caloric content of foods eaten, and may further input caloric content of exercise performed. In this way, e.g., a person in a weight-loss program may see in great detail whether they are expending more calories in the form of exercise than the same individual is consuming in the form of food.



Serial No.: 12/211,033

[0055] As examples of sensor types, to measure blood glucose levels, sensor 24 may be a sensor that accepts a drop of blood, e.g., via a finger-prick. To measure heart rate, sensor 24 may be placed via an adhesive sensor disposed on the chest. Other health monitors may also be employed so long as the measured data may either be transferred to WWD 12, e.g., via optional adaptor 42, described in further detail below, or by being read by a user, e.g., from a display, and manually input to WWD 12. Alternatively, the measured data may be transferred to WWD 12 via wireless communication schemes, such as RF includes Bluetooth® or 802.11, infrared, optical, microwaves, etc., directly from sensor 24 or from FIMD 11 as described in greater detail below.

The specific locations where sensors are described as connected to exercise machines include paragraphs [0018], [0044], and [0078]. As Brown provides no such teaching or disclosure of exercise management, nor teaching or disclosure of two types of data as noted above, Applicant respectfully submits that the rejection based on Brown should be withdrawn.

Even if Brown were to disclose the above, Applicant also notes that the reference is deficient as Brown discloses virtually no functions of the server application, beyond script and report generation and storage of script programs and response queries. Even if one identifies the programmable apparatus as the web-enabled wireless phone, then Brown cannot anticipate the claimed invention as the server application of Brown does not provide the report to this web-enabled wireless phone, but rather to the workstation. Conversely, if one identifies the workstation as the web-enabled wireless phone, then Brown cannot anticipate the claimed invention as the workstation does not have a way to couple to a device that provides exercise-related information. In summary, nowhere does Brown disclose that the server application performs a calculation using exercise-related information, and transmit a response corresponding to the calculation from the server back to the web-enabled wireless phone, as required by the claims noted above. Thus, the server application of the current invention differs widely from any software identified with Brown.

For at least the above reasons, Applicant submits that the anticipation rejection of the claims based on Brown should be withdrawn. The discussion above has focused on the independent claims; however, Applicant submits that the dependent claims are allowable for at least these reasons.

Serial No.: 12/211,033

**Nonstatutory Double Patenting Rejection**

With respect to the amended claims, Applicant traverses the nonstatutory double patenting rejection as follows. The current independent claims 1 and 8 (and corresponding CRM claims 14 and 15) are limited to methods requiring receiving exercise-related information in a web-enabled wireless phone, where the exercise-related information includes physiological data and data indicating an amount of exercise performed, and where at least one of the physiological data and the data indicating an amount of exercise performed is received from the device which provides exercise-related information. The claims of US Patent 6,602,191 do not so require these two types of data to be input. As noted above, various sections of the application point to these several types of data, and the claimed two types of data require monitoring of physiologic and exercise data during exercise. For example, the same would apply to tracking the amount of exercise performed during a bike ride as well as heart rate during the ride. For these reasons, it is respectfully submitted that the nonstatutory double patenting rejection should thus be withdrawn.

Should the Examiner be of the view that an interview would expedite consideration of the application, request is made that the Examiner telephone the Applicants' attorney at (619) 818-4615 in order that any outstanding issues be resolved.

Respectfully submitted,

Date: August 4, 2009

Attorney for Applicant  
Mayer & Williams PC  
251 North Avenue West, 2<sup>nd</sup> Floor  
Westfield, NJ 07090  
Tel: 619-818-4615  
Fax: 908-518-7795

/Mark Wieczorek/

Mark D. Wieczorek  
Registration No. 37,966

Under the Paperwork Reduction Act of 1995, no persons are required to respond to a collection of information unless it contains a valid OMB control number.

<b>INFORMATION DISCLOSURE STATEMENT BY APPLICANT</b> ( Not for submission under 37 CFR 1.99)	Application Number	12211033
	Filing Date	2008-09-15
	First Named Inventor	Roger Quy
	Art Unit	3769
	Examiner Name	Michael C. Astorino
	Attorney Docket Number	00125/002005

U.S.PATENTS						
Examiner Initial*	Cite No	Patent Number	Kind Code <sup>1</sup>	Issue Date	Name of Patentee or Applicant of cited Document	Pages,Columns,Lines where Relevant Passages or Relevant Figures Appear
	1	6790178	B1	2004-09-14	Mault et al.	

If you wish to add additional U.S. Patent citation information please click the Add button.

U.S.PATENT APPLICATION PUBLICATIONS						
Examiner Initial*	Cite No	Publication Number	Kind Code <sup>1</sup>	Publication Date	Name of Patentee or Applicant of cited Document	Pages,Columns,Lines where Relevant Passages or Relevant Figures Appear
	1					

If you wish to add additional U.S. Published Application citation information please click the Add button.

FOREIGN PATENT DOCUMENTS								
Examiner Initial*	Cite No	Foreign Document Number <sup>3</sup>	Country Code <sup>2</sup>	Kind Code <sup>4</sup>	Publication Date	Name of Patentee or Applicant of cited Document	Pages,Columns,Lines where Relevant Passages or Relevant Figures Appear	T <sup>5</sup>
	1							<input type="checkbox"/>

If you wish to add additional Foreign Patent Document citation information please click the Add button

NON-PATENT LITERATURE DOCUMENTS			
Examiner Initials*	Cite No	Include name of the author (in CAPITAL LETTERS), title of the article (when appropriate), title of the item (book, magazine, journal, serial, symposium, catalog, etc), date, pages(s), volume-issue number(s), publisher, city and/or country where published.	T <sup>5</sup>

**INFORMATION DISCLOSURE  
STATEMENT BY APPLICANT**  
( Not for submission under 37 CFR 1.99)

Application Number	12211033	
Filing Date	2008-09-15	
First Named Inventor	Roger Quy	
Art Unit	3769	
Examiner Name	Michael C. Astorino	
Attorney Docket Number	00125/002005	

	1		<input type="checkbox"/>
--	---	--	--------------------------

If you wish to add additional non-patent literature document citation information please click the Add button

**EXAMINER SIGNATURE**

Examiner Signature		Date Considered	
--------------------	--	-----------------	--

\*EXAMINER: Initial if reference considered, whether or not citation is in conformance with MPEP 609. Draw line through a citation if not in conformance and not considered. Include copy of this form with next communication to applicant.

<sup>1</sup> See Kind Codes of USPTO Patent Documents at [www.USPTO.GOV](http://www.USPTO.GOV) or MPEP 901.04. <sup>2</sup> Enter office that issued the document, by the two-letter code (WIPO Standard ST.3). <sup>3</sup> For Japanese patent documents, the indication of the year of the reign of the Emperor must precede the serial number of the patent document. <sup>4</sup> Kind of document by the appropriate symbols as indicated on the document under WIPO Standard ST.16 if possible. <sup>5</sup> Applicant is to place a check mark here if English language translation is attached.

**INFORMATION DISCLOSURE  
STATEMENT BY APPLICANT**  
( Not for submission under 37 CFR 1.99)

Application Number	12211033
Filing Date	2008-09-15
First Named Inventor	Roger Quy
Art Unit	3769
Examiner Name	Michael C. Astorino
Attorney Docket Number	00125/002005

**CERTIFICATION STATEMENT**

Please see 37 CFR 1.97 and 1.98 to make the appropriate selection(s):

- That each item of information contained in the information disclosure statement was first cited in any communication from a foreign patent office in a counterpart foreign application not more than three months prior to the filing of the information disclosure statement. See 37 CFR 1.97(e)(1).

**OR**

- That no item of information contained in the information disclosure statement was cited in a communication from a foreign patent office in a counterpart foreign application, and, to the knowledge of the person signing the certification after making reasonable inquiry, no item of information contained in the information disclosure statement was known to any individual designated in 37 CFR 1.56(c) more than three months prior to the filing of the information disclosure statement. See 37 CFR 1.97(e)(2).

- See attached certification statement.
- Fee set forth in 37 CFR 1.17 (p) has been submitted herewith.
- None

**SIGNATURE**

A signature of the applicant or representative is required in accordance with CFR 1.33, 10.18. Please see CFR 1.4(d) for the form of the signature.

Signature	/Mark Wieczorek/	Date (YYYY-MM-DD)	2009-08-04
Name/Print	Mark D. Wieczorek	Registration Number	37966

This collection of information is required by 37 CFR 1.97 and 1.98. The information is required to obtain or retain a benefit by the public which is to file (and by the USPTO to process) an application. Confidentiality is governed by 35 U.S.C. 122 and 37 CFR 1.14. This collection is estimated to take 1 hour to complete, including gathering, preparing and submitting the completed application form to the USPTO. Time will vary depending upon the individual case. Any comments on the amount of time you require to complete this form and/or suggestions for reducing this burden, should be sent to the Chief Information Officer, U.S. Patent and Trademark Office, U.S. Department of Commerce, P.O. Box 1450, Alexandria, VA 22313-1450. **DO NOT SEND FEES OR COMPLETED FORMS TO THIS ADDRESS. SEND TO: Commissioner for Patents, P.O. Box 1450, Alexandria, VA 22313-1450.**

## Privacy Act Statement

The Privacy Act of 1974 (P.L. 93-579) requires that you be given certain information in connection with your submission of the attached form related to a patent application or patent. Accordingly, pursuant to the requirements of the Act, please be advised that: (1) the general authority for the collection of this information is 35 U.S.C. 2(b)(2); (2) furnishing of the information solicited is voluntary; and (3) the principal purpose for which the information is used by the U.S. Patent and Trademark Office is to process and/or examine your submission related to a patent application or patent. If you do not furnish the requested information, the U.S. Patent and Trademark Office may not be able to process and/or examine your submission, which may result in termination of proceedings or abandonment of the application or expiration of the patent.

The information provided by you in this form will be subject to the following routine uses:

1. The information on this form will be treated confidentially to the extent allowed under the Freedom of Information Act (5 U.S.C. 552) and the Privacy Act (5 U.S.C. 552a). Records from this system of records may be disclosed to the Department of Justice to determine whether the Freedom of Information Act requires disclosure of these records.
2. A record from this system of records may be disclosed, as a routine use, in the course of presenting evidence to a court, magistrate, or administrative tribunal, including disclosures to opposing counsel in the course of settlement negotiations.
3. A record in this system of records may be disclosed, as a routine use, to a Member of Congress submitting a request involving an individual, to whom the record pertains, when the individual has requested assistance from the Member with respect to the subject matter of the record.
4. A record in this system of records may be disclosed, as a routine use, to a contractor of the Agency having need for the information in order to perform a contract. Recipients of information shall be required to comply with the requirements of the Privacy Act of 1974, as amended, pursuant to 5 U.S.C. 552a(m).
5. A record related to an International Application filed under the Patent Cooperation Treaty in this system of records may be disclosed, as a routine use, to the International Bureau of the World Intellectual Property Organization, pursuant to the Patent Cooperation Treaty.
6. A record in this system of records may be disclosed, as a routine use, to another federal agency for purposes of National Security review (35 U.S.C. 181) and for review pursuant to the Atomic Energy Act (42 U.S.C. 218(c)).
7. A record from this system of records may be disclosed, as a routine use, to the Administrator, General Services, or his/her designee, during an inspection of records conducted by GSA as part of that agency's responsibility to recommend improvements in records management practices and programs, under authority of 44 U.S.C. 2904 and 2906. Such disclosure shall be made in accordance with the GSA regulations governing inspection of records for this purpose, and any other relevant (i.e., GSA or Commerce) directive. Such disclosure shall not be used to make determinations about individuals.
8. A record from this system of records may be disclosed, as a routine use, to the public after either publication of the application pursuant to 35 U.S.C. 122(b) or issuance of a patent pursuant to 35 U.S.C. 151. Further, a record may be disclosed, subject to the limitations of 37 CFR 1.14, as a routine use, to the public if the record was filed in an application which became abandoned or in which the proceedings were terminated and which application is referenced by either a published application, an application open to public inspections or an issued patent.
9. A record from this system of records may be disclosed, as a routine use, to a Federal, State, or local law enforcement agency, if the USPTO becomes aware of a violation or potential violation of law or regulation.

## Electronic Patent Application Fee Transmittal

<b>Application Number:</b>	12211033			
<b>Filing Date:</b>	15-Sep-2008			
<b>Title of Invention:</b>	METHOD AND APPARATUS FOR HEALTH AND DISEASE MANAGEMENT COMBINING PATIENT DATA MONITORING WITH WIRELESS INTERNET CONNECTIVITY			
<b>First Named Inventor/Applicant Name:</b>	Roger J. Quy			
<b>Filer:</b>	David B. Bonham/Nancy Joyce Simmons			
<b>Attorney Docket Number:</b>	00125/002005			
Filed as Large Entity				
<b>Utility under 35 USC 111(a) Filing Fees</b>				
<b>Description</b>	<b>Fee Code</b>	<b>Quantity</b>	<b>Amount</b>	<b>Sub-Total in USD(\$)</b>
<b>Basic Filing:</b>				
<b>Pages:</b>				
<b>Claims:</b>				
<b>Miscellaneous-Filing:</b>				
<b>Petition:</b>				
<b>Patent-Appeals-and-Interference:</b>				
<b>Post-Allowance-and-Post-Issuance:</b>				
<b>Extension-of-Time:</b>				

Description	Fee Code	Quantity	Amount	Sub-Total in USD(\$)
<b>Miscellaneous:</b>				
Submission- Information Disclosure Stmt	1806	1	180	180
<b>Total in USD (\$)</b>				<b>180</b>



**Electronic Acknowledgement Receipt**

<b>EFS ID:</b>	5828782
<b>Application Number:</b>	12211033
<b>International Application Number:</b>	
<b>Confirmation Number:</b>	7693
<b>Title of Invention:</b>	METHOD AND APPARATUS FOR HEALTH AND DISEASE MANAGEMENT COMBINING PATIENT DATA MONITORING WITH WIRELESS INTERNET CONNECTIVITY
<b>First Named Inventor/Applicant Name:</b>	Roger J. Quy
<b>Customer Number:</b>	27774
<b>Filer:</b>	David B. Bonham/Nancy Joyce Simmons
<b>Filer Authorized By:</b>	David B. Bonham
<b>Attorney Docket Number:</b>	00125/002005
<b>Receipt Date:</b>	04-AUG-2009
<b>Filing Date:</b>	15-SEP-2008
<b>Time Stamp:</b>	19:20:37
<b>Application Type:</b>	Utility under 35 USC 111(a)

**Payment information:**

Submitted with Payment	yes
Payment Type	Deposit Account
Payment was successfully received in RAM	\$ 180
RAM confirmation Number	4826
Deposit Account	501047
Authorized User	

The Director of the USPTO is hereby authorized to charge indicated fees and credit any overpayment as follows:

Charge any Additional Fees required under 37 C.F.R. Section 1.16 (National application filing, search, and examination fees)

Charge any Additional Fees required under 37 C.F.R. Section 1.17 (Patent application and reexamination processing fees)

Charge any Additional Fees required under 37 C.F.R. Section 1.19 (Document supply fees)

Charge any Additional Fees required under 37 C.F.R. Section 1.20 (Post Issuance fees)

Charge any Additional Fees required under 37 C.F.R. Section 1.21 (Miscellaneous fees and charges)

**File Listing:**

Document Number	Document Description	File Name	File Size(Bytes)/ Message Digest	Multi Part /.zip	Pages (if appl.)
1		00125-002005_- _Response_to_OA.pdf	194442 <small>129b840f488501f7f06aad6ae5f13b4b7e28632</small>	yes	13
<b>Multipart Description/PDF files in .zip description</b>					
	<b>Document Description</b>		<b>Start</b>		<b>End</b>
	Amendment/Req. Reconsideration-After Non-Final Reject		1		1
	Claims		2		5
	Abstract		6		7
	Specification		8		8
	Applicant Arguments/Remarks Made in an Amendment		9		13
<b>Warnings:</b>					
<b>Information:</b>					
2	Information Disclosure Statement (IDS) Filed (SB/08)	00125_002005_IDS.pdf	32921 <small>40be4d41557e2bb3f5391941cedb545c4929990c</small>	no	4
<b>Warnings:</b>					
<b>Information:</b>					
This is not an USPTO supplied IDS fillable form					
3	Fee Worksheet (PTO-875)	fee-info.pdf	30758 <small>6264592b465e6079a0761068a585ce74006e3ce6</small>	no	2
<b>Warnings:</b>					
<b>Information:</b>					
<b>Total Files Size (in bytes):</b>			258121		

This Acknowledgement Receipt evidences receipt on the noted date by the USPTO of the indicated documents, characterized by the applicant, and including page counts, where applicable. It serves as evidence of receipt similar to a Post Card, as described in MPEP 503.

**New Applications Under 35 U.S.C. 111**

If a new application is being filed and the application includes the necessary components for a filing date (see 37 CFR 1.53(b)-(d) and MPEP 506), a Filing Receipt (37 CFR 1.54) will be issued in due course and the date shown on this Acknowledgement Receipt will establish the filing date of the application.

**National Stage of an International Application under 35 U.S.C. 371**

If a timely submission to enter the national stage of an international application is compliant with the conditions of 35 U.S.C. 371 and other applicable requirements a Form PCT/DO/EO/903 indicating acceptance of the application as a national stage submission under 35 U.S.C. 371 will be issued in addition to the Filing Receipt, in due course.

**New International Application Filed with the USPTO as a Receiving Office**

If a new international application is being filed and the international application includes the necessary components for an international filing date (see PCT Article 11 and MPEP 1810), a Notification of the International Application Number and of the International Filing Date (Form PCT/RO/105) will be issued in due course, subject to prescriptions concerning national security, and the date shown on this Acknowledgement Receipt will establish the international filing date of the application.

Under the Paperwork Reduction Act of 1995, no persons are required to respond to a collection of information unless it displays a valid OMB control number.

<b>PATENT APPLICATION FEE DETERMINATION RECORD</b> Substitute for Form PTO-875					Application or Docket Number <b>12/211,033</b>		Filing Date <b>09/15/2008</b>		<input type="checkbox"/> To be Mailed						
<b>APPLICATION AS FILED – PART I</b>							<b>OTHER THAN</b>								
(Column 1)			(Column 2)		SMALL ENTITY <input checked="" type="checkbox"/>		OR		SMALL ENTITY						
FOR	NUMBER FILED	NUMBER EXTRA		RATE (\$)	FEE (\$)	OR		RATE (\$)	FEE (\$)						
<input type="checkbox"/> BASIC FEE <small>(37 CFR 1.16(a), (b), or (c))</small>	N/A	N/A		N/A				N/A							
<input type="checkbox"/> SEARCH FEE <small>(37 CFR 1.16(k), (l), or (m))</small>	N/A	N/A		N/A				N/A							
<input type="checkbox"/> EXAMINATION FEE <small>(37 CFR 1.16(o), (p), or (q))</small>	N/A	N/A		N/A				N/A							
TOTAL CLAIMS <small>(37 CFR 1.16(i))</small>	minus 20 =	*		X \$ =				X \$ =							
INDEPENDENT CLAIMS <small>(37 CFR 1.16(h))</small>	minus 3 =	*		X \$ =				X \$ =							
<input type="checkbox"/> APPLICATION SIZE FEE <small>(37 CFR 1.16(s))</small>		If the specification and drawings exceed 100 sheets of paper, the application size fee due is \$250 (\$125 for small entity) for each additional 50 sheets or fraction thereof. See 35 U.S.C. 41(a)(1)(G) and 37 CFR 1.16(s).													
<input type="checkbox"/> MULTIPLE DEPENDENT CLAIM PRESENT <small>(37 CFR 1.16(j))</small>															
* If the difference in column 1 is less than zero, enter "0" in column 2.															
<b>APPLICATION AS AMENDED – PART II</b>							<b>OTHER THAN</b>								
(Column 1)			(Column 2)		(Column 3)		SMALL ENTITY		OR		SMALL ENTITY				
<b>AMENDMENT</b>	<b>08/04/2009</b>	CLAIMS REMAINING AFTER AMENDMENT		HIGHEST NUMBER PREVIOUSLY PAID FOR		PRESENT EXTRA		RATE (\$)	ADDITIONAL FEE (\$)		RATE (\$)	ADDITIONAL FEE (\$)			
	Total <small>(37 CFR 1.16(i))</small>	* 18	Minus	** 20	= 0		X \$26 =	0	OR		X \$ =				
	Independent <small>(37 CFR 1.16(h))</small>	* 2	Minus	***3	= 0		X \$110 =	0	OR		X \$ =				
	<input type="checkbox"/> Application Size Fee <small>(37 CFR 1.16(s))</small>														
	<input type="checkbox"/> FIRST PRESENTATION OF MULTIPLE DEPENDENT CLAIM <small>(37 CFR 1.16(j))</small>														
								TOTAL ADD'L FEE	<b>0</b>		OR		TOTAL ADD'L FEE		
<b>AMENDMENT</b>	(Column 1)		(Column 2)		(Column 3)		RATE (\$)	ADDITIONAL FEE (\$)		RATE (\$)	ADDITIONAL FEE (\$)				
	CLAIMS REMAINING AFTER AMENDMENT		HIGHEST NUMBER PREVIOUSLY PAID FOR		PRESENT EXTRA		X \$ =			OR		X \$ =			
	Total <small>(37 CFR 1.16(i))</small>		*		Minus **		=		OR		X \$ =				
	Independent <small>(37 CFR 1.16(h))</small>		*		Minus ***		=		OR		X \$ =				
	<input type="checkbox"/> Application Size Fee <small>(37 CFR 1.16(s))</small>														
<input type="checkbox"/> FIRST PRESENTATION OF MULTIPLE DEPENDENT CLAIM <small>(37 CFR 1.16(j))</small>															
								TOTAL ADD'L FEE			OR		TOTAL ADD'L FEE		
* If the entry in column 1 is less than the entry in column 2, write "0" in column 3.											Legal Instrument Examiner: /TINA J. BARDEN/				
** If the "Highest Number Previously Paid For" IN THIS SPACE is less than 20, enter "20".															
*** If the "Highest Number Previously Paid For" IN THIS SPACE is less than 3, enter "3".															
The "Highest Number Previously Paid For" (Total or Independent) is the highest number found in the appropriate box in column 1.															

This collection of information is required by 37 CFR 1.16. The information is required to obtain or retain a benefit by the public which is to file (and by the USPTO to process) an application. Confidentiality is governed by 35 U.S.C. 122 and 37 CFR 1.14. This collection is estimated to take 12 minutes to complete, including gathering, preparing, and submitting the completed application form to the USPTO. Time will vary depending upon the individual case. Any comments on the amount of time you require to complete this form and/or suggestions for reducing this burden, should be sent to the Chief Information Officer, U.S. Patent and Trademark Office, U.S. Department of Commerce, P.O. Box 1450, Alexandria, VA 22313-1450. DO NOT SEND FEES OR COMPLETED FORMS TO THIS ADDRESS. **SEND TO: Commissioner for Patents, P.O. Box 1450, Alexandria, VA 22313-1450.**

*If you need assistance in completing the form, call 1-800-PTO-9199 and select option 2.*



UNITED STATES PATENT AND TRADEMARK OFFICE

UNITED STATES DEPARTMENT OF COMMERCE  
 United States Patent and Trademark Office  
 Address: COMMISSIONER FOR PATENTS  
 P.O. Box 1450  
 Alexandria, Virginia 22313-1450  
 www.uspto.gov



Bib Data Sheet

CONFIRMATION NO. 7693

<b>SERIAL NUMBER</b> 12/211,033	<b>FILING OR 371(c) DATE</b> 09/15/2008 <b>RULE</b>	<b>CLASS</b> 600	<b>GROUP ART UNIT</b> 3769	<b>ATTORNEY DOCKET NO.</b> 00125/002005
------------------------------------	---	---------------------	-------------------------------	--

**APPLICANTS**

Roger J. Quy, Mill Valley, CA;

**\*\* CONTINUING DATA \*\*\*\*\***

This application is a CON of 11/649,703 01/03/2007 ABN which is a CON of 11/184,274 07/18/2005 PAT 7,156,808 which is a CON of 10/418,845 04/18/2003 PAT 6,936,007 which is a CON of 09/738,270 12/15/2000 PAT 6,602,191 which claims benefit of 60/172,486 12/17/1999

**\*\* FOREIGN APPLICATIONS \*\*\*\*\***

**IF REQUIRED, FOREIGN FILING LICENSE GRANTED\*\* SMALL ENTITY \*\***

\*\* 09/24/2008

Foreign Priority claimed <input type="checkbox"/> yes <input type="checkbox"/> no	<b>STATE OR COUNTRY</b> CA	<b>SHEETS DRAWING</b> 8	<b>TOTAL CLAIMS</b> 12	<b>INDEPENDENT CLAIMS</b> 2
35 USC 119 (a-d) conditions met <input type="checkbox"/> yes <input type="checkbox"/> no <input type="checkbox"/> Met after Allowance				
Verified and Acknowledged	Examiner's Signature _____	Initials _____		

**ADDRESS**

27774

**TITLE**

METHOD AND APPARATUS FOR MONITORING EXERCISE WITH WIRELESS INTERNET CONNECTIVITY

<b>FILING FEE RECEIVED</b> 527	FEES: Authority has been given in Paper No. _____ to charge/credit DEPOSIT ACCOUNT No. _____ for following:	<input type="checkbox"/> All Fees
		<input type="checkbox"/> 1.16 Fees ( Filing )
		<input type="checkbox"/> 1.17 Fees ( Processing Ext. of time )
		<input type="checkbox"/> 1.18 Fees ( Issue )
		<input type="checkbox"/> Other _____
		<input type="checkbox"/> Credit



UNITED STATES PATENT AND TRADEMARK OFFICE

UNITED STATES DEPARTMENT OF COMMERCE  
 United States Patent and Trademark Office  
 Address: COMMISSIONER FOR PATENTS  
 P.O. Box 1450  
 Alexandria, Virginia 22313-1450  
 www.uspto.gov

APPLICATION NO.	FILING DATE	FIRST NAMED INVENTOR	ATTORNEY DOCKET NO.	CONFIRMATION NO.
12/211,033	09/15/2008	Roger J. Quy	00125/002005	7693
2774	7590	12/29/2009	EXAMINER ASTORINO, MICHAEL C	
MAYER & WILLIAMS PC 251 NORTH AVENUE WEST 2ND FLOOR WESTFIELD, NJ 07090			ART UNIT	PAPER NUMBER
			3769	
			MAIL DATE	DELIVERY MODE
			12/29/2009	PAPER

**Please find below and/or attached an Office communication concerning this application or proceeding.**

The time period for reply, if any, is set in the attached communication.

<b>Office Action Summary</b>	<b>Application No.</b> 12/211,033	<b>Applicant(s)</b> QUY, ROGER J.	
	<b>Examiner</b> Michael C. Astorino	<b>Art Unit</b> 3769	

-- The MAILING DATE of this communication appears on the cover sheet with the correspondence address --

### Period for Reply

A SHORTENED STATUTORY PERIOD FOR REPLY IS SET TO EXPIRE 3 MONTH(S) OR THIRTY (30) DAYS, WHICHEVER IS LONGER, FROM THE MAILING DATE OF THIS COMMUNICATION.

- Extensions of time may be available under the provisions of 37 CFR 1.136(a). In no event, however, may a reply be timely filed after SIX (6) MONTHS from the mailing date of this communication.
- If NO period for reply is specified above, the maximum statutory period will apply and will expire SIX (6) MONTHS from the mailing date of this communication.
- Failure to reply within the set or extended period for reply will, by statute, cause the application to become ABANDONED (35 U.S.C. § 133). Any reply received by the Office later than three months after the mailing date of this communication, even if timely filed, may reduce any earned patent term adjustment. See 37 CFR 1.704(b).

### Status

- 1)  Responsive to communication(s) filed on 8/4/09.
- 2a)  This action is **FINAL**.                      2b)  This action is non-final.
- 3)  Since this application is in condition for allowance except for formal matters, prosecution as to the merits is closed in accordance with the practice under *Ex parte Quayle*, 1935 C.D. 11, 453 O.G. 213.

### Disposition of Claims

- 4)  Claim(s) 1-18 is/are pending in the application.
- 4a) Of the above claim(s) \_\_\_\_\_ is/are withdrawn from consideration.
- 5)  Claim(s) \_\_\_\_\_ is/are allowed.
- 6)  Claim(s) 1-18 is/are rejected.
- 7)  Claim(s) \_\_\_\_\_ is/are objected to.
- 8)  Claim(s) \_\_\_\_\_ are subject to restriction and/or election requirement.

### Application Papers

- 9)  The specification is objected to by the Examiner.
- 10)  The drawing(s) filed on \_\_\_\_\_ is/are: a)  accepted or b)  objected to by the Examiner.  
Applicant may not request that any objection to the drawing(s) be held in abeyance. See 37 CFR 1.85(a).  
Replacement drawing sheet(s) including the correction is required if the drawing(s) is objected to. See 37 CFR 1.121(d).
- 11)  The oath or declaration is objected to by the Examiner. Note the attached Office Action or form PTO-152.

### Priority under 35 U.S.C. § 119

- 12)  Acknowledgment is made of a claim for foreign priority under 35 U.S.C. § 119(a)-(d) or (f).
- a)  All    b)  Some \*    c)  None of:
1.  Certified copies of the priority documents have been received.
  2.  Certified copies of the priority documents have been received in Application No. \_\_\_\_\_.
  3.  Copies of the certified copies of the priority documents have been received in this National Stage application from the International Bureau (PCT Rule 17.2(a)).

\* See the attached detailed Office action for a list of the certified copies not received.

### Attachment(s)

- |  |  |
|--|--|
| <p>1) <input type="checkbox"/> Notice of References Cited (PTO-892)</p> <p>2) <input type="checkbox"/> Notice of Draftsperson's Patent Drawing Review (PTO-948)</p> <p>3) <input checked="" type="checkbox"/> Information Disclosure Statement(s) (PTO/SB/08)<br/>Paper No(s)/Mail Date <u>8/4/09 &amp; 5/11/09</u>.</p> | <p>4) <input type="checkbox"/> Interview Summary (PTO-413)<br/>Paper No(s)/Mail Date. _____.</p> <p>5) <input type="checkbox"/> Notice of Informal Patent Application</p> <p>6) <input type="checkbox"/> Other: _____.</p> |
|--|--|

Application/Control Number: 12/211,033  
Art Unit: 3769

Page 2

### **DETAILED ACTION**

The Examiner acknowledges the response filed August 4, 2009, wherein claims 1-18 are pending. For the record claims 14 and 15 are claims with a separate statutory class from method claims 1 and 8. The fact that claims 14 and 15 refer back, or reference claim 1 does not make claims 14 and 15 dependent claims. As such there are four independent claims and fourteen dependent claims pending in this application.

#### ***Information Disclosure Statement***

The information disclosure statement filed August 4, 2009 complies with the provisions of 37 CFR 1.97, 1.98 and MPEP § 609. It has been placed in the application file, the examiner's initials have been provided for each citation, the document has been signed and dated, and the information referred to therein has been considered as to the merits.

The information disclosure statement filed May 11, 2009 fails to comply with 37 CFR 1.98(a)(2), which requires a legible copy of each cited foreign patent document; each non-patent literature publication or that portion which caused it to be listed; and all other information or that portion which caused it to be listed. It has been placed in the application file, but the information referred to therein has not been considered.

#### ***Claim Rejections - 35 USC § 101***

35 U.S.C. 101 reads as follows:

Whoever invents or discovers any new and useful process, machine, manufacture, or composition of matter, or any new and useful improvement thereof, may obtain a patent therefor, subject to the conditions and requirements of this title.



Application/Control Number: 12/211,033  
Art Unit: 3769

Page 3

Claims 8-15 are rejected under 35 U.S.C. 101 because the claims recite a computer readable medium. The phrase "computer readable medium" was never explicitly defined in the specification.

Computer readable medium includes many possibilities including volatile and nonvolatile media, removable and non-removable media, which further could include RAM, ROM, EEPROM, flash memory or other memory technology, CD-ROM, digital versatile disks (DVD) or other optical storage, magnetic based storage or any other medium which can be used to store desired information and computer readable instructions, data structures, program modules or other data in a modulated data signal such as a *carrier wave* or other transport mechanism and includes any information delivery media. The term "modulated data signal" means a signal that has one or more of its characteristics set of changed in such a manner as to encode information in the signal. By way of example, and not limitation, communication media includes wired media such as wired network or direct-wired connection, and wireless media such as acoustic, RF, infrared and other wireless media. Evidence of the examiner's position regarding the broadest reasonable interpretation of the phrase machine readable medium is provided in Mitchell et al. US 2005/0235345 paragraphs [0020] and [0021].

A computer readable medium including a carrier wave is abstract idea having no practical application and as such is non-eligible subject matter.

Application/Control Number: 12/211,033  
Art Unit: 3769

Page 4

***Claim Objections***

Claim 15 is objected to because of the following informalities: in line 1 there is an extra space between “medium” and the comma. The examiner suggestion removing the extra character space from the claim to read, e.g. “medium,”. Appropriate correction is required.

***Claim Rejections - 35 USC § 112***

The following is a quotation of the second paragraph of 35 U.S.C. 112:

The specification shall conclude with one or more claims particularly pointing out and distinctly claiming the subject matter which the applicant regards as his invention.

**Claims 1-18 are rejected under 35 U.S.C. 112, second paragraph, as being indefinite for failing to particularly point out and distinctly claim the subject matter which applicant regards as the invention.**

In regards to claims 1 and 8, the examiner cannot discern based on the specification the distinction between “physiological data” and “data indicating an amount of exercise performed” because the data overlaps, and as such the examiner cannot discern if two types of data is required or one type of data is required. For example, calories-burned while exercising is physiological data and data indicating an amount of exercise performed. As such one type of data, “calories-burned” would cover two categories “physiological data” and “data indicating an amount of exercise performed”.

Applicant states, “[p]hysiological information is clear from the specification at, e.g., paragraph [0018] as describing devices that ‘monitor the physiologic status of a healthy subject’ and data indicating an amount of exercise performed is described in the specification at, e.g., paragraph [0044].” “Physiological information” is assumed to be synonymous with

Application/Control Number: 12/211,033

Page 5

Art Unit: 3769

physiological data. More importantly it is incorrect to suggest that physiological data or information comes from a device. Physiological information can be received from person, a person can measure there heart rate with there fingers lightly pressed against the carotid artery and a clock. The only device is the clock, but a clock is not sufficient by itself to measure heart rate such that it is physiological information or data. However, it is acceptable to assert physiological information is a “physiologic status of a healthy subject”. For example, calories expended while exercising is a type of physiological status/measurement of a healthy subject, but calories expended is also an amount of exercise performed.

Applicant relies on paragraph [0044] to support an argument of definiteness. However, paragraph [0044] merely states that “[0044] In a healthy lifestyle management embodiment, an HMD may be an exercise machine, including treadmills, rowers, steppers, exercise cycles, or other aerobic or anaerobic exercisers, or a monitor, include monitors for temperature, heart rate, blood pressure, *amount of work or rate of work performed, etc.*” (emphasis added). The Applicant’s assertion that this paragraph clears an otherwise murky issue is incredulous because it merely re-states the claimed limitation.

In conclusion the limitation directed to receiving “physiological data” and “data indicating an amount of exercise performed” is indefinite. The limitation appears to overlap in scope and as such the examiner cannot discern if two types of data are required or one type of data is required under the broadest reasonable interpretation of the claimed invention.

Additionally, claims 14-15 which refer back to claims 1 and 8, and dependent claims 2-7, and 9-13 are rejected because they are refer back to or depend on a rejected claim.

Application/Control Number: 12/211,033  
Art Unit: 3769

Page 6

Claim 17 is rejected under 35 U.S.C. 112, second paragraph, as being indefinite for failing to particularly point out and distinctly claim the subject matter which applicant regards as the invention. In claim 17, the applicant uses trademark, “Bluetooth®” in the claim. See below, MPEP § 2173.05(u). “...A trademark or trade name does not identify or describe the goods associated with the trademark or trade name...”. The examiner suggests removing “Bluetooth®”, amending the claim to state “short-range wireless transmission”<sup>1</sup>. For examination purposes claim 17 will be examined as if it stated “short-range wireless transmission”.

#### **2173.05(u) Trademarks or Trade Names in a Claim**

The presence of a trademark or trade name in a claim is not, per se, improper under 35 U.S.C. 112, second paragraph, but the claim should be carefully analyzed to determine how the mark or name is used in the claim. It is important to recognize that a trademark or trade name is used to identify a source of goods, and not the goods themselves. Thus a trademark or trade name does not identify or describe the goods associated with the trademark or trade name. See definitions of trademark and trade name in MPEP § 608.01(v). A list of some trademarks is found in Appendix I. If the trademark or trade name is used in a claim as a limitation to identify or describe a particular material or product, the claim does not comply with the requirements of the 35 U.S.C. 112, second paragraph. Ex parte Simpson, 218 USPQ 1020 (Bd. App. 1982). The claim scope is uncertain since the trademark or trade name cannot be used properly to identify any particular material or product. In fact, the value of a trademark would be lost to the extent that it became descriptive of a product, rather than used as an identification of a source or origin of a product. Thus, the use of a trademark or trade name in a claim to identify or describe a material or product would not only render a claim indefinite, but would also constitute an improper use of the trademark or trade name. If a trademark or trade name appears in a claim and is not intended as a limitation in the claim, the question of why it is in the claim should be addressed. Does its presence in the claim cause confusion as to the scope of the claim? If so, the claim should be rejected under 35 U.S.C. 112, second paragraph.

#### ***Note to Applicant Regarding Claim Interpretation***

Each of the following items are directed to descriptive material that is nonfunctional descriptive material because the broadest reasonable interpretation is that the claims are merely

---

<sup>1</sup> Using Short-range wireless transmission is a suggestion that if the Applicant decides to use should be reviewed for

Application/Control Number: 12/211,033

Page 7

Art Unit: 3769

instructions that are not given patentable weight. *See MPEP 2106.01*. In regards to claims 8-15 “computer readable medium” because the computer readable medium can be a carrier wave with instructions which does not have a structural component.

### ***Claim Rejections - 35 USC § 102***

The following is a quotation of the appropriate paragraphs of 35 U.S.C. 102 that form the basis for the rejections under this section made in this Office action:

A person shall be entitled to a patent unless –

(e) the invention was described in (1) an application for patent, published under section 122(b), by another filed in the United States before the invention by the applicant for patent or (2) a patent granted on an application for patent by another filed in the United States before the invention by the applicant for patent, except that an international application filed under the treaty defined in section 351(a) shall have the effects for purposes of this subsection of an application filed in the United States only if the international application designated the United States and was published under Article 21(2) of such treaty in the English language.

**Claims 1-18 are rejected under 35 U.S.C. 102(b) as being anticipated by Brown US**

**Patent Number 5,997,476.**

Brown teaches the use of a remote apparatus (26/28) with a communication network (24, Internet) workstation (20) to remotely monitor a patient/user, (figure 1). The remote apparatus is disclosed as being on a cellular/wireless network, i.e. a cellular/wireless phone (column 4, lines 36-63). The remote apparatus includes many different types of monitoring devices including weight scales and heart rate/pulse rate (column 5, lines 3-6) with an RS-232 connection (column 6, lines 44-46). Brown’s remote apparatus further includes a keyboard/buttons to input data regarding how people feel (see fig. 7).

As stated above in regards to claims 8-15 the phrase “computer readable medium” computer readable medium can be a carrier wave which does not have a structural component

---

compliance under 35 U.S.C. 112 first paragraph for written description issues, i.e. “new matter.”

Application/Control Number: 12/211,033  
Art Unit: 3769

Page 8

and as such lacks patentable weight. The remainder of the structural limitations in the claims is anticipated by Brown.

See Response to Arguments section below for further details of the rejection.

### ***Double Patenting***

The nonstatutory double patenting rejection is based on a judicially created doctrine grounded in public policy (a policy reflected in the statute) so as to prevent the unjustified or improper timewise extension of the "right to exclude" granted by a patent and to prevent possible harassment by multiple assignees. See *In re Goodman*, 11 F.3d 1046, 29 USPQ2d 2010 (Fed. Cir. 1993); *In re Longi*, 759 F.2d 887, 225 USPQ 645 (Fed. Cir. 1985); *In re Van Ornum*, 686 F.2d 937, 214 USPQ 761 (CCPA 1982); *In re Vogel*, 422 F.2d 438, 164 USPQ 619 (CCPA 1970); and, *In re Thorington*, 418 F.2d 528, 163 USPQ 644 (CCPA 1969).

A timely filed terminal disclaimer in compliance with 37 CFR 1.321(c) may be used to overcome an actual or provisional rejection based on a nonstatutory double patenting ground provided the conflicting application or patent is shown to be commonly owned with this application. See 37 CFR 1.130(b).

Effective January 1, 1994, a registered attorney or agent of record may sign a terminal disclaimer. A terminal disclaimer signed by the assignee must fully comply with 37 CFR 3.73(b).

Claims ***1-12*** are rejected under the judicially created doctrine of obviousness-type double patenting as being unpatentable over ***claims 3-6, and 33-43*** of U.S. Patent No. ***6,602,191***. Although the conflicting claims are not identical, they are not patentably distinct from each other

Application/Control Number: 12/211,033

Page 9

Art Unit: 3769

because it would have been obvious to one of ordinary skill in the art at the time of the invention to implement the method of the patent in the manner set forth in the instant application since the claims of the instant application are merely different renditions of the patented method and computer readable medium.

The Applicant is invited to explain, to make the record clear, reasons that the double patenting rejection does not apply.

***Response to Arguments***

Applicant's arguments filed August 4, 2009 have been fully considered but they are not persuasive.

Application/Control Number: 12/211,033  
Art Unit: 3769

Page 10

In regards to rejections under 35 U.S.C. 112, the Examiner disagrees with the Applicant that the amended claims are now in compliance. The Examiner has provided a detailed and updated rejection above on the newly amended claims.

In regards to rejections under 35 U.S.C. 102, the Examiner disagrees with the Applicant that the rejection should be withdrawn. The Examiner has thoroughly reviewed the Applicant response, and paraphrased and responded to the major arguments presented by the Applicant below:

**1. Brown notably fails to disclose any substantial teaching of how to take patient monitoring "into the field", i.e. to make it work wherever the patient is as long as there is a standard wireless connection.**

Examiner Response: Applicant never claimed the use of a wireless connection to perform any step of the method. As such even if the Examiner were to concede the Brown does not teach a wireless connection, which the Examiner does not concede, a wired connection still rejects properly the broadest reasonable interpretation of the claimed invention. The Applicant actually admits such a fact in claim 4 wherein the reception of exercised-related data occurs via a wired connection. Albeit claim 17, includes more specifics regarding the wireless connection, claim 17 is dependent on claim 4. And in rejecting claim 4 the examiner merely has to reject the wired alternative to then also reject claim 17 because the more specific wireless requirements to the wireless alternative do not affect the wired alternative.

**2. Brown lacks the use of a web-enabled wireless phone.**



Application/Control Number: 12/211,033

Page 11

Art Unit: 3769

Examiner Response: the broadest reasonable interpretation of a web-enabled wireless phone is taught by Brown in column 4, lines 35-63.

**3. Brown lacks “data indicating an amount of exercise performed”.**

Examiner Response: Brown disclosure is sufficient to reject the broadest reasonable interpretation of using data indicating an amount of exercise performed. A 60 year old user of the Brown device can reaching a maximum heart rate such as 160 bpm would be sufficient to reject the claim because the 60 year old user exercised an amount necessary to raise his heart rate to the maximum level. On a side note the claims never required the use of a bike, or a measurement of distance miles traveled.

Application/Control Number: 12/211,033  
Art Unit: 3769

Page 12

**4. Brown lacks the use of a server calculation.**

The specification states in paragraph [0072] that “[t]he term "calculate" is also used generally, and may entail a simple calculation as well as a complex one. A result may, e.g., be the result of a calculation.” The broadest reasonable interpretation of the Applicant’s definition of a calculation being a result is sufficiently rejected by a new script from the Brown server.

Regarding the double patenting rejection the broadest reasonable interpretation of claims in this application is merely a different rendition of the claims in the patent.

The Applicant is invited to request an interview to discuss suggestions to overcome the applied prior art.

***Conclusion***

Any inquiry concerning this communication or earlier communications from the examiner should be directed to Michael C. Astorino whose telephone number is (571)272-4723. The examiner can normally be reached on Monday-Friday, 8:30AM to 3:30PM.

If attempts to reach the examiner by telephone are unsuccessful, the examiner’s supervisor, Henry Johnson can be reached on 571-272-4726. The fax phone number for the organization where this application or proceeding is assigned is 571-273-8300.

Application/Control Number: 12/211,033  
Art Unit: 3769

Page 13

Information regarding the status of an application may be obtained from the Patent Application Information Retrieval (PAIR) system. Status information for published applications may be obtained from either Private PAIR or Public PAIR. Status information for unpublished applications is available through Private PAIR only. For more information about the PAIR system, see <http://pair-direct.uspto.gov>. Should you have questions on access to the Private PAIR system, contact the Electronic Business Center (EBC) at 866-217-9197 (toll-free). If you would like assistance from a USPTO Customer Service Representative or access to the automated information system, call 800-786-9199 (IN USA OR CANADA) or 571-272-1000.

/Michael C. Astorino/  
Primary Examiner, Art Unit 3769

December 22, 2009

<b>Search Notes</b>  	<b>Application/Control No.</b>  12211033	<b>Applicant(s)/Patent Under Reexamination</b>  QUY, ROGER J.
	<b>Examiner</b>  Michael C Astorino	<b>Art Unit</b>  3769

<b>SEARCHED</b>			
<b>Class</b>	<b>Subclass</b>	<b>Date</b>	<b>Examiner</b>
600	300-301 (text)	5/09	MA

<b>SEARCH NOTES</b>		
<b>Search Notes</b>	<b>Date</b>	<b>Examiner</b>
East search (class/subclass, inventor, parent cases backwards search)	5/09	MA
Reviewed applied prior art, spoke with H. Johnson	11/09	MA

<b>INTERFERENCE SEARCH</b>			
<b>Class</b>	<b>Subclass</b>	<b>Date</b>	<b>Examiner</b>

--	--

PTO/SB/08a (05-07)

Approved for use through 11/30/2007. OMB 0651-0031

U.S. Patent and Trademark Office; U.S. DEPARTMENT OF COMMERCE

Under the Paperwork Reduction Act of 1995, no persons are required to respond to a collection of information unless it contains a valid OMB control number.

<b>INFORMATION DISCLOSURE STATEMENT BY APPLICANT</b> ( Not for submission under 37 CFR 1.99)	Application Number		12211033	
	Filing Date		2008-09-15	
	First Named Inventor		Roger J. Quy	
	Art Unit		3769	
	Examiner Name		Michael C. Astorino	
	Attorney Docket Number		00125/002005	

U.S.PATENTS						
Examiner Initial*	Cite No	Patent Number	Kind Code <sup>1</sup>	Issue Date	Name of Patentee or Applicant of cited Document	Pages, Columns, Lines where Relevant Passages or Relevant Figures Appear
	1	5576952		1996-11-19	Stutman et al.	
	2	6093146		2000-07-25	Filangeri	
	3	6478736		2002-11-12	Mault	
	4	6610012	B2	2003-08-26	Mault	
	5	6856832		2005-02-15	Matsumura et al.	
	6	6936007	B2	2005-08-30	Quy	
	7	6976958	B2	2005-12-20	Quy	

If you wish to add additional U.S. Patent citation information please click the Add button.

**U.S.PATENT APPLICATION PUBLICATIONS**

**INFORMATION DISCLOSURE STATEMENT BY APPLICANT**  
( Not for submission under 37 CFR 1.99)

Application Number		12211033
Filing Date		2008-09-15
First Named Inventor	Roger J. Quy	
Art Unit	3769	
Examiner Name	Michael C. Astorino	
Attorney Docket Number	00125/002005	

U.S. PATENT DOCUMENTS						
Examiner Initials <sup>1</sup>	Cite No. <sup>1</sup>	U.S. Patent Document		Name of Patentee or Applicant of Cited Document	Date of Publication of Cited document MM-DD-YYYY	Pages, Column, Lines, Where Relevant Passages or Relevant Figures Appear
		Number	Kind Code <sup>2</sup> (If known)			
	AA	60/264,739		Posa et al.	01/2001	
	AB	4,282,883		Yerushalmy	08/1981	
	AC	5,012,814		Mills et al.	05/1991	
	AD	5,307,263		Brown	04/1994	
	AE	5,357,427		Langen et al.	10/1994	
	AF	5,434,611		Tamura	07/1995	
	AG	5,441,047		David et al.	08/1995	
	AH	5,544,649		David et al.	09/1996	
	AI	5,544,661		Davis et al.	08/1996	
	AJ	5,549,117		Tacklind et al.	08/1996	
	AK	5,553,609		Chen et al.	09/1996	
	AL	5,601,435		Quy	02/1997	
	AM	5,626,144		Tacklind et al.	05/1997	
	AN	5,678,562		Sellers	10/1997	
	AO	5,701,904		Simmons et al.	12/1997	
	AP	5,704,366		Tacklind, et al	01/1998	
	AQ	5,724,025		Tavori	03/1998	
	AR	5,732,709		Tacklind, et al	03/1998	
	AS	5,735,285		Albert, et al.	04/1998	
	AT	5,752,917		Fuchs	05/1998	
	AU	5,772,586		Heinonen, et al.	06/1998	
	AV	5,791,342		Woodard	09/1998	
	AW	5,931,791		Saltzstein et al.	08/1999	
	AX	5,933,136		Brown	08/1999	
	AY	5,935,060		Iliff	08/1999	
	AZ	5,941,829		Saltzstein et al.	08/1999	
	BA	5,951,300		Brown	09/1999	
	BB	5,959,533		Layson et al.	09/1999	
	BC	5,964,701		Asada, et al.	10/1999	
	BD	5,967,975		Ridgeway, Donald G.	10/1999	
	BE	5,987,352		Klein et al.	11/1999	
	BF	5,987,519		Peifer, et al.	10/1999	
	BG	5,997,476		Brown	12/1999	
	BH	6,022,315		Iliff	02/2000	
	BI	6,024,699		Surwit et al.	02/2000	
	BJ	6,050,940		Braun et al.	04/2000	
	BK	6,055,506		Frasca, Jr.	04/2000	
	BL	6,057,758		Dempsey, et al.	05/2000	

Examiner Signature	/Michael Astorino/	Date Considered	12/22/2009
--------------------	--------------------	-----------------	------------

<sup>1</sup>EXAMINER: Initial if reference considered, whether or not citation is in conformance with MPEP 609. Draw line through citation if not in conformance and not considered. Include copy of this form with next communication to applicant.

<sup>2</sup>Unique citation designation number. <sup>3</sup>Applicant is to place a check mark here if English language translation is attached.

Burden Hour Statement: This form is estimated to take 2.0 hours to complete. Time will vary depending upon the needs of the individual case. Any comments on the amount of time you are required to complete this form should be sent to the Chief Information Officer, Patent and Trademark Office, Washington, DC 20230.

ALL REFERENCES CONSIDERED EXCEPT WHERE LINED THROUGH. /MA/

<b>INFORMATION DISCLOSURE STATEMENT BY APPLICANT</b> ( Not for submission under 37 CFR 1.99)	Application Number		12211033
	Filing Date		2008-09-15
	First Named Inventor	Roger J. Quy	
	Art Unit	3769	
	Examiner Name	Michael C. Astorino	
	Attorney Docket Number	00125/002005	

U.S. PATENT DOCUMENTS						
Examiner Initials <sup>1</sup>	Cite No. <sup>1</sup>	U.S. Patent Document		Name of Patentee or Applicant of Cited Document	Date of Publications of Cited document MM-DD-YYYY	Pages, Column, Lines, Where Relevant Passages or Relevant Figures Appear
		Number	Kind Code <sup>2</sup> (if known)			
	BM	6,059,692		Hickman	05/2000	
	BN	6,083,156		Leselicki	07/2000	
	BO	6,101,478		Brown	08/2000	
	BP	6,144,837		Quy	11/2000	
	BQ	6,160,478		Jacobsen et al.	12/2000	
	BR	6,168,563		Brown	01/2001	
	BS	6,190,324		Kieval et al.	02/2001	
	BT	6,266,645		Simpson	07/2001	
	BU	6,319,199		Sheehan et al.	11/2001	
	BV	6,336,900		Alleckson et al.	01/2001	
	BW	6,375,614		Braun et al.	04/2002	
	BX	6,386,882		Lindberg	05/2002	
	BY	6,416,471		Kumar et al.	07/2002	
	BZ	6,418,346		Nelson et al.	07/2002	
	CA	6,440,068		Brown et al.	08/2002	
	CB	6,450,955		Brown et al.	09/2002	
	CC	6,458,080		Brown et al.	10/2002	
	CD	6,529,771		Kieval et al.	03/2003	
	CE	6,602,191		Quy	08/2003	
	CF	20020016719		Nemeth et al.	02/2002	
	CG	20020019584		Schultze et al.	02/2002	
	CH	20020026223		Riff et al.	02/2002	
	CI	20020072785		Nelson et al.	06/2002	
	CJ	20020082480		Riff et al.	06/2002	
	CK	20020120310		Linden et al.	08/2002	
	CL	20030004554		Riff et al.	01/2003	
	CM	20030072424		Evans et al.	04/2003	
	CN	20030139785		Riff et al.	07/2003	
	CO	20030204413		Riff	10/2003	

FOREIGN PATENT DOCUMENTS								
Examiner Initials <sup>1</sup>	Cite No. <sup>1</sup>	Foreign Patent Document			Name of Patentee or Applicant of Cited Document	Date of Publications of Cited document MM-DD-YYYY	Pages, Column, Lines, Where Relevant Passages or Relevant Figures Appear	Y <sup>3</sup>
		Office <sup>3</sup>	Number <sup>2</sup>	Kind Code <sup>3</sup> (if known)				
			WO 95/32480		ENACT PRODUCTS	11/1995		
	CQ		WO 97/28736		NOKIA MOBILE PHONES LTD	08/1997		

Examiner Signature	/Michael Astorino/	Date Considered	12/22/2009
--------------------	--------------------	-----------------	------------

<sup>1</sup>EXAMINER: Initial if reference considered, whether or not citation is in conformance with MPEP 609. Draw line through citation if not in conformance and not considered. Include copy of this form with next communication to applicant.  
<sup>2</sup>Unique citation designation number. <sup>3</sup>Applicant is to place a check mark here if English language Translation is attached.  
 Burden Hour Statement: This form is estimated to take 2.0 hours to complete. Time will vary depending upon the needs of the individual case. Any comments on the amount of time you are required to complete this form should be sent to the Chief Information Officer, Patent and Trademark Office, Washington, DC 20231.

ALL REFERENCES CONSIDERED EXCEPT WHERE LINED THROUGH. /MA/

<b>INFORMATION DISCLOSURE STATEMENT BY APPLICANT</b> (Not for submission under 37 CFR 1.99)	Application Number	12211033
	Filing Date	2008-09-15
	First Named Inventor	Roger J. Quy
	Art Unit	3769
	Examiner Name	Michael C. Astorino
	Attorney Docket Number	00125/002005

FOREIGN PATENT DOCUMENTS								
Examiner Initials <sup>1</sup>	Cite No. <sup>2</sup>	Office <sup>3</sup>	Number <sup>4</sup>	Kind Code <sup>5</sup> (if known)	Name of Patentee or Applicant of Cited Document	Date of Publications of Cited document MM-DD-YYYY	Pages, Column, Lines, Where Relevant Passages or Relevant Figures Appear	T <sup>2</sup>
	CR		WO 97/28737		NOKIA MOBILE PHONES LTD	08/1997		
	CS		WO 98/24358		ENACT HEALTH MANAGEMENT SYSTEMS	06/1998		
	CT		WO 98/28909		INFORMEDIX, INC	09/1998		
	CU		WO 99/04687		OPTS, INC	02/1999		
	CV		WO 99/14882		GEORGIA TECH RESEARCH CORPORATION	03/1999		
	CW		WO 99/41682		SOUTHERN RESEARCH INSTITUTE	08/1999		
	CX		WO 99/44494		CARD GUARD SCIENTIFIC SURVIVAL LTD	09/1999		
	CY		WO 99/46718		HEALTHWARE CORPORATION	09/1999		
	CZ		WO 00/36900		FOURIE, Louise	06/2000		
	DA		WO 00/40145		CRITICARE SYSTEMS	07/2000		
	DB		WO 00/54205		AC PROPERTIES B.V.	09/2000		
	DC		WO 00/54206		AC PROPERTIES B.V.	09/2000		
	DD		WO 00/62662		CARDIOCOM	10/2000		
	DE		WO 01/24038		Imetrikus, Inc.	04/2001		

OTHER PRIOR ART—NON-PATENT LITERATURE DOCUMENTS			
Examiner Initials <sup>1</sup>	Cite No. <sup>2</sup>	Include name of the author (in CAPITAL LETTERS), title of the article (when appropriate), title of the item (book, magazine, journal, serial, symposium, catalog, etc.), date, page(s), volume-issue number(s), publisher, city and/or country where published.	T <sup>2</sup>
	DF	Jyrki Orskari ; "Bluetooth versus WLAN IEEE 802.11x" ; Helsinki University of Technology (Department of Computer Science and Engineering) November, 2000	
	DG	Jack Smith ; Your Personal Health Buddy; ABCNews.com; <a href="http://abcnews.go.com/sections/tech/CuttingEdge/cuttingedge990225.html">http://abcnews.go.com/sections/tech/CuttingEdge/cuttingedge990225.html</a> ; 3 pages (November 24, 2000)	
	DH	The Health Hero Communications Platform ; The Health Hero Network Online Services ; <a href="http://www.hhn.com/products/index.html">http://www.hhn.com/products/index.html</a> ; 2 pages (November 24, 2000)	

Examiner Signature	/Michael Astorino/	Date Considered	12/22/2009
--------------------	--------------------	-----------------	------------

<sup>1</sup>EXAMINER: Initial if reference considered, whether or not citation is in conformance with MPEP 609. Draw line through citation if not in conformance and not considered. Include copy of this form with next communication to applicant.  
<sup>2</sup>Unique citation designation number. <sup>3</sup>Applicant is to place a check mark here if English language Translation is attached.  
 Burden Hour Statement: This form is estimated to take 2.0 hours to complete. Time will vary depending upon the needs of the individual case. Any comments on the amount of time you are required to complete this form should be sent to the Chief Information Officer, Patent and Trademark Office, Washington, DC 20231.

ALL REFERENCES CONSIDERED EXCEPT WHERE LINED THROUGH. /MA/



<b>INFORMATION DISCLOSURE STATEMENT BY APPLICANT</b> ( Not for submission under 37 CFR 1.99)	Application Number		12211033	
	Filing Date		2008-09-15	
	First Named Inventor	Roger J. Quy		
	Art Unit	3769		
	Examiner Name	Michael C. Astorino		
	Attorney Docket Number	00125/002005		

Examiner Initials*	Cite No. <sup>1</sup>	U.S. Patent Document		Name of Patentee or Applicant of Cited Document	Issue Date MM-DD-YYYY
		Number	Class/Subclass		

Examiner Initials*	Cite No. <sup>1</sup>	U.S. Patent Publication		Name of Patentee or Applicant of Cited Document	Date of Publication of Cited Document MM-DD-YYYY
		Number	Class/Subclass		

Examiner Initials*	Cite No. <sup>1</sup>	Office <sup>2</sup>	Foreign Patent Document		Name of Patentee or Applicant of Cited Document	Date of Publication of Cited Document MM-DD-YYYY	T
			Number	Class/ Subclass			
	1.	JP	11259783 English Abstract Included	A61B5/00	Seiko Precision KK, et al.	09/24/1999	X
	2.	JP	11122369 English Abstract Included	H04Q7/38	NEC Saitama Ltd	04/30/1999	X
	3.	JP	11077101 English Abstract Included	A61B5/00	TOTO Ltd	02/23/1999	X
	4.	JP	9224917 English Abstract Included	G08C19/00	Yoshida Masao	09/02/1997	X
	5.	JP	2002/344660 A English Abstract only	A61 B5/00	Nec Fielding Ltd.	11-29-2002	X

OTHER PRIOR ART - NON PATENT LITERATURE DOCUMENTS				
Examiner Initials*	Cite No. <sup>1</sup>	Include name of the author (in CAPITAL LETTERS), title of the article (when appropriate), title of the item (book, magazine, journal, serial, symposium, catalog, etc.), date, page(s), volume-issue number(s), publisher, city and/or country where published.		T <sup>2</sup>
	1.	"Cell Phones Cameras Put Doctors in the Picture", February 21, 2005, 1 page, <a href="http://news.healingwell.com/index.php?p=news1&amp;id=524118">http://news.healingwell.com/index.php?p=news1&amp;id=524118</a>		

Examiner Signature	/Michael Astorino/	Date Considered	12/22/2009
--------------------	--------------------	-----------------	------------

\*EXAMINER: Initial if reference considered, whether or not citation is in conformance with MPEP 609. Draw line through citation if not in conformance and not considered. Include copy of this form with next communication to applicant.

<sup>12</sup>Unique citation designation number. <sup>2</sup>Applicant is to place a check mark here if English language Translation is attached.  
Burden Hour Statement: This form is estimated to take 2.0 hours to complete. Time will vary depending upon the needs of the individual case. Any comments on the amount of time you are required to complete this form should be sent to the Chief Information Officer, Patent and trademark Office, Washington, DC 20231. DO NOT SEND FEES OR COMPLETED FORMS TO THIS ADDRESS. SEND TO: Assistant Commissioner for Patents, Washington, DC 20231.

ALL REFERENCES CONSIDERED EXCEPT WHERE LINED THROUGH. /MA/

**INFORMATION DISCLOSURE  
STATEMENT BY APPLICANT**  
( Not for submission under 37 CFR 1.99)

Application Number	12211033
Filing Date	2008-09-15
First Named Inventor	Roger J. Quy
Art Unit	3769
Examiner Name	Michael C. Astorino
Attorney Docket Number	00125/002005

		OTHER PRIOR ART—NON-PATENT LITERATURE DOCUMENTS	
Examiner Initials	Cite No.	Include name of the author (in CAPITAL LETTERS), title of the article (when appropriate), title of the item (book, magazine, journal, serial, symposium, catalog, etc.), date, page(s), volume-issue number(s), publisher, city and/or country where published.	T <sup>2</sup>
	DI	Painless Blood-Glucose Monitoring ; Kumertrix Technology Overview ; <a href="http://www.kumertrix.com/technology.html">http://www.kumertrix.com/technology.html</a> ; 2 pages; November 24, 2000	
	DJ	Technology & Clinical Results-Simple Solutions Through Technology-Progression of Glucose Monitoring Technology ; Amira ; <a href="http://amira.com/tech/tc_tech.htm">http://amira.com/tech/tc_tech.htm</a> ; 2 pages; November 24, 2000	
	DK	Wired for Wellness ; LifeChart.com ; <a href="http://www.lifechart.com">http://www.lifechart.com</a> ; 2 pages ; November 24, 2000	
	DL	About Data Critical Corporation ; Yahoo—Data Critical to Provide Mallincrod with Wireless Connectivity for Ventilators ; <a href="http://biz.yahoo.com/pmews/001012/mo_mallinc.html">http://biz.yahoo.com/pmews/001012/mo_mallinc.html</a> ; 1 page; November 24, 2000	
	DM	Bluetooth wireless technology-bridging the gap between computing and communication; Bluetooth Technology; <a href="http://www.intel.com/mobile/bluetooth/">http://www.intel.com/mobile/bluetooth/</a> ; 2 pages; November 28, 2000	
	DN	Bluetooth resource center ; What is Bluetooth ?; palowireless.com; <a href="http://www.palowireless.com/infotooth/walis.asp">http://www.palowireless.com/infotooth/walis.asp</a> ; 3 pages; November 28, 2000	
	DO	Bluetooth Tutorial ; palowireless.com—bluetooth resource center ; <a href="http://www.palowireless.com/infotooth/tutorial.asp">http://www.palowireless.com/infotooth/tutorial.asp</a> ; 4 pages; November 28, 2000	
	DP	Bluetooth Profiles; palowireless.com—bluetooth resource center; <a href="http://www.palowireless.com/infotooth/tutorial/profiles.asp">http://www.palowireless.com/infotooth/tutorial/profiles.asp</a> ; 4 pages; November 28, 2000	
	DQ	Nick Hunt ; Bluetooth Venus 802.11 ; TDK Systems ; <a href="http://www.cellular.com.za/bluetooth_versus_802.htm">http://www.cellular.com.za/bluetooth_versus_802.htm</a> ; 4 pages; November 28, 2000	
	DR	Bluetooth vs. Airport (802.11 Network); palowireless.com—Bluetooth resource center; <a href="http://www.palowireless.com/infotooth/knowledge/othernetworks/15.asp">http://www.palowireless.com/infotooth/knowledge/othernetworks/15.asp</a> ; 3 pages; November 28, 2000	
	DS	Personal Digital Assistants; A2 Anytime/Anywhere—A Weekly on Wireless Infrastructure and Data Services; Thomas Weisel Partners (Merchant Banking); 5 pages; November 29, 2000	
	DT	Ashlee Vance; Ericsson and Intel Make Bluetooth Pact; InfoWorld.com; <a href="http://www.infoworld.com/articles/hn/xml/00/12/04/001204hnericintel.xml?T.../printarticle.htm">http://www.infoworld.com/articles/hn/xml/00/12/04/001204hnericintel.xml?T.../printarticle.htm</a> ; 1 page; December 4, 2000	

Examiner Signature	/Michael Astorino/	Date Considered	12/22/2009
--------------------	--------------------	-----------------	------------

AMINER: Initial if reference considered, whether or not citation is in conformance with MPEP 609. Draw line through citation if not in conformance and not considered. Include copy of this form with next communication to applicant.  
 Unique citation designation number. <sup>2</sup> Applicant is to place a check mark here if English language Translation is attached.  
 Ten Hour Statement: This form is estimated to take 2.0 hours to complete. Time will vary depending upon the needs of the individual case. Any comments on amount of time you are required to complete this form should be sent to the Chief Information Officer, Patent and Trademark Office, Washington, DC 20231.  
 NOT SEND FEES OR COMPLETED FORMS TO THIS ADDRESS. SEND TO: Assistant Commissioner for Patents, Washington, DC 20231.

ALL REFERENCES CONSIDERED EXCEPT WHERE LINED THROUGH. /MA/

<b>INFORMATION DISCLOSURE STATEMENT BY APPLICANT</b> ( Not for submission under 37 CFR 1.99)	Application Number	12211033
	Filing Date	2008-09-15
	First Named Inventor	Roger J. Quy
	Art Unit	3769
	Examiner Name	Michael C. Astorino
	Attorney Docket Number	00125/002005

Examiner Initials <sup>1</sup>	Cite No. <sup>1</sup>	OTHER PRIOR ART—NON-PATENT LITERATURE DOCUMENTS	2
	DU	Personal Portable Office; Nokia 9000ii digital; <a href="http://www.nokiausa.com/9000ii">http://www.nokiausa.com/9000ii</a> ; 4 pages; December 7, 2000	
	DV	Pui-Wing Tam; Handspring Homes; Article from the Wall Street Journal; Section B; November 2000	
	DW	Author unknown; Articles on Phones and New Technologies; Article from the Wall Street Journal; November 2000	
	DX	David Pringle; Sagen to Launch Hand-held Computer that Doubles as Top-End Mobile Phone; Article from the Wall Street Journal; November 2000	
	DY	Svensson, Peter; "Cisco Launches WiFi Phone" Article from Australian IT; April 29, 2003	
	DZ	"Breakthrough Devices Shown At ADA" published in Diabetes News for July 1, 2001 at <a href="http://www.diabetesnet.com/news/news070101.php">http://www.diabetesnet.com/news/news070101.php</a>	
	EA	"iMetrikus" published at <a href="http://www.qualcomm.com/qwbs/resource/resourcelib_casestdy.shtml">http://www.qualcomm.com/qwbs/resource/resourcelib_casestdy.shtml</a>	
	EB	"Applications of MedStar" published on April 27, 2003 by Cybernet Medical, 16 pages	
	EC	"HIPAA & WiFi: Regulatory Tangles for Wireless Health Care Networks Analyzed" published at <a href="http://www.hipaadvisory.com/tech/wireless.htm">http://www.hipaadvisory.com/tech/wireless.htm</a>	
	ED	"Medtronic CareLink Network, How it Works" published at <a href="http://www.medtronic.com/carelink/features.html">http://www.medtronic.com/carelink/features.html</a>	
	EE	"FDA Approves Medtronic CareLink™ Monitor and Software, Opening a New Chapter in Patient Management Using Internet Technology", Medtronic News Release dated 01/02/02	
	EF	"The MedStar System, How the MedStar System Works" brochure published by Cybernet Medical.	

Examiner Signature	/Michael Astorino/	Date Considered	12/22/2009
--------------------	--------------------	-----------------	------------

<sup>1</sup>AMINER: Initial if reference considered, whether or not citation is in conformance with MPEP 609. Draw line through citation if not in conformance and not considered. Include copy of this form with next communication to applicant.  
<sup>2</sup>Include citation designation number. <sup>3</sup>Applicant is to place a check mark here if English language Translation is attached.  
 400 Hour Statement: This form is estimated to take 2.0 hours to complete. Time will vary depending upon the needs of the individual case. Any comments on amount of time you are required to complete this form should be sent to the Chief Information Officer, Patent and Trademark Office, Washington, DC 20231

ALL REFERENCES CONSIDERED EXCEPT WHERE LINED THROUGH. /MA/

<b>INFORMATION DISCLOSURE STATEMENT BY APPLICANT</b> ( Not for submission under 37 CFR 1.99)	Application Number		12211033
	Filing Date		2008-09-15
	First Named Inventor	Roger J. Quy	
	Art Unit	3769	
	Examiner Name	Michael C. Astorino	
	Attorney Docket Number	00125/002005	

OTHER PRIOR ART—NON-PATENT LITERATURE DOCUMENTS			
Examiner Initials <sup>*</sup>	Cite No. <sup>1</sup>	Include name of the author (In CAPITAL LETTERS), title of the article (when appropriate), title of the item (book, magazine, journal, serial, symposium, catalog, etc.), date, page(s), volume-issue number(s), publisher, city and/or country where published.	T <sup>2</sup>
	EG	"iMetrikus Mobile Solutions" brochure by iMetrikus, Inc.	
	EH	"Instromedix - Products" published at <a href="http://www.instromedix.com/pages/products/products.asp">www.instromedix.com/pages/products/products.asp</a> . 7 Pages	

Examiner Signature	/Michael Astorino/	Date Considered	12/22/2009
--------------------	--------------------	-----------------	------------

\*EXAMINER: Initial if reference considered, whether or not citation is in conformance with MPEP 609. Draw line through citation if not in conformance and not considered. Include copy of this form with next communication to applicant.

<sup>1</sup>Unique citation designation number. <sup>2</sup>Applicant is to place a check mark here if English language Translation is attached.

Burden Hour Statement: This form is estimated to take 2.0 hours to complete. Time will vary depending upon the needs of the individual case. Any comments on

ALL REFERENCES CONSIDERED EXCEPT WHERE LINED THROUGH. /MA/

<b>INFORMATION DISCLOSURE STATEMENT BY APPLICANT</b> ( Not for submission under 37 CFR 1.99)	Application Number	12211033
	Filing Date	2008-09-15
	First Named Inventor	Roger J. Quy
	Art Unit	3769
	Examiner Name	Michael C. Astorino
	Attorney Docket Number	00125/002005

OTHER PRIOR ART - NON PATENT LITERATURE DOCUMENTS			
Examiner Initials <sup>2</sup>	Cite No. <sup>1</sup>	Include name of the author (in CAPITAL LETTERS), title of the article (when appropriate), title of the item (book, magazine, journal, serial, symposium, catalog, etc.), date, page(s), volume-issue number(s), publisher, city and/or country where published.	T <sup>3</sup>
	1	<del>EFI Framework Draft Version 0.8 (03-June-2000); External Functionality Interface Framework, pp. 1-35.</del>	
	2.	<del>Internet Press Release: New York Business Wire (Sept. 25, 2000); MedSearch Technologies, Inc. Develops a Revolutionary Home-Care Wireless Technology Utilizing PSA's-Personal Organizers-as Patient Monitors</del>	

Examiner Signature	/Michael Astorino/	Date Considered	12/22/2009
--------------------	--------------------	-----------------	------------

EXAMINER: Initial if reference considered, whether or not citation is in conformance with MPEP 609. Draw line through citation, if not in conformance and not considered. Include copy of this form with next communication to applicant.

<sup>1</sup> Unique citation designation number. <sup>2</sup> Enter Office that issued the document, by the two-letter code (WIPO Standard ST.3). <sup>3</sup> For Japanese patent documents, the indication of the year of the reign of the Emperor must precede the serial number of the patent document. <sup>4</sup> Kind of document by the appropriate symbols as indicated on the document under WIPO Standard ST. 16 if possible. <sup>5</sup> Applicant is to place a check mark here if English Language Translation is attached.

ALL REFERENCES CONSIDERED EXCEPT WHERE LINED THROUGH. /MA/

<b>INFORMATION DISCLOSURE STATEMENT BY APPLICANT</b> ( Not for submission under 37 CFR 1.99)	Application Number		12211033
	Filing Date		2008-09-15
	First Named Inventor	Roger J. Quy	
	Art Unit	3769	
	Examiner Name	Michael C. Astorino	
	Attorney Docket Number	00125/002005	

If you wish to add additional Foreign Patent Document citation information please click the Add button

**NON-PATENT LITERATURE DOCUMENTS**

Examiner Initials*	Cite No	Include name of the author (in CAPITAL LETTERS), title of the article (when appropriate), title of the item (book, magazine, journal, serial, symposium, catalog, etc), date, pages(s), volume-issue number(s), publisher, city and/or country where published.	T <sup>5</sup>
	1	<del>JOSEPH FINKELSTEIN, et al., "Web-Based Monitoring of Asthma Severity: A New Approach to Ambulatory Management". Proc. 1998 IEEE Int'l Conf. on Info Tech. Applications in Biomedicine, 1998, pp. 139-143.</del>	<input type="checkbox"/>

If you wish to add additional non-patent literature document citation information please click the Add button

**EXAMINER SIGNATURE**

Examiner Signature	/Michael Astorino/	Date Considered	12/22/2009
--------------------	--------------------	-----------------	------------

\*EXAMINER: Initial if reference considered, whether or not citation is in conformance with MPEP 609. Draw line through a citation if not in conformance and not considered. Include copy of this form with next communication to applicant.

<sup>1</sup> See Kind Codes of USPTO Patent Documents at [www.USPTO.GOV](http://www.USPTO.GOV) or MPEP 901.04. <sup>2</sup> Enter office that issued the document, by the two-letter code (WIPO Standard ST.3). <sup>3</sup> For Japanese patent documents, the indication of the year of the reign of the Emperor must precede the serial number of the patent document. <sup>4</sup> Kind of document by the appropriate symbols as indicated on the document under WIPO Standard ST.16 if possible. <sup>5</sup> Applicant is to place a check mark here if English language translation is attached.

Receipt date: 05/11/2009

12211033 - GAU: 3769

<b>INFORMATION DISCLOSURE STATEMENT BY APPLICANT</b> ( Not for submission under 37 CFR 1.99)	Application Number		12211033
	Filing Date		2008-09-15
	First Named Inventor	Roger J. Quy	
	Art Unit		3769
	Examiner Name	Michael C. Astorino	
	Attorney Docket Number		00125/002005

	2.	YAN XIAO, PhD. et al., "Design and Evaluation of a Real-Time Mobile Telemedicine System for Ambulance Transport", <i>Proceedings of the 1998 American Medical Informatics Association Annual Fall Symposium</i> , 1998, pp. 1102-1103.	
	3.	YAN XIAO, PhD. et al., "Design and Evaluation of a Real-Time Mobile Telemedicine System for Ambulance Transport", <i>The Journal of High Speed Networks</i> , 2000, vol. 9 (1), pp. 47-56.	

Examiner Signature	/Michael Astorino/	Date Considered	12/22/2009
--------------------	--------------------	-----------------	------------

\*EXAMINER: Initial if reference considered, whether or not citation is in conformance with MPEP 609. Draw line through citation if not in conformance and not considered. Include copy of this form with next communication to applicant.

<sup>12</sup>Unique citation designation number. <sup>2</sup>Applicant is to place a check mark here if English language Translation is attached.

Burden Hour Statement: This form is estimated to take 2.0 hours to complete. Time will vary depending upon the needs of the individual case. Any comments on the amount of time you are required to complete this form should be sent to the Chief Information Officer, Patent and Trademark Office, Washington, DC 20231. DO NOT SEND FEES OR COMPLETED FORMS TO THIS ADDRESS. SEND TO: Assistant Commissioner for Patents, Washington, DC 20231.

ALL REFERENCES CONSIDERED EXCEPT WHERE LINED THROUGH. /MA/

Receipt date: 05/11/2009

12211033 - GAU: 3769

<b>INFORMATION DISCLOSURE STATEMENT BY APPLICANT</b> (Not for submission under 37 CFR 1.99)	Application Number	12211033
	Filing Date	2008-09-15
	First Named Inventor	Roger J. Quy
	Art Unit	3769
	Examiner Name	Michael C. Astorino
	Attorney Docket Number	00125/002005

OTHER PRIOR ART - NON PATENT LITERATURE DOCUMENTS			
Examiner Initials <sup>6</sup>	Cite No. <sup>1</sup>	Include name of the author (in CAPITAL LETTERS), title of the article (when appropriate), title of the item (book, magazine, journal, serial, symposium, catalog, etc.), date, page(s), volume-issue number(s), publisher, city and/or country where published.	T <sup>2</sup>
	1	<del>EFI Framework Draft Version 0.8 (03-June-2000); External Functionality Interface Framework, pp. 1-35.</del>	
	2.	<del>Internet Press Release: New York Business Wire (Sept. 25, 2000); MedSearch Technologies, Inc. Develops a Revolutionary Home-Care Wireless Technology Utilizing PSA's-Personal Organizers-as Patient Monitors</del>	

Examiner Signature	/Michael Astorino/	Date Considered	12/22/2009
--------------------	--------------------	-----------------	------------

EXAMINER: Initial if reference considered, whether or not citation is in conformance with MPEP 609. Draw line through citation, if not in conformance and not considered. Include copy of this form with next communication to applicant.

<sup>1</sup> Unique citation designation number. <sup>2</sup> Enter Office that issued the document, by the two-letter code (WIPO Standard ST.3). <sup>3</sup> For Japanese patent documents, the indication of the year of the reign of the Emperor must precede the serial number of the patent document. <sup>4</sup> Kind of document by the appropriate symbols as indicated on the document under WIPO Standard ST. 16 if possible. <sup>5</sup> Applicant is to place a check mark here if English Language Translation is attached.

ALL REFERENCES CONSIDERED EXCEPT WHERE LINED THROUGH. /MA/



<b>INFORMATION DISCLOSURE STATEMENT BY APPLICANT</b> ( Not for submission under 37 CFR 1.99)	Application Number		12211033	
	Filing Date		2008-09-15	
	First Named Inventor	Roger Quy		
	Art Unit	3769		
	Examiner Name	Michael C. Astorino		
	Attorney Docket Number	00125/002005		

U.S.PATENTS						
Examiner Initial*	Cite No	Patent Number	Kind Code <sup>1</sup>	Issue Date	Name of Patentee or Applicant of cited Document	Pages,Columns,Lines where Relevant Passages or Relevant Figures Appear
	1	6790178	B1	2004-09-14	Mault et al.	

If you wish to add additional U.S. Patent citation information please click the Add button.

U.S.PATENT APPLICATION PUBLICATIONS						
Examiner Initial*	Cite No	Publication Number	Kind Code <sup>1</sup>	Publication Date	Name of Patentee or Applicant of cited Document	Pages,Columns,Lines where Relevant Passages or Relevant Figures Appear
	1					

If you wish to add additional U.S. Published Application citation information please click the Add button.

FOREIGN PATENT DOCUMENTS								
Examiner Initial*	Cite No	Foreign Document Number <sup>3</sup>	Country Code <sup>2</sup>	Kind Code <sup>4</sup>	Publication Date	Name of Patentee or Applicant of cited Document	Pages,Columns,Lines where Relevant Passages or Relevant Figures Appear	T <sup>5</sup>
	1							<input type="checkbox"/>

If you wish to add additional Foreign Patent Document citation information please click the Add button

NON-PATENT LITERATURE DOCUMENTS			
Examiner Initials*	Cite No	Include name of the author (in CAPITAL LETTERS), title of the article (when appropriate), title of the item (book, magazine, journal, serial, symposium, catalog, etc), date, pages(s), volume-issue number(s), publisher, city and/or country where published.	T <sup>5</sup>

Receipt date: 08/04/2009  <b>INFORMATION DISCLOSURE STATEMENT BY APPLICANT</b> ( Not for submission under 37 CFR 1.99)	Application Number		12211033	12211033 - GAU: 3769	
	Filing Date		2008-09-15		
	First Named Inventor		Roger Quy		
	Art Unit		3769		
	Examiner Name		Michael C. Astorino		
	Attorney Docket Number		00125/002005		

	1		<input type="checkbox"/>
--	---	--	--------------------------

If you wish to add additional non-patent literature document citation information please click the Add button

**EXAMINER SIGNATURE**

Examiner Signature	/Michael Astorino/	Date Considered	12/22/2009
--------------------	--------------------	-----------------	------------

\*EXAMINER: Initial if reference considered, whether or not citation is in conformance with MPEP 609. Draw line through a citation if not in conformance and not considered. Include copy of this form with next communication to applicant.

<sup>1</sup> See Kind Codes of USPTO Patent Documents at [www.USPTO.GOV](http://www.USPTO.GOV) or MPEP 901.04. <sup>2</sup> Enter office that issued the document, by the two-letter code (WIPO Standard ST.3). <sup>3</sup> For Japanese patent documents, the indication of the year of the reign of the Emperor must precede the serial number of the patent document. <sup>4</sup> Kind of document by the appropriate symbols as indicated on the document under WIPO Standard ST.16 if possible. <sup>5</sup> Applicant is to place a check mark here if English language translation is attached.

## EAST Search History

## EAST Search History (Prior Art)

Ref #	Hits	Search Query	DBs	Default Operator	Plurals	Time Stamp
L1	143	"20020016719"   "20020019584"   "20020026223"   "20020072785"   "20020082480"   "20020120310"   "20030004554"   "20030072424"   "20030139785"   "20030204413"   "4282883"   "5012814"   "5307263"   "5357427"   "5434611"   "5441047"   "5544649"   "5544661"   "5549117"   "5553609"   "5576952"   "5601435"   "5626144"   "5678562"   "5701904"   "5704366"   "5724025"   "5732709"   "5735285"   "5752917"   "5772586"   "5791342"   "5931791"   "5933136"   "5935060"   "5941829"   "5951300"   "5959533"   "5964701"   "5967975"   "5987352"   "5987519"   "5997476"   "6022315"   "6024699"	US-PGPUB; USPAT; JPO; DERWENT	OR	ON	2009/12/22 11:39

"6050940" |  
"6055506" |  
"6057758" |  
"6059692" |  
"6083156" |  
"6093146" |  
"6101478" |  
"6144837" |  
"6160478" |  
"6168563" |  
"6190324" |  
"6264739" |  
"6266645" |  
"6319199" |  
"6336900" |  
"6375614" |  
"6386882" |  
"6416471" |  
"6418346" |  
"6440068" |  
"6450955" |  
"6458080" |  
"6478736" |  
"6529771" |  
"6602191" |  
"6610012" |  
"6790178" |  
"6856832" |  
"6936007" |  
"6976958").PN.

12/ 22/ 09 11:49:47 AM



UNITED STATES PATENT AND TRADEMARK OFFICE

UNITED STATES DEPARTMENT OF COMMERCE  
 United States Patent and Trademark Office  
 Address: COMMISSIONER FOR PATENTS  
 P.O. Box 1450  
 Alexandria, Virginia 22313-1450  
 www.uspto.gov

APPLICATION NO.	FILING DATE	FIRST NAMED INVENTOR	ATTORNEY DOCKET NO.	CONFIRMATION NO.
12/211,033	09/15/2008	Roger J. Quy	00125/002005	7693
2774	7590	03/10/2010	EXAMINER ASTORINO, MICHAEL C	
MAYER & WILLIAMS PC 251 NORTH AVENUE WEST 2ND FLOOR WESTFIELD, NJ 07090			ART UNIT	PAPER NUMBER
			3769	
			MAIL DATE	DELIVERY MODE
			03/10/2010	PAPER

**Please find below and/or attached an Office communication concerning this application or proceeding.**

The time period for reply, if any, is set in the attached communication.

<b>Interview Summary</b>	<b>Application No.</b> 12/211,033	<b>Applicant(s)</b> QUY, ROGER J.	
	<b>Examiner</b> Michael C. Astorino	<b>Art Unit</b> 3769	

All participants (applicant, applicant's representative, PTO personnel):

- (1) Michael C. Astorino. (3)\_\_\_\_\_.
- (2) Mark Wieczorek. (4)\_\_\_\_\_.

Date of Interview: 08 March 2010.

Type: a)  Telephonic b)  Video Conference  
 c)  Personal [copy given to: 1)  applicant 2)  applicant's representative]

Exhibit shown or demonstration conducted: d)  Yes e)  No.  
 If Yes, brief description: \_\_\_\_\_.

Claim(s) discussed: pending claims.

Identification of prior art discussed: applied prior art.

Agreement with respect to the claims f)  was reached. g)  was not reached. h)  N/A.

Substance of Interview including description of the general nature of what was agreed to if an agreement was reached, or any other comments: Participants discussed the previous office action including the IDS, 35 U.S.C. § 101, 35 U.S.C. § 112, 35 U.S.C. § 102, and double patenting rejections. The examiner provided suggestions to obviate the rejections and overcome the applied prior art.

(A fuller description, if necessary, and a copy of the amendments which the examiner agreed would render the claims allowable, if available, must be attached. Also, where no copy of the amendments that would render the claims allowable is available, a summary thereof must be attached.)

THE FORMAL WRITTEN REPLY TO THE LAST OFFICE ACTION MUST INCLUDE THE SUBSTANCE OF THE INTERVIEW. (See MPEP Section 713.04). If a reply to the last Office action has already been filed, APPLICANT IS GIVEN A NON-EXTENDABLE PERIOD OF THE LONGER OF ONE MONTH OR THIRTY DAYS FROM THIS INTERVIEW DATE, OR THE MAILING DATE OF THIS INTERVIEW SUMMARY FORM, WHICHEVER IS LATER, TO FILE A STATEMENT OF THE SUBSTANCE OF THE INTERVIEW. See Summary of Record of Interview requirements on reverse side or on attached sheet.

/Michael C. Astorino/ Primary Examiner, Art Unit 3769	571-272-4723
--	--------------

**Manual of Patent Examining Procedure (MPEP), Section 713.04, Substance of Interview Must be Made of Record**

A complete written statement as to the substance of any face-to-face, video conference, or telephone interview with regard to an application must be made of record in the application whether or not an agreement with the examiner was reached at the interview.

**Title 37 Code of Federal Regulations (CFR) § 1.133 Interviews**  
Paragraph (b)

In every instance where reconsideration is requested in view of an interview with an examiner, a complete written statement of the reasons presented at the interview as warranting favorable action must be filed by the applicant. An interview does not remove the necessity for reply to Office action as specified in §§ 1.111, 1.135. (35 U.S.C. 132)

37 CFR §1.2 Business to be transacted in writing.

All business with the Patent or Trademark Office should be transacted in writing. The personal attendance of applicants or their attorneys or agents at the Patent and Trademark Office is unnecessary. The action of the Patent and Trademark Office will be based exclusively on the written record in the Office. No attention will be paid to any alleged oral promise, stipulation, or understanding in relation to which there is disagreement or doubt.

The action of the Patent and Trademark Office cannot be based exclusively on the written record in the Office if that record is itself incomplete through the failure to record the substance of interviews.

It is the responsibility of the applicant or the attorney or agent to make the substance of an interview of record in the application file, unless the examiner indicates he or she will do so. It is the examiner's responsibility to see that such a record is made and to correct material inaccuracies which bear directly on the question of patentability.

Examiners must complete an Interview Summary Form for each interview held where a matter of substance has been discussed during the interview by checking the appropriate boxes and filling in the blanks. Discussions regarding only procedural matters, directed solely to restriction requirements for which interview recordation is otherwise provided for in Section 812.01 of the Manual of Patent Examining Procedure, or pointing out typographical errors or unreadable script in Office actions or the like, are excluded from the interview recordation procedures below. Where the substance of an interview is completely recorded in an Examiners Amendment, no separate Interview Summary Record is required.

The Interview Summary Form shall be given an appropriate Paper No., placed in the right hand portion of the file, and listed on the "Contents" section of the file wrapper. In a personal interview, a duplicate of the Form is given to the applicant (or attorney or agent) at the conclusion of the interview. In the case of a telephone or video-conference interview, the copy is mailed to the applicant's correspondence address either with or prior to the next official communication. If additional correspondence from the examiner is not likely before an allowance or if other circumstances dictate, the Form should be mailed promptly after the interview rather than with the next official communication.

The Form provides for recordation of the following information:

- Application Number (Series Code and Serial Number)
- Name of applicant
- Name of examiner
- Date of interview
- Type of interview (telephonic, video-conference, or personal)
- Name of participant(s) (applicant, attorney or agent, examiner, other PTO personnel, etc.)
- An indication whether or not an exhibit was shown or a demonstration conducted
- An identification of the specific prior art discussed
- An indication whether an agreement was reached and if so, a description of the general nature of the agreement (may be by attachment of a copy of amendments or claims agreed as being allowable). Note: Agreement as to allowability is tentative and does not restrict further action by the examiner to the contrary.
- The signature of the examiner who conducted the interview (if Form is not an attachment to a signed Office action)

It is desirable that the examiner orally remind the applicant of his or her obligation to record the substance of the interview of each case. It should be noted, however, that the Interview Summary Form will not normally be considered a complete and proper recordation of the interview unless it includes, or is supplemented by the applicant or the examiner to include, all of the applicable items required below concerning the substance of the interview.

A complete and proper recordation of the substance of any interview should include at least the following applicable items:

- 1) A brief description of the nature of any exhibit shown or any demonstration conducted,
- 2) an identification of the claims discussed,
- 3) an identification of the specific prior art discussed,
- 4) an identification of the principal proposed amendments of a substantive nature discussed, unless these are already described on the Interview Summary Form completed by the Examiner,
- 5) a brief identification of the general thrust of the principal arguments presented to the examiner,  
(The identification of arguments need not be lengthy or elaborate. A verbatim or highly detailed description of the arguments is not required. The identification of the arguments is sufficient if the general nature or thrust of the principal arguments made to the examiner can be understood in the context of the application file. Of course, the applicant may desire to emphasize and fully describe those arguments which he or she feels were or might be persuasive to the examiner.)
- 6) a general indication of any other pertinent matters discussed, and
- 7) if appropriate, the general results or outcome of the interview unless already described in the Interview Summary Form completed by the examiner.

Examiners are expected to carefully review the applicant's record of the substance of an interview. If the record is not complete and accurate, the examiner will give the applicant an extendable one month time period to correct the record.

**Examiner to Check for Accuracy**

If the claims are allowable for other reasons of record, the examiner should send a letter setting forth the examiner's version of the statement attributed to him or her. If the record is complete and accurate, the examiner should place the indication, "Interview Record OK" on the paper recording the substance of the interview along with the date and the examiner's initials.

Serial No.: 12/211,033

**IN THE UNITED STATES PATENT AND TRADEMARK OFFICE**

Applicant: Roger J. Quy

Serial No.: 12/211,033

Filed: 09/15/2008

Title: METHOD AND APPARATUS FOR HEALTH AND DISEASE  
MANAGEMENT COMBINING PATIENT DATA MONITORING WITH  
WIRELESS INTERNET CONNECTIVITY

Art Unit: 3769

Examiner: Michael C. Astorino

Confirmation No.: 7693

Docket No.: 00125/002005

**Via EFS Web**

Mail Stop Amendment  
Commissioner for Patents  
P.O. Box 1450  
Alexandria, VA 22313-1450

**AMENDMENT AND RESPONSE TO OFFICE ACTION**

Sir:

In response to the Office Action mailed December 29, 2009, kindly amend the above-identified application as follows:

**Certificate of Electronic Filing Under  
37 C.F.R. §1.8**

I certify that this correspondence and any document reference herein is being electronically deposited with the USPTO via EFS-Web on March 16, 2010.

Michelle Wolf  
(Printed Name of Person Mailing Correspondence)

/michelle wolf/  
(Signature)



Serial No.: 12/211,033

**Amendments to the Claims:**

1. (Currently Amended) A method for interactive exercise monitoring, the method comprising the steps of:
  - a. coupling a web-enabled wireless phone to a device which provides exercise-related information;
  - b. rendering a user interface on the web-enabled wireless phone;
  - c. receiving data ~~exercise-related information in the web-enabled wireless phone, wherein the exercise-related information includes~~ indicating a physiologic data status of a subject;
  - d. receiving and data ~~data~~ indicating an amount of exercise performed by the subject; and
  - e. wherein at least one of the data ~~physiological data and the data indicating a physiologic status of a subject or the data indicating~~ an amount of exercise performed by the subject is received from the device which provides exercise-related information, and wherein the data indicating a physiologic status of a subject is received at least partially while the subject is exercising;
  - f. sending the exercise-related information to an internet server via a wireless network;
  - g. receiving a calculated response from ~~a~~ the server, the response associated with a calculation performed by the server based on the exercise-related information; and
  - h. running an application in the web-enabled wireless phone for receiving the exercise-related information and displaying the response.
  
2. (Currently Amended) The method of claim 1, wherein the receiving data indicating a physiologic status of a subject ~~exercise-related information including physiological data~~ includes receiving data from a physiological sensor coupled to monitoring device ~~or from an exercise machine~~.
  
3. (Currently Amended) The method of claim 1, where the receiving ~~exercise-related information including~~ data indicating an amount of exercise performed by the subject includes receiving data from an exercise machine ~~or from a physiological monitoring device~~.

Serial No.: 12/211,033

4. (Previously Presented) The method of claim 1, wherein the web-enabled wireless phone receives exercise-related information over a transmission medium, the transmission medium including a wired connection or a wireless connection.

5. (Canceled)

6. (Original) The method of claim 1, wherein the web-enabled wireless phone receives data via an adapter to convert a signal from the device to a suitable input for the wireless phone.

7. (Currently Amended) The method of claim 1, wherein the data indicating an amount of exercise performed is received from a device ~~which provides exercise-related information is selected from the group consisting of: an electronic body weight scale, a body fat gauge, a pedometer, a biofeedback device, a treadmill, a stepper, an exercise cycle, an accelerometer, a rowing machine, physiotherapy equipment, an aerobic or anaerobic exercise device, a temperature monitor, a heart rate monitor, a blood pressure monitor, a respiratory monitor, and a device that monitors an amount of work or rate of work performed.~~

8. (Currently Amended) A computer-readable medium, containing an application instructions ~~instructions~~ for performing an interactive method of exercise monitoring, the application physically residing on a server, the method comprising the steps of:

- a. receiving exercise-related information from a web-enabled wireless phone, wherein the exercise-related information includes data indicating a physiological data status of a subject and data data indicating an amount of exercise performed by the subject, and wherein the data indicating a physiologic status of a subject is received at least partially while the subject is exercising;
- b. calculating a response based on the exercise-related information;
- c. transmitting the calculated response to the web-enabled wireless phone.

9. (Currently Amended) The medium of claim 8, wherein the method further comprises:

- a. enabling the web-enabled wireless phone to receive exercise-related information from a device; and
- b. transmitting to the web-enabled wireless phone ~~a~~ device application including a user interface on which the calculated response may be rendered.

Serial No.: 12/211,033

10. (Previously Presented) The medium of claim 8, wherein the calculating a response includes calculating a response to assist a person in monitoring calorie expenditure, losing weight, or maintaining a healthy lifestyle.

11. (Previously Presented) The medium of claim 8, wherein the instructions further cause the web-enabled wireless phone to receive the exercise-related information via an adapter, the adapter to convert a received data signal to a suitable input for the web-enabled wireless phone.

12. (Currently Amended) The medium of claim 8, wherein the data indicating an amount of exercise performed by the subject ~~exercise-related information~~ is received from a ~~physiological monitoring~~ device which is selected from the group consisting of: ~~an electronic body weight scale, a body fat gauge, a pedometer, a biofeedback device, a treadmill, a stepper, an exercise cycle, an accelerometer, a rowing machine, physiotherapy equipment, an aerobic or anaerobic exercise device, a temperature monitor, a heart rate monitor, a blood pressure monitor, a respiratory monitor,~~ and a device that monitors an amount of work or rate of work performed.

13. (Previously Presented) The medium of claim 8, wherein the receiving exercise-related information includes receiving exercise-related information over a wireless or a wired connection.

14. (Currently Amended) A web-enabled wireless phone, containing a computer-readable medium, the computer-readable medium comprising memory within a web-enabled wireless phone, the computer-readable medium comprising instructions for causing a processor in the web-enabled wireless phone to perform the method of claim 1.

15. (Currently Amended) A computer-readable medium-, the computer-readable medium comprising memory within a web-enabled wireless phone, the computer-readable medium containing instructions for causing a processor in a web-enabled wireless phone to perform the method of claim 1.

16. (Previously Presented) The method of claim 1, further comprising downloading the application to the web-enabled wireless phone from a server.

Serial No.: 12/211,033

17. (Currently Amended) The method of claim 4, wherein the wireless connection includes an infrared connection or a radio frequency communication protocol including a short-range wireless transmission scheme Bluetooth® or 802.11.

18. (Previously Presented) The method of claim 4, wherein the wired connection includes a USB connection, a cable, or a docking station.

19. (New) The method of claim 17, wherein the short-range wireless transmission scheme includes 802.11 or 802.15.

20. (New) The method of claim 1, wherein the data indicating a physiologic status of a subject is received from a device selected from the group consisting of: a heart rate monitor, a blood pressure monitor, a body temperature monitor, a respiratory monitor, a biofeedback device, an electronic body weight scale, and a body fat gauge.

21. (New) The medium of claim 8, wherein the data indicating a physiologic status of a subject is received from a device which is selected from the group consisting of: a heart rate monitor, a blood pressure monitor, a body temperature monitor, a respiratory monitor, a biofeedback device, an electronic body weight scale, and a body fat gauge.

Serial No.: 12/211,033

### **REMARKS**

Claims 1-18 were pending in this application. Claims 1-3, 7-9, 12, 14, 15, and 17 have been amended, claim 5 has been cancelled, and claims 19-21 have been added. Support for these amendments is described below. Reconsideration and allowance of all pending claims are respectfully requested.

#### **Interview**

Applicant would first like to thank the Examiner for the courtesy of an interview conducted March 8, 2010. The amendments to the claims were discussed, particularly the distinction between physiologic data and data indicating an amount of exercise performed, and the Examiner noted that Applicant's suggested claim amendments would further clarify what Applicant regards as the invention, obviating the definiteness rejections. The corresponding amendments are found in the independent claims, as well as in dependent claims 7 and 12. Dependent claim 17 was also discussed, and an amendment has been made (and new claim 19 added) to address the rejection. In the discussion of the prior art, Applicant noted how Brown failed to disclose a system and method where data indicating a physiologic status of a subject is received while the subject is exercising, and the Examiner indicated that this would likely be a patentable distinction, and that the same would also likely overcome the double-patenting rejection. The Examiner noted the importance for such amendments that the same be supported by the original disclosure. Additional specific discussions are referenced in the remarks below.

Applicant has made the claim amendments noted, and further pointed out where the same are based on the original disclosure. Consequently, Applicant submits that all the claims are currently in condition for allowance.

#### **Objection to the Information Disclosure Statement**

In the current Office Action, the Examiner states that the information disclosure statement filed May 11, 2009 fails to comply with 37 CFR 1.98(a)(2), which requires a legible copy of each cited foreign patent document; each non-patent literature publication or that portion which caused it to be listed; and all other information or that portion which caused it to be listed. It has been placed in the application file, but the information referred to therein has not been considered.

Serial No.: 12/211,033

The Examiner's direction is brought to the transmittal letter which was filed along with the Information Disclosure Statement on May 11, 2009 wherein Applicant noted that all of the references cited therein (for which a copy was not provided) were filed in one of the following four parent applications: *11/649,703, 10/418,845, 09/738,270, 11/184,274*. For this reason, copies of the non-US and NPL references were not required. The Examiner is therefore requested to consider the Information Disclosure Statement filed May 11, 2009.

**Objection due to informalities**

Claim 15 is objected to because in line 1 there is an extra space between "medium" and the comma. The examiner suggestion removing the extra character space from the claim to read, e.g. "medium,". This informality has been obviated by amendment.

**Rejection under 35 U.S.C. 101**

Claims 8-15 are rejected under 35 U.S.C. 101 because the claims recite a computer readable medium, and the phrase "computer readable medium" was allegedly never explicitly defined in the specification. This subject was discussed in the interview, and the Examiner noted the letter issued by the Director on January 26, 2010, regarding "Subject Matter Eligibility of Computer-Readable Media". Applicant has amended the claims to more specifically recite and define the claimed computer-readable media. These amendments find support in the originally-filed specification as follows. The amendment to claim 8 finds support at, at least, paragraphs [0026] and [0062], which discusses a software program physically resident on a server. The amendments to claims 14 and 15 find support at, at least, paragraph [0025], which discusses the use of memory for storage of applications within a wireless web device.

**Rejections under 35 U.S.C. 112, second paragraph**

Claims 1-18 are rejected under 35 U.S.C. 112, second paragraph, as being indefinite for failing to particularly point out and distinctly claim the subject matter which Applicant regards as the invention.

Applicant has made further amendments to clarify the distinction between the two types of data, data indicating a physiologic status of a subject and data indicating an amount of exercise performed by the subject, as well as clarifying that the data indicating a physiologic status of a subject is received at least partially while the subject is exercising. The data indicating a physiologic status of a subject is exemplified in new dependent claims 20 and 21,

Serial No.: 12/211,033

and data indicating an amount of exercise performed by the subject is exemplified in amended dependent claims 7 and 12. By way of support, Applicant notes that plural types of data are noted in several locations, e.g., paragraphs [0013] (“Various health parameters... may be entered into a health monitoring device...”), [0016] (“...the system may be employed to monitor the physiologic status of a healthy subject while eating, exercising...”, emphasis added), [0063] (“In a highly interactive embodiment, a patient may have numerous HMDs 11 connected via optional adaptors to a WWD 12, and wireless application 70 may correspondingly send a large amount of health data to server application 62.”)<sup>1</sup>, and [0075] (“Referring to FIG. 6, an example is given for a system of health, nutrition, and/or exercise management.”, emphasis added).

Regarding other second paragraph rejections, an amendment to claim 17 removes the offending Bluetooth® term, the amendment finding support in paragraph [0052], and Bluetooth® per se is replaced by 802.15, which is the protocol associated with the Bluetooth® specification. In addition, Applicant has amended claim 2, this amendment finding support in paragraph [0076].

Applicant submits that the above claim amendments better clarify what he regards as the invention, and respectfully requests that the 35 U.S.C. § 112 ¶2 rejections of these claims be withdrawn.

### **Rejection under 35 U.S.C. 102(b)**

Claims 1-18 are rejected under 35 U.S.C. 102(b) as being anticipated by Brown US Patent Number 5,997,476. This rejection is traversed with respect to the amended claims as follows, this traversal tracking the arguments Applicant made in the interview.

Applicant first submits that the Brown reference is deficient as an anticipatory reference because the same fails to disclose monitoring exercise data. While Brown discloses that the reference is broader than just medical monitoring (4:23-35), the reference never discloses any use of the device in the exercise field. Applicant next submits that while the Brown reference discloses receiving data from more than one health monitor (device jacks 68A-C), it fails to disclose receiving data indicating a physiologic status of a subject at least partially while the subject is exercising (and where data indicating an amount of exercise performed by the subject is also being received). At most, Brown discloses receiving data with “*multiple device*

---

<sup>1</sup> Note that the teachings of the “medical” embodiment were extended to the “exercise” embodiment in paragraph [0081].

Serial No.: 12/211,033

*interfaces to accommodate monitoring devices which have different connection standards.”*  
(6:47-50).

In fact, Applicant submits that even if systems were developed that modeled exercise data in a better way based on physiologic data, the same would require additional data inputs, e.g., type of exercise performed, that Brown fails to disclose.

For at least these reasons, Applicant submits that the claims are not anticipated by Brown, and further respectfully requests that the 35 U.S.C. §102 rejections of these claims be withdrawn.

### **Nonstatutory Double Patenting Rejection**

Claims 1-12 are rejected under the judicially created doctrine of obviousness-type double patenting as being allegedly unpatentable over claims 3-6, and 33-43 of U.S. Patent No. 6,602,191. In particular, the Examiner states that although the conflicting claims are not identical, they are not patentably distinct from each other because it would have been allegedly obvious to one of ordinary skill in the art at the time of the invention to implement the method of the patent in the manner set forth in the instant application since the claims of the instant application are allegedly merely different renditions of the patented method and computer readable medium.

This rejection is traversed with respect to the amended claims as follows, this traversal again tracking the arguments Applicant made in the interview. Applicant submits that the current claims are nonobvious over the claims noted for many of the same reasons they distinguish from Brown. In particular, the claims noted fail to disclose receiving data indicating a physiologic status of a subject at least partially while the subject is exercising (and where data indicating an amount of exercise performed by the subject is also being received).

For at least these reasons, Applicant submits that the claims are not obvious over the noted claims of U.S. Patent No. 6,602,191, and further respectfully requests that the double-patenting rejections of these claims be withdrawn.

### **Conclusion**

Should the Examiner be of the view that an interview would expedite consideration of the application, request is made that the Examiner telephone the Applicants' attorney at (619) 818-4615 in order that any outstanding issues be resolved.



Serial No.: 12/211,033

Authorization is given to charge deposit account 50-1047 in the amount of \$110.00 in additional claims fees Applicant believes is due as the application now has 20 claims, including 4 independent claims. Any deficiencies may also be charged to deposit account 50-1047.

Respectfully submitted,

Date: March 16, 2010  
Attorney for Applicant  
Mayer & Williams PC  
251 North Avenue West, 2<sup>nd</sup> Floor  
Westfield, NJ 07090  
Tel: 619-818-4615  
Fax: 908-518-7795

/Mark Wiczorek/  
Mark D. Wiczorek  
Registration No. 37,966

<b>Electronic Patent Application Fee Transmittal</b>				
<b>Application Number:</b>	12211033			
<b>Filing Date:</b>	15-Sep-2008			
<b>Title of Invention:</b>	METHOD AND APPARATUS FOR MONITORING EXERCISE WITH WIRELESS INTERNET CONNECTIVITY			
<b>First Named Inventor/Applicant Name:</b>	Roger J. Quy			
<b>Filer:</b>	Karin L. Williams/Michelle Wolf			
<b>Attorney Docket Number:</b>	00125/002005			
Filed as Small Entity				
<b>Utility under 35 USC 111(a) Filing Fees</b>				
Description	Fee Code	Quantity	Amount	Sub-Total in USD(\$)
<b>Basic Filing:</b>				
<b>Pages:</b>				
<b>Claims:</b>				
Independent claims in excess of 3	2201	1	110	110
<b>Miscellaneous-Filing:</b>				
<b>Petition:</b>				
<b>Patent-Appeals-and-Interference:</b>				
<b>Post-Allowance-and-Post-Issuance:</b>				
<b>Extension-of-Time:</b>				

Description	Fee Code	Quantity	Amount	Sub-Total in USD(\$)
<b>Miscellaneous:</b>				
<b>Total in USD (\$)</b>				<b>110</b>

**Electronic Acknowledgement Receipt**

<b>EFS ID:</b>	7217805
<b>Application Number:</b>	12211033
<b>International Application Number:</b>	
<b>Confirmation Number:</b>	7693
<b>Title of Invention:</b>	METHOD AND APPARATUS FOR MONITORING EXERCISE WITH WIRELESS INTERNET CONNECTIVITY
<b>First Named Inventor/Applicant Name:</b>	Roger J. Quy
<b>Customer Number:</b>	27774
<b>Filer:</b>	Karin L. Williams/Michelle Wolf
<b>Filer Authorized By:</b>	Karin L. Williams
<b>Attorney Docket Number:</b>	00125/002005
<b>Receipt Date:</b>	16-MAR-2010
<b>Filing Date:</b>	15-SEP-2008
<b>Time Stamp:</b>	14:12:49
<b>Application Type:</b>	Utility under 35 USC 111(a)

**Payment information:**

Submitted with Payment	yes
Payment Type	Deposit Account
Payment was successfully received in RAM	\$110
RAM confirmation Number	468
Deposit Account	501047
Authorized User	

**File Listing:**

Document Number	Document Description	File Name	File Size(Bytes)/ Message Digest	Multi Part /.zip	Pages (if appl.)
-----------------	----------------------	-----------	-------------------------------------	------------------	------------------

1		00125_002005_RespOA31510_ asfiled.pdf	174447  7842e61a4453f291086a472608353a7a14d 4e764	yes	10
<b>Multipart Description/PDF files in .zip description</b>					
		<b>Document Description</b>	<b>Start</b>	<b>End</b>	
		Amendment/Req. Reconsideration-After Non-Final Reject	1	1	
		Claims	2	5	
		Applicant Arguments/Remarks Made in an Amendment	6	10	
<b>Warnings:</b>					
<b>Information:</b>					
2	Fee Worksheet (PTO-875)	fee-info.pdf	30401  bfa978fe72fa88301fe74faaae3575b62c384 de3	no	2
<b>Warnings:</b>					
<b>Information:</b>					
<b>Total Files Size (in bytes):</b>			204848		
<p><b>This Acknowledgement Receipt evidences receipt on the noted date by the USPTO of the indicated documents, characterized by the applicant, and including page counts, where applicable. It serves as evidence of receipt similar to a Post Card, as described in MPEP 503.</b></p> <p><b><u>New Applications Under 35 U.S.C. 111</u></b>                  If a new application is being filed and the application includes the necessary components for a filing date (see 37 CFR 1.53(b)-(d) and MPEP 506), a Filing Receipt (37 CFR 1.54) will be issued in due course and the date shown on this Acknowledgement Receipt will establish the filing date of the application.</p> <p><b><u>National Stage of an International Application under 35 U.S.C. 371</u></b>                  If a timely submission to enter the national stage of an international application is compliant with the conditions of 35 U.S.C. 371 and other applicable requirements a Form PCT/DO/EO/903 indicating acceptance of the application as a national stage submission under 35 U.S.C. 371 will be issued in addition to the Filing Receipt, in due course.</p> <p><b><u>New International Application Filed with the USPTO as a Receiving Office</u></b>                  If a new international application is being filed and the international application includes the necessary components for an international filing date (see PCT Article 11 and MPEP 1810), a Notification of the International Application Number and of the International Filing Date (Form PCT/RO/105) will be issued in due course, subject to prescriptions concerning national security, and the date shown on this Acknowledgement Receipt will establish the international filing date of the application.</p>					

Under the Paperwork Reduction Act of 1995, no persons are required to respond to a collection of information unless it displays a valid OMB control number.

<b>PATENT APPLICATION FEE DETERMINATION RECORD</b> Substitute for Form PTO-875					Application or Docket Number <b>12/211,033</b>		Filing Date <b>09/15/2008</b>		<input checked="" type="checkbox"/> To be Mailed					
<b>APPLICATION AS FILED – PART I</b>							<b>OTHER THAN</b>							
(Column 1)		(Column 2)			SMALL ENTITY <input checked="" type="checkbox"/>		OR		SMALL ENTITY					
FOR	NUMBER FILED	NUMBER EXTRA			RATE (\$)	FEE (\$)	OR		RATE (\$)	FEE (\$)				
<input type="checkbox"/> BASIC FEE <small>(37 CFR 1.16(a), (b), or (c))</small>	N/A	N/A			N/A				N/A					
<input type="checkbox"/> SEARCH FEE <small>(37 CFR 1.16(k), (l), or (m))</small>	N/A	N/A			N/A				N/A					
<input type="checkbox"/> EXAMINATION FEE <small>(37 CFR 1.16(o), (p), or (q))</small>	N/A	N/A			N/A				N/A					
TOTAL CLAIMS <small>(37 CFR 1.16(i))</small>	minus 20 =	*			X \$ =				X \$ =					
INDEPENDENT CLAIMS <small>(37 CFR 1.16(h))</small>	minus 3 =	*			X \$ =				X \$ =					
<input type="checkbox"/> APPLICATION SIZE FEE <small>(37 CFR 1.16(s))</small>	If the specification and drawings exceed 100 sheets of paper, the application size fee due is \$250 (\$125 for small entity) for each additional 50 sheets or fraction thereof. See 35 U.S.C. 41(a)(1)(G) and 37 CFR 1.16(s).													
<input type="checkbox"/> MULTIPLE DEPENDENT CLAIM PRESENT <small>(37 CFR 1.16(j))</small>														
* If the difference in column 1 is less than zero, enter "0" in column 2.					TOTAL				TOTAL					
<b>APPLICATION AS AMENDED – PART II</b>							<b>OTHER THAN</b>							
(Column 1)		(Column 2)		(Column 3)			SMALL ENTITY		OR		SMALL ENTITY			
<b>AMENDMENT</b>	<b>03/16/2010</b>	CLAIMS REMAINING AFTER AMENDMENT		HIGHEST NUMBER PREVIOUSLY PAID FOR	PRESENT EXTRA		RATE (\$)	ADDITIONAL FEE (\$)	OR		RATE (\$)	ADDITIONAL FEE (\$)		
	Total <small>(37 CFR 1.16(i))</small>	* 20	Minus	** 20	= 0		X \$26 =	0			X \$ =			
	Independent <small>(37 CFR 1.16(h))</small>	* 2	Minus	***3	= 0		X \$110 =	0			X \$ =			
	<input type="checkbox"/> Application Size Fee <small>(37 CFR 1.16(s))</small>													
	<input type="checkbox"/> FIRST PRESENTATION OF MULTIPLE DEPENDENT CLAIM <small>(37 CFR 1.16(j))</small>													
							TOTAL ADD'L FEE	<b>0</b>		TOTAL ADD'L FEE				
(Column 1)		(Column 2)		(Column 3)			SMALL ENTITY		OR		SMALL ENTITY			
<b>AMENDMENT</b>		CLAIMS REMAINING AFTER AMENDMENT		HIGHEST NUMBER PREVIOUSLY PAID FOR	PRESENT EXTRA		RATE (\$)	ADDITIONAL FEE (\$)	OR		RATE (\$)	ADDITIONAL FEE (\$)		
	Total <small>(37 CFR 1.16(i))</small>	*	Minus	**	=		X \$ =				X \$ =			
	Independent <small>(37 CFR 1.16(h))</small>	*	Minus	***	=		X \$ =				X \$ =			
	<input type="checkbox"/> Application Size Fee <small>(37 CFR 1.16(s))</small>													
	<input type="checkbox"/> FIRST PRESENTATION OF MULTIPLE DEPENDENT CLAIM <small>(37 CFR 1.16(j))</small>													
							TOTAL ADD'L FEE			TOTAL ADD'L FEE				
* If the entry in column 1 is less than the entry in column 2, write "0" in column 3.					<b>Legal Instrument Examiner:</b>									
** If the "Highest Number Previously Paid For" IN THIS SPACE is less than 20, enter "20".					<b>/KATRINA HARLING/</b>									
*** If the "Highest Number Previously Paid For" IN THIS SPACE is less than 3, enter "3".														
The "Highest Number Previously Paid For" (Total or Independent) is the highest number found in the appropriate box in column 1.														

This collection of information is required by 37 CFR 1.16. The information is required to obtain or retain a benefit by the public which is to file (and by the USPTO to process) an application. Confidentiality is governed by 35 U.S.C. 122 and 37 CFR 1.14. This collection is estimated to take 12 minutes to complete, including gathering, preparing, and submitting the completed application form to the USPTO. Time will vary depending upon the individual case. Any comments on the amount of time you require to complete this form and/or suggestions for reducing this burden, should be sent to the Chief Information Officer, U.S. Patent and Trademark Office, U.S. Department of Commerce, P.O. Box 1450, Alexandria, VA 22313-1450. DO NOT SEND FEES OR COMPLETED FORMS TO THIS ADDRESS. **SEND TO: Commissioner for Patents, P.O. Box 1450, Alexandria, VA 22313-1450.**

*If you need assistance in completing the form, call 1-800-PTO-9199 and select option 2.*

Serial No.: 12/211,033

**IN THE UNITED STATES PATENT AND TRADEMARK OFFICE**

Applicant: Roger J. Quy

Serial No.: 12/211,033

Filed: 09/15/2008

Title: METHOD AND APPARATUS FOR HEALTH AND DISEASE  
MANAGEMENT COMBINING PATIENT DATA MONITORING WITH  
WIRELESS INTERNET CONNECTIVITY

Art Unit: 3769

Examiner: Michael C. Astorino

Confirmation No.: 7693

Docket No.: 00125/002005

**Via EFS Web**

Mail Stop Amendment  
Commissioner for Patents  
P.O. Box 1450  
Alexandria, VA 22313-1450

**Supplemental Amendment**

Sir:

This supplements the Amendment filed on March 16, 2010. Kindly amend the above-identified application as follows:

**Certificate of Electronic Filing Under  
37 C.F.R. §1.8**

I certify that this correspondence and any document reference herein is being electronically deposited with the USPTO via EFS-Web on June 2, 2010.

Michelle Wolf  
(Printed Name of Person Mailing Correspondence)

/michelle wolf/  
(Signature)

Serial No.: 12/211,033

**Amendments to the Claims:**

1. (Previously Presented) A method for interactive exercise monitoring, the method comprising the steps of:
  - a. coupling a web-enabled wireless phone to a device which provides exercise-related information;
  - b. rendering a user interface on the web-enabled wireless phone;
  - c. receiving data indicating a physiologic status of a subject;
  - d. receiving data indicating an amount of exercise performed by the subject;
  - e. wherein at least one of the data indicating a physiologic status of a subject or the data indicating an amount of exercise performed by the subject is received from the device which provides exercise-related information, and wherein the data indicating a physiologic status of a subject is received at least partially while the subject is exercising;
  - f. sending the exercise-related information to an internet server via a wireless network;
  - g. receiving a calculated response from the server, the response associated with a calculation performed by the server based on the exercise-related information; and
  - h. running an application in the web-enabled wireless phone for receiving the exercise-related information and displaying the response.
  
2. (Previously Presented) The method of claim 1, wherein the receiving data indicating a physiologic status of a subject includes receiving data from a physiological sensor coupled to an exercise machine.
  
3. (Previously Presented) The method of claim 1, where the receiving data indicating an amount of exercise performed by the subject includes receiving data from an exercise machine.
  
4. (Previously Presented) The method of claim 1, wherein the web-enabled wireless phone receives exercise-related information over a transmission medium, the transmission medium including a wired connection or a wireless connection.
  
5. (Canceled)



Serial No.: 12/211,033

6. (Original) The method of claim 1, wherein the web-enabled wireless phone receives data via an adapter to convert a signal from the device to a suitable input for the wireless phone.

7. (Previously Presented) The method of claim 1, wherein the data indicating an amount of exercise performed is received from a device selected from the group consisting of: a treadmill, a stepper, an exercise cycle, an accelerometer, a rowing machine, physiotherapy equipment, an aerobic or anaerobic exercise device, and a device that monitors an amount of work or rate of work performed.

8. (Currently Amended) A non-transitory computer-readable medium, containing an application for performing an interactive method of exercise monitoring, the application physically residing on a server, the method comprising the steps of:

- a. receiving exercise-related information from a web-enabled wireless phone, wherein the exercise-related information includes data indicating a physiologic status of a subject and data indicating an amount of exercise performed by the subject, and wherein the data indicating a physiologic status of a subject is received at least partially while the subject is exercising;
- b. calculating a response based on the exercise-related information;
- c. transmitting the calculated response to the web-enabled wireless phone.

9. (Previously Presented) The medium of claim 8, wherein the method further comprises:

- a. enabling the web-enabled wireless phone to receive exercise-related information from a device; and
- b. transmitting to the web-enabled wireless phone a device application including a user interface on which the calculated response may be rendered.

10. (Previously Presented) The medium of claim 8, wherein the calculating a response includes calculating a response to assist a person in monitoring calorie expenditure, losing weight, or maintaining a healthy lifestyle.

11. (Previously Presented) The medium of claim 8, wherein the instructions further cause the web-enabled wireless phone to receive the exercise-related information via an adapter, the adapter to convert a received data signal to a suitable input for the web-enabled wireless phone.

Serial No.: 12/211,033

12. (Previously Presented) The medium of claim 8, wherein the data indicating an amount of exercise performed by the subject is received from a device which is selected from the group consisting of: a pedometer, a treadmill, a stepper, an exercise cycle, an accelerometer, a rowing machine, physiotherapy equipment, an aerobic or anaerobic exercise device, and a device that monitors an amount of work or rate of work performed.

13. (Previously Presented) The medium of claim 8, wherein the receiving exercise-related information includes receiving exercise-related information over a wireless or a wired connection.

14. (Previously Presented) A web-enabled wireless phone, containing a computer-readable medium, the computer-readable medium comprising memory within a web-enabled wireless phone, the computer-readable medium comprising instructions for causing a processor in the web-enabled wireless phone to perform the method of claim 1.

15. (Previously Presented) A computer-readable medium, the computer-readable medium comprising memory within a web-enabled wireless phone, the computer-readable medium containing instructions for causing a processor in a web-enabled wireless phone to perform the method of claim 1.

16. (Previously Presented) The method of claim 1, further comprising downloading the application to the web-enabled wireless phone from a server.

17. (Previously Presented) The method of claim 4, wherein the wireless connection includes an infrared connection or a radio frequency communication protocol including a short-range wireless transmission scheme.

18. (Previously Presented) The method of claim 4, wherein the wired connection includes a USB connection, a cable, or a docking station.

19. (Previously Presented) The method of claim 17, wherein the short-range wireless transmission scheme includes 802.11 or 802.15.

Serial No.: 12/211,033

20. (Previously Presented) The method of claim 1, wherein the data indicating a physiologic status of a subject is received from a device selected from the group consisting of: a heart rate monitor, a blood pressure monitor, a body temperature monitor, a respiratory monitor, a biofeedback device, an electronic body weight scale, and a body fat gauge.

21. (Previously Presented) The medium of claim 8, wherein the data indicating a physiologic status of a subject is received from a device which is selected from the group consisting of: a heart rate monitor, a blood pressure monitor, a body temperature monitor, a respiratory monitor, a biofeedback device, an electronic body weight scale, and a body fat gauge.

Serial No.: 12/211,033

**REMARKS**

Claims 1-4 and 6-21 were pending in this application. Claim 8 has been amended, support for this amendment is found throughout the specification given the context of the invention. In addition, Applicant directs the Examiner to the memo of Director Kappos of January 26, 2010 regarding the use of the term “non-transitory”. Reconsideration and allowance of all pending claims are respectfully requested.

**Conclusion**

Should the Examiner be of the view that an interview would expedite consideration of the application, request is made that the Examiner telephone the Applicants’ attorney at (619) 818-4615 in order that any outstanding issues be resolved.

Authorization is given to charge deposit account 50-1047 in the amount of \$110.00 in additional claims fees Applicant believes is due as the application now has 20 claims, including 4 independent claims. Any deficiencies may also be charged to deposit account 50-1047.

Respectfully submitted,

Date: June 2, 2010  
Attorney for Applicant  
Mayer & Williams PC  
251 North Avenue West, 2<sup>nd</sup> Floor  
Westfield, NJ 07090  
Tel: 619-818-4615  
Fax: 908-518-7795

/Mark Wieczorek/  
Mark D. Wieczorek  
Registration No. 37,966

**Electronic Acknowledgement Receipt**

<b>EFS ID:</b>	7728108
<b>Application Number:</b>	12211033
<b>International Application Number:</b>	
<b>Confirmation Number:</b>	7693
<b>Title of Invention:</b>	METHOD AND APPARATUS FOR MONITORING EXERCISE WITH WIRELESS INTERNET CONNECTIVITY
<b>First Named Inventor/Applicant Name:</b>	Roger J. Quy
<b>Customer Number:</b>	27774
<b>Filer:</b>	Karin L. Williams/Michelle Wolf
<b>Filer Authorized By:</b>	Karin L. Williams
<b>Attorney Docket Number:</b>	00125/002005
<b>Receipt Date:</b>	02-JUN-2010
<b>Filing Date:</b>	15-SEP-2008
<b>Time Stamp:</b>	13:03:59
<b>Application Type:</b>	Utility under 35 USC 111(a)

**Payment information:**

Submitted with Payment	no
------------------------	----

**File Listing:**

Document Number	Document Description	File Name	File Size(Bytes)/ Message Digest	Multi Part /.zip	Pages (if appl.)
1		00125-002005-Supplemental-Amendment-final.pdf	142735 4f0c9bd3270315622d94549b5baa7581219de170	yes	6

## Multipart Description/PDF files in .zip description

Document Description	Start	End
Supplemental Response or Supplemental Amendment	1	1
Claims	2	5
Applicant Arguments/Remarks Made in an Amendment	6	6

**Warnings:****Information:****Total Files Size (in bytes):**

142735

This Acknowledgement Receipt evidences receipt on the noted date by the USPTO of the indicated documents, characterized by the applicant, and including page counts, where applicable. It serves as evidence of receipt similar to a Post Card, as described in MPEP 503.

**New Applications Under 35 U.S.C. 111**

If a new application is being filed and the application includes the necessary components for a filing date (see 37 CFR 1.53(b)-(d) and MPEP 506), a Filing Receipt (37 CFR 1.54) will be issued in due course and the date shown on this Acknowledgement Receipt will establish the filing date of the application.

**National Stage of an International Application under 35 U.S.C. 371**

If a timely submission to enter the national stage of an international application is compliant with the conditions of 35 U.S.C. 371 and other applicable requirements a Form PCT/DO/EO/903 indicating acceptance of the application as a national stage submission under 35 U.S.C. 371 will be issued in addition to the Filing Receipt, in due course.

**New International Application Filed with the USPTO as a Receiving Office**

If a new international application is being filed and the international application includes the necessary components for an international filing date (see PCT Article 11 and MPEP 1810), a Notification of the International Application Number and of the International Filing Date (Form PCT/RO/105) will be issued in due course, subject to prescriptions concerning national security, and the date shown on this Acknowledgement Receipt will establish the international filing date of the application.

PTO/SB/06 (07-06)  
 Approved for use through 1/31/2007. OMB 0651-0032  
 U.S. Patent and Trademark Office; U.S. DEPARTMENT OF COMMERCE

Under the Paperwork Reduction Act of 1995, no persons are required to respond to a collection of information unless it displays a valid OMB control number.

<b>PATENT APPLICATION FEE DETERMINATION RECORD</b> Substitute for Form PTO-875					Application or Docket Number <b>12/211,033</b>		Filing Date <b>09/15/2008</b>		<input type="checkbox"/> To be Mailed			
<b>APPLICATION AS FILED – PART I</b>							<b>OTHER THAN</b>					
(Column 1)			(Column 2)		SMALL ENTITY <input checked="" type="checkbox"/>		OR		SMALL ENTITY			
FOR	NUMBER FILED	NUMBER EXTRA	RATE (\$)	FEE (\$)	RATE (\$)	FEE (\$)	RATE (\$)	FEE (\$)				
<input type="checkbox"/> BASIC FEE <small>(37 CFR 1.16(a), (b), or (c))</small>	N/A	N/A	N/A		N/A		N/A					
<input type="checkbox"/> SEARCH FEE <small>(37 CFR 1.16(k), (l), or (m))</small>	N/A	N/A	N/A		N/A		N/A					
<input type="checkbox"/> EXAMINATION FEE <small>(37 CFR 1.16(o), (p), or (q))</small>	N/A	N/A	N/A		N/A		N/A					
TOTAL CLAIMS <small>(37 CFR 1.16(i))</small>	minus 20 =	*	X \$ =		OR	X \$ =						
INDEPENDENT CLAIMS <small>(37 CFR 1.16(h))</small>	minus 3 =	*	X \$ =		OR	X \$ =						
<input type="checkbox"/> APPLICATION SIZE FEE <small>(37 CFR 1.16(s))</small>	If the specification and drawings exceed 100 sheets of paper, the application size fee due is \$250 (\$125 for small entity) for each additional 50 sheets or fraction thereof. See 35 U.S.C. 41(a)(1)(G) and 37 CFR 1.16(s).											
<input type="checkbox"/> MULTIPLE DEPENDENT CLAIM PRESENT <small>(37 CFR 1.16(j))</small>												
* If the difference in column 1 is less than zero, enter "0" in column 2.					TOTAL		TOTAL					
<b>APPLICATION AS AMENDED – PART II</b>							<b>OTHER THAN</b>					
(Column 1)			(Column 2)		(Column 3)		SMALL ENTITY		OR		SMALL ENTITY	
<b>AMENDMENT</b>	<b>06/02/2010</b>	CLAIMS REMAINING AFTER AMENDMENT	HIGHEST NUMBER PREVIOUSLY PAID FOR	PRESENT EXTRA	RATE (\$)	ADDITIONAL FEE (\$)	RATE (\$)	ADDITIONAL FEE (\$)				
	Total <small>(37 CFR 1.16(i))</small>	* 16	Minus	** 20	= 0	X \$26 =	0	OR	X \$ =			
	Independent <small>(37 CFR 1.16(h))</small>	* 2	Minus	***3	= 0	X \$110 =	0	OR	X \$ =			
	<input type="checkbox"/> Application Size Fee <small>(37 CFR 1.16(s))</small>											
	<input type="checkbox"/> FIRST PRESENTATION OF MULTIPLE DEPENDENT CLAIM <small>(37 CFR 1.16(j))</small>											
					TOTAL ADD'L FEE		TOTAL ADD'L FEE					
					<b>0</b>							
<b>AMENDMENT</b>	CLAIMS REMAINING AFTER AMENDMENT	HIGHEST NUMBER PREVIOUSLY PAID FOR	PRESENT EXTRA	RATE (\$)	ADDITIONAL FEE (\$)	RATE (\$)	ADDITIONAL FEE (\$)					
	Total <small>(37 CFR 1.16(i))</small>	*	Minus	**	=	X \$ =		OR	X \$ =			
	Independent <small>(37 CFR 1.16(h))</small>	*	Minus	***	=	X \$ =		OR	X \$ =			
	<input type="checkbox"/> Application Size Fee <small>(37 CFR 1.16(s))</small>											
	<input type="checkbox"/> FIRST PRESENTATION OF MULTIPLE DEPENDENT CLAIM <small>(37 CFR 1.16(j))</small>											
					TOTAL ADD'L FEE		TOTAL ADD'L FEE					
* If the entry in column 1 is less than the entry in column 2, write "0" in column 3.					Legal Instrument Examiner: /LINDA A. WASHINGTON/							
** If the "Highest Number Previously Paid For" IN THIS SPACE is less than 20, enter "20".												
*** If the "Highest Number Previously Paid For" IN THIS SPACE is less than 3, enter "3".												
The "Highest Number Previously Paid For" (Total or Independent) is the highest number found in the appropriate box in column 1.												

This collection of information is required by 37 CFR 1.16. The information is required to obtain or retain a benefit by the public which is to file (and by the USPTO to process) an application. Confidentiality is governed by 35 U.S.C. 122 and 37 CFR 1.14. This collection is estimated to take 12 minutes to complete, including gathering, preparing, and submitting the completed application form to the USPTO. Time will vary depending upon the individual case. Any comments on the amount of time you require to complete this form and/or suggestions for reducing this burden, should be sent to the Chief Information Officer, U.S. Patent and Trademark Office, U.S. Department of Commerce, P.O. Box 1450, Alexandria, VA 22313-1450. DO NOT SEND FEES OR COMPLETED FORMS TO THIS ADDRESS. **SEND TO: Commissioner for Patents, P.O. Box 1450, Alexandria, VA 22313-1450.**

*If you need assistance in completing the form, call 1-800-PTO-9199 and select option 2.*



UNITED STATES PATENT AND TRADEMARK OFFICE

UNITED STATES DEPARTMENT OF COMMERCE  
 United States Patent and Trademark Office  
 Address: COMMISSIONER FOR PATENTS  
 P.O. Box 1450  
 Alexandria, Virginia 22313-1450  
 www.uspto.gov

APPLICATION NO.	FILING DATE	FIRST NAMED INVENTOR	ATTORNEY DOCKET NO.	CONFIRMATION NO.
12/211,033	09/15/2008	Roger J. Quy	00125/002005	7693
2774	7590	08/13/2010	EXAMINER JIAN, SHIRLEY XUEYING	
MAYER & WILLIAMS PC 251 NORTH AVENUE WEST 2ND FLOOR WESTFIELD, NJ 07090			ART UNIT	PAPER NUMBER
			3769	
			MAIL DATE	DELIVERY MODE
			08/13/2010 PAPER	

**Please find below and/or attached an Office communication concerning this application or proceeding.**

The time period for reply, if any, is set in the attached communication.



<b>Office Action Summary</b>	<b>Application No.</b> 12/211,033	<b>Applicant(s)</b> QUY, ROGER J.	
	<b>Examiner</b> SHIRLEY JIAN	<b>Art Unit</b> 3769	

**-- The MAILING DATE of this communication appears on the cover sheet with the correspondence address --**

### Period for Reply

A SHORTENED STATUTORY PERIOD FOR REPLY IS SET TO EXPIRE 3 MONTH(S) OR THIRTY (30) DAYS, WHICHEVER IS LONGER, FROM THE MAILING DATE OF THIS COMMUNICATION.

- Extensions of time may be available under the provisions of 37 CFR 1.136(a). In no event, however, may a reply be timely filed after SIX (6) MONTHS from the mailing date of this communication.
- If NO period for reply is specified above, the maximum statutory period will apply and will expire SIX (6) MONTHS from the mailing date of this communication.
- Failure to reply within the set or extended period for reply will, by statute, cause the application to become ABANDONED (35 U.S.C. § 133). Any reply received by the Office later than three months after the mailing date of this communication, even if timely filed, may reduce any earned patent term adjustment. See 37 CFR 1.704(b).

### Status

- 1)  Responsive to communication(s) filed on 02 June 2010.
- 2a)  This action is **FINAL**.                      2b)  This action is non-final.
- 3)  Since this application is in condition for allowance except for formal matters, prosecution as to the merits is closed in accordance with the practice under *Ex parte Quayle*, 1935 C.D. 11, 453 O.G. 213.

### Disposition of Claims

- 4)  Claim(s) 1-4 and 16-21 is/are pending in the application.  
4a) Of the above claim(s) \_\_\_\_\_ is/are withdrawn from consideration.
- 5)  Claim(s) \_\_\_\_\_ is/are allowed.
- 6)  Claim(s) 1-4 and 16-21 is/are rejected.
- 7)  Claim(s) \_\_\_\_\_ is/are objected to.
- 8)  Claim(s) \_\_\_\_\_ are subject to restriction and/or election requirement.

### Application Papers

- 9)  The specification is objected to by the Examiner.
- 10)  The drawing(s) filed on \_\_\_\_\_ is/are: a)  accepted or b)  objected to by the Examiner.  
Applicant may not request that any objection to the drawing(s) be held in abeyance. See 37 CFR 1.85(a).  
Replacement drawing sheet(s) including the correction is required if the drawing(s) is objected to. See 37 CFR 1.121(d).
- 11)  The oath or declaration is objected to by the Examiner. Note the attached Office Action or form PTO-152.

### Priority under 35 U.S.C. § 119

- 12)  Acknowledgment is made of a claim for foreign priority under 35 U.S.C. § 119(a)-(d) or (f).  
a)  All    b)  Some \*    c)  None of:
1.  Certified copies of the priority documents have been received.
  2.  Certified copies of the priority documents have been received in Application No. \_\_\_\_\_.
  3.  Copies of the certified copies of the priority documents have been received in this National Stage application from the International Bureau (PCT Rule 17.2(a)).

\* See the attached detailed Office action for a list of the certified copies not received.

### Attachment(s)

- |  |   |
|--|---|
| 1) <input checked="" type="checkbox"/> Notice of References Cited (PTO-892)                                | 4) <input type="checkbox"/> Interview Summary (PTO-413)<br>Paper No(s)/Mail Date. _____ |
| 2) <input type="checkbox"/> Notice of Draftsperson's Patent Drawing Review (PTO-948)                       | 5) <input type="checkbox"/> Notice of Informal Patent Application                       |
| 3) <input type="checkbox"/> Information Disclosure Statement(s) (PTO/SB/08)<br>Paper No(s)/Mail Date _____ | 6) <input type="checkbox"/> Other: _____  |

Application/Control Number: 12/211,033  
Art Unit: 3769

Page 2

## **DETAILED ACTION**

### *Acknowledgement*

The Examiner acknowledges the response filed March 16, 2010 and the supplemental response filed June 2, 2010 wherein claims 1-4 and 6-21 are pending. For the record claims 14 and 15 are claims with a separate statutory class from method claims 1 and 8. The fact that claims 14 and 15 refer back, or reference claim 1 does not make claims 14 and 15 dependent claims. As such there are four independent claims and fourteen dependent claims pending in this application.

### *Response to Arguments*

The 35 USC § 101 rejection to claims 8-15 are withdrawn due to claim amendments.

The claim objection to claim 15 is withdrawn due to claim amendment.

The 35 USC § 112- second paragraph rejection to claims 1 and 8 are withdrawn due to claim amendments.

The 35 USC § 112- second paragraph rejection to claim 17 is withdrawn due to claim amendment.

The claims stand rejected under obviousness type nonstatutory double patenting rejection, because, as previously stated, the broadest reasonable interpretation of claims in this application is merely a different rendition of the claims in the patent.

With regard to 102(b) rejections, the Applicant's arguments have been considered but are moot in view of the new ground(s) of rejection.

Application/Control Number: 12/211,033  
Art Unit: 3769

Page 3

### ***Double Patenting***

The nonstatutory double patenting rejection is based on a judicially created doctrine grounded in public policy (a policy reflected in the statute) so as to prevent the unjustified or improper timewise extension of the "right to exclude" granted by a patent and to prevent possible harassment by multiple assignees. See *In re Goodman*, 11 F.3d 1046, 29 USPQ2d 2010 (Fed. Cir. 1993); *In re Longi*, 759 F.2d 887, 225 USPQ 645 (Fed. Cir. 1985); *In re Van Ornum*, 686 F.2d 937, 214 USPQ 761 (CCPA 1982); *In re Vogel*, 422 F.2d 438, 164 USPQ 619 (CCPA 1970); and, *In re Thorington*, 418 F.2d 528, 163 USPQ 644 (CCPA 1969).

A timely filed terminal disclaimer in compliance with 37 CFR 1.321(c) may be used to overcome an actual or provisional rejection based on a nonstatutory double patenting ground provided the conflicting application or patent is shown to be commonly owned with this application. See 37 CFR 1.130(b).

Effective January 1, 1994, a registered attorney or agent of record may sign a terminal disclaimer. A terminal disclaimer signed by the assignee must fully comply with 37 CFR 3.73(b).

Claims ***1-12*** are rejected under the judicially created doctrine of obviousness-type double patenting as being unpatentable over ***claims 3-6, and 33-43*** of U.S. Patent No. ***6,602,191***.

Although the conflicting claims are not identical, they are not patentably distinct from each other because it would have been obvious to one of ordinary skill in the art at the time of the invention to implement the method of the patent in the manner set forth in the instant application since the claims of the instant application are merely different renditions of the patented method and computer readable medium.

The Applicant is invited to explain, to make the record clear, reasons that the double patenting rejection does not apply.

### ***Claim Rejections - 35 USC § 112***

The following is a quotation of the first paragraph of 35 U.S.C. 112:

The specification shall contain a written description of the invention, and of the manner and process of making and using it, in such full, clear, concise, and exact terms as to enable any person skilled in the art to which it pertains, or with which it is most nearly connected, to make and use the same and shall set forth the best mode contemplated by the inventor of carrying out his invention.

Application/Control Number: 12/211,033  
Art Unit: 3769

Page 4

Claim 19 is rejected under 35 U.S.C. 112, first paragraph, as failing to comply with the written description requirement. The claim(s) contains subject matter which was not described in the specification in such a way as to reasonably convey to one skilled in the relevant art that the inventor(s), at the time the application was filed, had possession of the claimed invention. The claim limitation “802.15” is new matter, not supported by the disclosure.

***Claim Rejections - 35 USC § 102***

The following is a quotation of the appropriate paragraphs of 35 U.S.C. 102 that form the basis for the rejections under this section made in this Office action:

A person shall be entitled to a patent unless –

(e) the invention was described in (1) an application for patent, published under section 122(b), by another filed in the United States before the invention by the applicant for patent or (2) a patent granted on an application for patent by another filed in the United States before the invention by the applicant for patent, except that an international application filed under the treaty defined in section 351(a) shall have the effects for purposes of this subsection of an application filed in the United States only if the international application designated the United States and was published under Article 21(2) of such treaty in the English language.

**Claims 1-4, 6-18, and 20-21 are rejected under 35 U.S.C. 102(e) as being anticipated by Root et al. US Patent No. 6,013,007 (“Root”).**

Root teaches the use of a personal athletic performance monitor (device 101) with a communication network (Internet 803) to remotely monitor a user while he/she is exercising (Figs. 1-3, 6-8). The Examiner interprets the remote device 101 as a web-enabled wireless phone because it has an internal modem for connecting to the internet and connecting to a telephone line (col.2, ll.36-39, and see Fig.1). The remote monitor is disclosed as being on a wireless GPS satellite network (col.4, ll.4-21, Figs. 2-3), a radio network (col.4, ll.41-47) and modem 613

Application/Control Number: 12/211,033  
Art Unit: 3769

Page 5

(Fig.6). The remote monitor is optionally connected to physiological sensors such as a heart rate sensor 611 and temperature sensor 612 (Fig.6) via a wired or wireless connection. The remote device is adapted to be worn by a user during exercise (see Figs.2-3).

In operation, a user controls the operation of the remote device via a user interface comprised of a variety of input buttons with different functions (col.4, ll.16-59: LED indicator, "NOW" button, volume thumb wheel, pause/position button, band selection button). A display 112 indicates the remote device's operating status (col.4, ll.7-13), and audio headphones provide exercise feedback to the user during exercises (col.7, ll.16-28 & ll.51-67). Upon activation, the remote monitor utilizes the built-in GPS receiver to calculate and rate the user's athletic performance, i.e. elapsed distance, and calories burned (col.7, ll.30-51). While the user exercises, the remote monitor continuously monitors the user's vitals signs in order to issue a real-time warning when predetermined thresholds are crossed (col.2, ll.17-20). The remote monitor is additionally capable of transmitting stored data to an Internet web site for performance trending and analysis via an internal modem 613 (col.2, ll.36-39), or a remote PC 801 (Fig.8); and receiving feedback from said web site regarding personal fitness recommendations (col.8, ll.58-col.9, ll.9, col.9, ll.20-30, data trending and a recommendation is interpreted as a calculated response).

Regarding claims 8-15, the remote monitor is disclosed to have a CPU 602 and associated memory 608 (Fig.6) with executable programming instructions for carry out the operation of the device as described above (col.6, ll.62-col.8, ll.65).

Regarding claims 17-18, the remote monitor is disclosed as having a wireless connection including an infrared type port 124 (col.5, ll.36-49, Fig.6) and a wired connection including

Application/Control Number: 12/211,033  
Art Unit: 3769

Page 6

serial port 118, and a cable (see Fig.1A cables 121, 123 for connecting with GPS and headphones).

***Claim Rejections - 35 USC § 103***

The following is a quotation of 35 U.S.C. 103(a) which forms the basis for all obviousness rejections set forth in this Office action:

(a) A patent may not be obtained though the invention is not identically disclosed or described as set forth in section 102 of this title, if the differences between the subject matter sought to be patented and the prior art are such that the subject matter as a whole would have been obvious at the time the invention was made to a person having ordinary skill in the art to which said subject matter pertains. Patentability shall not be negated by the manner in which the invention was made.

**Claim 19 is rejected under 35 U.S.C. 103(a) as being unpatentable Root as applied to claim 1 above.**

Regarding claim 19, Root does not teach using a short-range wireless transmission scheme including 802.11 or 802.16. However, Root discloses a wireless GPS receiver antenna, 301, radio antenna 614, infrared port 124, and modem 613 for connecting to the Internet (Fig.6). At the time the invention was made, it would have been an obvious matter of design choice to a person of ordinary skill in the art to substitute the infrared port to 802.11 or 802.15 connection, because the Applicant has not disclosed 802.11 or 802.15 provides an advantage over an infrared connection. In fact, the specification lists various wireless techniques, including infrared, microwaves, radio frequency, BLUETOOTH, and 802.11 protocols (Specification [0024]).

***Conclusion***

The prior art made of record and not relied upon is considered pertinent to applicant's disclosure:

Application/Control Number: 12/211,033  
Art Unit: 3769

Page 7

- Alyfuku et al. US Patent No. 5,410,471, networked health care and monitoring system for monitoring a user's daily activities (see Fig.1);
- Begun et al. US Patent No. 5,474,090, apparatus and method for monitoring exercise activity and exercise responses of a user;
- Hickman US Patent No. 6,059,692, an exercise system includes a local system having an exercise apparatus and remote system;
- Cairnes US Patent No. 6,139,494, integrated clinical tele-informatics based system.

Applicant's amendment necessitated the new ground(s) of rejection presented in this Office action. Accordingly, **THIS ACTION IS MADE FINAL**. See MPEP § 706.07(a). Applicant is reminded of the extension of time policy as set forth in 37 CFR 1.136(a).

A shortened statutory period for reply to this final action is set to expire **THREE MONTHS** from the mailing date of this action. In the event a first reply is filed within **TWO MONTHS** of the mailing date of this final action and the advisory action is not mailed until after the end of the **THREE-MONTH** shortened statutory period, then the shortened statutory period will expire on the date the advisory action is mailed, and any extension fee pursuant to 37 CFR 1.136(a) will be calculated from the mailing date of the advisory action. In no event, however, will the statutory period for reply expire later than **SIX MONTHS** from the date of this final action.

Any inquiry concerning this communication or earlier communications from the examiner should be directed to SHIRLEY JIAN whose telephone number is (571)270-7374. The examiner can normally be reached on Monday-Friday 10:30am-6:00pm

Application/Control Number: 12/211,033  
Art Unit: 3769

Page 8

If attempts to reach the examiner by telephone are unsuccessful, the examiner's supervisor, Hank Johnson can be reached on 571-272-4768. The fax phone number for the organization where this application or proceeding is assigned is 571-273-8300.

Information regarding the status of an application may be obtained from the Patent Application Information Retrieval (PAIR) system. Status information for published applications may be obtained from either Private PAIR or Public PAIR. Status information for unpublished applications is available through Private PAIR only. For more information about the PAIR system, see <http://pair-direct.uspto.gov>. Should you have questions on access to the Private PAIR system, contact the Electronic Business Center (EBC) at 866-217-9197 (toll-free). If you would like assistance from a USPTO Customer Service Representative or access to the automated information system, call 800-786-9199 (IN USA OR CANADA) or 571-272-1000.

/SHIRLEY JIAN/  
Examiner, Art Unit 3769

/Henry M. Johnson, III/  
Supervisory Patent Examiner, Art Unit  
3769

August 10, 2010



<b>Notice of References Cited</b>	Application/Control No. 12/211,033	Applicant(s)/Patent Under Reexamination QUY, ROGER J.	
	Examiner SHIRLEY JIAN	Art Unit 3769	Page 1 of 1

**U.S. PATENT DOCUMENTS**

*	Document Number Country Code-Number-Kind Code	Date MM-YYYY	Name	Classification
*	A US-5,410,471 A	04-1995	Alyfuku et al.	600/300
*	B US-5,474,090 A	12-1995	Begun et al.	600/520
*	C US-6,013,007 A	01-2000	Root et al.	482/8
*	D US-6,059,692 A	05-2000	Hickman, Paul L.	482/8
*	E US-6,139,494 A	10-2000	Cairnes, Walter J.	600/300
*	F US-2001/0005830 A1	06-2001	Kuroyanagi, Tadashi	705/2
*	G US-6,736,759 B1	05-2004	Stubbs et al.	482/8
*	H US-			
*	I US-			
*	J US-			
*	K US-			
*	L US-			
*	M US-			

**FOREIGN PATENT DOCUMENTS**

*	Document Number Country Code-Number-Kind Code	Date MM-YYYY	Country	Name	Classification
*	N				
*	O				
*	P				
*	Q				
*	R				
*	S				
*	T				

**NON-PATENT DOCUMENTS**

*	Document Number Country Code-Number-Kind Code	Date MM-YYYY	Country	Name	Classification
*	Include as applicable: Author, Title Date, Publisher, Edition or Volume, Pertinent Pages)				
*	U				
*	V				
*	W				
*	X				

\*A copy of this reference is not being furnished with this Office action. (See MPEP § 707.05(a).)  
Dates in MM-YYYY format are publication dates. Classifications may be US or foreign.

<p><b>Search Notes</b></p> 	<p><b>Application/Control No.</b></p> <p>12211033</p>	<p><b>Applicant(s)/Patent Under Reexamination</b></p> <p>QUY, ROGER J.</p>
	<p><b>Examiner</b></p> <p>Michael C Astorino</p>	<p><b>Art Unit</b></p> <p>3769</p>

<b>SEARCHED</b>			
<b>Class</b>	<b>Subclass</b>	<b>Date</b>	<b>Examiner</b>
600	300-301 (text)	5/09	MA
600	300-301 (text)	8/5/2010	SJ
428	8 (text)	8/5/2010	SJ

<b>SEARCH NOTES</b>		
<b>Search Notes</b>	<b>Date</b>	<b>Examiner</b>
East search (class/subclass, inventor, parent cases backwards search)	5/09	MA
Reviewed applied prior art, spoke with H. Johnson	11/09	MA
East search notes attached (inventor, IDS, class, subclass, text)	8/5/2010	SJ
EDAN related art search	8/5/2010	SJ

<b>INTERFERENCE SEARCH</b>			
<b>Class</b>	<b>Subclass</b>	<b>Date</b>	<b>Examiner</b>

--	--

## EAST Search History

## EAST Search History (Prior Art)

Ref #	Hits	Search Query	DBs	Default Operator	Plurals	Time Stamp
S1	1	"6602191".pn.	USPAT	OR	OFF	2010/08/05 13:42
S3	5	S2 and (exercise).clm.	US-PGPUB; USPAT; USOCR	OR	OFF	2010/08/05 13:57
S2	22	((ROGER) near2 (QUY)). INV.	US-PGPUB; USPAT; USOCR	OR	OFF	2010/08/05 13:57
S5	24	mault.inv. and (pedometer treadmill (exercise NEAR4 machine))	US-PGPUB; USPAT; USOCR	OR	OFF	2010/08/05 14:00
S4	22	mault.inv. and (pedometer)	US-PGPUB; USPAT; USOCR	OR	OFF	2010/08/05 14:00
S6	263	"2630798"   "2826912"   "2831348"   "2838399"   "2869357"   "2911825"   "2920012"   "3213684"   "3220255"   "3250270"   "3306283"   "3523529"   "3527205"   "3681197"   "3726270"   "3797480"   "3799149"   "3814091"   "3834375"   "3895630"   "3938551"   "3962917"   "3967690"   "3972038"   "3991304"   "4003396"   "4008712"   "4051847"   "4078554"   "4100401"   "4101071"   "4113039"   "4117834"   "4151668"   "4159416"   "4186735"   "4188946"   "4192000"   "4197857"   "4200094"   "4211239"   "4212079"   "4221224"   "4221959"   "4224952"   "4230108"   "4244020"   "4318447"   "4321674"   "4341867"	US-PGPUB; USPAT; USOCR	OR	OFF	2010/08/05 14:01

| "4353375" |  
"4359057" | "4366873"  
| "4368740" |  
"4380802" | "4386604"  
| "4387777" |  
"4423792" | "4425805"  
| "4440177" |  
"4444201" | "4463764"  
| "4566461" |  
"4571682" | "4572208"  
| "4575804" |  
"4577710" | "4598700"  
| "4608995" |  
"4619269" | "4629015"  
| "4648396" |  
"4650218" | "4658832"  
| "4686624" |  
"4709331" | "4731726"  
| "4753245" |  
"4756670" | "4757453"  
| "4781184" |  
"4793362" | "4796182"  
| "4796639" |  
"4803625" | "4807169"  
| "4823808" |  
"4850371" | "4853854"  
| "4855942" |  
"4855945" | "4856531"  
| "4880014" |  
"4891756" | "4894793"  
| "4895163" |  
"4909259" | "4911175"  
| "4911256" |  
"4914959" | "4917108"  
| "4924389" |  
"4947862" | "4951197"  
| "4954954" |  
"4955946" | "4965553"  
| "4966155" |  
"4986268" | "4998018"  
| "5007429" |  
"5012411" | "5019974"  
| "5022406" |  
"5033561" | "5038773"  
| "5038792" |  
"5042500" | "5042501"  
| "5060506" |  
"5060655" | "5060656"  
| "5063937" |  
"5068536" | "5069220").  
PN. OR ("5072737" |  
"5077476" | "5081871"  
| "5086781" |  
"5095900" | "5095913"  
| "5117674" |

"5119825" | "5178155"  
| "5179958" |  
"5203344" | "5214966"  
| "5233520" |  
"5233996" | "5263491"  
| "5280429" |  
"5282473" | "5282840"  
| "5285794" |  
"5293875" | "5299579"  
| "5303712" |  
"5307263" | "5309921"  
| "5326973" |  
"5335667" | "5355879"  
| "5357972" |  
"5363857" | "5372141"  
| "5381796" |  
"5387164" | "5388043"  
| "5398688" |  
"5398695" | "5402796"  
| "5412560" |  
"5412564" | "5415176"  
| "5419326" |  
"5421344" | "5425374"  
| "5449000" |  
"5450193" | "5454721"  
| "5468961" |  
"5485402" | "5503151"  
| "5542420" |  
"5570697" | "5579782"  
| "5611351" |  
"5615689" | "5632281"  
| "5645071" |  
"5647370" | "5673691"  
| "5676132" |  
"5678562" | "5678571"  
| "5691927" |  
"5704350" | "5705735"  
| "5720296" |  
"5729479" | "5746214"  
| "5754288" |  
"5788643" | "5789660"  
| "5796009" |  
"5796640" | "5800360"  
| "5810722" |  
"5816246" | "5817031"  
| "5819735" |  
"5822715" | "5827179"  
| "5831175" |  
"5832448" | "5834626"  
| "5836300" |  
"5836312" | "5876351"  
| "5890128" |  
"5897493" | "5899855"  
| "5902234" |  
"5908301" | "5910107"

		"5913310"   "5918603"   "5922610"   "5932812"   "5933136"   "5941825"   "5951300"   "5957858"   "5961451"   "5974124"   "5989188"   "5997476"   "6010459"   "6013007"   "6014578"   "6015389"   "6024281"   "6024699"   "6030342"   "6032676"   "6040531"   "6042383"   "6044843"   "6045513"   "6077193"   "6083006"   "6095949"   "6095985"   "6101478"   "6122536"   "6135950"   "6135951"   "6309342"   "6396416").PN.				
S7	20	S6 and (pedometer treadmill (exercise NEAR4 machine))	US-PGPUB; USPAT; USOCR	OR	OFF	2010/08/05 14:02
S11	59	teller.inv. and (pedometer treadmill (exercise NEAR4 machine)) AND (scale)	US-PGPUB; USPAT; USOCR	OR	OFF	2010/08/05 14:05
S10	59	teller.inv. and (pedometer treadmill (exercise NEAR4 machine))	US-PGPUB; USPAT; USOCR	OR	OFF	2010/08/05 14:05
S9	11108	"teller.inv. and" (pedometer treadmill (exercise NEAR4 machine))	US-PGPUB; USPAT; USOCR	OR	OFF	2010/08/05 14:05
S12	93	bro.inv.	US-PGPUB; USPAT; USOCR	OR	OFF	2010/08/05 15:05
S15	1	"5377258".pn. and exercise	USPAT	OR	OFF	2010/08/05 15:06
S14	1	"5377258".pn.	USPAT	OR	OFF	2010/08/05 15:06
S16	0	"5377258".pn. and treadmill	USPAT	OR	OFF	2010/08/05 15:07

S17	146	US-5576952-\$.DID. OR US-6093146-\$.DID. OR US-6478736-\$.DID. OR US-6610012-\$.DID. OR US-6856832-\$.DID. OR US-6936007-\$.DID. OR US-6976958-\$.DID. OR US-4282883-\$.DID. OR US-5012814-\$.DID. OR US-5307263-\$.DID. OR US-5357427-\$.DID. OR US-5434611-\$.DID. OR US-5441047-\$.DID. OR US-5544649-\$.DID. OR US-5544661-\$.DID. OR US-5553609-\$.DID. OR US-5601435-\$.DID. OR US-5626144-\$.DID. OR US-5678562-\$.DID. OR US-5701904-\$.DID. OR US-5704366-\$.DID. OR US-5724025-\$.DID. OR US-5732709-\$.DID. OR US-5752917-\$.DID. OR US-5772586-\$.DID. OR US-5791342-\$.DID. OR US-5931791-\$.DID. OR US-5933136-\$.DID. OR US-5935060-\$.DID. OR US-5941829-\$.DID. OR US-5951300-\$.DID. OR US-5964701-\$.DID. OR US-1011999-\$.DID. OR US-5987352-\$.DID. OR US-1111999-\$.DID. OR US-5987519-\$.DID. OR US-1019998-\$.DID. OR US-5997476-\$.DID. OR US-6022315-\$.DID. OR US-6024699-\$.DID. OR US-6050940-\$.DID. OR US-6055508-\$.DID. OR US-6057758-\$.DID. OR US-6083156-\$.DID. OR US-6101478-\$.DID. OR US-1112000-\$.DID. OR US-6160478-\$.DID. OR US-6168563-\$.DID. OR US-6190324-\$.DID. OR US-6266645-\$.DID. OR US-6319199-\$.DID. OR US-6336900-\$.DID. OR US-6375614-\$.DID. OR US-8386882-\$.DID. OR US-6416471-\$.DID. OR	US-PGPUB; USPAT; EPO; JPO; DERWENT; IBM_TDB	OR	OFF	2010/08/05 15:11
-----	-----	---	---	----	-----	---------------------

		US-6418346-\$.DID. OR US-6440068-\$.DID. OR US-6529771-\$.DID. OR US-20020016719-\$. DID. OR US- 20020019584-\$.DID. OR US-20020026223-\$. DID. OR US- 20020072785-\$.DID. OR US-20020082480-\$. DID. OR US- 20020120310-\$.DID. OR US-20030004554-\$. DID. OR US- 20030072424-\$.DID. OR US-20030139785-\$. DID. OR US- 20030204413-\$.DID. OR WO-9532480-\$.DID. OR US-1111995-\$.DID. OR US-9728737-\$.DID. OR WO-9838909-\$.DID. OR US-9904687-\$.DID. OR WO-9914882-\$.DID. OR US-9946718-\$.DID. OR WO-0036900-\$.DID. OR WO-0040145-\$.DID. OR WO-00154205-\$. DID. OR WO-0054206-\$. DID. OR WO-0062662-\$. DID. OR WO-0124038-\$. DID. OR JP-11259783-\$. DID. OR JP-11122369-\$. DID. OR JP-11047101-\$. DID. OR JP-9224917-\$. DID. OR JP- 2002344660-\$.DID. OR US-1292002-\$.DID. OR US-2120051-\$.DID. OR US-242000D-\$.DID. OR US-2820000-\$.DID. OR US-282000D-\$.DID.				
S18	8	S17 and (diet nutrition fitness).bsum. and (portable remote).bsum, clm,ab. and (exercise)	US-PGPUB; USPAT; EPO; JPO; DERWENT; IBM_TDB	OR	OFF	2010/08/05 15:12



S19	279	"2630798"   "2826912"   "2831348"   "2838399"   "2869357"   "2911825"   "2920012"   "3213684"   "3220255"   "3250270"   "3306283"   "3523529"   "3527205"   "3681197"   "3726270"   "3799149"   "3814091"   "3834375"   "3895630"   "3938551"   "3962917"   "3979480"   "3991304"   "4003396"   "4031847"   "4078554"   "4095274"   "4100401"   "4101071"   "4151668"   "4159416"   "4186735"   "4188946"   "4192000"   "4197857"   "4200094"   "4211239"   "4221079"   "4221224"   "4221959"   "4230108"   "4244020"   "4321674"   "4341867"   "4359057"   "4368740"   "4380802"   "4386604"   "4387777"   "4425805"   "4440177"   "4444201"   "4463764"   "4566461"   "4571682"   "4572208"   "4575804"   "4598700"   "4608995"   "4619269"   "4629015"   "4648396"   "4650218"   "4658832"   "4686624"   "4709331"   "4731726"   "4753245"   "4756670"   "4757453"   "4781184"   "4796182"   "4796639"   "4803625"   "4807169"   "4823808"   "4850371"   "4853854"   "4855945"   "4856531"   "4891756"   "4894793"   "4909259"	US-PGPUB; USPAT; USOCR	OR	OFF	2010/08/05 15:13
-----	-----	---	---------------------------	----	-----	---------------------

| "4911256" |  
"4914959" | "4917108"  
| "4924389" |  
"4951197" | "4954954"  
| "4955946" |  
"4986268" | "4998018"  
| "5022406" |  
"5033561" | "5038773"  
| "5038792" |  
"5042500" | "5042501"  
| "5060506" |  
"5060655" | "5060656"  
| "5069220" |  
"5072737" | "5081871"  
| "5095900" |  
"5095913" | "5117674"  
| "5119825" |  
"5178155" | "5179958"  
| "5214966" |  
"5233520" | "5233996"  
| "5263491" |  
"5282473" | "5285794"  
| "5293875" |  
"5299579" | "5303712"  
| "5309921" |  
"5326973" | "5355879"  
| "5357972" |  
"5363857" | "5387164").  
PN. OR ("5388043" |  
"5398688" | "5398695"  
| "5402796" |  
"5412560" | "5412564"  
| "5419326" |  
"5425374" | "5450193"  
| "5454721" |  
"5468961" | "5478989"  
| "5503151" |  
"5570697" | "5632281"  
| "5645071" |  
"5647370" | "5673691"  
| "5676132" |  
"5691927" | "5704350"  
| "5705735" |  
"5729479" | "5754288"  
| "5789660" |  
"5796009" | "5800360"  
| "5810722" |  
"5816246" | "5819735"  
| "5822715" |  
"5831175" | "5832448"  
| "5834626" |  
"5836300" | "5836312"  
| "5839901" |  
"5890128" | "5908301"  
| "5918603" |

		"5922610"   "5932812"   "5933136"   "5954510"   "5954640"   "5957858"   "5989188"   "6010459"   "6013007"   "6024281"   "6024699"   "6030342"   "6032119"   "6032676"   "6039688"   "6040531"   "6042383"   "6044843"   "6077193"   "6083006"   "6095949"   "6095985"   "6101478"   "6135950"   "6135951").PN. OR ("6478736").URPN.				
S21	213	S20 and (server central)	US-PGPUB; USPAT; EPO; JPO; DERWENT; IBM_TDB	OR	OFF	2010/08/05 15:14
S20	243	(diet nutrition fitness). bsum. and (portable remote).bsum,clm,ab. and (exercise) and 600/300-301.ccls.	US-PGPUB; USPAT; EPO; JPO; DERWENT; IBM_TDB	OR	OFF	2010/08/05 15:14
S22	2002	(diet nutrition fitness). bsum. and (portable remote).bsum,clm,ab. and (exercise)	US-PGPUB; USPAT; EPO; JPO; DERWENT; IBM_TDB	OR	OFF	2010/08/05 15:16
S23	402	S22 and ((measur\$4 detect\$4 monitor\$4 sens \$5) WITH ((heart NEAR2 rate) pulse (blood NEAR2 pressure) physiolog\$5 vital temperature respirat\$5 fatigue) WITH (exercis \$4 work\$out run\$5 walk \$3))	US-PGPUB; USPAT; EPO; JPO; DERWENT; IBM_TDB	OR	OFF	2010/08/05 15:18
S25	206	S24 and (PDA phone cellular mobile)	US-PGPUB; USPAT; EPO; JPO; DERWENT; IBM_TDB	OR	OFF	2010/08/05 15:19
S24	307	S23 and (server central)	US-PGPUB; USPAT; EPO; JPO; DERWENT; IBM_TDB	OR	OFF	2010/08/05 15:19

S26	78	("3436487"   "3882277"   "4523311"   "4586174"   "4757495"). PN. OR ("5474090"). URPN.	US-PGPUB; USPAT; USOCR	OR	OFF	2010/08/05 15:21
S27	184	S25 and wireless	US-PGPUB; USPAT; EPO; JPO; DERWENT; IBM_TDB	OR	OFF	2010/08/05 15:24
S28	165	S27 and (web internet)	US-PGPUB; USPAT; EPO; JPO; DERWENT; IBM_TDB	OR	OFF	2010/08/05 15:28
S29	185	("4685059"   "4731726"   "4803625"   "4981139"   "5016172"   "5019974"   "5024225"   "5025374"   "5047044"   "5077476"   "5078134"   "5216597"   "5265613"   "5307263"   "5341291"   "5371687"   "5379214"   "5432698"   "5458123"   "5471382"   "5579775"   "5619991"   "5840020"   "5907291"). PN. OR ("6024699"). URPN.	US-PGPUB; USPAT; USOCR	OR	OFF	2010/08/05 15:29
S30	156	S29 and (exercis\$4 work \$out run\$5 walk\$3 activit\$5)	US-PGPUB; USPAT; EPO; JPO; DERWENT; IBM_TDB	OR	OFF	2010/08/05 15:30
L3	2	"5997476".pn.	US-PGPUB; USPAT; EPO; JPO; DERWENT; IBM_TDB	OR	OFF	2010/08/05 15:57
L9	88	mault.inv.	US-PGPUB; USPAT	OR	OFF	2010/08/05 16:03
L8	9762	abraham.inv.	US-PGPUB; USPAT	OR	OFF	2010/08/05 16:03
L10	62	mault.inv. and exercise	US-PGPUB; USPAT	OR	OFF	2010/08/05 16:04
L11	740	brown.inv. and (exercise treadmill bike)	US-PGPUB; USPAT	OR	OFF	2010/08/05 16:14

L12	0	"5997476".pn. and (exercise treadmill bike)	US-PGPUB; USPAT	OR	OFF	2010/08/05 16:15
L16	173	(diet nutrition fitness). bsum. and (portable remote). bsum,clm,ab. and (exercise) and 482/8.ccls.	US-PGPUB; USPAT; EPO; JPO; DERWENT; IBM_TDB	OR	OFF	2010/08/05 16:30
L15	1158	482/8.ccls.	US-PGPUB; USPAT; EPO; JPO; DERWENT; IBM_TDB	OR	OFF	2010/08/05 16:30
L14	0	482/8.clas.	US-PGPUB; USPAT; EPO; JPO; DERWENT; IBM_TDB	OR	OFF	2010/08/05 16:30
L13	0	(diet nutrition fitness). bsum. and (portable remote). bsum,clm,ab. and (exercise) and 482/8.clas.	US-PGPUB; USPAT; EPO; JPO; DERWENT; IBM_TDB	OR	OFF	2010/08/05 16:30
L20	85	16 and (PDA phone cellular mobile) AND ( remote wireless internet web)	US-PGPUB; USPAT; EPO; JPO; DERWENT; IBM_TDB	OR	OFF	2010/08/05 16:33
L19	160	16 and (PDA phone cellular mobile remote wireless internet web)	US-PGPUB; USPAT; EPO; JPO; DERWENT; IBM_TDB	OR	OFF	2010/08/05 16:33
L18	160	16 and (PDA phone cellular mobile remote wireless internet)	US-PGPUB; USPAT; EPO; JPO; DERWENT; IBM_TDB	OR	OFF	2010/08/05 16:33
L17	154	16 and (PDA phone cellular mobile remote)	US-PGPUB; USPAT; EPO; JPO; DERWENT; IBM_TDB	OR	OFF	2010/08/05 16:33
L21	58	("5474090"   "5591104").PN. OR ("6059692").URPN.	US-PGPUB; USPAT; USOCR	OR	OFF	2010/08/05 16:34

L23	29	("4817940"   "4891785"   "5213555"   "5387164"   "5435799"   "5785632"   "5799281"   "5816443"   "5888172"   "5973696"   "6042519"   "6193631"   "6450922"   "6464618"). PN. OR ("6746371"). URPN.	US-PGPUB; USPAT; USOCR	OR	OFF	2010/08/05 16:35
L22	24	"6746371"	US-PGPUB; USPAT; USOCR	OR	OFF	2010/08/05 16:35
L24	9	23 and (wired wireless)	US-PGPUB; USPAT; USOCR	OR	OFF	2010/08/05 16:36
L26	1	"6213872".pn.	US-PGPUB; USPAT; USOCR	OR	OFF	2010/08/05 16:39
L25	8	"5673691".pn. "5652570".pn. "6447424".pn. "5839901".pn. "5680866".pn. "5213872".pn. "6746371".pn. "6736759".pn.	US-PGPUB; USPAT; USOCR	OR	OFF	2010/08/05 16:39
L27	2	25 and phone	US-PGPUB; USPAT; USOCR	OR	OFF	2010/08/05 16:40
L28	89	("4566461"   "5081991"   "5148002"   "5167230"   "5318487"   "5345244"   "5408444"   "5456262"   "5458548"   "5464021"   "5486818"   "5491474"   "5564417"   "5575284"   "5589835"   "5611346"   "5622180"   "5627548"   "5632279"   "5690119"   "5731757"   "5779631"   "5781155"   "5810722"   "5840039"   "5852401"   "5884198"   "5889493"   "5891042"   "5905460"   "5919133"   "6002982"   "6013007"   "6032108"   "6083248"   "6148262"   "6148280"   "6152856"   "6199550"	US-PGPUB; USPAT; USOCR	OR	OFF	2010/08/05 16:42

		"6285314").PN. OR ("6736759").URPN.				
L29	9	28 and exercise and phone and wireless	US-PGPUB; USPAT; USOCR	OR	OFF	2010/08/05 16:43
L30	20	28 and phone	US-PGPUB; USPAT; USOCR	OR	OFF	2010/08/05 16:44
L31	1	"6736759".pn. and (remote server central)	US-PGPUB; USPAT; EPO; JPO; DERWENT; IBM_TDB	OR	OFF	2010/08/05 16:50
L32	1	"5997476".pn. and (exercise treadmill bike activity diabetes)	US-PGPUB; USPAT	OR	OFF	2010/08/05 16:52
L34	157	33 and (exercise treadmill bike activity diabetes)	US-PGPUB; USPAT	OR	OFF	2010/08/05 16:53
L33	211	"5299121"   "5390238"   "5410471"   "5434611"   "5441047"   "5544649"   "5619991").PN. OR ("5997476").URPN.	US-PGPUB; USPAT; USOCR	OR	OFF	2010/08/05 16:53
L38	1	"6013007".pn. and (heart rate)	US-PGPUB; USPAT	OR	OFF	2010/08/05 16:59
L37	0	"6013007".pn. and pulse	US-PGPUB; USPAT	OR	OFF	2010/08/05 16:59
L36	55	"6013007" and pulse	US-PGPUB; USPAT	OR	OFF	2010/08/05 16:59
L35	171	"6013007"	US-PGPUB; USPAT	OR	OFF	2010/08/05 16:59
L40	1	"6013007".pn. and (distance (exercise NEAr4 amount))	US-PGPUB; USPAT	OR	OFF	2010/08/05 17:01
L39	1	"6013007".pn. and (distance)	US-PGPUB; USPAT	OR	OFF	2010/08/05 17:01
L42	1	"6013007".pn.	USPAT	OR	OFF	2010/08/05 18:27
L41	154	"6013007"	USPAT	OR	OFF	2010/08/05 18:27

### EAST Search History (I nterference)

< This search history is empty >

8/ 5/ 2010 6:31:02 PM

C:\ Documents and Settings\ sjian\ My Documents\ EAST\ Workspaces\ 12211033.wsp

Serial No.: 12/211,033  
Examiner Shirley Xueying Jian  
Group Art Unit 3769  
Page 1 of 7

**IN THE UNITED STATES PATENT AND TRADEMARK OFFICE**

Applicants: Roger J. Quy  
Application No. 12/211,033  
Filed: September 15, 2008  
Title: METHOD AND APPARATUS FOR MONITORING EXERCISE  
WITH WIRELESS INTERNET CONNECTIVITY  
Art Unit: 3769  
Examiner: Shirley Jian  
Confirm. No.: 7693  
Docket No.: 00125/002005  
Via EFS Web  
Commissioner for Patents  
P.O. Box 1450  
Alexandria, VA 22313-1450

Certificate of Electronic Transmission  
Under 37 C.F.R. §1.8  
I hereby certify that this correspondence and any document referenced  
herein are being electronically filed with the USPTO via EFS-Web on  
September 20, 2010  
Nancy Joyce Simmons  
(Printed Name of Person Sending Correspondence)  
/nancy joyce simmons/  
(Signature)

Sir:

**AMENDMENT AND RESPONSE TO FINAL OFFICE ACTION**

This is responsive to the Office Action mailed August 13, 2010 in the above matter, in which the rejections of the claims was made final. A response is due November 13, 2010, and thus this Amendment and Response is timely filed.

No fees are believed to be due. Any fees deemed to be due or credit for any overpayment for this application should be directed to Deposit Account Number 50-1047 and authorization is hereby given to charge such account.

Please enter the following remarks:

**Amendments** begin on page 2.

**Remarks/Arguments** begin on page 6.



Serial No.: 12/211,033  
Examiner Shirley Xueying Jian  
Group Art Unit 3769  
Page 2 of 7

IN THE CLAIMS:

1. (Previously Presented) A method for interactive exercise monitoring, the method comprising the steps of:
  - a. coupling a web-enabled wireless phone to a device which provides exercise-related information;
  - b. rendering a user interface on the web-enabled wireless phone;
  - c. receiving data indicating a physiologic status of a subject;
  - d. receiving data indicating an amount of exercise performed by the subject;
  - e. wherein at least one of the data indicating a physiologic status of a subject or the data indicating an amount of exercise performed by the subject is received from the device which provides exercise-related information, and wherein the data indicating a physiologic status of a subject is received at least partially while the subject is exercising;
  - f. sending the exercise-related information to an internet server via a wireless network;
  - g. receiving a calculated response from the server, the response associated with a calculation performed by the server based on the exercise-related information; and
  - h. running an application in the web-enabled wireless phone for receiving the exercise-related information and displaying the response.
  
2. (Previously Presented) The method of claim 1, wherein the receiving data indicating a physiologic status of a subject includes receiving data from a physiological sensor coupled to an exercise machine.
  
3. (Previously Presented) The method of claim 1, where the receiving data indicating an amount of exercise performed by the subject includes receiving data from an exercise machine.

Serial No.: 12/211,033  
Examiner Shirley Xueying Jian  
Group Art Unit 3769  
Page 3 of 7

4. (Previously Presented) The method of claim 1, wherein the web-enabled wireless phone receives exercise-related information over a transmission medium, the transmission medium including a wired connection or a wireless connection.
  
5. (Canceled)
  
6. (Original) The method of claim 1, wherein the web-enabled wireless phone receives data via an adapter to convert a signal from the device to a suitable input for the wireless phone.
  
7. (Previously Presented) The method of claim 1, wherein the data indicating an amount of exercise performed is received from a device selected from the group consisting of: a treadmill, a stepper, an exercise cycle, an accelerometer, a rowing machine, physiotherapy equipment, an aerobic or anaerobic exercise device, and a device that monitors an amount of work or rate of work performed.
  
8. (Previously Presented) A non-transitory computer-readable medium, containing an application for performing an interactive method of exercise monitoring, the application physically residing on a server, the method comprising the steps of:
  - a. receiving exercise-related information from a web-enabled wireless phone, wherein the exercise-related information includes data indicating a physiologic status of a subject and data indicating an amount of exercise performed by the subject, and wherein the data indicating a physiologic status of a subject is received at least partially while the subject is exercising;
  - b. calculating a response based on the exercise-related information;
  - c. transmitting the calculated response to the web-enabled wireless phone.
  
9. (Previously Presented) The medium of claim 8, wherein the method further comprises:
  - a. enabling the web-enabled wireless phone to receive exercise-related information from a device; and

Serial No.: 12/211,033  
Examiner Shirley Xueying Jian  
Group Art Unit 3769  
Page 4 of 7

b. transmitting to the web-enabled wireless phone a device application including a user interface on which the calculated response may be rendered.

10. (Previously Presented) The medium of claim 8, wherein the calculating a response includes calculating a response to assist a person in monitoring calorie expenditure, losing weight, or maintaining a healthy lifestyle.

11. (Previously Presented) The medium of claim 8, wherein the instructions further cause the web-enabled wireless phone to receive the exercise-related information via an adapter, the adapter to convert a received data signal to a suitable input for the web-enabled wireless phone.

12. (Previously Presented) The medium of claim 8, wherein the data indicating an amount of exercise performed by the subject is received from a device which is selected from the group consisting of: a pedometer, a treadmill, a stepper, an exercise cycle, an accelerometer, a rowing machine, physiotherapy equipment, an aerobic or anaerobic exercise device, and a device that monitors an amount of work or rate of work performed.

13. (Previously Presented) The medium of claim 8, wherein the receiving exercise-related information includes receiving exercise-related information over a wireless or a wired connection.

14. (Previously Presented) A web-enabled wireless phone, containing a computer-readable medium, the computer-readable medium comprising memory within a web-enabled wireless phone, the computer-readable medium comprising instructions for causing a processor in the web-enabled wireless phone to perform the method of claim 1.

15. (Previously Presented) A computer-readable medium, the computer-readable medium comprising memory within a web-enabled wireless phone, the computer-

Serial No.: 12/211,033  
Examiner Shirley Xueying Jian  
Group Art Unit 3769  
Page 5 of 7

readable medium containing instructions for causing a processor in a web-enabled wireless phone to perform the method of claim 1.

16. (Previously Presented) The method of claim 1, further comprising downloading the application to the web-enabled wireless phone from a server.

17. (Previously Presented) The method of claim 4, wherein the wireless connection includes an infrared connection or a radio frequency communication protocol including a short-range wireless transmission scheme.

18. (Previously Presented) The method of claim 4, wherein the wired connection includes a USB connection, a cable, or a docking station.

19. (Currently Amended) The method of claim 17, wherein the short-range wireless transmission scheme includes 802.11 or ~~802.15~~ Bluetooth®.

20. (Previously Presented) The method of claim 1, wherein the data indicating a physiologic status of a subject is received from a device selected from the group consisting of: a heart rate monitor, a blood pressure monitor, a body temperature monitor, a respiratory monitor, a biofeedback device, an electronic body weight scale, and a body fat gauge.

21. (Previously Presented) The medium of claim 8, wherein the data indicating a physiologic status of a subject is received from a device which is selected from the group consisting of: a heart rate monitor, a blood pressure monitor, a body temperature monitor, a respiratory monitor, a biofeedback device, an electronic body weight scale, and a body fat gauge.

Serial No.: 12/211,033  
Examiner Shirley Xueying Jian  
Group Art Unit 3769  
Page 6 of 7

## REMARKS

### Status of the Claims

Claims 1-4 and 6-21 are pending in the application. Claim 5 has been previously cancelled. Claims 1, 8, 14, and 15 are the independent claims. Claim 19 has been amended.

### General Remarks

Applicant notes the removal of certain objections and rejections due to Applicant's prior response. Applicant requests reconsideration of the remaining claims in light of the arguments provided below.

### Finality of Rejections

Applicant notes that the Examiner has made the current Office Action final as follows:

Applicant's amendment necessitated the new ground(s) of rejection presented in this Office action. Accordingly, **THIS ACTION IS MADE FINAL**. See MPEP § 706.07(a).

Applicant is reminded of the extension of time policy as set forth in 37 CFR 1.136(a).

For the record, Applicant has reproduced a portion of this section of the MPEP below:

#### **706.07(a) Final Rejection, When Proper on Second Action [R-6]**

Due to the change in practice as affecting final rejections, older decisions on questions of prematureness of final rejection or admission of subsequent amendments do not necessarily reflect present practice.

Under present practice, second or any subsequent actions on the merits shall be final, except where the examiner introduces a new ground of rejection that is neither necessitated by applicant's amendment of the claims, nor based on information submitted in an information disclosure statement filed during the period set forth in 37 CFR 1.97(c) with the fee set forth in 37 CFR 1.17(p).

Serial No.: 12/211,033  
Examiner Shirley Xueying Jian  
Group Art Unit 3769  
Page 7 of 7

In the present case, Applicant submits the finality of the Office Action is premature for at least two reasons. First, Applicant amended the claims in a way suggested by the Examiner as discussed in the telephonic interview held between the Applicant's representative and the prior Examiner (Michael C. Astorino) on March 8, 2010:

Substance of interview including description of the general nature of what was agreed to if an agreement was reached, or any other comments: Participants discussed the previous office action including the 103, 35 U.S.C. § 101, 35 U.S.C. § 112, 35 U.S.C. § 102, and double patenting rejections. The examiner provided suggestions to obviate the rejections and overcome the applied prior art.

Applicant submits that his attempt to meet the requirements of the Examiner should not be met with a Final Office Action, and that issuance of the same is in clear contravention to the Patent Office policy of compact prosecution. The amendments were of the type suggested by the Examiner in the telephonic interview, and merely clarified in a definitional way the two types of data previously claimed, as well as when such data are monitored. For this reason alone, the finality of the rejections should be withdrawn.

Even assuming, *arguendo*, that the above were not the case, Applicant submits that the rejections ought not be rendered final for other reasons. In particular, Office Actions are improperly final where the Examiner introduces a new ground of rejection that is not necessitated by applicant's amendment of the claims. In the current case, the Examiner introduced a new prior art reference, Root, that was not necessitated by Applicant's amendments of the claims.

For these reasons, Applicants respectfully submit that the finality of the rejections should be withdrawn.

### Double Patenting Rejection

Claims 1-12 stand rejected under the judicially created doctrine of obviousness-type double patenting as being allegedly unpatentable over claims 3-6 and 33-43 of U.S. Patent No. 6,602,191. This rejection is traversed with respect to the claims as follows.

Applicant initially notes that he assumes the Examiner is referring to at least the current independent claims 1 and 8 in the current case. The recitation of claims 1-12 is confusing as there is no currently-pending claim 5. However, in the interest of compact

Serial No.: 12/211,033  
Examiner Shirley Xueying Jian  
Group Art Unit 3769  
Page 8 of 7

prosecution, Applicant will assume the Examiner is at least referring to the above-noted independent claims (and claims 14 and 15 require the limitations of claim 1).

Independent claim 1 requires, among other limitations, receiving data indicating a physiologic status of a subject and receiving data indicating an amount of exercise performed by the subject, wherein at least one of the data indicating a physiologic status of a subject or the data indicating an amount of exercise performed by the subject is received from the device which provides exercise-related information, and wherein the data indicating a physiologic status of a subject is received at least partially while the subject is exercising. Independent claim 8 includes similar limitations, although on the server side.

Claims 3-6 and 33-43 of the '191 patent contain no such limitations about two types of data being received, nor that a physiologic status is received at least partially while a subject is exercising. Nor can the same be an obvious variant. Because of limitations in processing power, memory, and display capability with mobile phones at the time of the '191 patent, one of ordinary skill in the art would not have expected that two such types of data could be received and transmitted by a mobile phone. While voice communications were abundant and some data transmission was possible, the transmission of two data types in the way claimed would not have been obvious to one of ordinary skill in the art.

With regard to dependent claims, the same include even more distinguishing limitations.

For at least these reasons, Applicant submits that the double patenting rejections of the claims should be withdrawn.

**Claim Rejection Under 35 U.S.C. 112, first paragraph**

Claim 19 is rejected under 35 U.S.C. 112, first paragraph, as failing to comply with the written description requirement. In particular:

Serial No.: 12/211,033  
Examiner Shirley Xueying Jian  
Group Art Unit 3769  
Page 9 of 7

Claim 19 is rejected under 35 U.S.C. 112, first paragraph, as failing to comply with the written description requirement. The claim(s) contains subject matter which was not described in the specification in such a way as to reasonably convey to one skilled in the relevant art that the inventor(s), at the time the application was filed, had possession of the claimed invention. The claim limitation "802.15" is new matter, not supported by the disclosure.

Applicant has amended the claim to recite Bluetooth® instead of 802.15. Support for Bluetooth® is provided in various locations in the specification, including, e.g., [0044], [0052], and [0092]. Bluetooth®, a term well-understood to one skilled in the relevant art, was used in the claims of all previous family patents included by reference. Consequently, the rejection of claim 19 on this basis should be withdrawn.

**Claim Rejections Under 35 U.S.C. 102 - Root**

Claims 1-4, 6-18 and 20-21 are rejected under 35 U.S.C. 102(e) as being anticipated by Root et al., U.S. Patent No. 6,013,007 ("Root"). Applicant respectfully traverses this rejection as follows.

Applicant first notes that Root is much like the devices disclosed by the Applicant in the Background section of the current application. See [0007] and [0010]. These generally relate to systems that employ ordinary phone lines, and which lack full back-end server functionality.

Applicant next notes that Root is not a wireless device. Root connects to a PC for downloading via a "standard telephone line" (see Figs. 7-9, 4:54-67, 5:66 – 6:41). The only communications disclosed in Root that have any wireless character at all are as follows: an AM/FM/TV radio which is only disclosed for entertainment purposes (see Fig. 1A and 4:40-48), not for wireless communications; a GPS receiver (see Figs. 2-6 and 4:4-26, 5:36-65, 7:29-50) to determine the position of the GPS antenna 301 and its current speed and direction; and, in one embodiment, an IR port 124 (Fig. 1B, 6, 7 and 6:1-2) allowing data communication between the device 101 and a local PC 701.



Serial No.: 12/211,033  
Examiner Shirley Xueying Jian  
Group Art Unit 3769  
Page 10 of 7

Consequently, and with respect to all the claims, Root is deficient as an anticipatory reference because the same lacks teaching or disclosure of, at least, coupling a web-enabled wireless phone to a device which provides exercise-related information. That is, there is no wireless character nor is there web-enablement. As noted, the "radio" mentioned by the Examiner is AM/FM/TV radio module 607 which cannot send exercise-related information as claimed. The GPS system can only receive data, time signals, allowing geolocation. That is, the wireless GPS network 204 is not pertinent to such communications since the same is only employable to transmit radio signals to device 101 to determine location (7:29-40). The IR port cannot send exercise-related information to an internet server via a wireless network either.

Regarding web-enablement, the only such aspect even potentially inferable is using an external computer via the serial or infrared port or using a remote computer via modem. But this inference would defeat the purpose of having a mobile device. Accordingly, Applicant submits that to equate these with a web-enabled wireless phone is simply not supportable, especially as the clear purpose of the claimed device is to be carried and used while exercising without being limited to the location of a PC or telephone jack [0017]. In fact, Figs. 2-3 of Root show the user exercising with no connections indicated, and Figs. 7-9 show the monitor alone being connected to a PC or to a remote computer for data storage and analysis (4:54-64).

Applicant concurs that Root discloses that an "internet web site" may be employed to present performance data (8:64 – 9:9). But again Root only discloses PC-based browsers, not web-enabled wireless phones, and thus this disclosure deficient as an anticipatory reference against the claims.

Applicant submits that the equating of the claimed web-enabled wireless device with the device 101 in combination with the PC 701/801 same runs afoul of the MPEP 2131, which states that:

**TO ANTICIPATE A CLAIM, THE REFERENCE MUST TEACH EVERY ELEMENT OF THE CLAIM**

"A claim is anticipated only if each and every element as set forth in the claim is found, either expressly or inherently described, in a single prior art reference." *Verdegaal Bros. v. Union Oil Co. of California*, 814

Serial No.: 12/211,033  
Examiner Shirley Xueying Jian  
Group Art Unit 3769  
Page 11 of 7

F.2d 628, 631, 2 USPQ2d 1051, 1053 (Fed. Cir. 1987). "The identical invention must be shown in as complete detail as is contained in the ... claim." *Richardson v. Suzuki Motor Co.*, 868 F.2d 1226, 1236, 9 USPQ2d 1913, 1920 (Fed. Cir. 1989).

In this case, Root fails to teach use of a web-enabled wireless phone or anything like it, and thus Applicants respectfully submit that the novelty rejection based on this reference should be withdrawn.

Even assuming, *arguendo*, Root taught a web-enabled wireless phone, the reference is deficient as an anticipatory reference for even more reasons.

For example, with respect to claims 1, 14, and 15, Root fails to teach or disclose sending exercise-related information to an internet server via a wireless network (in the case of claim 8, receiving such information). Many of the ways in which this limitation is lacking in Root are analogous to the arguments above. In particular, Root discloses two ways of having their device 101 communicate with a PC 701/801. In one way, the reference employs an RJ-11 type telephone port 113 which connects an internal modem 613 via a standard telephone line to a remote computer 801, which is connected to the internet 803 by a modem bank 802 (Fig. 8 and 4:60-63 and 8:58-65). In the other way, the device 101 is connected to a PC 701 directly via a serial-type port 118 or an IR-type port 124 (Fig. 7 and 5:66 - 6:2). The PC 701 is then connected to the internet 803 via a modem 902 and standard telephone lines (Fig. 9 and 6:29-34). Notably, Root discloses other forms of communication too - but even where Root discloses these other forms, none of them are disclosed to be wireless (6:32-34).

Applicant submits that even if the PC were able to connect wirelessly, the reference would still be deficient as anticipatory because the device 101 is incapable of wireless communications to the internet in the absence of a PC (and such communications are clearly not the purpose of the IR port 124). The purpose of the invention would be completely defeated in this case, and thus such a reading would be impermissible.

The Root reference clearly is for storing data about exercise and then uploading the same at a later time via a standard telephone line, which is far different from real-time

Serial No.: 12/211,033  
Examiner Shirley Xueying Jian  
Group Art Unit 3769  
Page 12 of 7

monitoring of exercise and physiological data and real-time uploading of the same via a web-enabled wireless phone, thus enabling the user to be free from being limited only to the location of a PC or telephone jack. So for this reason as well, Applicant submits the rejections of the independent claims should be withdrawn.

Even assuming, *arguendo*, Root was not deficient on this basis, the reference is deficient as an anticipatory reference for even more reasons.

For example, with respect to claim 1, 14, and 15, Root fails to teach receiving a calculated response from a server (with respect to claim 8, calculating a response and transmitting such a calculated response). Rather, what is termed a calculated response by the Examiner is actually a compiling of multiple users' data for purposes of marketing or the like. Information is sent to an Internet web site (8:64 – 9:9). The same is nowhere disclosed to be received by the web-enabled wireless phone since the Root device is not a proper forum for this information. The promotional or other such information appears to be sent to a user's computer, not the device carried or worn by a user. Applicant concurs that a subject may listen to such promotional items such as audio targeted advertising on the device 101, but only after the same has been downloaded to a computer 701/801 and transferred (9:21-30).

The reference is further deficient because no calculated response could conceivably be received, at least not one associated with a calculation based on the exercise-related information, since exercise-related information is not sent to an internet server during the time of exercise. In other words, data indicating an amount of exercise performed by the subject may be received in Root because of the GPS connection, but the same could not be sent to an internet server and a response received based on the sent data. The same is true of data indicating a physiologic status of a subject. In both cases, the same is only disclosed to be uploaded later via a standard telephone line, and consequently is not disclosed to be used in a calculated response to a web-enabled wireless device.

Even where Root discloses communicating other sorts of information to a subject, the same are not calculated responses from a server, but rather locally-derived information such as pre-set targets input by the subject.

Serial No.: 12/211,033  
Examiner Shirley Xueying Jian  
Group Art Unit 3769  
Page 13 of 7

For all of these reasons as well, Applicant submits the rejections of the independent claims should be withdrawn.

The dependent claims are allowable for even more reasons. For example, with regard to claims 9 and 16, Root fails to disclose downloading applications to a web-enabled wireless phone from a server. Root fails to disclose adaptors, as required by claims 6 and 11. As Root fails to disclose web-enabled wireless phones, the reference is deficient in anticipating claims 14 and 15, which are directed to these.

**Claim Rejection Under 35 U.S.C. 103 - Root**

Claim 19 is rejected under 35 U.S.C. 103(a), as being unpatentable over Root as applied to claim 1 above. Applicant respectfully traverses this rejection.

Claim 19 refers to types of short-range wireless transmission schemes by which the web-enabled wireless phone receives exercise-related information, notably 802.11 or Bluetooth®. Root receives this information in device 101 in only one way that is wireless: GPS, which is in no way a short-range wireless transmission scheme. Root receives this information in device 101 in other ways, but they are all wired communications. It is true that Root discloses an IR port, but the same is for communications between the device 101 and the PC 701/801, not for transmitting data to the device 101. Since any structure or disclosure necessary to meet the claim limitation is lacking in Root, it cannot be obvious to include a Bluetooth® or 802.11 port as a means of receiving such exercise data, e.g., from physiological sensors or from exercise machines.

Serial No.: 12/211,033  
Examiner Shirley Xueying Jian  
Group Art Unit 3769  
Page 14 of 7

**Conclusion**

Should the Examiner be of the view that an interview would expedite consideration of the application, request is made that the Examiner telephone the Applicants' attorney at (703) 433-0510 in order that any outstanding issues be resolved.

Respectfully submitted,

Dated: \_September 20, 2010  
Attorney for Applicant  
Mayer & Williams, PC  
251 North Avenue West, 2<sup>nd</sup> Floor  
Westfield, NJ 07090  
Tel.: 703-433-0510  
Fax: 703-433-2362

/Mark Wiczorek/  
Mark D. Wiczorek  
Registration No. 37,966

**Electronic Acknowledgement Receipt**

<b>EFS ID:</b>	8458681
<b>Application Number:</b>	12211033
<b>International Application Number:</b>	
<b>Confirmation Number:</b>	7693
<b>Title of Invention:</b>	METHOD AND APPARATUS FOR MONITORING EXERCISE WITH WIRELESS INTERNET CONNECTIVITY
<b>First Named Inventor/Applicant Name:</b>	Roger J. Quy
<b>Customer Number:</b>	27774
<b>Filer:</b>	David B. Bonham/Nancy Joyce Simmons
<b>Filer Authorized By:</b>	David B. Bonham
<b>Attorney Docket Number:</b>	00125/002005
<b>Receipt Date:</b>	20-SEP-2010
<b>Filing Date:</b>	15-SEP-2008
<b>Time Stamp:</b>	22:10:37
<b>Application Type:</b>	Utility under 35 USC 111(a)

**Payment information:**

Submitted with Payment	no
------------------------	----

**File Listing:**

Document Number	Document Description	File Name	File Size(Bytes)/ Message Digest	Multi Part /.zip	Pages (if appl.)
1		00125-002005-Amendment-AF-08-13-2010.pdf	254227 276c7d18926ce843468ec49d8ade64955a03cbd7	yes	14

## Multipart Description/PDF files in .zip description

Document Description	Start	End
Amendment After Final	1	1
Claims	2	5
Applicant Arguments/Remarks Made in an Amendment	6	14

**Warnings:****Information:****Total Files Size (in bytes):**

254227

This Acknowledgement Receipt evidences receipt on the noted date by the USPTO of the indicated documents, characterized by the applicant, and including page counts, where applicable. It serves as evidence of receipt similar to a Post Card, as described in MPEP 503.

**New Applications Under 35 U.S.C. 111**

If a new application is being filed and the application includes the necessary components for a filing date (see 37 CFR 1.53(b)-(d) and MPEP 506), a Filing Receipt (37 CFR 1.54) will be issued in due course and the date shown on this Acknowledgement Receipt will establish the filing date of the application.

**National Stage of an International Application under 35 U.S.C. 371**

If a timely submission to enter the national stage of an international application is compliant with the conditions of 35 U.S.C. 371 and other applicable requirements a Form PCT/DO/EO/903 indicating acceptance of the application as a national stage submission under 35 U.S.C. 371 will be issued in addition to the Filing Receipt, in due course.

**New International Application Filed with the USPTO as a Receiving Office**

If a new international application is being filed and the international application includes the necessary components for an international filing date (see PCT Article 11 and MPEP 1810), a Notification of the International Application Number and of the International Filing Date (Form PCT/RO/105) will be issued in due course, subject to prescriptions concerning national security, and the date shown on this Acknowledgement Receipt will establish the international filing date of the application.

Under the Paperwork Reduction Act of 1995, no persons are required to respond to a collection of information unless it displays a valid OMB control number.

<b>PATENT APPLICATION FEE DETERMINATION RECORD</b> Substitute for Form PTO-875					Application or Docket Number <b>12/211,033</b>		Filing Date <b>09/15/2008</b>		<input type="checkbox"/> To be Mailed			
<b>APPLICATION AS FILED – PART I</b>					SMALL ENTITY <input checked="" type="checkbox"/>		OR		OTHER THAN SMALL ENTITY			
(Column 1)		(Column 2)										
FOR	NUMBER FILED	NUMBER EXTRA			RATE (\$)	FEE (\$)			RATE (\$)	FEE (\$)		
<input type="checkbox"/> BASIC FEE <small>(37 CFR 1.16(a), (b), or (c))</small>	N/A	N/A			N/A				N/A			
<input type="checkbox"/> SEARCH FEE <small>(37 CFR 1.16(k), (l), or (m))</small>	N/A	N/A			N/A				N/A			
<input type="checkbox"/> EXAMINATION FEE <small>(37 CFR 1.16(o), (p), or (q))</small>	N/A	N/A			N/A				N/A			
TOTAL CLAIMS <small>(37 CFR 1.16(i))</small>	minus 20 =	*			X \$ =		OR		X \$ =			
INDEPENDENT CLAIMS <small>(37 CFR 1.16(h))</small>	minus 3 =	*			X \$ =				X \$ =			
<input type="checkbox"/> APPLICATION SIZE FEE <small>(37 CFR 1.16(s))</small>	If the specification and drawings exceed 100 sheets of paper, the application size fee due is \$250 (\$125 for small entity) for each additional 50 sheets or fraction thereof. See 35 U.S.C. 41(a)(1)(G) and 37 CFR 1.16(s).											
<input type="checkbox"/> MULTIPLE DEPENDENT CLAIM PRESENT <small>(37 CFR 1.16(j))</small>												
* If the difference in column 1 is less than zero, enter "0" in column 2.					TOTAL				TOTAL			
<b>APPLICATION AS AMENDED – PART II</b>					SMALL ENTITY		OR		OTHER THAN SMALL ENTITY			
(Column 1)		(Column 2)		(Column 3)								
<b>AMENDMENT</b>	<b>09/20/2010</b>	CLAIMS REMAINING AFTER AMENDMENT		HIGHEST NUMBER PREVIOUSLY PAID FOR	PRESENT EXTRA	RATE (\$)	ADDITIONAL FEE (\$)			RATE (\$)	ADDITIONAL FEE (\$)	
	Total <small>(37 CFR 1.16(i))</small>	* 20	Minus	** 20	= 0	X \$26 =	0	OR		X \$ =		
	Independent <small>(37 CFR 1.16(h))</small>	* 2	Minus	***3	= 0	X \$110 =	0	OR		X \$ =		
	<input type="checkbox"/> Application Size Fee <small>(37 CFR 1.16(s))</small>											
	<input type="checkbox"/> FIRST PRESENTATION OF MULTIPLE DEPENDENT CLAIM <small>(37 CFR 1.16(j))</small>											
					TOTAL ADD'L FEE		<b>0</b>		OR		TOTAL ADD'L FEE	
<b>AMENDMENT</b>		CLAIMS REMAINING AFTER AMENDMENT		HIGHEST NUMBER PREVIOUSLY PAID FOR	PRESENT EXTRA	RATE (\$)	ADDITIONAL FEE (\$)			RATE (\$)	ADDITIONAL FEE (\$)	
	Total <small>(37 CFR 1.16(i))</small>	*	Minus	**	=	X \$ =		OR		X \$ =		
	Independent <small>(37 CFR 1.16(h))</small>	*	Minus	***	=	X \$ =		OR		X \$ =		
	<input type="checkbox"/> Application Size Fee <small>(37 CFR 1.16(s))</small>											
	<input type="checkbox"/> FIRST PRESENTATION OF MULTIPLE DEPENDENT CLAIM <small>(37 CFR 1.16(j))</small>											
					TOTAL ADD'L FEE				OR		TOTAL ADD'L FEE	
* If the entry in column 1 is less than the entry in column 2, write "0" in column 3.					Legal Instrument Examiner: /DAWN BREWER/							
** If the "Highest Number Previously Paid For" IN THIS SPACE is less than 20, enter "20".												
*** If the "Highest Number Previously Paid For" IN THIS SPACE is less than 3, enter "3".												
The "Highest Number Previously Paid For" (Total or Independent) is the highest number found in the appropriate box in column 1.												

This collection of information is required by 37 CFR 1.16. The information is required to obtain or retain a benefit by the public which is to file (and by the USPTO to process) an application. Confidentiality is governed by 35 U.S.C. 122 and 37 CFR 1.14. This collection is estimated to take 12 minutes to complete, including gathering, preparing, and submitting the completed application form to the USPTO. Time will vary depending upon the individual case. Any comments on the amount of time you require to complete this form and/or suggestions for reducing this burden, should be sent to the Chief Information Officer, U.S. Patent and Trademark Office, U.S. Department of Commerce, P.O. Box 1450, Alexandria, VA 22313-1450. DO NOT SEND FEES OR COMPLETED FORMS TO THIS ADDRESS. **SEND TO: Commissioner for Patents, P.O. Box 1450, Alexandria, VA 22313-1450.**

*If you need assistance in completing the form, call 1-800-PTO-9199 and select option 2.*





UNITED STATES PATENT AND TRADEMARK OFFICE

UNITED STATES DEPARTMENT OF COMMERCE  
 United States Patent and Trademark Office  
 Address: COMMISSIONER FOR PATENTS  
 P.O. Box 1450  
 Alexandria, Virginia 22313-1450  
 www.uspto.gov

APPLICATION NO.	FILING DATE	FIRST NAMED INVENTOR	ATTORNEY DOCKET NO.	CONFIRMATION NO.
12/211,033	09/15/2008	Roger J. Quy	00125/002005	7693
2774	7590	10/04/2010	EXAMINER JIAN, SHIRLEY XUEYING	
MAYER & WILLIAMS PC 251 NORTH AVENUE WEST 2ND FLOOR WESTFIELD, NJ 07090			ART UNIT	PAPER NUMBER
			3769	
			MAIL DATE	DELIVERY MODE
			10/04/2010	PAPER

**Please find below and/or attached an Office communication concerning this application or proceeding.**

The time period for reply, if any, is set in the attached communication.

<b>Advisory Action Before the Filing of an Appeal Brief</b>	<b>Application No.</b> 12/211,033	<b>Applicant(s)</b> QUY, ROGER J.	
	<b>Examiner</b> SHIRLEY JIAN	<b>Art Unit</b> 3769	

**--The MAILING DATE of this communication appears on the cover sheet with the correspondence address --**

THE REPLY FILED 20 September 2010 FAILS TO PLACE THIS APPLICATION IN CONDITION FOR ALLOWANCE.

1.  The reply was filed after a final rejection, but prior to or on the same day as filing a Notice of Appeal. To avoid abandonment of this application, applicant must timely file one of the following replies: (1) an amendment, affidavit, or other evidence, which places the application in condition for allowance; (2) a Notice of Appeal (with appeal fee) in compliance with 37 CFR 41.31; or (3) a Request for Continued Examination (RCE) in compliance with 37 CFR 1.114. The reply must be filed within one of the following time periods:

- a)  The period for reply expires \_\_\_\_\_ months from the mailing date of the final rejection.  
b)  The period for reply expires on: (1) the mailing date of this Advisory Action, or (2) the date set forth in the final rejection, whichever is later. In no event, however, will the statutory period for reply expire later than SIX MONTHS from the mailing date of the final rejection.  
Examiner Note: If box 1 is checked, check either box (a) or (b). ONLY CHECK BOX (b) WHEN THE FIRST REPLY WAS FILED WITHIN TWO MONTHS OF THE FINAL REJECTION. See MPEP 706.07(f).

Extensions of time may be obtained under 37 CFR 1.136(a). The date on which the petition under 37 CFR 1.136(a) and the appropriate extension fee have been filed is the date for purposes of determining the period of extension and the corresponding amount of the fee. The appropriate extension fee under 37 CFR 1.17(a) is calculated from: (1) the expiration date of the shortened statutory period for reply originally set in the final Office action; or (2) as set forth in (b) above, if checked. Any reply received by the Office later than three months after the mailing date of the final rejection, even if timely filed, may reduce any earned patent term adjustment. See 37 CFR 1.704(b).

**NOTICE OF APPEAL**

2.  The Notice of Appeal was filed on \_\_\_\_\_. A brief in compliance with 37 CFR 41.37 must be filed within two months of the date of filing the Notice of Appeal (37 CFR 41.37(a)), or any extension thereof (37 CFR 41.37(e)), to avoid dismissal of the appeal. Since a Notice of Appeal has been filed, any reply must be filed within the time period set forth in 37 CFR 41.37(a).

**AMENDMENTS**

3.  The proposed amendment(s) filed after a final rejection, but prior to the date of filing a brief, will not be entered because  
(a)  They raise new issues that would require further consideration and/or search (see NOTE below);  
(b)  They raise the issue of new matter (see NOTE below);  
(c)  They are not deemed to place the application in better form for appeal by materially reducing or simplifying the issues for appeal; and/or  
(d)  They present additional claims without canceling a corresponding number of finally rejected claims.

NOTE: \_\_\_\_\_. (See 37 CFR 1.116 and 41.33(a)).

4.  The amendments are not in compliance with 37 CFR 1.121. See attached Notice of Non-Compliant Amendment (PTOL-324).  
5.  Applicant's reply has overcome the following rejection(s): \_\_\_\_\_.  
6.  Newly proposed or amended claim(s) \_\_\_\_\_ would be allowable if submitted in a separate, timely filed amendment canceling the non-allowable claim(s).  
7.  For purposes of appeal, the proposed amendment(s): a)  will not be entered, or b)  will be entered and an explanation of how the new or amended claims would be rejected is provided below or appended.  
The status of the claim(s) is (or will be) as follows:  
Claim(s) allowed: \_\_\_\_\_.  
Claim(s) objected to: \_\_\_\_\_.  
Claim(s) rejected: 1-4 and 6-21.  
Claim(s) withdrawn from consideration: \_\_\_\_\_.

**AFFIDAVIT OR OTHER EVIDENCE**

8.  The affidavit or other evidence filed after a final action, but before or on the date of filing a Notice of Appeal will not be entered because applicant failed to provide a showing of good and sufficient reasons why the affidavit or other evidence is necessary and was not earlier presented. See 37 CFR 1.116(e).  
9.  The affidavit or other evidence filed after the date of filing a Notice of Appeal, but prior to the date of filing a brief, will not be entered because the affidavit or other evidence failed to overcome all rejections under appeal and/or appellant fails to provide a showing of good and sufficient reasons why it is necessary and was not earlier presented. See 37 CFR 41.33(d)(1).  
10.  The affidavit or other evidence is entered. An explanation of the status of the claims after entry is below or attached.

**REQUEST FOR RECONSIDERATION/OTHER**

11.  The request for reconsideration has been considered but does NOT place the application in condition for allowance because:  
See Continuation Sheet.  
12.  Note the attached Information *Disclosure Statement(s)*. (PTO/SB/08) Paper No(s). \_\_\_\_\_  
13.  Other: \_\_\_\_\_.

/Henry M. Johnson, III/  
Supervisory Patent Examiner, Art Unit 3769

/SHIRLEY JIAN/  
Examiner, Art Unit 3769

Continuation of 11. does NOT place the application in condition for allowance because: The Applicant argues that claim amendments are based on Examiner Astorino's suggestions to clarify the claims and therefore deems the finality of the last office action premature. Although the limitations were suggested by an Examiner, this does not change the fact that the newly added limitations have altered the Examiner's interpretation of the claims which necessitated the introduction of a new prior art Root. As such, the finality of the office action dated August 13, 2010 was proper. The Examiner thanks the Applicant in pointing out that claim 5 was cancelled and should not be rejected under the obviousness type double patenting rejection. However, the Applicants arguments have been fully considered and are not persuasive, claims 1-4 and 6-12 stand rejected. With regard to the 35 USC 102 rejections, the Examiner respectfully disagrees that Root fails to teach a wireless device. As pointed out by the Applicant, Root's device has wireless characteristics including an IR port for communication between the device and a local PC (Arguments pg. 9); as such, it satisfies the claim limitation which requires the coupling a web-enabled wireless phone to a device which provides exercise-related information. The Examiner broadly interprets any device with wireless capability as a wireless device. The Applicant is reminded that claims must not contain trademarks (see claim 19).

Serial No.: 12/211,033  
Examiner Shirley Xueying Jian  
Group Art Unit 3769  
Page 1 of 7

**IN THE UNITED STATES PATENT AND TRADEMARK OFFICE**

Applicants:	Roger J. Quy
Application No.	12/211,033
Filed:	September 15, 2008
Title:	METHOD AND APPARATUS FOR MONITORING EXERCISE WITH WIRELESS INTERNET CONNECTIVITY
Art Unit:	3769
Examiner:	Shirley Jian
Confirm. No.:	7693
Docket No.:	00125/002005

Via EFS Web  
Commissioner for Patents  
P.O. Box 1450  
Alexandria, VA 22313-1450

<p>Certificate of Electronic Transmission Under 37 C.F.R. §1.8</p> <p>I hereby certify that this correspondence and any document referenced herein are being electronically filed with the USPTO via EFS-Web on September 20, 2010</p> <p style="text-align: center;"><u>Nancy Joyce Simmons</u> (Printed Name of Person Sending Correspondence)</p> <p style="text-align: center;"><u>/nancy joyce simmons/</u> (Signature)</p>
--

Sir:

**AMENDMENT AND RESPONSE TO FINAL OFFICE ACTION**

This is responsive to the Office Action mailed August 13, 2010 in the above matter, in which the rejections of the claims was made final. A response is due November 13, 2010, and thus this Amendment and Response is timely filed.

No fees are believed to be due. Any fees deemed to be due or credit for any overpayment for this application should be directed to Deposit Account Number 50-1047 and authorization is hereby given to charge such account.

Please enter the following remarks:

**Amendments** begin on page 2.

**Remarks/Arguments** begin on page 6.

Doc Code: AP.PRE.REQ

PTO/SB/33 (12-08)

Approved for use through 07/31/2012. OMB 0651-00xx  
 U.S. Patent and Trademark Office; U.S. DEPARTMENT OF COMMERCE

Under the Paperwork Reduction Act of 1995, no persons are required to respond to a collection of information unless it displays a valid OMB control number.

<b>PRE-APPEAL BRIEF REQUEST FOR REVIEW</b>		Docket Number (Optional) 00125/002005									
<p style="text-align: center;">Certificate of Electronic Transmission                  Under 37 C.F.R. §1.8</p> <p>I hereby certify that this correspondence and any document referenced herein are being electronically filed with the USPTO via EFS-Web on November 15, 2010</p> <p style="text-align: center;"><u>Michelle Wolf</u>                  (Printed Name of Person Sending Correspondence)</p> <p style="text-align: center;"><u>Michelle Wolf/</u>                  (Signature)</p>	Application Number 12/211,033		Filed September 15, 2008								
	First Named Inventor Roger J. Quy										
	Art Unit 3769		Examiner Michael C. Astorino								
<p>Applicant requests review of the final rejection in the above-identified application. No amendments are being filed with this request.</p> <p>This request is being filed with a notice of appeal.</p> <p>The review is requested for the reason(s) stated on the attached sheet(s).                  Note: No more than five (5) pages may be provided.</p> <p>I am the</p> <table style="width: 100%; border: none;"> <tr> <td style="width: 60%;"><input type="checkbox"/> applicant /inventor.</td> <td style="width: 40%; text-align: center;">_____ /Mark Wieczorek/ Signature</td> </tr> <tr> <td><input type="checkbox"/> assignee of record of the entire interest. See 37 CFR 3.71. Statement under 37 CFR 3.73(b) is enclosed. (Form PTO/SB/96)</td> <td style="text-align: center;">_____ Mark D. Wieczorek Typed or printed name</td> </tr> <tr> <td><input checked="" type="checkbox"/> attorney or agent of record. Registration number <u>37,966</u></td> <td style="text-align: center;">_____ 619-818-4615 Telephone number</td> </tr> <tr> <td><input type="checkbox"/> attorney or agent acting under 37 CFR 1.34. Registration number if acting under 37 CFR 1.34. _____</td> <td style="text-align: center;">_____ November 15, 2010 Date</td> </tr> </table> <p>NOTE: Signatures of all the inventors or assignees of record of the entire interest or their representative(s) are required. Submit multiple forms if more than one signature is required, see below*.</p>				<input type="checkbox"/> applicant /inventor.	_____ /Mark Wieczorek/ Signature	<input type="checkbox"/> assignee of record of the entire interest. See 37 CFR 3.71. Statement under 37 CFR 3.73(b) is enclosed. (Form PTO/SB/96)	_____ Mark D. Wieczorek Typed or printed name	<input checked="" type="checkbox"/> attorney or agent of record. Registration number <u>37,966</u>	_____ 619-818-4615 Telephone number	<input type="checkbox"/> attorney or agent acting under 37 CFR 1.34. Registration number if acting under 37 CFR 1.34. _____	_____ November 15, 2010 Date
<input type="checkbox"/> applicant /inventor.	_____ /Mark Wieczorek/ Signature										
<input type="checkbox"/> assignee of record of the entire interest. See 37 CFR 3.71. Statement under 37 CFR 3.73(b) is enclosed. (Form PTO/SB/96)	_____ Mark D. Wieczorek Typed or printed name										
<input checked="" type="checkbox"/> attorney or agent of record. Registration number <u>37,966</u>	_____ 619-818-4615 Telephone number										
<input type="checkbox"/> attorney or agent acting under 37 CFR 1.34. Registration number if acting under 37 CFR 1.34. _____	_____ November 15, 2010 Date										
<input checked="" type="checkbox"/> *Total of <u>1</u> forms are submitted.											

Serial No.: 12/211,033  
Examiner Shirley Xueying Jian, Group Art Unit 3769  
Page 1 of 5

**REASONS FOR REQUESTING PRE-APPELLATE REVIEW**

The Claim Rejections under 35 USC §102

Claims 1-4, 6-18 and 20-21 stand rejected under 35 U.S.C. 102(e) as being anticipated by Root et al., U.S. Patent No. 6,013,007 (“Root”). Applicant submits that the Examiner’s rejections were clearly erroneous at least because the reference fails to disclose a wireless phone as a means to wirelessly transmit exercise/physiologic data to an internet server. Root also fails to disclose receiving a calculated response, the calculation based on the exercise/physiologic data, and displaying the response. In making these submissions, Applicant cites MPEP 2131, which notes that “to anticipate a claim, the reference must teach every element of the claim”. The reference fails to do this, and thus the rejections are erroneous.

The Examiner interpreted “the remote device 101 as a web-enabled wireless phone because it has an internal modem for connecting to the internet and connecting to a telephone line.” Office Action of 8/13/10 at page 4, emphasis added. The interpretation of this claim element (which appears in all the independent claims) is clearly erroneous. The disclosed internal modem 613 and telephone line with jack 113 do not configure the remote device 101 as a wireless phone, and are not ways to connect to wireless networks (also required by the independent claims, e.g., claim 1, element (f)), and are at most ways to connect to standard landline networks. See 4:60-67. The only wireless ways of communicating in the Root system are the disclosed GPS satellite receiver (4:4-26), the AM/FM/TV receiver (4:40-48), and the IR port 124 (6:2). The GPS and AM/FM/TV receivers clearly cannot meet the claim limitation of sending exercise-related information to an internet server via a wireless network; rather, they are merely passive receivers of radio wave signals.

Similarly, the IR port 124, while at least potentially capable of transmitting data, clearly cannot anticipate a claim limitation of sending exercise data to an internet server via a wireless network, as alleged by the Examiner in the comments on the Advisory Action (continuation sheet of PTO-33). The Examiner provides no indication of how such an IR port renders the device as a wireless phone, any more than how the presumed complementary IR port on the PC would render the PC a wireless phone. Moreover, the Examiner’s interpretation of the IR port 124 would lead to other missing elements. In this analogy, the remote device 101 in Root would be identified as the claimed wireless phone, and the PC in Root would be identified as the device which provides exercise-

Serial No.: 12/211,033

Examiner Shirley Xueying Jian, Group Art Unit 3769

Page 2 of 5

related information. But this interpretation fails: the PC in Root does not provide exercise-related information: rather, the PC is only disclosed to upload data from an exercise session for storage and trend analysis, or to download waypoints and preferences to configure the remote device. See 2:30-33, 3:47-50, 4:54-59, and 8:52-57. Thus, the interpretation is untenable.

Applicant further submits that the Examiner's attempt to expand the meaning of the term "wireless phone" to "any device with wireless capability" (see Advisory Action, continuation sheet of PTO-33) is overly broad; the extreme weight of industry usage gives a particular meaning to the term as a device that uses mobile telecommunication cellular network technologies to transfer data, this meaning is entirely consistent with Applicant's usage. It is clearly erroneous, running afoul of MPEP 2131, to ignore this usage.

With respect to claims 1, 14, and 15, Root also fails to teach receiving a calculated response (with respect to claim 8, calculating a response and transmitting such a calculated response to the web-enabled wireless phone), the calculation based on the exercise/physiologic data, and displaying the response. Root discloses various data trending and review aspects. For example, the user can set a course and have course changes indicated by the remote device (8:1-4). The remote device can provide feedback on athletic performance (8:17-22); however, and notably, the remote device does not access an internet server to provide such feedback. Once the remote device 101 has transferred data to the PC 701, historical trending may be displayed, but the display is on the PC 701, not on the remote device 101 (8:52-57) as claimed by Applicant.

Root also discloses that a remote computer 801 may be employed for this purpose, the remote computer 801 having received the data "via a standard telephone line" (8:58-64). The remote computer 801 may then combine multiple users' data and present the data on a user-accessible internet web site (8:64 – 9:9). However, the internet web site is also clearly distinct from the remote device 101, and the web site is never disclosed to be received and displayed on the same. In fact the remote device 101 is never disclosed to have any sort of capability of displaying user performance data. Thus, Applicant submits that the Examiner has misapplied the reference when alleging that the Root remote device is capable of "receiving feedback from said website regarding personal fitness recommendations and data trending" (Final Office Action, page 5). Correctly applied, the Root device is incapable of satisfying the requirement of the instant claims that the calculated response is received and displayed by the wireless phone.

Serial No.: 12/211,033

Examiner Shirley Xueying Jian, Group Art Unit 3769

Page 3 of 5

Despite this, Applicant concurs that some data from a server may be delivered to the Root remote device. However, this data is not a calculated response based on the exercise/physiologic data. Rather, what is termed a “calculated response” by the Examiner (Office Action of 8/13/10, page 5) is actually “[g]eographically and demographically targeted messages” relating to advertising (9:21-30), and not a calculated response based on the exercise/physiologic data.

In summary, the rejections of the claims based on Root are clearly erroneous because the reference fails to disclose a wireless phone as a means to wirelessly transmit exercise/physiologic data to an internet server by means of a wireless network, and further fails to teach receiving and displaying a calculated response (with respect to claim 8, calculating a response and transmitting such a calculated response for display to the web-enabled wireless phone), where the calculation is based on the exercise/physiologic data, nor does Root teach displaying the response. Even where Root teaches playback to a user, the same is directed to audio related to advertising. For at least these reasons, the claim rejections under 35 USC §102 should be withdrawn as clearly erroneous.

#### The Claim Rejections under Obviousness-Type Double Patenting

The Examiner has rejected Claims 1-4 and 6-12 under the judicially-created doctrine of obviousness-type double patenting as being allegedly unpatentable over claims 3-6 and 33-43 of U.S. Patent No. 6,602,191. In particular, the Examiner has stated that “the claims of the instant application are merely different renditions of the patented method and computer readable medium.” (Office Action of August 13, 2010, page 3, emphasis added).

Applicant submits that this conclusion is erroneous and not supported by the actual text of the claims. Instant claim 1 requires, among other limitations, receiving data indicating a physiologic status of a subject and receiving data indicating an amount of exercise performed by the subject, where at least one of the data indicating a physiologic status of a subject or the data indicating an amount of exercise performed by the subject is received from the device which provides exercise-related information, and wherein the data indicating a physiologic status of a subject is received at least partially while the subject is exercising. Independent claim 8 includes similar limitations, although on the server side.

Claims 3-6 and 33-43 of the ‘191 patent contain no such limitations about two types of data being received, nor that a physiologic status is received at least partially while a subject is exercising.



Serial No.: 12/211,033

Examiner Shirley Xueying Jian, Group Art Unit 3769

Page 4 of 5

Rather, the same states only that a health parameter signal is received, the same corresponding to a health, fitness, nutrition, or exercise state or condition of a patient. At most, the cited claim 37 of USP 6,602,191 relates to supplemental health data, but the same is not defined as in the instant claims, nor is the timing of reception of such supplemental health data specified.

Regarding obviousness and double patenting, the Office is reminded of the requirements of MPEP 804.II.B.1, requiring comparison for purposes of obviousness to be made between the instant claims and the patented claims, not the specification of the patent. Moreover, as specified in the above MPEP section, the analysis follows the standard Graham formula. Because of limitations in processing power, memory, and display capability with mobile phones at the time of the '191 patent, and despite the ubiquity of voice communications and even a certain level of data transmission, one of ordinary skill in the art would not have expected that two such types of data could be received and transmitted by a mobile phone given the '191 claims. Therefore, the instant claims are clearly nonobvious over the patented claims. For at least these reasons, Applicant submits that the double patenting rejections of the claims were clearly erroneous and should be withdrawn.

#### The Claim Rejection under 35 USC §112

Applicant next submits that the rejection of claim 19 on new matter grounds is clearly erroneous.<sup>1</sup> First, Applicant notes that the term “Bluetooth®” is provided in various locations in the specification, including, e.g., [0044], [0052], and [0092]. Bluetooth®, a term well-understood to one skilled in the relevant art, was used in the claims of previous family patents.<sup>2</sup> Next, Applicant cites MPEP 2173.05(u) and 608.01(v) for their teachings that trademarks are permissible in patent applications, even in claims, so long as they are properly used. In the present case, both 802.15 and Bluetooth® are not used generically but in reference to a particular short-range wireless transmission scheme. Finally, Applicant notes that the recitation of the 802.15 scheme is

---

<sup>1</sup> In the last amendment, Applicant replaced the term “802.15” with “Bluetooth®” in reference to a short-range wireless transmission scheme, so as to obviate a new matter rejection. That amendment was not entered. Here, Applicant reiterates his argument that 802.15 is not new matter. Applicant additionally notes that the prior Examiner had suggested changing “Bluetooth®” to “short range wireless transmission scheme”. Applicant made this change, but inserted “Bluetooth®” in a dependent claim to further specify the transmission scheme (along with “802.11”), these transmission schemes fully disclosed in the specification. To parallel the use of the standard “802.11”, Applicant replaced the “Bluetooth®” term with its ratified standard, “802.15”.

<sup>2</sup> See, e.g., 7,156,809. And as of October 26, 2010, the term appears in the claims of over 2300 patents issued by the USPTO.

Serial No.: 12/211,033

Examiner Shirley Xueying Jian, Group Art Unit 3769

Page 5 of 5

unambiguously and inherently tied to the Bluetooth® scheme disclosure. To wit, the IEEE 802.15 standard is the ratification of the Bluetooth® scheme. So the inclusion of 802.15 cannot be new matter vis-a-viz the specification's inclusion of Bluetooth®. Consequently, for at least these reasons, Applicant submits that the 35 USC §112 rejection of claim 19 is clearly erroneous and should be withdrawn.

#### The Claim Rejections under 35 USC §103

Claim 19 is rejected under 35 U.S.C. 103(a), as being unpatentable over Root as applied to claim 1. Applicant submits that this rejection is clearly erroneous, at least for the following reasons.

Claim 19 refers to types of short-range wireless transmission schemes by which the web-enabled wireless phone receives exercise-related information, notably 802.11 or 802.15. Root receives this information in device 101 in only one wireless way: GPS, which is in no way a short-range wireless transmission scheme. Root receives this information in device 101 in other ways, but they are all wired communications. It is true that Root discloses an IR port, but the same is for communications between the device 101 and the PC 701/801, not for transmitting data to the device 101. See also the argument above opposing this interpretation, bridging pages 1 and 2. Since any structure or disclosure necessary to meet the claim limitation is lacking in Root, it cannot be obvious to include a 802.11 or 802.15 port as a means of receiving such exercise data, e.g., from physiological sensors or from exercise machines.

#### Other Reasons for Patentability

The Applicant has provided various other reasons for patentability in the prior responses, particularly in the Response filed September 20, 2010 at pages 9-13 ("Prior Response"). For example, with regard to claims 9 and 16, Root fails to disclose downloading applications to a web-enabled wireless phone from a server. Root fails to disclose adaptors, as required by claims 6 and 11. And as Root fails to disclose web-enabled wireless phones, the reference is deficient in anticipating claims 14 and 15, which are directed to these.

## Electronic Patent Application Fee Transmittal

<b>Application Number:</b>	12211033			
<b>Filing Date:</b>	15-Sep-2008			
<b>Title of Invention:</b>	METHOD AND APPARATUS FOR MONITORING EXERCISE WITH WIRELESS INTERNET CONNECTIVITY			
<b>First Named Inventor/Applicant Name:</b>	Roger J. Quy			
<b>Filer:</b>	Karin L. Williams/Michelle Wolf			
<b>Attorney Docket Number:</b>	00125/002005			
Filed as Large Entity				
<b>Utility under 35 USC 111(a) Filing Fees</b>				
<b>Description</b>	<b>Fee Code</b>	<b>Quantity</b>	<b>Amount</b>	<b>Sub-Total in USD(\$)</b>
<b>Basic Filing:</b>				
<b>Pages:</b>				
<b>Claims:</b>				
<b>Miscellaneous-Filing:</b>				
<b>Petition:</b>				
<b>Patent-Appeals-and-Interference:</b>				
Notice of appeal	1401	1	540	540
<b>Post-Allowance-and-Post-Issuance:</b>				
<b>Extension-of-Time:</b>				

Description	Fee Code	Quantity	Amount	Sub-Total in USD(\$)
<b>Miscellaneous:</b>				
<b>Total in USD (\$)</b>				<b>540</b>

**Electronic Acknowledgement Receipt**

<b>EFS ID:</b>	8840413
<b>Application Number:</b>	12211033
<b>International Application Number:</b>	
<b>Confirmation Number:</b>	7693
<b>Title of Invention:</b>	METHOD AND APPARATUS FOR MONITORING EXERCISE WITH WIRELESS INTERNET CONNECTIVITY
<b>First Named Inventor/Applicant Name:</b>	Roger J. Quy
<b>Customer Number:</b>	27774
<b>Filer:</b>	Karin L. Williams/Michelle Wolf
<b>Filer Authorized By:</b>	Karin L. Williams
<b>Attorney Docket Number:</b>	00125/002005
<b>Receipt Date:</b>	15-NOV-2010
<b>Filing Date:</b>	15-SEP-2008
<b>Time Stamp:</b>	17:26:19
<b>Application Type:</b>	Utility under 35 USC 111(a)

**Payment information:**

Submitted with Payment	yes
Payment Type	Deposit Account
Payment was successfully received in RAM	\$ 540
RAM confirmation Number	4634
Deposit Account	501047
Authorized User	

The Director of the USPTO is hereby authorized to charge indicated fees and credit any overpayment as follows:

Charge any Additional Fees required under 37 C.F.R. Section 1.21 (Miscellaneous fees and charges)

**File Listing:**

Document Number	Document Description	File Name	File Size(Bytes)/ Message Digest	Multi Part /.zip	Pages (if appl.)
1		NOTICE-OF-APPEAL-AND-PRE-APPEAL.pdf	203433 bda8e176d84c90cb4928ed5fd8cb636832451805	yes	7
<b>Multipart Description/PDF files in .zip description</b>					
	<b>Document Description</b>		<b>Start</b>		<b>End</b>
	Notice of Appeal Filed		1		1
	Pre-Brief Conference request		2		7
<b>Warnings:</b>					
<b>Information:</b>					
2	Fee Worksheet (PTO-875)	fee-info.pdf	30451 72a86cb3ddb5b3873675d7fe90940e78436fcbcd	no	2
<b>Warnings:</b>					
<b>Information:</b>					
<b>Total Files Size (in bytes):</b>			233884		
<p>This Acknowledgement Receipt evidences receipt on the noted date by the USPTO of the indicated documents, characterized by the applicant, and including page counts, where applicable. It serves as evidence of receipt similar to a Post Card, as described in MPEP 503.</p> <p><b><u>New Applications Under 35 U.S.C. 111</u></b>  If a new application is being filed and the application includes the necessary components for a filing date (see 37 CFR 1.53(b)-(d) and MPEP 506), a Filing Receipt (37 CFR 1.54) will be issued in due course and the date shown on this Acknowledgement Receipt will establish the filing date of the application.</p> <p><b><u>National Stage of an International Application under 35 U.S.C. 371</u></b>  If a timely submission to enter the national stage of an international application is compliant with the conditions of 35 U.S.C. 371 and other applicable requirements a Form PCT/DO/EO/903 indicating acceptance of the application as a national stage submission under 35 U.S.C. 371 will be issued in addition to the Filing Receipt, in due course.</p> <p><b><u>New International Application Filed with the USPTO as a Receiving Office</u></b>  If a new international application is being filed and the international application includes the necessary components for an international filing date (see PCT Article 11 and MPEP 1810), a Notification of the International Application Number and of the International Filing Date (Form PCT/RO/105) will be issued in due course, subject to prescriptions concerning national security, and the date shown on this Acknowledgement Receipt will establish the international filing date of the application.</p>					

PTO/SB/31 (07-09)

Approved for use through 07/31/2012. OMB 0651-0031  
 U.S. Patent and Trademark Office; U.S. DEPARTMENT OF COMMERCE

Under the Paperwork Reduction Act of 1995, no persons are required to respond to a collection of information unless it displays a valid OMB control number

<b>NOTICE OF APPEAL FROM THE EXAMINER TO THE BOARD OF PATENT APPEALS AND INTERFERENCES</b>		Docket Number (Optional) 00125/002005						
Certificate of Electronic Transmission <u>Under 37 C.F.R. §1.8</u>  I hereby certify that this correspondence and any document referenced herein are being electronically filed with the USPTO via EFS-Web on November 15, 2010.  <div style="text-align: center;">                     /Michelle Wolf/                      (Printed Name of Person Sending Correspondence)                 </div> <div style="text-align: center;">                     /michelle wolf/                      (Signature)                 </div>	In re Application of Roger J. Quy  <table border="1" style="width: 100%; border-collapse: collapse;"> <tr> <td style="padding: 2px;">Application Number 12/211,033</td> <td style="padding: 2px;">Filed September 15, 2008</td> </tr> <tr> <td colspan="2" style="padding: 2px;">For METHOD AND APPARATUS FOR HEALTH AND DISEASE MANAGMEENT COMBINING PATIENT DATA MONITORING WITH WIRELESS INTERNET CONNECTIVITY</td> </tr> <tr> <td style="padding: 2px;">Art Unit 3769</td> <td style="padding: 2px;">Examiner Michael C. Astorino</td> </tr> </table>		Application Number 12/211,033	Filed September 15, 2008	For METHOD AND APPARATUS FOR HEALTH AND DISEASE MANAGMEENT COMBINING PATIENT DATA MONITORING WITH WIRELESS INTERNET CONNECTIVITY		Art Unit 3769	Examiner Michael C. Astorino
Application Number 12/211,033	Filed September 15, 2008							
For METHOD AND APPARATUS FOR HEALTH AND DISEASE MANAGMEENT COMBINING PATIENT DATA MONITORING WITH WIRELESS INTERNET CONNECTIVITY								
Art Unit 3769	Examiner Michael C. Astorino							
Applicant hereby <b>appeals</b> to the Board of Patent Appeals and Interferences from the last decision of the examiner.								
The fee for this Notice of Appeal is (37 CFR 41.20(b)(1)) <span style="float: right;">\$ <u>540.00</u></span>								
<input type="checkbox"/> Applicant claims small entity status. See 37 CFR 1.27. Therefore, the fee shown above is reduced by half, and the resulting fee is: <span style="float: right;">\$ _____</span>								
<input type="checkbox"/> A check in the amount of the fee is enclosed.								
<input type="checkbox"/> Payment by credit card. Form PTO-2038 is attached.								
<input checked="" type="checkbox"/> The Director has already been authorized to charge fees in this application to a Deposit Account.								
<input checked="" type="checkbox"/> The Director is hereby authorized to charge any fees which may be required, or credit any overpayment to Deposit Account No. <u>50-1047</u> .								
<input type="checkbox"/> A petition for an extension of time under 37 CFR 1.136(a) (PTO/SB/22) is enclosed.								
<b>WARNING: Information on this form may become public. Credit card information should not be included on this form. Provide credit card information and authorization on PTO-2038.</b>								
I am the								
<input type="checkbox"/> applicant /inventor.	_____ /Mark Wieczorek/ Signature							
<input type="checkbox"/> assignee of record of the entire interest. See 37 CFR 3.71. Statement under 37 CFR 3.73(b) is enclosed. (Form PTO/SB/96)	_____ Mark D. Wieczorek Typed or printed name							
<input checked="" type="checkbox"/> attorney or agent of record. Registration number <u>37,966</u>	_____ 619-818-4615 Telephone number							
<input type="checkbox"/> attorney or agent acting under 37 CFR 1.34. Registration number if acting under 37 CFR 1.34. _____	_____ November 15, 2010 Date							
NOTE: Signatures of all the inventors or assignees of record of the entire interest or their representative(s) are required. Submit multiple forms if more than one signature is required, see below*.								
<input type="checkbox"/> *Total of <u>1</u> forms are submitted.								



UNITED STATES PATENT AND TRADEMARK OFFICE

UNITED STATES DEPARTMENT OF COMMERCE  
 United States Patent and Trademark Office  
 Address: COMMISSIONER FOR PATENTS  
 P.O. Box 1450  
 Alexandria, Virginia 22313-1450  
 www.uspto.gov

APPLICATION NO.	FILING DATE	FIRST NAMED INVENTOR	ATTORNEY DOCKET NO.	CONFIRMATION NO.
12/211,033	09/15/2008	Roger J. Quy	00125/002005	7693

2774 7590 12/17/2010  
 MAYER & WILLIAMS PC  
 251 NORTH AVENUE WEST  
 Suite 201  
 WESTFIELD, NJ 07090

EXAMINER
----------

JIAN, SHIRLEY XUEYING

ART UNIT	PAPER NUMBER
----------	--------------

3769

MAIL DATE	DELIVERY MODE
-----------	---------------

12/17/2010

PAPER

**Please find below and/or attached an Office communication concerning this application or proceeding.**

The time period for reply, if any, is set in the attached communication.



<b>Notice of Panel Decision from Pre-Appeal Brief Review</b>	<b>Application/Control No.</b>	<b>Applicant(s)/Patent under Reexamination</b>	
	12/211,033	QUY, ROGER J.	
	SHIRLEY JIAN	<b>Art Unit</b>	
		3769	

This is in response to the Pre-Appeal Brief Request for Review filed 15 November 2010.

1.  **Improper Request** – The Request is improper and a conference will not be held for the following reason(s):

- The Notice of Appeal has not been filed concurrent with the Pre-Appeal Brief Request.  
 The request does not include reasons why a review is appropriate.  
 A proposed amendment is included with the Pre-Appeal Brief request.  
 Other: .

The time period for filing a response continues to run from the receipt date of the Notice of Appeal or from the mail date of the last Office communication, if no Notice of Appeal has been received.

2.  **Proceed to Board of Patent Appeals and Interferences** – A Pre-Appeal Brief conference has been held. The application remains under appeal because there is at least one actual issue for appeal. Applicant is required to submit an appeal brief in accordance with 37 CFR 41.37. The time period for filing an appeal brief will be reset to be one month from mailing this decision, or the balance of the two-month time period running from the receipt of the notice of appeal, whichever is greater. Further, the time period for filing of the appeal brief is extendible under 37 CFR 1.136 based upon the mail date of this decision or the receipt date of the notice of appeal, as applicable.

- The panel has determined the status of the claim(s) is as follows:  
Claim(s) allowed: \_\_\_\_\_.  
Claim(s) objected to: \_\_\_\_\_.  
Claim(s) rejected: \_\_\_\_\_.  
Claim(s) withdrawn from consideration: \_\_\_\_\_.

3.  **Allowable application** – A conference has been held. The rejection is withdrawn and a Notice of Allowance will be mailed. Prosecution on the merits remains closed. No further action is required by applicant at this time.

4.  **Reopen Prosecution** – A conference has been held. The rejection is withdrawn and a new Office action will be mailed. No further action is required by applicant at this time.

All participants:

(1) Shirley Jian.

(3) Linda Dvorak.

(2) Henry Johnson.

(4) \_\_\_\_\_.

/SHIRLEY JIAN/  
Examiner, Art Unit 3769

/Henry M. Johnson, III/  
Supervisory Patent Examiner, Art  
Unit 3769

/Linda C Dvorak/  
Supervisory Patent Examiner, Art  
Unit 3739



UNITED STATES PATENT AND TRADEMARK OFFICE

UNITED STATES DEPARTMENT OF COMMERCE  
 United States Patent and Trademark Office  
 Address: COMMISSIONER FOR PATENTS  
 P.O. Box 1450  
 Alexandria, Virginia 22313-1450  
 www.uspto.gov

APPLICATION NO.	FILING DATE	FIRST NAMED INVENTOR	ATTORNEY DOCKET NO.	CONFIRMATION NO.
12/211,033	09/15/2008	Roger J. Quy	00125/002005	7693

2774 7590 03/18/2011  
 MAYER & WILLIAMS PC  
 251 NORTH AVENUE WEST  
 Suite 201  
 WESTFIELD, NJ 07090

EXAMINER
----------

JIAN, SHIRLEY XUEYING

ART UNIT	PAPER NUMBER
----------	--------------

3769

MAIL DATE	DELIVERY MODE
-----------	---------------

03/18/2011

PAPER

**Please find below and/or attached an Office communication concerning this application or proceeding.**

The time period for reply, if any, is set in the attached communication.

<b>Office Action Summary</b>	<b>Application No.</b>	<b>Applicant(s)</b>	
	12/211,033	QUY, ROGER J.	
	<b>Examiner</b>	<b>Art Unit</b>	
	SHIRLEY JIAN	3769	

**-- The MAILING DATE of this communication appears on the cover sheet with the correspondence address --**

### Period for Reply

A SHORTENED STATUTORY PERIOD FOR REPLY IS SET TO EXPIRE 3 MONTH(S) OR THIRTY (30) DAYS, WHICHEVER IS LONGER, FROM THE MAILING DATE OF THIS COMMUNICATION.

- Extensions of time may be available under the provisions of 37 CFR 1.136(a). In no event, however, may a reply be timely filed after SIX (6) MONTHS from the mailing date of this communication.
- If NO period for reply is specified above, the maximum statutory period will apply and will expire SIX (6) MONTHS from the mailing date of this communication.
- Failure to reply within the set or extended period for reply will, by statute, cause the application to become ABANDONED (35 U.S.C. § 133). Any reply received by the Office later than three months after the mailing date of this communication, even if timely filed, may reduce any earned patent term adjustment. See 37 CFR 1.704(b).

### Status

- 1)  Responsive to communication(s) filed on 20 September 2010 and 15 November 2010.
- 2a)  This action is **FINAL**.                      2b)  This action is non-final.
- 3)  Since this application is in condition for allowance except for formal matters, prosecution as to the merits is closed in accordance with the practice under *Ex parte Quayle*, 1935 C.D. 11, 453 O.G. 213.

### Disposition of Claims

- 4)  Claim(s) 1-4 and 6-21 is/are pending in the application.
- 4a) Of the above claim(s) \_\_\_\_\_ is/are withdrawn from consideration.
- 5)  Claim(s) \_\_\_\_\_ is/are allowed.
- 6)  Claim(s) 1-4 and 6-21 is/are rejected.
- 7)  Claim(s) \_\_\_\_\_ is/are objected to.
- 8)  Claim(s) \_\_\_\_\_ are subject to restriction and/or election requirement.

### Application Papers

- 9)  The specification is objected to by the Examiner.
- 10)  The drawing(s) filed on \_\_\_\_\_ is/are: a)  accepted or b)  objected to by the Examiner.  
Applicant may not request that any objection to the drawing(s) be held in abeyance. See 37 CFR 1.85(a).  
Replacement drawing sheet(s) including the correction is required if the drawing(s) is objected to. See 37 CFR 1.121(d).
- 11)  The oath or declaration is objected to by the Examiner. Note the attached Office Action or form PTO-152.

### Priority under 35 U.S.C. § 119

- 12)  Acknowledgment is made of a claim for foreign priority under 35 U.S.C. § 119(a)-(d) or (f).
- a)  All    b)  Some \* c)  None of:
1.  Certified copies of the priority documents have been received.
  2.  Certified copies of the priority documents have been received in Application No. \_\_\_\_\_.
  3.  Copies of the certified copies of the priority documents have been received in this National Stage application from the International Bureau (PCT Rule 17.2(a)).

\* See the attached detailed Office action for a list of the certified copies not received.

### Attachment(s)

- |  |   |
|--|---|
| 1) <input checked="" type="checkbox"/> Notice of References Cited (PTO-892)                                | 4) <input type="checkbox"/> Interview Summary (PTO-413)<br>Paper No(s)/Mail Date. _____ |
| 2) <input type="checkbox"/> Notice of Draftsperson's Patent Drawing Review (PTO-948)                       | 5) <input type="checkbox"/> Notice of Informal Patent Application                       |
| 3) <input type="checkbox"/> Information Disclosure Statement(s) (PTO/SB/08)<br>Paper No(s)/Mail Date _____ | 6) <input type="checkbox"/> Other: _____  |

Application/Control Number: 12/211,033  
Art Unit: 3769

Page 2

## **DETAILED ACTION**

### **Prosecution is Reopened**

The applicant's arguments in the response filed November 15, 2010 have been fully considered and are persuasive, prosecution is reopened.

Claims 1-4 and 6-21 are pending.

### **Claim Rejections - 35 USC § 102**

The following is a quotation of the appropriate paragraphs of 35 U.S.C. 102 that form the basis for the rejections under this section made in this Office action:

A person shall be entitled to a patent unless –

(e) the invention was described in (1) an application for patent, published under section 122(b), by another filed in the United States before the invention by the applicant for patent or (2) a patent granted on an application for patent by another filed in the United States before the invention by the applicant for patent, except that an international application filed under the treaty defined in section 351(a) shall have the effects for purposes of this subsection of an application filed in the United States only if the international application designated the United States and was published under Article 21(2) of such treaty in the English language.

**Claims 1-4 and 6-21 are rejected under 35 U.S.C. 102(e) as being anticipated by**

**Mault et al. US Patent No. 6,790,178 B1 (hereinafter Mault).**

Regarding claims 1-4 and 6-21, Mault teach a system comprising a wireless computing device, such as a PDA or a cellular phone (web enabled wireless phone), a plurality of physiological monitors (hereinafter 'plug-in modules') adapted to interface with the PDA, and a remote internet based server communicatively coupled with the PDA to receive physiological data and to provide feedback to the PDA's user. The PDA has local application software for receiving, recording, processing, computing, displaying and transmitting signals from the plug-in modules (see col.4, ll.15-col.6, ll.51). Mault disclose the particular use of a calorimeter module,

Application/Control Number: 12/211,033

Page 3

Art Unit: 3769

spirometer module, pedometer module, EKG/Heart sound module, body fat measurement module, blood pressure module, body temperature module, blood pressure module, blood oxygen module, heart rate module, blood glucose module, ultra-sound sensors, food scale module, and even exercise equipment such as a bike (see col.7-col.24, particularly col.24, ll.35-47). The PDA is equipped with health management software that includes the ability to set up a variety of fitness plans and to track adherence to the plans. This includes tracking the user's exercise, diet and physiological parameters, then communicates this information to a remote internet server where the data is further analyzed and/or reviewed by a health professional so that feedback is provided to the user via the PDA. (col.6, ll.52-col.7, ll.26)

Regarding claims 2-3, 6-7 and 9-12, Mault specifically discloses a particular pedometer module in which the PDA stores exercise information received from the pedometer module and calculates various exercise parameters such as calories burned distance covered, average speed, etc. (col.11, ll.45-col.13, ll.55 and Figs. 7-10). Mault also discloses wherein the pedometer module could be attached to the crank arm on a bicycle so that parameters concerning bicycle usage could be determined. (col.13, ll.53-55)

Further regarding claims 4, 13 and 17-19, Mault discloses various ways for connecting the PDA and the plurality of plug-in modules via a wireless connection such as RF, infrared and Bluetooth (col.5, ll.19-39); or via a wired connection such as a docking station or by forming an integral unit consisting of the PDA and a plug-in module. (col.5, ll.40-col.6, ll.14)

The applicant should review the reference in its entirety and please refer to the different embodiments shown in Figs.1-28.

Application/Control Number: 12/211,033  
Art Unit: 3769

Page 4

**Claim Rejections - 35 USC § 103**

The following is a quotation of 35 U.S.C. 103(a) which forms the basis for all obviousness rejections set forth in this Office action:

(a) A patent may not be obtained though the invention is not identically disclosed or described as set forth in section 102 of this title, if the differences between the subject matter sought to be patented and the prior art are such that the subject matter as a whole would have been obvious at the time the invention was made to a person having ordinary skill in the art to which said subject matter pertains. Patentability shall not be negated by the manner in which the invention was made.

**Claims 1-4, 7-10, 12-16 and 20-21 are rejected under 35 U.S.C. 103(a) as being unpatentable over Hickman US Patent No. 6,059,692 in view of King et al. US Patent No. 6,353,839 B1.**

Regarding claims 1, 8-9, 14 and 15, Hickman discloses a ‘virtual personal trainer’ exercise system comprising an variety of exercise apparatuses and an associated local computing device where the local computing device has program software to control and monitor the operation and use of the exercise apparatus, the system further includes a remote internet based system having a remote computer and a bi-directional transmission medium including a telephone line that couples the local system and the remote system for data communication. Additionally, the local system (which includes the local computing device and exercise apparatus) has an interface for communicating with the user, and receives, stores, and transmits exercise and other health parameters to the remote server. The remote server is able to analyze the data from a plurality of local systems, and transmit exercise script/programs to the local system computer to implement these changes and to provide feedback to the user via the display at the exercise system. See abstract and summary of invention and also col.4, ll.40-col.6, ll.40. Hickman teaches using a conventional computer as a medium for connecting with the exercise equipment and for connecting with the internet based remote server via a modem (see Fig.1).

Application/Control Number: 12/211,033

Page 5

Art Unit: 3769

Hickman does not teach using a web enabled wireless phone as a computing device. However King, a reference in data processing art discloses that the rapid growth of the Internet has led to increases in data processing capabilities in portable devices such as web-enabled mobile phones and PDAs. Web enabled mobile phones and PDAs are able to serve as a medium for receiving data from an input and then bi-directional communicating the data between a user end and a remote server end (see Background of invention, especially col.1, ll.55-col.2, ll.13). As such, it would have been obvious to one of ordinary skill in the art at the time of the invention to replace Hickman's local computer with a portable device such as a web-enabled wireless phone because more and more people are carrying mobile devices, as such it would be beneficial to a user to carry Hickman's 'virtual personal trainer' to keep track and receive feedback on his/her daily exercise routines. Additionally, a portable 'virtual personal trainer' may provide additional on-the-go as diet encouragement/feedback services to assist a user further their health and fitness goal (Hickman col.3, ll.1-8).

Additionally, "when there is a design need or market pressure to solve a problem and there are a finite number of identified, predictable solutions, a person of ordinary skill has good reason to pursue the known options within his or her grasp. If this leads to the anticipated success, it is likely the product is not of innovation but ordinary skill and common sense. In that instance the fact that a combination was obvious to try might show it was obvious under 35 U.S.C. 103." *KSR Int'l Co. v. Teleflex Inc.*, 127 S.Ct. 1727, 1742, (2007). As such, replacing a cumbersome desktop computer with a mobile web-enabled phone is merely a product of market pressure as a result of increasing demands for mobile access to the Internet and increasing data processing power for such mobile devices.

Application/Control Number: 12/211,033  
Art Unit: 3769

Page 6

Further regarding claims 1-3, 7- 8, 14-16 and 20-21, Hickman, Figs.4-5 and col.7, ll.59- col.8, ll.47 discloses a local computing system which receives fitness exercise scripts from a remote server, wherein the local computing system further enforces the scripts to monitor a user's heart rate while the user performs an exercise. The exercise equipment include a stationary bicycle, a rowing machine, a step machine and a resistance trainer (see claim 6, col.12, ll.63-65).

Regarding claims 4, 6, 11, 13 and 18, Hickman discloses that the local computing system receives exercise related information over a wired connection via interface 60 (see Fig.1, solid lines indicate wired connection, this is also sufficient to reject a cable wired connection). Additionally, it is inherent that Hickman's local system comprises an adaptor to convert signal from the eService device to a suitable input for the computing device because the computing device is able to process the exercise related data (col.7, ll.59-col.8, ll.47).

**Claims 11, 17-19 are rejected under 35 U.S.C. 103(a) as being unpatentable over Hickman US Patent No.6,059,692 in view of King et al. US Patent No. 6,353,839 B1 as applied to claim claims 1 and 8 above, and further in view of Rautila US Patent No. 6,524,189 B1**

Further regarding claim 11 and 17-19, Hickman discloses that the local computing system receives exercise related information over a wired connection via interface 60 and various cables (see Fig.1). Hickman modified by King replaces the local computer with a web-enabled phone, as such, a wireless transfer medium is needed because mobile devices are intended to communicate via a wireless network (King: col.1, ll.13-23), and neither King nor Hickman teach receiving data via IR, RF or Bluetooth protocols. However Rautila Fig.1 and



Application/Control Number: 12/211,033

Page 7

Art Unit: 3769

col.4, ll.32-54, discloses a local network system comprising a plurality of gaming devices and a mobile phone equipped with an RF transceiver such as Bluetooth radio module for providing short-haul connectivity. It would have been obvious to one of ordinary skill in the art at the time of the invention to further modify Hickman's local system such that it includes King's web-enabled wireless phone and Rautila's wireless phone with RF and Bluetooth capabilities, because Bluetooth is a low cost short range wireless communication protocol enables multiple exercise devices to connect with the wireless phone over a single Bluetooth adapter (Hickman col.5, ll.18-19; Rautila: col.5, ll.26-47).

### **Response to Arguments**

With regard to the obviousness-type double patenting rejections, the applicant's arguments have been fully considered and are persuasive. The double patenting rejection is withdrawn.

With regard to prior art rejections, applicant's arguments have been considered but are moot in view of the new ground(s) of rejection.

### **Conclusion**

The prior art made of record and not relied upon is considered pertinent to applicant's disclosure:

Blazey et al. US Patent No. 6,309,342 B1

Application/Control Number: 12/211,033  
Art Unit: 3769

Page 8

Any inquiry concerning this communication or earlier communications from the examiner should be directed to SHIRLEY JIAN whose telephone number is (571)270-7374. The examiner can normally be reached on Monday-Friday 10:30am-6:00pm.

If attempts to reach the examiner by telephone are unsuccessful, the examiner's supervisor, Hank Johnson can be reached on 571-272-4768. The fax phone number for the organization where this application or proceeding is assigned is 571-273-8300.

Information regarding the status of an application may be obtained from the Patent Application Information Retrieval (PAIR) system. Status information for published applications may be obtained from either Private PAIR or Public PAIR. Status information for unpublished applications is available through Private PAIR only. For more information about the PAIR system, see <http://pair-direct.uspto.gov>. Should you have questions on access to the Private PAIR system, contact the Electronic Business Center (EBC) at 866-217-9197 (toll-free). If you would like assistance from a USPTO Customer Service Representative or access to the automated information system, call 800-786-9199 (IN USA OR CANADA) or 571-272-1000.

/SHIRLEY JIAN/  
Examiner, Art Unit 3769

/Eric F Winakur/  
Primary Examiner, Art Unit 3777

February 28, 2011

<b>Notice of References Cited</b>	Application/Control No. 12/211,033	Applicant(s)/Patent Under Reexamination QUY, ROGER J.	
	Examiner SHIRLEY JIAN	Art Unit 3769	Page 1 of 1

**U.S. PATENT DOCUMENTS**

*	Document Number Country Code-Number-Kind Code	Date MM-YYYY	Name	Classification
*	A US-6,059,692	05-2000	Hickman, Paul L.	482/8
*	B US-6,309,342	10-2001	Blazey et al.	600/26
*	C US-6,353,839 B1	03-2002	King et al.	715/236
*	D US-6,524,189 B1	02-2003	Rautila, Heikki	463/40
*	E US-6,790,178 B1	09-2004	Mault et al.	600/300
*	F US-			
*	G US-			
*	H US-			
*	I US-			
*	J US-			
*	K US-			
*	L US-			
*	M US-			

**FOREIGN PATENT DOCUMENTS**

*	Document Number Country Code-Number-Kind Code	Date MM-YYYY	Country	Name	Classification
*	N				
*	O				
*	P				
*	Q				
*	R				
*	S				
*	T				

**NON-PATENT DOCUMENTS**

*	Document Number Country Code-Number-Kind Code	Date MM-YYYY	Country	Name	Classification
*	Include as applicable: Author, Title Date, Publisher, Edition or Volume, Pertinent Pages)				
*	U				
*	V				
*	W				
*	X				

\*A copy of this reference is not being furnished with this Office action. (See MPEP § 707.05(a).)  
 Dates in MM-YYYY format are publication dates. Classifications may be US or foreign.

<p><b>Search Notes</b></p> 	<p><b>Application/Control No.</b></p> <p>12211033</p>	<p><b>Applicant(s)/Patent Under Reexamination</b></p> <p>QUY, ROGER J.</p>
	<p><b>Examiner</b></p> <p>Shirley Jian</p>	<p><b>Art Unit</b></p> <p>3769</p>

<b>SEARCHED</b>			
<b>Class</b>	<b>Subclass</b>	<b>Date</b>	<b>Examiner</b>
600	300-301 (text)	5/09	MA
600	300-301 (text)	8/5/2010	SJ
428	8 (text)	8/5/2010	SJ
	class and subclass search updated	3/3/2011	SJ

<b>SEARCH NOTES</b>		
<b>Search Notes</b>	<b>Date</b>	<b>Examiner</b>
East search (class/subclass, inventor, parent cases backwards search)	5/09	MA
Reviewed applied prior art, spoke with H. Johnson	11/09	MA
East search notes attached (inventor, IDS, class, subclass, text)	8/5/2010	SJ
EDAN related art search	8/5/2010	SJ
East search notes attached (inventor, IDS, class, subclass, text)	3/3/2011	SJ

<b>INTERFERENCE SEARCH</b>			
<b>Class</b>	<b>Subclass</b>	<b>Date</b>	<b>Examiner</b>

<p>/SHIRLEY JIAN/ Examiner.Art Unit 3769</p>	
--	--

**EAST Search History****EAST Search History (Prior Art)**

Ref #	Hits	Search Query	DBs	Default Operator	Plurals	Time Stamp
S1	1	"6059692".pn. and (heart NEAR4 rate) and ((treadmill) (bike bicycle) (step) (aerobic))	US-PGPUB; USPAT	OR	ON	2011/03/03 11:40
S2	110	(eye SAME (blink\$ pattern)) and (cognit \$5) AND (driv\$3 with sleep\$3)	US-PGPUB; USPAT	OR	ON	2011/03/03 12:02
S3	41	(eye WITH (blink\$ pattern)) and (cognit \$5) AND (driv\$3 with sleep\$3)	US-PGPUB; USPAT	OR	ON	2011/03/03 12:04
S5	1	"6059692".pn. and interface	US-PGPUB; USPAT	OR	ON	2011/03/03 12:19
S8	3	(mobile\$phone cell \$phone) SAME (bluetooth AND (IR RF infrared (radio NEAR2 frequency))) SAME (exercise bike bicycle treadmill step pedometer)	US-PGPUB; USPAT	OR	ON	2011/03/03 12:41
S7	12	(mobile\$phone cell \$phone) SAME (bluetooth AND (IR RF infrared (radio NEAR2 frequency))) and exercise	US-PGPUB; USPAT	OR	ON	2011/03/03 12:41
S6	138	(mobile\$phone cell \$phone) SAME (bluetooth AND (IR RF infrared (radio NEAR2 frequency)))	US-PGPUB; USPAT	OR	ON	2011/03/03 12:41

S9	548	(mobile\$phone cell \$phone phone) SAME (bluetooth AND (IR RF infrared (radio NEAR2 frequency))) and exercise	US-PGPUB; USPAT	OR	ON	2011/03/03 12:42
S13	14	S10 and @ay<="1999"	US-PGPUB; USPAT	OR	ON	2011/03/03 12:44
S12	0	S11 and @ay<="1999"	US-PGPUB; USPAT	OR	ON	2011/03/03 12:44
S11	204	((mobile cell cellular portable) NEAR5 phone) SAME (bluetooth AND (IR RF infrared (radio NEAR2 frequency))) SAME (receiv\$5 transmit\$5 obtain\$5 send\$5) and exercis \$5	US-PGPUB; USPAT	OR	ON	2011/03/03 12:44
S10	2820	((mobile cell cellular portable) NEAR5 phone) SAME (bluetooth AND (IR RF infrared (radio NEAR2 frequency))) SAME (receiv\$5 transmit\$5 obtain\$5 send\$5)	US-PGPUB; USPAT	OR	ON	2011/03/03 12:44
S15	3	S14 and @ay<="1999"	US-PGPUB; USPAT	OR	ON	2011/03/03 12:47
S14	191	((mobile cell cellular portable) NEAR5 phone) SAME (bluetooth AND (IR RF infrared (radio NEAR2 frequency))) SAME (short NEAR\$ range) and exercis\$5	US-PGPUB; USPAT	OR	ON	2011/03/03 12:47
S18	3	S16 and @ay<="1999"	US-PGPUB; USPAT	OR	ON	2011/03/03 12:48
S17	3	S15 and @ay<="1999"	US-PGPUB; USPAT	OR	ON	2011/03/03 12:48

S16	1198	((mobile cell cellular portable) NEAR5 phone) SAME (bluetooth AND (IR RF infrared (radio NEAR2 frequency))) SAME (short NEAR5 range)	US-PGPUB; USPAT	OR	ON	2011/03/03 12:48
S22	10	S21 and @ay<="1999"	US-PGPUB; USPAT	OR	ON	2011/03/03 12:49
S21	3179	((mobile cell cellular portable) NEAR5 phone) WITH (bluetooth AND (IR RF infrared (radio NEAR2 frequency)))	US-PGPUB; USPAT	OR	ON	2011/03/03 12:49
S20	1	S19 and @ay<="1999"	US-PGPUB; USPAT	OR	ON	2011/03/03 12:49
S19	440	((mobile cell cellular portable) NEAR5 phone) WITH (bluetooth AND (IR RF infrared (radio NEAR2 frequency))) SAME (short NEAR5 range)	US-PGPUB; USPAT	OR	ON	2011/03/03 12:49
S23	1	S21 and @ay<="1998"	US-PGPUB; USPAT	OR	ON	2011/03/03 12:52
S24	27	((mobile cell cellular portable) NEAR5 phone) WITH (bluetooth)) and @ay<="1999"	US-PGPUB; USPAT	OR	ON	2011/03/03 12:54

### EAST Search History (I nterference)

< This search history is empty >

**3/ 3/ 2011 2:15:30 PM**

**C:\ Documents and Settings\ sjian\ My Documents\ EAST\ Workspaces\ 12211033\_1. wsp**

## EAST Search History

## EAST Search History (Prior Art)

Ref #	Hits	Search Query	DBs	Default Operator	Plurals	Time Stamp
S67	63	mault.inv. and (cell \$phone phone pda)	US-PGPUB; USPAT; EPO; JPO; DERWENT; IBM_TDB	OR	OFF	2011/02/27 17:00
S68	352	"2630798"   "2826912"   "2831348"   "2838399"   "2869357"   "2911825"   "2920012"   "3213684"   "3220255"   "3250270"   "3306283"   "3523529"   "3527205"   "3681197"   "3726270"   "3797480"   "3799149"   "3814091"   "3834375"   "3895630"   "3938551"   "3962917"   "3967690"   "3972038"   "3991304"   "4003396"   "4008712"   "4051847"   "4078554"   "4100401"   "4101071"   "4113039"   "4117834"   "4151668"   "4159416"   "4186735"   "4188946"   "4192000"   "4197857"   "4200094"   "4211239"   "4212079"   "4221224"	US-PGPUB; USPAT; USOCR	OR	OFF	2011/02/27 17:02



"4221959"  
"4224952"  
"4230108"  
"4244020"  
"4318447"  
"4321674"  
"4341867"  
"4353375"  
"4359057"  
"4366873"  
"4368740"  
"4380802"  
"4386604"  
"4387777"  
"4423792"  
"4425805"  
"4440177"  
"4444201"  
"4463764"  
"4566461"  
"4571682"  
"4572208"  
"4575804"  
"4577710"  
"4598700"  
"4608995"  
"4619269"  
"4629015"  
"4648396"  
"4650218"  
"4658832"  
"4686624"  
"4709331"  
"4731726"  
"4753245"  
"4756670"  
"4757453"  
"4781184"  
"4793362"  
"4796182"  
"4796639"  
"4803625"  
"4807169"  
"4823808"  
"4850371"  
"4853854"  
"4855942"  
"4855945"  
"4856531"  
"4880014"  
"4891756"  
"4894793"  
"4895163"  
"4909259"  
"4911175"  
"4911256"

"4914959" |  
"4917108" |  
"4924389" |  
"4947862" |  
"4951197" |  
"4954954" |  
"4955946" |  
"4965553" |  
"4966155" |  
"4986268" |  
"4998018" |  
"5007429" |  
"5012411" |  
"5019974" |  
"5022406" |  
"5033561" |  
"5038773" |  
"5038792" |  
"5042500" |  
"5042501" |  
"5060506" |  
"5060655" |  
"5060656" |  
"5063937" |  
"5068536" |  
"5069220"). PN. OR  
("5072737" |  
"5077476" |  
"5081871" |  
"5086781" |  
"5095900" |  
"5095913" |  
"5117674" |  
"5119825" |  
"5178155" |  
"5179958" |  
"5203344" |  
"5214966" |  
"5233520" |  
"5233996" |  
"5263491" |  
"5280429" |  
"5282473" |  
"5282840" |  
"5285794" |  
"5293875" |  
"5299579" |  
"5303712" |  
"5307263" |  
"5309921" |  
"5326973" |  
"5335667" |  
"5355879" |  
"5357972" |  
"5363857" |  
"5372141" |

"5381796"  
"5387164"  
"5388043"  
"5398688"  
"5398695"  
"5402796"  
"5412560"  
"5412564"  
"5415176"  
"5419326"  
"5421344"  
"5425374"  
"5449000"  
"5450193"  
"5454721"  
"5468961"  
"5485402"  
"5503151"  
"5542420"  
"5570697"  
"5579782"  
"5611351"  
"5615689"  
"5632281"  
"5645071"  
"5647370"  
"5673691"  
"5676132"  
"5678562"  
"5678571"  
"5691927"  
"5704350"  
"5705735"  
"5720296"  
"5729479"  
"5746214"  
"5754288"  
"5788643"  
"5789660"  
"5796009"  
"5796640"  
"5800360"  
"5810722"  
"5816246"  
"5817031"  
"5819735"  
"5822715"  
"5827179"  
"5831175"  
"5832448"  
"5834626"  
"5836300"  
"5836312"  
"5876351"  
"5890128"  
"5897493"

		"5899855"				
		"5902234"				
		"5908301"				
		"5910107"				
		"5913310"				
		"5918603"				
		"5922610"				
		"5932812"				
		"5933136"				
		"5941825"				
		"5951300"				
		"5957858"				
		"5961451"				
		"5974124"				
		"5989188"				
		"5997476"				
		"6010459"				
		"6013007"				
		"6014578"				
		"6015389"				
		"6024281"				
		"6024699"				
		"6030342"				
		"6032676"				
		"6040531"				
		"6042383"				
		"6044843"				
		"6045513"				
		"6077193"				
		"6083006"				
		"6095949"				
		"6095985"				
		"6101478"				
		"6122536"				
		"6135950"				
		"6135951"				
		"6309342"				
		"6396416").PN. OR				
		("6790178").URPN.				
S69	45	S68 and (cell\$phone phone pda) and (exercis\$5)	US-PGPUB; USPAT; EPO; JPO; DERWENT; IBM_TDB	OR	OFF	2011/02/27 17:02
S70	53	S68 and (cell\$phone phone pda) and (exercis\$5)	US-PGPUB; USPAT; EPO; JPO; DERWENT; IBM_TDB	OR	ON	2011/02/27 17:02
S71	62	stivoriv.inv. and (cell \$phone phone pda) and (exercis\$5)	US-PGPUB; USPAT; EPO; JPO; DERWENT; IBM_TDB	OR	OFF	2011/02/27 17:03

S72	62	stivoriv.inv. and (cell \$phone phone pda) and (exercis\$5) and treadmill	US-PGPUB; USPAT; EPO; JPO; DERWENT; IBM_TDB	OR	OFF	2011/02/27 17:03
S73	96	600/300-301.ccls.and (cell\$phone phone pda) and (exercis\$5) and treadmill	US-PGPUB; USPAT; EPO; JPO; DERWENT; IBM_TDB	OR	OFF	2011/02/27 17:07
S74	96	600/300-301.ccls. and (cell\$phone phone pda) and (exercis\$5) and treadmill	US-PGPUB; USPAT; EPO; JPO; DERWENT; IBM_TDB	OR	OFF	2011/02/27 17:07
S75	0	S74 and @ay<="1999"	US-PGPUB; USPAT; EPO; JPO; DERWENT; IBM_TDB	OR	OFF	2011/02/27 17:08
S76	689	600/300-301.ccls. and (cell\$phone phone pda) and (exercis\$5)	US-PGPUB; USPAT; EPO; JPO; DERWENT; IBM_TDB	OR	OFF	2011/02/27 17:08
S77	44	S76 and @ay<="1999"	US-PGPUB; USPAT; EPO; JPO; DERWENT; IBM_TDB	OR	OFF	2011/02/27 17:08
S78	189	("5148002"   "5592401"   "5757929"   "5825327").PN. OR ("6013007").URPN.	US-PGPUB; USPAT; USOCR	OR	OFF	2011/02/27 17:11
S79	352	("2630798"   "2826912"   "2831348"   "2838399"   "2869357"   "2911825"   "2920012"   "3213684"   "3220255"   "3250270"   "3306283"   "3523529"   "3527205"   "3681197"   "3726270"   "3797480"   "3799149"   "3814091"   "3834375"   "3895630"   "3938551"   "3962917"   "3967690"   "3972038"	US-PGPUB; USPAT; USOCR	OR	OFF	2011/02/27 17:13

"3991304"  
"4003396"  
"4008712"  
"4051847"  
"4078554"  
"4100401"  
"4101071"  
"4113039"  
"4117834"  
"4151668"  
"4159416"  
"4186735"  
"4188946"  
"4192000"  
"4197857"  
"4200094"  
"4211239"  
"4212079"  
"4221224"  
"4221959"  
"4224952"  
"4230108"  
"4244020"  
"4318447"  
"4321674"  
"4341867"  
"4353375"  
"4359057"  
"4366873"  
"4368740"  
"4380802"  
"4386604"  
"4387777"  
"4423792"  
"4425805"  
"4440177"  
"4444201"  
"4463764"  
"4566461"  
"4571682"  
"4572208"  
"4575804"  
"4577710"  
"4598700"  
"4608995"  
"4619269"  
"4629015"  
"4648396"  
"4650218"  
"4658832"  
"4686624"  
"4709331"  
"4731726"  
"4753245"  
"4756670"  
"4757453"

"4781184"  
"4793362"  
"4796182"  
"4796639"  
"4803625"  
"4807169"  
"4823808"  
"4850371"  
"4853854"  
"4855942"  
"4855945"  
"4856531"  
"4880014"  
"4891756"  
"4894793"  
"4895163"  
"4909259"  
"4911175"  
"4911256"  
"4914959"  
"4917108"  
"4924389"  
"4947862"  
"4951197"  
"4954954"  
"4955946"  
"4965553"  
"4966155"  
"4986268"  
"4998018"  
"5007429"  
"5012411"  
"5019974"  
"5022406"  
"5033561"  
"5038773"  
"5038792"  
"5042500"  
"5042501"  
"5060506"  
"5060655"  
"5060656"  
"5063937"  
"5068536"  
"5069220").PN. OR  
("5072737"  
"5077476"  
"5081871"  
"5086781"  
"5095900"  
"5095913"  
"5117674"  
"5119825"  
"5178155"  
"5179958"  
"5203344"

"5214966"  
"5233520"  
"5233996"  
"5263491"  
"5280429"  
"5282473"  
"5282840"  
"5285794"  
"5293875"  
"5299579"  
"5303712"  
"5307263"  
"5309921"  
"5326973"  
"5335667"  
"5355879"  
"5357972"  
"5363857"  
"5372141"  
"5381796"  
"5387164"  
"5388043"  
"5398688"  
"5398695"  
"5402796"  
"5412560"  
"5412564"  
"5415176"  
"5419326"  
"5421344"  
"5425374"  
"5449000"  
"5450193"  
"5454721"  
"5468961"  
"5485402"  
"5503151"  
"5542420"  
"5570697"  
"5579782"  
"5611351"  
"5615689"  
"5632281"  
"5645071"  
"5647370"  
"5673691"  
"5676132"  
"5678562"  
"5678571"  
"5691927"  
"5704350"  
"5705735"  
"5720296"  
"5729479"  
"5746214"  
"5754288"



"5788643"  
"5789660"  
"5796009"  
"5796640"  
"5800360"  
"5810722"  
"5816246"  
"5817031"  
"5819735"  
"5822715"  
"5827179"  
"5831175"  
"5832448"  
"5834626"  
"5836300"  
"5836312"  
"5876351"  
"5890128"  
"5897493"  
"5899855"  
"5902234"  
"5908301"  
"5910107"  
"5913310"  
"5918603"  
"5922610"  
"5932812"  
"5933136"  
"5941825"  
"5951300"  
"5957858"  
"5961451"  
"5974124"  
"5989188"  
"5997476"  
"6010459"  
"6013007"  
"6014578"  
"6015389"  
"6024281"  
"6024699"  
"6030342"  
"6032676"  
"6040531"  
"6042383"  
"6044843"  
"6045513"  
"6077193"  
"6083006"  
"6095949"  
"6095985"  
"6101478"  
"6122536"  
"6135950"  
"6135951"  
"6309342"

		"6396416").PN. OR ("6790178").URPN.				
S80	235	S79 and @ay<="1999"	US-PGPUB; USPAT; EPO; JPO; DERWENT; IBM_TDB	OR	OFF	2011/02/27 17:13
S81	5	S79 and @ay<="1999" and mault.inv.	US-PGPUB; USPAT; EPO; JPO; DERWENT; IBM_TDB	OR	OFF	2011/02/27 17:13
S82	104	"600".clas. and (cell \$phone phone pda) and (exercis\$5) and @ay<="1999"	US-PGPUB; USPAT; EPO; JPO; DERWENT; IBM_TDB	OR	OFF	2011/02/27 17:16
S83	1975	(cell\$phone phone) and (exercis\$5) and @ay<="1999"	US-PGPUB; USPAT; EPO; JPO; DERWENT; IBM_TDB	OR	ON	2011/02/27 17:25
S84	263	"2630798"   "2826912"   "2831348"   "2838399"   "2869357"   "2911825"   "2920012"   "3213684"   "3220255"   "3250270"   "3306283"   "3523529"   "3527205"   "3681197"   "3726270"   "3797480"   "3799149"   "3814091"   "3834375"   "3895630"   "3938551"   "3962917"   "3967690"   "3972038"   "3991304"   "4003396"   "4008712"   "4051847"   "4078554"   "4100401"   "4101071"   "4113039"   "4117834"   "4151668"   "4159416"   "4186735"	US-PGPUB; USPAT; USOCR	OR	OFF	2011/02/27 17:36

"4188946"  
"4192000"  
"4197857"  
"4200094"  
"4211239"  
"4212079"  
"4221224"  
"4221959"  
"4224952"  
"4230108"  
"4244020"  
"4318447"  
"4321674"  
"4341867"  
"4353375"  
"4359057"  
"4366873"  
"4368740"  
"4380802"  
"4386604"  
"4387777"  
"4423792"  
"4425805"  
"4440177"  
"4444201"  
"4463764"  
"4566461"  
"4571682"  
"4572208"  
"4575804"  
"4577710"  
"4598700"  
"4608995"  
"4619269"  
"4629015"  
"4648396"  
"4650218"  
"4658832"  
"4686624"  
"4709331"  
"4731726"  
"4753245"  
"4756670"  
"4757453"  
"4781184"  
"4793362"  
"4796182"  
"4796639"  
"4803625"  
"4807169"  
"4823808"  
"4850371"  
"4853854"  
"4855942"  
"4855945"  
"4856531"

"4880014" |  
"4891756" |  
"4894793" |  
"4895163" |  
"4909259" |  
"4911175" |  
"4911256" |  
"4914959" |  
"4917108" |  
"4924389" |  
"4947862" |  
"4951197" |  
"4954954" |  
"4955946" |  
"4965553" |  
"4966155" |  
"4986268" |  
"4998018" |  
"5007429" |  
"5012411" |  
"5019974" |  
"5022406" |  
"5033561" |  
"5038773" |  
"5038792" |  
"5042500" |  
"5042501" |  
"5060506" |  
"5060655" |  
"5060656" |  
"5063937" |  
"5068536" |  
"5069220").PN. OR  
("5072737" |  
"5077476" |  
"5081871" |  
"5086781" |  
"5095900" |  
"5095913" |  
"5117674" |  
"5119825" |  
"5178155" |  
"5179958" |  
"5203344" |  
"5214966" |  
"5233520" |  
"5233996" |  
"5263491" |  
"5280429" |  
"5282473" |  
"5282840" |  
"5285794" |  
"5293875" |  
"5299579" |  
"5303712" |  
"5307263" |

"5309921"  
"5326973"  
"5335667"  
"5355879"  
"5357972"  
"5363857"  
"5372141"  
"5381796"  
"5387164"  
"5388043"  
"5398688"  
"5398695"  
"5402796"  
"5412560"  
"5412564"  
"5415176"  
"5419326"  
"5421344"  
"5425374"  
"5449000"  
"5450193"  
"5454721"  
"5468961"  
"5485402"  
"5503151"  
"5542420"  
"5570697"  
"5579782"  
"5611351"  
"5615689"  
"5632281"  
"5645071"  
"5647370"  
"5673691"  
"5676132"  
"5678562"  
"5678571"  
"5691927"  
"5704350"  
"5705735"  
"5720296"  
"5729479"  
"5746214"  
"5754288"  
"5788643"  
"5789660"  
"5796009"  
"5796640"  
"5800360"  
"5810722"  
"5816246"  
"5817031"  
"5819735"  
"5822715"  
"5827179"  
"5831175"

		"5832448"				
		"5834626"				
		"5836300"				
		"5836312"				
		"5876351"				
		"5890128"				
		"5897493"				
		"5899855"				
		"5902234"				
		"5908301"				
		"5910107"				
		"5913310"				
		"5918603"				
		"5922610"				
		"5932812"				
		"5933136"				
		"5941825"				
		"5951300"				
		"5957858"				
		"5961451"				
		"5974124"				
		"5989188"				
		"5997476"				
		"6010459"				
		"6013007"				
		"6014578"				
		"6015389"				
		"6024281"				
		"6024699"				
		"6030342"				
		"6032676"				
		"6040531"				
		"6042383"				
		"6044843"				
		"6045513"				
		"6077193"				
		"6083006"				
		"6095949"				
		"6095985"				
		"6101478"				
		"6122536"				
		"6135950"				
		"6135951"				
		"6309342"				
		"6396416").PN.				
S85	3	S84 and ((mobile cellular cell\$4) NEAR3 phone)	US-PGPUB; USPAT; USOCR	OR	OFF	2011/02/27 17:37
S86	16	jacobsen.inv. and (soldier)	US-PGPUB; USPAT; USOCR	OR	OFF	2011/02/28 12:21
S87	9	S86 and (mobile cellular phone)	US-PGPUB; USPAT; USOCR	OR	OFF	2011/02/28 12:21
S88	9	S86 and (mobile cellular phone call45)	US-PGPUB; USPAT; USOCR	OR	OFF	2011/02/28 12:23

S89	10	S86 and (mobile cellular phone call\$5)	US-PGPUB; USPAT; USOCR	OR	OFF	2011/02/28 12:23
S90	22	((ROGER) near2 (QUY)).INV.	US-PGPUB; USPAT; USOCR	OR	OFF	2011/02/28 14:50
S91	5	S90 and (exercise). clm.	US-PGPUB; USPAT; USOCR	OR	OFF	2011/02/28 14:50
S92	263	"2630798"   "2826912"   "2831348"   "2838399"   "2869357"   "2911825"   "2920012"   "3213684"   "3220255"   "3250270"   "3306283"   "3523529"   "3527205"   "3681197"   "3726270"   "3797480"   "3799149"   "3814091"   "3834375"   "3895630"   "3938551"   "3962917"   "3967690"   "3972038"   "3991304"   "4003396"   "4008712"   "4051847"   "4078554"   "4100401"   "4101071"   "4113039"   "4117834"   "4151668"   "4159416"   "4186735"   "4188946"   "4192000"   "4197857"   "4200094"   "4211239"   "4212079"   "4221224"   "4221959"   "4224952"   "4230108"   "4244020"   "4318447"	US-PGPUB; USPAT; USOCR	OR	OFF	2011/02/28 15:43

"4321674"  
"4341867"  
"4353375"  
"4359057"  
"4366873"  
"4368740"  
"4380802"  
"4386604"  
"4387777"  
"4423792"  
"4425805"  
"4440177"  
"4444201"  
"4463764"  
"4566461"  
"4571682"  
"4572208"  
"4575804"  
"4577710"  
"4598700"  
"4608995"  
"4619269"  
"4629015"  
"4648396"  
"4650218"  
"4658832"  
"4686624"  
"4709331"  
"4731726"  
"4753245"  
"4756670"  
"4757453"  
"4781184"  
"4793362"  
"4796182"  
"4796639"  
"4803625"  
"4807169"  
"4823808"  
"4850371"  
"4853854"  
"4855942"  
"4855945"  
"4856531"  
"4880014"  
"4891756"  
"4894793"  
"4895163"  
"4909259"  
"4911175"  
"4911256"  
"4914959"  
"4917108"  
"4924389"  
"4947862"  
"4951197"



"4954954" |  
"4955946" |  
"4965553" |  
"4966155" |  
"4986268" |  
"4998018" |  
"5007429" |  
"5012411" |  
"5019974" |  
"5022406" |  
"5033561" |  
"5038773" |  
"5038792" |  
"5042500" |  
"5042501" |  
"5060506" |  
"5060655" |  
"5060656" |  
"5063937" |  
"5068536" |  
"5069220").PN. OR  
("5072737" |  
"5077476" |  
"5081871" |  
"5086781" |  
"5095900" |  
"5095913" |  
"5117674" |  
"5119825" |  
"5178155" |  
"5179958" |  
"5203344" |  
"5214966" |  
"5233520" |  
"5233996" |  
"5263491" |  
"5280429" |  
"5282473" |  
"5282840" |  
"5285794" |  
"5293875" |  
"5299579" |  
"5303712" |  
"5307263" |  
"5309921" |  
"5326973" |  
"5335667" |  
"5355879" |  
"5357972" |  
"5363857" |  
"5372141" |  
"5381796" |  
"5387164" |  
"5388043" |  
"5398688" |  
"5398695" |

"5402796"  
"5412560"  
"5412564"  
"5415176"  
"5419326"  
"5421344"  
"5425374"  
"5449000"  
"5450193"  
"5454721"  
"5468961"  
"5485402"  
"5503151"  
"5542420"  
"5570697"  
"5579782"  
"5611351"  
"5615689"  
"5632281"  
"5645071"  
"5647370"  
"5673691"  
"5676132"  
"5678562"  
"5678571"  
"5691927"  
"5704350"  
"5705735"  
"5720296"  
"5729479"  
"5746214"  
"5754288"  
"5788643"  
"5789660"  
"5796009"  
"5796640"  
"5800360"  
"5810722"  
"5816246"  
"5817031"  
"5819735"  
"5822715"  
"5827179"  
"5831175"  
"5832448"  
"5834626"  
"5836300"  
"5836312"  
"5876351"  
"5890128"  
"5897493"  
"5899855"  
"5902234"  
"5908301"  
"5910107"  
"5913310"

		"5918603"   "5922610"   "5932812"   "5933136"   "5941825"   "5951300"   "5957858"   "5961451"   "5974124"   "5989188"   "5997476"   "6010459"   "6013007"   "6014578"   "6015389"   "6024281"   "6024699"   "6030342"   "6032676"   "6040531"   "6042383"   "6044843"   "6045513"   "6077193"   "6083006"   "6095949"   "6095985"   "6101478"   "6122536"   "6135950"   "6135951"   "6309342"   "6396416").PN.				
S93	17	S92 and ((internet web) and (phone mobile cellular call \$5))	US-PGPUB; USPAT; USOCR	OR	OFF	2011/02/28 15:44
S94	9	S92 and ((internet web) and (phone mobile cellular call \$5)) and wireless	US-PGPUB; USPAT; USOCR	OR	OFF	2011/02/28 15:45
S95	0	(09/430445).APP.	US-PGPUB; USOCR	OR	OFF	2011/02/28 16:14
S96	9	("385998"   "4632126"   "5047930"   "5253168"   "5304112"   "5343871"   "5465729"   "5596994"   "5676138").PN.	US-PGPUB; USPAT; USOCR	OR	OFF	2011/02/28 16:14
S97	1	"5678562".pn.	US-PGPUB; USPAT; USOCR	OR	OFF	2011/02/28 16:22

S98	6	"7056265".pn. "5387164".pn. "4828257".pn. "5474090".pn. "6059692".pn. "6645124".pn.	US-PGPUB; USPAT; USOCR	OR	OFF	2011/02/28 16:27
S99	6	S98 and ((cellphone cell\$phone phone mobile) (web\$page web internet) (exercise) and (interactive remote wireless))	US-PGPUB; USPAT; USOCR	OR	OFF	2011/02/28 16:28
S100	921	((exercis\$5 work\$out treadmill bike) AND (wireless) AND (cellular phone cell \$phone mobile \$phone)) and @ay<="1999"	US-PGPUB; USPAT; USOCR	OR	OFF	2011/02/28 16:34
S103	470	((exercis\$5 work\$out treadmill bike) AND (wireless) AND (cellular phone cell \$phone mobile \$phone) AND (web \$page web internet)) and @ay<="1999"	US-PGPUB; USPAT; USOCR	OR	ON	2011/02/28 16:35
S104	383	S103 and (server)	US-PGPUB; USPAT; USOCR	OR	ON	2011/02/28 16:36
S105	76	S104 and ((feedback advice comment) SAME (phone internet mobile\$phone cellular \$phone cell\$phone))	US-PGPUB; USPAT; USOCR	OR	ON	2011/02/28 16:36
S106	50	S105 and ((wireless) WITH (phone internet mobile\$phone cellular \$phone cell\$phone))	US-PGPUB; USPAT; USOCR	OR	ON	2011/02/28 16:38
S107	48	S106 and exercis\$5	US-PGPUB; USPAT; USOCR	OR	ON	2011/02/28 16:39
S108	12	S107 and @ay<"1999"	US-PGPUB; USPAT; USOCR	OR	ON	2011/02/28 16:43
S109	189	("5148002"   "5592401"   "5757929"   "5825327").PN. OR ("6013007").URPN.	US-PGPUB; USPAT; USOCR	OR	OFF	2011/02/28 16:54

S110	61	S109 and (web internet web\$page) and (phone mobile \$phone cell\$phone) and (wireless)	US-PGPUB; USPAT; USOCR	OR	OFF	2011/02/28 16:55
S111	561527	"61" and @ay<="1999"	US-PGPUB; USPAT; USOCR	OR	OFF	2011/02/28 16:58
S112	0	S110 and @ay<="1999"	US-PGPUB; USPAT; USOCR	OR	OFF	2011/02/28 16:58

**EAST Search History (Interference)**

<This search history is empty>

**3/ 3/ 2011 2:19:15 PM**

**C:\ Documents and Settings\ sjian\ My Documents\ EAST\ Workspaces\ 12211033.wsp**

Serial No.: 12/211,033  
Examiner Shirley Xueying Jian  
Group Art Unit 3769  
Page 1 of 17

**IN THE UNITED STATES PATENT AND TRADEMARK OFFICE**

Applicants: Roger J. Quy  
Application No. 12/211,033  
Filed: September 15, 2008  
Title: METHOD AND APPARATUS FOR MONITORING EXERCISE  
WITH WIRELESS INTERNET CONNECTIVITY  
Art Unit: 3769  
Examiner: Shirley Jian  
Confirm. No.: 7693  
Docket No.: 00125/002005  
Via EFS Web  
Commissioner for Patents  
P.O. Box 1450  
Alexandria, VA 22313-1450

Certificate of Electronic Transmission  
Under 37 C.F.R. §1.8  
I hereby certify that this correspondence and any document referenced  
herein are being electronically filed with the USPTO via EFS-Web on June  
14, 2011.  
Michelle Wolf  
(Printed Name of Person Sending Correspondence)  
/Michelle Wolf/  
(Signature)

Dear Sir:

**RESPONSE TO NON-FINAL OFFICE ACTION**

This filing is in response to the non-final Office Action mailed March 18, 2011, having a due date for response of June 18, 2011. This Response is timely filed and no fees are believed to be due.

However, if any fees are deemed to be due for this application, or if any credits for any overpayments are to be returned, the same should be directed to Deposit Account Number 50-1047 and authorization is hereby given to charge such account.

**Claims** begin on page 2.

**Remarks** begin on page 6.

Serial No.: 12/211,033  
Examiner Shirley Xueying Jian  
Group Art Unit 3769  
Page 2 of 17

IN THE CLAIMS:

1. (Previously Presented) A method for interactive exercise monitoring, the method comprising the steps of:
  - a. coupling a web-enabled wireless phone to a device which provides exercise-related information;
  - b. rendering a user interface on the web-enabled wireless phone;
  - c. receiving data indicating a physiologic status of a subject;
  - d. receiving data indicating an amount of exercise performed by the subject;
  - e. wherein at least one of the data indicating a physiologic status of a subject or the data indicating an amount of exercise performed by the subject is received from the device which provides exercise-related information, and wherein the data indicating a physiologic status of a subject is received at least partially while the subject is exercising;
  - f. sending the exercise-related information to an internet server via a wireless network;
  - g. receiving a calculated response from the server, the response associated with a calculation performed by the server based on the exercise-related information; and
  - h. running an application in the web-enabled wireless phone for receiving the exercise-related information and displaying the response.
  
2. (Previously Presented) The method of claim 1, wherein the receiving data indicating a physiologic status of a subject includes receiving data from a physiological sensor coupled to an exercise machine.
  
3. (Previously Presented) The method of claim 1, where the receiving data indicating an amount of exercise performed by the subject includes receiving data from an exercise machine.

Serial No.: 12/211,033  
Examiner Shirley Xueying Jian  
Group Art Unit 3769  
Page 3 of 17

4. (Previously Presented) The method of claim 1, wherein the web-enabled wireless phone receives exercise-related information over a transmission medium, the transmission medium including a wired connection or a wireless connection.
5. (Canceled)
6. (Original) The method of claim 1, wherein the web-enabled wireless phone receives data via an adapter to convert a signal from the device to a suitable input for the wireless phone.
7. (Previously Presented) The method of claim 1, wherein the data indicating an amount of exercise performed is received from a device selected from the group consisting of: a treadmill, a stepper, an exercise cycle, an accelerometer, a rowing machine, physiotherapy equipment, an aerobic or anaerobic exercise device, and a device that monitors an amount of work or rate of work performed.
8. (Previously Presented) A non-transitory computer-readable medium, containing an application for performing an interactive method of exercise monitoring, the application physically residing on a server, the method comprising the steps of:
  - a. receiving exercise-related information from a web-enabled wireless phone, wherein the exercise-related information includes data indicating a physiologic status of a subject and data indicating an amount of exercise performed by the subject, and wherein the data indicating a physiologic status of a subject is received at least partially while the subject is exercising;
  - b. calculating a response based on the exercise-related information;
  - c. transmitting the calculated response to the web-enabled wireless phone.
9. (Previously Presented) The medium of claim 8, wherein the method further comprises:



Serial No.: 12/211,033  
Examiner Shirley Xueying Jian  
Group Art Unit 3769  
Page 4 of 17

- a. enabling the web-enabled wireless phone to receive exercise-related information from a device; and
- b. transmitting to the web-enabled wireless phone a device application including a user interface on which the calculated response may be rendered.

10. (Previously Presented) The medium of claim 8, wherein the calculating a response includes calculating a response to assist a person in monitoring calorie expenditure, losing weight, or maintaining a healthy lifestyle.

11. (Previously Presented) The medium of claim 8, wherein the instructions further cause the web-enabled wireless phone to receive the exercise-related information via an adapter, the adapter to convert a received data signal to a suitable input for the web-enabled wireless phone.

12. (Previously Presented) The medium of claim 8, wherein the data indicating an amount of exercise performed by the subject is received from a device which is selected from the group consisting of: a pedometer, a treadmill, a stepper, an exercise cycle, an accelerometer, a rowing machine, physiotherapy equipment, an aerobic or anaerobic exercise device, and a device that monitors an amount of work or rate of work performed.

13. (Previously Presented) The medium of claim 8, wherein the receiving exercise-related information includes receiving exercise-related information over a wireless or a wired connection.

14. (Previously Presented) A web-enabled wireless phone, containing a computer-readable medium, the computer-readable medium comprising memory within a web-enabled wireless phone, the computer-readable medium comprising instructions for causing a processor in the web-enabled wireless phone to perform the method of claim 1.

Serial No.: 12/211,033  
Examiner Shirley Xueying Jian  
Group Art Unit 3769  
Page 5 of 17

15. (Previously Presented) A computer-readable medium, the computer-readable medium comprising memory within a web-enabled wireless phone, the computer-readable medium containing instructions for causing a processor in a web-enabled wireless phone to perform the method of claim 1.
16. (Previously Presented) The method of claim 1, further comprising downloading the application to the web-enabled wireless phone from a server.
17. (Previously Presented) The method of claim 4, wherein the wireless connection includes an infrared connection or a radio frequency communication protocol including a short-range wireless transmission scheme.
18. (Previously Presented) The method of claim 4, wherein the wired connection includes a USB connection, a cable, or a docking station.
19. (Previously Presented) The method of claim 17, wherein the short-range wireless transmission scheme includes 802.11 or Bluetooth®.
20. (Previously Presented) The method of claim 1, wherein the data indicating a physiologic status of a subject is received from a device selected from the group consisting of: a heart rate monitor, a blood pressure monitor, a body temperature monitor, a respiratory monitor, a biofeedback device, an electronic body weight scale, and a body fat gauge.
21. (Previously Presented) The medium of claim 8, wherein the data indicating a physiologic status of a subject is received from a device which is selected from the group consisting of: a heart rate monitor, a blood pressure monitor, a body temperature monitor, a respiratory monitor, a biofeedback device, an electronic body weight scale, and a body fat gauge.

Serial No.: 12/211,033  
Examiner Shirley Xueying Jian  
Group Art Unit 3769  
Page 6 of 17

## REMARKS

### Status of the Claims

Claims 1-4 and 6-21 are pending in the application. Claims 1-4 and 6-21 are rejected. No claims have been amended or cancelled, and thus claims 1-4 and 6-21 are currently pending, of which claims 1 and 8 are in independent form. Claims 14 and 15 are in independent form, but include all the limitations of claim 1.

### Rejection under 35 U.S.C. § 102

Claims 1-4 and 6-21 are rejected under 35 U.S.C. 102(e) as being anticipated by Mault et al. US 6,790,178 B1 (Mault). These rejections are traversed with respect to the amended claims as follows.

Applicant's date of invention pre-dates the effective date of the Mault reference. As shown in the attached Declaration Under 37 CFR 1.131 (Appendix I, referencing Appendix II), Applicant's date of invention for his provisional application 60/172,486 is at least as early as November 6, 1999. Thus Applicant's provisional patent application has an earlier effective date than all of the Mault provisionals with the *possible* exceptions of the following:

60/155,851

60/158,553

60/158,554

60/158,556

60/159,285

These provisional patent applications are reproduced in Appendix III.

With respect to independent claim 1, it is noted that the claim requires a method for interactive exercise monitoring, including coupling a web-enabled wireless phone to a device which provides exercise-related information; rendering a user interface on the web-enabled wireless phone; receiving data indicating a physiologic status of a subject;

Serial No.: 12/211,033  
Examiner Shirley Xueying Jian  
Group Art Unit 3769  
Page 7 of 17

and receiving data indicating an amount of exercise performed by the subject. At least one of the data indicating a physiologic status of a subject or the data indicating an amount of exercise performed by the subject is received from the device which provides exercise-related information, and the data indicating a physiologic status of a subject is received at least partially while the subject is exercising. Other steps include sending the exercise-related information to an internet server via a wireless network; receiving a calculated response from the server, the response associated with a calculation performed by the server based on the exercise-related information; and running an application in the web-enabled wireless phone for receiving the exercise-related information and displaying the response.

With respect to independent claim 8, it is noted that the claim requires a non-transitory computer-readable medium, containing an application for performing an interactive method of exercise monitoring, the application physically residing on a server, the method including receiving exercise-related information from a web-enabled wireless phone, where the exercise-related information includes data indicating a physiologic status of a subject and data indicating an amount of exercise performed by the subject, and where the data indicating a physiologic status of a subject is received at least partially while the subject is exercising; calculating a response based on the exercise-related information; and transmitting the calculated response to the web-enabled wireless phone.

These claims are clearly supported by Applicant's provisional patent application, provided in its entirety in Appendix II and excerpted below:

The advent of technology for wireless Internet connectivity enables an alternative system for interactive physiological monitoring and providing health-related information that is even less expensive and easier to use than one based on a television display. In addition,

•••

Serial No.: 12/211,033  
Examiner Shirley Xueying Jian  
Group Art Unit 3769  
Page 8 of 17

Software can be downloaded to the WWD from a server to provide a personalized display for the user, update information from health and disease management service companies, and control devices connected via a dataport to the WWD. The information supplied by health care web sites must be specially designed to suit the constraints of the small display screens of WWDs. However, the early adoption of such devices in Europe has demonstrated that their use to display information derived from the web is acceptable to consumers.

Wireless Internet connectivity has the advantage that the patient is not constrained to the place where the personal computer, information appliance or television set is located. For example, a diabetic could connect a blood glucose meter to a web-enabled cell phone while away from home and download data to a Diabetes Management Company's server and in response receive guidance displayed on the screen (or by voice) about choices for the next meal. Alternatively, the same person may take the WWD to the local gymnasium, send data output from various exercise machines over the Internet and receive a personalized response from the server of a company specializing in Health & Lifestyle Management. The connection of the WWD to a medical device, exercise machine or other health care equipment could be via a standardized data port, an adapter to extant interfaces such as RS232, infra red, radio frequency, or by default, the patient inputting data on the keypad.

In the preferred embodiment of the present invention, a web-enabled wireless phone (e.g. Sprint PCS Phone) is coupled to a medical monitoring device, such as (but not limited to) a blood glucose meter. An adapter is used if necessary to convert the output signal of the medical data monitor to a suitable input signal for the phone. The patient connects to a specific Internet site and a software program, resident on a remote server located on the Internet, downloads an interactive user interface for that patient and the measurement of the physiological data. Further information may be provided to the patient in response to the data or to other inputs that have been entered by voice or keypad.

In place of a conventional medical monitoring device, the web-enabled wireless phone may be coupled to other devices which provide health related information data, such as an electronic scale, a body fat gauge, biofeedback devices, physio-therapy or chiropractic equipment, or any type of exercise machine. The user connects to the Internet and a software program, resident on a remote server located on the Internet, captures data from the coupled device and downloads interactive information that relates to health management. Further information may be provided to the user in response to the data or to other inputs that have been entered by voice or keypad.

Mault, on the other hand, has no such disclosure, particularly not in the provisionals noted above. Rather, these disclose PDAs that primarily employ plug-ins (though internal software is disclosed) that allow a physiological or activity measurement. The PDA incorporates apparatus for sending results to "a central station via a telecommunications network such as the Internet". The link between the PDA and the telecommunications network could be "via a wireless connection to a transceiver

Serial No.: 12/211,033  
Examiner Shirley Xueying Jian  
Group Art Unit 3769  
Page 9 of 17

which is connected to the Internet". The same link return signals to the PDA for display to the user. See, e.g., 60/155,851, page 2, at paragraph 3. Monitors may also be coupled to the PDA through a wireless channel. See, e.g., 60/158,553, page 3, at paragraph 3.

Therefore, Applicant submits that Mault is deficient as anticipatory reference as the same lacks teaching or disclosure of a web enabled wireless phone. Mault's PDA cannot meet this claim limitation as, at the time of filing, a PDA and a mobile phone were quite distinct devices: it was in fact several years later until their functions became similar. The present application and the provisional application on which it is based disclose one type of wireless web device being a PDA equipped with a wireless modem, and another type of wireless web device being a web enabled wireless phone, and a third type being a device that combines the functions of a computer, PDA, and telephone. Mault also teaches a mobile phone in his 60/265,166, but as a distinct disclosure from a PDA as described in his earlier provisional applications. And 60/265,166 was filed subsequently to Applicant's declaration of invention.

Therefore, for at least this reason, Applicant submits that the rejection of claims 1 and 8 based on Mault should be withdrawn.

Even assuming, *arguendo*, the reference was not deficient on this basis, other distinctions may also be seen. For example, with respect to claim 1, Mault lacks teaching or disclosure of a user interface to display a response via a web enabled phone as disclosed and claimed by Applicant. What makes a web-enabled mobile phone distinct from a conventional cellular phone are features, e.g., a microbrowser, designed to operate within the constraints of a small display screen, to access and display information derived from the web (see, e.g., Applicant's provisional patent application at page 2, paragraph 2), and an operating system that includes the ability to download application programs from a website. For additional information about the known characteristics of a web-enabled phone, the Examiner is referred to:

<http://www.educause.edu/EDUCAUSE+Quarterly/EDUCAUSEQuarterlyMagazineVolume/SmartphonesandOtherMobileDevic/157292>).

For at least this reason as well, Applicant submits that the rejection of claim 1 based on Mault should be withdrawn.

Serial No.: 12/211,033  
Examiner Shirley Xueying Jian  
Group Art Unit 3769  
Page 10 of 17

The reference is even more deficient with respect to the dependent claims. For example, with respect to claims 9 and 16, Mault lacks teach or disclosure of downloading an application program from an internet server. See, e.g., Applicant's provisional patent application 60/172,486, at page 2, para 2, and page 3, para 1. Rather, Mault teaches that the local application software is loaded from plug-in modules. Alternatively, the reference discloses that the application software may be resident in the memory of the PDA. See, e.g., Mault '178 at 4:44-47. However, the reference does not teach by what means the application software is loaded into the PDA memory. It is noted that in one of the Mault provisional cases (60/165,166), filed subsequently to Applicant's provisional patent declaration of invention, the reference discloses a server program to receive and process data from a mobile phone; but notably, even in this disclosure, there is no teaching of downloading the application program to the phone, as required by instant claims 9 and 16.

**Rejection under 35 U.S.C. § 103**

Claims 1-4, 7-10, 12-16 and 20-21 stand rejected under 35 U.S.C. 103(a) as being allegedly unpatentable over Hickman US 6,059,692 (Hickman) in view of King et al. US 6,353,839 B1 (King).

Applicant initially notes the requirements of the cited code section (35 USC 103):

A patent may not be obtained though the invention is not identically disclosed or described as set forth in section 102 of this title, if the differences between the subject matter sought to be patented and the prior art are such that the subject matter as a whole would have been obvious at the time the invention was made to a person having ordinary skill in the art to which said subject matter pertains. Patentability shall not be negated by the manner in which the invention was made.

(Emphasis added.)

Applicant submits that at the time the invention was made, the claimed invention was clearly non-obvious over the prior art cited.

Serial No.: 12/211,033  
Examiner Shirley Xueying Jian  
Group Art Unit 3769  
Page 11 of 17

In particular, the Examiner alleges that it is obvious that a conventional computer, as taught by Hickman in the light of King, can be replaced by a mobile phone. The Examiner states that, “replacing a cumbersome desktop computer with a mobile web-enabled phone is merely a product of market pressure as a result of increasing demand for mobile access to the Internet and increasing processing power for such mobile devices.”

The Applicant concurs that nowadays mobile phones are being used for many tasks previously requiring a personal computer. However, this was clearly not the case at the time the invention was made twelve years ago. Rather, the use of a web-enabled wireless phone to replace the personal computer and standard telephone modem, or a conventional telemetry system of the time, was a product innovation and by no means obvious to a person having ordinary skill in the art—as previously discussed in response to prior rejections, e.g., those under the Root reference,

In particular, the relatively small amount of memory and processing capability provided on a wireless phone in the 1990s, as compared to the present time, severely limited the functionality of applications running on the wireless phone, especially in terms of computing capacity, processing power, and user interface. In the current claimed systems, e.g., the application program downloaded from a server is thus designed to suit the constraints of the small display screens of a mobile phone. By providing significant application functionality on the server, less memory and processing capabilities become necessary on the wireless phone; thus freeing memory and processing for an interactive user interface and for receiving the exercise related data. The external application running on the internet server and external data storage were other examples of ways employed to overcome the computing limitations of a mobile phone.

Even the King reference acknowledges that mobile phones at the time of their invention were extremely limited in computing power, memory capacity, display capability, input interface, and web browser implementation in comparison to desktop personal computers. See, e.g., 1:35-54. Hence, the purpose of King was to improve the display functionality of a mobile wireless device by reducing the delay involved in interacting with a back-end server. See, e.g., 2:3-29.



Serial No.: 12/211,033  
Examiner Shirley Xueying Jian  
Group Art Unit 3769  
Page 12 of 17

Consequently, King does not teach or disclose the use of mobile phones to control and monitor devices connected via a generic input/output port to the mobile phone. Nor does the reference teach or disclose how exercise or physiological data may be received by means of a wired or wireless connection to the phone, or that an application program downloaded from the server controls the manner, content, and display of the measured data to the user.

As one of ordinary skill in the art would not have been led to combine King with Hickman at the time the invention was made, a *prima facie* case of obviousness cannot be shown, and thus the rejection of claims 1, 8, 9, 14, and 15 should be withdrawn.

Even assuming, *arguendo*, the above were not the case, the references clearly teach away from their own combination. In particular, the Office uses Hickman for a basic disclosure of a “virtual personal trainer”, while using King for a disclosure of a mobile phone as a computing device. Hickman specifically uses a script system to control and monitor the operation of the exercise apparatus. In fact, the script system appears to be a key element of the invention, and is included in all of the claims. However, King specifically teaches away from script systems (2:6-11). Thus, one of ordinary skill in the art, with Hickman in hand, would never look to the King reference for potential combination.

Claims 11, 17-19 stand rejected under 35 U.S.C. 103(a) as being allegedly unpatentable over Hickman in view of King and further in view of Rautila US 6,524,189 B1 (Rautila).

Rautila teaches a system to link together multiple mobile phones and game units using a short range radio communication link, e.g., Bluetooth, to bypass a cellular network, or alternatively through a public wireless network. See, e.g., 4:55-65. The mobile phones are used to share game-related data with users. However, Rautila does not disclose that which is missing from the combination of Hickman and King. In particular, Rautila provides no more evidence of why one of ordinary skill in the art would develop the claimed invention at the time of the invention using the combination of references proposed by the Office. Applicant respectfully submits that it is only with the benefit of hindsight, gained through over a decade of development of mobile phones, can the

Serial No.: 12/211,033  
Examiner Shirley Xueying Jian  
Group Art Unit 3769  
Page 13 of 17

claimed invention seem obvious. Accordingly, Applicant submits that the rejection based on the combination is improper and should be withdrawn.

**Conclusion**

Should the Examiner be of the view that an interview would expedite consideration of the application, request is made that the Examiner telephone the Applicants' attorney at (619) 818-4615 in order that any outstanding issues be resolved.

Dated: \_June 14, 2011\_\_\_\_\_

Respectfully submitted,

\_\_\_/Mark Wiczorek/\_\_\_\_\_

Attorney for Applicant  
Mayer & Williams, PC  
251 North Avenue West, 2nd Floor  
Westfield, NJ 07090  
Tel.: 703-433-0510  
Fax: 703-433-2362

Mark D. Wiczorek  
Registration No. 37,966

Serial No.: 12/211,033

Examiner Shirley Xueying Jian

Group Art Unit 3769

Page 14 of 17

APPENDIX I

(Declaration Under 37 CFR 1.131)

Serial No.: 12/211,033  
Examiner Shirley Xueying Jian  
Group Art Unit 3769  
Page 15 of 17

**IN THE UNITED STATES PATENT AND TRADEMARK OFFICE**

Applicants: Roger J. Quy  
Application No. 12/211,033  
Filed: September 15, 2008  
Title: METHOD AND APPARATUS FOR MONITORING EXERCISE  
WITH WIRELESS INTERNET CONNECTIVITY  
Art Unit: 3769  
Examiner: Shirley Jian  
Confirm. No.: 7693  
Docket No.: 00125/002005  
Via EFS Web  
Commissioner for Patents  
P.O. Box 1450  
Alexandria, VA 22313-1450

Certificate of Electronic Transmission  
Under 37 C.F.R. §1.8  
I hereby certify that this correspondence and any document referenced  
herein are being electronically filed with the USPTO via EFS-Web on  
  
Michelle Wolf  
(Printed Name of Person Sending Correspondence)  
  
\_\_\_\_\_  
(Signature)

Dear Sir:

**DECLARATION UNDER 37 CFR 1.131**

1. I, Roger Quy, do declare and state:
2. I am the sole inventor of claims 1-4 and 6-21 of the above-identified application.
3. On or before November 6, 1999, I completed my invention as described in the provisional patent application on which the above-identified non-provisional patent application is based, i.e., U.S. Provisional Patent Application Serial No. 60/172,486, as evidenced by the following:
  - a. I prepared the text of the above-identified provisional patent application.

- b. I signed the above-identified provisional patent application on November 6, 1999, as evidenced by my dated signature on the final page of the same, under the notation "I hereby declare that I am the Inventor of the above-described invention on this date."

I declare that all statements made herein of my own knowledge are true, and that all statements made on information and belief are believed to be true, and further that the statements were made with the knowledge that willful false statements and the like so made are punishable by fine or imprisonment, or both, under Section 1001 of Title 18 of the United States Code and that such willful false statements may jeopardize the validity of the application or any patent issuing thereon.

Date: \_\_\_\_\_

6/10/11

\_\_\_\_\_  
Roger Quy



Serial No.: 12/211,033  
Examiner Shirley Xueying Jian  
Group Art Unit 3769  
Page 17 of 17

APPENDIX II

(File History of Applicant's 60/172,486 provisional)

APPROV

PTO/SB/16 (6-95)  
 Approved for use through 04/11/98. OMB0651-0037  
 Patent and Trademark Office, U.S. DEPARTMENT OF COMMERCE

**PROVISIONAL APPLICATION COVER SHEET**

This is a request for filing a PROVISIONAL APPLICATION under 37 CFR § 1.53(c)

Express Mail label number EL341845416US Date of Deposit December 17, 1999  
 I hereby certify that this paper or fee is being deposited with the United States Postal Service  
 "Express Mail Post Office to Addressee" service under 37 CFR § 1.10  
 on the date indicated above and is addressed to the Assistant Commissioner for Patents, Washington, DC 20231.

Drew R. Herndon  
 Name of person signing

Drew R. Herndon  
 Signature

10541 U.S. PTO  
 60/172486  
 12/17/99

Docket Number	24450-701	Type a plus sign (+) inside this box	+
---------------	-----------	--------------------------------------	---

INVENTOR(S)/APPLICANT(S)			
LAST NAME	FIRST NAME	MIDDLE INITIAL	RESIDENCE (CITY AND EITHER STATE OR FOREIGN COUNTRY)
QUY	Roger	J.	Mill Valley, California USA
TITLE OF THE INVENTION (280 characters max)			
Method and Apparatus for Health and Disease Management Combining Patient Data Monitoring with Wireless Internet Connectivity			
CORRESPONDENCE ADDRESS			
WILSON SONSINI GOODRICH & ROSATI 650 Page Mill Road Palo Alto, California 94304-1050 Telephone: (650) 493-9300 Facsimile: (650) 493-6811			
ENCLOSED APPLICATION PARTS (check all that apply)			
<input checked="" type="checkbox"/> Specification	Number of Pages <u>3</u>	<input type="checkbox"/> Small Entity Statement	
<input checked="" type="checkbox"/> Drawing(s)	Number of Sheets <u>2</u>	<input type="checkbox"/> Other (specify) _____	
METHOD OF PAYMENT (check one)			
<input type="checkbox"/> A check or money order is enclosed to cover the Provisional filing fees.	PROVISIONAL FILING FEE AMOUNT (\$)	\$150.00	
<input checked="" type="checkbox"/> The Commissioner is hereby authorized to charge filing fees and credit Deposit Account Number: <u>23-2415</u> (Docket No. 24450-701)			

The invention was made by an agency of the United States Government or under a contract with an agency of the United States Government.

No.  
 Yes, the same of the U.S. Government agency and the Government contract numbers are: \_\_\_\_\_

Respectfully submitted,

SIGNATURE Paul Davis

Date: December 17, 1999

TYPED or PRINTED NAME Paul Davis REGISTRATION NO. 29,294 (if appropriate)

Additional inventors are being named on separately numbered sheets attached hereto.

**PROVISIONAL APPLICATION FILING ONLY**

DECLARATION OF INVENTION FOR PROVISIONAL PATENT APPLICATION

**Method and Apparatus for Health and Disease Management Combining Patient Data Monitoring with Wireless Internet Connectivity**

Background of the Invention

Previous inventions by the Inventor addressed the need to reduce health care costs through providing educational health care information and interactive physiological monitoring in the home environment by means of a user-friendly, interactive system (Patent #5,601,435 & CIPs). The previous inventions were based on a video game console, or a multimedia player (such as that manufactured by Philips/Magnavox) using a conventional television screen as the display device to achieve a system which is simpler to use than systems based on a personal computer.

Although the personal computer is prevalent in the U.S., it is too expensive for a consumer physiological monitoring system and there are many people who find it too complicated to set up and use for that purpose. High-risk, chronically ill patients, with diseases such as diabetes, asthma or cardiac abnormalities are responsible for more than half of health care costs in the US and form the fastest growing segment as a result of our aging population. However, it is the aging, chronically ill patient who is most likely not to be able to afford or use a system built around a personal computer.

The initial embodiment of the previous inventions utilized a compact disc to provide interactive information for disease management. In subsequent embodiments, the information could also be delivered from a server via a multimedia appliance with an Internet connection to the World Wide Web. The advent of television sets with built-in connections to the Internet (e.g. WebTV) provided yet another embodiment. Various medical devices, such as a blood glucose monitor, blood pressure recorder, respiratory flow meter or ambulatory ECG recorder, could be connected to the system. The data from the medical devices could control the display of information presented to the patient and be stored for review by a health care provider.

With the growing adoption of the Internet, there has been a rapid increase in the number of patients using it to obtain health care information relating to both the management of diseases such as diabetes, or to the development of a healthy life style, such as by exercise and diet. There are thousands of health care related web sites available and there are many companies collecting health care information and providing interactive information to patients via the Internet.

The advent of technology for wireless Internet connectivity enables an alternative system for interactive physiological monitoring and providing health-related information that is even less expensive and easier to use than one based on a television display. In addition,



the deployment of voice processing technology will enable the ultimate user interface: i.e. one to which patients can talk. One type of a wireless web device (WWD) currently available is the personal digital assistant (PDA) equipped with a wireless modem (e.g. Palm Pilot). Another type of WWD is the web-enabled cell-phone (WEP) and the new generation of WEPs also offers a voice-activated interface. A third type of WWD under development is a combination of both a computer and a cell-phone.

Software can be downloaded to the WWD from a server to provide a personalized display for the user, update information from health and disease management service companies, and control devices connected via a dataport to the WWD. The information supplied by health care web sites must be specially designed to suit the constraints of the small display screens of WWDs. However, the early adoption of such devices in Europe has demonstrated that their use to display information derived from the web is acceptable to consumers.

Wireless Internet connectivity has the advantage that the patient is not constrained to the place where the personal computer, information appliance or television set is located. For example, a diabetic could connect a blood glucose meter to a web-enabled cell phone while away from home and download data to a Diabetes Management Company's server and in response receive guidance displayed on the screen (or by voice) about choices for the next meal. Alternatively, the same person may take the WWD to the local gymnasium, send data output from various exercise machines over the Internet and receive a personalized response from the server of a company specializing in Health & Lifestyle Management. The connection of the WWD to a medical device, exercise machine or other health care equipment could be via a standardized data port, an adapter to extant interfaces such as RS232, infra red, radio frequency, or by default, the patient inputting data on the keypad.

Several companies have developed interactive voice response systems (IVR) for disease management which use extensive telephone menu trees, but these do not provide for connections to medical devices or the interactive display of data. Other companies provide medical devices equipped with modems, but these also do not provide the interactive display of health management information. Some companies (e.g. Health Hero Network Inc.) do offer systems with medical devices connected to the Internet to collect data and provide interactive patient information. However, these systems use a personal computer, a television screen, or proprietary appliance for the user interface and not a WWD; hence they are more expensive, more complicated to use, and lack mobility in comparison to the present invention.

### Summary of the Invention

The present invention is a method and system for assisting patients to manage a disease or maintain a healthy lifestyle by collecting patient data and providing information in response to those data by means of a wireless device designed to display interactive information through an connection to the Internet.

In the preferred embodiment of the present invention, a web-enabled wireless phone (e.g. Sprint PCS Phone) is coupled to a medical monitoring device, such as (but not limited to) a blood glucose meter. An adapter is used if necessary to convert the output signal of the medical data monitor to a suitable input signal for the phone. The patient connects to a specific Internet site and a software program, resident on a remote server located on the Internet, downloads an interactive user interface for that patient and the measurement of the physiological data. Further information may be provided to the patient in response to the data or to other inputs that have been entered by voice or keypad.

In place of a conventional medical monitoring device, the web-enabled wireless phone may be coupled to other devices which provide health related information data, such as an electronic scale, a body fat gauge, biofeedback devices, physio-therapy or chiropractic equipment, or any type of exercise machine. The user connects to the Internet and a software program, resident on a remote server located on the Internet, captures data from the coupled device and downloads interactive information that relates to health management. Further information may be provided to the user in response to the data or to other inputs that have been entered by voice or keypad.

In an alternative embodiment of the present invention the web-enabled wireless phone is replaced in the above applications by a palm computer or "personal digital assistant" (PDA) that is equipped with a wireless modem and a web interface (e.g., the Palm Pilot Internet models).

In an alternative embodiment of the present invention, the web-enabled wireless phone, or wireless PDA, is replaced in the above applications by a device that combines the functions of a computer, PDA and a telephone, such as the next generation of cell-phones or satellite phones that have been demonstrated by several manufacturers.

Inventor

I hereby declare that I am the Inventor of the above-described invention on this date.

Signed,

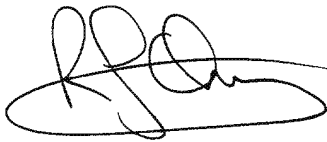

Roger J. Quay Ph.D.

Date, November 6<sup>th</sup>, 1999.



**SAMSUNG**

Model: SGH-D600

The Sprint PCS phone

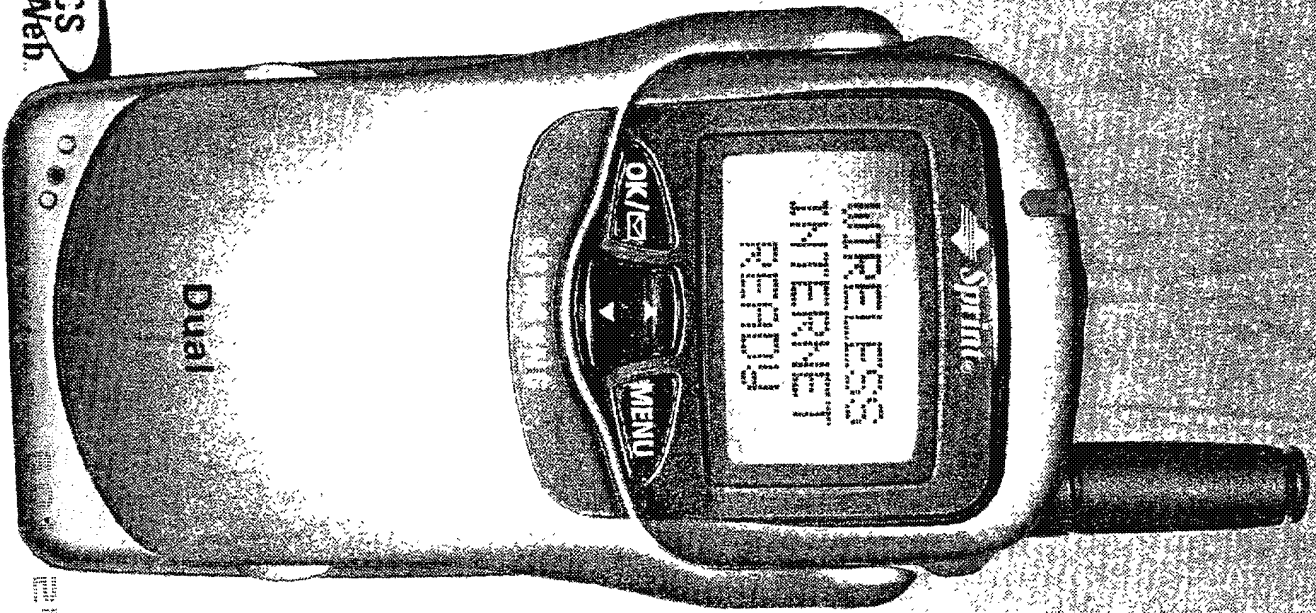

Sprint PCS  
Wireless Web

You can tell it things.  
It can tell you things.

© 2006 Samsung Electronics Co., Ltd.

Serial No.: 12/211,033  
Examiner Shirley Xueying Jian  
Group Art Unit 3769

APPENDIX III

(File Histories of Mault Provisional Cases that were filed prior to Applicant's effective date of invention of the 60/172,486 Provisional Patent Application, as evidenced by Applicant's DECLARATION OF INVENTION dated 11/6/99)

Please type a plus sign (+) inside this box

→  Express Mail No.  
EL456630913US

Docket Number: MJA-13118/03

**PROVISIONAL APPLICATION FOR PATENT COVER SHEET (Large Entity)**

*A/Prov*

This is a request for filing a PROVISIONAL APPLICATION FOR PATENT under 37 CFR 1.53 (c).

09/24/99

15541 U.S. PTO  
75957/09  
60/155051  
09/24/99

INVENTOR(S)/APPLICANT(S)					
Given Name (first and middle [if any])	Family Name or Surname	Residence (City and either State or Foreign Country)			
James R. Noel	Mault Johnson	Evergreen, Colorado, US Saratoga, California, US			
Additional inventors are being named on page 2 attached hereto					
TITLE OF THE INVENTION (280 characters max)					
PHYSIOLOGICAL MONITOR AND ASSOCIATED COMPUTATION, DISPLAY AND COMMUNICATION UNIT					
CORRESPONDENCE ADDRESS					
Direct all correspondence to:					
<input type="checkbox"/>	Customer Number			Place Customer Number Bar Code Label here	
OR					
<input checked="" type="checkbox"/>	Firm or Individual Name	Allen M. Krass, Eq.			
Address		Gifford, Krass, Groh, Sprinkle, Anderson & Citkowski, P.C.			
Address		280 N. Old Woodward, Suite 400			
City	Birmingham	State	MI	ZIP	48009
Country	US	Telephone	248-647-6000	Fax	248-647-5210
ENCLOSED APPLICATION PARTS (check all that apply)					
<input checked="" type="checkbox"/>	Specification	Number of Pages	4		
<input type="checkbox"/>	Drawing(s)	Number of Sheets			
<input type="checkbox"/>	Other (specify)				
METHOD OF PAYMENT OF FILING FEES FOR THIS PROVISIONAL APPLICATION FOR PATENT (check one)					
<input checked="" type="checkbox"/>	A check or money order is enclosed to cover the filing fees				FILING FEE AMOUNT
<input type="checkbox"/>	The Commissioner is hereby authorized to charge filing fees or credit any overpayment to Deposit Account Number:				
			07-1180		\$150.00
The invention was made by an agency of the United States Government or under a contract with an agency of the United States Government.					
<input checked="" type="checkbox"/>	No.				
<input type="checkbox"/>	Yes, the name of the U.S. Government agency and the Government contract number are:				

Respectfully submitted,

SIGNATURE

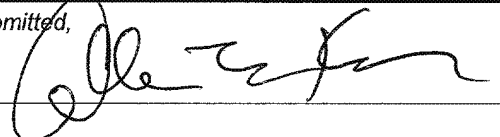

DATE

9/24/99

TYPED or PRINTED NAME

Allen M. Krass

REGISTRATION NO.  
(if appropriate)

18,277

TELEPHONE

248-647-6000

**USE ONLY FOR FILING A PROVISIONAL APPLICATION FOR PATENT**

SEND TO: Box Provisional Application, Assistant Commissioner for Patents, Washington, DC 20231

**PHYSIOLOGICAL MONITOR AND ASSOCIATED  
COMPUTATION, DISPLAY AND COMMUNICATION UNIT**

This invention relates to a physiological monitor for use in measuring a health characteristic of a user, such as metabolism, weight, body fat percentage, heart rate, ECG, blood pressure, blood oxygenation or the like, and an associated hand-held computer, often termed personal digital assistant (PDA), which acts to receive, record, compute and/or transmit signals from the monitor. The PDA is preferably of the type adapted to receive a variety of plug-in modules each of which provide the PDA with a particular application program. Plug-in modules used with the present invention also incorporate connections to the sensors forming part of the physiological monitor, as well as electronics which acts as an interface between the sensors of the physiological monitor and the PDA.

In one form of the invention the plug-in module for the PDA is formed as an integral part of the physiological monitor, and when the PDA is connected to the plug-in module, it effectively becomes an integral part of the monitor, providing the necessary computation and display section of the monitor. When the monitor is not at use the PDA may be removed and used for alternative purposes, possibly with other plug-in modules. In this embodiment, the plug-in module which carries the application program that converts the PDA into the computation and display unit for the monitor is physically supported on the monitor to allow the PDA to be connected to the module so that its keyboard is accessible to the user or to a tester and its display is visible. The plug-in module for the PDA may be permanently attached to the monitor or it may be separable from the monitor via a connector.

In a preferred embodiment of the invention, the physiological monitor constitutes an indirect calorimeter for the measurement of the user's metabolism and related respiratory factors

92309tlt

MJA-13118/03

as disclosed in my provisional patent application Serial No. \_\_\_\_\_. [the last one filed].

That calorimeter incorporates a mask that the user breaths through. The electrical signals generated by the flow meter and the gas sensor are provided to a computation and display unit as disclosed in the provisional application, but would be provided to the plug-in module for the PDA in the present invention.

The PDA could be attached to the plug-in module during the test period to serve as the computation and display unit for the monitor or, alternatively, the plug-in module could incorporate a memory, preferably of non-volatile form such as flash memory. During the test, the signal provided to the module by the sensor is conditioned and stored. At the completion of the test, the plug-in module could be detached from the calorimeter and inserted into the PDA. The PDA would then run portions of the application program stored in the plug-in module to process the stored calorimeter signals and display the results on the PDA screen.

The PDA preferably incorporates apparatus for communicating the results of the calorimeter test to a central station via a telecommunication network such as the Internet. The same link preferably returns signals to the PDA for display to provide communication to the user. The link between the PDA and the telecommunications network could be wired as by a plug-in module for the PDA which electrically connects to the network or via a wireless connection to a transceiver which is connected to the network. The connection could be through an intermediate unit such as a personal computer which connects to the network through a modem or the like.

Devices of the present invention are useful for monitoring a wide variety of physiological conditions. In connection with weight monitoring and weight loss programs the monitor may measure metabolism via an indirect calorimeter, body fat via conductance measurements,



92309tl

MJA-13118/03

individual activity through an accelerometer or pedometer and weight through a scale. Other physiological parameters that could be measured include breath flow using a spirometer, blood pressure employing an automatic or manual cuff type apparatus which might include a finger cuff, oxygenation using a finger cuff, glucose levels, EKG either alone or combined with a heart sound monitor, heart sound monitor alone, bone density. The unit could also include a bar code scanner which could be used to read bar codes on packages for food items consumed so as to determine their nature or caloric content.

In an alternative embodiment of the invention, the computer application program which controls the receipt and analysis of the input sensor signals and controls the computation and display of the results of the respiratory factor analysis is stored within a handheld computer itself such as a Palm Pilot. The Palm Pilot has a connector for the input of data which could be attached to a mating connector halve fixed to the monitor. In the case of a calorimeter of the type disclosed in my previous application, the computation and display unit which forms an integral part of the non-disposable section of the calorimeter as disclosed could be eliminated and replaced by a socket to receive the Palm Pilot with a suitable application program loaded in. The application could be stored in a mass storage device forming part of the Palm Pilot and loaded into operating memory at the time of use with the monitoring device. Otherwise, once detached from the monitoring device, the Palm Pilot could serve other functions. The Palm Pilot might also store the results of repeated tests and progress charts based on those results.

Having thus described my invention, I claim:

92309tt

MJA-13118/03

CLAIMS

1. A physiological monitor adapted to generate electrical signals representative of sensor signals during a test and a handheld computer for receiving and processing the signals and generating a display of the results, and a connector on the computer adapted to join with a mating connector supported on the monitor to provide the sensor signals to the computer.

TT-C:\mja13118.app.doc

6542607 FSDS

Please type a plus sign (+) inside this →

**EL 422047181US**

Docket Number:

MJA-10381/03

10/08/99

JC1553 U.S. PTO  
 60/158553  
 10/08/99

**PROVISIONAL APPLICATION FOR PATENT COVER SHEET (Small Entity)**

This is a request for filing a PROVISIONAL APPLICATION FOR PATENT under 37 CFR 1.53 (c).

INVENTOR(S)/APPLICANT(S)					
Given Name (first and middle [if any])	Family Name or Surname	Residence (City and either State or Foreign Country)			
James R.	Mault	Evergreen, Colorado, US			
<input type="checkbox"/> Additional inventors are being named on page 2 attached hereto					
TITLE OF THE INVENTION (280 characters max)					
INTEGRATED CALORIE MANAGEMENT SYSTEM					
CORRESPONDENCE ADDRESS					
Direct all correspondence to:					
<input type="checkbox"/> Customer Number <input style="width: 100px;" type="text"/>		Place Customer Number Bar Code Label here			
OR					
<input checked="" type="checkbox"/> Firm or Individual Name	Allen M. Krass, Esq.				
Address	GIFFORD, KRASS, GROH, SPRINKLE, ANDERSON & CITKOWSKI, P.C.				
Address	280 N. Old Woodward, Suite 400				
City	Birmingham	State	MI	ZIP	48009
Country	US	Telephone	248-647-6000	Fax	248-647-5210
ENCLOSED APPLICATION PARTS (check all that apply)					
<input checked="" type="checkbox"/> Specification	Number of Pages	5	<input checked="" type="checkbox"/> Small Entity Statement		
<input type="checkbox"/> Drawing(s)	Number of Sheets	<input style="width: 50px;" type="text"/>	<input type="checkbox"/> Other (specify)	<input style="width: 150px;" type="text"/>	
METHOD OF PAYMENT OF FILING FEES FOR THIS PROVISIONAL APPLICATION FOR PATENT (check one)					
<input checked="" type="checkbox"/>	A check or money order is enclosed to cover the filing fees				FILING FEE AMOUNT
<input type="checkbox"/>	The Commissioner is hereby authorized to charge filing fees or credit any overpayment to Deposit Account Number. <input style="width: 100px;" type="text"/>				\$75.00
The invention was made by an agency of the United States Government or under a contract with an agency of the United States Government.					
<input checked="" type="checkbox"/>	No.				
<input type="checkbox"/>	Yes, the name of the U S Government agency and the Government contract number are: _____				

Respectfully submitted,

SIGNATURE

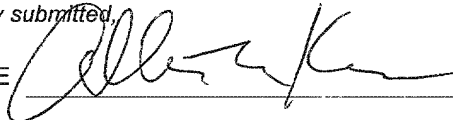

Date

10/8/99

TYPED or PRINTED NAME

Allen M. Krass

REGISTRATION NO.  
(if appropriate)

18,277

TELEPHONE

248-647-6000

**USE ONLY FOR FILING A PROVISIONAL APPLICATION FOR PATENT**

SEND TO: Box Provisional Application, Assistant Commissioner for Patents, Washington, DC 20231

<b>VERIFIED STATEMENT (DECLARATION) CLAIMING SMALL ENTITY STATUS (37 CFR 1.9(f) AND 1.27 (b)) - INDEPENDENT INVENTOR</b>			Docket No. <b>MJA-10381/03</b>
Serial No.	Filing Date	Patent No.	Issue Date
Applicant/ <b>James R. Mault</b> Patentee:			
Invention: <b>INTEGRATED CALORIE MANAGEMENT SYSTEM</b>			
<p>As a below named inventor, I hereby declare that I qualify as an independent inventor as defined in 37 CFR 1.9(c) for purposes of paying reduced fees under section 41(a) and (b) of Title 35, United States Code, to the Patent and Trademark Office with regard to the invention entitled above and described in:</p> <p><input checked="" type="checkbox"/> the specification to be filed herewith.</p> <p><input type="checkbox"/> the application identified above.</p> <p><input type="checkbox"/> the patent identified above.</p> <p>I have not assigned, granted, conveyed or licensed and am under no obligation under contract or law to assign, grant, convey or license, any rights in the invention to any person who could not be classified as an independent inventor under 37 CFR 1.9(c) if that person had made the invention, or to any concern which would not qualify as a small business concern under 37 CFR 1.9(d) or a nonprofit organization under 37 CFR 1.9(e).</p> <p>Each person, concern or organization to which I have assigned, granted, conveyed, or licensed or am under an obligation under contract or law to assign, grant, convey, or license any rights in the invention is listed below:</p> <p><input checked="" type="checkbox"/> No such person, concern or organization exists.</p> <p><input type="checkbox"/> Each such person, concern or organization is listed below.</p> <p><b>*NOTE:</b> Separate verified statements are required from each named person, concern or organization having rights to the invention averring to their status as small entities (37 CFR 1.27)</p>			
FULL NAME _____ ADDRESS _____ <input type="checkbox"/> Individual <input type="checkbox"/> Small Business Concern <input type="checkbox"/> Nonprofit Organization			
FULL NAME _____ ADDRESS _____ <input type="checkbox"/> Individual <input type="checkbox"/> Small Business Concern <input type="checkbox"/> Nonprofit Organization			
FULL NAME _____ ADDRESS _____ <input type="checkbox"/> Individual <input type="checkbox"/> Small Business Concern <input type="checkbox"/> Nonprofit Organization			
FULL NAME _____ ADDRESS _____ <input type="checkbox"/> Individual <input type="checkbox"/> Small Business Concern <input type="checkbox"/> Nonprofit Organization			

I acknowledge the duty to file, in this application or patent, notification of any change in status resulting in loss of entitlement to small entity status prior to paying, or at the time of paying, the earliest of the issue fee or any maintenance fee due after the date on which status as a small entity is no longer appropriate. (37 CFR 1.28(b))

I hereby declare that all statements made herein of my own knowledge are true and that all statements made on information and belief are believed to be true; and further that these statements were made with the knowledge that willful false statements and the like so made are punishable by fine or imprisonment, or both, under Section 1001 of Title 18 of the United States Code, and that such willful false statements may jeopardize the validity of the application, any patent issuing thereon, or any patent to which this verified statement is directed.

NAME OF INVENTOR James R. Mault

SIGNATURE OF INVENTOR

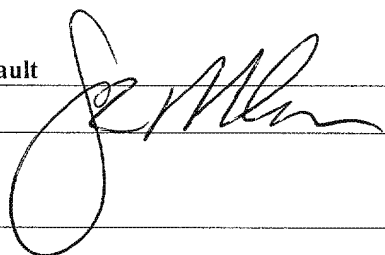

DATE:

10/8/99

NAME OF INVENTOR \_\_\_\_\_

SIGNATURE OF INVENTOR \_\_\_\_\_

DATE: \_\_\_\_\_

NAME OF INVENTOR \_\_\_\_\_

SIGNATURE OF INVENTOR \_\_\_\_\_

DATE: \_\_\_\_\_

NAME OF INVENTOR \_\_\_\_\_

SIGNATURE OF INVENTOR \_\_\_\_\_

DATE: \_\_\_\_\_

NAME OF INVENTOR \_\_\_\_\_

SIGNATURE OF INVENTOR \_\_\_\_\_

DATE: \_\_\_\_\_

NAME OF INVENTOR \_\_\_\_\_

SIGNATURE OF INVENTOR \_\_\_\_\_

DATE: \_\_\_\_\_

NAME OF INVENTOR \_\_\_\_\_

SIGNATURE OF INVENTOR \_\_\_\_\_

DATE: \_\_\_\_\_

NAME OF INVENTOR \_\_\_\_\_

SIGNATURE OF INVENTOR \_\_\_\_\_

DATE: \_\_\_\_\_

NAME OF INVENTOR \_\_\_\_\_

SIGNATURE OF INVENTOR \_\_\_\_\_

DATE: \_\_\_\_\_

NAME OF INVENTOR \_\_\_\_\_

SIGNATURE OF INVENTOR \_\_\_\_\_

DATE: \_\_\_\_\_

MJA10381/03  
October 8, 1999  
3:40 PM

**INTEGRATED CALORIE MANAGEMENT SYSTEM**

This invention relates to a calorie management system. The system measures those bodily functions and activities of a patient which relate to nutrition and weight management and provides that information to a computer system which monitors the patient's activity to make adjustments in the recommended diet and/or activity level in order to achieve a particular weight goal. The computer may be located conveniently to the user for personal use or may be located at some remote site so that communication is via telephone, Internet, or the like. At the remote site, a computer maintains files for each of the users and the activity and status of the user is monitored either by a computer program, by personal observation of a physician, nutritionist, etc., or by both to determine recommended changes in the user's diet and/or activity level, which are communicated back to the user via the telecommunications link. Each user preferably has a respiratory calorimeter capable of measuring the user's resting energy expenditure or activity energy expenditure, as well as other related parameters such as respiratory quotient; a dietary intake database in which the user enters the type of food or beverage consumed and the size of the portion; an activity level monitor which the user carries to record the activity level during each day; and a scale for use to determine the user's weight. Each of these units has an electrical output in a common format, which is provided to the local computer or to a telecommunication module, which converts the signals

053007-2-00000000

990810t1t

- 2 -

into suitable format for transmission to the remote site using a modem or the like. The calorimeter and scale may be permanently wired to the local computer or telecommunications unit or may be plugable into a base unit. The activity monitor is carried with the individual and communicates with the local computer or remote transmission unit electrically, either by wire, infrared link, or the like. In use, on a regular basis, which may be daily, every few days, weekly or the like, the user employs the respiratory calorimeter to measure his or her resting energy expenditure. The calorimeter may be of the type disclosed in Mault Patent Nos. 4,917,108; 5,038,792; 5,178,155; and 5,179,958 wherein the user breathes through a mouthpiece for a period of minutes to determine resting energy expenditure. The scale may or may not have a dial for providing information to the user as to his or her weight, but communicates electrically, in the common electronic language of the devices, to the local computer or telecommunications unit. This eliminates the possibility of the user falsely reporting weight for vanity purposes or the like.

The diet intake database preferably constitutes a portable unit in which the user reports the nature and quantity of dietary intake. The device may take the form of a personal communication unit or palm top computer and preferably will incorporate caloric information for display to the user and lists of acceptable foods and the like. The unit incorporates a database of common foods, their caloric contents for specific quantities, etc. This unit has an electrical output in the common format of the system for loading into the local computer or communications device for transmission to the remote computer. The computer,

66007-2333403

990810t1t

- 3 -

either local or remote, tabulates the user's caloric intakes and expenditures and relates them to the measured weight to make determinations for modifications of the recommended diet and/or activity level.

Through use of the remote computer, intervention by a trained dietary technician will allow necessary modifications in the user's activity or diet for special cases.

The computer, either local or remote, will store the inputs in a file and provide output plots of values taken over a period of time so that feedback and trends in the performance can be detected.

The portable unit which forms the diet intake database may constitute a personal digital assistant such as a Palm Pilot, Handspring, Vector, or the like. The unit may have a connector adapted to receive plug-in modules which incorporate application programs for the device so that as different plug-in modules are inserted the unit can perform different functions. The PDA is preferably adapted to be coupled to the activity level monitor, the scale and other units which are useful for weight management such as a heart rate monitor, a bar code scanner for use in determining dietary information from food packaging, a food scale, a body fat analyzer or the like. Any of these monitoring devices may be directly coupled to the PDA or PC via its input ports; may be coupled to a plug-in module for the PDA which provides an application program for a specific purpose; or may be coupled through a wireless infrared channel or the like.

990810t1t



990810t1t

- 4 -

The PDA preferably stores an application program for receiving digital input signals from each of the monitoring devices, instructions from a central computer, and signals entered by the user. These inputs allow the user to interactively relate to the program which instructs the user on dietary activities, when to couple to a monitoring device, etc.

I claim:

66007" 50003703

990810t1t

- 5 -

CLAIMS

1. An integrated calorie management system comprising:  
a portable unit including a database of a caloric contents of a variety of common foods;  
a plurality of plug-in modules for the portable unit including application programs for the portable unit;  
an activity monitor, a scale and other physiological parameters; and  
interface coupling the monitors for physiological parameters to the portable unit.

990810t1t

APPROV

Please type a plus sign (+) inside this box

→ + EL422047164US

Docket Number:

MJA-13418/03

10/08/99

# PROVISIONAL APPLICATION FOR PATENT COVER SHEET (Small Entity)

This is a request for filing a PROVISIONAL APPLICATION FOR PATENT under 37 CFR 1.53 (c).

## INVENTOR(S)/APPLICANT(S)

Given Name (first and middle (if any)) James R.	Family Name or Surname Mault	Residence (City and either State or Foreign Country) Evergreen, Colorado, US
--	---------------------------------	---

Additional inventors are being named on page 2 attached hereto

## TITLE OF THE INVENTION (280 characters max)

METHOD AND APPARATUS FOR ESTIMATING CALORIC EXPENDITURES USING BODY ACTIVITY MONITORS

## CORRESPONDENCE ADDRESS

Direct all correspondence to:

Customer Number

Place Customer Number Bar Code Label here

OR

<input checked="" type="checkbox"/> Firm or Individual Name	Allen M. Krass, Esq.					
Address	GIFFORD, KRASS, GROH, SPRINKLE, ANDERSON & CITKOWSKI, P.C.					
Address	280 N. Old Woodward, Suite 400					
City	Birmingham	State	MI	ZIP	48009	
Country	US	Telephone	248-647-6000	Fax	248-647-5210	

## ENCLOSED APPLICATION PARTS (check all that apply)

<input checked="" type="checkbox"/> Specification	Number of Pages	<input type="text" value="3"/>	<input checked="" type="checkbox"/> Small Entity Statement
<input type="checkbox"/> Drawing(s)	Number of Sheets	<input type="text"/>	<input type="checkbox"/> Other (specify) <input type="text"/>

## METHOD OF PAYMENT OF FILING FEES FOR THIS PROVISIONAL APPLICATION FOR PATENT (check one)

<input type="checkbox"/> A check or money order is enclosed to cover the filing fees	FILING FEE AMOUNT
<input checked="" type="checkbox"/> The Commissioner is hereby authorized to charge filing fees or credit any overpayment to Deposit Account Number.	<input type="text" value="07-1180"/> <input type="text" value="\$75.00"/>

The invention was made by an agency of the United States Government or under a contract with an agency of the United States Government.

No.  
 Yes, the name of the U.S. Government agency and the Government contract number are \_\_\_\_\_

Respectfully submitted,

SIGNATURE

Date

10/8/99

TYPED or PRINTED NAME

Allen M. Krass

REGISTRATION NO.  
(if appropriate)

18,277

TELEPHONE

248-647-6000

## USE ONLY FOR FILING A PROVISIONAL APPLICATION FOR PATENT

SEND TO: Box Provisional Application, Assistant Commissioner for Patents, Washington, DC 20231

JC 553 U.S. PTO  
60/158554  
10/08/99

<b>VERIFIED STATEMENT (DECLARATION) CLAIMING SMALL ENTITY STATUS (37 CFR 1.9(f) AND 1.27 (b)) - INDEPENDENT INVENTOR</b>			Docket No. MJA-13418/03
Serial No.	Filing Date	Patent No.	Issue Date
Applicant/ <b>James R. Mault</b> Patentee:			
Invention: <b>METHOD AND APPARATUS FOR ESTIMATING CALORIC EXPENDITURES USING BODY ACTIVITY MONITORS</b>			
<p>As a below named inventor, I hereby declare that I qualify as an independent inventor as defined in 37 CFR 1.9(c) for purposes of paying reduced fees under section 41(a) and (b) of Title 35, United States Code, to the Patent and Trademark Office with regard to the invention entitled above and described in:</p> <p><input checked="" type="checkbox"/> the specification to be filed herewith.</p> <p><input type="checkbox"/> the application identified above.</p> <p><input type="checkbox"/> the patent identified above.</p> <p>I have not assigned, granted, conveyed or licensed and am under no obligation under contract or law to assign, grant, convey or license, any rights in the invention to any person who could not be classified as an independent inventor under 37 CFR 1.9(c) if that person had made the invention, or to any concern which would not qualify as a small business concern under 37 CFR 1.9(d) or a nonprofit organization under 37 CFR 1.9(e).</p> <p>Each person, concern or organization to which I have assigned, granted, conveyed, or licensed or am under an obligation under contract or law to assign, grant, convey, or license any rights in the invention is listed below:</p> <p><input checked="" type="checkbox"/> No such person, concern or organization exists.</p> <p><input type="checkbox"/> Each such person, concern or organization is listed below.</p> <p><b>*NOTE:</b> Separate verified statements are required from each named person, concern or organization having rights to the invention averring to their status as small entities (37 CFR 1.27)</p>			
FULL NAME _____ ADDRESS _____ <input type="checkbox"/> Individual <input type="checkbox"/> Small Business Concern <input type="checkbox"/> Nonprofit Organization			
FULL NAME _____ ADDRESS _____ <input type="checkbox"/> Individual <input type="checkbox"/> Small Business Concern <input type="checkbox"/> Nonprofit Organization			
FULL NAME _____ ADDRESS _____ <input type="checkbox"/> Individual <input type="checkbox"/> Small Business Concern <input type="checkbox"/> Nonprofit Organization			
FULL NAME _____ ADDRESS _____ <input type="checkbox"/> Individual <input type="checkbox"/> Small Business Concern <input type="checkbox"/> Nonprofit Organization			

I acknowledge the duty to file, in this application or patent, notification of any change in status resulting in loss of entitlement to small entity status prior to paying, or at the time of paying, the earliest of the issue fee or any maintenance fee due after the date on which status as a small entity is no longer appropriate. (37 CFR 1.28(b))

I hereby declare that all statements made herein of my own knowledge are true and that all statements made on information and belief are believed to be true; and further that these statements were made with the knowledge that willful false statements and the like so made are punishable by fine or imprisonment, or both, under Section 1001 of Title 18 of the United States Code, and that such willful false statements may jeopardize the validity of the application, any patent issuing thereon, or any patent to which this verified statement is directed.

NAME OF INVENTOR James R. Mault

SIGNATURE OF INVENTOR 

DATE: 10/8/99

NAME OF INVENTOR \_\_\_\_\_

SIGNATURE OF INVENTOR \_\_\_\_\_

DATE: \_\_\_\_\_

NAME OF INVENTOR \_\_\_\_\_

SIGNATURE OF INVENTOR \_\_\_\_\_

DATE: \_\_\_\_\_

NAME OF INVENTOR \_\_\_\_\_

SIGNATURE OF INVENTOR \_\_\_\_\_

DATE: \_\_\_\_\_

NAME OF INVENTOR \_\_\_\_\_

SIGNATURE OF INVENTOR \_\_\_\_\_

DATE: \_\_\_\_\_

NAME OF INVENTOR \_\_\_\_\_

SIGNATURE OF INVENTOR \_\_\_\_\_

DATE: \_\_\_\_\_

NAME OF INVENTOR \_\_\_\_\_

SIGNATURE OF INVENTOR \_\_\_\_\_

DATE: \_\_\_\_\_

NAME OF INVENTOR \_\_\_\_\_

SIGNATURE OF INVENTOR \_\_\_\_\_

DATE: \_\_\_\_\_

NAME OF INVENTOR \_\_\_\_\_

SIGNATURE OF INVENTOR \_\_\_\_\_

DATE: \_\_\_\_\_

NAME OF INVENTOR \_\_\_\_\_

SIGNATURE OF INVENTOR \_\_\_\_\_

DATE: \_\_\_\_\_

MJA-13418/03  
91008gs

**METHOD AND APPARATUS FOR ESTIMATING CALORIC  
EXPENDITURES USING BODY ACTIVITY MONITORS**

Accelerometers and related devices which are attached to the body of a subject and generate signals representative of body activity have long been used to estimate caloric expenditures during a period in which body activity is monitored. However, the estimates of caloric expenditure to achieve the measured body movement are strictly gross estimates and the same factors are used for all individuals.

The present invention involves the actual measurement of caloric expenditure using indirect calorimetry and the simultaneous measurement of body motion or heart rate during periods of body activity in order to determine the caloric expenditure of the individual required to achieve that body activity. Thereafter, measurements of body activity or heart rate may be converted into caloric expenditure utilizing the calibration measurements made during the test periods.

It would be difficult to constantly measure caloric expenditures by indirect calorimetry involving the measurement of oxygen consumption. Such indirect calorimeters typically measure the gas flow and gas constituents of inhaled and exhaled gases. While this is relatively easy to do for subjects at rest and can be performed with exercising subjects for limited periods of time, it can't be conveniently done on a continuous 24 hour basis. On the other hand, accelerometers, pedometers and the like, and heart rate monitors, which can be attached to the body and generate a measure of body activity, can be used on a continuous basis. By measuring caloric expenditure during relatively

MJA-13418/03  
91008gs

short periods of a variety of exercise activities at the same time as signals from the activity monitors or heart monitors are stored, the correlation factor between an individual's energy expenditure and activity is measured by a monitor and can be readily determined.

5           The correlation factors can be stored in a table so that caloric expenditure can be accurately determined from subsequent activity or heart rate measurements.

I claim:

10

MJA-13418/03  
91008gs

CLAIMS

1. The method of measuring caloric expenditure based on measurements of body activity or heart rate, comprising:

measuring caloric expenditure using indirect calorimetry and  
5 simultaneously measuring body activity or heart rate to establish a correlation factor between body activity or heart rate and caloric expenditure and subsequently measuring body activity or heart rate and determining caloric expenditure based on a calibration table.



*Approved*

10/08/99

Please type a plus sign (+) inside this →  **EL422047195US** Docket Number: **MJA-13180/03**

**PROVISIONAL APPLICATION FOR PATENT COVER SHEET (Large Entity)**

This is a request for filing a PROVISIONAL APPLICATION FOR PATENT under 37 CFR 1.53 (c).

JC553 U.S. PTO  
60/156556

INVENTOR(S)/APPLICANT(S)					
Given Name (first and middle [if any])	Family Name or Surname	Residence (City and either State or Foreign Country)			
James R. Noel	Mault Johnson	Evergreen, Colorado, US Saratoga, California, US			
<input type="checkbox"/> Additional inventors are being named on page 2 attached hereto					
TITLE OF THE INVENTION (280 characters max)					
PHYSIOLOGICAL MONITOR AND ASSOCIATED COMPUTATION, DISPLAY AND COMMUNICATION UNIT					
CORRESPONDENCE ADDRESS					
Direct all correspondence to:					
<input type="checkbox"/> Customer Number				Place Customer Number Bar Code Label here	
OR					
<input checked="" type="checkbox"/> Firm or Individual Name	Allen M. Krass, Eq.				
Address	Gifford, Krass, Groh, Sprinkle, Anderson & Citkowski, P.C.				
Address	280 N. Old Woodward, Suite 400				
City	Birmingham	State	MI	ZIP	48009
Country	US	Telephone	248-647-6000	Fax	248-647-5210
ENCLOSED APPLICATION PARTS (check all that apply)					
<input checked="" type="checkbox"/> Specification	Number of Pages	7			
<input type="checkbox"/> Drawing(s)	Number of Sheets				
		<input type="checkbox"/> Other (specify)			
METHOD OF PAYMENT OF FILING FEES FOR THIS PROVISIONAL APPLICATION FOR PATENT (check one)					
<input checked="" type="checkbox"/>	A check or money order is enclosed to cover the filing fees				FILING FEE AMOUNT
<input type="checkbox"/>	The Commissioner is hereby authorized to charge filing fees or credit any overpayment to Deposit Account Number:				\$150.00
		07-1180			
The invention was made by an agency of the United States Government or under a contract with an agency of the United States Government.					
<input checked="" type="checkbox"/>	No.				
<input type="checkbox"/>	Yes, the name of the U.S. Government agency and the Government contract number are: _____				

Respectfully submitted,

SIGNATURE

DATE 10/8/99

TYPED or PRINTED NAME Allen M. Krass

REGISTRATION NO. (if appropriate) 18,277

TELEPHONE 248-647-6000

**USE ONLY FOR FILING A PROVISIONAL APPLICATION FOR PATENT**  
 SEND TO: Box Provisional Application, Assistant Commissioner for Patents, Washington, DC 20231

MJA-13180/03  
October 8, 1999  
4:10 PM

**PHYSIOLOGICAL MONITOR AND ASSOCIATED  
COMPUTATION, DISPLAY AND COMMUNICATION UNIT**

This invention relates to a physiological monitor for use in measuring a health characteristic of a user, such as metabolism, weight, body fat percentage, heart rate, ECG, blood pressure, blood oxygenation or the like, and an associated hand-held computer, often termed personal digital assistant (PDA), which acts to receive, record, compute and/or transmit signals from the monitor. The PDA is preferably of the type adapted to receive a variety of plug-in modules each of which provide the PDA with a particular application program. Plug-in modules used with the present invention also incorporate connections to the sensors forming part of the physiological monitor, as well as electronics which acts as an interface between the sensors of the physiological monitor and the PDA.

In one form of the invention the plug-in module for the PDA is formed as an integral part of the physiological monitor, and when the PDA is connected to the plug-in module, it effectively becomes an integral part of the monitor, providing the necessary computation and display section of the monitor. When the monitor is not at use the PDA may be removed and used for alternative purposes, possibly with other plug-in modules. In this embodiment, the plug-in module which carries the application program that converts the PDA into the computation and display unit for the physiological monitor is physically supported on the monitor to allow the PDA to be connected to the module so that its keyboard is accessible to the user or to a tester and its display is visible. The plug-in module for the PDA may be permanently attached to the monitor or it may be separable from the monitor via a connector.

In a preferred embodiment of the invention, the physiological monitor constitutes an indirect calorimeter for the measurement of the user's metabolism and related respiratory factors

92909tlt  
MJA-13180/03

as disclosed in my provisional patent application Serial No. 60/155,035. That calorimeter incorporates a mask or mouthpiece that the user breaths through. The electrical signals generated by the flow meter and the gas sensor(s) are provided to a computation and display unit as disclosed in the provisional application, but would be provided to the plug-in module for the PDA in the present invention.

The PDA could be attached to the plug-in module during the test period to serve as the computation and display unit for the monitor or, alternatively, the plug-in module could incorporate a memory, preferably of non-volatile form such as flash memory. During the test, the signal provided to the module by the sensor is conditioned and stored. At the completion of the test, the plug-in module could be detached from the calorimeter and inserted into the PDA. The PDA would then run portions of the application program stored in the plug-in module to process the stored calorimeter signals and display the results on the PDA screen.

The PDA preferably incorporates apparatus for communicating the results of the calorimeter test to a central station via a telecommunication network such as the Internet. The same link preferably returns signals to the PDA for display to provide communication to the user. The link between the PDA and the telecommunications network could be wired as by a plug-in module for the PDA which electrically connects to the network or via a wireless connection to a transceiver which is connected to the network. The connection could be through an intermediate unit such as a personal computer which connects to the network through a modem or the like.

Devices of the present invention are useful for monitoring a wide variety of physiological conditions. In connection with weight monitoring and weight loss programs the monitor may measure metabolism via an indirect calorimeter, body fat via conductance measurements,

92909tlt  
MJA-13180/03

hydration via short term variation in conductance measurements, individual activity through an accelerometer or pedometer, heart rate monitor and weight through a scale. The PDA could interface with a food scale to allow caloric intake to be monitored. Other physiological parameters that could be measured include body temperature, heart rate, breath flow using a spirometer, and other pulmonary function parameters, blood pressure employing an automatic or manual cuff type apparatus which might include a finger cuff, oxygenation using a finger cuff, glucose levels, EKG either alone or combined with a heart sound monitor, heart sound monitor alone, bone density. The unit could also include a bar code scanner which could be used to read bar codes on packages for food items consumed so as to determine their nature or caloric content.

In an alternative embodiment of the invention, the computer application program which controls the receipt and analysis of the input sensor signals and controls the computation and display of the results of the respiratory factor analysis is stored within a handheld computer itself such as a Palm Pilot. The Palm Pilot has a connector for the input of data which could be attached to a mating connector halve fixed to the monitor. In the case of a calorimeter of the type disclosed in my previous application, the computation and display unit which forms an integral part of the non-disposable section of the calorimeter as disclosed could be eliminated and replaced by a socket to receive the Palm Pilot with a suitable application program loaded in. The application could be stored in a mass storage device forming part of the Palm Pilot and loaded into operating memory at the time of use with the monitoring device. Otherwise, once detached from the monitoring device, the Palm Pilot could serve other functions. The Palm Pilot might also store the results of repeated tests and progress charts based on those results.

68007 9335708

92909tlt  
MJA-13180/03

The PDA preferably stores a program which allows the user to enter information relating to food and beverage consumed during the day and possibly activity level. Therefore, the PDA would normally be carried on the person of the user. The PDA will also preferably include a communication unit which allows information to be transferred between the PDA and the central server or website on the internet to allow information from the central station to be returned to the PDA. The communication can be directly from the PDA through internet connection device or could be into a personal computer which in turn is connected to the internet.

The PDA should be arranged so that it stores these programs which must be carried, either directly in its own memory, or through a plug-in module. When the PDA plugs in to the calorimeter it may also receive another plug-in module that contains the calorimeter calculation and display capability or that calculation and display capability could be permanently stored in the PDA so that the connection to the calorimeter only supplies the electrical sensor signals.

The combination of a PDA which can be normally carried and can provide programs for receiving the user's consumption and/or activity and can communicate with an internet-based website directly or indirectly, and which can plug into a calorimeter or other monitoring instrument to act as the computation and display unit for that instrument and also to transfer the information being measured into the memory of the PDA, is a powerful combination.

The software that is normally carried with the PDA can receive signals from the user of the PDA and can communicate electronically with the central station. Based on inputs that the PDA receives from the various monitors and from the central station, the PDA can supervise a program of activities for the user. These activities include signaling to the user when the PDA should be coupled to the various monitors to obtain signals. For example, while it may be desirable to couple to a weight scale on a daily basis, it may be only be necessary to couple to a

92909tlt  
MJA-13180/03

calorimeter on a weekly basis. The program which is displayed on the PDA will alert the user of the need to couple to the desired monitors in order to make the measurements. When the unit is coupled to the monitor, in addition to acting as the computation, display, and possibly control unit for the monitor (the buttons on the PDA may be used to control the monitor) the PDA receives the sensor signals generated by the monitor, processes them, displays them, and stores them. The PDA may communicate them via the internet or other communication channel to a central station at either a predetermined time programmed into the PDA, at regular intervals, or each time a monitored test is made. The central station will communicate back to the PDA instructions which may modify its program.

The PDA may be compatible with voice recognition software so that the user may communicate with the PDA vocally, eliminating the need to press buttons and go through complex program steps. The voice recognition circuitry could be permanently installed on the PDA or incorporated in a plug-in module. The PDA preferably has a voice generation circuitry which can give instructions to the user and, when the PDA is plugged into a monitor so as to act as the computation and display unit, give instructions to the user, for example, when to begin and end tests as well as announcing test results.

In the case of certain monitoring instruments which are relatively large, such as a weight scale, or calorimeter, the PDA may be physically plugged into the monitor which then forms the basic unit. Other monitors may be relatively compact so that they can effectively be built into the plug-in module that goes into the PDA so that the PDA is supplemented rather than supplementing the monitor. For example, a bio-impedance conductance monitor for the determination of body fat and hydration could be implemented simply by placing finger contacts on a plug-in module for the PDA so that the module could be loaded into the PDA and then two

66800T 9385T03

92909tlt  
MJA-13180/03

fingers of the user could be brought into position with respect to the contacts to measure the body impedance. Preferably they would constitute fingers on opposed hands and preferably four fingers. The module might be grasped in two hands between the forefingers and thumbs. Similarly, a module having electrical contacts for detecting EKG could be plugged into the PDA so that the entire PDA is positioned against the chest of the user to bring the contacts into position for an appropriate EKG measurement. Alternatively, either the PDA itself or a plug-in module for the PDA could have a jack to receive flexible conductors which have electrodes at their opposite ends and are positioned at various locations on the skin of the user to measure physiological parameters such as EKG and the like. In another alternative, the plug-in module may form the microphone of a stethoscope which is brought into position with respect to the user's chest. Headphones could be coupled to a plug-in jack in either the PDA or the module to allow the user's heart sounds to be auscultated. Simultaneously the electrical signals generated by the microphone could be digitized and recorded.

Certain physiological monitors are best worn on the person of the user for relatively large periods of time. For example, the accelerometer may be carried during at least waking hours. Similarly, a pulse monitor could be continuously worn. These monitors can be in the form of plug-in modules for the PDA. After a period of use, they may be plugged into the PDA to download stored measurements made during use. Alternatively, the monitors could be wired to a PDA which is carried on the person by the user so as to provide their output signals in real time. As another alternative, these monitors could be plugged into a PDA which is carried by the user so as to make their measurements while directly coupled to the PDA.

Having thus described my invention, I claim:

92909tlt  
MJA-13180/03

CLAIMS

1. A physiological monitor adapted to generate electrical signals representative of sensor signals during a test and a handheld computer for receiving and processing the signals and generating a display of the results, and a connector on the computer adapted to join with a mating connector supported on the monitor to provide the sensor signals to the computer.

TT-C:\mja13180.app.doc

654007" 030303T03



Please type a plus sign (+) inside this box → **+**

**EL 42204717805**

Docket Number: **MJA-13818/03**

*A/Prov*

**PROVISIONAL APPLICATION FOR PATENT COVER SHEET (Small Entity)**

This is a request for filing a PROVISIONAL APPLICATION FOR PATENT under 37 CFR 1.53 (c).

10/13/99

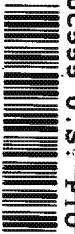

INVENTOR(S)/APPLICANT(S)					
Given Name (first and middle [if any])		Family Name or Surname		Residence (City and either State or Foreign Country)	
James R.		Mault		Evergreen, Colorado, US	
<input type="checkbox"/> Additional inventors are being named on page 2 attached hereto					
TITLE OF THE INVENTION (280 characters max)					
METHOD AND APPARATUS FOR DETERMINING NITRIC OXIDE CONCENTRATION OF RESPIRATION					
CORRESPONDENCE ADDRESS					
Direct all correspondence to:					
<input type="checkbox"/> Customer Number <input type="text"/>		<input type="text"/> Place Customer Number Bar Code Label here			
OR					
<input checked="" type="checkbox"/> Firm or Individual Name		Allen M. Krass, Esq.			
Address		GIFFORD, KRASS, GROH, SPRINKLE, ANDERSON & CITKOWSKI, P.C.			
Address		280 N. Old Woodward, Suite 400			
City		Birmingham	State	MI	ZIP
Country		US	Telephone	248-647-6000	Fax
				48009	248-647-5210
ENCLOSED APPLICATION PARTS (check all that apply)					
<input checked="" type="checkbox"/> Specification	Number of Pages	3	<input type="checkbox"/> Small Entity Statement		
<input type="checkbox"/> Drawing(s)	Number of Sheets		<input type="checkbox"/> Other (specify)		
METHOD OF PAYMENT OF FILING FEES FOR THIS PROVISIONAL APPLICATION FOR PATENT (check one)					
<input checked="" type="checkbox"/> A check or money order is enclosed to cover the filing fees					FILING FEE AMOUNT
<input type="checkbox"/> The Commissioner is hereby authorized to charge filing fees or credit any overpayment to Deposit Account Number:				<input type="text"/> \$150.00	
The invention was made by an agency of the United States Government or under a contract with an agency of the United States Government.					
<input checked="" type="checkbox"/> No.					
<input type="checkbox"/> Yes, the name of the U.S. Government agency and the Government contract number are:					

Respectfully submitted,

SIGNATURE

Date

10/13/99

TYPED or PRINTED NAME

Allen M. Krass

REGISTRATION NO.

18,277

(if appropriate)

TELEPHONE

248-647-6000

**USE ONLY FOR FILING A PROVISIONAL APPLICATION FOR PATENT**

SEND TO: Box Provisional Application, Assistant Commissioner for Patents, Washington, DC 20231

MJA/03  
91013ltt

**METHOD AND APPARATUS FOR DETERMINING  
NITRIC OXIDE CONCENTRATION OF RESPIRATION**

5 Nitric oxide content of respiration is an important clinical measure of lung health and disease. It has previously been proposed to collect samples of exhaled gases and analyze them for nitric oxide. However, nitric oxide levels may vary within a breath and from breath to breath and I have determined that it is desirable to make real time measurements of nitric oxide within the flow path of inhaled and exhaled gases in order to determine the condition of lung health.

10 The present invention relates to a device in which a patient breathes through a mask or mouthpiece and both the inhaled and exhaled gases are passed through a conduit. A suitable sensor for nitric oxide, such as a photoelectroluminescent sensor or possibly an infrared sensor, is disposed in this conduit. The sensor includes an excitation source, an electroluminescent target which is in contact with passing gases, and an optical sensor for measuring  
15 induced luminance of the source. The luminance is quenched by nitric oxide in the flowing gases so that the induced luminance level is a measure of the nitric oxide concentration in the gases. The sensor can also be reactive of the type disclosed in U.S. Patent No. 5,922,610. Other sensors are disclosed in U.S. Patent Nos. 5,517,313; 5,894,351; 5,910,661 and 5,917,605.

20 The unit preferably distinguishes between inhalations and exhalations by means of a valve or flow meter and cumulates the measurement of the nitric oxide in the inhaled gas over the period of the measurement and subtracts that value

MJA/03  
91013tl

from the cumulated measurement of the nitric oxide in the exhaled gas. The resultant measurement could be displayed and/or stored for downloading into an associated device for analysis or incorporation in a database.

66207 032520

MJA/03  
91013tl

Claim

- 1           1.     The method of measuring exhaled nitric oxide comprising:
- 2           passing inhaled and exhaled gases through a conduit,
- 3           distinguishing inhalations from exhalations,
- 4           measuring the nitric oxide concentration of gases passing through the
- 5     conduit using an electroluminescent sensor, and
- 6           cumulating and subtracting the nitric oxide content of the inhaled gas
- 7     from the cumulated nitric oxide content of the exhaled gas.

**Electronic Acknowledgement Receipt**

<b>EFS ID:</b>	10297668
<b>Application Number:</b>	12211033
<b>International Application Number:</b>	
<b>Confirmation Number:</b>	7693
<b>Title of Invention:</b>	METHOD AND APPARATUS FOR MONITORING EXERCISE WITH WIRELESS INTERNET CONNECTIVITY
<b>First Named Inventor/Applicant Name:</b>	Roger J. Quy
<b>Customer Number:</b>	27774
<b>Filer:</b>	Karin L. Williams/Michelle Wolf
<b>Filer Authorized By:</b>	Karin L. Williams
<b>Attorney Docket Number:</b>	00125/002005
<b>Receipt Date:</b>	14-JUN-2011
<b>Filing Date:</b>	15-SEP-2008
<b>Time Stamp:</b>	13:01:31
<b>Application Type:</b>	Utility under 35 USC 111(a)

**Payment information:**

Submitted with Payment	no
------------------------	----

**File Listing:**

Document Number	Document Description	File Name	File Size(Bytes)/ Message Digest	Multi Part /.zip	Pages (if appl.)
1	Amendment/Req. Reconsideration-After Non-Final Reject	s00125-002005-Resp-to-3-18-11-non-final-FINAL.pdf	2206086 1aa40b393cbd44478e05606de60f41f05c5a52	no	55

**Warnings:****Information:**

This Acknowledgement Receipt evidences receipt on the noted date by the USPTO of the indicated documents, characterized by the applicant, and including page counts, where applicable. It serves as evidence of receipt similar to a Post Card, as described in MPEP 503.

**New Applications Under 35 U.S.C. 111**

If a new application is being filed and the application includes the necessary components for a filing date (see 37 CFR 1.53(b)-(d) and MPEP 506), a Filing Receipt (37 CFR 1.54) will be issued in due course and the date shown on this Acknowledgement Receipt will establish the filing date of the application.

**National Stage of an International Application under 35 U.S.C. 371**

If a timely submission to enter the national stage of an international application is compliant with the conditions of 35 U.S.C. 371 and other applicable requirements a Form PCT/DO/EO/903 indicating acceptance of the application as a national stage submission under 35 U.S.C. 371 will be issued in addition to the Filing Receipt, in due course.

**New International Application Filed with the USPTO as a Receiving Office**

If a new international application is being filed and the international application includes the necessary components for an international filing date (see PCT Article 11 and MPEP 1810), a Notification of the International Application Number and of the International Filing Date (Form PCT/RO/105) will be issued in due course, subject to prescriptions concerning national security, and the date shown on this Acknowledgement Receipt will establish the international filing date of the application.

PTO/SB/06 (07-06)  
 Approved for use through 1/31/2007. OMB 0651-0032  
 U.S. Patent and Trademark Office; U.S. DEPARTMENT OF COMMERCE

Under the Paperwork Reduction Act of 1995, no persons are required to respond to a collection of information unless it displays a valid OMB control number.

<b>PATENT APPLICATION FEE DETERMINATION RECORD</b> Substitute for Form PTO-875					Application or Docket Number <b>12/211,033</b>		Filing Date <b>09/15/2008</b>		<input type="checkbox"/> To be Mailed				
<b>APPLICATION AS FILED – PART I</b>							<b>OTHER THAN</b>						
(Column 1)			(Column 2)		SMALL ENTITY <input checked="" type="checkbox"/>		OR		SMALL ENTITY				
FOR	NUMBER FILED	NUMBER EXTRA	RATE (\$)	FEE (\$)	OR		RATE (\$)	FEE (\$)					
<input type="checkbox"/> BASIC FEE <small>(37 CFR 1.16(a), (b), or (c))</small>	N/A	N/A	N/A				N/A						
<input type="checkbox"/> SEARCH FEE <small>(37 CFR 1.16(k), (l), or (m))</small>	N/A	N/A	N/A				N/A						
<input type="checkbox"/> EXAMINATION FEE <small>(37 CFR 1.16(o), (p), or (q))</small>	N/A	N/A	N/A				N/A						
TOTAL CLAIMS <small>(37 CFR 1.16(i))</small>	minus 20 =	*	X \$ =				X \$ =						
INDEPENDENT CLAIMS <small>(37 CFR 1.16(h))</small>	minus 3 =	*	X \$ =				X \$ =						
<input type="checkbox"/> APPLICATION SIZE FEE <small>(37 CFR 1.16(s))</small>			If the specification and drawings exceed 100 sheets of paper, the application size fee due is \$250 (\$125 for small entity) for each additional 50 sheets or fraction thereof. See 35 U.S.C. 41(a)(1)(G) and 37 CFR 1.16(s).										
<input type="checkbox"/> MULTIPLE DEPENDENT CLAIM PRESENT <small>(37 CFR 1.16(j))</small>			TOTAL				TOTAL						
* If the difference in column 1 is less than zero, enter "0" in column 2.													
<b>APPLICATION AS AMENDED – PART II</b>							<b>OTHER THAN</b>						
(Column 1)			(Column 2)		(Column 3)		SMALL ENTITY		OR		SMALL ENTITY		
<b>AMENDMENT</b>	<b>06/14/2011</b>	CLAIMS REMAINING AFTER AMENDMENT	HIGHEST NUMBER PREVIOUSLY PAID FOR	PRESENT EXTRA	RATE (\$)	ADDITIONAL FEE (\$)	OR		RATE (\$)	ADDITIONAL FEE (\$)			
	Total <small>(37 CFR 1.16(i))</small>	* 20	Minus	** 20	= 0	X \$26 =			0	X \$ =			
	Independent <small>(37 CFR 1.16(h))</small>	* 2	Minus	***3	= 0	X \$110 =			0	X \$ =			
	<input type="checkbox"/> Application Size Fee <small>(37 CFR 1.16(s))</small>												
	<input type="checkbox"/> FIRST PRESENTATION OF MULTIPLE DEPENDENT CLAIM <small>(37 CFR 1.16(j))</small>												
					TOTAL ADD'L FEE	<b>0</b>			TOTAL ADD'L FEE				
<b>AMENDMENT</b>	CLAIMS REMAINING AFTER AMENDMENT	HIGHEST NUMBER PREVIOUSLY PAID FOR	PRESENT EXTRA	RATE (\$)	ADDITIONAL FEE (\$)	OR		RATE (\$)	ADDITIONAL FEE (\$)				
	Total <small>(37 CFR 1.16(i))</small>	*	Minus	**	=			X \$ =	X \$ =				
	Independent <small>(37 CFR 1.16(h))</small>	*	Minus	***	=			X \$ =	X \$ =				
	<input type="checkbox"/> Application Size Fee <small>(37 CFR 1.16(s))</small>												
	<input type="checkbox"/> FIRST PRESENTATION OF MULTIPLE DEPENDENT CLAIM <small>(37 CFR 1.16(j))</small>												
					TOTAL ADD'L FEE			TOTAL ADD'L FEE					
* If the entry in column 1 is less than the entry in column 2, write "0" in column 3. ** If the "Highest Number Previously Paid For" IN THIS SPACE is less than 20, enter "20". *** If the "Highest Number Previously Paid For" IN THIS SPACE is less than 3, enter "3". The "Highest Number Previously Paid For" (Total or Independent) is the highest number found in the appropriate box in column 1.													
							Legal Instrument Examiner: /BRENDA MURPHY/						

This collection of information is required by 37 CFR 1.16. The information is required to obtain or retain a benefit by the public which is to file (and by the USPTO to process) an application. Confidentiality is governed by 35 U.S.C. 122 and 37 CFR 1.14. This collection is estimated to take 12 minutes to complete, including gathering, preparing, and submitting the completed application form to the USPTO. Time will vary depending upon the individual case. Any comments on the amount of time you require to complete this form and/or suggestions for reducing this burden, should be sent to the Chief Information Officer, U.S. Patent and Trademark Office, U.S. Department of Commerce, P.O. Box 1450, Alexandria, VA 22313-1450. DO NOT SEND FEES OR COMPLETED FORMS TO THIS ADDRESS. **SEND TO: Commissioner for Patents, P.O. Box 1450, Alexandria, VA 22313-1450.**

*If you need assistance in completing the form, call 1-800-PTO-9199 and select option 2.*



UNITED STATES PATENT AND TRADEMARK OFFICE

UNITED STATES DEPARTMENT OF COMMERCE  
 United States Patent and Trademark Office  
 Address: COMMISSIONER FOR PATENTS  
 P.O. Box 1450  
 Alexandria, Virginia 22313-1450  
 www.uspto.gov

APPLICATION NO.	FILING DATE	FIRST NAMED INVENTOR	ATTORNEY DOCKET NO.	CONFIRMATION NO.
12/211,033	09/15/2008	Roger J. Quy	00125/002005	7693
2774	7590	08/30/2011	EXAMINER JIAN, SHIRLEY XUEYING	
MAYER & WILLIAMS PC 251 NORTH AVENUE WEST Suite 201 WESTFIELD, NJ 07090			ART UNIT	PAPER NUMBER
			3769	
			MAIL DATE	DELIVERY MODE
			08/30/2011	PAPER

**Please find below and/or attached an Office communication concerning this application or proceeding.**

The time period for reply, if any, is set in the attached communication.



<b>Office Action Summary</b>	<b>Application No.</b> 12/211,033	<b>Applicant(s)</b> QUY, ROGER J.	
	<b>Examiner</b> SHIRLEY JIAN	<b>Art Unit</b> 3769	

**-- The MAILING DATE of this communication appears on the cover sheet with the correspondence address --**

### Period for Reply

A SHORTENED STATUTORY PERIOD FOR REPLY IS SET TO EXPIRE 3 MONTH(S) OR THIRTY (30) DAYS, WHICHEVER IS LONGER, FROM THE MAILING DATE OF THIS COMMUNICATION.

- Extensions of time may be available under the provisions of 37 CFR 1.136(a). In no event, however, may a reply be timely filed after SIX (6) MONTHS from the mailing date of this communication.
- If NO period for reply is specified above, the maximum statutory period will apply and will expire SIX (6) MONTHS from the mailing date of this communication.
- Failure to reply within the set or extended period for reply will, by statute, cause the application to become ABANDONED (35 U.S.C. § 133). Any reply received by the Office later than three months after the mailing date of this communication, even if timely filed, may reduce any earned patent term adjustment. See 37 CFR 1.704(b).

### Status

- 1)  Responsive to communication(s) filed on 14 June 2011.
- 2a)  This action is **FINAL**.                      2b)  This action is non-final.
- 3)  An election was made by the applicant in response to a restriction requirement set forth during the interview on \_\_\_\_\_; the restriction requirement and election have been incorporated into this action.
- 4)  Since this application is in condition for allowance except for formal matters, prosecution as to the merits is closed in accordance with the practice under *Ex parte Quayle*, 1935 C.D. 11, 453 O.G. 213.

### Disposition of Claims

- 5)  Claim(s) 1-4 and 6-21 is/are pending in the application.  
5a) Of the above claim(s) \_\_\_\_\_ is/are withdrawn from consideration.
- 6)  Claim(s) \_\_\_\_\_ is/are allowed.
- 7)  Claim(s) 1-4 and 6-21 is/are rejected.
- 8)  Claim(s) \_\_\_\_\_ is/are objected to.
- 9)  Claim(s) \_\_\_\_\_ are subject to restriction and/or election requirement.

### Application Papers

- 10)  The specification is objected to by the Examiner.
- 11)  The drawing(s) filed on \_\_\_\_\_ is/are: a)  accepted or b)  objected to by the Examiner.  
Applicant may not request that any objection to the drawing(s) be held in abeyance. See 37 CFR 1.85(a).  
Replacement drawing sheet(s) including the correction is required if the drawing(s) is objected to. See 37 CFR 1.121(d).
- 12)  The oath or declaration is objected to by the Examiner. Note the attached Office Action or form PTO-152.

### Priority under 35 U.S.C. § 119

- 13)  Acknowledgment is made of a claim for foreign priority under 35 U.S.C. § 119(a)-(d) or (f).  
a)  All    b)  Some \* c)  None of:
1.  Certified copies of the priority documents have been received.
  2.  Certified copies of the priority documents have been received in Application No. \_\_\_\_\_.
  3.  Copies of the certified copies of the priority documents have been received in this National Stage application from the International Bureau (PCT Rule 17.2(a)).

\* See the attached detailed Office action for a list of the certified copies not received.

### Attachment(s)

- |  |   |
|--|---|
| 1) <input type="checkbox"/> Notice of References Cited (PTO-892)   | 4) <input type="checkbox"/> Interview Summary (PTO-413)<br>Paper No(s)/Mail Date. _____ |
| 2) <input type="checkbox"/> Notice of Draftsperson's Patent Drawing Review (PTO-948)                       | 5) <input type="checkbox"/> Notice of Informal Patent Application                       |
| 3) <input type="checkbox"/> Information Disclosure Statement(s) (PTO/SB/08)<br>Paper No(s)/Mail Date _____ | 6) <input type="checkbox"/> Other: _____  |

Application/Control Number: 12/211,033  
Art Unit: 3769

Page 2

## DETAILED ACTION

### *Acknowledgement*

This office action is in response to the communication filed on June 14, 2011. Claims 1-4 and 6-21 are pending, and all pending claims are un-amended.

### *Claim Rejections - 35 USC § 102*

The following is a quotation of the appropriate paragraphs of 35 U.S.C. 102 that form the basis for the rejections under this section made in this Office action:

A person shall be entitled to a patent unless –

(e) the invention was described in (1) an application for patent, published under section 122(b), by another filed in the United States before the invention by the applicant for patent or (2) a patent granted on an application for patent by another filed in the United States before the invention by the applicant for patent, except that an international application filed under the treaty defined in section 351(a) shall have the effects for purposes of this subsection of an application filed in the United States only if the international application designated the United States and was published under Article 21(2) of such treaty in the English language.

**Claims 1-4 and 6-21 are rejected under 35 U.S.C. 102(e) as being anticipated by Mault et al. US Patent No. 6,790,178 B1 (hereinafter Mault).**

Regarding claims 1-4 and 6-21, Mault teach a system comprising a wireless computing device, such as a PDA or a cellular phone (web enabled wireless phone), a plurality of physiological monitors (hereinafter 'plug-in modules') adapted to interface with the PDA, and a remote internet based server communicatively coupled with the PDA to receive physiological data and to provide feedback to the PDA's user. The PDA has local application software for receiving, recording, processing, computing, displaying and transmitting signals from the plug-in modules (see col.4, ll.15-col.6, ll.51). Mault disclose the particular use of a calorimeter module, spirometer module, pedometer module, EKG/Heart sound module, body fat measurement

Application/Control Number: 12/211,033

Page 3

Art Unit: 3769

module, blood pressure module, body temperature module, blood pressure module, blood oxygen module, heart rate module, blood glucose module, ultra-sound sensors, food scale module, and even exercise equipment such as a bike (see col.7-col.24, particularly col.24, ll.35-47). The PDA is equipped with health management software that includes the ability to set up a variety of fitness plans and to track adherence to the plans. This includes tracking the user's exercise, diet and physiological parameters, then communicates this information to a remote internet server where the data is further analyzed and/or reviewed by a health professional so that feedback is provided to the user via the PDA. (col.6, ll.52-col.7, ll.26)

Regarding claims 2-3, 6-7 and 9-12, Mault specifically discloses a particular pedometer module in which the PDA stores exercise information received from the pedometer module and calculates various exercise parameters such as calories burned distance covered, average speed, etc. (col.11, ll.45-col.13, ll.55 and Figs. 7-10). Mault also discloses wherein the pedometer module could be attached to the crank arm on a bicycle so that parameters concerning bicycle usage could be determined. (col.13, ll.53-55)

Further regarding claims 4, 13 and 17-19, Mault discloses various ways for connecting the PDA and the plurality of plug-in modules via a wireless connection such as RF, infrared and Bluetooth (col.5, ll.19-39); or via a wired connection such as a docking station or by forming an integral unit consisting of the PDA and a plug-in module. (col.5, ll.40-col.6, ll.14)

The applicant should review the reference in its entirety and please refer to the different embodiments shown in Figs.1-28.

Application/Control Number: 12/211,033  
Art Unit: 3769

Page 4

***Claim Rejections - 35 USC § 103***

The following is a quotation of 35 U.S.C. 103(a) which forms the basis for all obviousness rejections set forth in this Office action:

(a) A patent may not be obtained though the invention is not identically disclosed or described as set forth in section 102 of this title, if the differences between the subject matter sought to be patented and the prior art are such that the subject matter as a whole would have been obvious at the time the invention was made to a person having ordinary skill in the art to which said subject matter pertains. Patentability shall not be negated by the manner in which the invention was made.

**Claims 1-4, 7-10, 12-16 and 20-21 are rejected under 35 U.S.C. 103(a) as being unpatentable over Hickman US Patent No. 6,059,692 in view of King et al. US Patent No. 6,353,839 B1.**

Regarding claims 1, 8-9, 14 and 15, Hickman discloses a ‘virtual personal trainer’ exercise system comprising an variety of exercise apparatuses and an associated local computing device where the local computing device has program software to control and monitor the operation and use of the exercise apparatus, the system further includes a remote internet based system having a remote computer and a bi-directional transmission medium including a telephone line that couples the local system and the remote system for data communication. Additionally, the local system (which includes the local computing device and exercise apparatus) has an interface for communicating with the user, and receives, stores, and transmits exercise and other health parameters to the remote server. The remote server is able to analyze the data from a plurality of local systems, and transmit exercise script/programs to the local system computer to implement these changes and to provide feedback to the user via the display at the exercise system. See abstract and summary of invention and also col.4, ll.40-col.6, ll.40. Hickman teaches using a conventional computer as a medium for connecting with the exercise equipment and for connecting with the internet based remote server via a modem (see Fig.1).

Application/Control Number: 12/211,033

Page 5

Art Unit: 3769

Hickman does not teach using a web enabled wireless phone as a computing device. However King, a reference in data processing art discloses that the rapid growth of the Internet has led to increases in data processing capabilities in portable devices such as web-enabled mobile phones and PDAs. Web enabled mobile phones and PDAs are able to serve as a medium for receiving data from an input and then bi-directional communicating the data between a user end and a remote server end (see Background of invention, especially col.1, ll.55-col.2, ll.13). As such, it would have been obvious to one of ordinary skill in the art at the time of the invention to replace Hickman's local computer with a portable device such as a web-enabled wireless phone because more and more people are carrying mobile devices, as such it would be beneficial to a user to carry Hickman's 'virtual personal trainer' to keep track and receive feedback on his/her daily exercise routines. Additionally, a portable 'virtual personal trainer' may provide additional on-the-go as diet encouragement/feedback services to assist a user further their health and fitness goal (Hickman col.3, ll.1-8).

Additionally, "when there is a design need or market pressure to solve a problem and there are a *finite number of identified, predictable solutions*, a person of ordinary skill has good reason to pursue the known options within his or her grasp. If this leads to the anticipated success, it is likely the product is not of innovation but ordinary skill and common sense. In that instance the fact that a combination was obvious to try might show it was obvious under 35 U.S.C. 103." *KSR Int'l Co. v. Teleflex Inc.*, 127 S.Ct. 1727, 1742, (2007). As such, replacing a cumbersome desktop computer with a mobile web-enabled phone is merely a product of market pressure as a result of increasing demands for mobile access to the Internet and increasing data processing power for such mobile devices.

Application/Control Number: 12/211,033  
Art Unit: 3769

Page 6

Further regarding claims 1-3, 7- 8, 14-16 and 20-21, Hickman, Figs.4-5 and col.7, ll.59- col.8, ll.47 discloses a local computing system which receives fitness exercise scripts from a remote server, wherein the local computing system further enforces the scripts to monitor a user's heart rate while the user performs an exercise. The exercise equipment include a stationary bicycle, a rowing machine, a step machine and a resistance trainer (see claim 6, col.12, ll.63-65).

Regarding claims 4, 6, 11, 13 and 18, Hickman discloses that the local computing system receives exercise related information over a wired connection via interface 60 (see Fig.1, solid lines indicate wired connection, this is also sufficient to reject a cable wired connection). Additionally, it is inherent that Hickman's local system comprises an adaptor to convert signal from the eService device to a suitable input for the computing device because the computing device is able to process the exercise related data (col.7, ll.59-col.8, ll.47).

**Claims 11, 17-19 are rejected under 35 U.S.C. 103(a) as being unpatentable over Hickman US Patent No.6,059,692 in view of King et al. US Patent No. 6,353,839 B1 as applied to claim claims 1 and 8 above, and further in view of Rautila US Patent No. 6,524,189 B1**

Further regarding claim 11 and 17-19, Hickman discloses that the local computing system receives exercise related information over a wired connection via interface 60 and various cables (see Fig.1). Hickman modified by King replaces the local computer with a web-enabled phone, as such, a wireless transfer medium is needed because mobile devices are intended to communicate via a wireless network (King: col.1, ll.13-23), and neither King nor Hickman teach receiving data via IR, RF or Bluetooth protocols. However Rautila Fig.1 and

Application/Control Number: 12/211,033

Page 7

Art Unit: 3769

col.4, ll.32-54, discloses a local network system comprising a plurality of gaming devices and a mobile phone equipped with an RF transceiver such as Bluetooth radio module for providing short-haul connectivity. It would have been obvious to one of ordinary skill in the art at the time of the invention to further modify Hickman's local system such that it includes King's web-enabled wireless phone and Rautila's wireless phone with RF and Bluetooth capabilities, because Bluetooth is a low cost short range wireless communication protocol enables multiple exercise devices to connect with the wireless phone over a single Bluetooth adapter (Hickman col.5, ll.18-19; Rautila: col.5, ll.26-47).

#### ***Response to Arguments***

Claims 1-4 and 6-21 stand rejected under Mault, and Hickman in view of King, and Hickman in view of King and Rautila as reasoned in the previous office action.

Applicant's arguments have been fully considered but they are not persuasive.

The applicant's date of invention for his provisional application 60/172,486 was signed on November 6, 1999; however, the same application was not filed until December 17, 1999. Currently, the effective provisional date for 60/172,486 is December 17, 1999.

As such, the following Mault's provisional applications have effective filing dates: 60/155,851 (09/24/1999), 60/158,553 (10/08/1999), 60/158,554 (10/08/1999), 60/158,556 (10/08/1999), 60/159,285 (10/13/1999), 60/165,166 (11/12/1999), 60/165,988 (11/17/1999), and 60/167,276 (11/24/1999).

With regard to the Mault reference, the applicant further argues: 1) Mault's PDA is distinct form the applicant's "web enabled wireless phone" and 2) Mault lacks teaching or

Application/Control Number: 12/211,033

Page 8

Art Unit: 3769

disclosure of a user interface to display a response via a web enabled phone as disclosed and claimed by applicant.

The examiner respectfully disagrees. Regarding point 1, the applicant does not provide an explicit definition of the term "web enabled wireless phone", as such, an ordinary dictionary based meaning of the terminology is given in light of the applicant's disclosure. The examiner interprets "web enabled wireless phone" as a wireless telephonic device which is enabled to communicate with the web/Internet. Alternatively, the Merriam Webster dictionary defines telephone (synonym to phone) as "an instrument for reproducing sounds at a distance; specifically: one in which sound is converted into electrical impulses for transmission (as by wire or radio waves)."

To this point, the applicant particular points out Mault's teachings in pages 8-9 of the Remarks.

[T]hese PDAs that primarily employ plug-ins for **sending results to "a central station via a telecommunications network such as the Internet"**. The link between the PDA and the telecommunications network could be "via a wireless connection to a transceiver which **is connect to the Internet**". The same link return signals to the PDA for display to the user. See, e.g. 60/155,851, page 2, at paragraph 3. Monitors may also be coupled to the PDA through a wireless channel. See, e.g. 60/158,533, page 3, at paragraph 3. (Emphasis added)

The applicant's declaration under 37 CFR 1.131 is moot because Mault's earliest provisional 60/155,851(09/24/1999) and 60/158,533(10/08/1999) predates the applicant's earliest priority date- November 6, 1999. These Mault provisional references establish a wireless device which is capable of communicating data over a telecommunications network; this meets the established definition of a telephone (synonym to phone) as a device which transmits data using electrical impulses.



Application/Control Number: 12/211,033  
Art Unit: 3769

Page 9

Additionally, the applicant's declaration under 37 CFR 1.131 is moot as established under MPEP 715.05, see below.

When the reference in question is a noncommonly owned U.S. patent or patent application publication claiming the same invention as applicant and its publication date is less than 1 year prior to the presentation of claims to that invention in the application being examined, applicant's remedy, if any, must be by way of 37 CFR 41.202 instead of 37 CFR 1.131.

Mault 60/265,166 (11/12/1999) also teaches an embodiment of the plug and play portable monitoring device using a mobile phone and telephonic communications network where a telephone connects wired or wirelessly to a monitoring device for measuring physiological parameters, and then uses a telephonic network for connection to a remote server or website, through the Internet (page 2, lines 7-10). Mault 60/265,166 also discloses wherein the phone may constitute commercially available operating systems for PDAs (page 2, lines. 10-12). With this in mind, it is evident that Mault contemplates at least a wireless portable phone, with PDA capabilities (enabled by PDA operating systems) where in the wireless portable phone is enabled to access the Internet. Regardless of Mault's PDA (60/155,851 and 60158,533) or wireless phone (60/265,16) embodiments, Mault's discloses are sufficient meet a "web enabled wireless phone."

Regarding point 2, Mault 60/165,166 page 3 specifically discloses:

**The signals representing the physiological measurements are transmitted to the phone** in the manner described above. The phone may incorporate software for processing the raw signals and **transmitting them via the phone, into the telephone network, and to the server site**. The results could be transmitted on a periodic basis, such as every day or two, to a health care professional such as a nutritionist. **The health professional would analyze the data and transmit information to the server which could be communicated to the telephone for display by the patient. Messages might recommend dietary**

Application/Control Number: 12/211,033  
Art Unit: 3769

Page 10

**changes, changes in activity level, changes in measurement time, etc.** There may be messages of encouragement or of warning. (Emphasis added)

Since this cited passage discloses displaying a response to the physiological measurements wherein the response includes recommendations received via an Internet server, this is evident that at least Mault 60/265,166 contemplates displaying a response via the web enabled phone.

Regarding rejections made under references Hickman in view of King. The applicant argues against the examiner's motivation to replace a conventional computer with a mobile phone.

The examiner respectfully disagrees. Despite the applicant pointing out that reference King acknowledges that mobile phones at the time of their invention was limited in computing power, memory, display, capability, input interface, and web browser implementations in comparison to desktop personal computers (col.1, ll.35-54). The examiner's motivation statement is not without basis from the references. Reference King also acknowledges that there is a recognized growing market need for a mobile paradigm in which the Internet can be instantly accessed by mobile devices, such as mobile phones, and PDAs (col.1, ll.28-32). It would be a natural and emerging market trend to implement the computing power of a desktop into a smaller, more portable device, i.e. a PDA or cellular phone. The following is a recitation of *KSR Int'l Co. v. Teleflex Inc.*, 127 S.Ct. 1727, 1742, (2007).

When there is a design need or market pressure to solve a problem and there are a *finite number of identified, predictable solutions*, a person of ordinary skill has good reason to pursue the known options within his or her grasp. If this leads to the anticipated success, it is likely the product is not of innovation but ordinary skill and common sense. In that instance the fact that a combination was obvious

Application/Control Number: 12/211,033  
Art Unit: 3769

Page 11

to try might show it was obvious under 35 U.S.C. 103.” *KSR Int’l Co. v. Teleflex Inc.*, 127 S.Ct. 1727, 1742, (2007).

As such, replacing a cumbersome desktop computer with a mobile web-enabled phone is merely a product of market pressure as a result of increasing demands for mobile access to the Internet and increasing data processing power for such mobile devices.

### *Conclusion*

**THIS ACTION IS MADE FINAL.** Applicant is reminded of the extension of time policy as set forth in 37 CFR 1.136(a).

A shortened statutory period for reply to this final action is set to expire THREE MONTHS from the mailing date of this action. In the event a first reply is filed within TWO MONTHS of the mailing date of this final action and the advisory action is not mailed until after the end of the THREE-MONTH shortened statutory period, then the shortened statutory period will expire on the date the advisory action is mailed, and any extension fee pursuant to 37 CFR 1.136(a) will be calculated from the mailing date of the advisory action. In no event, however, will the statutory period for reply expire later than SIX MONTHS from the mailing date of this final action.

Any inquiry concerning this communication or earlier communications from the examiner should be directed to SHIRLEY JIAN whose telephone number is (571)270-7374. The examiner can normally be reached on Monday-Friday 10:30am-6:00pm

If attempts to reach the examiner by telephone are unsuccessful, the examiner’s supervisor, Sam Chuan Yao can be reached on 571-272-1224. The fax phone number for the organization where this application or proceeding is assigned is 571-273-8300.

Application/Control Number: 12/211,033  
Art Unit: 3769

Page 12

Information regarding the status of an application may be obtained from the Patent Application Information Retrieval (PAIR) system. Status information for published applications may be obtained from either Private PAIR or Public PAIR. Status information for unpublished applications is available through Private PAIR only. For more information about the PAIR system, see <http://pair-direct.uspto.gov>. Should you have questions on access to the Private PAIR system, contact the Electronic Business Center (EBC) at 866-217-9197 (toll-free). If you would like assistance from a USPTO Customer Service Representative or access to the automated information system, call 800-786-9199 (IN USA OR CANADA) or 571-272-1000.

/SHIRLEY JIAN/  
Examiner, Art Unit 3769

/Henry M. Johnson, III/  
Primary Examiner, Art Unit 3769

August 23, 2011

**EAST Search History****EAST Search History (Prior Art)**

Ref #	Hits	Search Query	DBs	Default Operator	Plurals	Time Stamp
L1	1	"6059692".pn. and (heart NEAR4 rate) and ((treadmill) (bike bicycle) (step) (aerobic))	US-PGPUB; USPAT	OR	ON	2011/08/23 18:25
L2	3504	((mobile cell cellular portable) NEAR5 phone) WITH (bluetooth AND (IR RF infrared (radio NEAR2 frequency)))	US-PGPUB; USPAT	OR	ON	2011/08/23 18:25
L3	1	L2 and @ay<= "1998"	US-PGPUB; USPAT	OR	ON	2011/08/23 18:25
L4	228	((mobile cell cellular portable) NEAR5 phone) SAME (bluetooth AND (IR RF infrared (radio NEAR2 frequency))) SAME (receiv\$5 transsit\$5 obtain\$5 send\$5) and exercis \$5	US-PGPUB; USPAT	OR	ON	2011/08/23 18:25
L5	3504	((mobile cell cellular portable) NEAR5 phone) WITH (bluetooth AND (IR RF infrared (radio NEAR2 frequency)))	US-PGPUB; USPAT	OR	ON	2011/08/23 18:25
L6	1297	((mobile cell cellular portable) NEAR5 phone) SAME (bluetooth AND (IR RF infrared (radio NEAR2 frequency))) SAME (short NEAR5 range)	US-PGPUB; USPAT	OR	ON	2011/08/23 18:25
L7	3	L6 and @ay<= "1999"	US-PGPUB; USPAT	OR	ON	2011/08/23 18:25

L8	481	((mobile cell cellular portable) NEAR5 phone) WITH (bluetooth AND (IR RF infrared (radio NEAR2 frequency))) SAME (short NEAR5 range)	US-PGPUB; USPAT	OR	ON	2011/08/23 18:26
L9	1	L8 and @ay<="1999"	US-PGPUB; USPAT	OR	ON	2011/08/23 18:26
L10	3103	((mobile cell cellular portable) NEAR5 phone) SAME (bluetooth AND (IR RF infrared (radio NEAR2 frequency))) SAME (receiv\$5 transit\$5 obtain\$5 send\$5)	US-PGPUB; USPAT	OR	ON	2011/08/23 18:26
L11	14	L10 and @ay<="1999"	US-PGPUB; USPAT	OR	ON	2011/08/23 18:26
L12	217	((mobile cell cellular portable) NEAR5 phone) SAME (bluetooth AND (IR RF infrared (radio NEAR2 frequency))) SAME (short NEAR\$ range) and exercis\$5	US-PGPUB; USPAT	OR	ON	2011/08/23 18:26
L13	3	L12 and @ay<="1999"	US-PGPUB; USPAT	OR	ON	2011/08/23 18:26
L14	9	((ROGER) near2 (QUY)).INV.	USPAT; USOCR	OR	OFF	2011/08/23 18:27

**8/ 23/ 2011 6:32:00 PM**

**C:\ Documents and Settings\ sjian\ My Documents\ EAST\ Workspaces\ 12211033\_1.  
wsp**

<b>Search Notes</b>  	<b>Application/Control No.</b>  12211033	<b>Applicant(s)/Patent Under Reexamination</b>  QUY, ROGER J.
	<b>Examiner</b>  Shirley Jian	<b>Art Unit</b>  3769

SEARCHED			
Class	Subclass	Date	Examiner
600	300-301 (text)	5/09	MA
600	300-301 (text)	8/5/2010	SJ
428	8 (text)	8/5/2010	SJ
	class and subclass search updated	3/3/2011	SJ
	class and subclass search updated	8/23/2011	SJ

SEARCH NOTES		
Search Notes	Date	Examiner
East search (class/subclass, inventor, parent cases backwards search)	5/09	MA
Reviewed applied prior art, spoke with H. Johnson	11/09	MA
East search notes attached (inventor, IDS, class, subclass, text)	8/5/2010	SJ
EDAN related art search	8/5/2010	SJ
East search notes attached (inventor, IDS, class, subclass, text)	3/3/2011	SJ
East search notes attached (inventor, IDS, class, subclass, text)	8/23/2011	SJ

INTERFERENCE SEARCH			
Class	Subclass	Date	Examiner

/SHIRLEY JIAN/ Examiner.Art Unit 3769	
--	--

Doc Code: AP.PRE.REQ

PTO/SB/33 (07-09)  
 Approved for use through 07/31/2012. OMB 0651-0031  
 U.S. Patent and Trademark Office; U.S. DEPARTMENT OF COMMERCE

Under the Paperwork Reduction Act of 1995, no persons are required to respond to a collection of information unless it displays a valid OMB control number.

<b>PRE-APPEAL BRIEF REQUEST FOR REVIEW</b>		Docket Number (Optional) 00125/002005 (2051/14C4)	
I hereby certify that this correspondence is being deposited with the United States Postal Service with sufficient postage as first class mail in an envelope addressed to "Mail Stop AF, Commissioner for Patents, P.O. Box 1450, Alexandria, VA 22313-1450" [37 CFR 1.8(a)] on <u>September 28, 2011</u>  Signature <u>/Michelle Wolf/</u>  Typed or printed name <u>Michelle Wolf</u>	Application Number 12/211,033		Filed September 15, 2008
	First Named Inventor Roger J. Quy		
	Art Unit 3769	Examiner Shirley Xeuying Jian	

Applicant requests review of the final rejection in the above-identified application. No amendments are being filed with this request.

This request is being filed with a notice of appeal.

The review is requested for the reason(s) stated on the attached sheet(s).  
 Note: No more than five (5) pages may be provided.

I am the

- applicant/inventor.
- assignee of record of the entire interest.  
See 37 CFR 3.71. Statement under 37 CFR 3.73(b) is enclosed.  
(Form PTO/SB/96)
- attorney or agent of record.  
Registration number 37966
- attorney or agent acting under 37 CFR 1.34.  
Registration number if acting under 37 CFR 1.34 \_\_\_\_\_

/Mark Wieczorek/  
 Signature  
Mark D. Wieczorek  
 Typed or printed name  
619-818-4615  
 Telephone number  
October 27, 2011  
 Date

NOTE: Signatures of all the inventors or assignees of record of the entire interest or their representative(s) are required. Submit multiple forms if more than one signature is required, see below\*.

\*Total of \_\_\_\_\_ forms are submitted.

This collection of information is required by 35 U.S.C. 132. The information is required to obtain or retain a benefit by the public which is to file (and by the USPTO to process) an application. Confidentiality is governed by 35 U.S.C. 122 and 37 CFR 1.11, 1.14 and 41.6. This collection is estimated to take 12 minutes to complete, including gathering, preparing, and submitting the completed application form to the USPTO. Time will vary depending upon the individual case. Any comments on the amount of time you require to complete this form and/or suggestions for reducing this burden, should be sent to the Chief Information Officer, U.S. Patent and Trademark Office, U.S. Department of Commerce, P.O. Box 1450, Alexandria, VA 22313-1450. DO NOT SEND FEES OR COMPLETED FORMS TO THIS ADDRESS. SEND TO: Mail Stop AF, Commissioner for Patents, P.O. Box 1450, Alexandria, VA 22313-1450.

If you need assistance in completing the form, call 1-800-PTO-9199 and select option 2.



## Privacy Act Statement

The **Privacy Act of 1974 (P.L. 93-579)** requires that you be given certain information in connection with your submission of the attached form related to a patent application or patent. Accordingly, pursuant to the requirements of the Act, please be advised that: (1) the general authority for the collection of this information is 35 U.S.C. 2(b)(2); (2) furnishing of the information solicited is voluntary; and (3) the principal purpose for which the information is used by the U.S. Patent and Trademark Office is to process and/or examine your submission related to a patent application or patent. If you do not furnish the requested information, the U.S. Patent and Trademark Office may not be able to process and/or examine your submission, which may result in termination of proceedings or abandonment of the application or expiration of the patent.

The information provided by you in this form will be subject to the following routine uses:

1. The information on this form will be treated confidentially to the extent allowed under the Freedom of Information Act (5 U.S.C. 552) and the Privacy Act (5 U.S.C. 552a). Records from this system of records may be disclosed to the Department of Justice to determine whether disclosure of these records is required by the Freedom of Information Act.
2. A record from this system of records may be disclosed, as a routine use, in the course of presenting evidence to a court, magistrate, or administrative tribunal, including disclosures to opposing counsel in the course of settlement negotiations.
3. A record in this system of records may be disclosed, as a routine use, to a Member of Congress submitting a request involving an individual, to whom the record pertains, when the individual has requested assistance from the Member with respect to the subject matter of the record.
4. A record in this system of records may be disclosed, as a routine use, to a contractor of the Agency having need for the information in order to perform a contract. Recipients of information shall be required to comply with the requirements of the Privacy Act of 1974, as amended, pursuant to 5 U.S.C. 552a(m).
5. A record related to an International Application filed under the Patent Cooperation Treaty in this system of records may be disclosed, as a routine use, to the International Bureau of the World Intellectual Property Organization, pursuant to the Patent Cooperation Treaty.
6. A record in this system of records may be disclosed, as a routine use, to another federal agency for purposes of National Security review (35 U.S.C. 181) and for review pursuant to the Atomic Energy Act (42 U.S.C. 218(c)).
7. A record from this system of records may be disclosed, as a routine use, to the Administrator, General Services, or his/her designee, during an inspection of records conducted by GSA as part of that agency's responsibility to recommend improvements in records management practices and programs, under authority of 44 U.S.C. 2904 and 2906. Such disclosure shall be made in accordance with the GSA regulations governing inspection of records for this purpose, and any other relevant (*i.e.*, GSA or Commerce) directive. Such disclosure shall not be used to make determinations about individuals.
8. A record from this system of records may be disclosed, as a routine use, to the public after either publication of the application pursuant to 35 U.S.C. 122(b) or issuance of a patent pursuant to 35 U.S.C. 151. Further, a record may be disclosed, subject to the limitations of 37 CFR 1.14, as a routine use, to the public if the record was filed in an application which became abandoned or in which the proceedings were terminated and which application is referenced by either a published application, an application open to public inspection or an issued patent.
9. A record from this system of records may be disclosed, as a routine use, to a Federal, State, or local law enforcement agency, if the USPTO becomes aware of a violation or potential violation of law or regulation.

Serial No.: 12/211,003, Examiner Jian, Group Art Unit 3769

Page 1 of 5

## REASONS FOR REQUESTING PRE-APPEAL RELIEF

Claims 1–4 and 6–21 are pending and stand rejected as per a Final Office Action dated August 30, 2011. The claims stand rejected under 35 USC 102 (e) as being allegedly anticipated by US Patent No. 6,790,178 to Mault et al. (hereinafter “Mault”). In addition, Claims 1-4, 7-10, 12-16, and 20-21 stand rejected under 35 USC 103(a) as being allegedly unpatentable over US Patent No. 6,059,692 to Hickman (hereinafter "Hickman") in view of US Patent No. 6,353,839 to King et al. (hereinafter "King"). Finally, Claims 11 and 17–19 stand rejected as being allegedly unpatentable over Hickman in view of King and further in view of US Patent No. 6,524,189 to Rautila (hereinafter "Rautila"). These rejections are discussed in turn, as necessary, below.

Applicant first notes clear errors with regard to Office policy. The Final Office Action initially addressed Applicant’s Response filed June 14, 2011 by alleging that “The applicant’s date of invention for his provisional application 60/172,486 was signed on November 6, 1999; however, the same application was not filed until December 17, 1999. Currently, the effective provisional date for 60/172,486 is December 17, 1999.”

Applicant submits that this statement is clearly erroneous. Applicant is permitted under 37 CFR 1.131 to submit a Declaration to establish invention of the subject matter of the rejected claims prior to the effective date of the reference on which the rejection is based. Applicant alleged and provided evidence proving up a date of invention at least as early as November 6, 1999, i.e., a Declaration under 37 CFR 1.131 to prove a date of invention prior to that of Applicant’s provisional filing date, this date antedating most of the provisional applications to which the Mault reference claimed priority. No substantive issues were raised with regard to this Declaration.

However, in the Final Office Action dated August 30, 2011, the Examiner rejected the Declaration as moot under MPEP 715.05 because "When the reference in question is a non-commonly owned US patent or patent application publication claiming the same invention as applicant and its publication date is less than 1 year prior to the presentation of claims to that invention in the application being examined, applicant's remedy, if any, must be by way of 37 CFR 41.202 instead of 37 CFR 1.131." ( Page 9).

Applicant submits that this allegation is also clearly erroneous. On this issue in particular, Applicant is submitting these arguments in writing as Applicant was advised to do so upon calling the Office on September 21, 2011 in an attempt to remove this ground of rejection in a more expeditious manner.

Applicant believes MPEP 715.05 is inappropriately applied to the present case because the same deals with a US patent or application which claims the same invention, as defined in 37 CFR 41.203(a), as the Applicant. On the other hand, and pertinent to the present case, MPEP 706.02(b) states that a rejection based on 35 USC 102(e) can be overcome by “(D) filing an affidavit or declaration under 37 CFR 1.131 showing prior invention, if the reference is not a US patent or US patent application publication claiming the same patentable invention as defined in 37 CFR 41.203(a)”. MPEP 715(I)(A) states the same examination guideline of 706.02(b) in an alternative manner.

Serial No.: 12/211,003, Examiner Jian, Group Art Unit 3769

Page 2 of 5

The Examiner has not made the requisite showing under 37 CFR 41.203(a) that the Mault reference claims the same patentable invention as recited in the present pending claims. Moreover, Applicant submits that a comparison of the single claim of the Mault reference<sup>1</sup> with the present claims clearly indicates distinct subject matter: Mault requires an EKG and heart sound monitor including a housing with two or more electrodes and a microphone, a two-part separable connector, the two parts being operative when interconnected to physically join the monitor and a handheld unit in a rigid manner, and so on, which does not provide any exercise information; while the present claims require coupling a web enabled wireless phone to a device which provides exercise related information, receiving data indicating a physiological status of a subject where the data is received at least partially while the subject is exercising, receiving data indicating an amount of exercise performed by the subject, sending the information to an Internet server and receiving a calculated response, and so on. Clearly these are patentably distinct inventions.

In view of the preceding remarks, absent a valid application of the two-way obviousness interference standard, Applicant requests the Office consider and accept the Rule 1.131 Declaration, which swears behind the effective date of most of the Mault provisional applications, and withdraw the 102(e) rejections based on Mault.

On the more substantive issues regarding Mault, Applicant notes that the Examiner takes the position that even the five Mault provisional applications having an earlier filing date than the date of invention shown on Applicant's Rule 1.131 Declaration defeat the novelty of the claims. Applicant submits this position is clearly in error.

Applicant noted reasons for novelty in his response of June 14, 2011 at pages 6-10. Applicant illustrated how Mault failed to teach or disclose the inventions of independent claims 1 and 8, especially with regard to his five provisional applications filed prior to November 6, 1999 (see Page 9, first and third complete paragraphs).

Also in the prior response, Applicant noted additional deficiencies with regard to the dependent claims.

The Examiner disagreed and alleged the following primary points in the latest Final Office Action. The Examiner equated the claimed web enabled wireless phone with devices in Mault, and the Examiner alleged that the earliest provisional applications of Mault establish a wireless device that meets the requirements of the claims.

In discussing these allegations, Applicant initially notes the requirements of a novelty rejection. As noted at MPEP 2131: "To anticipate a claim, the reference must teach every element of the claim: A claim is anticipated only if each and every element as set forth in the claim is found, either expressly or inherently described, in a single prior art reference." *Verdegaal Bros. v. Union Oil Co. of California*, 814

---

<sup>1</sup> Applicant notes that the Mault provisional applications purport to have claims as well. However, claims are not required for such applications under 35 USC 111(b)(2). Moreover, 111(b)(8) states that provisional applications are not subject to interferences. By this analysis, and by extension to the present circumstances, Mault's provisional "claims" cannot be properly used as the basis for the two-way obviousness interference standard. However, even if they were, Applicant submits such claims are clearly patentably distinct.

Serial No.: 12/211,003, Examiner Jian, Group Art Unit 3769

Page 3 of 5

F.2d 628, 631, 2 USPQ2d 1051, 1053 (Fed. Cir. 1987)... "The identical invention must be shown in as complete detail as is contained in the ... claim." Richardson v. Suzuki Motor Co., 868 F.2d 1226, 1236 (Fed. Cir. 1989)."

Mault fails to do this. In particular, the five Mault provisional applications filed before November 6, 1999 disclose the following types of devices (here Applicant notes in particular computing devices, apart from physiological monitoring devices): PDAs and a handheld computer (60/155,851); a computer as well as a PDA (60/158,553); and PDAs (60/158,556). The other two Mault provisional applications filed during this period focus on specific types of physiological monitoring. The communication schemes by which the PDA (Personal Digital Assistant) communicates with a central station via a telecommunications network are disclosed as either a plug-in module for the PDA which electrically connects to the network, or via a wireless connection to a transceiver which is connected to the network, or through an intermediate unit such as a personal computer which connects to the network via a modem or the like (60/155,851, 60/158,556); or alternatively, a portable unit with an electrical output in the common format of the system for loading into a local computer or communications device for transmission to the remote computer (60/158,553).

Clearly none of these references provides disclosure sufficient to defeat the novelty of the claimed invention, to wit, a method for interactive exercise monitoring, with steps of: coupling a web-enabled wireless phone to a device which provides exercise-related information; rendering a user interface on the web-enabled wireless phone; receiving data indicating a physiologic status of a subject; receiving data indicating an amount of exercise performed by the subject, where at least one of the data indicating a physiologic status of a subject or the data indicating an amount of exercise performed by the subject is received from the device which provides exercise-related information, and where the data indicating a physiologic status of a subject is received at least partially while the subject is exercising; sending the exercise-related information to an internet server via a wireless network; receiving a calculated response from the server, the response associated with a calculation performed by the server based on the exercise-related information; and running an application in the web-enabled wireless phone for receiving the exercise-related information and displaying the response.

As one specific example, Applicant notes that on page 2 of the Final Office Action of August 30, 2011, the Examiner alleges that Mault teaches "...a wireless computing device, such as a PDA or cellular phone," which the Examiner then equates to a web enabled wireless phone. This interpretation is clearly erroneous, especially as part of a novelty rejection. No support is given in the Mault provisional applications noted above for phones, only for PDAs. The fact that the PDA requires a separate transceiver which is connected to the Internet inherently implies the deficiency of the reference to anticipate a web enabled wireless phone.

Applicant notes in addition that on page 8 of the Final Office Action of August 30, 2011, the Examiner gave an alternative definition for phone as "an instrument for reproducing sounds at a distance; specifically: one in which sound is converted into electrical impulses for transmission (as by wire or radio waves)". The Examiner construed this definition as "a device which transmits data using electrical

Serial No.: 12/211,003, Examiner Jian, Group Art Unit 3769

Page 4 of 5

impulses”, and employed the same at the bottom of page 8 to allege Mault’s disclosure of the claimed invention. Applicant respectfully submits these definitions are untenable. For one, the first definition would fail to even read on the PDA of Mault, as the PDA would fail to reproduce sounds at a distance. Next, the second definition of phone given by the Examiner is clearly overly broad and would read on devices such as garage door openers, which should not be construed as phones by anyone's definition.<sup>2</sup>

Applicant submits that PDAs and phones were recognized in the industry as separate devices at the time of the invention in 1999. Their functions were not combined until later. Tellingly, Mault discloses a mobile phone in one of his provisional applications, but such disclosure occurs subsequent to November 6, 1999; and as a distinct disclosure from a PDA. Applicant’s provisional application disclosed the same as separate embodiments of a wireless web device.

Applicant notes that the remainder of the Examiner’s comments in the Final Office Action of August 30, 2011 based on Mault alone concern provisional applications filed after November 6, 1999.

Accordingly, for at least all of the above reasons, Applicant submits the 102(e) novelty rejection is clearly erroneous and should be withdrawn.

With regard to the rejection of Claims 1-4, 7-10, 12-16, and 20-21 as being allegedly unpatentable over Hickman in view of King, Applicant provided clear reasons for patentability on pages 10-12 of the Response filed June 14, 2011. The reasons included that, at the time the invention was made, it would not have been obvious to replace the computer of Hickman with the mobile phone of King. In addition, Applicant argued that to do so would change the principle of operation of the references, which is prohibited by MPEP 2143.01(VI). In particular, to combine the script system of Hickman with the necessarily non-script system of King would require changing the principle of operation of one or the other. However, the script system of Hickman appears to be a key element of the invention, and is included in all the claims. In the same way, using a script system in King would not be a mere design variation; rather, the same is explicitly stated to be "too complicated to be used in mobile devices". (2:10–11).

The Examiner disagreed, noting that the King reference acknowledges that there is a growing need for a mobile paradigm in which the Internet can be instantly accessed by mobile devices. First, Applicant notes that he himself acknowledged this disclosure in King at the bottom of page 11 of the Response filed June 14, 2011. The King reference, intended to increase usability and navigation of web pages using thin devices such as mobile phones, would naturally have come about from a growing need for a mobile paradigm. But Applicant submits that this is a very different matter from the problem faced by the Applicant in developing the invention, to wit, providing mobile devices for health and exercise monitoring. Applicant solved the problem by placing much of the processing on the server side and using the limited computing capacity of the mobile device to serve as a conduit for health and exercise data. The King reference, on the other hand, “solves [the problem] without the necessity of the server round-

---

<sup>2</sup> In this regard, Applicant notes the Examiner made a similarly overly broad interpretation of a web-enabled wireless phone in the Final Office Action of August 13, 2010, with respect to Root et al., US Patent No. 6,013,007. This rejection was withdrawn in response to the Pre-Appeal Brief Request for Review filed November 15, 2010.

Serial No.: 12/211,003, Examiner Jian, Group Art Unit 3769

Page 5 of 5

trip and without incurring all the memory and processing requirements of a full scripting language.” (2:27-30, Emphasis added). In short, clearly neither King nor Hickman nor their combination point the way for one of ordinary skill in the art to make and use the claimed invention.

Next, Applicant submits that to replace the computer of Hickman with the mobile phone of King without clear reasons to do so is employing impermissible hindsight. The Examiner stated that it would have been obvious to do so to one of ordinary skill in the art at the time of the invention because “replacing a cumbersome desktop computer with a mobile web-enabled phone is merely a product of market pressure.” But it is important to note that the time period in question is almost 12 years ago. Applicant submits that many industry experts would question that a mobile phone could replace a computer for many computing tasks, even with smart phones today, much less 12 years ago. At the time of the invention it was not the case that there were a “finite number of identifiable solutions” as suggested by the Examiner. It took several more years for those solutions to emerge. To summarize, the proposed combination does not suggest the desirability of the claimed invention, running afoul of MPEP 2143.01(I). The same renders the prior art unsatisfactory for its intended purpose, running afoul of MPEP 2143.01(V). And the same changes the principle of operation of the references, running afoul of MPEP 2143.01(VI).

Accordingly, as one of ordinary skill in the art would not be led to combine King with Hickman at the time the invention was made, a *prima facie* case of obviousness has not been shown, and consequently Applicant respectfully submits that maintaining the rejection is clearly erroneous and the same should be withdrawn.

With regard to the rejection of claims 11 and 17-19 based on Hickman in view of King and further in view of Rautila, Applicant provided clear reasons for patentability on pages 12-13 of the Response filed June 14, 2011. No additional comments with regard to this rejection were made by the Examiner in the Final Office Action of August 30, 2011 and accordingly Applicant respectfully submits that maintaining the rejection is erroneous and the same should be withdrawn.<sup>3</sup>

Finally, Applicant notes that his patent application has undergone rigorous prosecution with two Examiners, having had three non-final Office Actions and two Final Office Actions over the last several years, each with varying rejections set forth and then changed, and has successfully had rejections withdrawn at the Board level. Clearly his innovation is pioneering, and was previously recognized by the Office, as he has been successful in obtaining five patents in this family. He was approached by Royal Philips Electronics and successfully assigned several of these patents to the same for significant value. In the interest of compact prosecution as laid out in the Official Gazette November 7, 2003, Applicant respectfully submits that if the clearly erroneous rejections are again withdrawn, it is time to allow the case to pass to issuance in an expeditious manner.

---

<sup>3</sup> In this regard Applicant notes a similar obviousness rejection using the above noted Root reference was previously withdrawn by the Board.

## Electronic Patent Application Fee Transmittal

<b>Application Number:</b>	12211033			
<b>Filing Date:</b>	15-Sep-2008			
<b>Title of Invention:</b>	METHOD AND APPARATUS FOR MONITORING EXERCISE WITH WIRELESS INTERNET CONNECTIVITY			
<b>First Named Inventor/Applicant Name:</b>	Roger J. Quy			
<b>Filer:</b>	Karin L. Williams/Michelle Wolf			
<b>Attorney Docket Number:</b>	00125/002005			
Filed as Small Entity				
<b>Utility under 35 USC 111(a) Filing Fees</b>				
<b>Description</b>	<b>Fee Code</b>	<b>Quantity</b>	<b>Amount</b>	<b>Sub-Total in USD(\$)</b>
<b>Basic Filing:</b>				
<b>Pages:</b>				
<b>Claims:</b>				
<b>Miscellaneous-Filing:</b>				
<b>Petition:</b>				
<b>Patent-Appeals-and-Interference:</b>				
Notice of appeal	2401	1	310	310
<b>Post-Allowance-and-Post-Issuance:</b>				
<b>Extension-of-Time:</b>				

Description	Fee Code	Quantity	Amount	Sub-Total in USD(\$)
<b>Miscellaneous:</b>				
<b>Total in USD (\$)</b>				<b>310</b>



**Electronic Acknowledgement Receipt**

<b>EFS ID:</b>	11286534
<b>Application Number:</b>	12211033
<b>International Application Number:</b>	
<b>Confirmation Number:</b>	7693
<b>Title of Invention:</b>	METHOD AND APPARATUS FOR MONITORING EXERCISE WITH WIRELESS INTERNET CONNECTIVITY
<b>First Named Inventor/Applicant Name:</b>	Roger J. Quy
<b>Customer Number:</b>	27774
<b>Filer:</b>	Karin L. Williams/Michelle Wolf
<b>Filer Authorized By:</b>	Karin L. Williams
<b>Attorney Docket Number:</b>	00125/002005
<b>Receipt Date:</b>	28-OCT-2011
<b>Filing Date:</b>	15-SEP-2008
<b>Time Stamp:</b>	10:01:33
<b>Application Type:</b>	Utility under 35 USC 111(a)

**Payment information:**

Submitted with Payment	yes
Payment Type	Deposit Account
Payment was successfully received in RAM	\$ 310
RAM confirmation Number	8699
Deposit Account	501047
Authorized User	

The Director of the USPTO is hereby authorized to charge indicated fees and credit any overpayment as follows:

Charge any Additional Fees required under 37 C.F.R. Section 1.16 (National application filing, search, and examination fees)

Charge any Additional Fees required under 37 C.F.R. Section 1.17 (Patent application and reexamination processing fees)

Charge any Additional Fees required under 37 C.F.R. Section 1.19 (Document supply fees)

Charge any Additional Fees required under 37 C.F.R. Section 1.20 (Post Issuance fees)

Charge any Additional Fees required under 37 C.F.R. Section 1.21 (Miscellaneous fees and charges)

**File Listing:**

Document Number	Document Description	File Name	File Size(Bytes)/ Message Digest	Multi Part /.zip	Pages (if appl.)
1	Notice of Appeal Filed	s00125-002005-Notice-of-Appeal.pdf	98807 70afa48ce2c626c704cf48ab22fa4a134a1303e3	no	2
<b>Warnings:</b>					
<b>Information:</b>					
2	Pre-Brief Conference request	s00125-002005-pre-appeal-request.pdf	262901 8b1e2d4c15687e43636be4b599acc5a44644d69d	no	7
<b>Warnings:</b>					
<b>Information:</b>					
3	Fee Worksheet (SB06)	fee-info.pdf	30383 dd4bf37f8b58e1b2c0a1e1a040da91564ccc4f52	no	2
<b>Warnings:</b>					
<b>Information:</b>					
<b>Total Files Size (in bytes):</b>			392091		

This Acknowledgement Receipt evidences receipt on the noted date by the USPTO of the indicated documents, characterized by the applicant, and including page counts, where applicable. It serves as evidence of receipt similar to a Post Card, as described in MPEP 503.

**New Applications Under 35 U.S.C. 111**

If a new application is being filed and the application includes the necessary components for a filing date (see 37 CFR 1.53(b)-(d) and MPEP 506), a Filing Receipt (37 CFR 1.54) will be issued in due course and the date shown on this Acknowledgement Receipt will establish the filing date of the application.

**National Stage of an International Application under 35 U.S.C. 371**

If a timely submission to enter the national stage of an international application is compliant with the conditions of 35 U.S.C. 371 and other applicable requirements a Form PCT/DO/EO/903 indicating acceptance of the application as a national stage submission under 35 U.S.C. 371 will be issued in addition to the Filing Receipt, in due course.

**New International Application Filed with the USPTO as a Receiving Office**

If a new international application is being filed and the international application includes the necessary components for an international filing date (see PCT Article 11 and MPEP 1810), a Notification of the International Application Number and of the International Filing Date (Form PCT/RO/105) will be issued in due course, subject to prescriptions concerning national security, and the date shown on this Acknowledgement Receipt will establish the international filing date of the application.

Serial No. 12/211,033

**IN THE UNITED STATES PATENT AND TRADEMARK OFFICE**

Inventor: Roger J. Quy

Serial No.: 12/211,033

Filed: September 15, 2008

Title: Method and Apparatus for Health and Disease Management Combining Patient Data Monitoring with Wireless Internet Connectivity

Art Unit: 3769

Examiner: Shirley Xueying Jian

Conf. No.: 7693

Docket No.: 00125/002005 (2051/14C3)

VIA EFS WEB  
Commissioner for Patents  
P.O. Box 1450  
Alexandria, VA 22313-1450

Certificate of Electronic Transmission  
Under 37 C.F.R. §1.8

I hereby certify that this correspondence and any document referenced herein are being electronically filed with the USPTO via EFS-Web on October 28, 2011.

Michelle Wolf  
Printed Name of Person Sending Correspondence)

/Michelle Wolf/  
(Signature)

**NOTICE OF APPEAL AND PRE-APPEAL BRIEF REQUEST FOR REVIEW**

SIR:

Applicant hereby respectfully appeals to the Board of Patent Appeals and Interferences from the decision of the Primary Examiner dated August 30, 2011, finally rejecting the pending claims in this application.

Authorization is hereby provided to charge Deposit Account No. 50-1047 the Appeal Fee under 37 CFR 41.20(b)(1) (\$310). It is further requested that the Commissioner charge any additional fees that may be required, or credit any overpayments, to Deposit Account 50-1047.

Serial No. 12/211,033

A Pre-Appeal Brief Request For Review is filed herewith.

Dated: October 27, 2011

Attorney for Applicant  
Mayer & Williams, PC  
251 North Avenue West, 2<sup>nd</sup> Floor  
Westfield, NJ 07090  
Tel.: 703-433-0510  
Fax: 908-518-7795

Respectfully submitted,

/Mark Wiczorek/

Mark Wiczorek  
Registration No. 37,966



UNITED STATES PATENT AND TRADEMARK OFFICE

UNITED STATES DEPARTMENT OF COMMERCE  
 United States Patent and Trademark Office  
 Address: COMMISSIONER FOR PATENTS  
 P.O. Box 1450  
 Alexandria, Virginia 22313-1450  
 www.uspto.gov

APPLICATION NO.	FILING DATE	FIRST NAMED INVENTOR	ATTORNEY DOCKET NO.	CONFIRMATION NO.
12/211,033	09/15/2008	Roger J. Quy	00125/002005	7693

2774 7590 01/10/2012  
 MAYER & WILLIAMS PC  
 251 NORTH AVENUE WEST  
 Suite 201  
 WESTFIELD, NJ 07090

EXAMINER
----------

JIAN, SHIRLEY XUEYING

ART UNIT	PAPER NUMBER
----------	--------------

3769

MAIL DATE	DELIVERY MODE
-----------	---------------

01/10/2012

PAPER

**Please find below and/or attached an Office communication concerning this application or proceeding.**

The time period for reply, if any, is set in the attached communication.

<b>Notice of Panel Decision from Pre-Appeal Brief Review</b>	<b>Application/Control No.</b>		<b>Applicant(s)/Patent under Reexamination</b>	
	12/211,033		QUY, ROGER J.	
	SHIRLEY JIAN		<b>Art Unit</b>	
		3769		

This is in response to the Pre-Appeal Brief Request for Review filed 28 October 2011.

1.  **Improper Request** – The Request is improper and a conference will not be held for the following reason(s):

- The Notice of Appeal has not been filed concurrent with the Pre-Appeal Brief Request.
- The request does not include reasons why a review is appropriate.
- A proposed amendment is included with the Pre-Appeal Brief request.
- Other: .

The time period for filing a response continues to run from the receipt date of the Notice of Appeal or from the mail date of the last Office communication, if no Notice of Appeal has been received.

2.  **Proceed to Board of Patent Appeals and Interferences** – A Pre-Appeal Brief conference has been held. The application remains under appeal because there is at least one actual issue for appeal. Applicant is required to submit an appeal brief in accordance with 37 CFR 41.37. The time period for filing an appeal brief will be reset to be one month from mailing this decision, or the balance of the two-month time period running from the receipt of the notice of appeal, whichever is greater. Further, the time period for filing of the appeal brief is extendible under 37 CFR 1.136 based upon the mail date of this decision or the receipt date of the notice of appeal, as applicable.

- The panel has determined the status of the claim(s) is as follows:  
 Claim(s) allowed: \_\_\_\_\_.  
 Claim(s) objected to: \_\_\_\_\_.  
 Claim(s) rejected: 1-4 and 6-21.  
 Claim(s) withdrawn from consideration: \_\_\_\_\_.

3.  **Allowable application** – A conference has been held. The rejection is withdrawn and a Notice of Allowance will be mailed. Prosecution on the merits remains closed. No further action is required by applicant at this time.

4.  **Reopen Prosecution** – A conference has been held. The rejection is withdrawn and a new Office action will be mailed. No further action is required by applicant at this time.

All participants:

(1) Shirley Jian.

(3) Linda Dvorak.

(2) Sam Yao.

(4) \_\_\_\_\_.

/SHIRLEY JIAN/  
Examiner, Art Unit 3769

/SAM YAO/  
Supervisory Patent Examiner, Art  
Unit 3769

/Linda C Dvorak/  
Supervisory Patent Examiner, Art  
Unit 3739

Application No.: 12/211,033

Docket No.: 00125/002005 (2051/14C4)

**IN THE UNITED STATES PATENT AND TRADEMARK OFFICE**

In re Patent Application of:  
Roger J. Quy

Application No.: 12/211,033

Filed: September 15, 2008

For: METHOD AND APPARATUS FOR  
MONITORING EXERCISE WITH WIRELESS  
INTERNET CONNECTIVITY

Examiner: Shirley Xueying Jian

Confirmation No.: 7693

Art Unit: 3769

Via EFS Web  
Commissioner for Patents  
P.O. Box 1450  
Alexandria, VA 22313-1450

<p>Certificate of Electronic Transmission <u>Under 37 C.F.R. §1.8</u></p> <p>I hereby certify that this correspondence and any document referenced herein are being electronically filed with the USPTO via EFS-Web on March 12, 2012.</p> <p style="text-align: center;"><u>Michelle Wolf</u> (Printed Name of Person Sending Correspondence)</p> <p style="text-align: center;"><u>Michelle Wolf/</u> (Signature)</p>
---

Dear Sir:

**APPEAL BRIEF UNDER 37 C.F.R. §41.37**

As set forth in the Notice of Appeal submitted October 27, 2011 and further to the Notice of Panel Decision mailed January 10, 2012, Appellant appeals the decision of the Examiner mailed August 30, 2011 (“Final Office Action”) in the above-identified application.

Appellant respectfully petitions under 37 C.F.R. 1.136(a) for a one-month extension of time to respond. The U.S. Patent and Trademark Office is authorized to charge the Appeal Fee under 37 C.F.R. 41.20(b)(1) (\$310), the fee for a one-month extension of time under 37 C.F.R. 1.17(a)(1) (\$75), and to charge any other fees deemed owing, and/or to credit any overpayments made regarding the application at large to Deposit Account 50-1047.

Appellant respectfully requests that the Board of Patent Appeals and Interferences reverse the Examiner’s rejections.

Application No.: 12/211,033

Docket No.: 00125/002005 (2051/14C4)

## **I. REAL PARTY IN INTEREST**

Q-TEC Systems LLC is the assignee of the present invention and the real party in interest.

## **II. RELATED APPEALS AND INTERFERENCES**

No prior and pending appeals, judicial proceedings or interferences which may be related to, directly affect or be directly affected by, or have a bearing on the Board's decision in the pending appeal are known to the Appellant.

## **III. STATUS OF CLAIMS**

The claims in the application are Claims 1-4 and 6-21. Claim 5 was previously canceled. Claims 1-4 and 6-21 are finally rejected and on appeal.

## **IV. STATUS OF AMENDMENTS**

A Final Office Action was mailed on August 30, 2011, rejecting Claims 1-4 and 6-21. In response thereto, a Notice of Appeal was filed on October 28, 2011. No amendments have been filed.

## **V. SUMMARY OF CLAIMED SUBJECT MATTER**

A concise explanation of the subject matter defined in each of the independent claims involved in the appeal, referring to the specification, follows. Claims 1 and 14 are the independent claims presently pending.

Independent Claim 1 is directed to a method for interactive exercise monitoring, the method comprising the steps of:

- a. coupling a web-enabled wireless phone to a device which provides exercise-related information (see Fig. 2; WWD 12; HMD 11; paragraph [0015], lines 1-5 (corresponding to page 4, lines 22-26); paragraph [0016], lines 1-7 (corresponding to page 5, lines 1-7) paragraph [0019], lines 1-2 (corresponding to page 5, lines 19-20); paragraph [0020], lines 1-4 (corresponding to page 5, lines 25-28));



Application No.: 12/211,033

Docket No.: 00125/002005 (2051/14C4)

- b. rendering a user interface on the web-enabled wireless phone (see Fig. 2; WWD 12; screen 41; paragraph [0049], lines 5-8 (corresponding to page 10, lines 17-18));
- c. receiving data indicating a physiologic status of a subject (see Fig. 6; steps 216, 218, 240, 220, 222; paragraph [0076], lines 1-5 (corresponding to page 16, lines 11-15); paragraph [0077], lines 1-3 (corresponding to page 16, lines 16-18); paragraph [0078], lines 1-4 (corresponding to page 16, lines 19-22));
- d. receiving data indicating an amount of exercise performed by the subject (see Fig. 6; steps 216, 218, 240, 220, 222; paragraph [0076], lines 1-5 (corresponding to page 16, lines 11-15); paragraph [0077], lines 1-3 (corresponding to page 16, lines 16-18); paragraph [0078], lines 1-4 (corresponding to page 16, lines 19-22));
- e. wherein at least one of the data indicating a physiologic status of a subject or the data indicating an amount of exercise performed by the subject is received from the device which provides exercise-related information, and wherein the data indicating a physiologic status of a subject is received at least partially while the subject is exercising (see paragraph [0013], lines 2-4 (corresponding to page 4, lines 13-15); paragraph [0016], lines 1-3 (corresponding to page 5, lines 1-3));
- f. sending the exercise-related information to an internet server via a wireless network (see Fig. 1, WHMA 10, POP 19, antenna 15, server 17, Internet 21; paragraph [0047], lines 1-7 (corresponding to page 10, lines 1-7); paragraph [0055], lines 1-6 (corresponding to page 11, line 29 to page 12, line 5));
- g. receiving a calculated response from the server, the response associated with a calculation performed by the server based on the exercise-related information (see Fig. 3; paragraph [0058], lines 1-5 (corresponding to page 12, lines 23-27)); and
- h. running an application in the web-enabled wireless phone for receiving the exercise-related information and displaying the response (see paragraph [0065], lines 1-2 (corresponding to page 14, lines 8-9); Fig. 5, step 128; paragraph [0069], lines 8-9 (corresponding to page 15, lines 5-6); Fig. 6, step 228; paragraph [0080], lines 4-5 (corresponding to page 17, lines 1-2)).

Application No.: 12/211,033

Docket No.: 00125/002005 (2051/14C4)

Independent Claim 8 is directed to a non-transitory computer-readable medium, containing an application for performing an interactive method of exercise monitoring, the application physically residing on a server, the method comprising the steps of:

- a. receiving exercise-related information from a web-enabled wireless phone, wherein the exercise-related information includes data indicating a physiologic status of a subject and data indicating an amount of exercise performed by the subject, and wherein the data indicating a physiologic status of a subject is received at least partially while the subject is exercising (see Fig. 6; steps 216, 218, 240, 220, 222; paragraph [0076], lines 1-5 (corresponding to page 16, lines 11-15); paragraph [0077], lines 1-3 (corresponding to page 16, lines 16-18); paragraph [0078], lines 1-4 (corresponding to page 16, lines 19-22));
- b. calculating a response based on the exercise-related information (see Fig. 4, server 22; paragraph [0058], lines 1-2 (corresponding to page 12, lines 23-24); Fig. 6, step 226; paragraph [0080], lines 1-2 (corresponding to page 16, lines 26-27));
- c. transmitting the calculated response to the web-enabled wireless phone (see Fig. 6, step 228; paragraph [0080], lines 4-5 (corresponding to page 17, lines 1-2)).

## **VI. GROUNDS OF REJECTION TO BE REVIEWED UPON APPEAL**

A. Whether Claims 1-4 and 6-21 are erroneously rejected under 35 U.S.C. 102(e) as being anticipated by U.S. Patent No. 6,790,178 (Mault) (which includes a further ground of rejection to be reviewed – whether the Declaration under 37 C.F.R. 1.131 submitted by Appellant was erroneously rejected).

B. Whether Claims 1-4, 7-10, 12-16 and 20-21 are erroneously rejected under 35 U.S.C. 103(a) as being unpatentable over U.S. Patent No. 6,059,692 (Hickman) in view of U.S. Patent No. 6,353,839 (King).

C. Whether Claims 11 and 17-19 are erroneously rejected under 35 U.S.C. 103(a) as being unpatentable over Hickman in view of King and further in view of U.S. Patent No. 6,524,189 (Rautila).

Application No.: 12/211,033

Docket No.: 00125/002005 (2051/14C4)

## VII. ARGUMENT

A. Whether Claims 1-4 and 6-21 are erroneously rejected as being anticipated by Mault  
(and whether the Declaration under 37 C.F.R. 1.131 submitted by Appellant was erroneously rejected)

Appellant first notes clear errors with regard to Office policy. The Final Office Action initially addressed Appellant's Response filed June 14, 2011 by alleging that "The applicant's date of invention for his provisional application 60/172,486 was signed on November 6, 1999; however, the same application was not filed until December 17, 1999. Currently, the effective provisional date for 60/172,486 is December 17, 1999."

Appellant submits that this statement is clearly erroneous. Appellant is permitted under 37 CFR 1.131 to submit a Declaration to establish invention of the subject matter of the rejected claims prior to the effective date of the reference on which the rejection is based. Appellant alleged and provided evidence proving up a date of invention at least as early as November 6, 1999, i.e., a Declaration under 37 CFR 1.131 to prove a date of invention prior to that of Appellant's provisional filing date, this date antedating most of the provisional applications to which the Mault reference claimed priority. No substantive issues were raised with regard to this Declaration.

However, in the Final Office Action dated August 30, 2011, the Examiner rejected the Declaration as moot under MPEP 715.05 because "When the reference in question is a non-commonly owned US patent or patent application publication *claiming the same invention* as applicant and its publication date is less than 1 year prior to the presentation of claims to that invention in the application being examined, applicant's remedy, if any, must be by way of 37 CFR 41.202 instead of 37 CFR 1.131." (Page 9 of Final Office Action; emphasis added herein).

Appellant submits that this allegation is also clearly erroneous. On this issue in particular, Appellant is (again) submitting these arguments in writing as Appellant was advised to do so upon calling the Office on September 21, 2011 in an attempt to remove this ground of rejection in a more expeditious manner.

Appellant believes MPEP 715.05 is inappropriately applied to the present case because the same deals with a US patent or application which claims the same invention, as defined in 37 CFR 41.203(a), as the Appellant. On the other hand, and pertinent to the present case, MPEP 706.02(b)

Application No.: 12/211,033

Docket No.: 00125/002005 (2051/14C4)

states that a rejection based on 35 USC 102(e) *can be overcome* by “(D) filing an affidavit or declaration under 37 CFR 1.131 showing prior invention, if the reference is not a US patent or US patent application publication claiming the same patentable invention as defined in 37 CFR 41.203(a)”. MPEP 715(I)(A) states the same examination guideline of 706.02(b) in an alternative manner.

Appellant submits that the Examiner has not made the requisite showing under 37 CFR 41.203(a) that the Mault reference claims the same patentable invention as recited in the present pending claims.

Moreover, Appellant submits that a comparison of the single claim of the Mault reference<sup>1</sup> with the present claims *clearly indicates distinct subject matter*:

Mault requires an EKG and heart sound monitor including a housing with two or more electrodes and a microphone, a two-part separable connector, the two parts being operative when interconnected to physically join the monitor and a handheld unit in a rigid manner, and so on, which does not provide any exercise information;

The present claims require coupling a web enabled wireless phone to a device which provides exercise related information, receiving data indicating a physiological status of a subject where the data is received at least partially while the subject is exercising, receiving data indicating an amount of exercise performed by the subject, sending the information to an Internet server and receiving a calculated response, and so on.

Clearly these are patentably distinct inventions.

In view of the preceding remarks, absent a valid application of the two-way obviousness interference standard, Appellant requests the Office consider and accept the Rule 1.131 Declaration, which swears behind the effective date of most of the Mault provisional applications, and withdraw the 102(e) rejection based on Mault.

---

<sup>1</sup> Appellant notes that the Mault provisional applications purport to have claims as well. However, claims are not required for such applications under 35 USC 111(b)(2). Moreover, 111(b)(8) states that provisional applications are not subject to interferences. By this analysis, and by extension to the present circumstances, Mault’s provisional “claims” cannot be properly used as the basis for the two-way obviousness interference standard. However, even if they were, Appellant submits such claims are clearly patentably distinct.

Application No.: 12/211,033

Docket No.: 00125/002005 (2051/14C4)

Discussion of alleged teachings of Mault

On the more substantive issues regarding Mault, Appellant notes that the Examiner takes the position that even the five Mault provisional applications having an earlier filing date than the date of invention shown on Appellant's Rule 1.131 Declaration defeat the novelty of the claims.

Appellant submits this position is clearly in error.

Appellant initially notes the requirements of a novelty rejection. As noted at MPEP 2131: "To anticipate a claim, the reference must teach every element of the claim: A claim is anticipated only if each and every element as set forth in the claim is found, either expressly or inherently described, in a single prior art reference." *Verdegaal Bros. v. Union Oil Co. of California*, 814 F.2d 628, 631, 2 USPQ2d 1051, 1053 (Fed. Cir. 1987)... "The identical invention must be shown in as complete detail as is contained in the ... claim." *Richardson v. Suzuki Motor Co.*, 868 F.2d 1226, 1236 (Fed. Cir. 1989)."

Appellant respectfully submits that Mault fails to teach or disclose the inventions of each of independent Claims 1 and 8, especially with regard to his five provisional applications filed prior to November 6, 1999.

In particular, the five Mault provisional applications *filed before November 6, 1999* disclose the following types of devices (here Appellant notes in particular computing devices, apart from physiological monitoring devices): PDAs and a handheld computer (60/155,851); a computer as well as a PDA (60/158,553); and PDAs (60/158,556). The other two Mault provisional applications filed during this period focus on specific types of physiological monitoring. The communication schemes by which the PDA (Personal Digital Assistant) communicates with a central station via a telecommunications network are disclosed as either a plug-in module for the PDA which electrically connects to the network, or via a wireless connection to a transceiver which is connected to the network, or through an intermediate unit such as a personal computer which connects to the network via a modem or the like (60/155,851, 60/158,556); or alternatively, a portable unit with an electrical output in the common format of the system for loading into a local computer or communications device for transmission to the remote computer (60/158,553).

The five Mault provisional applications filed before November 6, 1999 do not disclose a phone, as the term is claimed by Appellant. A "phone" is shorthand for a "telephone", the

Application No.: 12/211,033

Docket No.: 00125/002005 (2051/14C4)

dictionary definition of which is “a system that converts acoustic vibrations to electrical signals in order to transmit sound, typically voices over a distance using wire or radio” (Oxford Dictionary Online). None of the devices disclosed by Mault in these provisional applications have such voice functionality. Moreover, the Appellant is not required to disclose the voice capability of a telephone expressly because it is inherent in the function of a telephone and would be so recognized by persons of ordinary skill. According to MPEP 2163.07(A) “ By disclosing in a patent application a device that inherently performs a function or has a property, operates according to a theory or has an advantage, a patent application necessarily discloses that function, theory or advantage, even though it says nothing explicit concerning it. The application may later be amended to recite the function, theory or advantage without introducing prohibited new matter. *In re Reynolds*, 443 F.2d 384, 170 USPQ 94 (CCPA 1971); *In re Smythe*, 480 F. 2d 1376, 178 USPQ 279 (CCPA 1973). "To establish inherency, the extrinsic evidence 'must make clear that the missing descriptive matter is necessarily present in the thing described in the reference, and that it would be so recognized by persons of ordinary skill". It should be noted that appellant is not suggesting that descriptive matter is missing: in fact, support for voice functionality is found in paragraph [0016], lines 6-7 and paragraph [0030], lines 7-9.

Appellant notes in addition that on page 8 of the Final Office Action of August 30, 2011, the Examiner gave an alternative definition for phone as "an instrument for reproducing sounds at a distance; specifically: one in which sound is converted into electrical impulses for transmission (as by wire or radio waves)". The Examiner construed this definition as “a device which transmits data using electrical impulses”, and employed the same at the bottom of page 8 of the Final Office Action to allege Mault’s disclosure of the claimed invention. Appellant respectfully submits these definitions are untenable. For one, the first definition would fail to even read on the PDA of Mault, as the PDA would fail to reproduce sounds at a distance. Next, the second definition of phone given by the Examiner is clearly overly broad and would read on devices that do not have any voice capability, which should not be construed as “phones” by anyone's definition. <sup>2</sup>

---

<sup>2</sup> In this regard, Appellant notes the Examiner made a similarly overly broad interpretation of a web-enabled wireless phone in the Final Office Action of August 13, 2010, with respect to Root et al., US Patent No. 6,013,007. This rejection was withdrawn in response to the Pre-Appeal Brief Request for Review filed November 15, 2010.

Application No.: 12/211,033

Docket No.: 00125/002005 (2051/14C4)

Furthermore, Mault has no disclosure of a method for interactive exercise monitoring, the method including the step of coupling a web-enabled wireless phone to a device which provides exercise-related information - particularly not in the provisionals having an earlier filing date than the date of invention shown on Appellant's Rule 1.131 Declaration noted above. Rather, these provisionals disclose PDAs that primarily employ plug-ins (though internal software is disclosed) that allow a physiological or activity measurement. The PDA incorporates apparatus for sending results to "a central station via a telecommunications network such as the Internet". The link between the PDA and the telecommunications network could be "via a wireless connection to a transceiver which is connected to the Internet". The same link return signals to the PDA for display to the user. See, e.g., 60/155,851, page 2, at paragraph 3. Monitors may also be coupled to the PDA through a wireless channel. See, e.g., 60/158,553, page 3, at paragraph 3.

Therefore, Appellant submits that Mault is deficient as anticipatory reference as the same lacks teaching or disclosure of a web enabled wireless phone. Mault's PDA cannot meet this claim limitation as, at the time of filing, a PDA and a mobile phone were distinct devices: it was in fact several years later until their functions became similar. The present application discloses one type of wireless web device being a PDA equipped with a wireless modem, and another type of wireless web device being a web enabled wireless phone, and a third type being a device that combines the functions of a computer, PDA, and telephone. Appellant's provisional application, included by reference, disclosed the same as separate embodiments of a wireless web device. Tellingly, Mault discloses a mobile phone in his 60/265,166 provisional application, *but as a distinct disclosure from a PDA* as described in his earlier provisional applications. However, provisional application 60/265,166 was filed subsequent to Appellant's date of invention as illustrated by Appellant's declaration of invention, and thus cannot be used as prior art.

Therefore, for at least this reason, Appellant submits that the rejection of each of independent Claims 1 and 8 based on Mault should be withdrawn.

Even assuming, arguendo, the reference was not deficient on this basis, other distinctions may also be seen. For example, with respect to Claim 1, Mault lacks teaching or disclosure of a user interface to display a response via a web enabled phone as disclosed and claimed by Appellant. What makes a web-enabled mobile phone distinct from a conventional cellular phone are features, e.g., a microbrowser, designed to operate within the constraints of a small display screen, to access

Application No.: 12/211,033

Docket No.: 00125/002005 (2051/14C4)

and display information derived from the web (see, e.g., Appellant's provisional patent application at page 2, paragraph 2), and an operating system that includes the ability to download application programs from a website.

For additional information about the known characteristics of a web-enabled phone, the Board is referred to:

<http://www.educause.edu/EDUCAUSE+Quarterly/EDUCAUSEQuarterlyMagazineVolum/SmartphonesandOtherMobileDevic/157292>).

For at least this reason as well, Appellant submits that the rejection of Claim 1 based on Mault should be withdrawn.

The Mault reference is even more deficient with respect to the dependent claims. For example, with respect to each of dependent Claims 9 and 16, Mault lacks teach or disclosure of downloading an application program from an internet server. See, e.g., Appellant's provisional patent application 60/172,486, at page 2, para 2, and page 3, para 1. Rather, Mault teaches that the local application software is loaded from plug-in modules. Alternatively, the reference discloses that the application software may be resident in the memory of the PDA. See, e.g., Mault '178 at 4:44-47. However, the reference does not teach by what means the application software is loaded into the PDA memory. It is noted that in one of the Mault provisional cases (60/165,166), filed subsequently to Appellant's provisional patent declaration of invention, the reference discloses a server program to receive and process data from a mobile phone; but notably, even in this disclosure, there is no teaching of downloading the application program to the phone, as required by instant Claims 9 and 16.

In response to these arguments, the Examiner disagreed and alleged the following primary points in the latest Final Office Action. The Examiner equated the claimed web enabled wireless phone with devices in Mault, and the Examiner alleged that the earliest provisional applications of Mault establish a wireless device that meets the requirements of the claims.

Appellant notes that the remainder of the Examiner's comments in the Final Office Action of August 30, 2011 based on Mault alone concern provisional applications filed after November 6, 1999.

Accordingly, for at least all of the above reasons, Appellant submits the 102(e) novelty rejection based upon Mault is clearly erroneous and should be withdrawn.



Application No.: 12/211,033

Docket No.: 00125/002005 (2051/14C4)

B. Whether Claims 1-4, 7-10, 12-16 and 20-21 are erroneously rejected  
as being unpatentable over Hickman in view of King

With regard to the rejection of Claims 1-4, 7-10, 12-16, and 20-21 as being allegedly unpatentable over Hickman in view of King, Appellant provided clear reasons for patentability in the Response filed June 14, 2011.

First, Appellant initially notes the requirements of the cited code section (35 USC 103):

A patent may not be obtained though the invention is not identically disclosed or described as set forth in section 102 of this title, if the differences between the subject matter sought to be patented and the prior art are such that the subject matter as a whole would have been obvious at the time the invention was made to a person having ordinary skill in the art to which said subject matter pertains. Patentability shall not be negated by the manner in which the invention was made.

(Emphasis added.)

Appellant submits that at the time the invention was made, the claimed invention was clearly non-obvious over the prior art cited.

In particular, the Examiner alleges that it is obvious that a conventional computer, as taught by Hickman in the light of King, can be replaced by a mobile phone. The Examiner states that, “replacing a cumbersome desktop computer with a mobile web-enabled phone is merely a product of market pressure as a result of increasing demand for mobile access to the Internet and increasing processing power for such mobile devices.” However, the Examiner’s argument relies on impermissible hindsight in the light of the evolution of mobile phones over the last decade.

In particular, MPEP § 2142 states that “To reach a proper determination under 35 U.S.C. 103, the examiner must step backward in time and into the shoes worn by the hypothetical "person of ordinary skill in the art" when the invention was unknown and just before it was made. In view of all factual information, the examiner must then make a determination whether the claimed invention "as a whole" would have been obvious at that time to that person. Knowledge of applicant's disclosure must be put aside in reaching this determination, yet kept in mind in order to determine

Application No.: 12/211,033

Docket No.: 00125/002005 (2051/14C4)

the "differences," conduct the search and evaluate the "subject matter as a whole" of the invention. The tendency to resort to "hindsight" based upon applicant's disclosure is often difficult to avoid due to the very nature of the examination process. However, impermissible hindsight must be avoided and the legal conclusion must be reached on the basis of the facts gleaned from the prior art."

The Appellant concurs that nowadays mobile phones are being used for many tasks previously requiring a personal computer. However, this was clearly not the case at the time the invention was made twelve years ago. Rather, the use of a web-enabled wireless phone to replace the personal computer and standard telephone modem, or a conventional telemetry system of the time, was a product innovation and by no means obvious to a person having ordinary skill in the art—as previously discussed in response to prior rejections, e.g., those under the Root reference,

In particular, the relatively small amount of memory and processing capability provided on a wireless phone in the 1990s, as compared to the present time, severely limited the functionality of applications running on the wireless phone, especially in terms of computing capacity, processing power, and user interface. In the current claimed systems, e.g., the application program downloaded from a server is thus designed to suit the constraints of the small display screens of a mobile phone. An illustration of the display screen of an extant web-enabled wireless phone at the time of the invention is provided in the Appellant's provisional filing, which is included by way of reference. By providing significant application functionality on the server, less memory and processing capabilities become necessary on the wireless phone; thus freeing memory and processing for an interactive user interface and for receiving the exercise related data. The external application running on the internet server and external data storage were other examples of ways employed to overcome the computing limitations of a mobile phone.

Even the King reference acknowledges that mobile phones at the time of their invention were extremely limited in computing power, memory capacity, display capability, input interface, and web browser implementation in comparison to desktop personal computers. See, e.g., 1:35-54. Hence, the purpose of King was to improve the display functionality of a mobile wireless device by reducing the delay involved in interacting with a back-end server. See, e.g., 2:3-29.

Consequently, King does not teach or disclose the use of mobile phones to control and monitor devices connected via a generic input/output port to the mobile phone. Nor does the

Application No.: 12/211,033

Docket No.: 00125/002005 (2051/14C4)

reference teach or disclose how exercise or physiological data may be received by means of a wired or wireless connection to the phone, or that an application program downloaded from the server controls the manner, content, and display of the measured data to the user. Such teaching has been improperly gleaned from Appellant's own specification alone and thus the combination of King and Hickman is an exercise of impermissible hindsight.

As one of ordinary skill in the art would not have been led to combine King with Hickman at the time the invention was made, a *prima facie* case of obviousness cannot be shown, and thus the rejection of Claims 1, 8, 9, 14, and 15 should be withdrawn.

Even assuming, *arguendo*, the above were not the case, the references clearly teach away from their own combination.

In this regard Appellant notes that:

**VI. PRIOR ART MUST BE CONSIDERED IN ITS ENTIRETY, INCLUDING DISCLOSURES THAT TEACH AWAY FROM THE CLAIMS**

A prior art reference must be considered in its entirety, i.e., as a whole, including portions that would lead away from the claimed invention. *W.L. Gore & Associates, Inc. v. Garlock, Inc.*, 721 F.2d 1540, 220 USPQ 303 (Fed. Cir. 1983), cert. denied, 469 U.S. 851 (1984) (Claims were directed to a process of producing a porous article by expanding shaped, unsintered, highly crystalline poly(tetrafluoroethylene) (PTFE) by stretching said PTFE at a 10% per second rate to more than five times the original length. The prior art teachings with regard to unsintered PTFE indicated the material does not respond to conventional plastics processing, and the material should be stretched slowly. A reference teaching rapid stretching of conventional plastic polypropylene with reduced crystallinity combined with a reference teaching stretching unsintered PTFE would not suggest rapid stretching of highly crystalline PTFE, in light of the disclosures in the art that teach away from the invention, i.e., that the conventional polypropylene should have reduced crystallinity before stretching, and that PTFE should be stretched slowly.).

However, "the prior art's mere disclosure of more than one alternative does not constitute a teaching away from any of these alternatives because such disclosure does not criticize, discredit, or otherwise discourage the solution claimed.." In re Fulton, 391 F.3d 1195, 1201, 73 USPQ2d 1141, 1146 (Fed. Cir. 2004). >See also MPEP § 2123.<

In particular, the Office uses Hickman for a basic disclosure of a "virtual personal trainer", while using King for a disclosure of a mobile phone as a computing device. Hickman specifically uses a script system to control and monitor the operation of the exercise apparatus. In fact, the script system appears to be a key element of the invention, and is included in all of the claims.

Application No.: 12/211,033

Docket No.: 00125/002005 (2051/14C4)

However, King specifically teaches away from script systems (2:6-11). Thus, one of ordinary skill in the art, with Hickman in hand, would never look to the King reference for potential combination.

Again, at the time the invention was made, it would not have been obvious to replace the computer of Hickman with the mobile phone of King, and in fact, to do so would change the principle of operation of the references, which is prohibited by MPEP 2143.01(VI). In particular, to combine the script system of Hickman with the necessarily non-script system of King would require changing the principle of operation of one or the other. However, the script system of Hickman appears to be a key element of the invention, and is included in all the claims. In the same way, using a script system in King would not be a mere design variation; rather, the same is explicitly stated to be "too complicated to be used in mobile devices". (2:10-11).

In response, the Examiner disagreed, noting that the King reference acknowledges that there is a growing need for a mobile paradigm in which the Internet can be instantly accessed by mobile devices. First, Appellant notes that he himself acknowledged this disclosure in King at the bottom of page 11 of the Response filed June 14, 2011. The King reference, intended to increase usability and navigation of web pages using thin devices such as mobile phones, would naturally have come about from a growing need for a mobile paradigm. But Appellant submits that this is a very different matter from the problem faced by the Appellant in developing the invention, to wit, providing mobile devices for health and exercise monitoring. Appellant solved the problem by *placing much of the processing on the server side* and using the limited computing capacity of the mobile device to serve as a conduit for health and exercise data. The King reference, on the other hand, "solves [the problem] without the necessity of the server round-trip and without incurring all the memory and processing requirements of a full scripting language." (2:27-30, Emphasis added). In short, clearly neither King nor Hickman nor their combination point the way for one of ordinary skill in the art to make and use the claimed invention.

Next, Appellant submits that to replace the computer of Hickman with the mobile phone of King without clear reasons to do so is employing impermissible hindsight. The Examiner stated that it would have been obvious to do so to one of ordinary skill in the art at the time of the invention because "replacing a cumbersome desktop computer with a mobile web-enabled phone is merely a product of market pressure." But it is important to note that the time period in question is almost 12 years ago. Appellant submits that many industry experts would question that a mobile phone could

Application No.: 12/211,033

Docket No.: 00125/002005 (2051/14C4)

replace a computer for many computing tasks, even with smart phones today, much less 12 years ago. At the time of the invention it was not the case that there were a "finite number of identifiable solutions" as suggested by the Examiner. It took several more years for those solutions to emerge. To summarize, the proposed combination does not suggest the desirability of the claimed invention, running afoul of MPEP 2143.01(I). The same renders the prior art unsatisfactory for its intended purpose, running afoul of MPEP 2143.01(V). And the same changes the principle of operation of the references, running afoul of MPEP 2143.01(VI).

Accordingly, as one of ordinary skill in the art would not be led to combine King with Hickman at the time the invention was made, a *prima facie* case of obviousness has not been shown, and consequently Appellant respectfully submits that maintaining the rejection is clearly erroneous and the same should be withdrawn.

C. Whether Claims 1-4, 7-10, 12-16 and 20-21 are erroneously rejected as being unpatentable over Hickman in view of King

With regard to the rejection of Claims 11 and 17-19 based on Hickman in view of King and further in view of Rautila, Appellant provided clear reasons for patentability on in the Response filed June 14, 2011.

Specifically, Rautila teaches a system to link together multiple mobile phones and game units using a short range radio communication link, e.g., Bluetooth, to bypass a cellular network, or alternatively through a public wireless network. See, e.g., 4:55-65. The mobile phones are used to share game-related data with users. However, Rautila does not disclose that which is missing from the combination of Hickman and King. In particular, Rautila provides no more evidence of why one of ordinary skill in the art would develop the claimed invention at the time of the invention using the combination of references proposed by the Office. Appellant respectfully submits that it is only with the benefit of hindsight, gained through over a decade of development of mobile phones, can the claimed invention seem obvious. Accordingly, Appellant submits that the rejection based on the combination is improper and should be withdrawn.

Application No.: 12/211,033

Docket No.: 00125/002005 (2051/14C4)

No additional comments with regard to this rejection were made by the Examiner in the Final Office Action of August 30, 2011 and accordingly Appellant respectfully submits that maintaining the rejection is erroneous and the same should be withdrawn.<sup>3</sup>

Concluding Comments

For at least the above reasons, Appellant respectfully submits that the Examiner's rejections under 35 U.S.C § 102 (e) and 35 U.S.C § 103(a) are in error and should be reversed.

Finally, Appellant notes that his patent application has undergone rigorous prosecution with two Examiners, having had three non-final Office Actions and two Final Office Actions over the last several years, each with varying rejections set forth and then changed, and has successfully had rejections withdrawn at the Board level. Clearly his innovation is pioneering, and was previously recognized by the Office, as he has been successful in obtaining five patents in this family. He was approached by Royal Philips Electronics and successfully assigned several of these patents to the same for significant value. In the interest of compact prosecution as laid out in the Official Gazette November 7, 2003, Appellant respectfully submits that if the clearly erroneous rejections are again withdrawn, it is time to allow the case to pass to issuance in an expeditious manner.

Dated: March 12, 2012

Respectfully submitted,

Attorney for Appellant  
Mayer & Williams PC  
251 North Avenue West, 2<sup>nd</sup> Floor  
Westfield, NJ 07090  
619-818-4615 Tel.  
908-518-7795 Fax

By: /Mark Wiczorek/

\_\_\_\_\_  
Mark D. Wiczorek  
Registration No.: 37,966

---

<sup>3</sup> In this regard Appellant notes a similar obviousness rejection using the above noted Root reference was previously withdrawn by the Board.

Application No.: 12/211,033

Docket No.: 00125/002005 (2051/14C4)

### **VIII. Claims Appendix**

1. A method for interactive exercise monitoring, the method comprising the steps of:
  - a. coupling a web-enabled wireless phone to a device which provides exercise-related information;
  - b. rendering a user interface on the web-enabled wireless phone;
  - c. receiving data indicating a physiologic status of a subject;
  - d. receiving data indicating an amount of exercise performed by the subject;
  - e. wherein at least one of the data indicating a physiologic status of a subject or the data indicating an amount of exercise performed by the subject is received from the device which provides exercise-related information, and wherein the data indicating a physiologic status of a subject is received at least partially while the subject is exercising;
  - f. sending the exercise-related information to an internet server via a wireless network;
  - g. receiving a calculated response from the server, the response associated with a calculation performed by the server based on the exercise-related information; and
  - h. running an application in the web-enabled wireless phone for receiving the exercise-related information and displaying the response.
  
2. The method of claim 1, wherein the receiving data indicating a physiologic status of a subject includes receiving data from a physiological sensor coupled to an exercise machine.
  
3. The method of claim 1, where the receiving data indicating an amount of exercise performed by the subject includes receiving data from an exercise machine.
  
4. The method of claim 1, wherein the web-enabled wireless phone receives exercise-related information over a transmission medium, the transmission medium including a wired connection or a wireless connection.
  
6. The method of claim 0, wherein the web-enabled wireless phone receives data via an adapter to convert a signal from the device to a suitable input for the wireless phone.

Application No.: 12/211,033

Docket No.: 00125/002005 (2051/14C4)

7. The method of claim 1, wherein the data indicating an amount of exercise performed is received from a device selected from the group consisting of: a treadmill, a stepper, an exercise cycle, an accelerometer, a rowing machine, physiotherapy equipment, an aerobic or anaerobic exercise device, and a device that monitors an amount of work or rate of work performed.

8. A non-transitory computer-readable medium, containing an application for performing an interactive method of exercise monitoring, the application physically residing on a server, the method comprising the steps of:

d. receiving exercise-related information from a web-enabled wireless phone, wherein the exercise-related information includes data indicating a physiologic status of a subject and data indicating an amount of exercise performed by the subject, and wherein the data indicating a physiologic status of a subject is received at least partially while the subject is exercising;

e. calculating a response based on the exercise-related information;

f. transmitting the calculated response to the web-enabled wireless phone.

9. The medium of claim 8, wherein the method further comprises:

a. enabling the web-enabled wireless phone to receive exercise-related information from a device; and

b. transmitting to the web-enabled wireless phone a device application including a user interface on which the calculated response may be rendered.

10. The medium of claim 8, wherein the calculating a response includes calculating a response to assist a person in monitoring calorie expenditure, losing weight, or maintaining a healthy lifestyle.

11. The medium of claim 8, wherein the instructions further cause the web-enabled wireless phone to receive the exercise-related information via an adapter, the adapter to convert a received data signal to a suitable input for the web-enabled wireless phone.



Application No.: 12/211,033

Docket No.: 00125/002005 (2051/14C4)

12. The medium of claim 8, wherein the data indicating an amount of exercise performed by the subject is received from a device which is selected from the group consisting of: a pedometer, a treadmill, a stepper, an exercise cycle, an accelerometer, a rowing machine, physiotherapy equipment, an aerobic or anaerobic exercise device, and a device that monitors an amount of work or rate of work performed.

13. The medium of claim 8, wherein the receiving exercise-related information includes receiving exercise-related information over a wireless or a wired connection.

14. A web-enabled wireless phone, containing a computer-readable medium, the computer-readable medium comprising memory within a web-enabled wireless phone, the computer-readable medium comprising instructions for causing a processor in the web-enabled wireless phone to perform the method of claim 1.

15. A computer-readable medium, the computer-readable medium comprising memory within a web-enabled wireless phone, the computer-readable medium containing instructions for causing a processor in a web-enabled wireless phone to perform the method of claim 1.

16. The method of claim 1, further comprising downloading the application to the web-enabled wireless phone from a server.

17. The method of claim 4, wherein the wireless connection includes an infrared connection or a radio frequency communication protocol including a short-range wireless transmission scheme.

18. The method of claim 4, wherein the wired connection includes a USB connection, a cable, or a docking station.

19. The method of claim 17, wherein the short-range wireless transmission scheme includes 802.11 or Bluetooth®.

Application No.: 12/211,033

Docket No.: 00125/002005 (2051/14C4)

20. The method of claim 1, wherein the data indicating a physiologic status of a subject is received from a device selected from the group consisting of: a heart rate monitor, a blood pressure monitor, a body temperature monitor, a respiratory monitor, a biofeedback device, an electronic body weight scale, and a body fat gauge.

21. The medium of claim 8, wherein the data indicating a physiologic status of a subject is received from a device which is selected from the group consisting of: a heart rate monitor, a blood pressure monitor, a body temperature monitor, a respiratory monitor, a biofeedback device, an electronic body weight scale, and a body fat gauge.

Application No.: 12/211,033

Docket No.: 00125/002005 (2051/14C4)

**IX. Evidence Appendix**

None.

Application No.: 12/211,033

Docket No.: 00125/002005 (2051/14C4)

**X. Related Proceedings Appendix**

None.

<b>Electronic Patent Application Fee Transmittal</b>				
<b>Application Number:</b>	12211033			
<b>Filing Date:</b>	15-Sep-2008			
<b>Title of Invention:</b>	METHOD AND APPARATUS FOR MONITORING EXERCISE WITH WIRELESS INTERNET CONNECTIVITY			
<b>First Named Inventor/Applicant Name:</b>	Roger J. Quy			
<b>Filer:</b>	Karin L. Williams/Michelle Wolf			
<b>Attorney Docket Number:</b>	00125/002005			
Filed as Small Entity				
<b>Utility under 35 USC 111(a) Filing Fees</b>				
Description	Fee Code	Quantity	Amount	Sub-Total in USD(\$)
<b>Basic Filing:</b>				
<b>Pages:</b>				
<b>Claims:</b>				
<b>Miscellaneous-Filing:</b>				
<b>Petition:</b>				
<b>Patent-Appeals-and-Interference:</b>				
<b>Post-Allowance-and-Post-Issuance:</b>				
<b>Extension-of-Time:</b>				
Extension - 1 month with \$0 paid	2251	1	75	75

Description	Fee Code	Quantity	Amount	Sub-Total in USD(\$)
<b>Miscellaneous:</b>				
<b>Total in USD (\$)</b>				<b>75</b>

**Electronic Acknowledgement Receipt**

<b>EFS ID:</b>	12275606
<b>Application Number:</b>	12211033
<b>International Application Number:</b>	
<b>Confirmation Number:</b>	7693
<b>Title of Invention:</b>	METHOD AND APPARATUS FOR MONITORING EXERCISE WITH WIRELESS INTERNET CONNECTIVITY
<b>First Named Inventor/Applicant Name:</b>	Roger J. Quy
<b>Customer Number:</b>	27774
<b>Filer:</b>	Karin L. Williams/Michelle Wolf
<b>Filer Authorized By:</b>	Karin L. Williams
<b>Attorney Docket Number:</b>	00125/002005
<b>Receipt Date:</b>	12-MAR-2012
<b>Filing Date:</b>	15-SEP-2008
<b>Time Stamp:</b>	09:35:57
<b>Application Type:</b>	Utility under 35 USC 111(a)

**Payment information:**

Submitted with Payment	yes
Payment Type	Deposit Account
Payment was successfully received in RAM	\$75
RAM confirmation Number	8976
Deposit Account	501047
Authorized User	

The Director of the USPTO is hereby authorized to charge indicated fees and credit any overpayment as follows:

Charge any Additional Fees required under 37 C.F.R. Section 1.16 (National application filing, search, and examination fees)

Charge any Additional Fees required under 37 C.F.R. Section 1.17 (Patent application and reexamination processing fees)

Charge any Additional Fees required under 37 C.F.R. Section 1.19 (Document supply fees)

Charge any Additional Fees required under 37 C.F.R. Section 1.20 (Post Issuance fees)

Charge any Additional Fees required under 37 C.F.R. Section 1.21 (Miscellaneous fees and charges)

**File Listing:**

Document Number	Document Description	File Name	File Size(Bytes)/ Message Digest	Multi Part /.zip	Pages (if appl.)
1	Appeal Brief Filed	s2051-14C4-appeal-brief.pdf	215860 024b152d4ea43f677f5aeb1d0a6bb917a154e510	no	22

**Warnings:**

**Information:**

2	Fee Worksheet (SB06)	fee-info.pdf	30625 0d6a908aa267b08f5a91229b6260ec893231ca70	no	2
---	----------------------	--------------	---	----	---

**Warnings:**

**Information:**

<b>Total Files Size (in bytes):</b>			246485		
-------------------------------------	--	--	--------	--	--

This Acknowledgement Receipt evidences receipt on the noted date by the USPTO of the indicated documents, characterized by the applicant, and including page counts, where applicable. It serves as evidence of receipt similar to a Post Card, as described in MPEP 503.

**New Applications Under 35 U.S.C. 111**

If a new application is being filed and the application includes the necessary components for a filing date (see 37 CFR 1.53(b)-(d) and MPEP 506), a Filing Receipt (37 CFR 1.54) will be issued in due course and the date shown on this Acknowledgement Receipt will establish the filing date of the application.

**National Stage of an International Application under 35 U.S.C. 371**

If a timely submission to enter the national stage of an international application is compliant with the conditions of 35 U.S.C. 371 and other applicable requirements a Form PCT/DO/EO/903 indicating acceptance of the application as a national stage submission under 35 U.S.C. 371 will be issued in addition to the Filing Receipt, in due course.

**New International Application Filed with the USPTO as a Receiving Office**

If a new international application is being filed and the international application includes the necessary components for an international filing date (see PCT Article 11 and MPEP 1810), a Notification of the International Application Number and of the International Filing Date (Form PCT/RO/105) will be issued in due course, subject to prescriptions concerning national security, and the date shown on this Acknowledgement Receipt will establish the international filing date of the application.



<b>Electronic Patent Application Fee Transmittal</b>				
<b>Application Number:</b>	12211033			
<b>Filing Date:</b>	15-Sep-2008			
<b>Title of Invention:</b>	METHOD AND APPARATUS FOR MONITORING EXERCISE WITH WIRELESS INTERNET CONNECTIVITY			
<b>First Named Inventor/Applicant Name:</b>	Roger J. Quy			
<b>Filer:</b>	Karin L. Williams/Michelle Wolf			
<b>Attorney Docket Number:</b>	00125/002005			
Filed as Small Entity				
<b>Utility under 35 USC 111(a) Filing Fees</b>				
Description	Fee Code	Quantity	Amount	Sub-Total in USD(\$)
<b>Basic Filing:</b>				
<b>Pages:</b>				
<b>Claims:</b>				
<b>Miscellaneous-Filing:</b>				
<b>Petition:</b>				
<b>Patent-Appeals-and-Interference:</b>				
Filing a brief in support of an appeal	2402	1	310	310
<b>Post-Allowance-and-Post-Issuance:</b>				
<b>Extension-of-Time:</b>				

Description	Fee Code	Quantity	Amount	Sub-Total in USD(\$)
<b>Miscellaneous:</b>				
<b>Total in USD (\$)</b>				<b>310</b>

**Electronic Acknowledgement Receipt**

<b>EFS ID:</b>	12275692
<b>Application Number:</b>	12211033
<b>International Application Number:</b>	
<b>Confirmation Number:</b>	7693
<b>Title of Invention:</b>	METHOD AND APPARATUS FOR MONITORING EXERCISE WITH WIRELESS INTERNET CONNECTIVITY
<b>First Named Inventor/Applicant Name:</b>	Roger J. Quy
<b>Customer Number:</b>	27774
<b>Filer:</b>	Karin L. Williams/Michelle Wolf
<b>Filer Authorized By:</b>	Karin L. Williams
<b>Attorney Docket Number:</b>	00125/002005
<b>Receipt Date:</b>	12-MAR-2012
<b>Filing Date:</b>	15-SEP-2008
<b>Time Stamp:</b>	09:48:48
<b>Application Type:</b>	Utility under 35 USC 111(a)

**Payment information:**

Submitted with Payment	yes
Payment Type	Deposit Account
Payment was successfully received in RAM	\$310
RAM confirmation Number	9051
Deposit Account	501047
Authorized User	

The Director of the USPTO is hereby authorized to charge indicated fees and credit any overpayment as follows:

Charge any Additional Fees required under 37 C.F.R. Section 1.16 (National application filing, search, and examination fees)

Charge any Additional Fees required under 37 C.F.R. Section 1.17 (Patent application and reexamination processing fees)

Charge any Additional Fees required under 37 C.F.R. Section 1.19 (Document supply fees)

Charge any Additional Fees required under 37 C.F.R. Section 1.20 (Post Issuance fees)

Charge any Additional Fees required under 37 C.F.R. Section 1.21 (Miscellaneous fees and charges)

**File Listing:**

Document Number	Document Description	File Name	File Size(Bytes)/ Message Digest	Multi Part /.zip	Pages (if appl.)
1	Fee Worksheet (SB06)	fee-info.pdf	30498 <small>ce52111a35ff26ebe221ec895503e9543ac9d93e</small>	no	2

**Warnings:**

**Information:**

**Total Files Size (in bytes):** 30498

**This Acknowledgement Receipt evidences receipt on the noted date by the USPTO of the indicated documents, characterized by the applicant, and including page counts, where applicable. It serves as evidence of receipt similar to a Post Card, as described in MPEP 503.**

**New Applications Under 35 U.S.C. 111**

**If a new application is being filed and the application includes the necessary components for a filing date (see 37 CFR 1.53(b)-(d) and MPEP 506), a Filing Receipt (37 CFR 1.54) will be issued in due course and the date shown on this Acknowledgement Receipt will establish the filing date of the application.**

**National Stage of an International Application under 35 U.S.C. 371**

**If a timely submission to enter the national stage of an international application is compliant with the conditions of 35 U.S.C. 371 and other applicable requirements a Form PCT/DO/EO/903 indicating acceptance of the application as a national stage submission under 35 U.S.C. 371 will be issued in addition to the Filing Receipt, in due course.**

**New International Application Filed with the USPTO as a Receiving Office**

**If a new international application is being filed and the international application includes the necessary components for an international filing date (see PCT Article 11 and MPEP 1810), a Notification of the International Application Number and of the International Filing Date (Form PCT/RO/105) will be issued in due course, subject to prescriptions concerning national security, and the date shown on this Acknowledgement Receipt will establish the international filing date of the application.**

Application No.: 12/211,033

Docket No.: 00125/002005 (2051/14C4)

**IN THE UNITED STATES PATENT AND TRADEMARK OFFICE**

In re Patent Application of:  
Roger J. Quy

Application No.: 12/211,033

Filed: September 15, 2008

For: METHOD AND APPARATUS FOR  
MONITORING EXERCISE WITH WIRELESS  
INTERNET CONNECTIVITY

Examiner: Shirley Xueying Jian

Confirmation No.: 7693

Art Unit: 3769

Via EFS Web  
Commissioner for Patents  
P.O. Box 1450  
Alexandria, VA 22313-1450

<p>Certificate of Electronic Transmission <u>Under 37 C.F.R. §1.8</u></p> <p>I hereby certify that this correspondence and any document referenced herein are being electronically filed with the USPTO via EFS-Web on March 12, 2012.</p> <p style="text-align: center;"><u>Michelle Wolf</u> (Printed Name of Person Sending Correspondence)</p> <p style="text-align: center;"><u>Michelle Wolf/</u> (Signature)</p>
---

Dear Sir:

**APPEAL BRIEF UNDER 37 C.F.R. §41.37**

As set forth in the Notice of Appeal submitted October 27, 2011 and further to the Notice of Panel Decision mailed January 10, 2012, Appellant appeals the decision of the Examiner mailed August 30, 2011 (“Final Office Action”) in the above-identified application.

Appellant respectfully petitions under 37 C.F.R. 1.136(a) for a one-month extension of time to respond. The U.S. Patent and Trademark Office is authorized to charge the Appeal Fee under 37 C.F.R. 41.20(b)(1) (\$310), the fee for a one-month extension of time under 37 C.F.R. 1.17(a)(1) (\$75), and to charge any other fees deemed owing, and/or to credit any overpayments made regarding the application at large to Deposit Account 50-1047.

Appellant respectfully requests that the Board of Patent Appeals and Interferences reverse the Examiner’s rejections.

Application No.: 12/211,033

Docket No.: 00125/002005 (2051/14C4)

## **I. REAL PARTY IN INTEREST**

Q-TEC Systems LLC is the assignee of the present invention and the real party in interest.

## **II. RELATED APPEALS AND INTERFERENCES**

No prior and pending appeals, judicial proceedings or interferences which may be related to, directly affect or be directly affected by, or have a bearing on the Board's decision in the pending appeal are known to the Appellant.

## **III. STATUS OF CLAIMS**

The claims in the application are Claims 1-4 and 6-21. Claim 5 was previously canceled. Claims 1-4 and 6-21 are finally rejected and on appeal.

## **IV. STATUS OF AMENDMENTS**

A Final Office Action was mailed on August 30, 2011, rejecting Claims 1-4 and 6-21. In response thereto, a Notice of Appeal was filed on October 28, 2011. No amendments have been filed.

## **V. SUMMARY OF CLAIMED SUBJECT MATTER**

A concise explanation of the subject matter defined in each of the independent claims involved in the appeal, referring to the specification, follows. Claims 1 and 14 are the independent claims presently pending.

Independent Claim 1 is directed to a method for interactive exercise monitoring, the method comprising the steps of:

- a. coupling a web-enabled wireless phone to a device which provides exercise-related information (see Fig. 2; WWD 12; HMD 11; paragraph [0015], lines 1-5 (corresponding to page 4, lines 22-26); paragraph [0016], lines 1-7 (corresponding to page 5, lines 1-7) paragraph [0019], lines 1-2 (corresponding to page 5, lines 19-20); paragraph [0020], lines 1-4 (corresponding to page 5, lines 25-28));

Application No.: 12/211,033

Docket No.: 00125/002005 (2051/14C4)

- b. rendering a user interface on the web-enabled wireless phone (see Fig. 2; WWD 12; screen 41; paragraph [0049], lines 5-8 (corresponding to page 10, lines 17-18));
- c. receiving data indicating a physiologic status of a subject (see Fig. 6; steps 216, 218, 240, 220, 222; paragraph [0076], lines 1-5 (corresponding to page 16, lines 11-15); paragraph [0077], lines 1-3 (corresponding to page 16, lines 16-18); paragraph [0078], lines 1-4 (corresponding to page 16, lines 19-22));
- d. receiving data indicating an amount of exercise performed by the subject (see Fig. 6; steps 216, 218, 240, 220, 222; paragraph [0076], lines 1-5 (corresponding to page 16, lines 11-15); paragraph [0077], lines 1-3 (corresponding to page 16, lines 16-18); paragraph [0078], lines 1-4 (corresponding to page 16, lines 19-22));
- e. wherein at least one of the data indicating a physiologic status of a subject or the data indicating an amount of exercise performed by the subject is received from the device which provides exercise-related information, and wherein the data indicating a physiologic status of a subject is received at least partially while the subject is exercising (see paragraph [0013], lines 2-4 (corresponding to page 4, lines 13-15); paragraph [0016], lines 1-3 (corresponding to page 5, lines 1-3));
- f. sending the exercise-related information to an internet server via a wireless network (see Fig. 1, WHMA 10, POP 19, antenna 15, server 17, Internet 21; paragraph [0047], lines 1-7 (corresponding to page 10, lines 1-7); paragraph [0055], lines 1-6 (corresponding to page 11, line 29 to page 12, line 5));
- g. receiving a calculated response from the server, the response associated with a calculation performed by the server based on the exercise-related information (see Fig. 3; paragraph [0058], lines 1-5 (corresponding to page 12, lines 23-27)); and
- h. running an application in the web-enabled wireless phone for receiving the exercise-related information and displaying the response (see paragraph [0065], lines 1-2 (corresponding to page 14, lines 8-9); Fig. 5, step 128; paragraph [0069], lines 8-9 (corresponding to page 15, lines 5-6); Fig. 6, step 228; paragraph [0080], lines 4-5 (corresponding to page 17, lines 1-2)).

Application No.: 12/211,033

Docket No.: 00125/002005 (2051/14C4)

Independent Claim 8 is directed to a non-transitory computer-readable medium, containing an application for performing an interactive method of exercise monitoring, the application physically residing on a server, the method comprising the steps of:

- a. receiving exercise-related information from a web-enabled wireless phone, wherein the exercise-related information includes data indicating a physiologic status of a subject and data indicating an amount of exercise performed by the subject, and wherein the data indicating a physiologic status of a subject is received at least partially while the subject is exercising (see Fig. 6; steps 216, 218, 240, 220, 222; paragraph [0076], lines 1-5 (corresponding to page 16, lines 11-15); paragraph [0077], lines 1-3 (corresponding to page 16, lines 16-18); paragraph [0078], lines 1-4 (corresponding to page 16, lines 19-22));
- b. calculating a response based on the exercise-related information (see Fig. 4, server 22; paragraph [0058], lines 1-2 (corresponding to page 12, lines 23-24); Fig. 6, step 226; paragraph [0080], lines 1-2 (corresponding to page 16, lines 26-27));
- c. transmitting the calculated response to the web-enabled wireless phone (see Fig. 6, step 228; paragraph [0080], lines 4-5 (corresponding to page 17, lines 1-2)).

## **VI. GROUNDS OF REJECTION TO BE REVIEWED UPON APPEAL**

A. Whether Claims 1-4 and 6-21 are erroneously rejected under 35 U.S.C. 102(e) as being anticipated by U.S. Patent No. 6,790,178 (Mault) (which includes a further ground of rejection to be reviewed – whether the Declaration under 37 C.F.R. 1.131 submitted by Appellant was erroneously rejected).

B. Whether Claims 1-4, 7-10, 12-16 and 20-21 are erroneously rejected under 35 U.S.C. 103(a) as being unpatentable over U.S. Patent No. 6,059,692 (Hickman) in view of U.S. Patent No. 6,353,839 (King).

C. Whether Claims 11 and 17-19 are erroneously rejected under 35 U.S.C. 103(a) as being unpatentable over Hickman in view of King and further in view of U.S. Patent No. 6,524,189 (Rautila).



Application No.: 12/211,033

Docket No.: 00125/002005 (2051/14C4)

## VII. ARGUMENT

A. Whether Claims 1-4 and 6-21 are erroneously rejected as being anticipated by Mault  
(and whether the Declaration under 37 C.F.R. 1.131 submitted by Appellant was erroneously rejected)

Appellant first notes clear errors with regard to Office policy. The Final Office Action initially addressed Appellant's Response filed June 14, 2011 by alleging that "The applicant's date of invention for his provisional application 60/172,486 was signed on November 6, 1999; however, the same application was not filed until December 17, 1999. Currently, the effective provisional date for 60/172,486 is December 17, 1999."

Appellant submits that this statement is clearly erroneous. Appellant is permitted under 37 CFR 1.131 to submit a Declaration to establish invention of the subject matter of the rejected claims prior to the effective date of the reference on which the rejection is based. Appellant alleged and provided evidence proving up a date of invention at least as early as November 6, 1999, i.e., a Declaration under 37 CFR 1.131 to prove a date of invention prior to that of Appellant's provisional filing date, this date antedating most of the provisional applications to which the Mault reference claimed priority. No substantive issues were raised with regard to this Declaration.

However, in the Final Office Action dated August 30, 2011, the Examiner rejected the Declaration as moot under MPEP 715.05 because "When the reference in question is a non-commonly owned US patent or patent application publication *claiming the same invention* as applicant and its publication date is less than 1 year prior to the presentation of claims to that invention in the application being examined, applicant's remedy, if any, must be by way of 37 CFR 41.202 instead of 37 CFR 1.131." (Page 9 of Final Office Action; emphasis added herein).

Appellant submits that this allegation is also clearly erroneous. On this issue in particular, Appellant is (again) submitting these arguments in writing as Appellant was advised to do so upon calling the Office on September 21, 2011 in an attempt to remove this ground of rejection in a more expeditious manner.

Appellant believes MPEP 715.05 is inappropriately applied to the present case because the same deals with a US patent or application which claims the same invention, as defined in 37 CFR 41.203(a), as the Appellant. On the other hand, and pertinent to the present case, MPEP 706.02(b)

Application No.: 12/211,033

Docket No.: 00125/002005 (2051/14C4)

states that a rejection based on 35 USC 102(e) *can be overcome* by “(D) filing an affidavit or declaration under 37 CFR 1.131 showing prior invention, if the reference is not a US patent or US patent application publication claiming the same patentable invention as defined in 37 CFR 41.203(a)”. MPEP 715(I)(A) states the same examination guideline of 706.02(b) in an alternative manner.

Appellant submits that the Examiner has not made the requisite showing under 37 CFR 41.203(a) that the Mault reference claims the same patentable invention as recited in the present pending claims.

Moreover, Appellant submits that a comparison of the single claim of the Mault reference<sup>1</sup> with the present claims *clearly indicates distinct subject matter*:

Mault requires an EKG and heart sound monitor including a housing with two or more electrodes and a microphone, a two-part separable connector, the two parts being operative when interconnected to physically join the monitor and a handheld unit in a rigid manner, and so on, which does not provide any exercise information;

The present claims require coupling a web enabled wireless phone to a device which provides exercise related information, receiving data indicating a physiological status of a subject where the data is received at least partially while the subject is exercising, receiving data indicating an amount of exercise performed by the subject, sending the information to an Internet server and receiving a calculated response, and so on.

Clearly these are patentably distinct inventions.

In view of the preceding remarks, absent a valid application of the two-way obviousness interference standard, Appellant requests the Office consider and accept the Rule 1.131 Declaration, which swears behind the effective date of most of the Mault provisional applications, and withdraw the 102(e) rejection based on Mault.

---

<sup>1</sup> Appellant notes that the Mault provisional applications purport to have claims as well. However, claims are not required for such applications under 35 USC 111(b)(2). Moreover, 111(b)(8) states that provisional applications are not subject to interferences. By this analysis, and by extension to the present circumstances, Mault’s provisional “claims” cannot be properly used as the basis for the two-way obviousness interference standard. However, even if they were, Appellant submits such claims are clearly patentably distinct.

Application No.: 12/211,033

Docket No.: 00125/002005 (2051/14C4)

Discussion of alleged teachings of Mault

On the more substantive issues regarding Mault, Appellant notes that the Examiner takes the position that even the five Mault provisional applications having an earlier filing date than the date of invention shown on Appellant's Rule 1.131 Declaration defeat the novelty of the claims.

Appellant submits this position is clearly in error.

Appellant initially notes the requirements of a novelty rejection. As noted at MPEP 2131: "To anticipate a claim, the reference must teach every element of the claim: A claim is anticipated only if each and every element as set forth in the claim is found, either expressly or inherently described, in a single prior art reference." *Verdegaal Bros. v. Union Oil Co. of California*, 814 F.2d 628, 631, 2 USPQ2d 1051, 1053 (Fed. Cir. 1987)... "The identical invention must be shown in as complete detail as is contained in the ... claim." *Richardson v. Suzuki Motor Co.*, 868 F.2d 1226, 1236 (Fed. Cir. 1989)."

Appellant respectfully submits that Mault fails to teach or disclose the inventions of each of independent Claims 1 and 8, especially with regard to his five provisional applications filed prior to November 6, 1999.

In particular, the five Mault provisional applications *filed before November 6, 1999* disclose the following types of devices (here Appellant notes in particular computing devices, apart from physiological monitoring devices): PDAs and a handheld computer (60/155,851); a computer as well as a PDA (60/158,553); and PDAs (60/158,556). The other two Mault provisional applications filed during this period focus on specific types of physiological monitoring. The communication schemes by which the PDA (Personal Digital Assistant) communicates with a central station via a telecommunications network are disclosed as either a plug-in module for the PDA which electrically connects to the network, or via a wireless connection to a transceiver which is connected to the network, or through an intermediate unit such as a personal computer which connects to the network via a modem or the like (60/155,851, 60/158,556); or alternatively, a portable unit with an electrical output in the common format of the system for loading into a local computer or communications device for transmission to the remote computer (60/158,553).

The five Mault provisional applications filed before November 6, 1999 do not disclose a phone, as the term is claimed by Appellant. A "phone" is shorthand for a "telephone", the

Application No.: 12/211,033

Docket No.: 00125/002005 (2051/14C4)

dictionary definition of which is “a system that converts acoustic vibrations to electrical signals in order to transmit sound, typically voices over a distance using wire or radio” (Oxford Dictionary Online). None of the devices disclosed by Mault in these provisional applications have such voice functionality. Moreover, the Appellant is not required to disclose the voice capability of a telephone expressly because it is inherent in the function of a telephone and would be so recognized by persons of ordinary skill. According to MPEP 2163.07(A) “ By disclosing in a patent application a device that inherently performs a function or has a property, operates according to a theory or has an advantage, a patent application necessarily discloses that function, theory or advantage, even though it says nothing explicit concerning it. The application may later be amended to recite the function, theory or advantage without introducing prohibited new matter. *In re Reynolds*, 443 F.2d 384, 170 USPQ 94 (CCPA 1971); *In re Smythe*, 480 F. 2d 1376, 178 USPQ 279 (CCPA 1973). "To establish inherency, the extrinsic evidence 'must make clear that the missing descriptive matter is necessarily present in the thing described in the reference, and that it would be so recognized by persons of ordinary skill". It should be noted that appellant is not suggesting that descriptive matter is missing: in fact, support for voice functionality is found in paragraph [0016], lines 6-7 and paragraph [0030], lines 7-9.

Appellant notes in addition that on page 8 of the Final Office Action of August 30, 2011, the Examiner gave an alternative definition for phone as "an instrument for reproducing sounds at a distance; specifically: one in which sound is converted into electrical impulses for transmission (as by wire or radio waves)". The Examiner construed this definition as “a device which transmits data using electrical impulses”, and employed the same at the bottom of page 8 of the Final Office Action to allege Mault’s disclosure of the claimed invention. Appellant respectfully submits these definitions are untenable. For one, the first definition would fail to even read on the PDA of Mault, as the PDA would fail to reproduce sounds at a distance. Next, the second definition of phone given by the Examiner is clearly overly broad and would read on devices that do not have any voice capability, which should not be construed as “phones” by anyone's definition. <sup>2</sup>

---

<sup>2</sup> In this regard, Appellant notes the Examiner made a similarly overly broad interpretation of a web-enabled wireless phone in the Final Office Action of August 13, 2010, with respect to Root et al., US Patent No. 6,013,007. This rejection was withdrawn in response to the Pre-Appeal Brief Request for Review filed November 15, 2010.

Application No.: 12/211,033

Docket No.: 00125/002005 (2051/14C4)

Furthermore, Mault has no disclosure of a method for interactive exercise monitoring, the method including the step of coupling a web-enabled wireless phone to a device which provides exercise-related information - particularly not in the provisionals having an earlier filing date than the date of invention shown on Appellant's Rule 1.131 Declaration noted above. Rather, these provisionals disclose PDAs that primarily employ plug-ins (though internal software is disclosed) that allow a physiological or activity measurement. The PDA incorporates apparatus for sending results to "a central station via a telecommunications network such as the Internet". The link between the PDA and the telecommunications network could be "via a wireless connection to a transceiver which is connected to the Internet". The same link return signals to the PDA for display to the user. See, e.g., 60/155,851, page 2, at paragraph 3. Monitors may also be coupled to the PDA through a wireless channel. See, e.g., 60/158,553, page 3, at paragraph 3.

Therefore, Appellant submits that Mault is deficient as anticipatory reference as the same lacks teaching or disclosure of *a web enabled wireless phone*. Mault's PDA cannot meet this claim limitation as, at the time of filing, a PDA and a mobile phone were distinct devices: it was in fact several years later until their functions became similar. The present application discloses one type of wireless web device being a PDA equipped with a wireless modem, and another type of wireless web device being a web enabled wireless phone, and a third type being a device that combines the functions of a computer, PDA, and telephone. Appellant's provisional application, included by reference, disclosed the same as separate embodiments of a wireless web device. Tellingly, Mault discloses a mobile phone in his 60/265,166 provisional application, *but as a distinct disclosure from a PDA* as described in his earlier provisional applications. However, provisional application 60/265,166 was filed subsequent to Appellant's date of invention as illustrated by Appellant's declaration of invention, and thus cannot be used as prior art.

Therefore, for at least this reason, Appellant submits that the rejection of each of independent Claims 1 and 8 based on Mault should be withdrawn.

Even assuming, arguendo, the reference was not deficient on this basis, other distinctions may also be seen. For example, with respect to Claim 1, Mault lacks teaching or disclosure of a user interface to display a response via a web enabled phone as disclosed and claimed by Appellant. What makes a web-enabled mobile phone distinct from a conventional cellular phone are features, e.g., a microbrowser, designed to operate within the constraints of a small display screen, to access

Application No.: 12/211,033

Docket No.: 00125/002005 (2051/14C4)

and display information derived from the web (see, e.g., Appellant's provisional patent application at page 2, paragraph 2), and an operating system that includes the ability to download application programs from a website.

For additional information about the known characteristics of a web-enabled phone, the Board is referred to:

<http://www.educause.edu/EDUCAUSE+Quarterly/EDUCAUSEQuarterlyMagazineVolum/SmartphonesandOtherMobileDevic/157292>).

For at least this reason as well, Appellant submits that the rejection of Claim 1 based on Mault should be withdrawn.

The Mault reference is even more deficient with respect to the dependent claims. For example, with respect to each of dependent Claims 9 and 16, Mault lacks teach or disclosure of downloading an application program from an internet server. See, e.g., Appellant's provisional patent application 60/172,486, at page 2, para 2, and page 3, para 1. Rather, Mault teaches that the local application software is loaded from plug-in modules. Alternatively, the reference discloses that the application software may be resident in the memory of the PDA. See, e.g., Mault '178 at 4:44-47. However, the reference does not teach by what means the application software is loaded into the PDA memory. It is noted that in one of the Mault provisional cases (60/165,166), filed subsequently to Appellant's provisional patent declaration of invention, the reference discloses a server program to receive and process data from a mobile phone; but notably, even in this disclosure, there is no teaching of downloading the application program to the phone, as required by instant Claims 9 and 16.

In response to these arguments, the Examiner disagreed and alleged the following primary points in the latest Final Office Action. The Examiner equated the claimed web enabled wireless phone with devices in Mault, and the Examiner alleged that the earliest provisional applications of Mault establish a wireless device that meets the requirements of the claims.

Appellant notes that the remainder of the Examiner's comments in the Final Office Action of August 30, 2011 based on Mault alone concern provisional applications filed after November 6, 1999.

Accordingly, for at least all of the above reasons, Appellant submits the 102(e) novelty rejection based upon Mault is clearly erroneous and should be withdrawn.

Application No.: 12/211,033

Docket No.: 00125/002005 (2051/14C4)

B. Whether Claims 1-4, 7-10, 12-16 and 20-21 are erroneously rejected  
as being unpatentable over Hickman in view of King

With regard to the rejection of Claims 1-4, 7-10, 12-16, and 20-21 as being allegedly unpatentable over Hickman in view of King, Appellant provided clear reasons for patentability in the Response filed June 14, 2011.

First, Appellant initially notes the requirements of the cited code section (35 USC 103):

A patent may not be obtained though the invention is not identically disclosed or described as set forth in section 102 of this title, if the differences between the subject matter sought to be patented and the prior art are such that the subject matter as a whole would have been obvious at the time the invention was made to a person having ordinary skill in the art to which said subject matter pertains. Patentability shall not be negated by the manner in which the invention was made.

(Emphasis added.)

Appellant submits that at the time the invention was made, the claimed invention was clearly non-obvious over the prior art cited.

In particular, the Examiner alleges that it is obvious that a conventional computer, as taught by Hickman in the light of King, can be replaced by a mobile phone. The Examiner states that, “replacing a cumbersome desktop computer with a mobile web-enabled phone is merely a product of market pressure as a result of increasing demand for mobile access to the Internet and increasing processing power for such mobile devices.” However, the Examiner’s argument relies on impermissible hindsight in the light of the evolution of mobile phones over the last decade.

In particular, MPEP § 2142 states that “To reach a proper determination under 35 U.S.C. 103, the examiner must step backward in time and into the shoes worn by the hypothetical "person of ordinary skill in the art" when the invention was unknown and just before it was made. In view of all factual information, the examiner must then make a determination whether the claimed invention "as a whole" would have been obvious at that time to that person. Knowledge of applicant's disclosure must be put aside in reaching this determination, yet kept in mind in order to determine

Application No.: 12/211,033

Docket No.: 00125/002005 (2051/14C4)

the "differences," conduct the search and evaluate the "subject matter as a whole" of the invention. The tendency to resort to "hindsight" based upon applicant's disclosure is often difficult to avoid due to the very nature of the examination process. However, impermissible hindsight must be avoided and the legal conclusion must be reached on the basis of the facts gleaned from the prior art."

The Appellant concurs that nowadays mobile phones are being used for many tasks previously requiring a personal computer. However, this was clearly not the case at the time the invention was made twelve years ago. Rather, the use of a web-enabled wireless phone to replace the personal computer and standard telephone modem, or a conventional telemetry system of the time, was a product innovation and by no means obvious to a person having ordinary skill in the art—as previously discussed in response to prior rejections, e.g., those under the Root reference,

In particular, the relatively small amount of memory and processing capability provided on a wireless phone in the 1990s, as compared to the present time, severely limited the functionality of applications running on the wireless phone, especially in terms of computing capacity, processing power, and user interface. In the current claimed systems, e.g., the application program downloaded from a server is thus designed to suit the constraints of the small display screens of a mobile phone. An illustration of the display screen of an extant web-enabled wireless phone at the time of the invention is provided in the Appellant's provisional filing, which is included by way of reference. By providing significant application functionality on the server, less memory and processing capabilities become necessary on the wireless phone; thus freeing memory and processing for an interactive user interface and for receiving the exercise related data. The external application running on the internet server and external data storage were other examples of ways employed to overcome the computing limitations of a mobile phone.

Even the King reference acknowledges that mobile phones at the time of their invention were extremely limited in computing power, memory capacity, display capability, input interface, and web browser implementation in comparison to desktop personal computers. See, e.g., 1:35-54. Hence, the purpose of King was to improve the display functionality of a mobile wireless device by reducing the delay involved in interacting with a back-end server. See, e.g., 2:3-29.

Consequently, King does not teach or disclose the use of mobile phones to control and monitor devices connected via a generic input/output port to the mobile phone. Nor does the



Application No.: 12/211,033

Docket No.: 00125/002005 (2051/14C4)

reference teach or disclose how exercise or physiological data may be received by means of a wired or wireless connection to the phone, or that an application program downloaded from the server controls the manner, content, and display of the measured data to the user. Such teaching has been improperly gleaned from Appellant's own specification alone and thus the combination of King and Hickman is an exercise of impermissible hindsight.

As one of ordinary skill in the art would not have been led to combine King with Hickman at the time the invention was made, a *prima facie* case of obviousness cannot be shown, and thus the rejection of Claims 1, 8, 9, 14, and 15 should be withdrawn.

Even assuming, *arguendo*, the above were not the case, the references clearly teach away from their own combination.

In this regard Appellant notes that:

**VI. PRIOR ART MUST BE CONSIDERED IN ITS ENTIRETY, INCLUDING DISCLOSURES THAT TEACH AWAY FROM THE CLAIMS**

A prior art reference must be considered in its entirety, i.e., as a whole, including portions that would lead away from the claimed invention. *W.L. Gore & Associates, Inc. v. Garlock, Inc.*, 721 F.2d 1540, 220 USPQ 303 (Fed. Cir. 1983), cert. denied, 469 U.S. 851 (1984) (Claims were directed to a process of producing a porous article by expanding shaped, unsintered, highly crystalline poly(tetrafluoroethylene) (PTFE) by stretching said PTFE at a 10% per second rate to more than five times the original length. The prior art teachings with regard to unsintered PTFE indicated the material does not respond to conventional plastics processing, and the material should be stretched slowly. A reference teaching rapid stretching of conventional plastic polypropylene with reduced crystallinity combined with a reference teaching stretching unsintered PTFE would not suggest rapid stretching of highly crystalline PTFE, in light of the disclosures in the art that teach away from the invention, i.e., that the conventional polypropylene should have reduced crystallinity before stretching, and that PTFE should be stretched slowly.).

However, "the prior art's mere disclosure of more than one alternative does not constitute a teaching away from any of these alternatives because such disclosure does not criticize, discredit, or otherwise discourage the solution claimed.." In re Fulton, 391 F.3d 1195, 1201, 73 USPQ2d 1141, 1146 (Fed. Cir. 2004). >See also MPEP § 2123.<

In particular, the Office uses Hickman for a basic disclosure of a "virtual personal trainer", while using King for a disclosure of a mobile phone as a computing device. Hickman specifically uses a script system to control and monitor the operation of the exercise apparatus. In fact, the script system appears to be a key element of the invention, and is included in all of the claims.

Application No.: 12/211,033

Docket No.: 00125/002005 (2051/14C4)

However, King specifically teaches away from script systems (2:6-11). Thus, one of ordinary skill in the art, with Hickman in hand, would never look to the King reference for potential combination.

Again, at the time the invention was made, it would not have been obvious to replace the computer of Hickman with the mobile phone of King, and in fact, to do so would change the principle of operation of the references, which is prohibited by MPEP 2143.01(VI). In particular, to combine the script system of Hickman with the necessarily non-script system of King would require changing the principle of operation of one or the other. However, the script system of Hickman appears to be a key element of the invention, and is included in all the claims. In the same way, using a script system in King would not be a mere design variation; rather, the same is explicitly stated to be "too complicated to be used in mobile devices". (2:10-11).

In response, the Examiner disagreed, noting that the King reference acknowledges that there is a growing need for a mobile paradigm in which the Internet can be instantly accessed by mobile devices. First, Appellant notes that he himself acknowledged this disclosure in King at the bottom of page 11 of the Response filed June 14, 2011. The King reference, intended to increase usability and navigation of web pages using thin devices such as mobile phones, would naturally have come about from a growing need for a mobile paradigm. But Appellant submits that this is a very different matter from the problem faced by the Appellant in developing the invention, to wit, providing mobile devices for health and exercise monitoring. Appellant solved the problem by *placing much of the processing on the server side* and using the limited computing capacity of the mobile device to serve as a conduit for health and exercise data. The King reference, on the other hand, "solves [the problem] without the necessity of the server round-trip and without incurring all the memory and processing requirements of a full scripting language." (2:27-30, Emphasis added). In short, clearly neither King nor Hickman nor their combination point the way for one of ordinary skill in the art to make and use the claimed invention.

Next, Appellant submits that to replace the computer of Hickman with the mobile phone of King without clear reasons to do so is employing impermissible hindsight. The Examiner stated that it would have been obvious to do so to one of ordinary skill in the art at the time of the invention because "replacing a cumbersome desktop computer with a mobile web-enabled phone is merely a product of market pressure." But it is important to note that the time period in question is almost 12 years ago. Appellant submits that many industry experts would question that a mobile phone could

Application No.: 12/211,033

Docket No.: 00125/002005 (2051/14C4)

replace a computer for many computing tasks, even with smart phones today, much less 12 years ago. At the time of the invention it was not the case that there were a "finite number of identifiable solutions" as suggested by the Examiner. It took several more years for those solutions to emerge. To summarize, the proposed combination does not suggest the desirability of the claimed invention, running afoul of MPEP 2143.01(I). The same renders the prior art unsatisfactory for its intended purpose, running afoul of MPEP 2143.01(V). And the same changes the principle of operation of the references, running afoul of MPEP 2143.01(VI).

Accordingly, as one of ordinary skill in the art would not be led to combine King with Hickman at the time the invention was made, a *prima facie* case of obviousness has not been shown, and consequently Appellant respectfully submits that maintaining the rejection is clearly erroneous and the same should be withdrawn.

C. Whether Claims 1-4, 7-10, 12-16 and 20-21 are erroneously rejected as being unpatentable over Hickman in view of King

With regard to the rejection of Claims 11 and 17-19 based on Hickman in view of King and further in view of Rautila, Appellant provided clear reasons for patentability on in the Response filed June 14, 2011.

Specifically, Rautila teaches a system to link together multiple mobile phones and game units using a short range radio communication link, e.g., Bluetooth, to bypass a cellular network, or alternatively through a public wireless network. See, e.g., 4:55-65. The mobile phones are used to share game-related data with users. However, Rautila does not disclose that which is missing from the combination of Hickman and King. In particular, Rautila provides no more evidence of why one of ordinary skill in the art would develop the claimed invention at the time of the invention using the combination of references proposed by the Office. Appellant respectfully submits that it is only with the benefit of hindsight, gained through over a decade of development of mobile phones, can the claimed invention seem obvious. Accordingly, Appellant submits that the rejection based on the combination is improper and should be withdrawn.

Application No.: 12/211,033

Docket No.: 00125/002005 (2051/14C4)

No additional comments with regard to this rejection were made by the Examiner in the Final Office Action of August 30, 2011 and accordingly Appellant respectfully submits that maintaining the rejection is erroneous and the same should be withdrawn.<sup>3</sup>

Concluding Comments

For at least the above reasons, Appellant respectfully submits that the Examiner's rejections under 35 U.S.C § 102 (e) and 35 U.S.C § 103(a) are in error and should be reversed.

Finally, Appellant notes that his patent application has undergone rigorous prosecution with two Examiners, having had three non-final Office Actions and two Final Office Actions over the last several years, each with varying rejections set forth and then changed, and has successfully had rejections withdrawn at the Board level. Clearly his innovation is pioneering, and was previously recognized by the Office, as he has been successful in obtaining five patents in this family. He was approached by Royal Philips Electronics and successfully assigned several of these patents to the same for significant value. In the interest of compact prosecution as laid out in the Official Gazette November 7, 2003, Appellant respectfully submits that if the clearly erroneous rejections are again withdrawn, it is time to allow the case to pass to issuance in an expeditious manner.

Dated: March 12, 2012

Respectfully submitted,

Attorney for Appellant  
Mayer & Williams PC  
251 North Avenue West, 2<sup>nd</sup> Floor  
Westfield, NJ 07090  
619-818-4615 Tel.  
908-518-7795 Fax

By: /Mark Wiczorek/

\_\_\_\_\_  
Mark D. Wiczorek  
Registration No.: 37,966

---

<sup>3</sup> In this regard Appellant notes a similar obviousness rejection using the above noted Root reference was previously withdrawn by the Board.

Application No.: 12/211,033

Docket No.: 00125/002005 (2051/14C4)

### **VIII. Claims Appendix**

1. A method for interactive exercise monitoring, the method comprising the steps of:
  - a. coupling a web-enabled wireless phone to a device which provides exercise-related information;
  - b. rendering a user interface on the web-enabled wireless phone;
  - c. receiving data indicating a physiologic status of a subject;
  - d. receiving data indicating an amount of exercise performed by the subject;
  - e. wherein at least one of the data indicating a physiologic status of a subject or the data indicating an amount of exercise performed by the subject is received from the device which provides exercise-related information, and wherein the data indicating a physiologic status of a subject is received at least partially while the subject is exercising;
  - f. sending the exercise-related information to an internet server via a wireless network;
  - g. receiving a calculated response from the server, the response associated with a calculation performed by the server based on the exercise-related information; and
  - h. running an application in the web-enabled wireless phone for receiving the exercise-related information and displaying the response.
  
2. The method of claim 1, wherein the receiving data indicating a physiologic status of a subject includes receiving data from a physiological sensor coupled to an exercise machine.
  
3. The method of claim 1, where the receiving data indicating an amount of exercise performed by the subject includes receiving data from an exercise machine.
  
4. The method of claim 1, wherein the web-enabled wireless phone receives exercise-related information over a transmission medium, the transmission medium including a wired connection or a wireless connection.
  
6. The method of claim 0, wherein the web-enabled wireless phone receives data via an adapter to convert a signal from the device to a suitable input for the wireless phone.

Application No.: 12/211,033

Docket No.: 00125/002005 (2051/14C4)

7. The method of claim 1, wherein the data indicating an amount of exercise performed is received from a device selected from the group consisting of: a treadmill, a stepper, an exercise cycle, an accelerometer, a rowing machine, physiotherapy equipment, an aerobic or anaerobic exercise device, and a device that monitors an amount of work or rate of work performed.

8. A non-transitory computer-readable medium, containing an application for performing an interactive method of exercise monitoring, the application physically residing on a server, the method comprising the steps of:

d. receiving exercise-related information from a web-enabled wireless phone, wherein the exercise-related information includes data indicating a physiologic status of a subject and data indicating an amount of exercise performed by the subject, and wherein the data indicating a physiologic status of a subject is received at least partially while the subject is exercising;

e. calculating a response based on the exercise-related information;

f. transmitting the calculated response to the web-enabled wireless phone.

9. The medium of claim 8, wherein the method further comprises:

a. enabling the web-enabled wireless phone to receive exercise-related information from a device;

and

b. transmitting to the web-enabled wireless phone a device application including a user interface on which the calculated response may be rendered.

10. The medium of claim 8, wherein the calculating a response includes calculating a response to assist a person in monitoring calorie expenditure, losing weight, or maintaining a healthy lifestyle.

11. The medium of claim 8, wherein the instructions further cause the web-enabled wireless phone to receive the exercise-related information via an adapter, the adapter to convert a received data signal to a suitable input for the web-enabled wireless phone.

Application No.: 12/211,033

Docket No.: 00125/002005 (2051/14C4)

12. The medium of claim 8, wherein the data indicating an amount of exercise performed by the subject is received from a device which is selected from the group consisting of: a pedometer, a treadmill, a stepper, an exercise cycle, an accelerometer, a rowing machine, physiotherapy equipment, an aerobic or anaerobic exercise device, and a device that monitors an amount of work or rate of work performed.

13. The medium of claim 8, wherein the receiving exercise-related information includes receiving exercise-related information over a wireless or a wired connection.

14. A web-enabled wireless phone, containing a computer-readable medium, the computer-readable medium comprising memory within a web-enabled wireless phone, the computer-readable medium comprising instructions for causing a processor in the web-enabled wireless phone to perform the method of claim 1.

15. A computer-readable medium, the computer-readable medium comprising memory within a web-enabled wireless phone, the computer-readable medium containing instructions for causing a processor in a web-enabled wireless phone to perform the method of claim 1.

16. The method of claim 1, further comprising downloading the application to the web-enabled wireless phone from a server.

17. The method of claim 4, wherein the wireless connection includes an infrared connection or a radio frequency communication protocol including a short-range wireless transmission scheme.

18. The method of claim 4, wherein the wired connection includes a USB connection, a cable, or a docking station.

19. The method of claim 17, wherein the short-range wireless transmission scheme includes 802.11 or Bluetooth®.

Application No.: 12/211,033

Docket No.: 00125/002005 (2051/14C4)

20. The method of claim 1, wherein the data indicating a physiologic status of a subject is received from a device selected from the group consisting of: a heart rate monitor, a blood pressure monitor, a body temperature monitor, a respiratory monitor, a biofeedback device, an electronic body weight scale, and a body fat gauge.

21. The medium of claim 8, wherein the data indicating a physiologic status of a subject is received from a device which is selected from the group consisting of: a heart rate monitor, a blood pressure monitor, a body temperature monitor, a respiratory monitor, a biofeedback device, an electronic body weight scale, and a body fat gauge.



Application No.: 12/211,033

Docket No.: 00125/002005 (2051/14C4)

**IX. Evidence Appendix**

None.

Application No.: 12/211,033

Docket No.: 00125/002005 (2051/14C4)

**X. Related Proceedings Appendix**

None.

<b>Electronic Patent Application Fee Transmittal</b>				
<b>Application Number:</b>	12211033			
<b>Filing Date:</b>	15-Sep-2008			
<b>Title of Invention:</b>	METHOD AND APPARATUS FOR MONITORING EXERCISE WITH WIRELESS INTERNET CONNECTIVITY			
<b>First Named Inventor/Applicant Name:</b>	Roger J. Quy			
<b>Filer:</b>	Karin L. Williams/Michelle Wolf			
<b>Attorney Docket Number:</b>	00125/002005			
Filed as Large Entity				
<b>Utility under 35 USC 111(a) Filing Fees</b>				
Description	Fee Code	Quantity	Amount	Sub-Total in USD(\$)
<b>Basic Filing:</b>				
<b>Pages:</b>				
<b>Claims:</b>				
<b>Miscellaneous-Filing:</b>				
<b>Petition:</b>				
<b>Patent-Appeals-and-Interference:</b>				
<b>Post-Allowance-and-Post-Issuance:</b>				
<b>Extension-of-Time:</b>				
Extension - 1 month with \$0 paid	1251	1	150	150

Description	Fee Code	Quantity	Amount	Sub-Total in USD(\$)
<b>Miscellaneous:</b>				
<b>Total in USD (\$)</b>				<b>150</b>

**Electronic Acknowledgement Receipt**

<b>EFS ID:</b>	12275583
<b>Application Number:</b>	12211033
<b>International Application Number:</b>	
<b>Confirmation Number:</b>	7693
<b>Title of Invention:</b>	METHOD AND APPARATUS FOR MONITORING EXERCISE WITH WIRELESS INTERNET CONNECTIVITY
<b>First Named Inventor/Applicant Name:</b>	Roger J. Quy
<b>Customer Number:</b>	27774
<b>Filer:</b>	Karin L. Williams/Michelle Wolf
<b>Filer Authorized By:</b>	Karin L. Williams
<b>Attorney Docket Number:</b>	00125/002005
<b>Receipt Date:</b>	12-MAR-2012
<b>Filing Date:</b>	15-SEP-2008
<b>Time Stamp:</b>	09:31:33
<b>Application Type:</b>	Utility under 35 USC 111(a)

**Payment information:**

Submitted with Payment	no
------------------------	----

**File Listing:**

Document Number	Document Description	File Name	File Size(Bytes)/ Message Digest	Multi Part /.zip	Pages (if appl.)
1	Appeal Brief Filed	s2051-14C4-appeal-brief.pdf	215860 024b152d4ea43f677f5aeb1d0a6bb917a154e510	no	22

**Warnings:****Information:**

2	Fee Worksheet (SB06)	fee-info.pdf	30626	no	2
b1824b9a7121940867297222ee97bff873714e2d					
<b>Warnings:</b>					
<b>Information:</b>					
<b>Total Files Size (in bytes):</b>				246486	
<p>This Acknowledgement Receipt evidences receipt on the noted date by the USPTO of the indicated documents, characterized by the applicant, and including page counts, where applicable. It serves as evidence of receipt similar to a Post Card, as described in MPEP 503.</p> <p><b><u>New Applications Under 35 U.S.C. 111</u></b>  If a new application is being filed and the application includes the necessary components for a filing date (see 37 CFR 1.53(b)-(d) and MPEP 506), a Filing Receipt (37 CFR 1.54) will be issued in due course and the date shown on this Acknowledgement Receipt will establish the filing date of the application.</p> <p><b><u>National Stage of an International Application under 35 U.S.C. 371</u></b>  If a timely submission to enter the national stage of an international application is compliant with the conditions of 35 U.S.C. 371 and other applicable requirements a Form PCT/DO/EO/903 indicating acceptance of the application as a national stage submission under 35 U.S.C. 371 will be issued in addition to the Filing Receipt, in due course.</p> <p><b><u>New International Application Filed with the USPTO as a Receiving Office</u></b>  If a new international application is being filed and the international application includes the necessary components for an international filing date (see PCT Article 11 and MPEP 1810), a Notification of the International Application Number and of the International Filing Date (Form PCT/RO/105) will be issued in due course, subject to prescriptions concerning national security, and the date shown on this Acknowledgement Receipt will establish the international filing date of the application.</p>					

Application Serial No. 12/211,033

**IN THE UNITED STATES PATENT AND TRADEMARK OFFICE**

Applicants: Roger J. Quy  
Application No. 12/211,033  
Filed: September 15, 2008  
Title: METHOD AND APPARATUS FOR MONITORING EXERCISE WITH WIRELESS INTERNET CONNECTIVITY  
Art Unit: 3769  
Examiner: Shirley Jian  
Confirm. No.: 7693  
Docket No.: 00125/002005  
Via EFS Web  
Commissioner for Patents  
P.O. Box 1450  
Alexandria, VA 22313-1450

Certificate of Electronic Transmission  
Under 37 C.F.R. §1.8  
I hereby certify that this correspondence and any document referenced herein are being electronically filed with the USPTO via EFS-Web on April 9, 2012.  
Michelle Wolf  
(Printed Name of Person Sending Correspondence)  
Michelle Wolf/  
(Signature)

**APPLICANT PERSONAL INTERVIEW SUMMARY**

Case 12/211,033  
Applicant Roger J Quy  
Examiner Shirley Xueying Jian

April 4, 2012, 11am-12pm  
Randolph Bldg, USPTO

Participants:  
Applicant Roger J. Quy  
Attorney Mark Wiczorek  
Examiner Shirley Jian  
Supervisory Patent Examiner Sam Yao

The pending claims and applied prior art were discussed.

Agreement was reached that if Applicant is entitled to the November 6, 1999 date of invention recorded in the Provisional filing, the case should be allowable. Such distinguishes Applicant's invention from Mault, and also overcomes the 103 rejections (following discussion in the interview). If the case is not given the recorded date of

Application Serial No. 12/211,033

invention, then Applicant will amend the claims to distinguish over Mault. The amendment will be chosen to be that for which Applicant has most support.

The 103 obviousness rejections were also discussed and Applicant provided reasons for non-obviousness of the subject invention. Agreement was reached that, although the King reference provided background information on the use of mobile devices for accessing the internet, the subject matter taught against the Applicant's invention, and for at least that reason, did not provide support for an obviousness rejection in combination with Hickman or (Rautila).

Various other aspects were also discussed:

Potential double-patenting was raised. Applicant reminded the Office that a rejection under this doctrine had been made in a previous Final Office Action and successfully overcome in a Pre-Appeal Brief Conference (see Office Action of March 18, 2011, page 7). As the claims will either stay the same or be narrowed, agreement was reached that this would not become an issue.

It was agreed that, in an effort towards compact prosecution, if an amendment was required to claims 1 and 8 in order for the application to be allowed, it was preferable to do this by way of an Examiner's amendment, rather than by filing a RCE, or proceeding to an Appeal conference.



**Electronic Acknowledgement Receipt**

<b>EFS ID:</b>	12495551
<b>Application Number:</b>	12211033
<b>International Application Number:</b>	
<b>Confirmation Number:</b>	7693
<b>Title of Invention:</b>	METHOD AND APPARATUS FOR MONITORING EXERCISE WITH WIRELESS INTERNET CONNECTIVITY
<b>First Named Inventor/Applicant Name:</b>	Roger J. Quy
<b>Customer Number:</b>	27774
<b>Filer:</b>	Stuart H. Mayer/Michelle Wolf
<b>Filer Authorized By:</b>	Stuart H. Mayer
<b>Attorney Docket Number:</b>	00125/002005
<b>Receipt Date:</b>	09-APR-2012
<b>Filing Date:</b>	15-SEP-2008
<b>Time Stamp:</b>	12:55:18
<b>Application Type:</b>	Utility under 35 USC 111(a)

**Payment information:**

Submitted with Payment	no
------------------------	----

**File Listing:**

Document Number	Document Description	File Name	File Size(Bytes)/ Message Digest	Multi Part /.zip	Pages (if appl.)
1	Applicant summary of interview with examiner	00125-002005-Applicant-Interview-Summary.pdf	165794 <small>073d430995aaa9cdfca2630106ed2f08ce8a1fc5</small>	no	2

**Warnings:****Information:**

This Acknowledgement Receipt evidences receipt on the noted date by the USPTO of the indicated documents, characterized by the applicant, and including page counts, where applicable. It serves as evidence of receipt similar to a Post Card, as described in MPEP 503.

**New Applications Under 35 U.S.C. 111**

If a new application is being filed and the application includes the necessary components for a filing date (see 37 CFR 1.53(b)-(d) and MPEP 506), a Filing Receipt (37 CFR 1.54) will be issued in due course and the date shown on this Acknowledgement Receipt will establish the filing date of the application.

**National Stage of an International Application under 35 U.S.C. 371**

If a timely submission to enter the national stage of an international application is compliant with the conditions of 35 U.S.C. 371 and other applicable requirements a Form PCT/DO/EO/903 indicating acceptance of the application as a national stage submission under 35 U.S.C. 371 will be issued in addition to the Filing Receipt, in due course.

**New International Application Filed with the USPTO as a Receiving Office**

If a new international application is being filed and the international application includes the necessary components for an international filing date (see PCT Article 11 and MPEP 1810), a Notification of the International Application Number and of the International Filing Date (Form PCT/RO/105) will be issued in due course, subject to prescriptions concerning national security, and the date shown on this Acknowledgement Receipt will establish the international filing date of the application.



UNITED STATES PATENT AND TRADEMARK OFFICE

UNITED STATES DEPARTMENT OF COMMERCE  
 United States Patent and Trademark Office  
 Address: COMMISSIONER FOR PATENTS  
 P.O. Box 1450  
 Alexandria, Virginia 22313-1450  
 www.uspto.gov

APPLICATION NO.	FILING DATE	FIRST NAMED INVENTOR	ATTORNEY DOCKET NO.	CONFIRMATION NO.
12/211,033	09/15/2008	Roger J. Quy	00125/002005	7693

2774 7590 04/16/2012  
 MAYER & WILLIAMS PC  
 251 NORTH AVENUE WEST  
 Suite 201  
 WESTFIELD, NJ 07090

EXAMINER
----------

JIAN, SHIRLEY XUEYING

ART UNIT	PAPER NUMBER
----------	--------------

3769

MAIL DATE	DELIVERY MODE
-----------	---------------

04/16/2012

PAPER

**Please find below and/or attached an Office communication concerning this application or proceeding.**

The time period for reply, if any, is set in the attached communication.

<b>Applicant-Initiated Interview Summary</b>	<b>Application No.</b> 12/211,033	<b>Applicant(s)</b> QUY, ROGER J.	
	<b>Examiner</b> SHIRLEY JIAN	<b>Art Unit</b> 3769	

All participants (applicant, applicant's representative, PTO personnel):

- (1) Shirley Jian. (3) Roger Quy.  
 (2) Sam Yao. (4) Mark Wiczorek.

Date of Interview: 04 April 2012.

Type:  Telephonic  Video Conference  
 Personal [copy given to:  applicant  applicant's representative]

Exhibit shown or demonstration conducted:  Yes  No.  
 If Yes, brief description: \_\_\_\_\_.

Issues Discussed 101 112 102 103 Others  
 (For each of the checked box(es) above, please describe below the issue and detailed description of the discussion)

Claim(s) discussed: 1 and 8.

Identification of prior art discussed: Mault, Hickman, and King.

**Substance of Interview**

(For each issue discussed, provide a detailed description and indicate if agreement was reached. Some topics may include: identification or clarification of a reference or a portion thereof, claim interpretation, proposed amendments, arguments of any applied references etc...)

The participants discussed the possibility of using the applicant's signing date (November 6, 1999) to overcome the Mault reference as filed under CRF 1.131 affidavit; and discussed possible claim amendments to further distinguish the claims over the applied prior art references. However, currently there is no guidance (based on the MPEP) that would support using the date other than the filing date as constructive reduction to practice. As such, the applicant may choose to maintain the Appeal filed on 03/12/2012, or to submit an RCE with the discussed claim amendments.

**Applicant recordation instructions:** The formal written reply to the last Office action must include the substance of the interview. (See MPEP section 713.04). If a reply to the last Office action has already been filed, applicant is given a non-extendable period of the longer of one month or thirty days from this interview date, or the mailing date of this interview summary form, whichever is later, to file a statement of the substance of the interview

**Examiner recordation instructions:** Examiners must summarize the substance of any interview of record. A complete and proper recordation of the substance of an interview should include the items listed in MPEP 713.04 for complete and proper recordation including the identification of the general thrust of each argument or issue discussed, a general indication of any other pertinent matters discussed regarding patentability and the general results or outcome of the interview, to include an indication as to whether or not agreement was reached on the issues raised.

Attachment

/SHIRLEY JIAN/  
 Examiner, Art Unit 3769

/SAM YAO/  
 Supervisory Patent Examiner, Art Unit 3769

**Manual of Patent Examining Procedure (MPEP), Section 713.04, Substance of Interview Must be Made of Record**

A complete written statement as to the substance of any face-to-face, video conference, or telephone interview with regard to an application must be made of record in the application whether or not an agreement with the examiner was reached at the interview.

**Title 37 Code of Federal Regulations (CFR) § 1.133 Interviews**

Paragraph (b)

In every instance where reconsideration is requested in view of an interview with an examiner, a complete written statement of the reasons presented at the interview as warranting favorable action must be filed by the applicant. An interview does not remove the necessity for reply to Office action as specified in §§ 1.111, 1.135. (35 U.S.C. 132)

37 CFR §1.2 Business to be transacted in writing.

All business with the Patent or Trademark Office should be transacted in writing. The personal attendance of applicants or their attorneys or agents at the Patent and Trademark Office is unnecessary. The action of the Patent and Trademark Office will be based exclusively on the written record in the Office. No attention will be paid to any alleged oral promise, stipulation, or understanding in relation to which there is disagreement or doubt.

The action of the Patent and Trademark Office cannot be based exclusively on the written record in the Office if that record is itself incomplete through the failure to record the substance of interviews.

It is the responsibility of the applicant or the attorney or agent to make the substance of an interview of record in the application file, unless the examiner indicates he or she will do so. It is the examiner's responsibility to see that such a record is made and to correct material inaccuracies which bear directly on the question of patentability.

Examiners must complete an Interview Summary Form for each interview held where a matter of substance has been discussed during the interview by checking the appropriate boxes and filling in the blanks. Discussions regarding only procedural matters, directed solely to restriction requirements for which interview recordation is otherwise provided for in Section 812.01 of the Manual of Patent Examining Procedure, or pointing out typographical errors or unreadable script in Office actions or the like, are excluded from the interview recordation procedures below. Where the substance of an interview is completely recorded in an Examiners Amendment, no separate Interview Summary Record is required.

The Interview Summary Form shall be given an appropriate Paper No., placed in the right hand portion of the file, and listed on the "Contents" section of the file wrapper. In a personal interview, a duplicate of the Form is given to the applicant (or attorney or agent) at the conclusion of the interview. In the case of a telephone or video-conference interview, the copy is mailed to the applicant's correspondence address either with or prior to the next official communication. If additional correspondence from the examiner is not likely before an allowance or if other circumstances dictate, the Form should be mailed promptly after the interview rather than with the next official communication.

The Form provides for recordation of the following information:

- Application Number (Series Code and Serial Number)
- Name of applicant
- Name of examiner
- Date of interview
- Type of interview (telephonic, video-conference, or personal)
- Name of participant(s) (applicant, attorney or agent, examiner, other PTO personnel, etc.)
- An indication whether or not an exhibit was shown or a demonstration conducted
- An identification of the specific prior art discussed
- An indication whether an agreement was reached and if so, a description of the general nature of the agreement (may be by attachment of a copy of amendments or claims agreed as being allowable). Note: Agreement as to allowability is tentative and does not restrict further action by the examiner to the contrary.
- The signature of the examiner who conducted the interview (if Form is not an attachment to a signed Office action)

It is desirable that the examiner orally remind the applicant of his or her obligation to record the substance of the interview of each case. It should be noted, however, that the Interview Summary Form will not normally be considered a complete and proper recordation of the interview unless it includes, or is supplemented by the applicant or the examiner to include, all of the applicable items required below concerning the substance of the interview.

A complete and proper recordation of the substance of any interview should include at least the following applicable items:

- 1) A brief description of the nature of any exhibit shown or any demonstration conducted,
- 2) an identification of the claims discussed,
- 3) an identification of the specific prior art discussed,
- 4) an identification of the principal proposed amendments of a substantive nature discussed, unless these are already described on the Interview Summary Form completed by the Examiner,
- 5) a brief identification of the general thrust of the principal arguments presented to the examiner,  
(The identification of arguments need not be lengthy or elaborate. A verbatim or highly detailed description of the arguments is not required. The identification of the arguments is sufficient if the general nature or thrust of the principal arguments made to the examiner can be understood in the context of the application file. Of course, the applicant may desire to emphasize and fully describe those arguments which he or she feels were or might be persuasive to the examiner.)
- 6) a general indication of any other pertinent matters discussed, and
- 7) if appropriate, the general results or outcome of the interview unless already described in the Interview Summary Form completed by the examiner.

Examiners are expected to carefully review the applicant's record of the substance of an interview. If the record is not complete and accurate, the examiner will give the applicant an extendable one month time period to correct the record.

**Examiner to Check for Accuracy**

If the claims are allowable for other reasons of record, the examiner should send a letter setting forth the examiner's version of the statement attributed to him or her. If the record is complete and accurate, the examiner should place the indication, "Interview Record OK" on the paper recording the substance of the interview along with the date and the examiner's initials.

**REQUEST FOR CONTINUED EXAMINATION(RCE)TRANSMITTAL  
 (Submitted Only via EFS-Web)**

Application Number	12211033	Filing Date	2008-09-15	Docket Number (if applicable)	00125/002005	Art Unit	3769
First Named Inventor	Roger J. Quy			Examiner Name	Shirley Xueying Jian		

**This is a Request for Continued Examination (RCE) under 37 CFR 1.114 of the above-identified application.**  
 Request for Continued Examination (RCE) practice under 37 CFR 1.114 does not apply to any utility or plant application filed prior to June 8, 1995, or to any design application. The Instruction Sheet for this form is located at WWW.USPTO.GOV

**SUBMISSION REQUIRED UNDER 37 CFR 1.114**

Note: If the RCE is proper, any previously filed unentered amendments and amendments enclosed with the RCE will be entered in the order in which they were filed unless applicant instructs otherwise. If applicant does not wish to have any previously filed unentered amendment(s) entered, applicant must request non-entry of such amendment(s).

Previously submitted. If a final Office action is outstanding, any amendments filed after the final Office action may be considered as a submission even if this box is not checked.

Consider the arguments in the Appeal Brief or Reply Brief previously filed on \_\_\_\_\_

Other \_\_\_\_\_

Enclosed

Amendment/Reply

Information Disclosure Statement (IDS)

Affidavit(s)/ Declaration(s)

Other \_\_\_\_\_

**MISCELLANEOUS**

Suspension of action on the above-identified application is requested under 37 CFR 1.103(c) for a period of months \_\_\_\_\_  
 (Period of suspension shall not exceed 3 months; Fee under 37 CFR 1.17(i) required)

Other \_\_\_\_\_

**FEES**

**The RCE fee under 37 CFR 1.17(e) is required by 37 CFR 1.114 when the RCE is filed.**  
 The Director is hereby authorized to charge any underpayment of fees, or credit any overpayments, to  
 Deposit Account No 501047

**SIGNATURE OF APPLICANT, ATTORNEY, OR AGENT REQUIRED**

Patent Practitioner Signature

Applicant Signature

Doc description: Request for Continued Examination (RCE)

Approved for use through 07/31/2012. OMB 0651-0031  
 U.S. Patent and Trademark Office; U.S. DEPARTMENT OF COMMERCE

Under the Paperwork Reduction Act of 1995, no persons are required to respond to a collection of information unless it contains a valid OMB control number.

**Signature of Registered U.S. Patent Practitioner**

<b>Signature</b>	/Mark Wieczorek/	<b>Date (YYYY-MM-DD)</b>	2012-05-18
<b>Name</b>	Mark D. Wieczorek	<b>Registration Number</b>	37966

This collection of information is required by 37 CFR 1.114. The information is required to obtain or retain a benefit by the public which is to file (and by the USPTO to process) an application. Confidentiality is governed by 35 U.S.C. 122 and 37 CFR 1.11 and 1.14. This collection is estimated to take 12 minutes to complete, including gathering, preparing, and submitting the completed application form to the USPTO. Time will vary depending upon the individual case. Any comments on the amount of time you require to complete this form and/or suggestions for reducing this burden, should be sent to the Chief Information Officer, U.S. Patent and Trademark Office, U.S. Department of Commerce, P.O. Box 1450, Alexandria, VA 22313-1450.

*If you need assistance in completing the form, call 1-800-PTO-9199 and select option 2.*

## Privacy Act Statement

The Privacy Act of 1974 (P.L. 93-579) requires that you be given certain information in connection with your submission of the attached form related to a patent application or patent. Accordingly, pursuant to the requirements of the Act, please be advised that: (1) the general authority for the collection of this information is 35 U.S.C. 2(b)(2); (2) furnishing of the information solicited is voluntary; and (3) the principal purpose for which the information is used by the U.S. Patent and Trademark Office is to process and/or examine your submission related to a patent application or patent. If you do not furnish the requested information, the U.S. Patent and Trademark Office may not be able to process and/or examine your submission, which may result in termination of proceedings or abandonment of the application or expiration of the patent.

The information provided by you in this form will be subject to the following routine uses:

1. The information on this form will be treated confidentially to the extent allowed under the Freedom of Information Act (5 U.S.C. 552) and the Privacy Act (5 U.S.C. 552a). Records from this system of records may be disclosed to the Department of Justice to determine whether the Freedom of Information Act requires disclosure of these records.
2. A record from this system of records may be disclosed, as a routine use, in the course of presenting evidence to a court, magistrate, or administrative tribunal, including disclosures to opposing counsel in the course of settlement negotiations.
3. A record in this system of records may be disclosed, as a routine use, to a Member of Congress submitting a request involving an individual, to whom the record pertains, when the individual has requested assistance from the Member with respect to the subject matter of the record.
4. A record in this system of records may be disclosed, as a routine use, to a contractor of the Agency having need for the information in order to perform a contract. Recipients of information shall be required to comply with the requirements of the Privacy Act of 1974, as amended, pursuant to 5 U.S.C. 552a(m).
5. A record related to an International Application filed under the Patent Cooperation Treaty in this system of records may be disclosed, as a routine use, to the International Bureau of the World Intellectual Property Organization, pursuant to the Patent Cooperation Treaty.
6. A record in this system of records may be disclosed, as a routine use, to another federal agency for purposes of National Security review (35 U.S.C. 181) and for review pursuant to the Atomic Energy Act (42 U.S.C. 218(c)).
7. A record from this system of records may be disclosed, as a routine use, to the Administrator, General Services, or his/her designee, during an inspection of records conducted by GSA as part of that agency's responsibility to recommend improvements in records management practices and programs, under authority of 44 U.S.C. 2904 and 2906. Such disclosure shall be made in accordance with the GSA regulations governing inspection of records for this purpose, and any other relevant (i.e., GSA or Commerce) directive. Such disclosure shall not be used to make determinations about individuals.
8. A record from this system of records may be disclosed, as a routine use, to the public after either publication of the application pursuant to 35 U.S.C. 122(b) or issuance of a patent pursuant to 35 U.S.C. 151. Further, a record may be disclosed, subject to the limitations of 37 CFR 1.14, as a routine use, to the public if the record was filed in an application which became abandoned or in which the proceedings were terminated and which application is referenced by either a published application, an application open to public inspections or an issued patent.
9. A record from this system of records may be disclosed, as a routine use, to a Federal, State, or local law enforcement agency, if the USPTO becomes aware of a violation or potential violation of law or regulation.



## Electronic Patent Application Fee Transmittal

<b>Application Number:</b>	12211033			
<b>Filing Date:</b>	15-Sep-2008			
<b>Title of Invention:</b>	METHOD AND APPARATUS FOR MONITORING EXERCISE WITH WIRELESS INTERNET CONNECTIVITY			
<b>First Named Inventor/Applicant Name:</b>	Roger J. Quy			
<b>Filer:</b>	Karin L. Williams/Michelle Wolf			
<b>Attorney Docket Number:</b>	00125/002005			
Filed as Small Entity				
<b>Utility under 35 USC 111(a) Filing Fees</b>				
<b>Description</b>	<b>Fee Code</b>	<b>Quantity</b>	<b>Amount</b>	<b>Sub-Total in USD(\$)</b>
<b>Basic Filing:</b>				
<b>Pages:</b>				
<b>Claims:</b>				
<b>Miscellaneous-Filing:</b>				
<b>Petition:</b>				
<b>Patent-Appeals-and-Interference:</b>				
<b>Post-Allowance-and-Post-Issuance:</b>				
<b>Extension-of-Time:</b>				

Description	Fee Code	Quantity	Amount	Sub-Total in USD(\$)
<b>Miscellaneous:</b>				
Request for continued examination	2801	1	465	465
<b>Total in USD (\$)</b>				<b>465</b>

**Electronic Acknowledgement Receipt**

<b>EFS ID:</b>	12812070
<b>Application Number:</b>	12211033
<b>International Application Number:</b>	
<b>Confirmation Number:</b>	7693
<b>Title of Invention:</b>	METHOD AND APPARATUS FOR MONITORING EXERCISE WITH WIRELESS INTERNET CONNECTIVITY
<b>First Named Inventor/Applicant Name:</b>	Roger J. Quy
<b>Customer Number:</b>	27774
<b>Filer:</b>	Karin L. Williams/Michelle Wolf
<b>Filer Authorized By:</b>	Karin L. Williams
<b>Attorney Docket Number:</b>	00125/002005
<b>Receipt Date:</b>	18-MAY-2012
<b>Filing Date:</b>	15-SEP-2008
<b>Time Stamp:</b>	12:18:54
<b>Application Type:</b>	Utility under 35 USC 111(a)

**Payment information:**

Submitted with Payment	yes
Payment Type	Deposit Account
Payment was successfully received in RAM	\$465
RAM confirmation Number	9358
Deposit Account	501047
Authorized User	

The Director of the USPTO is hereby authorized to charge indicated fees and credit any overpayment as follows:

Charge any Additional Fees required under 37 C.F.R. Section 1.16 (National application filing, search, and examination fees)

Charge any Additional Fees required under 37 C.F.R. Section 1.17 (Patent application and reexamination processing fees)

Charge any Additional Fees required under 37 C.F.R. Section 1.19 (Document supply fees)

Charge any Additional Fees required under 37 C.F.R. Section 1.20 (Post Issuance fees)

Charge any Additional Fees required under 37 C.F.R. Section 1.21 (Miscellaneous fees and charges)

**File Listing:**

Document Number	Document Description	File Name	File Size(Bytes)/ Message Digest	Multi Part /.zip	Pages (if appl.)
1		00125-002005-amendment-05-18-2012.pdf	137976 <small>4e5cd24accee45f7f675a5a00a147c5accebb8393</small>	yes	6
<b>Multipart Description/PDF files in .zip description</b>					
	<b>Document Description</b>		<b>Start</b>		<b>End</b>
	Amendment Submitted/Entered with Filing of CPA/RCE		1		1
	Claims		2		5
	Applicant Arguments/Remarks Made in an Amendment		6		6
<b>Warnings:</b>					
<b>Information:</b>					
2	Request for Continued Examination (RCE)	s00125-002005-RCE.pdf	697821 <small>cc2f6c95dba54f6ad14be85e81d1c3c8a1814384</small>	no	3
<b>Warnings:</b>					
<b>Information:</b>					
3	Fee Worksheet (SB06)	fee-info.pdf	30775 <small>2c71deebaa8fee81287f7ceb4d99cccd26d06ad</small>	no	2
<b>Warnings:</b>					
<b>Information:</b>					
<b>Total Files Size (in bytes):</b>			866572		

This Acknowledgement Receipt evidences receipt on the noted date by the USPTO of the indicated documents, characterized by the applicant, and including page counts, where applicable. It serves as evidence of receipt similar to a Post Card, as described in MPEP 503.

**New Applications Under 35 U.S.C. 111**

If a new application is being filed and the application includes the necessary components for a filing date (see 37 CFR 1.53(b)-(d) and MPEP 506), a Filing Receipt (37 CFR 1.54) will be issued in due course and the date shown on this Acknowledgement Receipt will establish the filing date of the application.

**National Stage of an International Application under 35 U.S.C. 371**

If a timely submission to enter the national stage of an international application is compliant with the conditions of 35 U.S.C. 371 and other applicable requirements a Form PCT/DO/EO/903 indicating acceptance of the application as a national stage submission under 35 U.S.C. 371 will be issued in addition to the Filing Receipt, in due course.

**New International Application Filed with the USPTO as a Receiving Office**

If a new international application is being filed and the international application includes the necessary components for an international filing date (see PCT Article 11 and MPEP 1810), a Notification of the International Application Number and of the International Filing Date (Form PCT/RO/105) will be issued in due course, subject to prescriptions concerning national security, and the date shown on this Acknowledgement Receipt will establish the international filing date of the application.

Application No.: 12/211,033

Docket No.: 00125/002005 (2051/14C4)

**IN THE UNITED STATES PATENT AND TRADEMARK OFFICE**

In re Patent Application of:  
Roger J. Quy

Application No.: 12/211,033

Filed: September 15, 2008

For: METHOD AND APPARATUS FOR  
MONITORING EXERCISE WITH WIRELESS  
INTERNET CONNECTIVITY

Examiner: Shirley Xueying Jian

Confirmation No.: 7693

Art Unit: 3769

Via EFS Web  
Commissioner for Patents  
P.O. Box 1450  
Alexandria, VA 22313-1450

Certificate of Electronic Transmission  
Under 37 C.F.R. §1.8  
I hereby certify that this correspondence and any document referenced herein are being electronically filed with the USPTO via EFS-Web on May 18, 2012.  
Michelle Wolf  
(Printed Name of Person Sending Correspondence)  
/Michelle Wolf/  
(Signature)

Dear Sir/Madam:

**AMENDMENT AND RESPONSE**

This filing accompanies a Request For Continued Examination filed herewith.

Any fees deemed to be due or credit for any overpayment for this application should be directed to Deposit Account Number 50-1047 and authorization is hereby given to charge such account.

Please enter the following amendments and remarks.

**Amendments to the Claims** are reflected in the listing of claims which begins on page 2.

**Remarks/Arguments** begin on page 6.

Application No.: 12/211,033

Docket No.: 00125/002005 (2051/14C4)

In the claims:

1. (Currently Amended) A method for interactive exercise monitoring, the method comprising the steps of:
  - a. downloading an application to a web-enabled wireless phone directly from a remote server over the internet;
  - b. coupling ~~the~~ a web-enabled wireless phone to a device which provides exercise-related information;
  - c. rendering a user interface on the web-enabled wireless phone;
  - d. using the application, receiving data indicating a physiologic status of a subject;
  - e. using the application, receiving data indicating an amount of exercise performed by the subject;
  - f. wherein at least one of the data indicating a physiologic status of a subject or the data indicating an amount of exercise performed by the subject is received from the device which provides exercise-related information, and wherein the data indicating a physiologic status of a subject is received at least partially while the subject is exercising;
  - g. sending the exercise-related information to an internet server via a wireless network;
  - h. receiving a calculated response from the server, the response associated with a calculation performed by the server based on the exercise-related information; and
  - i. using the application, ~~running an application in the web-enabled wireless phone for receiving the exercise-related information and~~ displaying the response.
2. (Previously Presented) The method of claim 1, wherein the receiving data indicating a physiologic status of a subject includes receiving data from a physiological sensor coupled to an exercise machine.
3. (Previously Presented) The method of claim 1, where the receiving data indicating an amount of exercise performed by the subject includes receiving data from an exercise machine.

Application No.: 12/211,033

Docket No.: 00125/002005 (2051/14C4)

4. (Previously Presented) The method of claim 1, wherein the web-enabled wireless phone receives exercise-related information over a transmission medium, the transmission medium including a wired connection or a wireless connection.

5. (Cancelled)

6. (Original) The method of claim 1, wherein the web-enabled wireless phone receives data via an adapter to convert a signal from the device to a suitable input for the wireless phone.

7. (Previously Presented) The method of claim 1, wherein the data indicating an amount of exercise performed is received from a device selected from the group consisting of: a treadmill, a stepper, an exercise cycle, an accelerometer, a rowing machine, physiotherapy equipment, an aerobic or anaerobic exercise device, and a device that monitors an amount of work or rate of work performed.

8. (Currently Amended) A non-transitory computer-readable medium, containing an application for performing an interactive method of exercise monitoring, the application physically residing on a server, the method comprising the steps of:

- a. downloading an application to a web-enabled wireless phone directly from a remote server over the internet;
- b. receiving exercise-related information from a web-enabled wireless phone, wherein the exercise-related information includes data collected at least in part using the application and indicating a physiologic status of a subject and data indicating an amount of exercise performed by the subject, and wherein the data indicating a physiologic status of a subject is received at least partially while the subject is exercising;
- c. calculating a response based on the exercise-related information;
- d. transmitting the calculated response to the web-enabled wireless phone for subsequent display, the display using the application.



Application No.: 12/211,033

Docket No.: 00125/002005 (2051/14C4)

9. (Currently Amended) The medium of claim 8, wherein the method further comprises:  
a. enabling the web-enabled wireless phone to receive exercise-related information from a device;  
and  
b. transmitting to the web-enabled wireless phone the ~~a~~ device application including a user interface on which the calculated response may be rendered.

10. (Previously Presented) The medium of claim 8, wherein the calculating a response includes calculating a response to assist a person in monitoring calorie expenditure, losing weight, or maintaining a healthy lifestyle.

11. (Previously Presented) The medium of claim 8, wherein the instructions further cause the web-enabled wireless phone to receive the exercise-related information via an adapter, the adapter to convert a received data signal to a suitable input for the web-enabled wireless phone.

12. (Previously Presented) The medium of claim 8, wherein the data indicating an amount of exercise performed by the subject is received from a device which is selected from the group consisting of: a pedometer, a treadmill, a stepper, an exercise cycle, an accelerometer, a rowing machine, physiotherapy equipment, an aerobic or anaerobic exercise device, and a device that monitors an amount of work or rate of work performed.

13. (Previously Presented) The medium of claim 8, wherein the receiving exercise-related information includes receiving exercise-related information over a wireless or a wired connection.

14. (Currently Amended) A web-enabled wireless phone, containing a non-transitory computer-readable medium, the computer-readable medium comprising memory within a web-enabled wireless phone, the computer-readable medium comprising instructions for causing a processor in the web-enabled wireless phone to perform the method of claim 1.

Application No.: 12/211,033

Docket No.: 00125/002005 (2051/14C4)

15. (Currently Amended) A non-transitory computer-readable medium, the computer-readable medium comprising memory within a web-enabled wireless phone, the computer-readable medium containing instructions for causing a processor in a web-enabled wireless phone to perform the method of claim 1.

16. (Cancelled)

17. (Previously Presented) The method of claim 4, wherein the wireless connection includes an infrared connection or a radio frequency communication protocol including a short-range wireless transmission scheme.

18. (Previously Presented) The method of claim 4, wherein the wired connection includes a USB connection, a cable, or a docking station.

19. (Previously Presented) The method of claim 17, wherein the short-range wireless transmission scheme includes 802.11 or Bluetooth®.

20. (Previously Presented) The method of claim 1, wherein the data indicating a physiologic status of a subject is received from a device selected from the group consisting of: a heart rate monitor, a blood pressure monitor, a body temperature monitor, a respiratory monitor, a biofeedback device, an electronic body weight scale, and a body fat gauge.

21. (Previously Presented) The medium of claim 8, wherein the data indicating a physiologic status of a subject is received from a device which is selected from the group consisting of: a heart rate monitor, a blood pressure monitor, a body temperature monitor, a respiratory monitor, a biofeedback device, an electronic body weight scale, and a body fat gauge.

Application No.: 12/211,033

Docket No.: 00125/002005 (2051/14C4)

**REMARKS**

Claims 1-4 and 6-21 were pending in the application. Claim 16 has been canceled here. Claims 1, 8, 9, 14, and 15 have been amended here. Reconsideration and allowance of all pending claims is requested.

Applicant thanks Examiner Shirley Jian and Supervisory Patent Examiner Sam Yao for the personal interview and the many discussions regarding the case. In accordance with these discussions and as described in the Interview Summary filed on April 9, 2012, the attached amended claims are respectfully submitted to define over the applied references and thus should be in allowable condition.

If the Examiner has any questions, or would like to discuss the case in greater detail, she is invited to contact the undersigned attorney at the number given below.

**FEES**

The Commissioner is authorized to charge any fees that may be due and owing as a result of this Amendment to the undersigned attorney's PTO Deposit Account Number 50-1047.

Dated: May 17, 2012

Respectfully submitted,

/Mark Wieczorek/\_\_\_\_\_

Mark D. Wieczorek

Registration No. 37,966

Mayer & Williams PC  
251 North Avenue West, 2<sup>nd</sup> Floor  
Westfield, NJ 07090  
(619) 846-4615 Tel.  
(908) 518-7795 Fax

PTO/SB/06 (07-06)  
 Approved for use through 1/31/2007. OMB 0651-0032  
 U.S. Patent and Trademark Office; U.S. DEPARTMENT OF COMMERCE

Under the Paperwork Reduction Act of 1995, no persons are required to respond to a collection of information unless it displays a valid OMB control number.

<b>PATENT APPLICATION FEE DETERMINATION RECORD</b> Substitute for Form PTO-875					Application or Docket Number <b>12/211,033</b>		Filing Date <b>09/15/2008</b>		<input type="checkbox"/> To be Mailed				
<b>APPLICATION AS FILED – PART I</b>							OTHER THAN						
(Column 1)		(Column 2)			SMALL ENTITY <input checked="" type="checkbox"/>		OR		SMALL ENTITY				
FOR	NUMBER FILED	NUMBER EXTRA			RATE (\$)	FEE (\$)			RATE (\$)	FEE (\$)			
<input type="checkbox"/> BASIC FEE <small>(37 CFR 1.16(a), (b), or (c))</small>	N/A	N/A			N/A				N/A				
<input type="checkbox"/> SEARCH FEE <small>(37 CFR 1.16(k), (l), or (m))</small>	N/A	N/A			N/A				N/A				
<input type="checkbox"/> EXAMINATION FEE <small>(37 CFR 1.16(o), (p), or (q))</small>	N/A	N/A			N/A				N/A				
TOTAL CLAIMS <small>(37 CFR 1.16(i))</small>	minus 20 =	*			X \$ =		OR		X \$ =				
INDEPENDENT CLAIMS <small>(37 CFR 1.16(h))</small>	minus 3 =	*			X \$ =				X \$ =				
<input type="checkbox"/> APPLICATION SIZE FEE <small>(37 CFR 1.16(s))</small>	If the specification and drawings exceed 100 sheets of paper, the application size fee due is \$250 (\$125 for small entity) for each additional 50 sheets or fraction thereof. See 35 U.S.C. 41(a)(1)(G) and 37 CFR 1.16(s).												
<input type="checkbox"/> MULTIPLE DEPENDENT CLAIM PRESENT <small>(37 CFR 1.16(j))</small>													
* If the difference in column 1 is less than zero, enter "0" in column 2.													
<b>APPLICATION AS AMENDED – PART II</b>							OTHER THAN						
(Column 1)		(Column 2)		(Column 3)			SMALL ENTITY		OR		SMALL ENTITY		
AMENDMENT	<b>05/18/2012</b>	CLAIMS REMAINING AFTER AMENDMENT		HIGHEST NUMBER PREVIOUSLY PAID FOR		PRESENT EXTRA		RATE (\$)	ADDITIONAL FEE (\$)			RATE (\$)	ADDITIONAL FEE (\$)
	Total <small>(37 CFR 1.16(i))</small>	* 19	Minus	** 20		= 0		X \$30 =	0	OR		X \$ =	
	Independent <small>(37 CFR 1.16(h))</small>	* 2	Minus	*** 4		= 0		X \$125 =	0	OR		X \$ =	
	<input type="checkbox"/> Application Size Fee <small>(37 CFR 1.16(s))</small>												
	<input type="checkbox"/> FIRST PRESENTATION OF MULTIPLE DEPENDENT CLAIM <small>(37 CFR 1.16(j))</small>												
								TOTAL ADD'L FEE	<b>0</b>	OR		TOTAL ADD'L FEE	
(Column 1)		(Column 2)		(Column 3)			SMALL ENTITY		OR		SMALL ENTITY		
AMENDMENT	CLAIMS REMAINING AFTER AMENDMENT		HIGHEST NUMBER PREVIOUSLY PAID FOR		PRESENT EXTRA		RATE (\$)	ADDITIONAL FEE (\$)			RATE (\$)	ADDITIONAL FEE (\$)	
	Total <small>(37 CFR 1.16(i))</small>		*	Minus	**		=		X \$ =		OR		X \$ =
	Independent <small>(37 CFR 1.16(h))</small>		*	Minus	***		=		X \$ =		OR		X \$ =
	<input type="checkbox"/> Application Size Fee <small>(37 CFR 1.16(s))</small>												
	<input type="checkbox"/> FIRST PRESENTATION OF MULTIPLE DEPENDENT CLAIM <small>(37 CFR 1.16(j))</small>												
								TOTAL ADD'L FEE		OR		TOTAL ADD'L FEE	
* If the entry in column 1 is less than the entry in column 2, write "0" in column 3.													
** If the "Highest Number Previously Paid For" IN THIS SPACE is less than 20, enter "20".													
*** If the "Highest Number Previously Paid For" IN THIS SPACE is less than 3, enter "3".													
The "Highest Number Previously Paid For" (Total or Independent) is the highest number found in the appropriate box in column 1.													

Legal Instrument Examiner:  
/THUY TA/

This collection of information is required by 37 CFR 1.16. The information is required to obtain or retain a benefit by the public which is to file (and by the USPTO to process) an application. Confidentiality is governed by 35 U.S.C. 122 and 37 CFR 1.14. This collection is estimated to take 12 minutes to complete, including gathering, preparing, and submitting the completed application form to the USPTO. Time will vary depending upon the individual case. Any comments on the amount of time you require to complete this form and/or suggestions for reducing this burden, should be sent to the Chief Information Officer, U.S. Patent and Trademark Office, U.S. Department of Commerce, P.O. Box 1450, Alexandria, VA 22313-1450. DO NOT SEND FEES OR COMPLETED FORMS TO THIS ADDRESS. **SEND TO: Commissioner for Patents, P.O. Box 1450, Alexandria, VA 22313-1450.**  
 If you need assistance in completing the form, call 1-800-PTO-9199 and select option 2.



UNITED STATES PATENT AND TRADEMARK OFFICE

UNITED STATES DEPARTMENT OF COMMERCE  
 United States Patent and Trademark Office  
 Address: COMMISSIONER FOR PATENTS  
 P. O. Box 1450  
 Alexandria, Virginia 22313-1450  
 www.uspto.gov

**NOTICE OF ALLOWANCE AND FEE(S) DUE**

27774 7590 06/11/2012  
 MAYER & WILLIAMS PC  
 251 NORTH AVENUE WEST  
 Suite 201  
 WESTFIELD, NJ 07090

EXAMINER	
JIAN, SHIRLEY XUEYING	
ART UNIT	PAPER NUMBER
3769	
DATE MAILED: 06/11/2012	

APPLICATION NO.	FILING DATE	FIRST NAMED INVENTOR	ATTORNEY DOCKET NO.	CONFIRMATION NO.
12/211,033	09/15/2008	Roger J. Quy	00125/002005	7693

TITLE OF INVENTION: METHOD AND APPARATUS FOR MONITORING EXERCISE WITH WIRELESS INTERNET CONNECTIVITY

APPLN. TYPE	SMALL ENTITY	ISSUE FEE DUE	PUBLICATION FEE DUE	PREV. PAID ISSUE FEE	TOTAL FEE(S) DUE	DATE DUE
nonprovisional	YES	\$870	\$300	\$0	\$1170	09/11/2012

**THE APPLICATION IDENTIFIED ABOVE HAS BEEN EXAMINED AND IS ALLOWED FOR ISSUANCE AS A PATENT. PROSECUTION ON THE MERITS IS CLOSED. THIS NOTICE OF ALLOWANCE IS NOT A GRANT OF PATENT RIGHTS. THIS APPLICATION IS SUBJECT TO WITHDRAWAL FROM ISSUE AT THE INITIATIVE OF THE OFFICE OR UPON PETITION BY THE APPLICANT. SEE 37 CFR 1.313 AND MPEP 1308.**

**THE ISSUE FEE AND PUBLICATION FEE (IF REQUIRED) MUST BE PAID WITHIN THREE MONTHS FROM THE MAILING DATE OF THIS NOTICE OR THIS APPLICATION SHALL BE REGARDED AS ABANDONED. THIS STATUTORY PERIOD CANNOT BE EXTENDED. SEE 35 U.S.C. 151. THE ISSUE FEE DUE INDICATED ABOVE DOES NOT REFLECT A CREDIT FOR ANY PREVIOUSLY PAID ISSUE FEE IN THIS APPLICATION. IF AN ISSUE FEE HAS PREVIOUSLY BEEN PAID IN THIS APPLICATION (AS SHOWN ABOVE), THE RETURN OF PART B OF THIS FORM WILL BE CONSIDERED A REQUEST TO REAPPLY THE PREVIOUSLY PAID ISSUE FEE TOWARD THE ISSUE FEE NOW DUE.**

**HOW TO REPLY TO THIS NOTICE:**

I. Review the SMALL ENTITY status shown above.

If the SMALL ENTITY is shown as YES, verify your current SMALL ENTITY status:

- A. If the status is the same, pay the TOTAL FEE(S) DUE shown above.
- B. If the status above is to be removed, check box 5b on Part B - Fee(s) Transmittal and pay the PUBLICATION FEE (if required) and twice the amount of the ISSUE FEE shown above, or

If the SMALL ENTITY is shown as NO:

- A. Pay TOTAL FEE(S) DUE shown above, or
- B. If applicant claimed SMALL ENTITY status before, or is now claiming SMALL ENTITY status, check box 5a on Part B - Fee(s) Transmittal and pay the PUBLICATION FEE (if required) and 1/2 the ISSUE FEE shown above.

II. PART B - FEE(S) TRANSMITTAL, or its equivalent, must be completed and returned to the United States Patent and Trademark Office (USPTO) with your ISSUE FEE and PUBLICATION FEE (if required). If you are charging the fee(s) to your deposit account, section "4b" of Part B - Fee(s) Transmittal should be completed and an extra copy of the form should be submitted. If an equivalent of Part B is filed, a request to reapply a previously paid issue fee must be clearly made, and delays in processing may occur due to the difficulty in recognizing the paper as an equivalent of Part B.

III. All communications regarding this application must give the application number. Please direct all communications prior to issuance to Mail Stop ISSUE FEE unless advised to the contrary.

**IMPORTANT REMINDER: Utility patents issuing on applications filed on or after Dec. 12, 1980 may require payment of maintenance fees. It is patentee's responsibility to ensure timely payment of maintenance fees when due.**

PART B - FEE(S) TRANSMITTAL

Complete and send this form, together with applicable fee(s), to: **Mail** **Mail Stop ISSUE FEE**  
**Commissioner for Patents**  
**P.O. Box 1450**  
**Alexandria, Virginia 22313-1450**  
**or Fax (571)-273-2885**

INSTRUCTIONS: This form should be used for transmitting the ISSUE FEE and PUBLICATION FEE (if required). Blocks 1 through 5 should be completed where appropriate. All further correspondence including the Patent, advance orders and notification of maintenance fees will be mailed to the current correspondence address as indicated unless corrected below or directed otherwise in Block 1, by (a) specifying a new correspondence address; and/or (b) indicating a separate "FEE ADDRESS" for maintenance fee notifications.

CURRENT CORRESPONDENCE ADDRESS (Note: Use Block 1 for any change of address)

Note: A certificate of mailing can only be used for domestic mailings of the Fee(s) Transmittal. This certificate cannot be used for any other accompanying papers. Each additional paper, such as an assignment or formal drawing, must have its own certificate of mailing or transmission.

27774 7590 06/11/2012  
**MAYER & WILLIAMS PC**  
**251 NORTH AVENUE WEST**  
**Suite 201**  
**WESTFIELD, NJ 07090**

**Certificate of Mailing or Transmission**

I hereby certify that this Fee(s) Transmittal is being deposited with the United States Postal Service with sufficient postage for first class mail in an envelope addressed to the Mail Stop ISSUE FEE address above, or being facsimile transmitted to the USPTO (571) 273-2885, on the date indicated below.

(Depositor's name)
(Signature)
(Date)

APPLICATION NO.	FILING DATE	FIRST NAMED INVENTOR	ATTORNEY DOCKET NO.	CONFIRMATION NO.
12/211,033	09/15/2008	Roger J. Quy	00125/002005	7693

TITLE OF INVENTION: METHOD AND APPARATUS FOR MONITORING EXERCISE WITH WIRELESS INTERNET CONNECTIVITY

APPLN. TYPE	SMALL ENTITY	ISSUE FEE DUE	PUBLICATION FEE DUE	PREV. PAID ISSUE FEE	TOTAL FEE(S) DUE	DATE DUE
nonprovisional	YES	\$870	\$300	\$0	\$1170	09/11/2012

EXAMINER	ART UNIT	CLASS-SUBCLASS
JIAN, SHIRLEY XUEYING	3769	600-300000

1. Change of correspondence address or indication of "Fee Address" (37 CFR 1.363).

- Change of correspondence address (or Change of Correspondence Address form PTO/SB/122) attached.
- "Fee Address" indication (or "Fee Address" Indication form PTO/SB/47; Rev 03-02 or more recent) attached. **Use of a Customer Number is required.**

2. For printing on the patent front page, list

- (1) the names of up to 3 registered patent attorneys or agents OR, alternatively, 1 \_\_\_\_\_
- (2) the name of a single firm (having as a member a registered attorney or agent) and the names of up to 2 registered patent attorneys or agents. If no name is listed, no name will be printed. 2 \_\_\_\_\_
- 3 \_\_\_\_\_

3. ASSIGNEE NAME AND RESIDENCE DATA TO BE PRINTED ON THE PATENT (print or type)

PLEASE NOTE: Unless an assignee is identified below, no assignee data will appear on the patent. If an assignee is identified below, the document has been filed for recordation as set forth in 37 CFR 3.11. Completion of this form is NOT a substitute for filing an assignment.

(A) NAME OF ASSIGNEE \_\_\_\_\_ (B) RESIDENCE: (CITY and STATE OR COUNTRY) \_\_\_\_\_

Please check the appropriate assignee category or categories (will not be printed on the patent) :  Individual  Corporation or other private group entity  Government

4a. The following fee(s) are submitted:

- Issue Fee
- Publication Fee (No small entity discount permitted)
- Advance Order - # of Copies \_\_\_\_\_

4b. Payment of Fee(s): (Please first reapply any previously paid issue fee shown above)

- A check is enclosed.
- Payment by credit card. Form PTO-2038 is attached.
- The Director is hereby authorized to charge the required fee(s), any deficiency, or credit any overpayment, to Deposit Account Number \_\_\_\_\_ (enclose an extra copy of this form).

5. Change in Entity Status (from status indicated above)

- a. Applicant claims SMALL ENTITY status. See 37 CFR 1.27.
- b. Applicant is no longer claiming SMALL ENTITY status. See 37 CFR 1.27(g)(2).

NOTE: The Issue Fee and Publication Fee (if required) will not be accepted from anyone other than the applicant; a registered attorney or agent; or the assignee or other party in interest as shown by the records of the United States Patent and Trademark Office.

Authorized Signature \_\_\_\_\_ Date \_\_\_\_\_  
 Typed or printed name \_\_\_\_\_ Registration No. \_\_\_\_\_

This collection of information is required by 37 CFR 1.311. The information is required to obtain or retain a benefit by the public which is to file (and by the USPTO to process) an application. Confidentiality is governed by 35 U.S.C. 122 and 37 CFR 1.14. This collection is estimated to take 12 minutes to complete, including gathering, preparing, and submitting the completed application form to the USPTO. Time will vary depending upon the individual case. Any comments on the amount of time you require to complete this form and/or suggestions for reducing this burden, should be sent to the Chief Information Officer, U.S. Patent and Trademark Office, U.S. Department of Commerce, P.O. Box 1450, Alexandria, Virginia 22313-1450. DO NOT SEND FEES OR COMPLETED FORMS TO THIS ADDRESS. SEND TO: Commissioner for Patents, P.O. Box 1450, Alexandria, Virginia 22313-1450.

Under the Paperwork Reduction Act of 1995, no persons are required to respond to a collection of information unless it displays a valid OMB control number.



UNITED STATES PATENT AND TRADEMARK OFFICE

UNITED STATES DEPARTMENT OF COMMERCE  
 United States Patent and Trademark Office  
 Address: COMMISSIONER FOR PATENTS  
 P.O. Box 1450  
 Alexandria, Virginia 22313-1450  
 www.uspto.gov

APPLICATION NO.	FILING DATE	FIRST NAMED INVENTOR	ATTORNEY DOCKET NO.	CONFIRMATION NO.
12/211,033	09/15/2008	Roger J. Quy	00125/002005	7693

2774 7590 06/11/2012  
 MAYER & WILLIAMS PC  
 251 NORTH AVENUE WEST  
 Suite 201  
 WESTFIELD, NJ 07090

EXAMINER	
JIAN, SHIRLEY XUEYING	
ART UNIT	PAPER NUMBER
3769	

DATE MAILED: 06/11/2012

**Determination of Patent Term Adjustment under 35 U.S.C. 154 (b)**  
 (application filed on or after May 29, 2000)

The Patent Term Adjustment to date is 32 day(s). If the issue fee is paid on the date that is three months after the mailing date of this notice and the patent issues on the Tuesday before the date that is 28 weeks (six and a half months) after the mailing date of this notice, the Patent Term Adjustment will be 32 day(s).

If a Continued Prosecution Application (CPA) was filed in the above-identified application, the filing date that determines Patent Term Adjustment is the filing date of the most recent CPA.

Applicant will be able to obtain more detailed information by accessing the Patent Application Information Retrieval (PAIR) WEB site (<http://pair.uspto.gov>).

Any questions regarding the Patent Term Extension or Adjustment determination should be directed to the Office of Patent Legal Administration at (571)-272-7702. Questions relating to issue and publication fee payments should be directed to the Customer Service Center of the Office of Patent Publication at 1-(888)-786-0101 or (571)-272-4200.

## Privacy Act Statement

**The Privacy Act of 1974 (P.L. 93-579)** requires that you be given certain information in connection with your submission of the attached form related to a patent application or patent. Accordingly, pursuant to the requirements of the Act, please be advised that: (1) the general authority for the collection of this information is 35 U.S.C. 2(b)(2); (2) furnishing of the information solicited is voluntary; and (3) the principal purpose for which the information is used by the U.S. Patent and Trademark Office is to process and/or examine your submission related to a patent application or patent. If you do not furnish the requested information, the U.S. Patent and Trademark Office may not be able to process and/or examine your submission, which may result in termination of proceedings or abandonment of the application or expiration of the patent.

The information provided by you in this form will be subject to the following routine uses:

1. The information on this form will be treated confidentially to the extent allowed under the Freedom of Information Act (5 U.S.C. 552) and the Privacy Act (5 U.S.C. 552a). Records from this system of records may be disclosed to the Department of Justice to determine whether disclosure of these records is required by the Freedom of Information Act.
2. A record from this system of records may be disclosed, as a routine use, in the course of presenting evidence to a court, magistrate, or administrative tribunal, including disclosures to opposing counsel in the course of settlement negotiations.
3. A record in this system of records may be disclosed, as a routine use, to a Member of Congress submitting a request involving an individual, to whom the record pertains, when the individual has requested assistance from the Member with respect to the subject matter of the record.
4. A record in this system of records may be disclosed, as a routine use, to a contractor of the Agency having need for the information in order to perform a contract. Recipients of information shall be required to comply with the requirements of the Privacy Act of 1974, as amended, pursuant to 5 U.S.C. 552a(m).
5. A record related to an International Application filed under the Patent Cooperation Treaty in this system of records may be disclosed, as a routine use, to the International Bureau of the World Intellectual Property Organization, pursuant to the Patent Cooperation Treaty.
6. A record in this system of records may be disclosed, as a routine use, to another federal agency for purposes of National Security review (35 U.S.C. 181) and for review pursuant to the Atomic Energy Act (42 U.S.C. 218(c)).
7. A record from this system of records may be disclosed, as a routine use, to the Administrator, General Services, or his/her designee, during an inspection of records conducted by GSA as part of that agency's responsibility to recommend improvements in records management practices and programs, under authority of 44 U.S.C. 2904 and 2906. Such disclosure shall be made in accordance with the GSA regulations governing inspection of records for this purpose, and any other relevant (i.e., GSA or Commerce) directive. Such disclosure shall not be used to make determinations about individuals.
8. A record from this system of records may be disclosed, as a routine use, to the public after either publication of the application pursuant to 35 U.S.C. 122(b) or issuance of a patent pursuant to 35 U.S.C. 151. Further, a record may be disclosed, subject to the limitations of 37 CFR 1.14, as a routine use, to the public if the record was filed in an application which became abandoned or in which the proceedings were terminated and which application is referenced by either a published application, an application open to public inspection or an issued patent.
9. A record from this system of records may be disclosed, as a routine use, to a Federal, State, or local law enforcement agency, if the USPTO becomes aware of a violation or potential violation of law or regulation.



<b>Notice of Allowability</b>	<b>Application No.</b>	<b>Applicant(s)</b>	
	12/211,033	QUY, ROGER J.	
	<b>Examiner</b>	<b>Art Unit</b>	
	SHIRLEY JIAN	3769	

**-- The MAILING DATE of this communication appears on the cover sheet with the correspondence address--**

All claims being allowable, PROSECUTION ON THE MERITS IS (OR REMAINS) CLOSED in this application. If not included herewith (or previously mailed), a Notice of Allowance (PTOL-85) or other appropriate communication will be mailed in due course. **THIS NOTICE OF ALLOWABILITY IS NOT A GRANT OF PATENT RIGHTS.** This application is subject to withdrawal from issue at the initiative of the Office or upon petition by the applicant. See 37 CFR 1.313 and MPEP 1308.

1.  This communication is responsive to 05/18/2012.
2.  An election was made by the applicant in response to a restriction requirement set forth during the interview on \_\_\_\_; the restriction requirement and election have been incorporated into this action.
3.  The allowed claim(s) is/are 1-4,6-15 and 17-21.
4.  Acknowledgment is made of a claim for foreign priority under 35 U.S.C. § 119(a)-(d) or (f).
  - a)  All    b)  Some\*    c)  None    of the:
    1.  Certified copies of the priority documents have been received.
    2.  Certified copies of the priority documents have been received in Application No. \_\_\_\_ .
    3.  Copies of the certified copies of the priority documents have been received in this national stage application from the International Bureau (PCT Rule 17.2(a)).

\* Certified copies not received: \_\_\_\_.

Applicant has THREE MONTHS FROM THE "MAILING DATE" of this communication to file a reply complying with the requirements noted below. Failure to timely comply will result in ABANDONMENT of this application. **THIS THREE-MONTH PERIOD IS NOT EXTENDABLE.**

5.  A SUBSTITUTE OATH OR DECLARATION must be submitted. Note the attached EXAMINER'S AMENDMENT or NOTICE OF INFORMAL PATENT APPLICATION (PTO-152) which gives reason(s) why the oath or declaration is deficient.
6.  CORRECTED DRAWINGS ( as "replacement sheets") must be submitted.
  - (a)  including changes required by the Notice of Draftsperson's Patent Drawing Review ( PTO-948) attached
    - 1)  hereto or 2)  to Paper No./Mail Date \_\_\_\_.
  - (b)  including changes required by the attached Examiner's Amendment / Comment or in the Office action of Paper No./Mail Date \_\_\_\_.

**Identifying indicia such as the application number (see 37 CFR 1.84(c)) should be written on the drawings in the front (not the back) of each sheet. Replacement sheet(s) should be labeled as such in the header according to 37 CFR 1.121(d).**
7.  DEPOSIT OF and/or INFORMATION about the deposit of BIOLOGICAL MATERIAL must be submitted. Note the attached Examiner's comment regarding REQUIREMENT FOR THE DEPOSIT OF BIOLOGICAL MATERIAL.

**Attachment(s)**

- |  |  |
|--|--|
| <ol style="list-style-type: none"> <li>1. <input type="checkbox"/> Notice of References Cited (PTO-892)</li> <li>2. <input type="checkbox"/> Notice of Draftsperson's Patent Drawing Review (PTO-948)</li> <li>3. <input type="checkbox"/> Information Disclosure Statements (PTO/SB/08), Paper No./Mail Date ____</li> <li>4. <input type="checkbox"/> Examiner's Comment Regarding Requirement for Deposit of Biological Material</li> </ol> | <ol style="list-style-type: none"> <li>5. <input type="checkbox"/> Notice of Informal Patent Application</li> <li>6. <input type="checkbox"/> Interview Summary (PTO-413), Paper No./Mail Date ____ .</li> <li>7. <input checked="" type="checkbox"/> Examiner's Amendment/Comment</li> <li>8. <input checked="" type="checkbox"/> Examiner's Statement of Reasons for Allowance</li> <li>9. <input type="checkbox"/> Other ____.</li> </ol> |
|--|--|

/SHIRLEY JIAN/  
Examiner, Art Unit 3769

/SAM YAO/  
Supervisory Patent Examiner, Art Unit 3769

Application/Control Number: 12/211,033  
Art Unit: 3769

Page 2

## **DETAILED ACTION**

### **Examiner's Amendment**

An examiner's amendment to the record appears below. Should the changes and/or additions be unacceptable to applicant, an amendment may be filed as provided by 37 CFR 1.312. To ensure consideration of such an amendment, it **MUST** be submitted no later than the payment of the issue fee.

Authorization for this examiner's amendment was given in a communication with Mark Wieczorek (Registration number: 37966) on May 31, 2012.

### ***Changes to the Claims***

Claims are amended as follows:

1. (Previously Presented) A method for interactive exercise monitoring, the method comprising the steps of:
  - a. downloading an application to a web-enabled wireless phone directly from a remote server over the internet;
  - b. coupling the a web-enabled wireless phone to a device which provides exercise-related information;
  - c. rendering a user interface on the web-enabled wireless phone;
  - d. using the application, receiving data indicating a physiologic status of a subject;
  - e. using the application, receiving data indicating an amount of exercise performed by the subject;

Application/Control Number: 12/211,033

Page 3

Art Unit: 3769

- f. wherein at least one of the data indicating a physiologic status of a subject or the data indicating an amount of exercise performed by the subject is received from the device which provides exercise-related information, and wherein the data indicating a physiologic status of a subject is received at least partially while the subject is exercising;
- g. sending the exercise-related information to an internet server via a wireless network;
- h. receiving a calculated response from the server, the response associated with a calculation performed by the server based on the exercise-related information; and
- i. using the application, displaying the response.

2. (Previously Presented) The method of claim 1, wherein the receiving data indicating a physiologic status of a subject includes receiving data from a physiological sensor coupled to an exercise machine.

3. (Previously Presented) The method of claim 1, where the receiving data indicating an amount of exercise performed by the subject includes receiving data from an exercise machine.

4. (Previously Presented) The method of claim 1, wherein the web-enabled wireless phone receives exercise-related information over a transmission medium, the transmission medium including a wired connection or a wireless connection.

5. (Cancelled)

Application/Control Number: 12/211,033

Page 4

Art Unit: 3769

6. (Original) The method of claim 1, wherein the web-enabled wireless phone receives data via an adapter to convert a signal from the device to a suitable input for the wireless phone.

7. (Previously Presented) The method of claim 1, wherein the data indicating an amount of exercise performed is received from a device selected from the group consisting of: a treadmill, a stepper, an exercise cycle, an accelerometer, a rowing machine, physiotherapy equipment, an aerobic or anaerobic exercise device, and a device that monitors an amount of work or rate of work performed.

8. (Currently Amended) A non-transitory computer-readable medium, containing an application for performing an interactive method of exercise monitoring, the application physically residing on a server, the method comprising the steps of:

- a. downloading an application to a web-enabled wireless phone directly from a remote server over the internet;
- b. receiving exercise-related information from a web-enabled wireless phone, wherein the exercise-related information includes data collected ~~at least in part~~ using the application and indicating a physiologic status of a subject and data indicating an amount of exercise performed by the subject, and wherein the data indicating a physiologic status of a subject is received at least partially while the subject is exercising;
- c. calculating a response based on the exercise-related information;
- d. transmitting the calculated response to the web-enabled wireless phone for subsequent display, the display using the application.

Application/Control Number: 12/211,033  
Art Unit: 3769

Page 5

9. (Currently Amended) The non-transitory computer-readable medium of claim 8, wherein the method further comprises:

- a. enabling the web-enabled wireless phone to receive exercise-related information from a device; and
- b. transmitting to the web-enabled wireless phone the device application including a user interface on which the calculated response may be rendered.

10. (Currently Amended) The non-transitory computer-readable medium of claim 8, wherein the calculating a response includes calculating a response to assist a person in monitoring calorie expenditure, losing weight, or maintaining a healthy lifestyle.

11. (Currently Amended) The non-transitory computer-readable medium of claim 8, wherein the instructions further cause the web-enabled wireless phone to receive the exercise-related information via an adapter, the adapter to convert a received data signal to a suitable input for the web-enabled wireless phone.

12. (Currently Amended) The non-transitory computer-readable medium of claim 8, wherein the data indicating an amount of exercise performed by the subject is received from a device which is selected from the group consisting of: a pedometer, a treadmill, a stepper, an exercise cycle, an accelerometer, a rowing machine, physiotherapy equipment, an aerobic or anaerobic exercise

Application/Control Number: 12/211,033

Page 6

Art Unit: 3769

device, and a device that monitors an amount of work or rate of work performed.

13. (Currently Amended) The non-transitory computer-readable medium of claim 8, wherein the receiving exercise-related information includes receiving exercise-related information over a wireless or a wired connection.

14. (Previously Presented) A web-enabled wireless phone, containing a non-transitory computer-readable medium, the computer-readable medium comprising memory within a web-enabled wireless phone, the computer-readable medium comprising instructions for causing a processor in the web-enabled wireless phone to perform the method of claim 1.

15. (Previously Presented) A non-transitory computer-readable medium, the computer-readable medium comprising memory within a web-enabled wireless phone, the computer-readable medium containing instructions for causing a processor in a web-enabled wireless phone to perform the method of claim 1.

16. (Cancelled)

17. (Previously Presented) The method of claim 4, wherein the wireless connection includes an infrared connection or a radio frequency communication protocol including a short-range wireless transmission scheme.

Application/Control Number: 12/211,033

Page 7

Art Unit: 3769

18. (Previously Presented) The method of claim 4, wherein the wired connection includes a USB connection, a cable, or a docking station.

19. (Currently Amended) The method of claim 17, wherein the short-range wireless transmission scheme includes IEEE 802.11 protocol or Bluetooth® short-wavelength radio transmission in the ISM band of 2400-2480 MHz.

20. (Previously Presented) The method of claim 1, wherein the data indicating a physiologic status of a subject is received from a device selected from the group consisting of: a heart rate monitor, a blood pressure monitor, a body temperature monitor, a respiratory monitor, a biofeedback device, an electronic body weight scale, and a body fat gauge.

21. (Currently Amended) The non-transitory computer-readable medium of claim 8, wherein the data indicating a physiologic status of a subject is received from a device which is selected from the group consisting of: a heart rate monitor, a blood pressure monitor, a body temperature monitor, a respiratory monitor, a biofeedback device, an electronic body weight scale, and a body fat gauge.

### *Changes to the Specification*

Please replace paragraph [0022] with the following paragraph:

[0022] As for wireless techniques, infrared (IR), microwaves, radio frequency (RF), e.g., Bluetooth® or IEEE 802.11 protocols, optical techniques including lasers, and other such

Application/Control Number: 12/211,033

Page 8

Art Unit: 3769

techniques may be used. The patient or subject may also input data manually, such as by a stylus, keypad, synchronization from a PC, or by various other techniques discussed below.

Please replace paragraph [0044] with the following paragraph:

[0044] The term "signal communication" is used to mean any type of connection between components where the connection is, e.g., electromagnetic, and where the connection allows information to be passed from one component to another. This term may be used in a similar fashion as "coupled", "connected", "information communication", "data communication", etc. The following are examples of signal communication schemes. As for wired techniques, a standard bus or serial cable may be used if the input/output ports are compatible and an optional adaptor may be employed if they are not. As for wireless techniques, IR, microwaves, RF, e.g., Bluetooth® or IEEE 802.11 protocols, optical techniques including lasers, and other such techniques may be used. The patient or subject may even input data manually, such as by a stylus or keypad or by various other techniques discussed above and below.

Please replace paragraph [0052] with the following paragraph:

[0052] For medical devices and applications, physiologic sensor 24 may include, e.g., a sensor appropriate for measuring blood glucose levels, blood pressure, heart rate, or any other desired parameter as required by the physician. Sensor 24 may connect via an optional cable 44 to subject 38. Alternatively, sensor 24 may be distal of HMD 11, i.e., at or within subject 38. In other words, if cable 44 is employed, sensor 24 may be proximal or distal of cable 44. If a wireless communications capability is added, sensor 24 need not physically connect with HMD



Application/Control Number: 12/211,033

Page 9

Art Unit: 3769

11 or WWD 12 at all. That is, the same may measure a health parameter and may communicate the same to wireless health-monitoring apparatus 10 wirelessly. The short range wireless communications schemes which may be employed include infrared, radio frequency including ~~Bluetooth~~ Bluetooth® or IEEE 802.11 protocols, or other such schemes.

Please replace paragraph [0053] with the following paragraph:

[0053] As examples of sensor types, to measure blood glucose levels, sensor 24 may be a sensor that accepts a drop of blood, e.g., via a finger-prick. To measure heart rate, sensor 24 may be placed via an adhesive sensor disposed on the chest. Other health monitors may also be employed so long as the measured data may either be transferred to WWD 12, e.g., via optional adaptor 42, described in further detail below, or by being read by a user, e.g., from a display, and manually input to WWD 12. Alternatively, the measured data may be transferred to WWD 12 via wireless communication schemes, such as RF includes Bluetooth® or IEEE 802.11 protocols, infrared, optical, microwaves, etc., directly from sensor 24 or from HMD 11 as described in greater detail below.

Please replace paragraph [0092] with the following paragraph:

[0092] While the device shown in FIG. 8 is described in the context of general wireless communications, various protocols may be employed. For radio frequency communications, protocols such as Bluetooth® or IEEE 802.11 protocols may be advantageously employed. Other techniques employing a similar configuration include those employing IR, microwaves, optical techniques including lasers, and so on.

Application/Control Number: 12/211,033  
Art Unit: 3769

Page 10

### *Reasons for Allowance*

The prior art does not disclose or fairly suggest a web-enabled wireless phone for interfacing with a device which receive exercise related information; wherein said web-enabled wireless phone downloads a software application directly from a remote server via the Internet, and uses said application to receive and transmit a user's exercise information for management and analysis by said remote server.

Prior art reference- Mault (US Patent No. 6,790,178 B1) discloses a portable computing device, i.e. a PDA or a cellular phone, which interfaces with a plethora of sensors for obtaining exercise related information, and wherein said portable computing device further uses a software application to receive and transmit a user's exercise information for management and analysis by a remote server. However, Mault fails to teach a direct connection with said remote server for downloading said software application; in fact Mault specifically discloses that downloading and installing of software applications are done via another memory module.

### *Conclusion*

Any inquiry concerning this communication or earlier communications from the examiner should be directed to SHIRLEY JIAN whose telephone number is (571)270-7374. The examiner can normally be reached on Monday-Friday 10am-5:00pm.

If attempts to reach the examiner by telephone are unsuccessful, the examiner's supervisor, Gregory Morse can be reached on 571-272-3838. The fax phone number for the organization where this application or proceeding is assigned is 571-273-8300.

Application/Control Number: 12/211,033  
Art Unit: 3769

Page 11

Information regarding the status of an application may be obtained from the Patent Application Information Retrieval (PAIR) system. Status information for published applications may be obtained from either Private PAIR or Public PAIR. Status information for unpublished applications is available through Private PAIR only. For more information about the PAIR system, see <http://pair-direct.uspto.gov>. Should you have questions on access to the Private PAIR system, contact the Electronic Business Center (EBC) at 866-217-9197 (toll-free). If you would like assistance from a USPTO Customer Service Representative or access to the automated information system, call 800-786-9199 (IN USA OR CANADA) or 571-272-1000.

/SHIRLEY JIAN/  
Examiner, Art Unit 3769

May 31, 2012

/SAM YAO/

Supervisory Patent Examiner, Art Unit 3769

<b>Search Notes</b>  	<b>Application/Control No.</b>  12211033	<b>Applicant(s)/Patent Under Reexamination</b>  QUY, ROGER J.
	<b>Examiner</b>  Shirley Jian	<b>Art Unit</b>  3769

**SEARCHED**

Class	Subclass	Date	Examiner
600	300-301 (text)	5/09	MA
600	300-301 (text)	8/5/2010	SJ
428	8 (text)	8/5/2010	SJ
	class and subclass search updated	3/3/2011	SJ
	class and subclass search updated	8/23/2011	SJ

**SEARCH NOTES**

Search Notes	Date	Examiner
East search (class/subclass, inventor, parent cases backwards search)	5/09	MA
Reviewed applied prior art, spoke with H. Johnson	11/09	MA
East search notes attached (inventor, IDS, class, subclass, text)	8/5/2010	SJ
EDAN related art search	8/5/2010	SJ
East search notes attached (inventor, IDS, class, subclass, text)	3/3/2011	SJ
East search notes attached (inventor, IDS, class, subclass, text)	8/23/2011	SJ
Updated East search notes attached (inventor, text)	5/31/2012	SJ

**INTERFERENCE SEARCH**

Class	Subclass	Date	Examiner
	Interference searched	5/31/2012	SJ

/SHIRLEY JIAN/  
Examiner, Art Unit 3769



UNITED STATES PATENT AND TRADEMARK OFFICE

UNITED STATES DEPARTMENT OF COMMERCE  
 United States Patent and Trademark Office  
 Address: COMMISSIONER FOR PATENTS  
 P.O. Box 1450  
 Alexandria, Virginia 22313-1450  
 www.uspto.gov

BIB DATA SHEET

CONFIRMATION NO. 7693

SERIAL NUMBER	FILING or 371(c) DATE	CLASS	GROUP ART UNIT	ATTORNEY DOCKET NO.
12/211,033	09/15/2008	600	3769	00125/002005
	<b>RULE</b>			

**APPLICANTS**

Roger J. Quy, Mill Valley, CA; /SJ/

**\*\* CONTINUING DATA \*\*\*\*\***

This application is a CON of 11/649,703 01/03/2007 ABN which is a CON of 11/184,274 07/18/2005 PAT 7,156,808 which is a CON of 10/418,845 04/18/2003 PAT 6,936,007 which is a CON of 09/738,270 12/15/2000 PAT 6,602,191 which claims benefit of 60/172,486 12/17/1999

**\*\* FOREIGN APPLICATIONS \*\*\*\*\***

**\*\* IF REQUIRED, FOREIGN FILING LICENSE GRANTED \*\* \*\* SMALL ENTITY \*\***  
 09/24/2008

Foreign Priority claimed <input type="checkbox"/> Yes <input checked="" type="checkbox"/> No	<input type="checkbox"/> Met after Allowance	<b>STATE OR COUNTRY</b>	<b>SHEETS DRAWINGS</b>	<b>TOTAL CLAIMS</b>	<b>INDEPENDENT CLAIMS</b>
35 USC 119(a-d) conditions met <input type="checkbox"/> Yes <input checked="" type="checkbox"/> No		CA	8	<del>12</del> 19	2
Verified and /SHIRLEY XUEYING JIAN/ Examiner's Signature	Initials				

**ADDRESS**

MAYER & WILLIAMS PC  
 251 NORTH AVENUE WEST  
 Suite 201  
 WESTFIELD, NJ 07090  
 UNITED STATES

**TITLE**

METHOD AND APPARATUS FOR MONITORING EXERCISE WITH WIRELESS INTERNET CONNECTIVITY

<b>FILING FEE RECEIVED</b> 637	FEES: Authority has been given in Paper No. _____ to charge/credit DEPOSIT ACCOUNT No. _____ for following:	<input type="checkbox"/> All Fees
		<input type="checkbox"/> 1.16 Fees (Filing)
		<input type="checkbox"/> 1.17 Fees (Processing Ext. of time)
		<input type="checkbox"/> 1.18 Fees (Issue)
		<input type="checkbox"/> Other _____
		<input type="checkbox"/> Credit

## EAST Search History

## EAST Search History (Prior Art)

Ref #	Hits	Search Query	DBs	Default Operator	Plurals	Time Stamp
L1	1	"5790178".pn.	US-PGPUB; USPAT	OR	OFF	2012/05/31 14:08
L2	0	"5790178".pn. and (web internet download)	US-PGPUB; USPAT	OR	OFF	2012/05/31 14:08
L3	0	"5790178".pn. and (web internet download)	US-PGPUB; USPAT	OR	ON	2012/05/31 14:08
L4	94	mault.inv.	US-PGPUB; USPAT	OR	OFF	2012/05/31 14:08
L5	1	"6790178".pn. and (web internet download)	US-PGPUB; USPAT	OR	OFF	2012/05/31 14:09
L6	1	"6790178".pn. and (web internet download)	US-PGPUB; USPAT	OR	ON	2012/05/31 14:09
L10	450	"2630798"   "2826912"   "2831348" "2838399"   "2869357"   "2911825" "2920012"   "3213684"   "3220255" "3250270"   "3306283"   "3523529" "3527205"   "3681197"   "3726270" "3797480"   "3799149"   "3814091" "3834375"   "3895630"   "3938551" "3962917"   "3967690"   "3972038" "3991304"   "4003396"   "4008712" "4051847"   "4078554"   "4100401" "4101071"   "4113039"   "4117834" "4151668"   "4159416"   "4186735" "4188946"   "4192000"   "4197857" "4200094"   "4211239"   "4212079" "4221224"   "4221959"   "4224952" "4230108"   "4244020"   "4318447" "4321674"   "4341867"   "4353375" "4359057"   "4366873"   "4368740" "4380802"   "4386604"   "4387777" "4423792"   "4425805"   "4440177" "4444201"   "4463764"   "4566461" "4571682"   "4572208"   "4575804" "4577710"   "4598700"   "4608995" "4619269"   "4629015"   "4648396" "4650218"   "4658832"   "4686624" "4709331"   "4731726"   "4753245" "4756670"   "4757453"   "4781184" "4793362"   "4796182"   "4796639" "4803625"   "4807169"   "4823808" "4850371"   "4853854"   "4855942" "4855945"   "4856531"   "4880014" "4891756"   "4894793"   "4895163" "4909259"   "4911175"   "4911256" "4914959"   "4917108"   "4924389" "4947862"   "4951197"   "4954954" "4955946"   "4965553"   "4966155" "4986268"   "4998018"   "5007429" "5012411"   "5019974"   "5022406" "5033561"   "5038773"   "5038792"	US-PGPUB; USPAT; USOCR	OR	OFF	2012/05/31 14:47

		"5042500"   "5042501"   "5060506"   "5060655"   "5060656"   "5063937"   "5068536"   "5069220").PN. OR ("5072737"   "5077476"   "5081871"   "5086781"   "5095900"   "5095913"   "5117674"   "5119825"   "5178155"   "5179958"   "5203344"   "5214966"   "5233520"   "5233996"   "5263491"   "5280429"   "5282473"   "5282840"   "5285794"   "5293875"   "5299579"   "5303712"   "5307263"   "5309921"   "5326973"   "5335667"   "5355879"   "5357972"   "5363857"   "5372141"   "5381796"   "5387164"   "5388043"   "5398688"   "5398695"   "5402796"   "5412560"   "5412564"   "5415176"   "5419326"   "5421344"   "5425374"   "5449000"   "5450193"   "5454721"   "5468961"   "5485402"   "5503151"   "5542420"   "5570697"   "5579782"   "5611351"   "5615689"   "5632281"   "5645071"   "5647370"   "5673691"   "5676132"   "5678562"   "5678571"   "5691927"   "5704350"   "5705735"   "5720296"   "5729479"   "5746214"   "5754288"   "5788643"   "5789660"   "5796009"   "5796640"   "5800360"   "5810722"   "5816246"   "5817031"   "5819735"   "5822715"   "5827179"   "5831175"   "5832448"   "5834626"   "5836300"   "5836312"   "5876351"   "5890128"   "5897493"   "5899855"   "5902234"   "5908301"   "5910107"   "5913310"   "5918603"   "5922610"   "5932812"   "5933136"   "5941825"   "5951300"   "5957858"   "5961451"   "5974124"   "5989188"   "5997476"   "6010459"   "6013007"   "6014578"   "6015389"   "6024281"   "6024699"   "6030342"   "6032676"   "6040531"   "6042383"   "6044843"   "6045513"   "6077193"   "6083006"   "6095949"   "6095985"   "6101478"   "6122536"   "6135950"   "6135951"   "6309342"   "6396416").PN. OR ("6790178").URPN.				
L11	27	10 and (web internet download) and @ay<="1999"	US-PGPUB; USPAT	OR	ON	2012/05/31 14:47
L17	23	((ROGER) near2 (QUY)).INV.	US-PGPUB; USPAT; USOCR	OR	OFF	2012/05/31 15:15
L18	1	17 and (download\$5 same server).clm.	US-PGPUB; USPAT; USOCR; FPRS; EPO; JPO; DERWENT; IBM_TDB	OR	ON	2012/05/31 15:15
S1	1	"12211033" and (IEEE bluetooth "802.11")	US-PGPUB; USPAT	OR	OFF	2012/05/30 18:21

**EAST Search History (Interference)**

--	--	--	--	--	--	--

Ref #	Hits	Search Query	DBs	Default Operator	Plurals	Time Stamp
L12	1	(download\$5 AND (application software program) AND wireless AND (phone cellular telephone) AND exercise AND (server central) and (internet)).clm.	USPAT; UPAD	OR	ON	2012/05/31 14:49
L13	0	(download\$5 SAME (application software program) SAME wireless SAME (phone cellular telephone) SAME exercise SAME (server central) SAME (internet)).clm.	USPAT; UPAD	OR	ON	2012/05/31 14:50
L14	0	(download\$5 SAME (application software program) SAME wireless SAME (exercise physiological biological medical ) SAME (server central) SAME (internet)).clm.	USPAT; UPAD	OR	ON	2012/05/31 14:50
L15	18	(download\$5 AND (application software program) AND wireless AND (exercise physiological biological medical ) AND (server central database) and (internet) AND response).clm.	USPAT; UPAD	OR	ON	2012/05/31 14:51
L16	8	(download\$5 AND (application software program) AND wireless AND (exercise physiological biological medical ) AND (server central database) and (internet) AND response AND display).clm.	USPAT; UPAD	OR	ON	2012/05/31 14:51

5/ 31/ 2012 3:15:56 PM

C:\Users\sjian\Documents\EAST\Workspaces\12211033.wsp





PTO/SB/08a (05-07)

Approved for use through 11/30/2007. OMB 0651-0031

U.S. Patent and Trademark Office; U.S. DEPARTMENT OF COMMERCE

Under the Paperwork Reduction Act of 1995, no persons are required to respond to a collection of information unless it contains a valid OMB control number.

<b>INFORMATION DISCLOSURE STATEMENT BY APPLICANT</b> ( Not for submission under 37 CFR 1.99)	Application Number		12211033	
	Filing Date		2008-09-15	
	First Named Inventor		Roger J. Quy	
	Art Unit		3769	
	Examiner Name		Michael C. Astorino	
	Attorney Docket Number		00125/002005	

U.S.PATENTS						
Examiner Initial*	Cite No	Patent Number	Kind Code <sup>1</sup>	Issue Date	Name of Patentee or Applicant of cited Document	Pages, Columns, Lines where Relevant Passages or Relevant Figures Appear
	1	5576952		1996-11-19	Stutman et al.	
	2	6093146		2000-07-25	Filangeri	
	3	6478736		2002-11-12	Mault	
	4	6610012	B2	2003-08-26	Mault	
	5	6856832		2005-02-15	Matsumura et al.	
	6	6936007	B2	2005-08-30	Quy	
	7	6976958	B2	2005-12-20	Quy	

If you wish to add additional U.S. Patent citation information please click the Add button.

**U.S.PATENT APPLICATION PUBLICATIONS**

**INFORMATION DISCLOSURE STATEMENT BY APPLICANT**  
( Not for submission under 37 CFR 1.99)

Application Number		12211033
Filing Date		2008-09-15
First Named Inventor	Roger J. Quy	
Art Unit	3769	
Examiner Name	Michael C. Astorino	
Attorney Docket Number	00125/002005	

U.S. PATENT DOCUMENTS						
Examiner Initials <sup>1</sup>	Cite No. <sup>1</sup>	U.S. Patent Document		Name of Patentee or Applicant of Cited Document	Date of Publication of Cited document MM-DD-YYYY	Pages, Column, Lines, Where Relevant Passages or Relevant Figures Appear
		Number	Kind Code <sup>2</sup> (If known)			
	AA	60/264,739		Posa et al.	01/2001	
	AB	4,282,883		Yerushalmy	08/1981	
	AC	5,012,814		Mills et al.	05/1991	
	AD	5,307,263		Brown	04/1994	
	AE	5,357,427		Langen et al.	10/1994	
	AF	5,434,611		Tamura	07/1995	
	AG	5,441,047		David et al.	08/1995	
	AH	5,544,649		David et al.	09/1996	
	AI	5,544,661		Davis et al.	08/1996	
	AJ	5,549,117		Tacklind et al.	08/1996	
	AK	5,553,609		Chen et al.	09/1996	
	AL	5,601,435		Quy	02/1997	
	AM	5,626,144		Tacklind et al.	05/1997	
	AN	5,678,562		Sellers	10/1997	
	AO	5,701,904		Simmons et al.	12/1997	
	AP	5,704,366		Tacklind, et al	01/1998	
	AQ	5,724,025		Tavori	03/1998	
	AR	5,732,709		Tacklind, et al	03/1998	
	AS	5,735,285		Albert, et al.	04/1998	
	AT	5,752,917		Fuchs	05/1998	
	AU	5,772,586		Heinonen, et al.	06/1998	
	AV	5,791,342		Woodard	09/1998	
	AW	5,931,791		Saltzstein et al.	08/1999	
	AX	5,933,136		Brown	08/1999	
	AY	5,935,060		Iliff	08/1999	
	AZ	5,941,829		Saltzstein et al.	08/1999	
	BA	5,951,300		Brown	09/1999	
	BB	5,959,533		Layson et al.	09/1999	
	BC	5,964,701		Asada, et al.	10/1999	
	BD	5,967,975		Ridgeway, Donald G.	10/1999	
	BE	5,987,352		Klein et al.	11/1999	
	BF	5,987,519		Peifer, et al.	10/1999	
	BG	5,997,476		Brown	12/1999	
	BH	6,022,315		Iliff	02/2000	
	BI	6,024,699		Surwit et al.	02/2000	
	BJ	6,050,940		Braun et al.	04/2000	
	BK	6,055,506		Frasca, Jr.	04/2000	
	BL	6,057,758		Dempsey, et al.	05/2000	

Examiner Signature	/Shirley Jian/	Date Considered	07/23/2012
--------------------	----------------	-----------------	------------

<sup>1</sup>EXAMINER: Initial if reference considered, whether or not citation is in conformance with MPEP 609. Draw line through citation if not in conformance and not considered. Include copy of this form with next communication to applicant.

<sup>2</sup>Unique citation designation number. <sup>3</sup>Applicant is to place a check mark here if English language translation is attached.

Burden Hour Statement: This form is estimated to take 2.0 hours to complete. Time will vary depending upon the needs of the individual case. Any comments on the amount of time you are required to complete this form should be sent to the Chief Information Officer, Patent and Trademark Office, Washington, DC 20230.

ALL REFERENCES CONSIDERED EXCEPT WHERE LINED THROUGH. /S.J./

<b>INFORMATION DISCLOSURE STATEMENT BY APPLICANT</b> (Not for submission under 37 CFR 1.99)	Application Number	12211033
	Filing Date	2008-09-15
	First Named Inventor	Roger J. Quy
	Art Unit	3769
	Examiner Name	Michael C. Astorino
	Attorney Docket Number	00125/002005

U.S. PATENT DOCUMENTS						
Examiner Initials <sup>1</sup>	Cite No. <sup>1</sup>	U.S. Patent Document		Name of Patentee or Applicant of Cited Document	Date of Publications of Cited document MM-DD-YYYY	Pages, Column, Lines, Where Relevant Passages or Relevant Figures Appear
		Number	Kind Code <sup>2</sup> (if known)			
	BM	6,059,692		Hickman	05/2000	
	BN	6,083,156		Leselicki	07/2000	
	BO	6,101,478		Brown	08/2000	
	BP	6,144,837		Quy	11/2000	
	BQ	6,160,478		Jacobsen et al.	12/2000	
	BR	6,168,563		Brown	01/2001	
	BS	6,190,324		Kieval et al.	02/2001	
	BT	6,266,645		Simpson	07/2001	
	BU	6,319,199		Sheehan et al.	11/2001	
	BV	6,336,900		Alleckson et al.	01/2001	
	BW	6,375,614		Braun et al.	04/2002	
	BX	6,386,882		Lindberg	05/2002	
	BY	6,416,471		Kumar et al.	07/2002	
	BZ	6,418,346		Nelson et al.	07/2002	
	CA	6,440,068		Brown et al.	08/2002	
	CB	6,450,955		Brown et al.	09/2002	
	CC	6,458,080		Brown et al.	10/2002	
	CD	6,529,771		Kieval et al.	03/2003	
	CE	6,602,191		Quy	08/2003	
	CF	20020016719		Nemeth et al.	02/2002	
	CG	20020019584		Schultze et al.	02/2002	
	CH	20020026223		Riff et al.	02/2002	
	CI	20020072785		Nelson et al.	06/2002	
	CJ	20020082480		Riff et al.	06/2002	
	CK	20020120310		Linden et al.	08/2002	
	CL	20030004554		Riff et al.	01/2003	
	CM	20030072424		Evans et al.	04/2003	
	CN	20030139785		Riff et al.	07/2003	
	CO	20030204413		Riff	10/2003	

FOREIGN PATENT DOCUMENTS							
Examiner Initials <sup>1</sup>	Cite No. <sup>1</sup>	Foreign Patent Document		Name of Patentee or Applicant of Cited Document	Date of Publications of Cited document MM-DD-YYYY	Pages, Column, Lines, Where Relevant Passages or Relevant Figures Appear	Y <sup>3</sup>
		Office <sup>3</sup>	Number <sup>2</sup>				
	CP		WO 95/32480	ENACT PRODUCTS	11/1995		
	CQ		WO 97/28736	NOKIA MOBILE PHONES LTD	08/1997		

Examiner Signature	/Shirley Jian/	Date Considered	07/23/2012
--------------------	----------------	-----------------	------------

<sup>1</sup>EXAMINER: Initial if reference considered, whether or not citation is in conformance with MPEP 609. Draw line through citation if not in conformance and not considered. Include copy of this form with next communication to applicant.  
<sup>2</sup>Unique citation designation number. <sup>3</sup>Applicant is to place a check mark here if English language Translation is attached.  
 Burden Hour Statement: This form is estimated to take 2.0 hours to complete. Time will vary depending upon the needs of the individual case. Any comments on the amount of time you are required to complete this form should be sent to the Chief Information Officer, Patent and Trademark Office, Washington, DC 20231.

ALL REFERENCES CONSIDERED EXCEPT WHERE LINED THROUGH. /S.J./

<b>INFORMATION DISCLOSURE STATEMENT BY APPLICANT</b> (Not for submission under 37 CFR 1.99)	Application Number	12211033
	Filing Date	2008-09-15
	First Named Inventor	Roger J. Quy
	Art Unit	3769
	Examiner Name	Michael C. Astorino
	Attorney Docket Number	00125/002005

FOREIGN PATENT DOCUMENTS								
Examiner Initials <sup>1</sup>	Cite No. <sup>2</sup>	Office <sup>3</sup>	Number <sup>4</sup>	Kind Code <sup>5</sup> (if known)	Name of Patentee or Applicant of Cited Document	Date of Publications of Cited document MM-DD-YYYY	Pages, Column, Lines, Where Relevant Passages or Relevant Figures Appear	T <sup>2</sup>
	CR		WO 97/28737		NOKIA MOBILE PHONES LTD	08/1997		
	CS		WO 98/24358		ENACT HEALTH MANAGEMENT SYSTEMS	06/1998		
	CT		WO 98/38909		INFORMEDIX, INC	09/1998		
	CU		WO 99/04687		OPTS, INC	02/1999		
	CV		WO 99/14882		GEORGIA TECH RESEARCH CORPORATION	03/1999		
	CW		WO 99/41682		SOUTHERN RESEARCH INSTITUTE	08/1999		
	CX		WO 99/44494		CARD GUARD SCIENTIFIC SURVIVAL LTD	09/1999		
	CY		WO 99/46718		HEALTHWARE CORPORATION	09/1999		
	CZ		WO 00/36900		FOURIE, Louise	06/2000		
	DA		WO 00/40145		CRITICARE SYSTEMS	07/2000		
	DB		WO 00/54205		AC PROPERTIES B.V.	09/2000		
	DC		WO 00/54206		AC PROPERTIES B.V.	09/2000		
	DD		WO 00/62662		CARDIOCOM	10/2000		
	DE		WO 01/24038		Imetrikus, Inc.	04/2001		

OTHER PRIOR ART—NON-PATENT LITERATURE DOCUMENTS			
Examiner Initials <sup>1</sup>	Cite No. <sup>2</sup>	Include name of the author (in CAPITAL LETTERS), title of the article (when appropriate), title of the item (book, magazine, journal, serial, symposium, catalog, etc.), date, page(s), volume-issue number(s), publisher, city and/or country where published.	T <sup>2</sup>
	DF	Jyrki Oraskari ; "Bluetooth versus WLAN IEEE 802.11x" ; Helsinki University of Technology (Department of Computer Science and Engineering) November, 2000	
	DG	Jack Smith ; Your Personal Health Buddy; ABCNews.com; <a href="http://abcnews.go.com/sections/tech/CuttingEdge/cuttingedge990225.html">http://abcnews.go.com/sections/tech/CuttingEdge/cuttingedge990225.html</a> ; 3 pages (November 24, 2000)	
	DH	The Health Hero Communications Platform ; The Health Hero Network Online Services ; <a href="http://www.hhn.com/products/index.html">http://www.hhn.com/products/index.html</a> ; 2 pages (November 24, 2000)	

Examiner Signature	/Shirley Jian/	Date Considered	07/23/2012
--------------------	----------------	-----------------	------------

<sup>1</sup>EXAMINER: Initial if reference considered, whether or not citation is in conformance with MPEP 609. Draw line through citation if not in conformance and not considered. Include copy of this form with next communication to applicant.

<sup>2</sup>Unique citation designation number. <sup>3</sup>Applicant is to place a check mark here if English language Translation is attached.

Burden Hour Statement: This form is estimated to take 2.0 hours to complete. Time will vary depending upon the needs of the individual case. Any comments on the amount of time you are required to complete this form should be sent to the Chief Information Officer, Patent and Trademark Office, Washington, DC 20231.

~~ALL REFERENCES CONSIDERED EXCEPT WHERE LINED THROUGH. /S.J./~~

<b>INFORMATION DISCLOSURE STATEMENT BY APPLICANT</b> ( Not for submission under 37 CFR 1.99)	Application Number		12211033	
	Filing Date		2008-09-15	
	First Named Inventor		Roger J. Quy	
	Art Unit		3769	
	Examiner Name		Michael C. Astorino	
	Attorney Docket Number		00125/002005	

Examiner Initials*	Cite No. <sup>1</sup>	U.S. Patent Document		Name of Patentee or Applicant of Cited Document	Issue Date MM-DD-YYYY
		Number	Class/Subclass		

Examiner Initials*	Cite No. <sup>1</sup>	U.S. Patent Publication		Name of Patentee or Applicant of Cited Document	Date of Publication of Cited Document MM-DD-YYYY
		Number	Class/Subclass		

Examiner Initials*	Cite No. <sup>1</sup>	Foreign Patent Document			Name of Patentee or Applicant of Cited Document	Date of Publication of Cited Document MM-DD-YYYY	T
		Office <sup>2</sup>	Number	Class/ Subclass			
	1.	JP	11259783 English Abstract Included	A61B5/00	Seiko Precision KK, et al.	09/24/1999	X
	2.	JP	11122369 English Abstract Included	H04Q7/38	NEC Saitama Ltd	04/30/1999	X
	3.	JP	11047101 English Abstract Included	A61B5/00	TOTO Ltd	02/23/1999	X
	4.	JP	9224917 English Abstract Included	G08C19/00	Yoshida Masao	09/02/1997	X
	5.	JP	2002/344660 A English Abstract only	A61 B5/00	Nec Fielding Ltd.	11-29-2002	X

OTHER PRIOR ART - NON PATENT LITERATURE DOCUMENTS			
Examiner Initials*	Cite No. <sup>1</sup>	Include name of the author (in CAPITAL LETTERS), title of the article (when appropriate), title of the item (book, magazine, journal, serial, symposium, catalog, etc.), date, page(s), volume-issue number(s), publisher, city and/or country where published.	T <sup>2</sup>
	1.	"Cell Phones Cameras Put Doctors in the Picture", February 21, 2005, 1 page, <a href="http://news.healingwell.com/index.php?p=news1&amp;id=524118">http://news.healingwell.com/index.php?p=news1&amp;id=524118</a>	

Examiner Signature	/Shirley Jian/	Date Considered	07/23/2012
--------------------	----------------	-----------------	------------

\*EXAMINER: Initial if reference considered, whether or not citation is in conformance with MPEP 609. Draw line through citation if not in conformance and not considered. Include copy of this form with next communication to applicant.

<sup>12</sup>Unique citation designation number. <sup>2</sup>Applicant is to place a check mark here if English language Translation is attached.  
 Burden Hour Statement: This form is estimated to take 2.0 hours to complete. Time will vary depending upon the needs of the individual case. Any comments on the amount of time you are required to complete this form should be sent to the Chief Information Officer, Patent and trademark Office, Washington, DC 20231. DO NOT SEND FEES OR COMPLETED FORMS TO THIS ADDRESS. SEND TO: Assistant Commissioner for Patents, Washington, DC 20231.

ALL REFERENCES CONSIDERED EXCEPT WHERE LINED THROUGH. /S.J./

<b>INFORMATION DISCLOSURE STATEMENT BY APPLICANT</b> ( Not for submission under 37 CFR 1.99)	Application Number		12211033
	Filing Date		2008-09-15
	First Named Inventor	Roger J. Quy	
	Art Unit	3769	
	Examiner Name	Michael C. Astorino	
	Attorney Docket Number	00125/002005	

OTHER PRIOR ART—NON-PATENT LITERATURE DOCUMENTS			
Examiner Initials	Cite No.	Include name of the author (in CAPITAL LETTERS), title of the article (when appropriate), title of the item (book, magazine, journal, serial, symposium, catalog, etc.), date, page(s), volume-issue number(s), publisher, city and/or country where published.	T <sup>2</sup>
	DI	Painless Blood-Glucose Monitoring ; Kumertrix Technology Overview ; <a href="http://www.kumertrix.com/technology.html">http://www.kumertrix.com/technology.html</a> ; 2 pages; November 24, 2000	
	DJ	Technology & Clinical Results-Simple Solutions Through Technology-Progression of Glucose Monitoring Technology ; Amira ; <a href="http://amira.com/tech/tc_tech.htm">http://amira.com/tech/tc_tech.htm</a> ; 2 pages; November 24, 2000	
	DK	Wired for Wellness ; LifeChart.com ; <a href="http://www.lifechart.com">http://www.lifechart.com</a> ; 2 pages ; November 24, 2000	
	DL	About Data Critical Corporation ; Yahoo—Data Critical to Provide Mallincrod with Wireless Connectivity for Ventilators ; <a href="http://biz.yahoo.com/pmews/001012/mo_mallinc.html">http://biz.yahoo.com/pmews/001012/mo_mallinc.html</a> ; 1 page; November 24, 2000	
	DM	Bluetooth wireless technology-bridging the gap between computing and communication; Bluetooth Technology; <a href="http://www.intel.com/mobile/bluetooth/">http://www.intel.com/mobile/bluetooth/</a> ; 2 pages; November 28, 2000	
	DN	Bluetooth resource center ; What is Bluetooth ?; palowireless.com; <a href="http://www.palowireless.com/infotooth/walis.asp">http://www.palowireless.com/infotooth/walis.asp</a> ; 3 pages; November 28, 2000	
	DO	Bluetooth Tutorial ; palowireless.com—bluetooth resource center ; <a href="http://www.palowireless.com/infotooth/tutorial.asp">http://www.palowireless.com/infotooth/tutorial.asp</a> ; 4 pages; November 28, 2000	
	DP	Bluetooth Profiles; palowireless.com—bluetooth resource center; <a href="http://www.palowireless.com/infotooth/tutorial/profiles.asp">http://www.palowireless.com/infotooth/tutorial/profiles.asp</a> ; 4 pages; November 28, 2000	
	DQ	Nick Hunt ; Bluetooth Venus 802.11 ; TDK Systems ; <a href="http://www.cellular.com.za/bluetooth_versus_802.htm">http://www.cellular.com.za/bluetooth_versus_802.htm</a> ; 4 pages; November 28, 2000	
	DR	Bluetooth vs. Airport (802.11 Network); palowireless.com—Bluetooth resource center; <a href="http://www.palowireless.com/infotooth/knowledge/othernetworks/15.asp">http://www.palowireless.com/infotooth/knowledge/othernetworks/15.asp</a> ; 3 pages; November 28, 2000	
	DS	Personal Digital Assistants; A2 Anytime/Anywhere—A Weekly on Wireless Infrastructure and Data Services; Thomas Wiesel Partners (Merchant Banking); 5 pages; November 29, 2000	
	DT	Ashlee Vance; Ericsson and Intel Make Bluetooth Pact; InfoWorld.com; <a href="http://www.infoworld.com/articles/hn/xml/00/12/04/001204hnericintel.xml?T.../printarticle.htm">http://www.infoworld.com/articles/hn/xml/00/12/04/001204hnericintel.xml?T.../printarticle.htm</a> ; 1 page; December 4, 2000	

Examiner Signature	/Shirley Jian/	Date Considered	07/23/2012
--------------------	----------------	-----------------	------------

AMINER: Initial if reference considered, whether or not citation is in conformance with MPEP 609. Draw line through citation if not in conformance and not considered. Include copy of this form with next communication to applicant.  
 Unique citation designation number. <sup>2</sup> Applicant is to place a check mark here if English language Translation is attached.  
 Ten Hour Statement: This form is estimated to take 2.0 hours to complete. Time will vary depending upon the needs of the individual case. Any comments on amount of time you are required to complete this form should be sent to the Chief Information Officer, Patent and Trademark Office, Washington, DC 20231.  
 NOT SEND FEES OR COMPLETED FORMS TO THIS ADDRESS. SEND TO: Assistant Commissioner for Patents, Washington, DC 20235

ALL REFERENCES CONSIDERED EXCEPT WHERE LINED THROUGH. /S.J./

<b>INFORMATION DISCLOSURE STATEMENT BY APPLICANT</b> ( Not for submission under 37 CFR 1.99)	Application Number	12211033
	Filing Date	2008-09-15
	First Named Inventor	Roger J. Quy
	Art Unit	3769
	Examiner Name	Michael C. Astorino
	Attorney Docket Number	00125/002005

Examiner Initials <sup>1</sup>	Cite No. <sup>1</sup>	OTHER PRIOR ART—NON-PATENT LITERATURE DOCUMENTS	2
		Include name of the author (In CAPITAL LETTERS), title of the article (when appropriate), title of the item (book, magazine, journal, serial, symposium, catalog, etc.), date, page(s), volume-issue number(s), publisher, city and/or country where published.	
	DU	Personal Portable Office; Nokia 9000ii digital; <a href="http://www.nokiausa.com/9000ii">http://www.nokiausa.com/9000ii</a> ; 4 pages; December 7, 2000	
	DV	Pui-Wing Tam; Handspring Homes; Article from the Wall Street Journal; Section B; November 2000	
	DW	Author unknown; Articles on Phones and New Technologies; Article from the Wall Street Journal; November 2000	
	DX	David Pringle; Sagen to Launch Hand-held Computer that Doubles as Top-End Mobile Phone; Article from the Wall Street Journal; November 2000	
	DY	Svensson, Peter, "Cisco Launches WiFi Phone" Article from Australian IT; April 29, 2003	
	DZ	"Breakthrough Devices Shown At ADA" published in Diabetes News for July 1, 2001 at <a href="http://www.diabetesnet.com/news/news070101.php">http://www.diabetesnet.com/news/news070101.php</a>	
	EA	"iMetrikus" published at <a href="http://www.qualcomm.com/qwbs/resource/resource/lib_casestdy.shtml">http://www.qualcomm.com/qwbs/resource/resource/lib_casestdy.shtml</a>	
	EB	"Applications of MedStar" published on April 27, 2003 by Cybernet Medical, 16 pages	
	EC	"HIPAA & WiFi: Regulatory Tangles for Wireless Health Care Networks Analyzed" published at <a href="http://www.hipaadvisory.com/tech/wireless.htm">http://www.hipaadvisory.com/tech/wireless.htm</a>	
	ED	"Medtronic CareLink Network, How it Works" published at <a href="http://www.medtronic.com/carelink/features.html">http://www.medtronic.com/carelink/features.html</a>	
	EE	"FDA Approves Medtronic CareLink™ Monitor and Software, Opening a New Chapter in Patient Management Using Internet Technology", Medtronic News Release dated 01/02/02	
	EF	"The MedStar System, How the MedStar System Works" brochure published by Cybernet Medical.	

Examiner Signature	/Shirley Jian/	Date Considered	07/23/2012
--------------------	----------------	-----------------	------------

<sup>1</sup>AMINER: Initial if reference considered, whether or not citation is in conformance with MPEP 609. Draw line through citation if not in conformance and not considered. Include copy of this form with next communication to applicant.  
<sup>2</sup>Applicant is to place a check mark here if English language Translation is attached.  
 10 Hour Statement: This form is estimated to take 2.0 hours to complete. Time will vary depending upon the needs of the individual case. Any comments on amount of time you are required to complete this form should be sent to the Chief Information Officer, Patent and Trademark Office, Washington, DC 20231

ALL REFERENCES CONSIDERED EXCEPT WHERE LINED THROUGH. /S.J./



<b>INFORMATION DISCLOSURE STATEMENT BY APPLICANT</b> ( Not for submission under 37 CFR 1.99)	Application Number		12211033
	Filing Date		2008-09-15
	First Named Inventor	Roger J. Quy	
	Art Unit	3769	
	Examiner Name	Michael C. Astorino	
	Attorney Docket Number	00125/002005	

OTHER PRIOR ART—NON-PATENT LITERATURE DOCUMENTS			
Examiner Initials*	Cite No. <sup>1</sup>	Include name of the author (In CAPITAL LETTERS), title of the article (when appropriate), title of the item (book, magazine, journal, serial, symposium, catalog, etc.), date, page(s), volume-issue number(s), publisher, city and/or country where published.	T <sup>2</sup>
	EG	"iMetrikus Mobile Solutions" brochure by iMetrikus, Inc.	
	EH	"Instromedix - Products" published at <a href="http://www.instromedix.com/pages/products/products.asp">www.instromedix.com/pages/products/products.asp</a> . 7 Pages	

Examiner Signature	/Shirley Jian/	Date Considered	07/23/2012
--------------------	----------------	-----------------	------------

\*EXAMINER: Initial if reference considered, whether or not citation is in conformance with MPEP 609. Draw line through citation if not in conformance and not considered. Include copy of this form with next communication to applicant.

<sup>1</sup>Unique citation designation number. <sup>2</sup>Applicant is to place a check mark here if English language Translation is attached.

Burden Hour Statement: This form is estimated to take 2.0 hours to complete. Time will vary depending upon the needs of the individual case. Any comments on

ALL REFERENCES CONSIDERED EXCEPT WHERE LINED THROUGH. /S.J./

<b>INFORMATION DISCLOSURE STATEMENT BY APPLICANT</b> ( Not for submission under 37 CFR 1.99)	Application Number	12211033
	Filing Date	2008-09-15
	First Named Inventor	Roger J. Quy
	Art Unit	3769
	Examiner Name	Michael C. Astorino
	Attorney Docket Number	00125/002005

OTHER PRIOR ART - NON PATENT LITERATURE DOCUMENTS			
Examiner Initials <sup>2</sup>	Cite No. <sup>1</sup>	Include name of the author (in CAPITAL LETTERS), title of the article (when appropriate), title of the item (book, magazine, journal, serial, symposium, catalog, etc.), date, page(s), volume-issue number(s), publisher, city and/or country where published.	T <sup>3</sup>
	1.	EFI Framework Draft Version 0.8 (03-June-2000); External Functionality Interface Framework; pp, 1-35.	
	2.	Internet Press Release: New York Business Wire (Sept. 25, 2000); MedSearch Technologies, Inc. Develops a Revolutionary Home-Care Wireless Technology Utilizing PSA's-Personal Organizers-as Patient Monitors	

Examiner Signature	/Shirley Jian/	Date Considered	07/23/2012
--------------------	----------------	-----------------	------------

EXAMINER: Initial if reference considered, whether or not citation is in conformance with MPEP 609. Draw line through citation, if not in conformance and not considered. Include copy of this form with next communication to applicant.

<sup>1</sup> Unique citation designation number. <sup>2</sup> Enter Office that issued the document, by the two-letter code (WIPO Standard ST.3). <sup>3</sup> For Japanese patent documents, the indication of the year of the reign of the Emperor must precede the serial number of the patent document. <sup>4</sup> Kind of document by the appropriate symbols as indicated on the document under WIPO Standard ST. 16 if possible. <sup>5</sup> Applicant is to place a check mark here if English Language Translation is attached.

ALL REFERENCES CONSIDERED EXCEPT WHERE LINED THROUGH. /S.J./

<b>INFORMATION DISCLOSURE STATEMENT BY APPLICANT</b> ( Not for submission under 37 CFR 1.99)	Application Number		12211033
	Filing Date		2008-09-15
	First Named Inventor	Roger J. Quy	
	Art Unit	3769	
	Examiner Name	Michael C. Astorino	
	Attorney Docket Number	00125/002005	

If you wish to add additional Foreign Patent Document citation information please click the Add button

**NON-PATENT LITERATURE DOCUMENTS**

Examiner Initials*	Cite No	Include name of the author (in CAPITAL LETTERS), title of the article (when appropriate), title of the item (book, magazine, journal, serial, symposium, catalog, etc), date, pages(s), volume-issue number(s), publisher, city and/or country where published.	T <sup>5</sup>
	1	JOSEPH FINKELSTEIN, et al., "Web-Based Monitoring of Asthma Severity: A New Approach to Ambulatory Management". Proc. 1998 IEEE Int'l Conf. on Info Tech. Applications in Biomedicine, 1998, pp. 139-143.	<input type="checkbox"/>

If you wish to add additional non-patent literature document citation information please click the Add button

**EXAMINER SIGNATURE**

Examiner Signature	/Shirley Jian/	Date Considered	07/23/2012
--------------------	----------------	-----------------	------------

\*EXAMINER: Initial if reference considered, whether or not citation is in conformance with MPEP 609. Draw line through a citation if not in conformance and not considered. Include copy of this form with next communication to applicant.

<sup>1</sup> See Kind Codes of USPTO Patent Documents at [www.USPTO.GOV](http://www.USPTO.GOV) or MPEP 901.04. <sup>2</sup> Enter office that issued the document, by the two-letter code (WIPO Standard ST.3). <sup>3</sup> For Japanese patent documents, the indication of the year of the reign of the Emperor must precede the serial number of the patent document. <sup>4</sup> Kind of document by the appropriate symbols as indicated on the document under WIPO Standard ST.16 if possible. <sup>5</sup> Applicant is to place a check mark here if English language translation is attached.

Receipt date: 05/11/2009

12211033 - GAU: 3769

<b>INFORMATION DISCLOSURE STATEMENT BY APPLICANT</b> ( Not for submission under 37 CFR 1.99)	Application Number		12211033
	Filing Date		2008-09-15
	First Named Inventor	Roger J. Quy	
	Art Unit		3769
	Examiner Name	Michael C. Astorino	
	Attorney Docket Number		00125/002005

2.		YAN XIAO, PhD. et al., "Design and Evaluation of a Real-Time Mobile Telemedicine System for Ambulance Transport", <i>Proceedings of the 1998 American Medical Informatics Association Annual Fall Symposium</i> , 1998, pp. 1102-1103.	
3.		YAN XIAO, PhD. et al., "Design and Evaluation of a Real-Time Mobile Telemedicine System for Ambulance Transport", <i>The Journal of High Speed Networks</i> , 2000, vol. 9 (1), pp. 47-56.	

Examiner Signature	/Shirley Jian/	Date Considered	07/23/2012
--------------------	----------------	-----------------	------------

\*EXAMINER: Initial if reference considered, whether or not citation is in conformance with MPEP 609. Draw line through citation if not in conformance and not considered. Include copy of this form with next communication to applicant.

<sup>12</sup>Unique citation designation number. <sup>2</sup>Applicant is to place a check mark here if English language Translation is attached.  
 Burden Hour Statement: This form is estimated to take 2.0 hours to complete. Time will vary depending upon the needs of the individual case. Any comments on the amount of time you are required to complete this form should be sent to the Chief Information Officer, Patent and Trademark Office, Washington, DC 20231. DO NOT SEND FEES OR COMPLETED FORMS TO THIS ADDRESS. SEND TO: Assistant Commissioner for Patents, Washington, DC 20231.

ALL REFERENCES CONSIDERED EXCEPT WHERE LINED THROUGH. /S.J./

<b>INFORMATION DISCLOSURE STATEMENT BY APPLICANT</b> (Not for submission under 37 CFR 1.99)	Application Number		12211033
	Filing Date		2008-09-15
	First Named Inventor	Roger J. Quy	
	Art Unit	3769	
	Examiner Name	Michael C. Astorino	
	Attorney Docket Number	00125/002005	

OTHER PRIOR ART - NON PATENT LITERATURE DOCUMENTS			
Examiner Initials <sup>6</sup>	Cite No. <sup>1</sup>	Include name of the author (in CAPITAL LETTERS), title of the article (when appropriate), title of the item (book, magazine, journal, serial, symposium, catalog, etc.), date, page(s), volume-issue number(s), publisher, city and/or country where published.	T <sup>2</sup>
	1.	EFI Framework Draft Version 0.8 (03-June-2000); External Functionality Interface Framework; pp, 1-35.	
	2.	Internet Press Release: New York Business Wire (Sept. 25, 2000); MedSearch Technologies, Inc. Develops a Revolutionary Home-Care Wireless Technology Utilizing PSA's-Personal Organizers-as Patient Monitors	

Examiner Signature	/Shirley Jian/	Date Considered	07/23/2012
--------------------	----------------	-----------------	------------

EXAMINER: Initial if reference considered, whether or not citation is in conformance with MPEP 609. Draw line through citation, if not in conformance and not considered. Include copy of this form with next communication to applicant.

<sup>1</sup> Unique citation designation number. <sup>2</sup> Enter Office that issued the document, by the two-letter code (WIPO Standard ST.3). <sup>3</sup> For Japanese patent documents, the indication of the year of the reign of the Emperor must precede the serial number of the patent document. <sup>4</sup> Kind of document by the appropriate symbols as indicated on the document under WIPO Standard ST. 16 if possible. <sup>5</sup> Applicant is to place a check mark here if English Language Translation is attached.

ALL REFERENCES CONSIDERED EXCEPT WHERE LINED THROUGH. /S.J./



UNITED STATES PATENT AND TRADEMARK OFFICE

UNITED STATES DEPARTMENT OF COMMERCE  
 United States Patent and Trademark Office  
 Address: COMMISSIONER FOR PATENTS  
 P.O. Box 1450  
 Alexandria, Virginia 22313-1450  
 www.uspto.gov

APPLICATION NO.	FILING DATE	FIRST NAMED INVENTOR	ATTORNEY DOCKET NO.	CONFIRMATION NO.
12/211,033	09/15/2008	Roger J. Quy	00125/002005	7693
27774	7590	07/25/2012	EXAMINER	
MAYER & WILLIAMS PC 251 NORTH AVENUE WEST Suite 201 WESTFIELD, NJ 07090			JIAN, SHIRLEY XUEYING	
			ART UNIT	PAPER NUMBER
			3769	
			MAIL DATE	DELIVERY MODE
			07/25/2012	PAPER

**Please find below and/or attached an Office communication concerning this application or proceeding.**

The time period for reply, if any, is set in the attached communication.



UNITED STATES DEPARTMENT OF COMMERCE

**U.S. Patent and Trademark Office**

Address : COMMISSIONER FOR PATENTS  
 P.O. Box 1450  
 Alexandria, Virginia 22313-1450

<b>APPLICATION NO./ CONTROL NO.</b>	<b>FILING DATE</b>	<b>FIRST NAMED INVENTOR / PATENT IN REEXAMINATION</b>	<b>ATTORNEY DOCKET NO.</b>
12/211,033	15 September, 2008	QUY, ROGER J.	00125/002005

MAYER & WILLIAMS PC 251 NORTH AVENUE WEST Suite 201 WESTFIELD, NJ 07090	<b>EXAMINER</b>	
	SHIRLEY JIAN	
	<b>ART UNIT</b>	<b>PAPER</b>
	3769	20120723

DATE MAILED:

**Please find below and/or attached an Office communication concerning this application or proceeding.**

Commissioner for Patents

The IDS submitted on 05/11/2009 has been considered.	
/Gregory A Morse/ Supervisory Patent Examiner, Art Unit 3769	/SHIRLEY JIAN/ Examiner, Art Unit 3769

PART B - FEE(S) TRANSMITTAL

Complete and send this form, together with applicable fee(s), to: **Mail** **Mail Stop ISSUE FEE**  
**Commissioner for Patents**  
**P.O. Box 1450**  
**Alexandria, Virginia 22313-1450**  
**or Fax** **(571)-273-2885**

INSTRUCTIONS: This form should be used for transmitting the ISSUE FEE and PUBLICATION FEE (if required). Blocks 1 through 5 should be completed where appropriate. All further correspondence including the Patent, advance orders and notification of maintenance fees will be mailed to the current correspondence address as indicated unless corrected below or directed otherwise in Block 1, by (a) specifying a new correspondence address; and/or (b) indicating a separate "FEE ADDRESS" for maintenance fee notifications.

CURRENT CORRESPONDENCE ADDRESS (Note: Use Block 1 for any change of address)

Mayer & Williams PC  
 251 North Avenue West  
 Suite 201  
 Westfield, New Jersey 07090

Note: A certificate of mailing can only be used for domestic mailings of the Fee(s) Transmittal. This certificate cannot be used for any other accompanying papers. Each additional paper, such as an assignment or formal drawing, must have its own certificate of mailing or transmission.

**Certificate of Mailing or Transmission**

I hereby certify that this Fee(s) Transmittal is being deposited with the United States Postal Service with sufficient postage for first class mail in an envelope addressed to the Mail Stop ISSUE FEE address above, or being facsimile transmitted to the USPTO (571) 273-2885, on the date indicated below.

Michelle Wolf	(Depositor's name)
/Michelle Wolf/	(Signature)
August 27, 2012	(Date)

APPLICATION NO.	FILING DATE	FIRST NAMED INVENTOR	ATTORNEY DOCKET NO.	CONFIRMATION NO.
12/211033	09/15/2008	Roger J. Quy	00125/002005	7693

TITLE OF INVENTION:

APPLN. TYPE	SMALL ENTITY	ISSUE FEE DUE	PUBLICATION FEE DUE	PREV. PAID ISSUE FEE	TOTAL FEE(S) DUE	DATE DUE
nonprovisional	YES	\$870.00	\$300.00	\$0	\$1170.00	9/11/2012
EXAMINER		ART UNIT	CLASS-SUBCLASS			

1. Change of correspondence address or indication of "Fee Address" (37 CFR 1.363).

- Change of correspondence address (or Change of Correspondence Address form PTO/SB/122) attached.
- "Fee Address" indication (or "Fee Address" Indication form PTO/SB/47; Rev 03-02 or more recent) attached. **Use of a Customer Number is required.**

2. For printing on the patent front page, list

- (1) the names of up to 3 registered patent attorneys or agents OR, alternatively,
- (2) the name of a single firm (having as a member a registered attorney or agent) and the names of up to 2 registered patent attorneys or agents. If no name is listed, no name will be printed.

- 1 Mark D. Wieczorek
- 2 Mayer & Williams P.C.
- 3

3. ASSIGNEE NAME AND RESIDENCE DATA TO BE PRINTED ON THE PATENT (print or type)

PLEASE NOTE: Unless an assignee is identified below, no assignee data will appear on the patent. If an assignee is identified below, the document has been filed for recordation as set forth in 37 CFR 3.11. Completion of this form is NOT a substitute for filing an assignment.

(A) NAME OF ASSIGNEE

(B) RESIDENCE: (CITY and STATE OR COUNTRY)

Q-Tec Systems LLC

Wilmington, DE

Please check the appropriate assignee category or categories (will not be printed on the patent) :  Individual  Corporation or other private group entity  Government

4a. The following fee(s) are submitted:

- Issue Fee
- Publication Fee (No small entity discount permitted)
- Advance Order - # of Copies \_\_\_\_\_

4b. Payment of Fee(s): (Please first reapply any previously paid issue fee shown above)

- A check is enclosed.
- Payment by credit card. Form PTO-2038 is attached.
- The Director is hereby authorized to charge the required fee(s), any deficiency, or credit any overpayment, to Deposit Account Number 501047 \_\_\_\_\_ (enclose an extra copy of this form).

5. Change in Entity Status (from status indicated above)

- a. Applicant claims SMALL ENTITY status. See 37 CFR 1.27.
- b. Applicant is no longer claiming SMALL ENTITY status. See 37 CFR 1.27(g)(2).

NOTE: The Issue Fee and Publication Fee (if required) will not be accepted from anyone other than the applicant; a registered attorney or agent; or the assignee or other party in interest as shown by the records of the United States Patent and Trademark Office.

Authorized Signature Mark Wieczorek/

Date August 24, 2012

Typed or printed name Mark D. Wieczorek

Registration No. 37966

This collection of information is required by 37 CFR 1.311. The information is required to obtain or retain a benefit by the public which is to file (and by the USPTO to process) an application. Confidentiality is governed by 35 U.S.C. 122 and 37 CFR 1.14. This collection is estimated to take 12 minutes to complete, including gathering, preparing, and submitting the completed application form to the USPTO. Time will vary depending upon the individual case. Any comments on the amount of time you require to complete this form and/or suggestions for reducing this burden, should be sent to the Chief Information Officer, U.S. Patent and Trademark Office, U.S. Department of Commerce, P.O. Box 1450, Alexandria, Virginia 22313-1450. DO NOT SEND FEES OR COMPLETED FORMS TO THIS ADDRESS. SEND TO: Commissioner for Patents, P.O. Box 1450, Alexandria, Virginia 22313-1450.

Under the Paperwork Reduction Act of 1995, no persons are required to respond to a collection of information unless it displays a valid OMB control number.



## Privacy Act Statement

**The Privacy Act of 1974 (P.L. 93-579)** requires that you be given certain information in connection with your submission of the attached form related to a patent application or patent. Accordingly, pursuant to the requirements of the Act, please be advised that: (1) the general authority for the collection of this information is 35 U.S.C. 2(b)(2); (2) furnishing of the information solicited is voluntary; and (3) the principal purpose for which the information is used by the U.S. Patent and Trademark Office is to process and/or examine your submission related to a patent application or patent. If you do not furnish the requested information, the U.S. Patent and Trademark Office may not be able to process and/or examine your submission, which may result in termination of proceedings or abandonment of the application or expiration of the patent.

The information provided by you in this form will be subject to the following routine uses:

1. The information on this form will be treated confidentially to the extent allowed under the Freedom of Information Act (5 U.S.C. 552) and the Privacy Act (5 U.S.C. 552a). Records from this system of records may be disclosed to the Department of Justice to determine whether disclosure of these records is required by the Freedom of Information Act.
2. A record from this system of records may be disclosed, as a routine use, in the course of presenting evidence to a court, magistrate, or administrative tribunal, including disclosures to opposing counsel in the course of settlement negotiations.
3. A record in this system of records may be disclosed, as a routine use, to a Member of Congress submitting a request involving an individual, to whom the record pertains, when the individual has requested assistance from the Member with respect to the subject matter of the record.
4. A record in this system of records may be disclosed, as a routine use, to a contractor of the Agency having need for the information in order to perform a contract. Recipients of information shall be required to comply with the requirements of the Privacy Act of 1974, as amended, pursuant to 5 U.S.C. 552a(m).
5. A record related to an International Application filed under the Patent Cooperation Treaty in this system of records may be disclosed, as a routine use, to the International Bureau of the World Intellectual Property Organization, pursuant to the Patent Cooperation Treaty.
6. A record in this system of records may be disclosed, as a routine use, to another federal agency for purposes of National Security review (35 U.S.C. 181) and for review pursuant to the Atomic Energy Act (42 U.S.C. 218(c)).
7. A record from this system of records may be disclosed, as a routine use, to the Administrator, General Services, or his/her designee, during an inspection of records conducted by GSA as part of that agency's responsibility to recommend improvements in records management practices and programs, under authority of 44 U.S.C. 2904 and 2906. Such disclosure shall be made in accordance with the GSA regulations governing inspection of records for this purpose, and any other relevant (i.e., GSA or Commerce) directive. Such disclosure shall not be used to make determinations about individuals.
8. A record from this system of records may be disclosed, as a routine use, to the public after either publication of the application pursuant to 35 U.S.C. 122(b) or issuance of a patent pursuant to 35 U.S.C. 151. Further, a record may be disclosed, subject to the limitations of 37 CFR 1.14, as a routine use, to the public if the record was filed in an application which became abandoned or in which the proceedings were terminated and which application is referenced by either a published application, an application open to public inspection or an issued patent.
9. A record from this system of records may be disclosed, as a routine use, to a Federal, State, or local law enforcement agency, if the USPTO becomes aware of a violation or potential violation of law or regulation.

## Electronic Patent Application Fee Transmittal

<b>Application Number:</b>	12211033			
<b>Filing Date:</b>	15-Sep-2008			
<b>Title of Invention:</b>	METHOD AND APPARATUS FOR MONITORING EXERCISE WITH WIRELESS INTERNET CONNECTIVITY			
<b>First Named Inventor/Applicant Name:</b>	Roger J. Quy			
<b>Filer:</b>	Stuart H. Mayer/Michelle Wolf			
<b>Attorney Docket Number:</b>	00125/002005			
Filed as Small Entity				
<b>Utility under 35 USC 111(a) Filing Fees</b>				
<b>Description</b>	<b>Fee Code</b>	<b>Quantity</b>	<b>Amount</b>	<b>Sub-Total in USD(\$)</b>
<b>Basic Filing:</b>				
<b>Pages:</b>				
<b>Claims:</b>				
<b>Miscellaneous-Filing:</b>				
<b>Petition:</b>				
<b>Patent-Appeals-and-Interference:</b>				
<b>Post-Allowance-and-Post-Issuance:</b>				
Utility Appl issue fee	2501	1	870	870
Publ. Fee- early, voluntary, or normal	1504	1	300	300

Description	Fee Code	Quantity	Amount	Sub-Total in USD(\$)
<b>Extension-of-Time:</b>				
<b>Miscellaneous:</b>				
<b>Total in USD (\$)</b>				<b>1170</b>

**Electronic Acknowledgement Receipt**

<b>EFS ID:</b>	13592640
<b>Application Number:</b>	12211033
<b>International Application Number:</b>	
<b>Confirmation Number:</b>	7693
<b>Title of Invention:</b>	METHOD AND APPARATUS FOR MONITORING EXERCISE WITH WIRELESS INTERNET CONNECTIVITY
<b>First Named Inventor/Applicant Name:</b>	Roger J. Quy
<b>Customer Number:</b>	27774
<b>Filer:</b>	Stuart H. Mayer/Michelle Wolf
<b>Filer Authorized By:</b>	Stuart H. Mayer
<b>Attorney Docket Number:</b>	00125/002005
<b>Receipt Date:</b>	27-AUG-2012
<b>Filing Date:</b>	15-SEP-2008
<b>Time Stamp:</b>	13:17:31
<b>Application Type:</b>	Utility under 35 USC 111(a)

**Payment information:**

Submitted with Payment	yes
Payment Type	Deposit Account
Payment was successfully received in RAM	\$1170
RAM confirmation Number	10806
Deposit Account	501047
Authorized User	

The Director of the USPTO is hereby authorized to charge indicated fees and credit any overpayment as follows:

Charge any Additional Fees required under 37 C.F.R. Section 1.16 (National application filing, search, and examination fees)

Charge any Additional Fees required under 37 C.F.R. Section 1.17 (Patent application and reexamination processing fees)

Charge any Additional Fees required under 37 C.F.R. Section 1.19 (Document supply fees)

Charge any Additional Fees required under 37 C.F.R. Section 1.20 (Post Issuance fees)

Charge any Additional Fees required under 37 C.F.R. Section 1.21 (Miscellaneous fees and charges)

**File Listing:**

Document Number	Document Description	File Name	File Size(Bytes)/ Message Digest	Multi Part /.zip	Pages (if appl.)
1	Issue Fee Payment (PTO-85B)	s00125-002005-issue-fee-transmittal.pdf	87929 0f14feb979fb6be0a333edf3d4b8632fe149aaef	no	2

**Warnings:**

**Information:**

2	Fee Worksheet (SB06)	fee-info.pdf	32059 6eccdf3de0233b433898b30c61c861371e48394	no	2
---	----------------------	--------------	--	----	---

**Warnings:**

**Information:**

<b>Total Files Size (in bytes):</b>			119988		
-------------------------------------	--	--	--------	--	--

This Acknowledgement Receipt evidences receipt on the noted date by the USPTO of the indicated documents, characterized by the applicant, and including page counts, where applicable. It serves as evidence of receipt similar to a Post Card, as described in MPEP 503.

**New Applications Under 35 U.S.C. 111**

If a new application is being filed and the application includes the necessary components for a filing date (see 37 CFR 1.53(b)-(d) and MPEP 506), a Filing Receipt (37 CFR 1.54) will be issued in due course and the date shown on this Acknowledgement Receipt will establish the filing date of the application.

**National Stage of an International Application under 35 U.S.C. 371**

If a timely submission to enter the national stage of an international application is compliant with the conditions of 35 U.S.C. 371 and other applicable requirements a Form PCT/DO/EO/903 indicating acceptance of the application as a national stage submission under 35 U.S.C. 371 will be issued in addition to the Filing Receipt, in due course.

**New International Application Filed with the USPTO as a Receiving Office**

If a new international application is being filed and the international application includes the necessary components for an international filing date (see PCT Article 11 and MPEP 1810), a Notification of the International Application Number and of the International Filing Date (Form PCT/RO/105) will be issued in due course, subject to prescriptions concerning national security, and the date shown on this Acknowledgement Receipt will establish the international filing date of the application.

Receipt date: 05/11/2009

12211033 - GAU: 3769

<b>INFORMATION DISCLOSURE STATEMENT BY APPLICANT</b> (Not for submission under 37 CFR 1.99)	Application Number		12211033
	Filing Date		2008-09-15
	First Named Inventor	Roger J. Quy	
	Art Unit	3769	
	Examiner Name	Michael C. Astorino	
	Attorney Docket Number	00125/002005	

Change(s) applied to document /A.E.M./ 8/6/2012

U.S. PATENT DOCUMENTS						
Examiner Initials <sup>1</sup>	Cite No. <sup>1</sup>	U.S. Patent Document		Name of Patentee or Applicant of Cited Document	Date of Publication of Cited document MM-DD-YYYY	Pages, Column, Lines, Where Relevant Passages or Relevant Figures Appear
		Number	Kind Code <sup>2</sup> (if known)			
	BM	6,059,692		Hickman	05/2000	
	BN	6,083,156		Leselcki	07/2000	
	BO	6,101,478		Brown	08/2000	
	BP	6,144,837		Quy	11/2000	
	BQ	6,160,478		Jacobsen et al.	12/2000	
	BR	6,168,563		Brown	01/2001	
	BS	6,190,324		Kieval et al.	02/2001	
	BT	6,266,645		Simpson	07/2001	
	BU	6,319,199		Sheehan et al.	11/2001	
	BV	6,336,900		Alleckson et al.	01/2002	
	BW	6,375,614		Braun et al.	04/2002	
	BX	6,386,882		Lindberg	05/2002	
	BY	6,416,471		Kumar et al.	07/2002	
	BZ	6,418,346		Nelson et al.	07/2002	
	CA	6,440,068		Brown et al.	08/2002	
	CB	6,450,955		Brown et al.	09/2002	
	CC	6,458,080		Brown et al.	10/2002	
	CD	6,529,771		Kieval et al.	03/2003	
	CE	6,602,191		Quy	08/2003	
	CF	20020016719		Nemeth et al.	02/2002	
	CG	20020019584		Schultze et al.	02/2002	
	CH	20020026223		Riff et al.	02/2002	
	CI	20020072785		Nelson et al.	06/2002	
	CJ	20020082480		Riff et al.	06/2002	
	CK	20020120310		Linden et al.	08/2002	
	CL	20030004554		Riff et al.	01/2003	
	CM	20030072424		Evans et al.	04/2003	
	CN	20030139785		Riff et al.	07/2003	
	CO	20030204413		Riff	10/2003	

FOREIGN PATENT DOCUMENTS							
Examiner Initials <sup>1</sup>	Cite No. <sup>1</sup>	Foreign Patent Document			Name of Patentee or Applicant of Cited Document	Date of Publication of Cited document MM-DD-YYYY	Pages, Column, Lines, Where Relevant Passages or Relevant Figures Appear
		Office <sup>3</sup>	Number <sup>3</sup>	Kind Code <sup>2</sup> (if known)			
	CP		WO 95/32480		ENACT PRODUCTS	11/1995	
	CQ		WO 97/28736		NOKIA MOBILE PHONES LTD	08/1997	

Examiner Signature	/Shirley Jian/	Date Considered	07/23/2012
--------------------	----------------	-----------------	------------

<sup>1</sup>EXAMINER: Indicate if reference considered, whether or not citation is in conformance with MPEP 609. Draw line through citation if not in conformance and not considered. Include copy of this form with next communication to applicant.

<sup>2</sup>Unique citation designation number. <sup>3</sup>Applicant is to place a check mark here if English language Translation is attached.

Burden Hour Statement: This form is estimated to take 2.0 hours to complete. Time will vary depending upon the needs of the individual case. Any comments on the amount of time you are required to complete this form should be sent to the Chief Information Officer, Patent and Trademark Office, Washington, DC 20231.

ALL REFERENCES CONSIDERED EXCEPT WHERE LINED THROUGH. /S.J./

Receipt date: 05/11/2009

12211033 - GAU: 3769

<b>INFORMATION DISCLOSURE STATEMENT BY APPLICANT</b> (Not for submission under 37 CFR 1.99)	Application Number		12211033
	Filing Date		2008-09-15
	First Named Inventor	Roger J. Quy	
	Art Unit	3769	
	Examiner Name	Michael C. Astorino	
	Attorney Docket Number	00125/002005	

U.S. PATENT DOCUMENTS						
Examiner Initials	Cite No. <sup>1</sup>	U.S. Patent Document		Name of Patentee or Applicant of Cited Document	Date of Publication of Cited Document MM-DD-YYYY	Pages, Column, Lines, Where Relevant Passages or Relevant Figures Appear
		Number	Kind Code <sup>2</sup> (if known)			
	AA	60/264,739		Posa et al.	01/2001	
	AB	4,282,883		Yerushalmy	08/1981	
	AC	5,012,814		Mills et al.	05/1991	
	AD	5,307,263		Brown	04/1994	
	AE	5,357,427		Langen et al.	10/1994	
	AF	5,434,611		Tamura	07/1995	
	AG	5,441,047		David et al.	08/1995	
	AH	5,544,649		David et al.	09/1996	
	AI	5,544,661		Davis et al.	08/1996	
	AJ	5,549,117		Tacklind et al.	08/1996	
	AK	5,553,609		Chen et al.	09/1996	
	AL	5,601,435		Quy	02/1997	
	AM	5,626,144		Tacklind et al.	05/1997	
	AN	5,678,562		Sellers	10/1997	
	AO	5,701,904		Simmons et al.	12/1997	
	AP	5,704,366		Tacklind, et al.	01/1998	
	AQ	5,724,025		Tavori	03/1998	
	AR	5,732,709		Tacklind, et al.	03/1998	
	AS	5,735,285		Albert, et al.	04/1998	
	AT	5,752,917		Fuchs	05/1998	
	AU	5,772,586		Heinonen, et al.	06/1998	
	AV	5,791,342		Woodard	09/1998	
	AW	5,931,791		Saltzstein et al.	08/1999	
	AX	5,933,136		Brown	08/1999	
	AY	5,935,060		Iilff	08/1999	
	AZ	5,941,829		Saltzstein et al.	08/1999	
	BA	5,951,300		Brown	09/1999	
	BB	5,959,533		Layson et al.	09/1999	
	BC	5,964,701		Asada, et al.	10/1999	
	BD	5,967,975		Ridgeway, Donald G.	10/1999	
	BE	5,987,352		Klein et al.	11/1999	
	BF	5,987,519		Peifer, et al.	10/1999	
	BG	5,997,476		Brown	12/1999	
	BH	6,022,315		Iilff	02/2000	
	BI	6,024,699		Surwit et al.	02/2000	
	BJ	6,050,940		Braun et al.	04/2000	
	BK	6,055,506		Frasca, Jr.	04/2000	
	BL	6,057,758		Dempsey, et al.	05/2000	

Change(s) applied to document /A.E.M./ 8/6/2012

Change(s) applied to document /A.E.M./ 8/6/2012

Examiner Signature	/Shirley Jian/	Date Considered	07/23/2012
--------------------	----------------	-----------------	------------

<sup>1</sup>EXAMINER: Initial if reference considered, whether or not citation is in conformance with MPEP 608. Draw line through citation if not in conformance and not considered. Include copy of this form with next communication to applicant.  
<sup>2</sup>Unique citation designation number. <sup>3</sup>Applicant is to place a check mark here if English language translation is attached.  
 Burden Hour Statement: This form is estimated to take 2.0 hours to complete. Time will vary depending upon the needs of the individual case. Any comments on the amount of time you are requesting to complete this form should be filed with the Office for Patent Practice, Patent and Trademark Office, Washington, DC 20230.

ALL REFERENCES CONSIDERED EXCEPT WHERE LINED THROUGH. /S.J./

**INFORMATION DISCLOSURE STATEMENT BY APPLICANT**  
 ( Not for submission under 37 CFR 1.99)

Application Number		12211033
Filing Date		2008-09-15
First Named Inventor	Roger J. Quy	
Art Unit	3769	
Examiner Name	Michael C. Astorino	
Attorney Docket Number	00125/002005	

Change(s) applied to document, /A.E.M./ 8/6/2012

U.S. PATENT DOCUMENTS						
Examiner Initials <sup>1</sup>	Cite No. <sup>1</sup>	U.S. Patent Document		Name of Patentee or Applicant of Cited Document	Date of Publication of Cited document MM-DD-YYYY	Pages, Column, Lines, Where Relevant Passages or Relevant Figures Appear
		Number	Kind Code <sup>2</sup> (If known)			
	AA	60,264,739		Posa et al.	01/2001	
	AB	4,282,883		Yerushalmy	08/1981	
	AC	5,012,814		Mills et al.	05/1991	
	AD	5,307,263		Brown	04/1994	
	AE	5,357,427		Langen et al.	10/1994	
	AF	5,434,611		Tamura	07/1995	
	AG	5,441,047		David et al.	08/1995	
	AH	5,544,649		David et al.	08/1996	
	AI	5,544,661		Davis et al.	08/1996	
	AJ	5,549,117		Tacklind et al.	08/1996	
	AK	5,553,609		Chen et al.	09/1996	
	AL	5,601,435		Quy	02/1997	
	AM	5,626,144		Tacklind et al.	05/1997	
	AN	5,678,562		Sellers	10/1997	
	AO	5,701,904		Simmons et al.	12/1997	
	AP	5,704,366		Tacklind, et al	01/1998	
	AQ	5,724,025		Tavori	03/1998	
	AR	5,732,709		Tacklind, et al	03/1998	
	AS	5,735,285		Albert, et al.	04/1998	
	AT	5,752,917		Fuchs	05/1998	
	AU	5,772,586		Heinonen, et al.	06/1998	
	AV	5,791,342		Woodard	09/1998	
	AW	5,931,791		Saltzstein et al.	08/1999	
	AX	5,933,136		Brown	08/1999	
	AY	5,935,060		Iliff	08/1999	
	AZ	5,941,829		Saltzstein et al.	08/1999	
	BA	5,951,300		Brown	09/1999	
	BB	5,959,533		Layson et al.	09/1999	
	BC	5,964,701		Asada, et al.	10/1999	
	BD	5,967,975		Ridgeway, Donald G.	10/1999	
	BE	5,987,352		Klein et al.	11/1999	
	BF	5,987,519		Peifer, et al.	10/1999	
	BG	5,997,476		Brown	12/1999	
	BH	6,022,315		Iliff	02/2000	
	BI	6,024,699		Surwit et al.	02/2000	
	BJ	6,050,940		Braun et al.	04/2000	
	BK	6,055,506		Frasca, Jr.	04/2000	
	BL	6,057,758		Dempsey, et al.	05/2000	

Examiner Signature	/Michael Astorino/	Date Considered	12/22/2009
--------------------	--------------------	-----------------	------------

<sup>1</sup>EXAMINER: Initial if reference considered, whether or not citation is in conformance with MPEP 609. Draw line through citation if not in conformance and not considered. Include copy of this form with next communication to applicant.  
<sup>2</sup>Unique citation designation number. <sup>3</sup>Applicant is to place a check mark here if English language translation is attached.  
 Burden Hour Statement: This form is estimated to take 2.0 hours to complete. Time will vary depending upon the needs of the individual case. Any comments on the amount of time you are required to complete this form should be sent to the Chief Information Officer, Patent and Trademark Office, Washington, DC 20234.  
**ALL REFERENCES CONSIDERED EXCEPT WHERE LINED THROUGH. /MA/**



<b>INFORMATION DISCLOSURE STATEMENT BY APPLICANT</b> (Not for submission under 37 CFR 1.99)	Application Number		12211033
	Filing Date		2008-09-15
	First Named Inventor	Roger J. Quy	
	Art Unit	3769	
	Examiner Name	Michael C. Astorino	
	Attorney Docket Number	00125/002005	

U.S. PATENT DOCUMENTS						
Examiner Initials <sup>1</sup>	Cite No. <sup>1</sup>	U.S. Patent Document		Name of Patentee or Applicant of Cited Document	Date of Publications of Cited document MM-DD-YYYY	Pages, Column, Lines, Where Relevant Passages or Relevant Figures Appear
		Number	Kind Code <sup>2</sup> (if known)			
	BM	6,059,692		Hickman	05/2000	
	BN	6,083,156		Leselicki	07/2000	
	BO	6,101,478		Brown	08/2000	
	BP	6,144,837		Quy	11/2000	
	BQ	6,160,478		Jacobsen et al.	12/2000	
	BR	6,168,563		Brown	01/2001	
	BS	6,190,324		Kieval et al.	02/2001	
	BT	6,266,645		Simpson	07/2001	
	BU	6,319,199		Sheehan et al.	11/2001	
	BV	6,336,900		Alleckson et al.	01/2002	
	BW	6,375,614		Braun et al.	04/2002	
	BX	6,386,882		Lindberg	05/2002	
	BY	6,416,471		Kumar et al.	07/2002	
	BZ	6,418,346		Nelson et al.	07/2002	
	CA	6,440,068		Brown et al.	08/2002	
	CB	6,450,955		Brown et al.	09/2002	
	CC	6,458,080		Brown et al.	10/2002	
	CD	6,529,771		Kieval et al.	03/2003	
	CE	6,602,191		Quy	08/2003	
Change(s) applied to document /D.G./ 8/8/2012	CF	20020016719		Nemeth et al.	02/2002	
	CG	20020019584		Schultze et al.	02/2002	
	CH	20020026223		Riff et al.	02/2002	
	CI	20020072785		Nelson et al.	06/2002	
	CJ	20020082480		Riff et al.	06/2002	
	CK	20020120310		Linden et al.	08/2002	
	CL	20030004554		Riff et al.	01/2003	
	CM	20030072424		Evans et al.	04/2003	
	CN	20030139785		Riff et al.	07/2003	
	CO	20030204413		Riff	10/2003	

FOREIGN PATENT DOCUMENTS								
Examiner Initials <sup>1</sup>	Cite No. <sup>1</sup>	Foreign Patent Document			Name of Patentee or Applicant of Cited Document	Date of Publications of Cited document MM-DD-YYYY	Pages, Column, Lines, Where Relevant Passages or Relevant Figures Appear	Y <sup>3</sup>
		Office <sup>3</sup>	Number <sup>2</sup>	Kind Code <sup>3</sup> (if known)				
			WO 95/32480		ENACT PRODUCTS	11/1995		
	CQ		WO 97/28736		NOKIA MOBILE PHONES LTD	08/1997		

Examiner Signature	/Michael Astorino/	Date Considered	12/22/2009
--------------------	--------------------	-----------------	------------

<sup>1</sup>EXAMINER: Initial if reference considered, whether or not citation is in conformance with MPEP 609. Draw line through citation if not in conformance and not considered. Include copy of this form with next communication to applicant.  
<sup>2</sup>Unique citation designation number. <sup>3</sup>Applicant is to place a check mark here if English language Translation is attached.  
 Burden Hour Statement: This form is estimated to take 2.0 hours to complete. Time will vary depending upon the needs of the individual case. Any comments on the amount of time you are required to complete this form should be sent to the Chief Information Officer, Patent and Trademark Office, Washington, DC 20231.

ALL REFERENCES CONSIDERED EXCEPT WHERE LINED THROUGH. /MA/



## UNITED STATES PATENT AND TRADEMARK OFFICE

UNITED STATES DEPARTMENT OF COMMERCE  
 United States Patent and Trademark Office  
 Address: COMMISSIONER FOR PATENTS  
 P.O. Box 1450  
 Alexandria, Virginia 22313-1450  
 www.uspto.gov

APPLICATION NO.	ISSUE DATE	PATENT NO.	ATTORNEY DOCKET NO.	CONFIRMATION NO.
12/211,033	10/02/2012	8277377	00125/002005	7693

27774                      7590                      09/12/2012  
 MAYER & WILLIAMS PC  
 251 NORTH AVENUE WEST  
 Suite 201  
 WESTFIELD, NJ 07090

## ISSUE NOTIFICATION

The projected patent number and issue date are specified above.

### Determination of Patent Term Adjustment under 35 U.S.C. 154 (b) (application filed on or after May 29, 2000)

The Patent Term Adjustment is 32 day(s). Any patent to issue from the above-identified application will include an indication of the adjustment on the front page.

If a Continued Prosecution Application (CPA) was filed in the above-identified application, the filing date that determines Patent Term Adjustment is the filing date of the most recent CPA.

Applicant will be able to obtain more detailed information by accessing the Patent Application Information Retrieval (PAIR) WEB site (<http://pair.uspto.gov>).

Any questions regarding the Patent Term Extension or Adjustment determination should be directed to the Office of Patent Legal Administration at (571)-272-7702. Questions relating to issue and publication fee payments should be directed to the Application Assistance Unit (AAU) of the Office of Data Management (ODM) at (571)-272-4200.

APPLICANT(s) (Please see PAIR WEB site <http://pair.uspto.gov> for additional applicants):

Roger J. Quy, Mill Valley, CA;

The United States represents the largest, most dynamic marketplace in the world and is an unparalleled location for business investment, innovation, and commercialization of new technologies. The USA offers tremendous resources and advantages for those who invest and manufacture goods here. Through SelectUSA, our nation works to encourage and facilitate business investment. To learn more about why the USA is the best country in the world to develop technology, manufacture products, and grow your business, visit [SelectUSA.gov](http://SelectUSA.gov).

Under the Paperwork Reduction Act of 1995, no persons are required to respond to a collection of information unless it displays a valid OMB control number.

**POWER OF ATTORNEY TO PROSECUTE APPLICATIONS BEFORE THE USPTO**

I hereby revoke all previous powers of attorney given in the application identified in the attached statement under 37 CFR 3.73(c).

I hereby appoint:

Practitioners associated with Customer Number: 24737

**OR**

Practitioner(s) named below (if more than ten patent practitioners are to be named, then a customer number must be used):

Name	Registration Number

Name	Registration Number

As attorney(s) or agent(s) to represent the undersigned before the United States Patent and Trademark Office (USPTO) in connection with any and all patent applications assigned only to the undersigned according to the USPTO assignment records or assignments documents attached to this form in accordance with 37 CFR 3.73(c).

Please change the correspondence address for the application identified in the attached statement under 37 CFR 3.73(c) to:

The address associated with Customer Number: 24737

**OR**

	Firm or Individual Name			
	Address			
	City	State	Zip	
	Country			
	Telephone	Email		

Assignee Name and Address: Koninklijke Philips N.V.  
High Tech Campus 5  
Eindhoven, 5656 AE, NL

**A copy of this form, together with a statement under 37 CFR 3.73(c) (Form PTO/AIA/96 or equivalent) is required to be Filed in each application in which this form is used. The statement under 37 CFR 3.73(c) may be completed by one of The practitioners appointed in this form, and must identify the application in which this Power of Attorney is to be filed.**

**SIGNATURE of Assignee of Record**  
The individual whose signature and title is supplied below is authorized to act on behalf of the assignee

Signature	/Michael E. Marion/	Date August 3, 2016
Name	Michael E. Marion	Telephone 914-495
Title	Authorized Signatory of Koninklijke Philips N.V.	

This collection of information is required by 37 CFR 1.31, 1.32 and 1.33. The information is required to obtain or retain a benefit by the public which is to file (and by the USPTO to process) an application. Confidentiality is governed by 35 U.S.C. 122 and 37 CFR 1.11 and 1.14. This collection is estimated to take 3 minutes to complete, including gathering, preparing, and submitting the completed application form to the USPTO. Time will vary depending upon the individual case. Any comments on the amount of time you require to complete this form and/or suggestions for reducing this burden, should be sent to the Chief Information Officer, U.S. Patent and Trademark Office, U.S. Department of Commerce, P.O. Box 1450, Alexandria, VA 22313-1450. DO NOT SEND FEES OR COMPLETED FORMS TO THIS ADDRESS. SEND TO: Commissioner for Patents, P.O. Box 1450, Alexandria, VA 22313-1450.

If you need assistance in completing the form, call 1-800-PTO-9199 and select option 2.

Under the Paperwork Reduction Act of 1995, no persons are required to respond to a collection of information unless it displays a valid OMB control number.

**STATEMENT UNDER 37 CFR 3.73(c)**

Applicant/Patent Owner: KONINKLIJKE PHILIPS N.V.

Application No./Patent No.: 8277377 Filed/Issue Date: October 2, 2012

Titled: METHOD AND APPARATUS FOR MONITORING EXERCISE WITH WIRELESS INTERNET CONNECTIVITY  
KONINKLIJKE PHILIPS N.V., a CORPORATION

(Name of Assignee) (Type of Assignee, e.g., corporation, partnership, university, government agency, etc.)

states that, for the patent application/patent identified above, it is (choose **one** of options 1, 2, 3 or 4 below):

- 1.  The assignee of the entire right, title, and interest.
- 2.  An assignee of less than the entire right, title, and interest (check applicable box):
  - The extent (by percentage) of its ownership interest is \_\_\_\_\_%. Additional Statement(s) by the owners holding the balance of the interest must be submitted to account for 100% of the ownership interest.
  - There are unspecified percentages of ownership. The other parties, including inventors, who together own the entire right, title and interest are:

Additional Statement(s) by the owner(s) holding the balance of the interest must be submitted to account for the entire right, title, and interest.

- 3.  The assignee of an undivided interest in the entirety (a complete assignment from one of the joint inventors was made). The other parties, including inventors, who together own the entire right, title, and interest are:

Additional Statement(s) by the owner(s) holding the balance of the interest must be submitted to account for the entire right, title, and interest.

- 4.  The recipient, via a court proceeding or the like (e.g., bankruptcy, probate), of an undivided interest in the entirety (a complete transfer of ownership interest was made). The certified document(s) showing the transfer is attached.

The interest identified in option 1, 2 or 3 above (not option 4) is evidenced by either (choose **one** of options A or B below):

- A.  An assignment from the inventor(s) of the patent application/patent identified above. The assignment was recorded in the United States Patent and Trademark Office at Reel \_\_\_\_\_, Frame \_\_\_\_\_, or for which a copy thereof is attached.
- B.  A chain of title from the inventor(s), of the patent application/patent identified above, to the current assignee as follows:

1. From: ROGER J. QUY To: Q-TEC SYSTEMS LLC

The document was recorded in the United States Patent and Trademark Office at Reel 022282, Frame 0264, or for which a copy thereof is attached.

2. From: Q-TEC SYSTEMS LLC To: KONINKLIJKE PHILIPS N.V.

The document was recorded in the United States Patent and Trademark Office at Reel 039196, Frame 0451, or for which a copy thereof is attached.

This collection of information is required by 37 CFR 3.73(b). The information is required to obtain or retain a benefit by the public which is to file (and by the USPTO to process) an application. Confidentiality is governed by 35 U.S.C. 122 and 37 CFR 1.11 and 1.14. This collection is estimated to take 12 minutes to complete, including gathering, preparing, and submitting the completed application form to the USPTO. Time will vary depending upon the individual case. Any comments on the amount of time you require to complete this form and/or suggestions for reducing this burden, should be sent to the Chief Information Officer, U.S. Patent and Trademark Office, U.S. Department of Commerce, P.O. Box 1450, Alexandria, VA 22313-1450. DO NOT SEND FEES OR COMPLETED FORMS TO THIS ADDRESS. **SEND TO: Commissioner for Patents, P.O. Box 1450, Alexandria, VA 22313-1450.**

*If you need assistance in completing the form, call 1-800-PTO-9199 and select option 2.*

Under the Paperwork Reduction Act of 1995, no persons are required to respond to a collection of information unless it displays a valid OMB control number.

**STATEMENT UNDER 37 CFR 3.73(c)**

3. From: \_\_\_\_\_ To: \_\_\_\_\_

The document was recorded in the United States Patent and Trademark Office at  
Reel \_\_\_\_\_, Frame \_\_\_\_\_, or for which a copy thereof is attached.

4. From: \_\_\_\_\_ To: \_\_\_\_\_

The document was recorded in the United States Patent and Trademark Office at  
Reel \_\_\_\_\_, Frame \_\_\_\_\_, or for which a copy thereof is attached.

5. From: \_\_\_\_\_ To: \_\_\_\_\_

The document was recorded in the United States Patent and Trademark Office at  
Reel \_\_\_\_\_, Frame \_\_\_\_\_, or for which a copy thereof is attached.

6. From: \_\_\_\_\_ To: \_\_\_\_\_

The document was recorded in the United States Patent and Trademark Office at  
Reel \_\_\_\_\_, Frame \_\_\_\_\_, or for which a copy thereof is attached.

Additional documents in the chain of title are listed on a supplemental sheet(s).

As required by 37 CFR 3.73(c)(1)(i), the documentary evidence of the chain of title from the original owner to the assignee was, or concurrently is being, submitted for recordation pursuant to 37 CFR 3.11.

[NOTE: A separate copy (i.e., a true copy of the original assignment document(s)) must be submitted to Assignment Division in accordance with 37 CFR Part 3, to record the assignment in the records of the USPTO. See MPEP 302.08]

The undersigned (whose title is supplied below) is authorized to act on behalf of the assignee.

/Michael E. Marion/

August 3, 2016

Signature

Date

Michael E. Marion

Authorized Signatory of Koninklijke Philips N.V.

Printed or Typed Name

Title or Registration Number

**Electronic Acknowledgement Receipt**

<b>EFS ID:</b>	26529723
<b>Application Number:</b>	12211033
<b>International Application Number:</b>	
<b>Confirmation Number:</b>	7693
<b>Title of Invention:</b>	METHOD AND APPARATUS FOR MONITORING EXERCISE WITH WIRELESS INTERNET CONNECTIVITY
<b>First Named Inventor/Applicant Name:</b>	Roger J. Quy
<b>Customer Number:</b>	27774
<b>Filer:</b>	Michael E. Marion/Patti DeMichele
<b>Filer Authorized By:</b>	Michael E. Marion
<b>Attorney Docket Number:</b>	00125/002005
<b>Receipt Date:</b>	03-AUG-2016
<b>Filing Date:</b>	15-SEP-2008
<b>Time Stamp:</b>	09:48:05
<b>Application Type:</b>	Utility under 35 USC 111(a)

**Payment information:**

Submitted with Payment	no
------------------------	----

**File Listing:**

Document Number	Document Description	File Name	File Size(Bytes)/ Message Digest	Multi Part /.zip	Pages (if appl.)
1	Power of Attorney	POA.pdf	50683 80817b32c72ff1cd570f881c928994b6f3b0bea7	no	1

**Warnings:**

<b>Information:</b>					
2	Assignee showing of ownership per 37 CFR 3.73	1999P01960US05_373STATEMENT.pdf	66968	no	2
			6abc7d73e271a83ced089dcef69c05322e7a5f49		

**Warnings:**

**Information:**

<b>Total Files Size (in bytes):</b>	117651
-------------------------------------	--------

**This Acknowledgement Receipt evidences receipt on the noted date by the USPTO of the indicated documents, characterized by the applicant, and including page counts, where applicable. It serves as evidence of receipt similar to a Post Card, as described in MPEP 503.**

**New Applications Under 35 U.S.C. 111**

**If a new application is being filed and the application includes the necessary components for a filing date (see 37 CFR 1.53(b)-(d) and MPEP 506), a Filing Receipt (37 CFR 1.54) will be issued in due course and the date shown on this Acknowledgement Receipt will establish the filing date of the application.**

**National Stage of an International Application under 35 U.S.C. 371**

**If a timely submission to enter the national stage of an international application is compliant with the conditions of 35 U.S.C. 371 and other applicable requirements a Form PCT/DO/EO/903 indicating acceptance of the application as a national stage submission under 35 U.S.C. 371 will be issued in addition to the Filing Receipt, in due course.**

**New International Application Filed with the USPTO as a Receiving Office**

**If a new international application is being filed and the international application includes the necessary components for an international filing date (see PCT Article 11 and MPEP 1810), a Notification of the International Application Number and of the International Filing Date (Form PCT/RO/105) will be issued in due course, subject to prescriptions concerning national security, and the date shown on this Acknowledgement Receipt will establish the international filing date of the application.**



UNITED STATES PATENT AND TRADEMARK OFFICE

UNITED STATES DEPARTMENT OF COMMERCE  
United States Patent and Trademark Office  
Address: COMMISSIONER FOR PATENTS  
P.O. Box 1450  
Alexandria, Virginia 22313-1450  
www.uspto.gov

APPLICATION NUMBER	FILING OR 371(C) DATE	FIRST NAMED APPLICANT	ATTY. DOCKET NO./TITLE
12/211,033	09/15/2008	Roger J. Quy	00125/002005

**CONFIRMATION NO. 7693**

**POA ACCEPTANCE LETTER**



24737  
PHILIPS INTELLECTUAL PROPERTY & STANDARDS  
465 Columbus Avenue  
Suite 340  
Valhalla, NY 10595

Date Mailed: 08/15/2016

**NOTICE OF ACCEPTANCE OF POWER OF ATTORNEY**

This is in response to the Power of Attorney filed 08/03/2016.

The Power of Attorney in this application is accepted. Correspondence in this application will be mailed to the above address as provided by 37 CFR 1.33.

Questions about the contents of this notice and the requirements it sets forth should be directed to the Office of Data Management, Application Assistance Unit, at (571) 272-4000 or (571) 272-4200 or 1-888-786-0101.

/agizaw/





UNITED STATES PATENT AND TRADEMARK OFFICE

UNITED STATES DEPARTMENT OF COMMERCE  
United States Patent and Trademark Office  
Address: COMMISSIONER FOR PATENTS  
P.O. Box 1450  
Alexandria, Virginia 22313-1450  
www.uspto.gov

APPLICATION NUMBER	FILING OR 371(C) DATE	FIRST NAMED APPLICANT	ATTY. DOCKET NO./TITLE
12/211,033	09/15/2008	Roger J. Quy	00125/002005

**CONFIRMATION NO. 7693**

**POWER OF ATTORNEY NOTICE**



27774  
MAYER & WILLIAMS PC  
928 Mountain Avenue  
Second Floor  
Moutainside, NJ 07092

Date Mailed: 08/15/2016

**NOTICE REGARDING CHANGE OF POWER OF ATTORNEY**

This is in response to the Power of Attorney filed 08/03/2016.

- The Power of Attorney to you in this application has been revoked by the assignee who has intervned as provided by 37 CFR 3.71. Future correspondence will be mailed to the new address of record(37 CFR 1.33).

Questions about the contents of this notice and the requirements it sets forth should be directed to the Office of Data Management, Application Assistance Unit, at (571) 272-4000 or (571) 272-4200 or 1-888-786-0101.

/agizaw/

**UNITED STATES PATENT AND TRADEMARK OFFICE**

UNITED STATES DEPARTMENT OF COMMERCE  
**United States Patent and Trademark Office**  
 Address: COMMISSIONER FOR PATENTS  
 P.O. Box 1450  
 Alexandria, Virginia 22313-1450  
 www.uspto.gov

APPLICATION NUMBER	FILING OR 371(C) DATE	FIRST NAMED APPLICANT	ATTY. DOCKET NO./TITLE	REQUEST ID
12/211,033	09/15/2008	Roger J. Quy	00125/002005	25670

**Acknowledgement of Loss of Entitlement to Entity Status Discount**

The entity status change request below filed through Private PAIR on 09/28/2016 has been accepted.

**CERTIFICATIONS:**
**Change of Entity Status:**

Applicant changing to regular undiscounted fee status.

NOTE: Checking this box will be taken to be notification of loss of entitlement to small or micro entity status, as applicable.

This portion must be completed by the signatory or signatories making the entity status change in accordance with 37 CFR 1.4(d)(4).

<b>Signature:</b>	/William J. McNamara/
<b>Name:</b>	William J. McNamara
<b>Registration Number:</b>	63283

AO 120 (Rev. 08/10)

<b>TO:</b> Mail Stop 8 Director of the U.S. Patent and Trademark Office P.O. Box 1450 Alexandria, VA 22313-1450	<b>REPORT ON THE                  FILING OR DETERMINATION OF AN                  ACTION REGARDING A PATENT OR                  TRADEMARK</b>
---	--

In Compliance with 35 U.S.C. § 290 and/or 15 U.S.C. § 1116 you are hereby advised that a court action has been filed in the U.S. District Court MASSACHUSETTS on the following

Trademarks or  Patents. (  the patent action involves 35 U.S.C. § 292.):

DOCKET NO.	DATE FILED 7/22/2019	U.S. DISTRICT COURT MASSACHUSETTS
PLAINTIFF Philips North America LLC		DEFENDANT Fitbit, Inc.
PATENT OR TRADEMARK NO.	DATE OF PATENT OR TRADEMARK	HOLDER OF PATENT OR TRADEMARK
1 6,013,007	1/11/2000	Philips North America LLC
2 6,976,958	12/20/2005	Philips North America LLC
3 7,088,233	8/8/2006	Philips North America LLC
4 8,277,377	10/2/2012	Philips North America LLC
5		

In the above—entitled case, the following patent(s)/ trademark(s) have been included:

DATE INCLUDED	INCLUDED BY <input type="checkbox"/> Amendment <input type="checkbox"/> Answer <input type="checkbox"/> Cross Bill <input type="checkbox"/> Other Pleading		
PATENT OR TRADEMARK NO.	DATE OF PATENT OR TRADEMARK	HOLDER OF PATENT OR TRADEMARK	
1			
2			
3			
4			
5			

In the above—entitled case, the following decision has been rendered or judgement issued:

DECISION/JUDGEMENT
--------------------

CLERK	(BY) DEPUTY CLERK	DATE
-------	-------------------	------

Copy 1—Upon initiation of action, mail this copy to Director    Copy 3—Upon termination of action, mail this copy to Director  
 Copy 2—Upon filing document adding patent(s), mail this copy to Director    Copy 4—Case file copy