

Exhibit 1
REDACTED VERSION
OF ECF No. 78-1

1 BAKER BOTTS L.L.P.
Jeremy J. Taylor (SBN 249075)
2 jeremy.taylor@bakerbotts.com
Arya Moshiri (SBN 324231)
3 arya.moshiri@bakerbotts.com
101 California St., Ste. 3600
4 San Francisco, CA 94111
Telephone: 415.291.6200
5 Facsimile: 415.291.6300

6 Bethany R. Salpietra (*pro hac vice pending*)
bethany.salpietra@bakerbotts.com
7 2001 Ross Ave., Ste. 900
Dallas, TX 75201
8 Telephone: 214.953.6500
Facsimile: 214.953.6503

9 *Attorneys for Plaintiff*

10 **UNITED STATES DISTRICT COURT**
11 **NORTHERN DISTRICT OF CALIFORNIA**

12 LYFT, INC.

13 Plaintiffs,

14 v.

15 AGIS SOFTWARE DEVELOPMENT LLC,
16 ADVANCED GROUND INFORMATION
17 SYSTEMS, INC., AGIS HOLDINGS, INC.,
MALCOM K. BEYER, JR.

18 Defendants.

Case No. 21-cv-4653

**FIRST AMENDED COMPLAINT FOR
DECLARATORY JUDGMENT**

FILED UNDER SEAL

JURY TRIAL DEMANDED

19
20 Plaintiff Lyft, Inc. (“Lyft”) hereby pleads the following claims for Declaratory Judgment
21 against Defendants AGIS Software Development LLC (“AGIS Software”), Advanced Ground
22 Information Systems, Inc. (“AGIS, Inc.”), AGIS Holdings, Inc. (“AGIS Holdings”), and Malcolm
23 K. Beyer, Jr. (“Beyer”) (collectively “AGIS”) and alleges as follows:
24

25 **THE PARTIES**

26 1. Lyft is a Delaware corporation with its principal place of business located at 185
27 Berry Street, Suite 5000, San Francisco, California 94107.
28

1 importing into the United States the “the Lyft and Lyft Driver applications and the related services
2 and/or servers for the applications.” *See AGIS Software Development LLC v. Lyft, Inc.*, Civil Action
3 No. 2:21-cv-00024-JRG (E.D. Tex.), Dkt. 1 at ¶ 23.

4 15. On April 27, 2021 Lyft moved to dismiss the Eastern District of Texas litigation for
5 improper venue. *See AGIS Software Development LLC v. T-Mobile USA, Inc. et al.*, Civil Action
6 No. 2:21-cv-00072-JRG (E.D. Tex.), Dkt. 30.

7 16. On November 10, 2021, Magistrate Judge Payne issued a Report and
8 Recommendation that Lyft’s motion to dismiss be granted. *See AGIS Software Development LLC*
9 *v. T-Mobile USA, Inc. et al.*, Civil Action No. 2:21-cv-00072-JRG (E.D. Tex.), Dkt. 212.

10 17. On January 19, 2022, the Court adopted the Magistrate’s Report and
11 Recommendation and directed the clerk of the Court to close the case. *See AGIS Software*
12 *Development LLC v. T-Mobile USA, Inc. et al.*, Civil Action No. 2:21-cv-00072-JRG (E.D. Tex.),
13 Dkt. 334.

14 **B. Lyft seeks a declaratory judgment that it does not infringe the Patents-in-Suit**

15 18. Lyft denies that the Patents-in-Suit have been or currently are infringed through the
16 making, using, distributing, sale, offering for sale, exportation, or importation of the Lyft or Lyft
17 Driver applications and any related services and/or servers for the applications.

18 19. AGIS Software’s infringement allegations and related actions threaten actual and
19 imminent injury to Lyft that can be redressed by judicial relief and warrants the issue of a declaratory
20 judgment, under the Federal Declaratory Judgment Act, 28 U.S.C. §§ 2201 *et seq.*

21 20. An actual and justiciable controversy with respect to the Patents-in-Suit exists
22 between Lyft and AGIS Software and between Lyft and AGIS, Inc., AGIS Holdings, and/or
23 Malcolm K. Beyer, Jr. under an alter ego theory.

24 **C. AGIS Software is subject to the specific jurisdiction of this Court**

25 21. AGIS Software, AGIS, Inc., AGIS Holdings, and/or Malcom K. Beyer, Jr. are subject
26 to this Court’s specific jurisdiction, pursuant to due process and/or the California Long Arm Statute
27 due to: (1) AGIS Software, AGIS, Inc., AGIS Holdings, and/or Malcom K. Beyer, Jr. purposefully
28 directing activities at residents of this forum, and (2) the claims arising out of or relating to these

1 activities of AGIS Software, AGIS, Inc., AGIS Holdings, and/or Malcom K. Beyer, Jr. Further, the
2 assertions of personal jurisdiction are reasonable and fair.

3 i. **AGIS Software purposefully directed its patent licensing activities to California**
4 **companies subjecting it to specific jurisdiction under *Trimble***

5 22. AGIS Software is a patent licensing company that licenses its patent portfolio,
6 including the Patents-in-Suit.

7 23. AGIS Software has no employees.

8 24. AGIS Software develops software related to the Patents-in-Suit.

9 25. Software developed by AGIS Software is both used inside and outside the United
10 States.

11 26. On information and belief, software developed by AGIS Software related to the
12 Patents-in-Suit is used within California. Lyft attempted to confirm this information from AGIS
13 Software via an interrogatory (i.e., Jurisdictional Interrogatory No. 1), but AGIS Software has
14 refused to provide it. Lyft also sought to confirm this information at the deposition of AGIS
15 Software, however, its designated witness, Thomas Meriam, was unable to confirm it.

16 27. AGIS Software's principal source of revenue is from patent licenses with California
17 companies and other companies operating in the State of California.

18 28. AGIS Software or its predecessor-in-interest has taken purposeful steps to enforce
19 the Patents-in-Suit and/or obtain licenses to the Patents-in-Suit and/or related patents with
20 companies having principal places of business and operations in this judicial district, including Lyft,
21 Google LLC ("Google"), Apple Inc. ("Apple"), WhatsApp LLC ("WhatsApp"), Facebook, Inc.
22 ("Facebook"), Uber Technologies, Inc. d/b/a UBER ("Uber"), Life360, Inc. ("Life360"), and with
23 companies or their affiliates having operations and offices in the State of California, including ZTE
24 (USA) Inc. ("ZTE"), Waze LLC ("Waze"), HTC Corporation ("HTC"), T-Mobile US, Inc. ("T-
25 Mobile"), Huawei Device USA Inc. ("Huawei"), LG Electronics, Inc. ("LG"), and Samsung
26 Electronics America, Inc ("Samsung").

27 29. On information and belief, AGIS Software or its predecessor-in-interest has taken
28 purposeful steps to enforce the Patents-in-Suit and/or obtain licenses to the Patents-in-Suit and/or

1 related patents with Smith Micro Software (“Smith Micro”), a company having operations and
2 offices in the State of California. Lyft attempted to confirm this information from AGIS Software
3 via an interrogatory (i.e., Jurisdictional Interrogatory No. 1), but AGIS Software has refused to
4 provide it. Lyft also sought to confirm this information at the deposition of AGIS Software,
5 however, its designated witness, Thomas Meriam, was unable to confirm it. On information and
6 belief, this information could have also been confirmed had AGIS Software complied with its
7 obligations under Patent L.R. 3-2 to produce “all agreements, including licenses, transferring an
8 interest in any patent-in-suit.” But AGIS Software has not produced all such agreements despite a
9 specific request by Lyft that AGIS Software do so.

10 30. AGIS Software or its predecessor-in-interest alleged infringement of the Patents-in-
11 Suit and/or related patents through communications directed at companies with principal places of
12 business in this judicial district, including Google, Facebook, and Life360.

13 31. AGIS Software or its predecessor-in-interest enforced the Patents-in-Suit and/or
14 related patents against companies with principal places of business in this judicial district, including
15 Lyft, Google, Apple, WhatsApp, Uber, Life360, and against companies or their affiliates having
16 operations and offices in the State of California, including ZTE, Waze, HTC, T-Mobile, Huawei,
17 LG, and Samsung.

18 32. [REDACTED]
19 [REDACTED]
20 [REDACTED]
21 [REDACTED]
22 [REDACTED]

23 33. On information and belief, AGIS Software negotiated a license agreement involving
24 the Patents-in-Suit and/or related patents through communications with Smith Micro, a company
25 having operations and offices in the State of California. Lyft attempted to confirm this information
26 from AGIS Software via an interrogatory (i.e., Jurisdictional Interrogatory No. 1), but AGIS
27 Software has refused to provide it. Lyft also sought to confirm this information at the deposition of
28 AGIS Software, however, its designated witness, Thomas Meriam, was unable to confirm it. On

1 information and belief, this information could have also been confirmed had AGIS Software
2 complied with its obligations under Patent L.R. 3-2 to produce “all agreements, including licenses,
3 transferring an interest in any patent-in-suit.” But AGIS Software has not produced all such
4 agreements despite a specific request by Lyft that AGIS Software do so.

5 34. On information and belief, AGIS Software or its predecessor-in-interest have
6 negotiated and communicated with Google, Waze, and Samsung in an attempt to enter into license
7 agreements for the Patents-in-Suit and/or related patents. Lyft requested this information from
8 AGIS Software via an interrogatory (i.e., Jurisdictional Interrogatory No. 1), but AGIS Software
9 has refused to provide it. Lyft also sought to confirm this information at the deposition of AGIS
10 Software, however, its designated witness, Thomas Meriam, was unable to confirm it.

11 35. AGIS Software’s communications, including through telephone, mail, and/or other
12 means, with companies having principal places of business, offices, and/or operations in the State
13 of California to enforce and to negotiate licenses the Patents-in-Suit and/or related patents creates
14 specific personal jurisdiction over AGIS Software. *See Trimble Inc. v. PerDiemCo LLC*, 997 F.3d
15 1147, 1155 (Fed. Cir. 2021).

16 36. AGIS Software’s non-exclusive licenses to the Patents-in-Suit with companies
17 having principal places of business, offices, and operations in the State of California are sufficiently
18 related to this declaratory judgment action concerning the same patents to support a finding of
19 specific jurisdiction. *Id.* at 1156.

20 **a. AGIS Entities’ patent license with Apple and related negotiations**

21 37. On June 21, 2017, AGIS Software sued Apple, a California corporation with its
22 principal place of business in this District in Cupertino, California, alleging infringement of the ’970
23 Patent, one of the Patents-in-Suit, and other patents related to the Patents-In-Suit. *See AGIS Software*
24 *Development LLC v. Apple Inc.*, Civil Action No. 2:17-cv-00516 (E.D. Tex.), Dkt. 1 at ¶¶ 6-9, 18,
25 27, 41, 55.

26 38. On information and belief, Apple currently has or previously had headquarters at 1
27 Apple Park Way Cupertino, California 95014.

28

1 39. On information and belief, in or around March 2019, AGIS Software, AGIS, Inc.,
2 AGIS Holdings, and/or Malcom K. Beyer, Jr. (collectively, “AGIS Entities”) entered into a license
3 agreement with Apple (“Apple License”) covering all patents and patent applications assigned to,
4 owned by, or controlled by the AGIS Entities, including the Patents-in-Suit. On information and
5 belief, this information could have been confirmed had AGIS Software complied with its obligations
6 under Patent L.R. 3-2 to produce “all agreements, including licenses, transferring an interest in any
7 patent-in-suit.” But AGIS Software has not produced all such agreements despite a specific request
8 by Lyft that AGIS Software do so.

9 40. On information and belief, AGIS Software negotiated, including through numerous
10 written email and/or other communications, with Apple to obtain the Apple License. Lyft requested
11 this information from AGIS Software via an interrogatory (i.e., Jurisdictional Interrogatory No. 1),
12 but AGIS Software has refused to provide it. Lyft also sought to confirm this information at the
13 deposition of AGIS Software, however, its designated witness, Thomas Meriam, was unable to
14 confirm it.

15 **b. AGIS Software’s patent license with Huawei and related negotiations**

16 41. On June 21, 2017, AGIS Software sued Huawei Device USA Inc., Huawei
17 Technologies USA Inc., and Huawei Technologies Co., Ltd. alleging infringement of patents,
18 including the ’970 Patent, one of the Patents-in-Suit. *AGIS Software Development LLC v. Huawei*
19 *Device USA Inc.*, Civil Action No. 2:17-cv-00513 (E.D. Tex.), Dkt. 1 at ¶¶ 8-11, 20, 29, 42, 55.

20 42. On August 17, 2017, AGIS Software filed an amended complaint, adding Huawei
21 Device (Dongguan) Co., Ltd. as a defendant.

22 43. On information and belief, Huawei currently has or previously had an affiliate office
23 in California.

24 44. On information and belief, in or around March 2019, AGIS Software entered into a
25 license agreement with Huawei (“Huawei License”) covering all patents and patent applications
26 owned or controlled by AGIS Software or its affiliates. On information and belief, this information
27 could have been confirmed had AGIS Software complied with its obligations under Patent L.R. 3-
28 2 to produce “all agreements, including licenses, transferring an interest in any patent-in-suit.” But

1 AGIS Software has not produced all such agreements despite a specific request by Lyft that AGIS
2 Software do so.

3 45. On information and belief, AGIS Software negotiated, including through numerous
4 written email and/or other communications, with Huawei to obtain the Huawei License. Lyft
5 requested this information from AGIS Software via an interrogatory (i.e., Jurisdictional
6 Interrogatory No. 1), but AGIS Software has refused to provide it. Lyft also sought to confirm this
7 information at the deposition of AGIS Software, however, its designated witness, Thomas Meriam,
8 was unable to confirm it.

9 **c. AGIS Software patent license with HTC and related negotiations**

10 46. On June 21, 2017, AGIS Software sued HTC Corporation alleging infringement of
11 patents, including the '970 Patent, one of the Patents-in-Suit. *AGIS Software Development LLC v.*
12 *HTC Corporation*, Civil Action No. 2:17-cv-00514 (E.D. Tex.), Dkt. 1 at ¶¶ 6-9, 18, 27, 40, 53.

13 47. On information and belief, HTC currently has or previously had an affiliate office in
14 California.

15 48. On information and belief, in or around July of 2019, AGIS Software entered into a
16 license agreement with HTC (“HTC License”) covering all patents and patent applications owned
17 or controlled by AGIS Software or its affiliates. On information and belief, this information could
18 have been confirmed had AGIS Software complied with its obligations under Patent L.R. 3-2
19 to produce “all agreements, including licenses, transferring an interest in any patent-in-suit.” But
20 AGIS Software has not produced all such agreements despite a specific request by Lyft that AGIS
21 Software do so.

22 49. On information and belief, AGIS Software negotiated, including through numerous
23 written email and/or other communications, with HTC to obtain the HTC License. Lyft requested
24 this information from AGIS Software via an interrogatory (i.e., Jurisdictional Interrogatory No. 1),
25 but AGIS Software has refused to provide it. Lyft also sought to confirm this information at the
26 deposition of AGIS Software, however, its designated witness, Thomas Meriam, was unable to
27 confirm it.

28 **d. AGIS Software patent license with LG and related negotiations**

1 50. On June 21, 2017, AGIS Software sued LG Electronics, Inc. alleging infringement
2 of patents, including the '970 Patent, one of the Patents-in-Suit. *AGIS Software Development LLC*
3 *v. LG Electronics, Inc.*, Civil Action No. 2:17-cv-00515 (E.D. Tex.), Dkt. 1, ¶¶ 6-9, 18, 27, 40, 53.

4 51. On information and belief, LG currently has or previously had an affiliate office in
5 California.

6 52. On information and belief, in or around July 2019, AGIS Software entered into a
7 license agreement with LG (“LG License”) covering all patents and patent applications owned or
8 controlled by AGIS Software or its affiliates. On information and belief, this information could
9 have been confirmed had AGIS Software complied with its obligations under Patent L.R. 3-2 to
10 produce “all agreements, including licenses, transferring an interest in any patent-in-suit.” But
11 AGIS Software has not produced all such agreements despite a specific request by Lyft that AGIS
12 Software do so.

13 53. On information and belief, AGIS Software negotiated, including through numerous
14 written email and/or other communications, with LG to obtain the LG License. Lyft requested this
15 information from AGIS Software via an interrogatory (i.e., Jurisdictional Interrogatory No. 1), but
16 AGIS Software has refused to provide it. Lyft also sought to confirm this information at the
17 deposition of AGIS Software, however, its designated witness, Thomas Meriam, was unable to
18 confirm it.

19 **e. AGIS Software patent license with ZTE and related negotiations**

20 54. On June 21, 2017, AGIS Software sued ZTE Corporation and ZTE (TX) Inc. alleging
21 infringement of patents, including the '970 Patent, one of the Patents-in-Suit. *AGIS Software*
22 *Development LLC v. ZTE Corporation et al.*, Civil Action No. 2:17-cv-00517-JRG (E.D. Tex.), Dkt.
23 1 at ¶¶ 7-10, 19, 28, 41 54.

24 55. On October 17, 2017, AGIS Software filed an amended complaint, adding ZTE
25 (USA) Inc. as a defendant to this litigation and alleging infringement of an additional related patent,
26 the '829 patent. *AGIS Software Development LLC v. ZTE Corporation et al.*, Civil Action No. 2:17-
27 v-00517-JRG (E.D. Tex.), Dkt. 32 at ¶¶ 3 & 73.

28

1 56. On information and belief, ZTE or a ZTE affiliate currently has or previously had an
2 office located in California.

3 57. On information and belief, in or around October 2019, AGIS Software entered into
4 a license agreement with ZTE (“ZTE License”) covering all patents and patent applications owned
5 or controlled by AGIS Software or its affiliates. On information and belief, this information could
6 have been confirmed had AGIS Software complied with its obligations under Patent L.R. 3-2 to
7 produce “all agreements, including licenses, transferring an interest in any patent-in-suit.” But
8 AGIS Software has not produced all such agreements despite a specific request by Lyft that AGIS
9 Software do so.

10 58. On information and belief, AGIS Software negotiated, including through numerous
11 written email and/or other communications, with ZTE to obtain the ZTE License. Lyft requested
12 this information from AGIS Software via an interrogatory (i.e., Jurisdictional Interrogatory No. 1),
13 but AGIS Software has refused to provide it. Lyft also sought to confirm this information at the
14 deposition of AGIS Software, however, its designated witness, Thomas Meriam, was unable to
15 confirm it.

16 **f. AGIS Software patent license with WhatsApp and Facebook and related**
17 **negotiations**

18 59. On January 29, 2021, AGIS Software sued WhatsApp, a corporation having its
19 principal place of business in this District in Menlo Park, California, alleging infringement of the
20 ’728 Patent and ’724 Patent, two of the Patent-in-Suit, and alleging infringement of other patents
21 related to the Patents-In-Suit. *See AGIS Software Development LLC v. WhatsApp, Inc.*, Civil Action
22 No. 2:21-cv-00029 (E.D. Tex.), Dkt. 1 at ¶¶ 7-12, 21, 40, 59, 78, 97, 116.

23 60. On information and belief, WhatsApp currently has or previously had an office in
24 California.

25 61. In or around September 2021, AGIS Software entered into a license agreement with
26 WhatsApp and Facebook (“WhatsApp/Facebook License”) covering all patents and patent
27 applications held or controlled by AGIS Software, including the Patents-in-Suit.

28

1 62. On information and belief, Facebook currently has or previously had an office in
2 California.

3 63. On information and belief, AGIS Software negotiated, including through numerous
4 written email and/or other communications, with WhatsApp and/or Facebook to obtain the
5 WhatsApp/Facebook License. Lyft requested this information from AGIS Software via an
6 interrogatory (i.e., Jurisdictional Interrogatory No. 1), but AGIS Software has refused to provide it.
7 Lyft also sought to confirm this information at the deposition of AGIS Software, however, its
8 designated witness, Thomas Meriam, was unable to confirm it.

9 **g. AGIS Software patent license with Uber and related negotiations**

10 64. On January 29, 2021, AGIS Software sued Uber alleging infringement of all five of
11 the Patents-in-Suit. *AGIS Software Development LLC v. Uber Technologies Inc., d/b/a Uber*, Civil
12 Action No. 2:21-cv-00026 (E.D. Tex.), Dkt. 1 at ¶¶ 18-22, 30, 46, 62, 77, 95.

13 65. On information and belief, Uber currently has or previously had an office in
14 California.

15 66. On information and belief, in or around March of 2022, AGIS Software entered into
16 a license agreement with Uber (“Uber License”) covering all patents and patent applications held or
17 controlled by AGIS Software, including the Patents-in-Suit. On information and belief, this
18 information could have been confirmed had AGIS Software complied with its obligations under
19 Patent L.R. 3-2 to produce “all agreements, including licenses, transferring an interest in any patent-
20 in-suit.” But AGIS Software has not produced all such agreements despite a specific request by
21 Lyft that AGIS Software do so.

22 67. On information and belief, AGIS Software negotiated, including through numerous
23 written email and/or other communications, with Uber to obtain the Uber License. Lyft requested
24 this information from AGIS Software via an interrogatory (i.e., Jurisdictional Interrogatory No. 1),
25 but AGIS Software has refused to provide it. Lyft also sought to confirm this information at the
26 deposition of AGIS Software, however, its designated witness, Thomas Meriam, was unable to
27 confirm it.

28 **h. AGIS Software patent license with T-Mobile and related negotiations**

1 68. On March 3, 2021, AGIS Software sued T-Mobile alleging infringement of patents
2 including the '728 Patent and the '724 Patent, two of the Patents-in-Suit. *AGIS Software*
3 *Development LLC v. T-Mobile USA, Inc.*, Civil Action No. 2:21-cv-00072 (E.D. Tex.), Dkt. 1 at ¶¶
4 7-12, 24, 46, 67, 98, 120, 147.

5 69. On information and belief, T-Mobile or a T-Mobile affiliate currently has or
6 previously had an office in California.

7 70. On information and belief, in or around November of 2021, AGIS Software entered
8 into a license agreement with T-Mobile (“T-Mobile License”) covering all patents and patent
9 applications owned or controlled by AGIS Software or its affiliates. On information and belief, this
10 information could have been confirmed had AGIS Software complied with its obligations under
11 Patent L.R. 3-2 to produce “all agreements, including licenses, transferring an interest in any patent-
12 in-suit.” But AGIS Software has not produced all such agreements despite a specific request by
13 Lyft that AGIS Software do so.

14 71. On information and belief, AGIS Software negotiated, including through numerous
15 written email and/or other communications, with T-Mobile to obtain the -Mobile License. Lyft
16 requested this information from AGIS Software via an interrogatory (i.e., Jurisdictional
17 Interrogatory No. 1), but AGIS Software has refused to provide it. Lyft also sought to confirm this
18 information at the deposition of AGIS Software, however, its designated witness, Thomas Meriam,
19 was unable to confirm it.

20 **i. AGIS Software patent license with Smith Micro and related negotiations**

21 72. On May 17, 2021, Smith Micro sued AGIS Software for a declaratory judgment that
22 Smith Micro did not infringe certain of AGIS Software’s patents, including the '728 and '724
23 Patents, and that said patents were further invalid. *Smith Micro Software, Inc. v. AGIS Software*
24 *Development LLC*, Civil Action No. 5:21-cv-03677 (N.D.Cal.), Dkt. 1 at ¶¶ 16, 50, 55, 60, 65, 70,
25 75, 81, 88, 96, 103, 110, 117.

26 73. On information and belief, Smith Micro currently has or previously had an office
27 located in California.

28

1 74. On information and belief, in or around October 2021, AGIS Software entered into
2 a license agreement with Smith Micro (“Smith Micro License”) covering all patents and patent
3 applications owned or controlled by AGIS Software or its affiliates. On information and belief, this
4 information could have been confirmed had AGIS Software complied with its obligations under
5 Patent L.R. 3-2 to produce “all agreements, including licenses, transferring an interest in any patent-
6 in-suit.” But AGIS Software has not produced all such agreements despite a specific request by
7 Lyft that AGIS Software do so.

8 75. On information and belief, AGIS Software negotiated, including through numerous
9 written email and/or other communications, with Smith Micro to obtain the Smith Micro License.
10 Lyft requested this information from AGIS Software via an interrogatory (i.e., Jurisdictional
11 Interrogatory No. 1), but AGIS Software has refused to provide it. Lyft also sought to confirm this
12 information at the deposition of AGIS Software, however, its designated witness, Thomas Meriam,
13 was unable to confirm it.

14 **j. AGIS, Inc.’s negotiations with Life360**

15 76. On information and belief, AGIS, Inc. sent a letter to Life360, a company
16 headquartered in San Francisco, California, on May 13, 2014 alleging infringement of AGIS’s
17 patents, expressing a willingness to engage in discussions regarding “royalty bearing licensing
18 terms,” and stating that “Life360 and its customers must cease and desist from further infringement”
19 in the absence of a license. *See Advanced Ground Information Sys., Inc. v. Life360, Inc.*, Civil
20 Action No. 9:14-cv-80651 (S.D. Fla.), Dkt. 181 (Transcript of Jury Trial Proceedings Day 1 held on
21 Mar. 9, 2015) at 87:2-7.

22 77. Three days later, on May 16, 2014, AGIS, Inc. sued Life360 alleging infringement
23 of the ’728 Patent, one of the Patents-in-Suit, and related patents. *Advanced Ground Information*
24 *Sys., Inc. v. Life360, Inc.*, Civil Action No. 9:14-cv-80651 (S.D. Fla.), Dkt. 1 at ¶¶ 2, 16, 25, 34, 43.

25 78. On information and belief, Life360 currently has or previously had an office located
26 in California.

27 79. On information and belief, AGIS, Inc. negotiated, including through numerous
28 written email and/or other communications, with Life360 to attempt to license AGIS’s patents. Lyft

1 requested this information from AGIS, Inc. via a subpoena issued by Lyft on February 4, 2022, in
2 addition to requesting such information via an interrogatory (i.e., Jurisdictional Interrogatory No.
3 1). Both AGIS, Inc. and AGIS Software have refused to provide the requested information. Lyft
4 also sought to confirm this information at the deposition of AGIS Software, however, its designated
5 witness, Thomas Meriam, was unable to confirm it.

6 ii. **AGIS Software is a sham entity created to avoid jurisdiction and the corporate**
7 **structure should be ignored under *Dainippon***

8 80. On June 1, 2017, twenty days before filing a patent infringement lawsuit against
9 Apple and ZTE, AGIS Software was created as a Texas LLC to hold and manage intellectual
10 property asserts previously owned by AGIS, Inc.

11 81. On June 15, 2017, AGIS, Inc. assigned the Patents-in-Suit to AGIS Holdings.

12 82. On the same day, AGIS Holdings assigned the Patents-in-Suit to AGIS Software.

13 83. [REDACTED]

14 [REDACTED]
15 84. [REDACTED]
16 [REDACTED]

17 85. Both AGIS, Inc. and AGIS Software are [REDACTED] subsidiaries of AGIS
18 Holdings.

19 86. Malcom K. Beyer, Jr., the named inventor of the Patents-in-Suit, is the CEO of AGIS
20 Software, AGIS Holdings, and AGIS, Inc.

21 87. On information and belief, AGIS Software shares business addresses with AGIS
22 Holdings and AGIS, Inc. at 92 Lighthouse Drive, Jupiter, FL 33469. Lyft requested this information
23 from AGIS, Inc. and AGIS Holdings via a subpoena issued by Lyft on February 4, 2022, in addition
24 to requesting such information via an interrogatory (i.e., Jurisdictional Interrogatory No. 1). AGIS,
25 Inc., AGIS Holdings and AGIS Software have refused to provide the requested information. Lyft
26 also sought to confirm this information at the deposition of AGIS Software, however, its designated
27 witness, Thomas Meriam, was unable to confirm it.

28 88. AGIS Software does not have any employees.

1 89. AGIS Software’s principal source of revenue is from patent licenses.

2 90. AGIS, Inc. has regular contacts with California as discussed in Paragraphs 125-152.

3 91. As a result of its 2017 reorganization, AGIS Software argues that it is insulated from
4 defending declaratory judgment actions in the State of California despite AGIS, Inc.’s contacts with
5 California.

6 92. The creation of AGIS Software to insulate AGIS, Inc. from declaratory jurisdiction
7 is an improper use of the corporate structure and should be disregarded for the jurisdictional
8 analysis. *See Dainippon Screen Mfg. Co., Ltd. v. CFMT, Inc.*, 142 F.3d 1266, 1271 (Fed. Cir. 1998);
9 *Google Inc. v. Rockstar Consortium U.S. LP*, No. C 13-5933-CW, 2014 WL 1571807, at *4 (N.D.
10 Cal. 2014).

11 **iii. AGIS Software, AGIS, Inc., AGIS Holdings, and/or Malcom K. Beyer, Jr. are**
12 **alter egos of each other**

13 93. AGIS Software, AGIS, Inc., AGIS Holdings, and/or Malcom K. Beyer, Jr. are alter
14 egos of each other, and contacts with the State of California by any of the AGIS entities should be
15 considered in the personal jurisdiction analysis.

16 94. AGIS Software self-describes as an “inanimate entity.”

17 95. AGIS Software is inadequately capitalized.

18 96. AGIS Software’s principal source of revenue is from patent licenses.

19 97. AGIS Software, AGIS Holdings, and AGIS, Inc. commingle funds and other assets.

20 98. On information and belief, AGIS, Inc. and AGIS Holdings transfer funds between
21 their bank accounts to pay expenses when one does not have an adequate revenue source for a
22 particular time period. Lyft requested this information from AGIS, Inc. and AGIS Holdings via
23 subpoenas issued by Lyft on February 4, 2022, but both AGIS, Inc. and AGIS Holdings have refused
24 to provide this information.

25 99. [REDACTED]
26 [REDACTED]

27 100. [REDACTED]
28 [REDACTED]

1 101. On information and belief, proceeds from lawsuits filed by AGIS Software involving
2 the Patents-in-Suit were paid to AGIS, Inc. or AGIS Holdings rather than AGIS Software. Lyft
3 requested this information from AGIS, Inc. and AGIS Holdings via subpoenas issued by Lyft on
4 February 4, 2022, but both AGIS, Inc. and AGIS Holdings have refused to provide this information.
5 Lyft also sought to confirm this information at the deposition of AGIS Software, however, its
6 designated witness, Thomas Meriam, was unable to confirm it.

7 102. AGIS Software and AGIS, Inc. each claim the LifeRing products to be their product,
8 and each represent that the LifeRing products practice at least one claim of the Patents-In-Suit.

9 103. AGIS Software, AGIS Holdings, and AGIS, Inc. disregard corporate formalities and
10 fail to maintain an arm’s length relationship.

11 104. On information and belief, AGIS, Inc. transferred patents and patent applications,
12 including the Patents-in-Suit, to AGIS Holdings without consideration. Lyft requested this
13 information from AGIS, Inc. and AGIS Holdings via subpoenas issued by Lyft on February 4, 2022,
14 but both AGIS, Inc. and AGIS Holdings have refused to provide this information.

15 105. [REDACTED]
16 [REDACTED]

17 106. On information and belief, electronic inquiries submitted to AGIS Software’s
18 website are transmitted to AGIS, Inc. Lyft sought to confirm this information at the deposition of
19 AGIS Software, however, its designated witness, Thomas Meriam, was unable to confirm it.

20 107. [REDACTED]

21 108. [REDACTED]

22 109. [REDACTED]

23 110. [REDACTED]

24 [REDACTED]

25 111. [REDACTED]

26 112. [REDACTED]

27 [REDACTED]

28

1 113. On information and belief, AGIS, Inc. pays for office expenses at the business
2 location in Jupiter, Florida. Lyft requested this information from AGIS, Inc. via a subpoena issued
3 by Lyft on February 4, 2022, but AGIS, Inc. has refused to provide this information.

4 114. AGIS Software and AGIS, Inc. share a business location in Marshall, Texas.

5 115. AGIS Software, AGIS Holdings, and AGIS, Inc. use the same employees.

6 116. AGIS Software has no employees of its own, and employees of AGIS, Inc. perform
7 work for AGIS Software.

8 117. On information and belief, AGIS Holdings has no employees of its own, and
9 employees of AGIS, Inc. perform work on behalf of AGIS Holdings. Lyft requested this
10 information from AGIS, Inc. and AGIS Holdings via subpoenas issued by Lyft on February 4, 2022,
11 but both AGIS, Inc. and AGIS Holdings have refused to provide this information.

12 118. AGIS Software does not hold regular officer, board, or other company meetings, and
13 does not record and maintain regular minutes from officer, board, or other company meetings.

14 119. On information and belief, AGIS, Inc. does not hold regular officer, board, or other
15 corporate meetings and does not record and maintain regular minutes from officer, board, or other
16 corporate meetings. Lyft requested this information from AGIS, Inc. via a subpoena issued by Lyft
17 on February 4, 2022, but AGIS, Inc. has refused to provide this information.

18 120. AGIS Software, AGIS Holdings, and AGIS, Inc. have identical directors and/or
19 officers.

20 121. AGIS, Inc., AGIS Software, and AGIS Holdings have overlapping officers. Malcolm
21 K. Beyer Jr. is the CEO of AGIS Software, the CEO/Director/Chairman of AGIS Holdings, and the
22 CEO/Director/Chairman of AGIS, Inc. Margaret Beyer is the Secretary of AGIS Software, the
23 Secretary/Director of AGIS Holdings, and the Secretary/Director of AGIS, Inc. Ronald Wisneski is
24 the CFO/Treasurer of AGIS Software, the CFO/Treasurer of AGIS Holdings, and the
25 CFO/Treasurer of AGIS, Inc. Sandel Blackwell is the President of AGIS Software, the
26 President/Director of AGIS Holdings, and the President of AGIS, Inc.

27 122. Because there is a unity of interest and ownership between AGIS Software, AGIS,
28 Inc., AGIS Holdings, and/or Malcom K. Beyer, Jr. the separate personalities of the entities no longer

1 exist, and the corporate structure should be disregarded. *See, e.g. City & Cty. of San Francisco v.*
2 *Purdue Pharma L.P.*, 491 F. Supp. 3d 610, 635 (N.D. Cal. 2020).

3 123. Failure to disregard the separate identities of AGIS Software, AGIS, Inc., AGIS
4 Holdings, and/or Malcom K. Beyer, Jr. would result in fraud or injustice to Lyft's ability to seek a
5 declaratory judgment of no infringement and recover any damages resulting from this lawsuit. *See,*
6 *e.g., Reynolds v. Binance Holdings Ltd.*, 481 F. Supp. 3d 997, 1009 (N.D. Cal. 2020) ("To establish
7 inequity in the absence of alter ego liability, a plaintiff must plead facts sufficient to demonstrate
8 that conduct amounting to bad faith makes it inequitable for the corporate owner to hide behind the
9 corporate form."); *Successor Agency to Former Emeryville Redevelopment Agency v. Swagelok Co.*,
10 364 F. Supp. 3d 1061, 1072 (N.D. Cal. 2019).

11 124. Because Malcom K. Beyer, Jr. and/or AGIS, Inc. controls the actions of the AGIS
12 Software and AGIS Holdings such that AGIS Software and AGIS Holdings are mere alter egos of
13 Malcom K. Beyer, Jr. and/or AGIS, Inc., the Court may exercise jurisdiction collectively over the
14 AGIS entities.

15 **iv. AGIS, Inc. has regular contacts with California involving the Patents-in-**
16 **Suit**

17 125. AGIS, Inc. has intentionally directed activities and communications to the State of
18 California.

19 126. On information and belief, AGIS, Inc. maintains or maintained a bank account in
20 California. Lyft requested this information from AGIS, Inc. via a subpoena issued by Lyft on
21 February 4, 2022, in addition to requesting such information via an interrogatory (i.e., Jurisdictional
22 Interrogatory No. 1). Both AGIS, Inc. and AGIS Software have refused to provide the requested
23 information. Lyft also sought to confirm this information at the deposition of AGIS Software,
24 however, its designated witness, Thomas Meriam, was unable to confirm it.

25 127. AGIS, Inc. communicated with California companies, including Google, Inc. and
26 Facebook, Inc., to pursue joint ventures, acquisition, or patent licensing agreements involving the
27 Patents-in-Suit and/or related patents.

28

1 128. On information and belief, AGIS, Inc. formed partnerships with one or more
2 California companies or individuals involving products that embody the Patents-in-Suit, including
3 the LifeRing products. Lyft requested this information from AGIS, Inc. via a subpoena issued by
4 Lyft on February 4, 2022, in addition to requesting such information via an interrogatory (i.e.,
5 Jurisdictional Interrogatory No. 1). Both AGIS, Inc. and AGIS Software have refused to provide
6 the requested information. Lyft also sought to confirm this information at the deposition of AGIS
7 Software, however, its designated witness, Thomas Meriam, was unable to confirm it.

8 129. On information and belief, AGIS, Inc. entered into non-disclosure agreements with
9 California companies and organizations to pursue business opportunities involving products and/or
10 services that embody the Patents-in-Suit, including the LifeRing products. Lyft requested this
11 information from AGIS, Inc. via a subpoena issued by Lyft on February 4, 2022, in addition to
12 requesting such information via an interrogatory (i.e., Jurisdictional Interrogatory No. 1). Both
13 AGIS, Inc. and AGIS Software have refused to provide the requested information. Lyft also sought
14 to confirm this information at the deposition of AGIS Software, however, its designated witness,
15 Thomas Meriam, was unable to confirm it.

16 130. AGIS, Inc. sent a letter to California-based company Life360 alleging infringement
17 of and seeking a license to one or more of the Patents-in-Suit and/or related patents.

18 131. On information and belief, AGIS, Inc. marketed and continued to market its LifeRing
19 product, which allegedly embodies the Patents-in-Suit, in California. Lyft requested this
20 information from AGIS, Inc. via a subpoena issued by Lyft on February 4, 2022, in addition to
21 requesting such information via an interrogatory (i.e., Jurisdictional Interrogatory No. 1). Both
22 AGIS, Inc. and AGIS Software have refused to provide the requested information. Lyft also sought
23 to confirm this information at the deposition of AGIS Software, however, its designated witness,
24 Thomas Meriam, was unable to confirm it.

25 132. On information and belief, AGIS, Inc. marketed LifeRing, which allegedly embodies
26 the Patents-in-Suit, to California companies CornerTurn LLC, Integrity Applications and American
27 Reliance, Inc. *See Life360, Inc. v. Advanced Ground Info. Sys., Inc.*, 2015 WL 5612008, at *3, Case
28 No. 15-cv-00151-BLF (N.D. Cal. Sept. 21, 2015). Lyft requested this information from AGIS, Inc.

1 via a subpoena issued by Lyft on February 4, 2022, in addition to requesting such information via
2 an interrogatory (i.e., Jurisdictional Interrogatory No. 1). Both AGIS, Inc. and AGIS Software have
3 refused to provide the requested information. On information and belief, AGIS, Inc. has also
4 marketed LifeRing, which allegedly embodies the Patents-in-Suit to first responders, military
5 agencies, and/or military contractors, including those in the State of California. Lyft requested this
6 information from AGIS, Inc. via a subpoena issued by Lyft on February 4, 2022, in addition to
7 requesting such information via an interrogatory (i.e., Jurisdictional Interrogatory No. 1). Both
8 AGIS, Inc. and AGIS Software have refused to provide the requested information. Lyft also sought
9 to confirm this information at the deposition of AGIS Software, however, its designated witness,
10 Thomas Meriam, was unable to confirm it.

11 133. On information and belief, AGIS, Inc. provides or has provided downloads and
12 updates of its LifeRing product, which allegedly embodies the Patents-in-Suit, in California. Lyft
13 requested this information from AGIS, Inc. via a subpoena issued by Lyft on February 4, 2022, in
14 addition to requesting such information via an interrogatory (i.e., Jurisdictional Interrogatory No.
15 1). Both AGIS, Inc. and AGIS Software have refused to provide the requested information. Lyft
16 also sought to confirm this information at the deposition of AGIS Software, however, its designated
17 witness, Thomas Meriam, was unable to confirm it.

18 134. On information and belief, AGIS, Inc. provided downloads of its LifeRing product,
19 which allegedly embodies the Patents-in-Suit, to United States Navy personnel and contractors at
20 the United States Navy, SPAWAR Systems Center Pacific, in San Diego, California. *See Life360,*
21 *Inc.*, 2015 WL 5612008, at *3. Lyft requested this information from AGIS, Inc. via a subpoena
22 issued by Lyft on February 4, 2022, in addition to requesting such information via an interrogatory
23 (i.e., Jurisdictional Interrogatory No. 1). Both AGIS, Inc. and AGIS Software have refused to
24 provide the requested information.

25 135. AGIS, Inc. allows companies and individuals, including California companies and
26 individuals, a trial of the LifeRing product, which allegedly embodies the Patents-in-Suit.

27 136. On information and belief, AGIS Software has licensed the Patents-in-Suit and/or
28 related patents to end users residing in California who downloaded the LifeRing product, which

1 allegedly embodies the Patents-in-Suit. Lyft requested this information from AGIS, Inc. via a
2 subpoena issued by Lyft on February 4, 2022, in addition to requesting such information via an
3 interrogatory (i.e., Jurisdictional Interrogatory No. 1). Both AGIS, Inc. and AGIS Software have
4 refused to provide the requested information. Lyft also sought to confirm this information at the
5 deposition of AGIS Software, however, its designated witness, Thomas Meriam, was unable to
6 confirm it.

7 137. On information and belief, AGIS, Inc. demonstrates or has demonstrated its LifeRing
8 product, which allegedly embodies the Patents-in-Suit, in California or to individuals or entities
9 residing in or operating out of California, respectively. Lyft requested this information from AGIS,
10 Inc. via a subpoena issued by Lyft on February 4, 2022, in addition to requesting such information
11 via an interrogatory (i.e., Jurisdictional Interrogatory No. 1). Both AGIS, Inc. and AGIS Software
12 have refused to provide the requested information. Lyft also sought to confirm this information at
13 the deposition of AGIS Software, however, its designated witness, Thomas Meriam, was unable to
14 confirm it.

15 138. On information and belief, AGIS, Inc. demonstrated its LifeRing product, which
16 allegedly embodies the Patents-in-Suit, at a U.S. military exercise in San Diego, California. *See*
17 *Life360, Inc.*, 2015 WL 5612008, at *3. Lyft requested this information from AGIS, Inc. via a
18 subpoena issued by Lyft on February 4, 2022, in addition to requesting such information via an
19 interrogatory (i.e., Jurisdictional Interrogatory No. 1). Both AGIS, Inc. and AGIS Software have
20 refused to provide the requested information.

21 139. On information and belief, Malcolm K. Beyer, Jr. discussed the LifeRing Product,
22 which allegedly embodies the Patents-in-Suit, with California companies including ADI
23 Technology and Maven Consulting. *See Life360, Inc.*, 2015 WL 5612008, at *3. Lyft requested
24 this information from AGIS, Inc. via a subpoena issued by Lyft on February 4, 2022, in addition to
25 requesting such information via an interrogatory (i.e., Jurisdictional Interrogatory No. 1). Both
26 AGIS, Inc. and AGIS Software have refused to provide the requested information.

27 140. On information and belief, AGIS, Inc. demonstrated its LifeRing product, which
28 allegedly embodies the Patents-in-Suit, at the National Incident Management System (NIMS) Test,

1 to individuals or entities residing in or operating out of California, respectively, and/or which
2 occurred in California. Lyft requested this information from AGIS, Inc. via a subpoena issued by
3 Lyft on February 4, 2022, in addition to requesting such information via an interrogatory (i.e.,
4 Jurisdictional Interrogatory No. 1). Both AGIS, Inc. and AGIS Software have refused to provide
5 the requested information. Lyft also sought to confirm this information at the deposition of AGIS
6 Software, however, its designated witness, Thomas Meriam, was unable to confirm it.

7 141. On information and belief, AGIS, Inc. demonstrated its LifeRing product, which
8 allegedly embodies the Patents-in-Suit, at a Coalition Warrior Interoperability Demonstration, to
9 individuals or entities residing in or operating out of California, respectively, and/or which occurred
10 in California. Lyft requested this information from AGIS, Inc. via a subpoena issued by Lyft on
11 February 4, 2022, in addition to requesting such information via an interrogatory (i.e., Jurisdictional
12 Interrogatory No. 1). Both AGIS, Inc. and AGIS Software have refused to provide the requested
13 information. Lyft also sought to confirm this information at the deposition of AGIS Software,
14 however, its designated witness, Thomas Meriam, was unable to confirm it.

15 142. On information and belief, AGIS, Inc. demonstrated its LifeRing product, which
16 allegedly embodies the Patents-in-Suit, at Army Network Integration Evaluation, to individuals or
17 entities residing in or operating out of California, respectively, and/or which occurred in California.
18 Lyft requested this information from AGIS, Inc. via a subpoena issued by Lyft on February 4, 2022,
19 in addition to requesting such information via an interrogatory (i.e., Jurisdictional Interrogatory No.
20 1). Both AGIS, Inc. and AGIS Software have refused to provide the requested information. Lyft
21 also sought to confirm this information at the deposition of AGIS Software, however, its designated
22 witness, Thomas Meriam, was unable to confirm it.

23 143. On information and belief, AGIS, Inc. demonstrated its LifeRing product, which
24 allegedly embodies the Patents-in-Suit, at various U.S. Joint Commission Chief of Staff exercises,
25 to individuals or entities residing in or operating out of California, respectively, and/or which
26 occurred in California. Lyft requested this information from AGIS, Inc. via a subpoena issued by
27 Lyft on February 4, 2022, in addition to requesting such information via an interrogatory (i.e.,
28 Jurisdictional Interrogatory No. 1). Both AGIS, Inc. and AGIS Software have refused to provide

1 the requested information. Lyft also sought to confirm this information at the deposition of AGIS
2 Software, however, its designated witness, Thomas Meriam, was unable to confirm it.

3 144. On information and belief, AGIS, Inc. demonstrated its LifeRing product, which
4 allegedly embodies the Patents-in-Suit, at the Defense Intelligence Agency's Plugfest, to individuals
5 or entities residing in or operating out of California, respectively, and/or which occurred in
6 California. Lyft requested this information from AGIS, Inc. via a subpoena issued by Lyft on
7 February 4, 2022, in addition to requesting such information via an interrogatory (i.e., Jurisdictional
8 Interrogatory No. 1). Both AGIS, Inc. and AGIS Software have refused to provide the requested
9 information. Lyft also sought to confirm this information at the deposition of AGIS Software,
10 however, its designated witness, Thomas Meriam, was unable to confirm it.

11 145. On information and belief, AGIS, Inc. demonstrated its LifeRing product, which
12 allegedly embodies the Patents-in-Suit, at various SOCOM TNT exercises, to individuals or entities
13 residing in or operating out of California, respectively, and/or which occurred in California. Lyft
14 requested this information from AGIS, Inc. via a subpoena issued by Lyft on February 4, 2022, in
15 addition to requesting such information via an interrogatory (i.e., Jurisdictional Interrogatory No.
16 1). Both AGIS, Inc. and AGIS Software have refused to provide the requested information. Lyft
17 also sought to confirm this information at the deposition of AGIS Software, however, its designated
18 witness, Thomas Meriam, was unable to confirm it.

19 146. On information and belief, AGIS, Inc. demonstrated its LifeRing product, which
20 allegedly embodies the Patents-in-Suit, at U.S. NATO Bold Quest, to individuals or entities residing
21 in or operating out of California, respectively, and/or which occurred in California. Lyft requested
22 this information from AGIS, Inc. via a subpoena issued by Lyft on February 4, 2022, in addition to
23 requesting such information via an interrogatory (i.e., Jurisdictional Interrogatory No. 1). Both
24 AGIS, Inc. and AGIS Software have refused to provide the requested information. Lyft also sought
25 to confirm this information at the deposition of AGIS Software, however, its designated witness,
26 Thomas Meriam, was unable to confirm it.

27 147. On information and belief, AGIS, Inc. demonstrated its LifeRing product, which
28 allegedly embodies the Patents-in-Suit, at Joint-Interagency Field Experimentation (JIFX)

1 exercises, to individuals or entities residing in or operating out of California, respectively, and/or
2 which occurred in California. Lyft requested this information from AGIS, Inc. via a subpoena issued
3 by Lyft on February 4, 2022, in addition to requesting such information via an interrogatory (i.e.,
4 Jurisdictional Interrogatory No. 1). Both AGIS, Inc. and AGIS Software have refused to provide
5 the requested information. Lyft also sought to confirm this information at the deposition of AGIS
6 Software, however, its designated witness, Thomas Meriam, was unable to confirm it.

7 148. On information and belief, AGIS, Inc. demonstrated its LifeRing product, which
8 allegedly embodies the Patents-in-Suit, at the Army Expeditionary Warrior Experiment, to
9 individuals or entities residing in or operating out of California, respectively, and/or which occurred
10 in California. Lyft requested this information from AGIS, Inc. via a subpoena issued by Lyft on
11 February 4, 2022, in addition to requesting such information via an interrogatory (i.e., Jurisdictional
12 Interrogatory No. 1). Both AGIS, Inc. and AGIS Software have refused to provide the requested
13 information. Lyft also sought to confirm this information at the deposition of AGIS Software,
14 however, its designated witness, Thomas Meriam, was unable to confirm it.

15 149. On information and belief, AGIS, Inc. demonstrated its LifeRing product, which
16 allegedly embodies the Patents-in-Suit, at Jolted Tactics, to individuals or entities residing in or
17 operating out of California, respectively, and/or which occurred in California. Lyft requested this
18 information from AGIS, Inc. via a subpoena issued by Lyft on February 4, 2022, in addition to
19 requesting such information via an interrogatory (i.e., Jurisdictional Interrogatory No. 1). Both
20 AGIS, Inc. and AGIS Software have refused to provide the requested information. Lyft also sought
21 to confirm this information at the deposition of AGIS Software, however, its designated witness,
22 Thomas Meriam, was unable to confirm it.

23 150. On information and belief, AGIS, Inc. demonstrated its LifeRing product, which
24 allegedly embodies the Patents-in-Suit, to various individuals affiliated with the U.S. Navy that
25 reside in California and/or which occurred in California. Lyft requested this information from
26 AGIS, Inc. via a subpoena issued by Lyft on February 4, 2022, in addition to requesting such
27 information via an interrogatory (i.e., Jurisdictional Interrogatory No. 1). Both AGIS, Inc. and AGIS
28 Software have refused to provide the requested information. Lyft also sought to confirm this

1 information at the deposition of AGIS Software, however, its designated witness, Thomas Meriam,
2 was unable to confirm it.

3 151. As a result of the foregoing, AGIS Software either individually or as an alter ego of
4 AGIS, Inc., AGIS Holdings, and/or Malcom K. Beyer, Jr. is subject to personal jurisdiction within
5 this judicial district.

6 152. Venue is proper in this judicial district pursuant to 28 U.S.C. § 1391 in that a
7 substantial part of the acts giving rise to the claim occurred in this judicial district, and because
8 AGIS Software is subject to personal jurisdiction in this district.

9 **COUNT I**

10 **Declaratory Relief Regarding Non-Infringement of U.S. Patent No. 7,031,728**

11 153. Lyft restates and incorporates by reference each of the allegations set forth in
12 paragraphs 1-152 above, as if fully set forth herein.

13 154. On information and belief, AGIS Software is the owner of all right, title, and interest
14 in the '728 patent, including the right to assert all causes of action arising under that patent and the
15 right to any remedies for infringement of it. A copy of the '728 patent is attached hereto as **Exhibit**
16 **A.**

17 155. As a result of the acts described in the preceding paragraphs, there exists a
18 controversy of sufficient immediacy and reality regarding whether Lyft infringes the claims of the
19 '728 Patent, including Lyft facing an imminent threat of restraint on free use of its non-infringing
20 products, such that a declaratory judgment of non-infringement is warranted.

21 156. Lyft has not infringed, directly or indirectly the claims of the '728 Patent by or
22 through making, using, offering for sale, selling within the United States and/or importing of its
23 products and/or services.

24 157. The '728 Patent purports to concern a system for monitoring the location and status
25 of a plurality users on the display of the users' cellular phone or PDA." Exhibit A at Abstract.

26 158. Claim 7 of the '728 Patent provides as follows:

27
28 7. A method of establishing a cellular phone communication network for designated
participants, each having a similarly equipped cellular phone that includes voice

1 communication, free and operator selected text messages, photograph and video, a CPU, a
2 GPS navigation system and a touch screen display comprising the steps of:

3 a) generating one or more symbols on the touch display screen, each representing a
4 different participant that has a cellular phone that includes said voice
5 communication, free and operator selected text messages, photograph and video, a
6 CPU, said GPS system and a touch screen display;

7 b) providing and storing in each of the participant cellular phones one or more
8 cellular phone telephone numbers, each cellular phone number of which relates to a
9 different symbol of each of the participants in the communication network;

10 c) providing initiating cellular phone calling software in each cellular phone that is
11 activated by touching a symbol on the touch display that automatically initiates a
12 cellular phone call using the stored cellular phone number to the participant
13 represented by the symbol; and

14 d) generating a geographical location chart on said display screen to show the
15 geographical location of each of the symbols representing the participants in the
16 communication network by latitude and longitude.

17 159. Lyft does not infringe claim 7 of the '728 Patent at least because the activities and/or
18 products of Lyft accused of infringing the '728 Patent, including at least Lyft's Accused Products,
19 do not infringe claim 7 literally or under the doctrine of equivalents.

20 160. For example, without limitation, Lyft does not "provid[e] and stor[e] in each of the
21 participant cellular phones one or more cellular phone telephone numbers, each cellular phone
22 number of which relates to a different symbol of each of the participants in the communication
23 network" as required by claim 7 and as alleged by AGIS Software. Contrary to AGIS Software's
24 allegations, Lyft does not store numbers on user devices. Consequently, Lyft does not "provid[e]
25 and stor[e] in each of the participant cellular phones one or more cellular phone telephone numbers"
26 as required by claim 7 of the '728 Patent. At least for these reasons, Lyft does not infringe claim 7
27 of the '728 Patent. The allegations in this paragraph are exemplary and do not preclude Lyft from
28 contending that claim 7 and the claims depending from it are not infringed for additional reasons.

161. As another example, without limitation, Lyft does not "provid[e] initiating cellular
phone calling software in each cellular phone that is activated by touching a symbol on the touch
display that automatically initiates a cellular phone call using the stored cellular phone number to
the participant represented by the symbol" as required by claim 7 and as alleged by AGIS Software.
Contrary to AGIS Software's allegations, Lyft does not use symbols representing participants to

1 place calls. Consequently, Lyft does not “provid[e] initiating cellular phone calling software in each
2 cellular phone that is activated by touching a symbol on the touch display that automatically initiates
3 a cellular phone call using the stored cellular phone number to the participant represented by the
4 symbol” as required by claim 7 of the ’728 Patent. At least for these reasons, Lyft does not infringe
5 claim 7 of the ’728 Patent. The allegations in this paragraph are exemplary and do not preclude
6 Lyft from contending that claim 7 and the claims depending from it are not infringed for additional
7 reasons.

8 162. For at least the foregoing reasons, Lyft does not infringe any claim of the ’728 patent,
9 directly or indirectly, contributorily or otherwise through its or its user’s activities in conjunction
10 with the Lyft rider or Lyft driver applications, or any other Lyft product.

11 163. As set forth above, an actual and justiciable controversy exists between Lyft and
12 AGIS Software as to Lyft’s non-infringement of the ’728 patent.

13 164. Pursuant to the Federal Declaratory Judgment Act, 28 U.S.C. §§ 2201 *et seq.*, Lyft
14 requests that this Court enter a judgment that Lyft does not infringe, under any theory of
15 infringement, any valid claim of the ’728 patent.

16 COUNT II

17 **Declaratory Relief Regarding Non-Infringement of U.S. Patent No. 7,630,724**

18 165. Lyft restates and incorporates by reference each of the allegations set forth in
19 paragraphs 1-164 above, as if fully set forth herein.

20 166. AGIS Software alleges that it is the owner of all right, title, and interest in the ’724
21 patent, including the right to assert all causes of action arising under that patent and the right to any
22 remedies for infringement of it. A copy of the ’724 patent is attached hereto as **Exhibit B**.

23 167. As a result of the acts described in the preceding paragraphs, there exists a
24 controversy of sufficient immediacy and reality regarding whether Lyft infringes the claims of the
25 ’724 Patent, including Lyft facing an imminent threat of restraint on free use of its non-infringing
26 products, such that a declaratory judgment of non-infringement is warranted.

27
28

1 168. Lyft has not infringed, directly or indirectly the claims of the '724 Patent by or
2 through making, using, offering for sale, selling within the United States and/or its importing of it
3 products and/or services.

4 169. The '724 Patent purports to concern monitoring other user's location and status, and
5 to initiate cellular phone calls between users by selecting a symbol on a touch display. Exhibit B at
6 Abstract.

7 170. Claim 16 of the '724 Patent provides as follows:

8
9 16. A method of providing a cellular phone communication network for designated
10 participating users, each having a similarly equipped PDA cellular phone that includes a
11 CPU, a GPS navigational system and a touch screen display comprising:

12 selecting an icon that establishes rapid voice call initiation and communication to
13 the users of the cellular telephone PDA/GPS network system by touching their
14 symbol on the phone's a touch screen;

15 transmitting high speed internet rapid transmission of operator selected text
16 messages, photographs, voice recordings and video to other cellular phone users
17 using the touch screen;

18 accessing a server for establishing high speed internet communications between
19 said cellular phone network users and said server; and

20 generating at the server networks enabling anonymous voice and data
21 communications so that neither the originator of the phone call or data transmission
22 nor the receiver of the phone call or data transmission need to know the other's
23 phone number, name or other identifier other than a symbol location on a map.

24 171. Lyft does not infringe claim 16 of the '724 Patent at least because the activities and/or
25 products of Lyft accused of infringing the '724 Patent, including at least Lyft's Accused Products,
26 do not infringe claim 16 literally or under the doctrine of equivalents.

27 172. For, without limitation, Lyft does not "establish[] rapid voice call initiation and
28 communication to the users of the cellular telephone PDA/GPS network system by touching their
symbol on the phone's a touch screen" as required by claim 16 and as alleged by AGIS Software.
Contrary to AGIS Software's allegations, Lyft does not use symbols representing participants to
place calls. Consequently, Lyft does not "establish[] rapid voice call initiation and communication
to the users of the cellular telephone PDA/GPS network system by touching their symbol on the
phone's a touch screen" as required by claim 16 of the '724 Patent. At least for these reasons, Lyft

1 does not infringe claim 16 of the '724 Patent. The allegations in this paragraph are exemplary and
2 do not preclude Lyft from contending that claim 16 and the claims depending from it are not
3 infringed for additional reasons.

4 173. As another example, without limitation, Lyft does not “generate[e] at the server
5 networks enabling anonymous voice and data communications so that neither the originator of the
6 phone call or data transmission nor the receiver of the phone call or data transmission need to know
7 the other’s phone number, name or other identifier other than a symbol location on a map” as
8 required by claim 16 and as alleged by AGIS Software. Contrary to AGIS Software’s allegations,
9 Lyft does provide additional information such as a phone numbers, name, and/or other identifiers
10 other than a symbol on a map. At least for these reasons, Lyft does not infringe claim 16 of the '724
11 Patent. The allegations in this paragraph are exemplary and do not preclude Lyft from contending
12 that claim 16 and the claims depending from it are not infringed for additional reasons.

13 174. For at least the foregoing reasons, Lyft does not infringe any claim of the '724 patent,
14 directly or indirectly, contributorily or otherwise through its or its user’s activities in conjunction
15 with the Lyft rider or Lyft driver applications, or any other Lyft product.

16 175. As set forth above, an actual and justiciable controversy exists between Lyft and
17 AGIS Software as to Lyft’s non-infringement of the '724 patent.

18 176. Pursuant to the Federal Declaratory Judgment Act, 28 U.S.C. §§ 2201 *et seq.*, Lyft
19 requests that this Court enter a judgment that Lyft does not infringe, under any theory of
20 infringement, any valid claim of the '724 patent.

21 **COUNT III**

22 **Declaratory Relief Regarding Non-Infringement of U.S. Patent No. 8,213,970**

23 177. Lyft restates and incorporates by reference each of the allegations set forth in
24 paragraphs 1-176 above, as if fully set forth herein.

25 178. On information and belief, AGIS Software is the owner of all right, title, and interest
26 in the '970 patent, including the right to assert all causes of action arising under that patent and the
27 right to any remedies for infringement of it. A copy of the '970 patent is attached hereto as **Exhibit**
28 **C.**

1 179. As a result of the acts described in the preceding paragraphs, there exists a
2 controversy of sufficient immediacy and reality regarding whether Lyft infringes the claims of the
3 '970 Patent, including Lyft facing an imminent threat of restraint on free use of its non-infringing
4 products, such that a declaratory judgment of non-infringement is warranted.

5 180. Lyft has not infringed, directly or indirectly the claims of the '970 Patent by or
6 through making, using, offering for sale, selling within the United States and/or its importing of it
7 products and/or services.

8 181. The '970 Patent purports to concern “enabl[ing] a participant to force an automatic
9 acknowledgement and a manual response to a text or voice message from other participants within
10 the same network.” Exhibit C at Abstract. The Patent describes a sender to select an option to send
11 a forced message, which forced message requires a response from a recipient of the message. In
12 response to receiving the forced message, the recipient must select a response on their device before
13 they can exit from the message. *Id.* at Figures 3A and 4.

14 182. Claim 2 of the '970 Patent provides as follows:

15 2. A communication system for transmitting, receiving, confirming receipt, and responding
16 to an electronic message, comprising:

17 a predetermined network of participants, wherein each participant has a similarly
18 equipped PDA/cell phone that includes a CPU and a touch screen display a CPU
and memory;

19 a data transmission means that facilitates the transmission of electronic files
20 between said PDA/cell phones in different locations;

21 a sender PDA/cell phone and at least one recipient PDA/cell phone for each
electronic message;

22 a forced message alert software application program including a list of required
23 possible responses to be selected by a participant recipient of a forced message
response loaded on each participating PDA/cell phone;

24 means for attaching a forced message alert software packet to a voice or text
25 message creating a forced message alert that is transmitted by said sender PDA/cell
26 phone to the recipient PDA/cell phone, said forced message alert software packet
27 containing a list of possible required responses and requiring the forced message
alert software on said recipient PDA/cell phone to transmit an automatic
acknowledgment to the sender PDA/cell phone as soon as said forced message alert
is received by the recipient PDA/cell phone;

28 means for requiring a required manual response from the response list by the

- 1 recipient in order to clear recipient's response list from recipient's cell phone
display;
- 2 means for receiving and displaying a listing of which recipient PDA/cell phones
3 have automatically acknowledged the forced message alert and which recipient
PDA/cell phones have not automatically acknowledged the forced message alert;
- 4 means for periodically resending said forced message alert to said recipient
5 PDA/cell phones that have not automatically acknowledged the forced message
alert; and
- 6 means for receiving and displaying a listing of which recipient PDA/cell phones
7 have transmitted a manual response to said forced message alert and details the
response from each recipient PDA/cell phone that responded; and
- 8 means for displaying a geographical map with georeferenced entities on the display
9 of the sender PDA/cell phone; means for obtaining location and status data
associated with the recipient PDA/cell phone; and means for presenting a recipient
10 symbol on the geographical map corresponding to a correct geographical location
of the recipient PDA/cell phone, wherein the forced message alert software
11 application program on the recipient PDA/cell phone includes:
- 12 means for transmitting the acknowledgment of receipt to said sender PDA/cell
13 phone immediately upon receiving a forced message alert from the sender PDA/cell
phone;
- 14 means for controlling of the recipient PDA/cell phone upon transmitting said
15 automatic acknowledgment and causing, in cases where the force message alert is a
text message, the text message and a response list to be shown on the display of the
16 recipient PDA/cell phone or causes, in cases where the forced message alert is a
voice message, the voice message being periodically repeated by the speakers of
17 the recipient PDA/cell phone while said response list is shown on the display;
- 18 means for allowing a manual response to be manually selected from the response
list or manually recorded and transmitting said manual response to the sender
19 PDA/cell phone; and
- 20 means for clearing the text message and a response list from the display of the
recipient PDA/cell phone or stopping the repeating voice message and clearing the
21 response list from the display of the recipient PDA/cell phone once the manual
response is transmitted.

22 183. Lyft does not infringe claim 2 of the '970 Patent at least because the activities and/or
23 products of Lyft accused of infringing the '970 Patent, including at least Lyft's Accused Products,
24 do not infringe claim 1 literally or under the doctrine of equivalents.

25 184. For example, without limitation, Lyft does not require a "forced message alert" nor
26 "[require] a required manual response from the response list by the recipient in order to clear
27 recipient's response list from recipient's cell phone display" as required by claim 2 and as alleged
28

1 by AGIS Software. The '970 Patent defines “the response list” as “the response list from which the
2 message receive must select.” *Id.* at 7:55-56. Contrary to AGIS Software’s allegations, Lyft does
3 not requires manual responses to clear a recipient’s response list from the recipient’s cell phone
4 display. Consequently, Lyft does not require a “forced message alert” nor “[require] a required
5 manual response from the response list by the recipient in order to clear recipient's response list
6 from recipient's cell phone display” as required by claim 2 of the '970 Patent. At least for these
7 reasons, Lyft does not infringe claim 2 of the '970 Patent. The allegations in this paragraph are
8 exemplary and do not preclude Lyft from contending that claim 2 and the claims depending from it
9 are not infringed for additional reasons.

10 185. For example, without limitation, Lyft does not require a “means for requiring a
11 required manual response from the response list by the recipient in order to clear recipient's response
12 list from recipient's cell phone display” as required by claim 2 and as alleged by AGIS Software.
13 The '970 Patent states that a display “can only be cleared by manually transmitting a response.” *Id.*
14 at Abstract. Contrary to AGIS Software’s allegations, Lyft does not requires manual responses to
15 clear a display. Consequently, Lyft does not require a “forced message alert” nor “[require] a
16 required manual response from the response list by the recipient in order to clear recipient's response
17 list from recipient's cell phone display” as required by claim 2 of the '970 Patent. At least for these
18 reasons, Lyft does not infringe claim 2 of the '970 Patent. The allegations in this paragraph are
19 exemplary and do not preclude Lyft from contending that claim 2 and the claims depending from it
20 are not infringed for additional reasons.

21 186. For at least the foregoing reasons, Lyft does not infringe any claim of the '970 patent,
22 directly or indirectly, contributorily or otherwise through its or its user’s activities in conjunction
23 with the Lyft rider or Lyft driver applications, or any other Lyft product.

24 187. As set forth above, an actual and justiciable controversy exists between Lyft and
25 AGIS Software as to Lyft’s non-infringement of the '970 patent.

26 188. Pursuant to the Federal Declaratory Judgment Act, 28 U.S.C. §§ 2201 *et seq.*, Lyft
27 requests that this Court enter a judgment that Lyft does not infringe, under any theory of
28 infringement, any valid claim of the '970 patent.

1
2
3
4
5
6
7
8
9
10
11
12
13
14
15
16
17
18
19
20
21
22
23
24
25
26
27
28

COUNT IV

Declaratory Relief Regarding Non-Infringement of U.S. Patent No. 10,299,100

189. Lyft restates and incorporates by reference each of the allegations set forth in paragraphs 1-188 above, as if fully set forth herein.

190. AGIS Software alleges that it is the owner of all right, title, and interest in the '100 patent, including the right to assert all causes of action arising under that patent and the right to any remedies for infringement of it. A copy of the '100 patent is attached hereto as **Exhibit D**.

191. As a result of the acts described in the preceding paragraphs, there exists a controversy of sufficient immediacy and reality regarding whether Lyft infringes the claims of the '100 Patent, including Lyft facing an imminent threat of restraint on free use of its non-infringing products, such that a declaratory judgment of non-infringement is warranted.

192. Lyft has not infringed, directly or indirectly the claims of the '100 Patent by or through making, using, offering for sale, selling within the United States and/or its importing of it products and/or services.

193. The '100 Patent purports to concern “set[ting] up ad hoc networks in emergency situations.” Exhibit D at Abstract. The Patent further describes how users may join the ad hoc networks. *Id.* at Figures 2-4.

194. Claim 1 of the '100 Patent provides as follows:

1. A method performed by a mobile device having a display and one or more processors, the method comprising:

executing operations on the one or more processors of the mobile device, the operations comprising:

associating the mobile device with an identifier, wherein the identifier corresponds to a network participant;

determining a device location corresponding to a geographical location of the mobile device;

receiving, from a server, mapping data including a map and coordinate translation data correlating coordinates of positions on the map with corresponding coordinates of geographical locations;

receiving, from a server, location data indicating vehicle locations of one or more vehicles;

1 marking the map with a plurality of symbols comprising: a participant
2 symbol corresponding to the device location, one or more facility symbols
3 corresponding to respective facility locations of one or more facilities, and
4 one or more vehicle symbols corresponding to the respective vehicle
5 locations of the one or more vehicles, wherein marking the map comprises:

6 determining, based at least in part on the vehicle locations and the
7 coordinate translation data, positions on the map corresponding to
8 the vehicle locations,

9 displaying the map on the display of the mobile device, and

10 placing the vehicle symbols on the map at the determined positions
11 corresponding to the vehicle locations;

12 responsive to user selection of a portion of the display corresponding to a
13 position on the map, identifying a selected facility symbol based on the
14 selected position, comprising: initiating a search of a set of symbols
15 including the facility symbols for a symbol located nearest to the selected
16 position and, based on a result of the search, identifying the selected facility
17 symbol as the symbol located nearest to the selected position;

18 responsive to user input, transmitting first information to a first vehicle of
19 the one or more vehicles; and

20 receiving second information corresponding to the first vehicle and
21 displaying the received second information on the display of the mobile
22 device,

23 wherein the mobile device does not have access to a phone number
24 associated with a computing device corresponding to the first vehicle, an
25 Internet Protocol (IP) address associated with the computing device
26 corresponding to the first vehicle, and an e-mail address associated with the
27 computing device corresponding to the first vehicle.

28 195. Lyft does not infringe claim 1 of the '100 Patent or any claim dependent thereon at
least because the activities and/or products of Lyft accused of infringing the '100 Patent, including
at least Lyft's Accused Products, do not infringe claim 1 literally or under the doctrine of
equivalents.

196. For example, without limitation, Lyft does not "receiv[e], from a server, mapping
data including a map and coordinate translation data correlating coordinates of positions on the map
with corresponding coordinates of geographical locations" as required by claim 1 and as alleged by
AGIS Software. Contrary to AGIS Software's allegations, Lyft does not have a use "coordinate
translation data" to correlate "coordinates of positions on the map with corresponding coordinates
of geographical locations" as required by the '100 Patent. Consequently, Lyft does not prepare a

1 “coordinate translation data” as required by claim 1 of the ’100 Patent. At least for these reasons,
2 Lyft does not infringe claim 1 of the ’100 Patent. The allegations in this paragraph are exemplary
3 and do not preclude Lyft from contending that claim 21 and the claims depending from it are not
4 infringed for additional reasons.

5 197. As another example, without limitation, Lyft does not “initiat[e] a search of a set of
6 symbols including the facility symbols for a symbol located nearest to the selected position” as
7 required by claim 1 and as alleged by AGIS Software. Contrary to AGIS Software’s allegations,
8 Lyft does not have a use “search a set of symbols” as required by the ’100 Patent, as Lyft searches
9 addresses and locations and does not search through symbols themselves. Consequently, Lyft does
10 not “search a set of symbols” as required by claim 1 of the ’100 Patent. At least for these reasons,
11 Lyft does not infringe claim 1 of the ’100 Patent. The allegations in this paragraph are exemplary
12 and do not preclude Lyft from contending that claim 1 and the claims depending from it are not
13 infringed for additional reasons.

14 198. For at least the foregoing reasons, Lyft does not infringe any claim of the ’100 patent,
15 directly or indirectly, contributorily or otherwise through its or its user’s activities in conjunction
16 with the Lyft rider or Lyft driver applications, or any other Lyft product.

17 199. As set forth above, an actual and justiciable controversy exists between Lyft and
18 AGIS Software as to Lyft’s non-infringement of the ’100 patent.

19 200. Pursuant to the Federal Declaratory Judgment Act, 28 U.S.C. §§ 2201 *et seq.*, Lyft
20 requests that this Court enter a judgment that Lyft does not infringe, under any theory of
21 infringement, any valid claim of the ’100 patent.

22 **COUNT V**

23 **Declaratory Relief Regarding Non-Infringement of U.S. Patent No. 10,341,838**

24 201. Lyft restates and incorporates by reference each of the allegations set forth in
25 paragraphs 1-200 above, as if fully set forth herein.

26 202. AGIS Software alleges that it is the owner of all right, title, and interest in the ’838
27 patent, including the right to assert all causes of action arising under that patent and the right to any
28 remedies for infringement of it. A copy of the ’838 patent is attached hereto as **Exhibit E**.

1 203. As a result of the acts described in the preceding paragraphs, there exists a
2 controversy of sufficient immediacy and reality regarding whether Lyft infringes the claims of the
3 '838 Patent, including Lyft facing an imminent threat of restraint on free use of its non-infringing
4 products, such that a declaratory judgment of non-infringement is warranted.

5 204. Lyft has not infringed, directly or indirectly the claims of the '838 Patent by or
6 through making, using, offering for sale, selling within the United States and/or its importing of it
7 products and/or services.

8 205. The '838 Patent purports to concern "system setting up ad hoc networks." Exhibit E
9 at Abstract. The Patent describes an ad hoc network for users to coordinate and communicate with
10 one another." *Id.* at Figures 2-4.

11 206. Claim 1 of the '838 Patent provides as follows:

- 12
- 13 1. A method performed by one or more servers each having one or more processors, the
method comprising:
- 14 executing operations on the one or more processors, the operations comprising:
- 15 obtaining first data provided by a first mobile device corresponding to a vehicle,
16 the first data including a first identifier;
- 17 permitting the first mobile device corresponding to the vehicle to join a
18 communication network, the permitting based on a determination regarding the first
data;
- 19 obtaining second data provided by a second mobile device corresponding to a
20 participant, the second data including a second identifier associated with the
participant;
- 21 allowing the second mobile device corresponding to the participant to join the
22 communication network, the allowing based on a determination regarding the
second data;
- 23 receiving vehicle location data provided by the first mobile device corresponding to
24 the vehicle, wherein the vehicle location data are associated with the first identifier
and indicate coordinates of a geographical location of the first mobile device;
- 25 receiving participant location data provided by the second mobile device
26 corresponding to the participant, wherein the participant location data are
associated with the second identifier and indicate coordinates of a geographical
location of the second mobile device;
- 27 sending participant data to the second mobile device corresponding to the
28 participant, wherein the participant data comprise the vehicle location data, wherein
the second mobile device corresponding to the participant is configured to (1)

1 determine coordinates of a position on the participant map corresponding to the
2 coordinates of the geographical location of the second mobile device, (2) display
3 the participant map, and (3) place a first symbol on the participant map at the
4 determined coordinates of the position on the participant map corresponding to the
5 coordinates of the geographical location of the second mobile device;

6 sending vehicle data to the first mobile device corresponding to the vehicle,
7 wherein the vehicle data comprise the participant location data, wherein the first
8 mobile device corresponding to the vehicle is configured to (1) determine
9 coordinates of a position on the vehicle map corresponding to the coordinates of the
10 geographical location of the first mobile device, (2) display the vehicle map, and
11 (3) place a second symbol on the vehicle map at the determined coordinates of the
12 position on the vehicle map corresponding to the coordinates of the geographical
13 location of the first mobile device;

14 receiving participant selection data provided by the second mobile device
15 corresponding to the participant, the participant selection data corresponding to
16 user input provided via a display of the second mobile device;

17 based on the participant selection data, performing one or more acts selected from
18 the group consisting of: sending updated vehicle data to the first mobile device
19 corresponding to the vehicle, sending updated participant data to the second mobile
20 device corresponding to the participant, and sending a message to the first mobile
21 device corresponding to the vehicle;

22 receiving entity-of-interest data transmitted by the second mobile device, the entity-
23 of-interest data comprising coordinates of a geographical location of a new entity of
24 interest, wherein the second mobile device is configured to (1) identify participant
25 interaction with a display of the second mobile device, the participant interaction
26 indicating selection of a position on the participant map and entry of the new entity
27 of interest at the selected position, (2) display an entity symbol representing the
28 new entity of interest at the selected position on the participant map, (3) determine
coordinates of a geographical location of the new entity of interest based on
coordinates of the selected position on the participant map, and (4) transmit the
entity-of-interest data; and

29 sending the entity-of-interest data to the first mobile device corresponding to the
30 vehicle, wherein the first mobile device is configured to place the entity symbol
31 representing the new entity of interest on the vehicle map at a position on the
32 vehicle map corresponding to the geographical location of the new entity of
33 interest.

34 207. Lyft does not infringe claim 1 of the '838 Patent or any claim dependent thereon at
35 least because the activities and/or products of Lyft accused of infringing the '838 Patent, including
36 at least Lyft's Accused Products, do not infringe claim 1 literally or under the doctrine of
37 equivalents.

38 208. For example, without limitation, Lyft sends additional information beyond the
limited options in the Markush group "based on the participant selection data, performing one or

1 more acts selected from the group consisting of: sending updated vehicle data to the first mobile
2 device corresponding to the vehicle, sending updated participant data to the second mobile device
3 corresponding to the participant, and sending a message to the first mobile device corresponding to
4 the vehicle” as required by claim 1 and as alleged by AGIS Software. At least for these reasons,
5 Lyft does not infringe claim 1 of the ’838 Patent. The allegations in this paragraph are exemplary
6 and do not preclude Lyft from contending that claim 1 and the claims depending from it are not
7 infringed for additional reasons.

8 209. As another example, without limitation, Lyft does not “receiv[e] entity-of-interest
9 data transmitted by the second mobile device, the entity-of-interest data comprising coordinates of
10 a geographical location of a new entity of interest” as required by claim 1 and as alleged by AGIS
11 Software. Contrary to AGIS Software’s allegations, Lyft does not have a use “receive new entities-
12 of-interest data as required by the ’100 Patent, as Lyft relies on existing entities-of-interest.
13 Consequently, Lyft does not “receive entity-of-interest data ... comprising coordinates of a
14 geographical location of a new entity of interest” as required by claim 1 of the ’100 Patent. At least
15 for these reasons, Lyft does not infringe claim 1 of the ’838 Patent. The allegations in this paragraph
16 are exemplary and do not preclude Lyft from contending that claim 1 and the claims depending from
17 it are not infringed for additional reasons.

18 210. For at least the foregoing reasons, Lyft does not infringe any claim of the ’838 patent,
19 directly or indirectly, contributorily or otherwise through its or its user’s activities in conjunction
20 with the Lyft rider or Lyft driver applications, or any other Lyft product.

21 211. As set forth above, an actual and justiciable controversy exists between Lyft and
22 AGIS Software as to Lyft’s non-infringement of the ’838 patent.

23 212. Pursuant to the Federal Declaratory Judgment Act, 28 U.S.C. §§ 2201 *et seq.*, Lyft
24 requests that this Court enter a judgment that Lyft does not infringe, under any theory of
25 infringement, any valid claim of the ’838 patent.

26 **COUNT VI**

27 **Breach of Contract**

28 *Overview of Apple Agreement*

1 213. Lyft restates and incorporates by reference each of the allegations set forth in
2 paragraphs 1-212 above, as if fully set forth herein.

3 214. On September 18, 2017, AGIS Software Development LLC (“AGIS Software”) sued
4 Apple, Inc. (“Apple”) for patent infringement in the Eastern District of Texas in consolidated lead
5 case no. 2:17-cv-516 (“Apple Litigation”).

6 215. On information and belief, in March 2019, one or more of the AGIS Entities entered
7 into a settlement and patent license agreement with Apple (hereinafter the “Apple Agreement”),
8 which resolved the Apple Litigation. On information and belief, this information could have been
9 confirmed had AGIS Software complied with its obligations under Patent L.R. 3-2 to produce “all
10 agreements, including licenses, transferring an interest in any patent-in-suit.” But AGIS Software
11 has not produced all such agreements despite a specific request by Lyft that AGIS Software do so.

12 216. On information and belief, one or more of the AGIS Entities are parties to the Apple
13 Agreement. On information and belief, this information could have been confirmed had AGIS
14 Software complied with its obligations under Patent L.R. 3-2 to produce “all agreements, including
15 licenses, transferring an interest in any patent-in-suit.” But AGIS Software has not produced all
16 such agreements despite a specific request by Lyft that AGIS Software do so.

17 217. On information and belief, Apple is a party to the Apple Agreement. On information
18 and belief, this information could have been confirmed had AGIS Software complied with its
19 obligations under Patent L.R. 3-2 to produce “all agreements, including licenses, transferring an
20 interest in any patent-in-suit.” But AGIS Software has not produced all such agreements despite a
21 specific request by Lyft that AGIS Software do so.

22 218. On information and belief, settlement agreements executed by Apple to resolve
23 patent litigation matters may include covenants not to assert infringement based on covered Apple
24 products. *See, e.g., Perfect Co. v. Adaptics Ltd.*, 374 F. Supp. 3d 1039 (W.D. Wash. 2019).

25 219. On information and belief, the Apple Agreement includes a covenant not to sue for
26 infringement of the Patents-In-Suit based on the alleged infringement of an Apple product. *See id.*

27 220. On information and belief, the Apple Agreement has not been terminated. On
28 information and belief, this information could have been confirmed had AGIS Software complied

1 with its obligations under Patent L.R. 3-2 to produce “all agreements, including licenses, transferring
2 an interest in any patent-in-suit.” But AGIS Software has not produced all such agreements despite
3 a specific request by Lyft that AGIS Software do so.

4 221. On information and belief, as of March 2019, the Apple Agreement was an
5 enforceable contract that was binding upon AGIS Software, AGIS, Inc., AGIS Holdings, and/or
6 Malcolm K. Beyer Jr. On information and belief, this information could have been confirmed had
7 AGIS Software complied with its obligations under Patent L.R. 3-2 to produce “all agreements,
8 including licenses, transferring an interest in any patent-in-suit.” But AGIS Software has not
9 produced all such agreements despite a specific request by Lyft that AGIS Software do so.

10 222. On information and belief, the Apple Agreement remains an enforceable contract
11 that is currently binding upon AGIS Software, AGIS, Inc., AGIS Holdings, and/or Malcolm K.
12 Beyer Jr. On information and belief, this information could have been confirmed had AGIS
13 Software complied with its obligations under Patent L.R. 3-2 to produce “all agreements, including
14 licenses, transferring an interest in any patent-in-suit.” But AGIS Software has not produced all
15 such agreements despite a specific request by Lyft that AGIS Software do so.

16 223. On information and belief, the Apple Agreement has not expired. On information
17 and belief, this information could have been confirmed had AGIS Software complied with its
18 obligations under Patent L.R. 3-2 to produce “all agreements, including licenses, transferring an
19 interest in any patent-in-suit.” But AGIS Software has not produced all such agreements despite a
20 specific request by Lyft that AGIS Software do so.

21 224. On information and belief, any and all conditions precedent necessary to enforce the
22 terms of the Apple Agreement have been satisfied.

23 225. On information and belief, Apple has fully performed any and all obligations
24 required of it under the Apple Agreement.

25 *The Asserted Patents in in the Eastern District of Texas litigation*

26 226. On information and belief, the Apple Agreement covers the Patents-in-Suit, which
27 are related to patents asserted against Apple by AGIS Software. On information and belief, this
28 information could have been confirmed had AGIS Software complied with its obligations under

1 Patent L.R. 3-2 to produce “all agreements, including licenses, transferring an interest in any patent-
2 in-suit.” But AGIS Software has not produced all such agreements despite a specific request by
3 Lyft that AGIS Software do so.

4 *The Apple Agreement Covers the Products Accused in the Eastern District of Texas litigation*

5 227. On information and belief, the Apple Agreement covers Apple iOS products which
6 AGIS Software accused of infringing the Patents-in-Suit or related patents.

7 *The Accused Products in the Eastern District of Texas litigation are Licensed Products*

8 228. Lyft’s application(s) may be installed on iPhones or other iOS devices.

9 229. On information and belief, Lyft’s application(s) installed on an iPhone or other iOS
10 device would be licensed by the Apple Agreement. On information and belief, this information
11 could have been confirmed had AGIS Software complied with its obligations under Patent L.R. 3-
12 2 to produce “all agreements, including licenses, transferring an interest in any patent-in-suit.” But
13 AGIS Software has not produced all such agreements despite a specific request by Lyft that AGIS
14 Software do so.

15 230. In its infringement contentions served May 19, 2021 as part of its Eastern District of
16 Texas litigation against Lyft alleging patent infringement, attached as Exhibit F, AGIS Software
17 accused the Lyft application installed on all iOS mobile devices.

18 231. In its infringement contentions served February 25, 2022 as part of this lawsuit, AGIS
19 Software accused the Lyft application installed on iOS mobile devices and has not formally
20 withdrawn its allegations against iOS devices.

21 232. AGIS Software included a picture of the Lyft application running on an iPhone in its
22 E.D. Tex. complaint and its infringement contentions in this case. *See, e.g., AGIS Software*
23 *Development LLC v. Lyft, Inc.*, Civil Action No. 2:21-cv-00024-JRG (E.D. Tex.), Dkt. 1 at page 14;
24 Exhibit G at A-29.

25 *AGIS Software Breached the Covenant Not to Sue Provision of the Apple Agreement*

26 233. On January 29, 2021, AGIS Software sued Lyft for patent infringement of the ’970
27 Patent, ’724 Patent, ’728 Patent, ’838 Patent, and the ’100 Patent, alleging infringement based on
28 Lyft’s application(s) installed on iOS devices.

1 Lyft's users claiming the Patents-in-Suit are infringed, or for representing that Lyft's products or
2 services, or that others' use thereof, infringe the Patents-in-Suit;

3 3. For a declaration that this case is exceptional under 35 U.S.C. § 285 and for an award
4 of attorneys' fees and costs in this action; and

5 4. For such other and further relief as this Court may deem just and proper.

6 **DEMAND FOR JURY TRIAL**

7 Lyft respectfully demands a jury trial in this action on all issues so triable.

8 Dated: March 28, 2022

By: /s/ Jeremy Taylor

9 Jeremy Taylor

10 Jeremy J. Taylor (SBN 249075)

11 Arya Moshiri (SBN 324231)

Baker Botts L.L.P.

12 jeremy.taylor@bakerbotts.com

13 arya.moshiri@bakerbotts.com

14 101 California St., Suite 3600

15 San Francisco, CA 94111

16 Telephone: (415) 291-6200

17 Facsimile: (415) 291-6300

18 Bethany R. Salpietra (*pro hac vice*)

Baker Botts L.L.P.

19 bethany.salpietra@bakerbotts.com

20 2001 Ross Ave., Ste. 900

21 Dallas, TX 75201

22 Telephone: (214) 953-6500

23 Facsimile: (214) 953-6503

24 *Attorneys for Plaintiff Lyft, Inc.*

25
26
27
28

Exhibit A



US007031728B2

(12) **United States Patent**
Beyer, Jr.

(10) **Patent No.:** US 7,031,728 B2
 (45) **Date of Patent:** Apr. 18, 2006

(54) **CELLULAR PHONE/PDA COMMUNICATION SYSTEM**

(76) Inventor: **Malcolm K. Beyer, Jr.**, 92 Lighthouse Dr., Jupiter Inlet Colony, FL (US) 33469-3504

(*) Notice: Subject to any disclaimer, the term of this patent is extended or adjusted under 35 U.S.C. 154(b) by 0 days.

(21) Appl. No.: **10/711,490**

(22) Filed: **Sep. 21, 2004**

(65) **Prior Publication Data**

US 2006/0063539 A1 Mar. 23, 2006

(51) **Int. Cl.**

H04Q 7/20 (2006.01)

(52) **U.S. Cl.** **455/456.3; 455/457; 455/420**

(58) **Field of Classification Search** 455/456.3, 455/418, 456.1, 419, 556.2, 420, 88, 41.2, 455/41.3, 416, 414.4, 412.2-412.1, 415, 455/457, 404.2, 442.1, 427, 431, 500, 517, 455/518, 519, 516, 564, 458, 463

See application file for complete search history.

(56) **References Cited**

U.S. PATENT DOCUMENTS

5,555,286 A * 9/1996 Tendler 455/404.2

6,204,844 B1 *	3/2001	Fumarolo et al.	715/736
6,542,475 B1 *	4/2003	Bala et al.	370/271
6,775,560 B1 *	8/2004	King et al.	455/566
6,868,337 B1 *	3/2005	Muramatsu	701/211
2001/0044321 A1 *	11/2001	Ausems et al.	455/556
2003/0139150 A1	7/2003	Rodrigues et al.	
2004/0192331 A1 *	9/2004	Gorday et al.	455/456.1
2004/0266456 A1 *	12/2004	Bostrom et al.	455/456.3
2005/0130634 A1 *	6/2005	Godfrey	455/414.1

* cited by examiner

Primary Examiner—Aung Moe

(74) Attorney, Agent, or Firm—Malin, Haley & DiMaggio, P.A.

(57) **ABSTRACT**

A cellular PDA communication system for allowing a plurality of cellular phone users to monitor each others' location and status, to initiate cellular phone calls by touching a symbol on the display screen with a stylus or finger which can also include conferencing calling. The system also provides for remote activation of a cellular phone by an initiator causing the remote cellular phone to annunciate audio announcements, to call another phone number, to increase the volume of the speaker, to vibrate or to display images or videos. All this is accomplished with a conventional cellular phone PDA that includes GPS navigation with an enhanced improved software program.

15 Claims, 3 Drawing Sheets

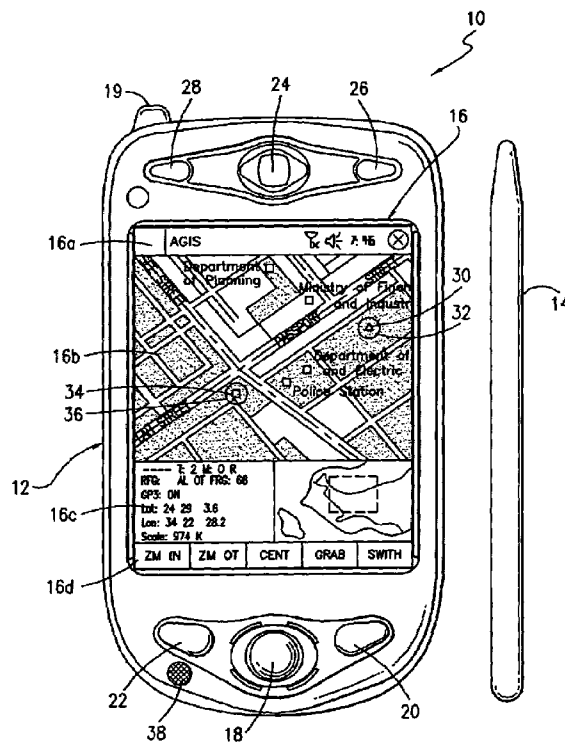

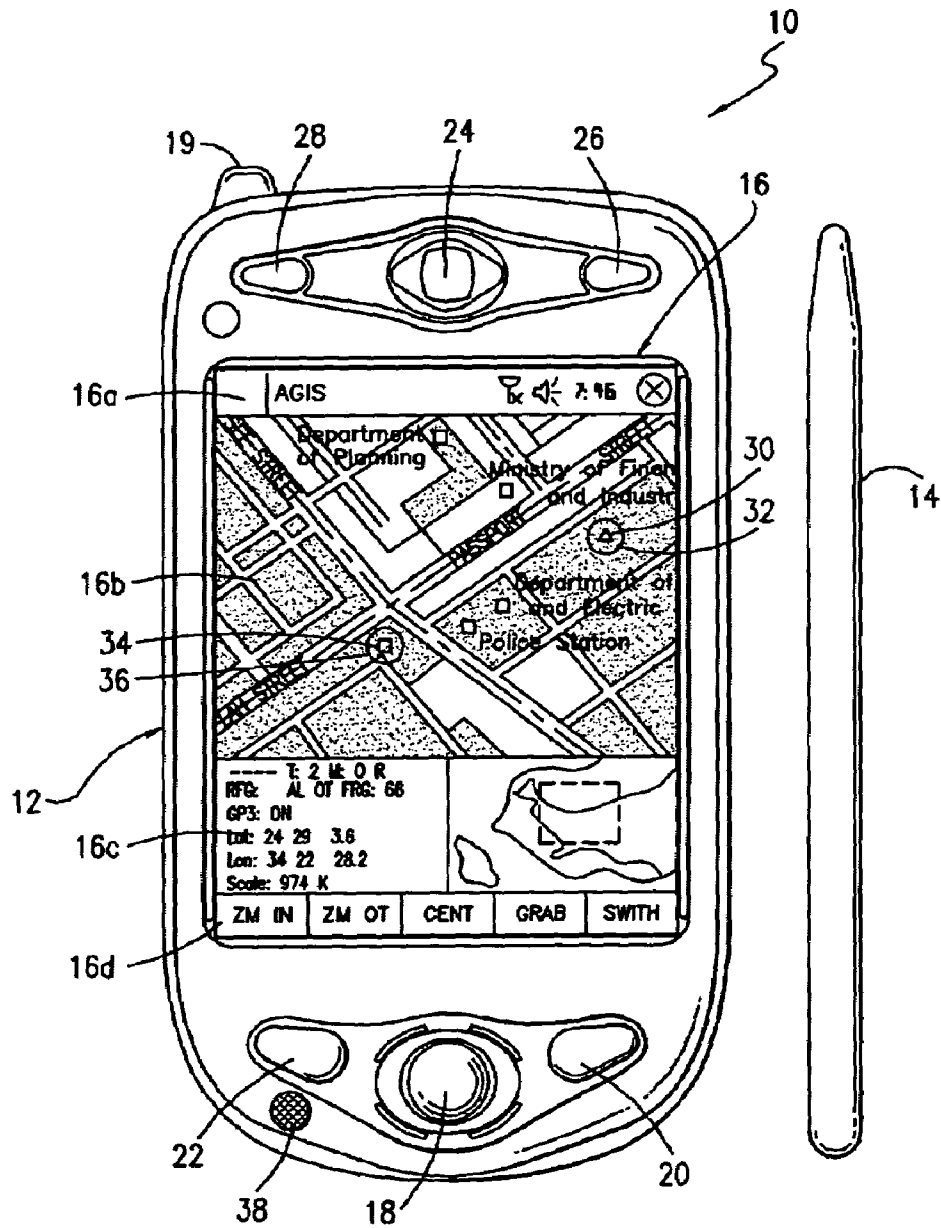

FIG. 1

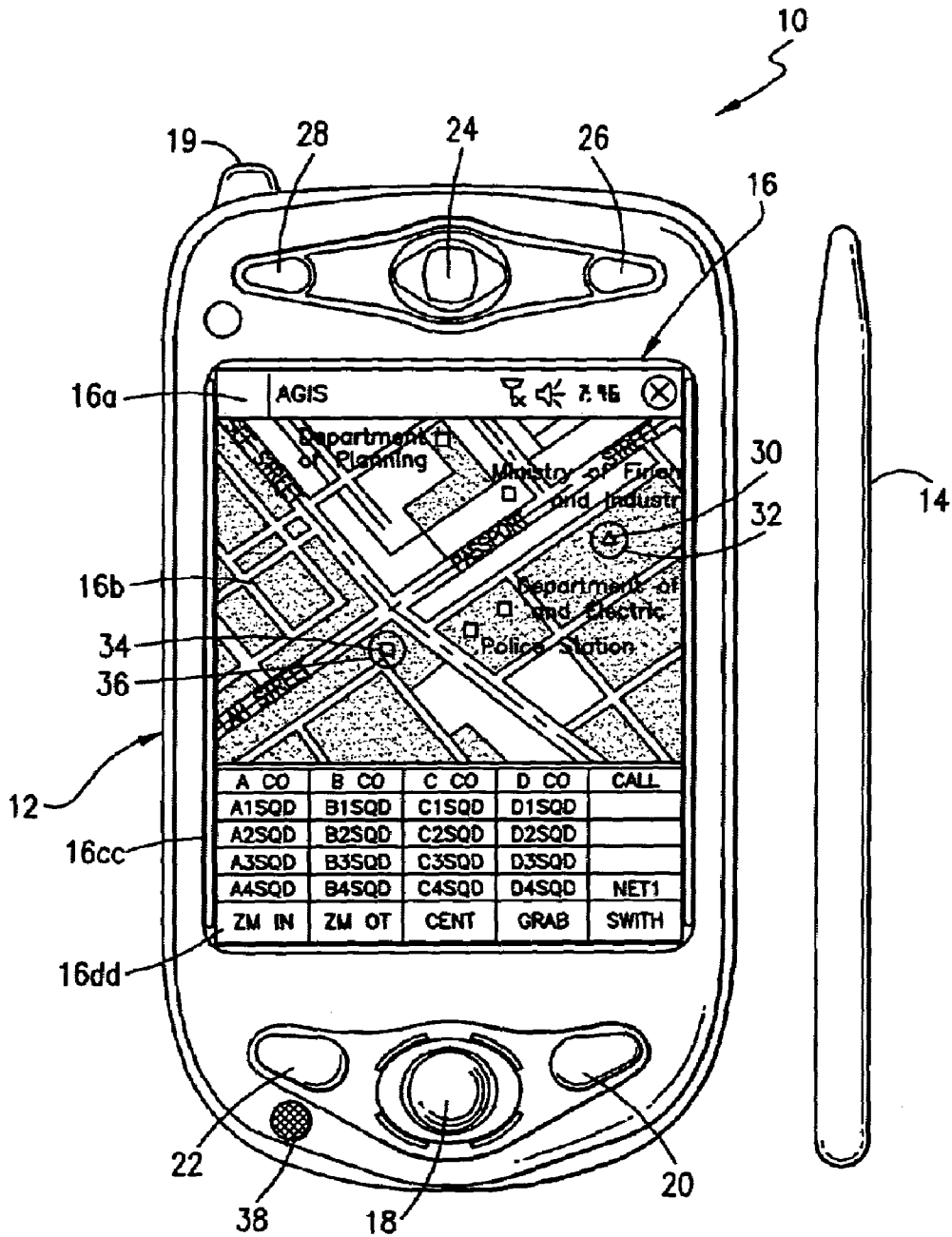
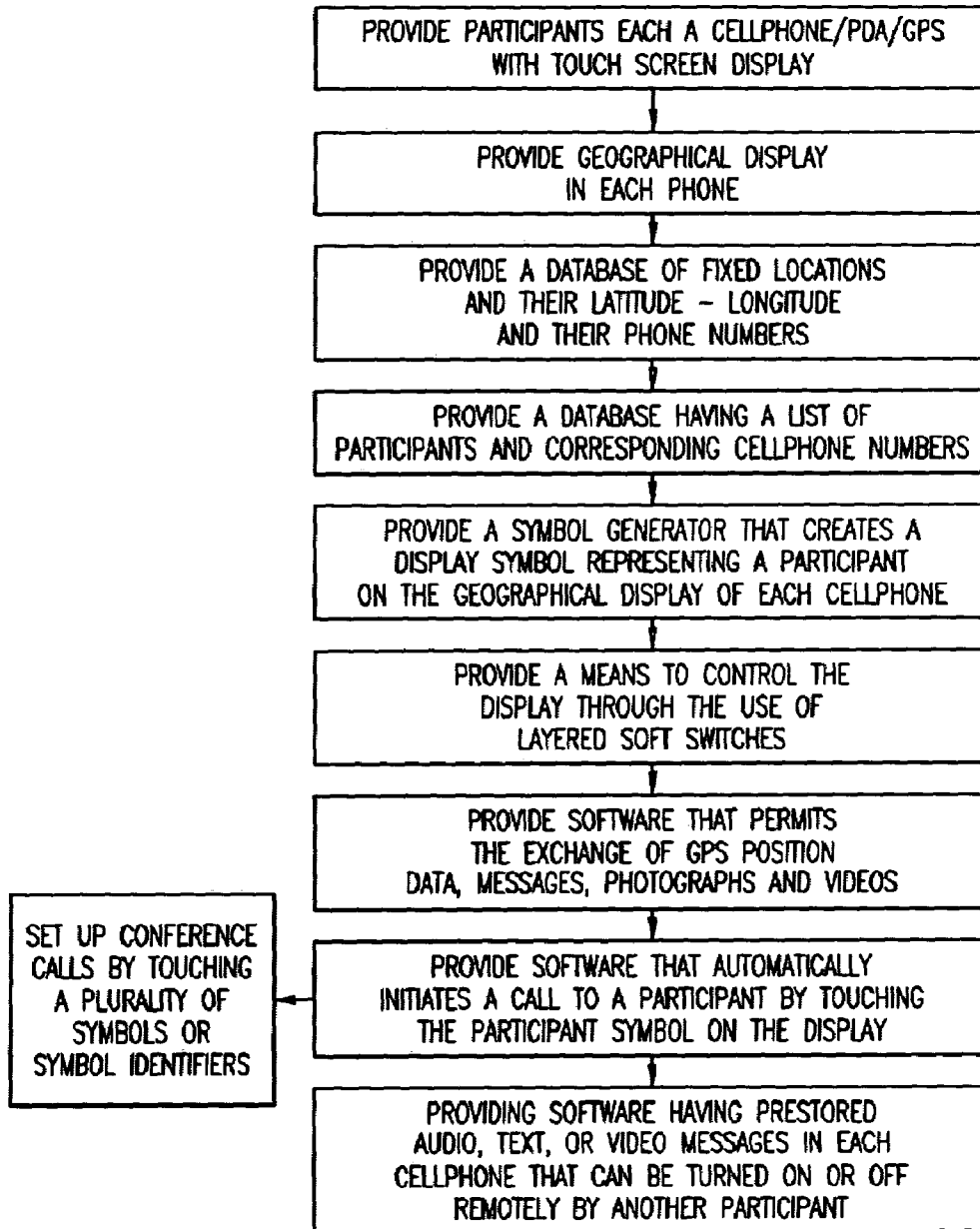

FIG. 2

FIG. 3

US 7,031,728 B2

1

CELLULAR PHONE/PDA COMMUNICATION SYSTEM

FIELD OF THE INVENTION

This invention relates generally to an integrated communications system using a plurality of cellular PDA/GPS phones for the management of a group of people through the use of a communications net and, specifically, provide each user with a cellular phone that has features that permit all the users to know each other's locations and status, to rapidly call and communicate data among the users by touching display screen symbols and to enable the users to easily access data concerning other users and other database information.

DESCRIPTION OF RELATED ART

The purpose of a communications system is to transmit information bearing signals from a source, located at one point, to a user destination, located at another point some distance away. A communications system is generally comprised of three basic elements: transmitter, information channel and receiver. One form of communication in recent years is cellular phone telephony. A network of communication cells set up around an area such as the United States allows multiple users to talk to each other, either on individual calls or on group calls. Some cellular phone services enable a cellular phone to engage in conference calls with a small number of users. Furthermore, cellular conference calls can be established through 800 number services. Cellular telephony also now includes systems that include Global Positioning System (GPS) navigation that utilizes satellite navigation. These devices thus unite cellular phone cellular technology with navigation information and computer information transmission and receipt of data.

Digital SMS (Smart Message Service) and TCP/IP messages can be transmitted using cellular technology such as the various versions of GSM and CDMA or via a WiFi local area network. One implementation of these GPS location reporting cellular systems is for the data to go to a central site where the information is displayed for a person to monitor the locations of the units that have the combined GPS cellular phone. Another implementation permits the cellular phone users to also view the location of other GPS equipped units. A drawback of the current implementation is that these systems are either all on or all off. There is no way to selectively activate participants or to stop the participants from participating in the network. Another drawback of the use of the current combined cellular phone PDA technology is that when using the PDA to display a map (that also may depict georeferenced businesses, homes and other facilities' locations and phone numbers), and the operator wants to place a call, the cellular phone/PDA operator is required to obtain the phone number by touching the display screen at the correct location of that entity on the map to obtain the phone number, then the operator has to memorize the phone number, then go to a different display to enter the phone number, to make the call and then, if desired, go back to the map display. Needless to say, this is a cumbersome process. Sending a text message to a location, business, home or facility that appears on a PDA map display to another cellular phone can also be a cumbersome process as the PDA operator has to find the phone number on the map display, memorize the phone number, then go to a different display to enter a text message, enter the text message, send the text message and then shift back to the map display program.

2

Furthermore, for a phone to send data concerning a new entity of interest (car, person, tank, accident, or other entity) the operator must type in the information and the latitude and longitude of the entity.

5 In spite of the rapid advance in cellular phone technology, it would also be desirable to actuate a remote cellular phone to announce an audio message to alert the remote user that there is an emergency (or for another reason) and that the calling cellular phone should be called immediately. Furthermore, it would be desirable to cause the remote phone to display a text message, photograph, video clip or video transmission, to announce the caller's name and to be able to control a remote phone and cause the remote phone to call another phone number (as an example, to automatically establish an 800 number conference call), to vibrate, or increase the loudness of an announcement without any action by the remote phone operator.

The present software invention overcomes many of these problems shown in the prior art by providing a cellular phone/PDA/GPS user: a) the ability to selectively poll each of the other PDA/GPS phones to start reporting their positions and status information directly to all or selected users equipped with cellular phone/PDA communication/GPS system in the communications net so that each of the systems that the data is transmitted to is provided a display of the location, status and other information of the other users; b) the ability to exchange other entities of interest information and to assign these entities a category (car, person, tank, accident, or other entity) by touching the display screen at their locations on the map, and selecting the appropriate category switch; c) the ability to make rapid voice and data call initiation to locations, businesses, homes and facilities whose phone number is available in a georeferenced database including the cellular phone/PDA/GPS systems in a communications net by touching the display screen at the appropriate location on the PDA display and selecting a call switch; d) the ability to make rapid voice and data conference call initiation to locations, businesses, homes and facilities whose phone number is available in a georeferenced database including the cellular phone/PDA/GPS systems in a communications net by touching the display screen at the appropriate locations on the PDA display and selecting a conference call switch; e) the ability to remotely control from one cellular phone/PDA/GPS any of the other cellular phone/PDA/GPS systems phones including the ability to control remote cellular phones to make verbal prerecorded announcements, place return calls, place calls to another phone number, vibrate, execute text to speech software, change sound intensity and process and display information by touching the display screen at their location on the PDA display and selecting the appropriate switch; and f) the ability to layer a sufficient number of switches or buttons on the PDA display to perform the above functions without overlaying the map.

U.S. Patent Application No. 2003/0139150 published Jul. 24, 2003 shows a portable navigation and communication system. In one embodiment, the system combines within a single enclosure a GPS satellite positioning unit, mobile telephony using cellular phone technology and personal computing capable of wired or wireless internet or intranet access using a standard operating system. The purpose of this invention is to provide portable navigation for an individual. However, to operate the device, one still needs to utilize a keypad with the telephone functions. U.S. Patent Application No. 2003/0139150 described a wireless communication operating the PDA in a conventional manner. There is no provision for displaying the location of other

US 7,031,728 B2

3

similarly equipped systems. There is no provision to cause other similarly equipped cellular phone PDA users to transmit their location. There is no provision for entering other entities of interest by touching the display screen at their locations on a map. There is no provision for making a telephone call by touching the display screen at a net participant's symbol to initiate automatically the telephone call to that user or by touching multiple symbols to make conference calls. There is no provision for sending text messages, photographs or videos by touching the net participant(s)' symbol(s) on the display screen to automatically send text messages, photographs or videos to that participant or participants. There is no description or disclosure of a procedure to cause digital messages to be sent to a remote cellular phone that would cause the cellular phone to make verbal announcements, increase sound intensity, vibrate or to call back or to call another phone number. There is no description of the uses of layered soft switches which confine the switches to a particular vicinity of the PDA's display screen.

SUMMARY OF THE INVENTION

A method and system employing cellular telephone communications to provide the location information to a group of geographically dispersed people, and to enable the rapid transmission of data concerning entities of interest to the members of the group and to coordinate the activities of the group through data and voice communications. Each of the cellular telephones includes a visual display with a touch screen, a global positioning system (GPS) receiver and navigation display, a CPU, memory, power supply, battery, microphone, speaker and commercially available software. To this is added: a) communications data and voice exchange software, b) a map database and a database of geographically referenced fixed locations including military bases, homes, businesses, government facilities, street locations and the like, each with a specified latitude and longitude, along with, if available, phone numbers that are associated with each of these entities, c) another database with the constantly updated GPS location and status of all the software equipped cellular phone/PDA/GPS systems that are part of the communications net.

Each cellular phone/PDA/GPS system is identified on the display of the other phone systems by a symbol that is generated to indicate its identity. The symbol is placed at the correct geographical location and is correlated with the map on the display. Each cellular phone/PDA/GPS System may enter other entities (locations of people, vehicles, buildings, facilities, and other entities) into its database. This information can be likewise transmitted to all the other participants on the communications net. The map, fixed entities, and cellular phone/PDA/GPS System communications net participants' latitude and longitude information is related to the display x, y display locations by a mathematical correlation algorithm.

When the cellular phone/PDA/GPS System user uses his stylus or finger to touch one or more of the symbols or a location on the cellular phone display, the system's software causes the status and latitude and longitude information concerning that symbol or location to be displayed.

To operate the present invention, the operator ("cellular phone one" or "phone one") starts the system by selecting the software which causes: a) the cellular phone to initiate (if it has not already been activated), b) the GPS interface to be established, c) a map of the geographic area where the operator is located and operator's own unit symbol to appear

4

at the correct latitude and longitude on the map, d) the locations of people, vehicles, buildings, and the like that are part of the database appear as symbols on the map, e) the system selected item read out area (which provides amplification information for the communications net participant or object that has been touched on the display screen) to appear on the display, f) an insert area that contains various varying data including: the list of net participants, a list of messages to be read, an indication of what portion of the map is being displayed in major area and other information to appear on the display, and g) a row of primary software created "soft switches" that are always present on the display. One of these soft switches when touched causes a matrix of software driven layered switches (soft switches) to appear on the display in place of the readout and insert areas. Some of these soft switches, when touched, cause the system's functions to occur. Other soft switches cause yet another layer of soft switches to appear, replacing those that were previously displayed. The operator is provided an indication of where the operator is in the layer of switches, and is able to return to the previous layer or to cause the layered switches to disappear and only the basic switches to remain. The operator can also use the phone's hardware pointing device (Navigation Pad) to control the soft switches. By using these soft switches, and hard switches that are part of the cellular phone, the operator can activate different maps, change map scales, select which fixed entities are desired to be displayed, display the information concerning the symbol the operator has touched, initiate phone voice calls, send messages (text, photographs and videos), enter symbols and information representative of other entities, view the locations and statuses of the other communications net participants, establish conference calls, pre-establish conference sub-nets that, when activated, cause all the phone numbers that are specified to be conferenced for voice, text and photograph and video communications, and transmit messages to remote phones which cause the remote phones to make calls, verbal announcements, vibrate, increase sound levels and other functions. To initialize the communications net, the cellular phone one operator selects, from a list, the other users (or all of them), that the operator desires to be part of the communications net. The system then polls the selected phones to activate and become part of the communications net. The selected phones then transmit their positions to all the other phones in the established net. Through interaction with one or more other software enabled cellular phones, symbols are generated on the operators' displays based on the participants' latitude and longitude that is exchanged between the cellular phones. The transmission of this information is based on an algorithm that considers time and or movement or upon a polling request. Each of the communication net symbols on the display represent a different cellular phone remote from cellular phone one. Each of the cellular phones has the phone numbers of all the phones in the communications net in its database. Each of the phones also has in its database the pre-established phone numbers for the fixed locations: people, buildings, facilities, military bases, and other desired locations that can be called in its database. The touch screen provided with the LCD display in the cellular phone includes x, y coordinates that are correlated with the map on the cellular phone display and the geographic location of the fixed sites and the cellular phones in the communications net. Each cellular phone can enter objects of interest by touching the display screen at the object's location on the display screen map. The operator can then assign these objects a category (car, person, tank, accident, or other

US 7,031,728 B2

5

category). The latitude and longitude of these objects along with their category and other information is then sent on the communications network. Because each of the receiving telephone units has software that automatically converts the received data to the correct map location, the transmitted symbols appear at the correct location without operator intervention and their category information is available by touching the symbol on the display screen.

Each cellular phone/PDA/GPS has the communications hardware along with the circuitry in software to initiate a voice telephone call or transmit data messages, photographs, or videos by touching the screen with a stylus or finger at the symbol location displayed on the screen of the desired phone to be called and then selecting the "call" software switch on the display touch screen. The software will then cause the cellular phone to call to the specific phone number represented by the symbol on the screen. This is done automatically. This action alleviates completely the necessity of actually looking up a phone number and manually entering the phone numbers required to make a cellular phone call.

A further benefit of the present invention is that more than one symbol can be specified to receive a cellular phone voice call and or data call, thus automatically conferencing them. The operator of the cellular phone can conference a small number of phones by touching the display screen locations of the communications net participant symbols that the operator wishes to conference by selecting a "conference" soft switch. This action will then cause the selected units to be conferenced together. The conference call can be expanded to a greater number of users by providing additional software that would conference phones by sending a digital message to the remote cellular phones from the operator cellular phone causing each of the remote cellular phones to dial a specified 800 conference call number and enter each individual phone participant code. The originator phone calls the same number and automatically enters the originator host code. Once all the phones have dialed the 800 number and entered their appropriate participant and host numbers, the conference call will be established. Furthermore, the operator of cellular phone one can pre-establish conference nets for voice and data exchange by either selecting them from a list or a table or by touching the display screen locations of the communication net participant symbols that the operator wishes to conference and selecting a "conference net" soft switch. Once the operator has done that, the software associates those communication net participants as being part of an established conference net. When the cellular phone operator chooses to call all the net participants, all the operator has to do is to select the designated software switch for that net to conference the pre-selected conference participants together. That action will then place a call to all the conferences without further action. This method of conference calling can be also used to send text messages, photographs and videos.

Another embodiment of the invention can include a unique feature in which cellular phone one can send a digital message using SMS, TCP/IP or another protocol to another cellular phone on the communications net by touching a display screen symbol on the geographical screen and then selecting the appropriate software switch to transmit a digital message that would then remotely activate a program in the remote cellular phone to play a recorded audio file to announce an emergency and that a call to cellular phone one is required immediately. Since each of the remote cellular phones has the same software as cellular phone one and includes a PDA and the ability to receive digital messages, the ability to control remote cellular phones to make verbal

6

announcements, display images, place return calls, place calls to another phone number, vibrate, change sound intensity and process and display pre-stored data, images and video can be achieved.

In accordance with the present invention, a multiple cellular phone communication network is set up using the invention. Each cellular phone contains the same software and circuitry that includes cellular phone technology, GPS navigation technology, and a PDA for displaying maps, georeferenced symbols, and data concerning symbols of interest and software created soft switches, transmitting and receiving digital SMS, TCP/IP and other protocol messages. To establish each other's communication net IP addresses, the cellular phones first exchange SMS messages (or use another method) that identifies their IP addresses. Each phone then transmits to all others its location and status in accordance with an established algorithm that is based on time and or movement. Each cellular phone is also able to poll the other cellular phones to transmit their locations. Each user is able to transmit to all the other users: text messages, photographs and videos. Using the present invention, a cellular telephone network can be set up in which all of the parties in the network have almost automatic and instant access to and status of any and all other parties in the network by touching the display screen symbol of the party he desires to initiate voice and data calls, thus, instantly activating the calls. This is an immense time saver in dealing with a cellular phone network for all the parties combined.

It is an object of this invention to provide an improved cellular telephone communication network among a plurality of cellular phones for greatly increasing the call up and initiation speed of each of the cellular phones with each other.

And yet another object of this invention is to enable each participant to automatically exchange IP addresses using SMS or another digital message format.

And yet another object of this invention is to enable each participant in the communications net to poll the other net participants to report or cease reporting their locations and status on the communication net.

And yet another object of this invention is to enable each participant in the communications net to be able to easily transmit entities of interest to the other participants of the net by touching the display at the entities' location on the map and causing a symbol to be entered and then entering the entities' category information.

And yet another object of this invention is to provide for initiating a cellular phone telephone call to another phone by touching the other phone's symbol on the screen of the cellular phone, which automatically activates the telephone call.

And yet another object of this invention is to provide a cellular phone network that provides for instant conference calling among a plurality of cellular phones by touching the screen of specific symbols for initiating the calls.

And yet another object of this invention is to provide a cellular phone network that provides for instant conference voice, text, photographs and video exchange by pre-establishing conferencing sub-nets and the subsequent activation of one of those sub-nets to establish a conference call.

And yet still another object of this invention is to provide a cellular phone that allows for remote alarm activation on another cellular phone to cause a remote cellular phone to make verbal announcements, display images, place return calls, place calls to another phone number, vibrate, change sound intensity and process and display pre-stored data, images and video.

7

In accordance with these and other objects which will become apparent hereinafter, the instant invention will now be described with particular reference to the accompanying drawings.

BRIEF DESCRIPTION OF THE DRAWINGS

FIG. 1 shows a front plan view of a cellular phone/PDA and display in accordance with the present invention.

FIG. 2 shows a front plan view of the cellular phone/PDA of FIG. 1 with a different display.

FIG. 3 shows a flow chart of the operation of the present invention.

DETAILED DESCRIPTION

Referring now to the drawings and, in particular, FIG. 1, the present invention is shown generally at **10** that includes a small handheld cellular phone/PDA communications system in housing **12** that includes an on/off power switch **19**, a microphone **38**, and an LCD display **16** that is also a touch screen system. The small area **16a** is the Navigation Bar that depicts the telephone, GPS and other status data and the active software. With the touch screen system, the screen symbols are entered through GPS inputs or by the operator using a stylus or finger **14** by manipulatively directing the stylus or finger **14** to literally touch display screen **16**. The soft switches displayed on the screen are likewise activated by using a stylus or finger **14** and physically and manipulatively directing the stylus or finger to literally touch display screen **16**. The display x, y coordinates of the touched point are known by a CPU in the PDA section of the communication system that can coordinate various information contained in the PDA portion relative to the x, y coordinate position on the screen. Inside housing **12** is contained the conventional cellular phone elements including a modem, a CPU for use with a PDA and associated circuitry connected to a speaker **24** and a microphone **38**. A GPS navigational system that can determine the latitude and longitude of the cellular phone can be internal or external to the housing **12**. PDA/cellular phone units such as these are currently on sale and sold as a complete unit (or with an external connected GPS) that can be used for cellular telephone calls and sending cellular SMS and TCP/IP or other messages using the PDA's display and computer. The GPS system is capable of determining the latitude and longitude and through SMS, TCP/IP, WiFi or other digital messaging software, to also transmit this latitude and longitude information to other cellular phones via cellular communications, WiFi or radio. The unit includes a pair of cellular phone hardware activating buttons **20** to turn the cellular phone on and **22** to turn the cellular phone off. Navigation Pad actuator **18** is similar to a joy or force stick in that the actuator **18** manually provides movement commands that can be used by the PDA's software to move a cursor. Switches **26** and **28** are designed to quickly select an operator specified software program. Device **24** is the system's speaker. Device **38** is the system's microphone. Switch **19** at the top left of the unit is the power on and power off switch.

The heart of the invention lies in the software applications provided in the system. Mounted inside housing **12** as part of the PDA is the display function screen and the CPU. The CPU includes databases that provide for a geographical map and georeferenced entities that is shown as display portion **16b** that includes as part of the display various areas of interest in the particular local map section.

8

When looking at display **16**, the software switches which appear at the very bottom of the display **16d** are used to control many of the software driven functions of the phone. The software drawn and controlled switches are activated through the operator's use of the Navigation Pad **18**, or a small track ball, force stick or similar hardware pointing device. Alternatively, the operator may chose to activate the software switch matrix by touching the screen with his finger or stylus at the switches' locations. When some of the software switches are activated, it will cause yet different software switches to appear. The bar display **16d** shows the software switches "ZM IN, (zoom in)" "ZM OT (zoom out).", "CENT (center)" "GRAB, (pan/grab)" at the bottom of the screen. These software switches are for the operator to perform these functions. The "SWITH (switch)" software switch at the lower right causes the matrix of layered software switches to appear above the bottom row of switches. Through use of the software switches, one can also manipulate the geographical map or chart display. When looking at FIG. 1, permanent geographical locations and buildings are shown. For example, the police station is shown and when the symbol is touched by the stylus or finger, the latitude and longitude of the symbol's location, as shown in display section **16c**, is displayed at the bottom left of the screen. The bottom right side of display **16c** is a multifunction inset area that can contain a variety of information including: a) a list of the communication link participants; b) a list of received messages; c) a map, aerial photograph or satellite image with an indication of the zoom and off set location of the main map display, which is indicated by a square that depicts the area actually displayed in the main geographical screen **16b**; d) applicable status information; and e) a list of the communication net participants.

Also shown on the display screen **16**, specifically the geographical display **16b**, is a pair of different looking symbols **30** and **34**, a small triangle and a small square, which are not labeled. These symbols **30** and **34** can represent communication net cellular phone users in the displayed geographical area that are part of the overall cellular phone communications net used in this invention wherein each of the users has a similar cellular phone to the one shown in FIG. 1. The latitude and longitude of symbol **30** is associated within a database along with a specific phone number. The screen display **16b**, which is a touch screen, provides x and y coordinates of the screen **16b** to the CPU's software. The software has an algorithm that relates the x and y coordinates to latitude and longitude and can access a communications net participant's symbol or an entity's symbol as being the one closest to that point. In order to initiate a telephone call to the cellular phone user represented by symbol (triangle) **30** at a specific GPS provided latitude and longitude which has been sent to the cellular phone shown in FIG. 1, the operator or initiator of what we call cellular phone one in FIG. 1 can take the stylus or finger **14**, touch the triangle **30** with the stylus or finger, and then touch a "call" software switch from a matrix of displayed switches that will overlay the display area **16c** and immediately the cellular phone one will initiate a cellular phone telephone call to the cellular phone user at the location shown that represents symbol **30**. A second cellular phone user is represented by symbol **34** which is a small square but could be any shape or icon to represent an individual cellular phone unit in the display area. The ring **32** around symbol **30** indicates that the symbol has been touched and that a telephone call can be initiated by touching the soft switch that says "call." When this is done, the

telephone call is placed. Another type of symbolic display can indicate that the call is in effect. Furthermore, the operator of cellular phone one can call the police station or other locations, buildings, or facilities (whose phone numbers are stored in the database) by touching them on the display screen using the stylus or his finger and then the call switch. Additionally, the operator can touch both symbol **34** and symbol **30** and can activate a conference call between the two cellular phones and users represented by symbols **30** and **34**. Again, a symbolic ring around symbol **34** indicates that a call has been initiated.

The system shown in FIG. 1 can also initiate a telephone conference call for a small number of phones using a stylus or finger contact to touch all the displayed symbols on display **16** that the initiator desires to conference and then selecting the conference call soft switch. The operator can also pre-establish a conference sub-net that the operator desires to be able to rapidly call. The operator performs this task by touching the symbols or by selecting participants from a list or a matrix of the participant addresses and assigning the participants to a net software switch. When the operator desires to place a conference call to these participants, the operator simply touches the net soft switch associated with this group. Software is provided in the unit that mimics setting up a normal small conference call from "phone one" to each of the cellular phones the user had indicated by touching their symbols or selecting their sub-net soft switch on the screen. Once the first call is complete, the party will be automatically put on hold and other callers will be called or answered in sequence and put on hold until all the parties are on line at which time the conference call will be announced at each phone. As each participant is called, the phone will announce that a conference call requested by cellular phone one is in progress. This will all be done by software.

If a conference call is desired that includes more than a small number of phone users, the use of an 800 number conferencing service is required. The initiator or operator of cellular phone one would select the "conference 800" call software switch and then use the stylus or finger to touch the cellular phone users' symbols to whom the calls are to be placed. For example, 50 users are desired on a conference call. The cellular phone would send out a SMS or TCP/IP message to all of the cellular phone displays that requests each cellular phone to call an 800 number (the given number for a conference call) to conference with cellular phone one. Each individual cellular phone user at that point in time would then be verbally notified that a conference call was requested. When the user selected the "accept" software switch, the phone would then call the 800 number and enter its conference participant code.

Another feature available in the cellular phone/PDA system shown in FIG. 1 is its ability to activate a remote cellular phone to make verbal announcements, display images, place return calls, place calls to another phone number, vibrate, change sound intensity and process and display pre-stored data, images and video. As an example, on the PDA screen display **16**, a software switch will be provided that would allow cellular phone one to call in an emergency situation and that would basically initiate an emergency audio response call. Using the stylus or finger again, a symbol such as **30** would be touched with the stylus or finger indicating a call to be made. The software switch labeled "call" would cause other software switches to appear, one of which would be "call provide emergency audio response" which when touched by the stylus or finger **14** would cause the cellular phone one system to automatically call the telephone num-

ber represented by symbol **30**. The cellular phone **30** includes software that when it receives the SMS or TCP/IP message, can activate an audio message that announces "emergency please call cellular phone one immediately." The announcement would be done through the cellular phone speaker.

Thus, the system is capable of initiating a cellular phone call by touch only, initiating conference call by touch only and activating a remote cellular phone to announce an emergency and other messages and elicit the audio response in the remote cellular phone by touch only.

Referring now to FIG. 2, the same cellular phone/PDA **10** is shown with the soft switch matrix displayed at **16cc** and **16d**. The cellular phone/PDA is capable of an alternative method of contacting the participants. As shown in FIG. 2 and display **16cc**, a plurality of squares is displayed having letters and numbers, each square of which indicates a different participant such as "AISQD." Also, on the right hand side, top line is a switch option called "call." The bottom line **16dd** shows ZM IN, ZM OUT, CENT, GRAB and SWIT. Using this alternative telephone method, the initiator can touch individual squares, each having a reference to a participant to initiate one call or a conference call with all of the parties. These can also be joined in a single NET **1** as shown. Subsequent phone calls with the particular designated parties or participants established with NET **1** can subsequently be initiated just by touching NET **1** with the stylus or with a finger. The displayed information can be layered with a plurality of "NETS" on a next layer for contacting groups of participants in each NET. This is used in lieu of the screen symbols for conference calls.

Referring now to FIG. 3, a flow chart is shown of the activities provided by the present invention and the methodology. First, we provide a cellular phone that includes PDA computer technology and a GPS navigation system that provides to the PDA the location of the cellular phone in latitude and longitude at all times. The cellular phone includes an LCD display with touch screen features for use with a stylus or finger.

The communication device is also given a database that includes a geographical display on the LCD display and software that coordinates the x and y coordinates on the LCD display touch screen with the geographical display. There is also software that places symbols on the geographical display that represent other cellular phone users that are part of the communications net. All the participant's cellular phones that are a part of the communications net include an integrated or electronically connected GPS navigational system. Each phone can call the other cellular phones and request that they broadcast their latitude and longitude locations and status information. Each cellular phone can enter other entities of interest and assign each of them a category (car, person, tank, accident, or other category). The latitude and longitude of each of these entities along with each category is then sent on the communications network. Each phone can also have the latitude and longitude and phone numbers of fixed (geographically referenced fixed locations including: restaurants, gas stations, hospitals, fire departments, military bases, homes, businesses, government facilities, street locations, and the like) are also contained in the data base and displayed on the screen.

Therefore, the present invention can provide a cellular phone PDA GPS system that includes a geographical display that shows one or more other cellular phone users symbolically displayed on the screen and also entered entities that each of the cellular phone users consider to be items of interest, along with pre-established points of interest (geo-

US 7,031,728 B2

11

graphical referenced fixed locations including: restaurants, gas stations, hospitals, fire departments, military bases, homes, businesses, government facilities, street locations, and the like).

The present invention also includes a database that has the specific cellular phone telephone numbers of each of the displayed symbols thus providing a relationship between the symbol, its location on the geographical screen and the stored memory phone number.

There is also a software program that allows the operator of cellular phone one to touch one of the symbols representing a phone user on the display screen and to initiate a call by touching the appropriate switch with a stylus or finger at which time the software will automatically retrieve the designated symbolic phone telephone number from memory and will initiate instantly a telephone call to the cellular phone number that is associated with the symbol. This is all done by merely touching the symbol representing the phone in the database and touching the "call" soft switch.

In addition, with multiple cellular phone users present, the operator of cellular phone one can use the stylus or finger and touch more than one cellular phone user's symbol and then touch a software switch that says "conference call" wherein the software will initiate and establish conference calls with all of the designated cellular phone users by the touch of a stylus or finger or by selecting a pre-established participant conference net switch. In the event that there are more than a small number of phone users in the area that need to be established on a conference call, because of the technological limitations of conference calls on cellular phones, the system will send a different message that causes the remote cellular phone to call a specific 800 conference number that can establish a much larger number of conference callers. Thus, if the user selects to conference more than an established number of phone users for a conference call, the software will indicate that the 800 number software switch is to be utilized.

In addition the operator of cellular phone one can address text messages, photographs and video for transmission to one or more net participants by either touching their symbols and selecting the appropriate soft switch or selecting the appropriate call net.

Another important feature of the present invention is that the operator or initiator of cellular phone one can by touching a switch on the display, send through the PDA system, a signal and digital message to all the cellular phones in the communications net or to designated cellular phone(s), represented by their symbols on the geographic display, an emergency message which requires a response. When received, the software in the remote cellular phone causes the remote cellular phone to initiate an audio message to the cellular phone user that there is an emergency (or another message) and to call the initiator immediately. This is accomplished by the message sent from cellular phone one to the software in the remote cellular phone(s).

In summary, the present invention provides for expeditious data exchange and cellular phone calls to one or more users by merely touching the display screen location of a remote cellular phone user's symbol to initiate the call. Other features include conference calling by stylus or finger and a rapid emergency remote activation and causing a remote phone to: announce various pre-established messages, execute text to speech software, increase its volume level, vibrate, show photographs, or show videos.

The instant invention has been shown and described herein in what is considered to be the most practical and preferred embodiment. It is recognized, however, that depar-

12

tures may be made there from within the scope of the invention and that obvious modifications will occur to a person skilled in the art.

What is claimed is:

1. A method of providing a cellular phone communication network for designated participating users, each having a similarly equipped cellular phone that includes a CPU, GPS navigational system and a touch screen display comprising the steps of:

- a) providing for the selective polling of position and status information from one user among all of the other users equipped with cellular phone/PDA/GPS system and its associated software;
- b1) providing for the entering of other entities of interest into the cellular phone CPU and assigning the other entities of interest a category;
- b2) providing the latitude and longitude of the entities of interest along with their categories being automatically sent on the communications network;
- c) providing rapid voice call initiation to one or more locations whose phone number is available in a geographical referenced database using the touch screen;
- d) providing rapid voice call initiation to the users of the cellular phone/PDA/GPS network system using the touch screen;
- e) providing rapid transmission of free, operator selected text messages, photographs, and video to another cellular phone using the touch screen;
- f) providing rapid conference calling multiple phones that are contained within the geographical referenced data base; and
- g) providing remote control from one cellular phone/PDA/GPS system to any of the other cellular phone/PDA/GPS system phones, including the ability to control remote cellular phones to make verbal announcements, display images, place return calls, place calls to another phone number, vibrate, change sound intensity and process and display pre-stored data, images and stored video.

2. The method of providing a communication network as in claim 1 including the step of:

- providing in each of the cellular phones a remotely activatable software program for turning the cellular phone on and off and that initiates a signal from the remote cellular phone displaying a pre-stored message and to call the initiating cellular phone; and
- providing software that activates the remote cellular phone causing the remote cellular phone to generate said pre-stored message to the remote cellular phone user.

3. A communication system to provide a cellular phone network for a group of participants, each of the participants having an individual portable cellular phone that includes voice communication, free and operator selected text messages, photographs and video, a CPU and a GPS navigational system that can accurately determine the location of each cellular phone, each of the cellular phones in the communications net of participants containing:

- said CPU and memory;
- a touch screen display;
- symbol generator in said CPU that can generate symbols that represent each of the participants' cell phones in the communication network on the display screen;
- a database that stores the individual telephone numbers related to each of the symbols each of which represents a participant in the communication network;

US 7,031,728 B2

13

cellular phone call initiating software in said CPU connected to the telephone number database and the touch screen and the symbols on the touch screen whereby touching an individual symbol will automatically initiate a cellular phone telephone call to the user represented by the symbol that includes said voice communication, free and operator selected text messages, photographs and video; and

said display including databases that display geographical information that includes showing the geographical location of each of the symbols representing participants in the communication network, fixed locations, and entered items of interest.

4. A communication network that includes said participants, as in claim 3 further comprising:

said software for automatically initiating a cellular phone call to a user represented by a symbol includes initiating a conference call to two or more of the participants from a base phone by touching the specific symbols of those participants that will be participating in a conference call by touching the symbol of each of those users and providing a software switch to initiate the conference call by touching the screen whereby each of the initiated conference participants will be called by the base phone to establish a conference call.

5. A communication network as in claim 4 whereby the communication network can include a large number of participants in a conference call comprising:

conference call initiating software in said CPU that is made by sending a digital message to the remote cellular phones from said phone, by touching the symbol of each of the participants, of an 800 number and a participant code that cause each of the participants to call the 800 number and to enter a participant code to establish the conference call with the said phone.

6. A communication network as in claim 3 comprising:

said CPU including a software program to initiate a call to one of the participants represented by a symbol on said touch screen in conjunction with a software switch displayed on said touch screen and software to initiate the cellular phone call automatically that turns the remote cellular phone on or off and generates in the receiving remote cellular phone a pre-stored message that alerts the remote cellular phone user to call the initiator.

7. A method of establishing a cellular phone communication network for designated participants, each having a similarly equipped cellular phone that includes voice communication, free and operator selected text messages, photograph and video, a CPU, a GPS navigation system and a touch screen display comprising the steps of:

- a) generating one or more symbols on the touch display screen, each representing a different participant that has a cellular phone that includes said voice communication, free and operator selected text messages, photograph and video, a CPU, said GPS system and a touch screen display;
- b) providing and storing in each of the participant cellular phones one or more cellular phone telephone numbers, each cellular phone number of which relates to a different symbol of each of the participants in the communication network;
- c) providing initiating cellular phone calling software in each cellular phone that is activated by touching a symbol on the touch display that automatically initiates

14

a cellular phone call using the stored cellular phone number to the participant represented by the symbol; and

d) generating a geographical location chart on said display screen to show the geographical location of each of the symbols representing the participants in the communication network by latitude and longitude.

8. The method of establishing a communication network as in claim 7 comprising the additional step of:

e) providing conference call initiating software that allows each of the participants to initiate a conference call to other participants by touching each of the symbols on the touch screen representing participants who will participate in the conference call.

9. A method of establishing a communication network as in claim 7 including the step of:

f) providing conference call initiating software for a large number of participants represented by the symbols on the touch screen in which each of the proposed conference call participants are established by touching the participant's symbol on the screen which causes the cellular phone initiating the conference call to transmit messages to each of the users represented by the touched symbols that tells each of the called participants through their cellular phones to call a particular 800 number to establish the conference call.

10. A cellular phone for use in a communication network for a plurality of participants comprising:

a cellular phone transmitter and receiver for transmitting and receiving voice communication, free and operator selected text messages, photographs, and video;

a small hand held portable housing containing said cellular phone transmitter and receiver;

a touch display screen mounted in said housing;

a modem connected to said cellular phone transmitter and receiver;

a CPU connected to said cellular phone transmitter and receiver;

a GPS navigation system connected to said CPU and to said cellular phone transmitter and receiver on said touch screen;

a database connected to said CPU that includes of a list of telephone numbers that relate to specific symbols;

a symbol generator connected to said CPU and said database for generating symbols on said touch display screen;

CPU software for selectively polling other participants with a cellular phone;

call initiating software connected through said CPU and said telephone database and said symbol generator whereby when a user touches the symbol displayed on a said touch display screen the cellular phone call is automatically initiated to the cellular phone represented by the symbol; and

a geographical database connected to said CPU to provide a geographical display on said touch screen representing a defined geographical area that also displays symbols representing each of the participants by latitude and longitude.

11. A cellular phone as in claim 10, including:

conference call initiating software connected to said CPU that allows the cellular phone user to initiate a conference call to a plurality of participants represented by symbols by touching each of the symbols and initiating a conference call software switch.

US 7,031,728 B2

15

12. A cellular phone as in claim 10, including:
 conference call initiating software for large number of
 conference call participants that allows the user of the
 cellular phone to initiate a conference call to the
 cellular phone users represented by the symbols on the
 screen by touching each of the symbols representing a
 participant in the conference call which initiates an
 automatic cellular phone call to the remote cellular
 phone users represented by the symbols displaying a
 text message to call a particular 800 number to estab-
 lish the conference call.

13. A cellular phone as in claim 12, including:
 providing the ability to pre-establish phone conferencing
 nets by touching the said touch display screen at a
 symbolic representation of the person(s) location or by
 selecting the parties from a list appearing on the touch
 display screen and assigning them to a software drawn
 switch made to appear on a touch display screen; and
 providing the ability to conference the participants pre-
 viously assigned to a net by using a software drawn
 switch(es) for a conference call, whereby the user

16

touches the net software switch to initiate the call to all
 of the participants on the net.

14. A layered set of software drawn switches as in claim
 13, including:
 a matrix of layered software drawn switches so that each
 switch that when activated on the touch display screen
 overlays the previously drawn matrix of switches, the
 matrix level of which is noted in one of the switch
 locations, thus providing the operator a large choice of
 switches in the same physical space on the touch
 display screen and informing the operator of the level
 of switches that are displayed.

15. A cellular phone as in claim 10, including:
 an emergency call initiating software connected to said
 CPU that includes a remote cellular phone activating
 signal for causing a remote cellular phone that is called
 by touching a symbol representing the cellular phone to
 be called to generate and play an audio message telling
 the remote cellular phone user that there is an emer-
 gency and to call the cellular phone initiator.

* * * * *

UNITED STATES PATENT AND TRADEMARK OFFICE
CERTIFICATE OF CORRECTION

PATENT NO. : 7,031,728 B2
APPLICATION NO. : 10/711490
DATED : April 18, 2006
INVENTOR(S) : Malcolm K. Beyer, Jr.

Page 1 of 1

It is certified that error appears in the above-identified patent and that said Letters Patent is hereby corrected as shown below:

Column 1, Line 37, should read

“Digital SMS (Short Message Service) and TCP/IP mes-...”

Column 5, Line 35, should read

“...enter each individual phone’s participant code. The originator...”

Column 13, Line 43, should read

“...remote cellular phone’s software on or off and generates in the...”

Signed and Sealed this

Eighth Day of April, 2008

A handwritten signature in black ink that reads "Jon W. Dudas". The signature is written in a cursive style with a large, stylized initial "J".

JON W. DUDAS

Director of the United States Patent and Trademark Office

Exhibit B



US007630724B2

(12) **United States Patent**
Beyer, Jr. et al.

(10) **Patent No.:** **US 7,630,724 B2**
(45) **Date of Patent:** **Dec. 8, 2009**

(54) **METHOD OF PROVIDING A CELLULAR PHONE/PDA COMMUNICATION SYSTEM**

6,868,337 B2	3/2005	Muramatsu
2003/0139150 A1	7/2003	Rodriguez et al.
2003/0200259 A1*	10/2003	Tsuge 709/203
2004/0192331 A1*	9/2004	Gorday et al. 455/456.1
2004/0204070 A1*	10/2004	August et al. 455/557
2004/0266456 A1	12/2004	Bostrom et al.
2006/0031927 A1*	2/2006	Mizuno et al. 726/11

(75) Inventors: **Malcolm K. Beyer, Jr.**, Jupiter Inlet Colony, FL (US); **Christopher R. Rice**, Monroe, WA (US)

(73) Assignee: **Advanced Ground Information Systems, Inc.**, Jupiter Inlet Colony, FL (US)

* cited by examiner

Primary Examiner—Nick Corsaro
Assistant Examiner—Amanuel Lebassi

(*) Notice: Subject to any disclaimer, the term of this patent is extended or adjusted under 35 U.S.C. 154(b) by 450 days.

(74) *Attorney, Agent, or Firm*—Malin Haley DiMaggio Bowen & Lhota, P.A.

(57) **ABSTRACT**

A cellular, PDA communication device and communication system for allowing a plurality of cellular phone users to monitor each others' locations and status, to initiate cellular phone calls by touching a symbol on the touch screen display with a stylus which can also include point to call conferencing calling. Each participant's cellular phone PDA device includes GPS navigation receiver with application software for point to call cellular phone initiation to participants and geographical entities including vehicles, persons or events, conference calls and video transfers. The method and system also includes automatic shifting from GPRS/EDGE/CDMA/1XEVD0 to SMS when any of the cellular phones in the communication network is in the voice mode and in use and for automatic shifting back to GPRS/EDGE/CDMA/1XEVD0 upon completion of the voice phone call. In addition, using the system, a full transfer of photographs, video clips and high speed data can be used between any cellular phones regardless of who the cellular phone vendors or cellular phone companies are and in either CDMA, GSM, WiFi or a combination of the two.

(21) Appl. No.: **11/308,648**

(22) Filed: **Apr. 17, 2006**

(65) **Prior Publication Data**

US 2006/0199612 A1 Sep. 7, 2006

Related U.S. Application Data

(63) Continuation-in-part of application No. 10/711,490, filed on Sep. 21, 2004, now Pat. No. 7,031,728.

(51) **Int. Cl.**
H04W 24/00 (2009.01)

(52) **U.S. Cl.** **455/457; 455/416; 455/417**

(58) **Field of Classification Search** 455/452.3, 455/416, 457

See application file for complete search history.

(56) **References Cited**

U.S. PATENT DOCUMENTS

6,204,844 B1*	3/2001	Fumarolo et al.	715/736
6,662,016 B1*	12/2003	Buckham et al.	455/457

16 Claims, 6 Drawing Sheets

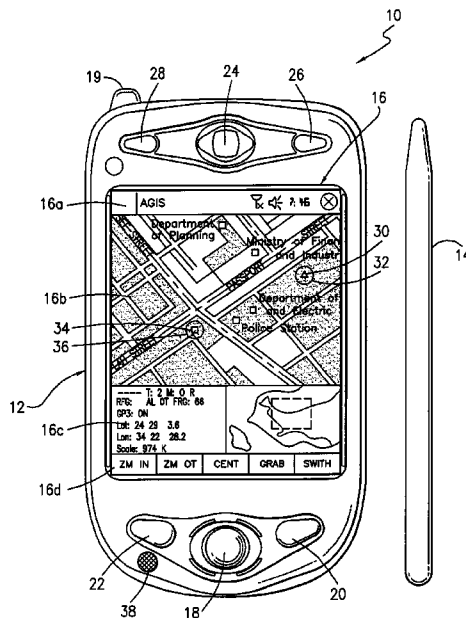

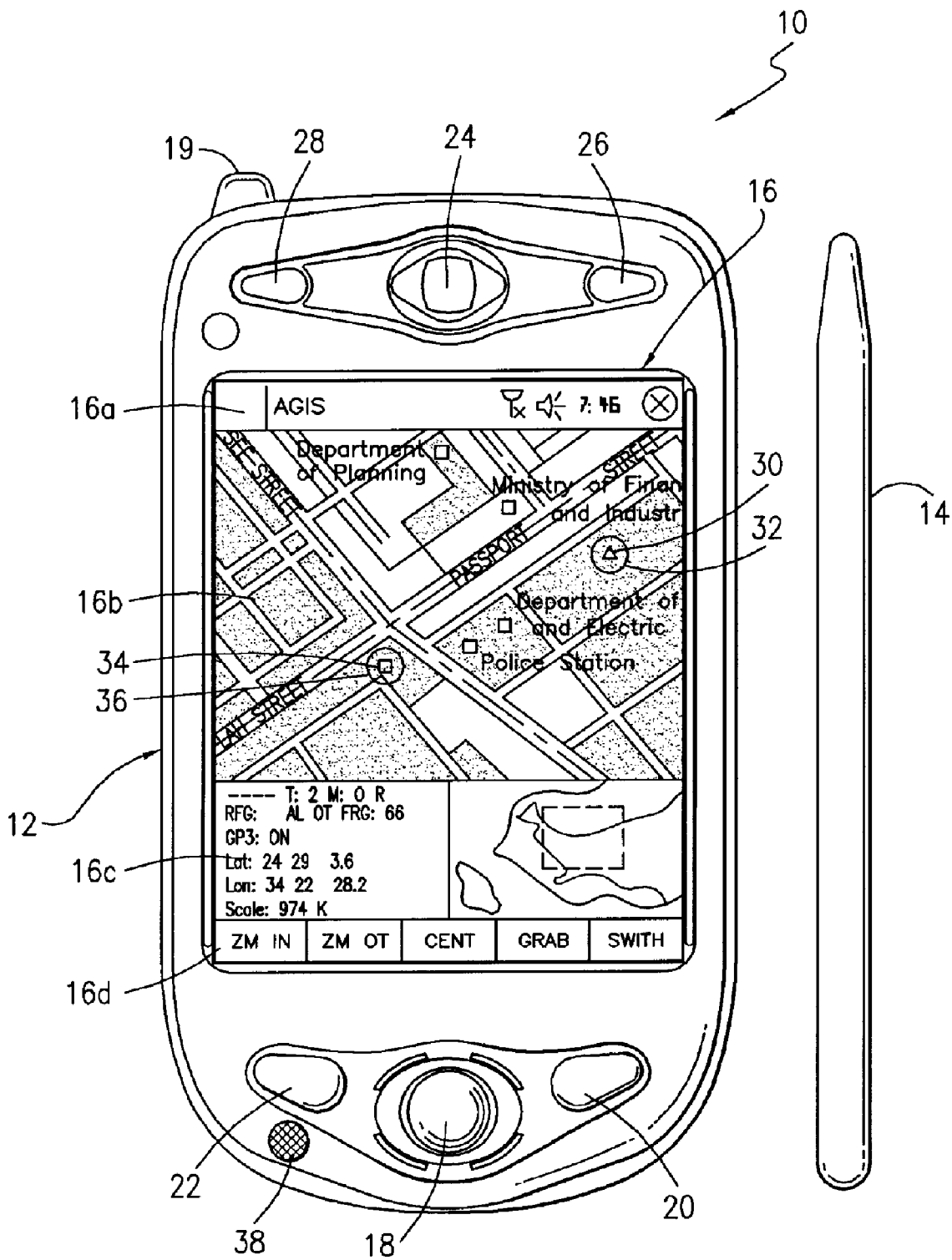

FIG. 1

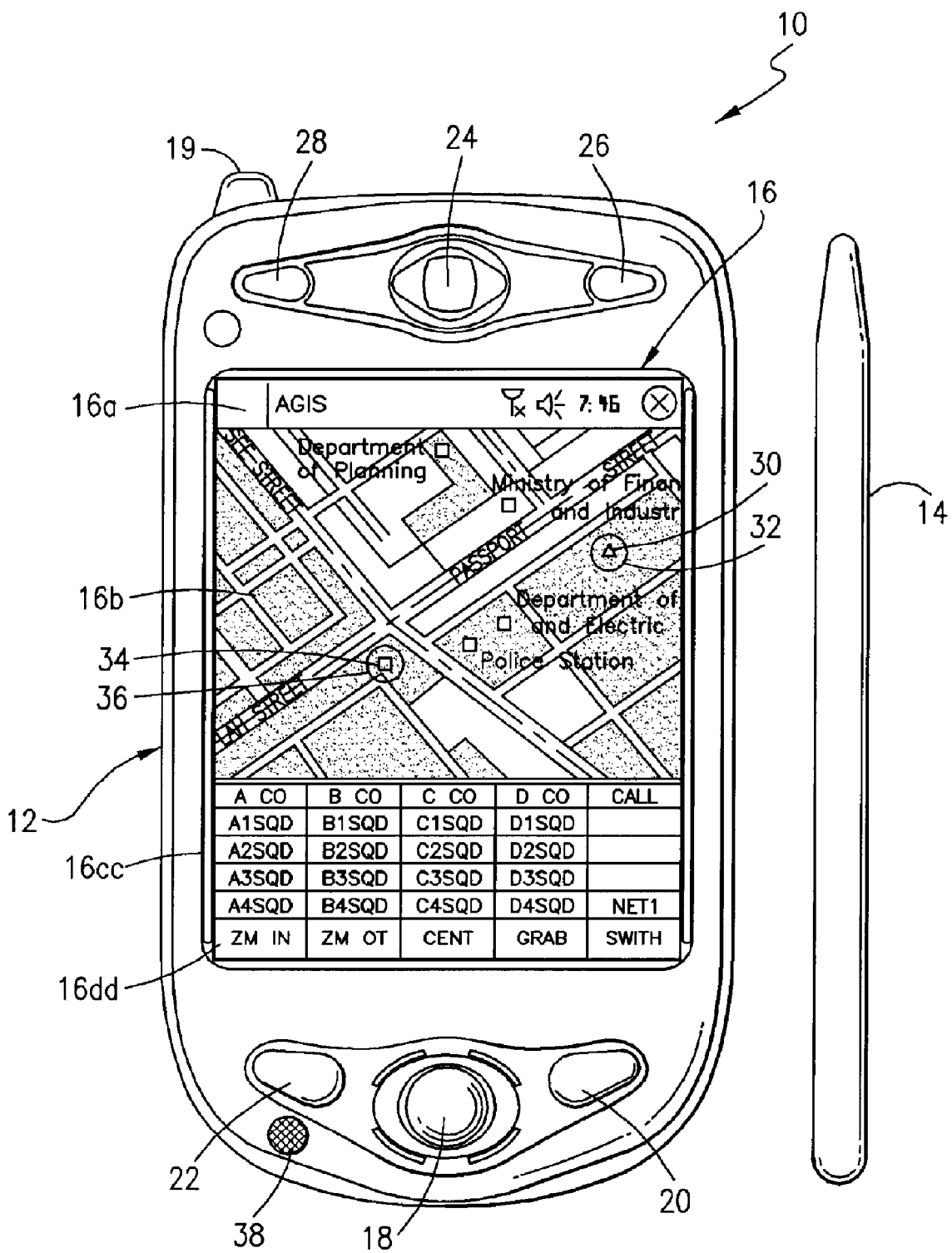
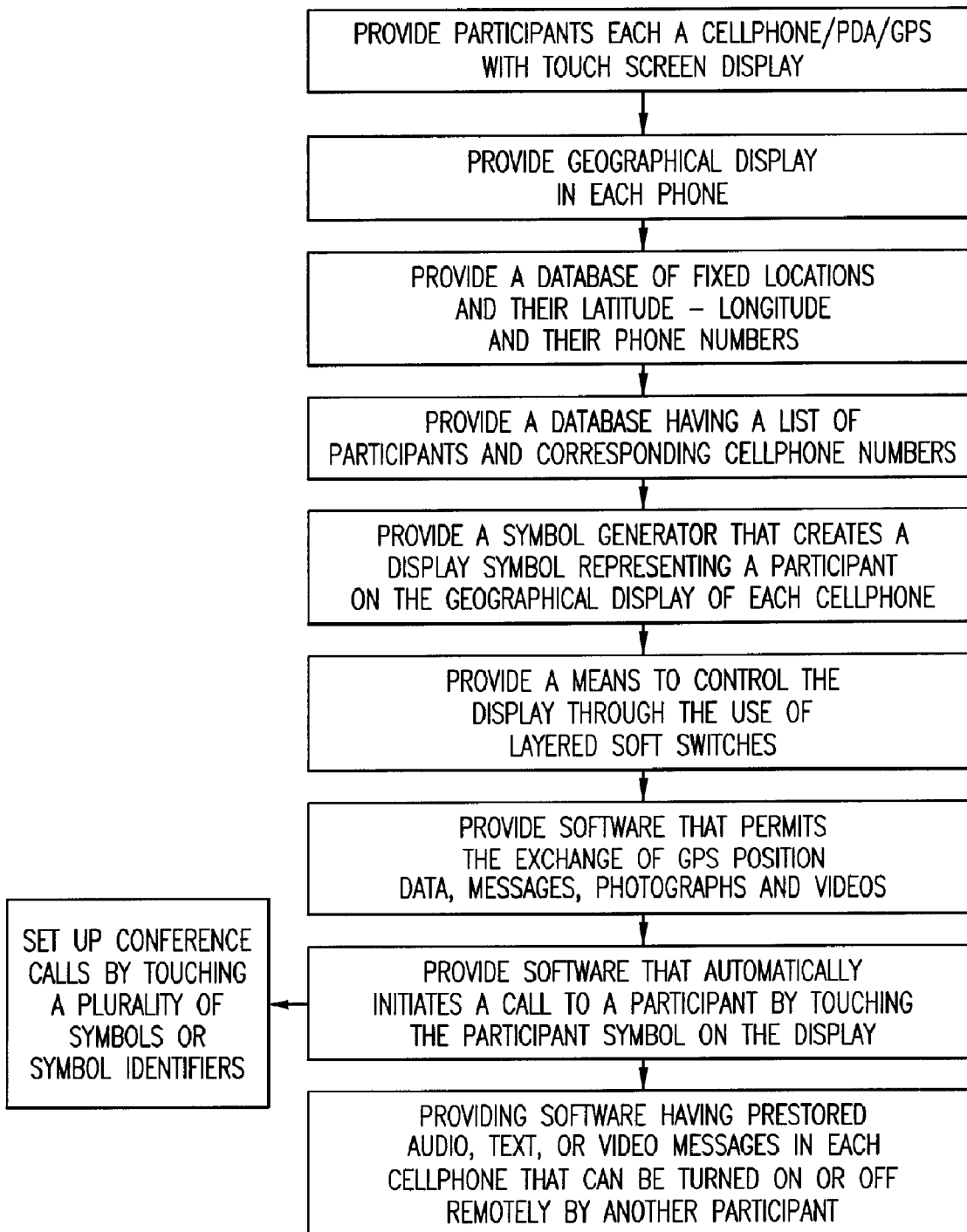

FIG. 2

FIG. 3

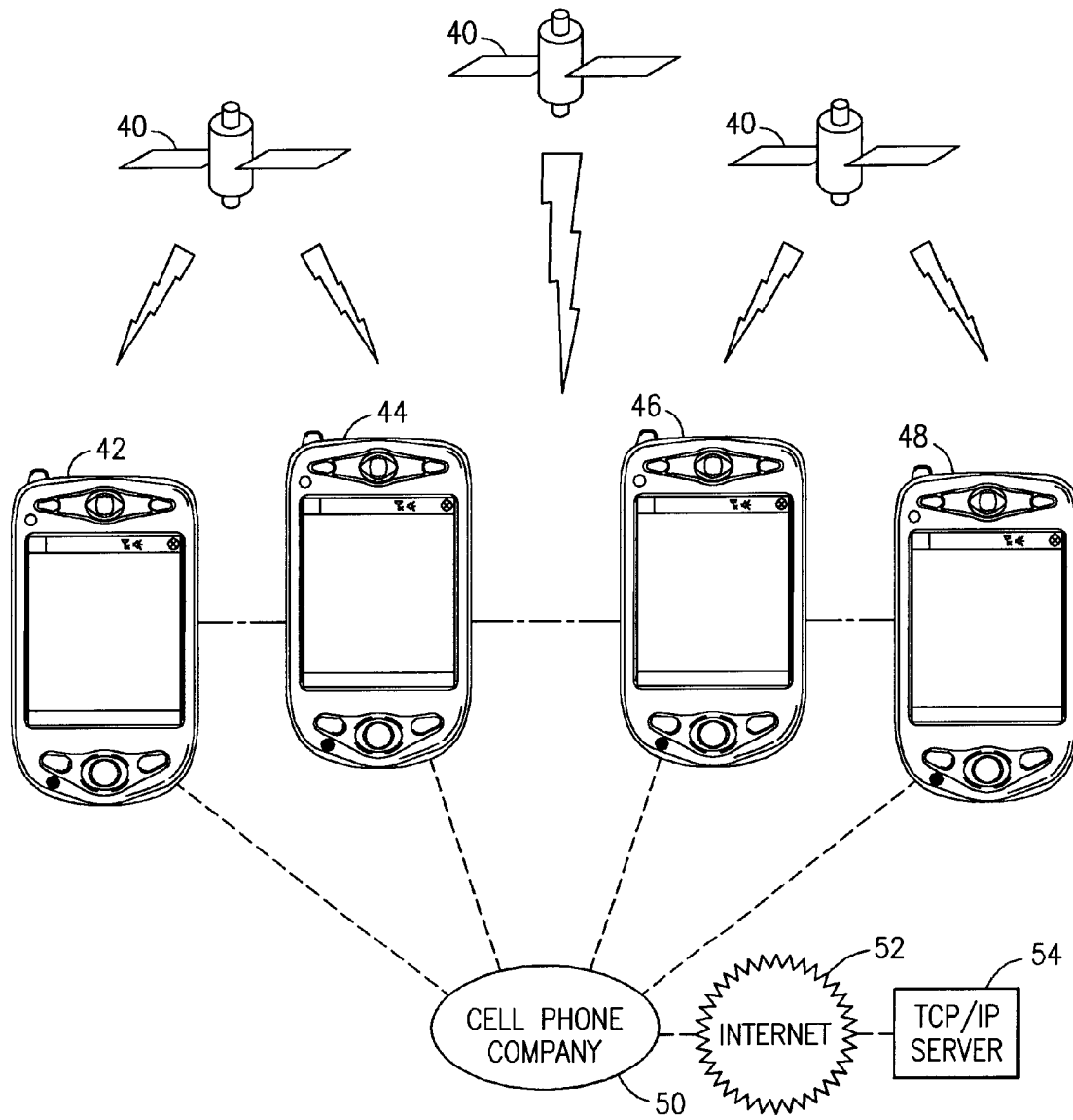

FIG. 4

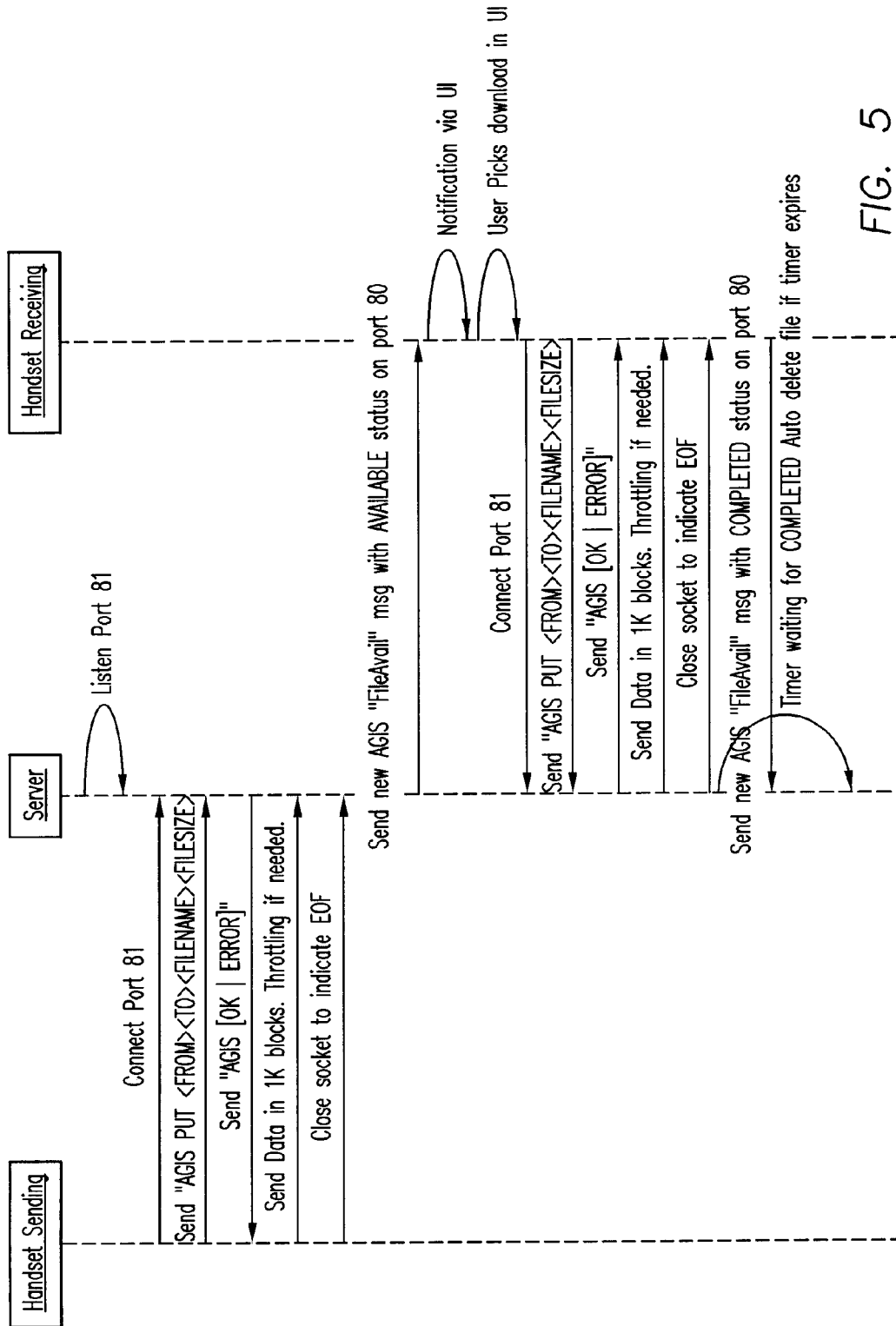
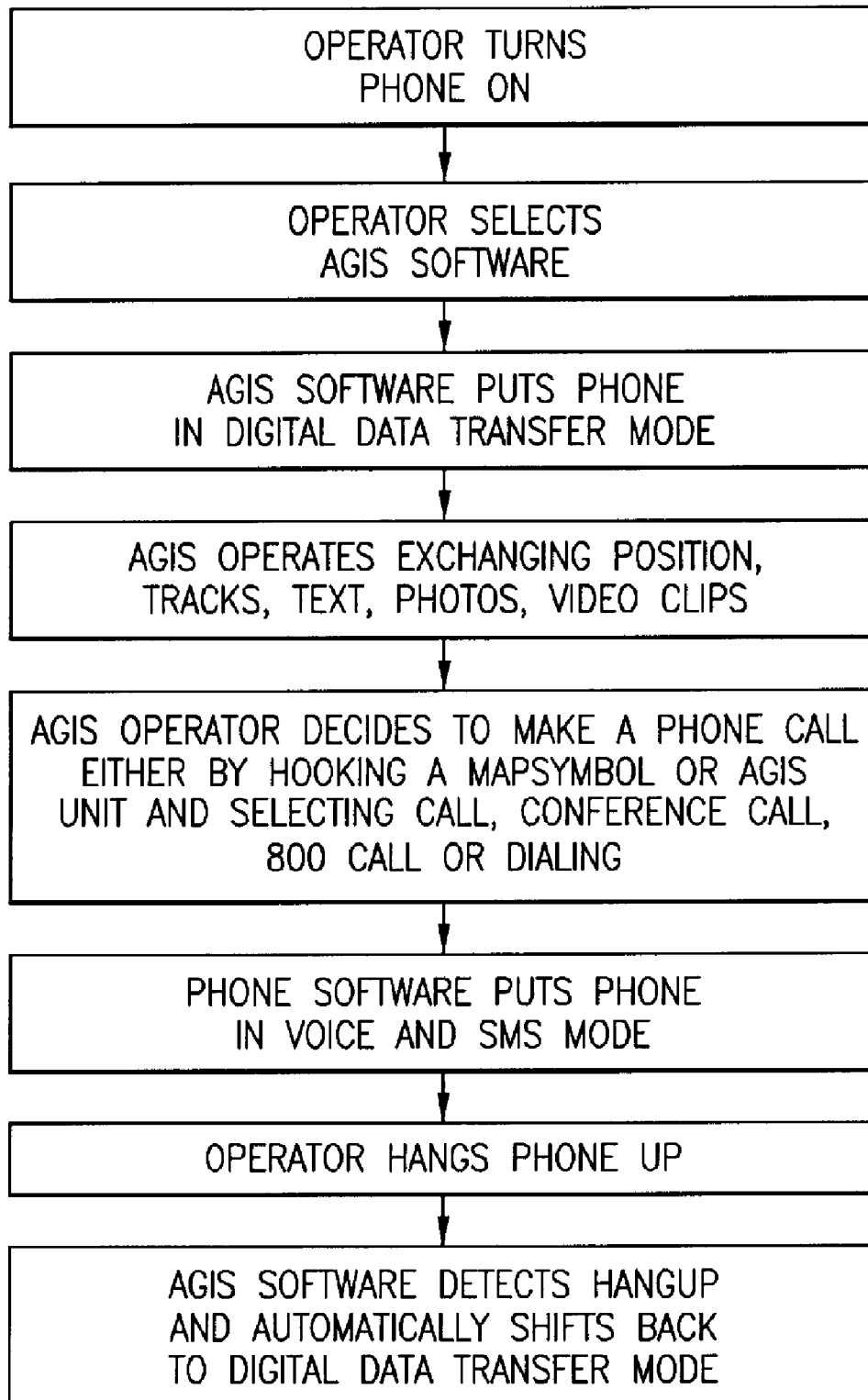

FIG. 5

FIG. 6

US 7,630,724 B2

1

**METHOD OF PROVIDING A CELLULAR
PHONE/PDA COMMUNICATION SYSTEM**

FIELD OF THE INVENTION

This invention relates generally to an integrated communications system using a plurality of cellular/PDA/GPS phones for the management of a group of people through the use of a communications net and, specifically, to provide each user with a cellular/PDA/GPS/phone that has software application programs and databases that permit all the users to continuously know each other's locations and status, to rapidly call and communicate voice, high speed internet data, photographs and video clips among the users by touching display screen symbols and to enable the users to easily access data concerning other users and other database information.

DESCRIPTION OF RELATED ART

The purpose of a communications system is to transmit information bearing signals from a source, located at one point, to a user destination, located at another point some distance away. A communications system is generally comprised of three basic elements: transmitter, information channel and receiver. One form of communication in recent years is cellular phone telephony. A network of cellular communication systems set up around an area such as the United States allows multiple users to talk to each other, either on individual calls or on group calls. Some cellular phone services enable a cellular phone to engage in conference calls with a small number of users. Furthermore, cellular conference calls can be established through 800 number services. Cellular telephony also now includes systems that include Global Positioning System (GPS) navigation that utilizes satellite navigation. These devices thus unite cellular phone technology with navigation information, computer information transmission and receipt of data.

Digital Smart Message Service (SMS) and TCP/IP messages can be transmitted using cellular technology such as various versions of GSM and CDMA or via a WiFi local area network. One implementation of these GPS location reporting cellular systems is for the data to go to a remote central site where the information is displayed for a person to monitor the locations of the cellular units that have the combined cellular GPS phone. Another implementation permits the cellular phone users to also view the location of other GPS equipped units. A drawback of the current implementation is that these systems are either all on or all off. There is no way to selectively activate participants or to stop the participants from participating in the network or for participants to set their reporting intervals that is based on time or distance traveled. The use of the current combined cellular phone/PDA technology has drawbacks when calling. When an operator makes a cellular phone call using the PDA to display a map (that also may depict geo-referenced businesses, homes and other facilities' locations and phone numbers), the cellular phone/PDA operator is required to display the numeric phone number by touching the display screen at the correct location of that entity on the map, memorize the numeric phone number, and select a different display to physically enter the phone number to make the call and then, if desired, go back to the map display. Needless to say, this is a cumbersome process. Sending a text message or an email to a location, business, home or facility that appears on a PDA map display or to another cellular phone can also be a cumbersome process as the PDA operator has to find the phone number or email

2

address of the location on the map display, memorize the phone number or email address, then go to a different display to enter a text message, enter the text message, send the text message and then shift back to the map display program.

5 Furthermore, for a phone to send data concerning a new entity of interest, not currently on the geo-referenced map display (car, person, tank, accident, or other entity), the operator must type in the information and the latitude and longitude of the new entity of interest.

10 U.S. Patent Application No. 2003/0139150 published Jul. 24, 2003 shows a portable navigation and communication system. In one embodiment, the system combines within a single enclosure a GPS satellite positioning unit, mobile telephony using cellular phone technology and personal computing capable of wired or wireless internet or intranet access using a standard operating system. The purpose of this invention is to provide portable navigation for an individual. However, to operate the device, one still needs to utilize a keypad with the telephone functions. U.S. Patent Application No. 2003/0139150 described a wireless communication system operating the PDA in a conventional manner. There is no provision for displaying the location of other similarly equipped systems. There is no provision to cause other similarly equipped cellular phone/PDA users to transmit their locations. There is no provision for entering other entities of interest by touching the display screen at their locations on a map. There is no provision for making a telephone call by touching the display screen at a net participant's symbol or entered facility (police station, fire station, etc.) symbol to initiate automatically the telephone call to that user or by touching multiple symbols to make conference calls. There is no provision for sending text messages, photographs or videos by touching the net participant(s)' symbol(s) on the display screen to automatically send text messages, photographs or videos to that participant or participants. There is no provision to go to a facility's web site or to automatically fill in a facility's E-mail address. There is no description or disclosure of a procedure to cause digital messages to be sent to a remote cellular phone that would cause the cellular phone to make verbal announcements, increase sound intensity, vibrate or to call back or to call another phone number. There is no description of the uses of layered soft switches which confine the switches to a particular vicinity of the PDA's display screen.

SUMMARY OF THE INVENTION

A plurality of cellular phone/WiFi/PDA/GPS devices each having application software and databases to provide a communication network having: a) the ability to selectively poll each of the other PDA/GPS phone devices with each participant to start reporting its position and status information directly to all or selected users equipped with the same cellular phone/PDA communication/GPS devices in the communications net so that each of the devices that the data is transmitted to is provided a display of the location, status and other information of the other users; b) the ability of each of the cellular phone/PDA devices to report to another device at an operator selected time rate or at a rate based on distance traveled; c) the ability to exchange other entities' of interest information and to assign these entities a category (car, person, tank, accident, or other event) by touching the display screen at the entity's location on the displayed map, and selecting the appropriate category switch; d) the ability to make rapid voice and data call initiation to any other participant in the cellular phone/WiFi net whose phone number is available in a geo-referenced database including the cellular

US 7,630,724 B2

3

phone/PDA/GPS devices in a communications net by touching the display screen at the appropriate map location on the PDA map display and selecting a call switch; e) the ability to make rapid voice, and conference call initiation to locations, businesses, homes and facilities whose phone numbers are available in a geo-referenced database including the cellular phone/PDA/GPS devices in a communications net by touching the display screen at the appropriate other user locations on the PDA map display and selecting a conference call switch; f) the ability to access a facility's URL or to automatically fill in their E-mail address; g) the ability to remotely control from one cellular phone/PDA/GPS any of the other cellular phone/PDA/GPS systems phones including the ability to control remote cellular phones to make verbal pre-recorded announcements, place return calls, place calls to another phone number, vibrate, execute text to speech software, change sound intensity, remotely control software and functions resident on the remote phone and process and display information by touching the display screen at their location on the PDA display and selecting the appropriate switch; and g) the ability to layer a sufficient number of switches or buttons on the PDA display to perform the above functions without overlaying the map.

It is an object of this invention to provide an improved cellular telephone communication network among a plurality of cellular phones for greatly decreasing the operator actions necessary to establish calling and conferencing between each of the cellular phones.

And yet another object of this invention is to enable each participant to automatically exchange IP addresses using SMS or another digital message format.

And yet another object of this invention is to enable each participant in the communications net to poll the other net participants to report or cease reporting their locations, identity and status on the communication net.

And yet another object of this invention is to enable each participant in the communications net to be able to easily transmit an entity of interest to the other participants of the net by touching the display screen at the entity's location on the map and causing a symbol to be generated on the screen and entered and then entering the entity's category information.

And yet another object of this invention is to provide for initiating a cellular phone telephone call to another phone by touching the other phone's symbol on the screen of the cellular phone, which automatically activates the telephone call.

And yet another object of this invention is to provide a cellular phone network that provides for instant voice conference calling and the exchange of free text, preformatted messages, photographs and video among a plurality of cellular phones by touching the display screen of specific geo-referenced map symbols for initiating the calls.

And yet another object of this invention is to provide a cellular phone network that provides for instant conference voice, text, photographs and video exchange by pre-establishing conferencing sub-nets and the subsequent activation of one of those sub-nets to establish a conference call.

But yet still another object of the invention is to provide for a communication system that uses cellular telephone network that allows for photographs and video clips to be transferred ("pushed") between and among the cellular phone users across multiple cellular carriers, between smart phone and PCs.

In accordance with these and other objects which will become apparent hereinafter, the instant invention will now be described with particular reference to the accompanying drawings.

4

BRIEF DESCRIPTION OF THE DRAWINGS

FIG. 1 shows a front plan view of a cellular phone/PDA having a touch screen display in accordance with the present invention.

FIG. 2 shows a front plan view of the cellular phone/PDA of FIG. 1 with a different touch screen display.

FIG. 3 shows a flow chart of the operation of the present invention.

FIG. 4 shows a schematic diagram depicting GPS satellites, a plurality of cellular phone/PDA units, the cellular phone company, the internet and the command server that allows automatic shifting between high speed cellular internet communications and voice communications.

FIG. 5 shows a process flow diagram of the transfer protocol in accordance with the present invention.

FIG. 6 shows a flow diagram for automatic shifting between voice and high speed cellular internet communications.

PREFERRED EMBODIMENT OF THE INVENTION

Referring now to the drawings and, in particular, FIG. 1, the present invention is shown generally at **10** that includes a small handheld cellular phone that includes a personal digital assistant (PDA) and a global positioning system receiver (GPS) communications device in housing **12** that includes an on/off power switch **19**, a microphone **38**, and an LCD display **16** that is also a touch screen system. The small area **16a** is the navigation bar that depicts the telephone, GPS and other status data and the active software. AGIS software refers to the application software used in this invention. AGIS is a trademark of AGIS Corporation. Each cell phone includes a CPU and databases that store information useful in the communication network. The CPU also includes a symbol generator for creating touch screen display symbols discussed herein. With the touch screen **16**, the screen symbols are entered through GPS inputs or by the operator using a stylus **14** (or operator finger) by manipulatively directing the stylus **14** to literally touch display **16**. The soft switches **16d** displayed on the display **16** are likewise activated by using a stylus **14** and physically and manipulatively directing the stylus to literally touch display **16**. The display x, y coordinates of the touched point are known by a CPU in the PDA section of the communication system in housing **12** that can coordinate various information contained in the PDA portion relative to the x, y coordinate position on the display **16**. Inside housing **12** is contained the conventional cellular phone elements including a modem, a CPU for use with a PDA and associated circuitry connected to speaker **24** and microphone **38**. A GPS navigational receiver that receives signals from satellites that can determine the latitude and longitude of the cellular phone housing **12** can be internal or external to the housing **12**. PDA/cellular phone units such as these are currently on sale and sold as a complete unit (or with an external connected GPS) that can be used for cellular telephone calls and sending cellular SMS and TCP/IP or other messages using the PDA's display **16** and computer (CPU). The GPS system including a receiver in housing **12** is capable of determining the latitude and longitude and through SMS, TCP/IP, WiFi or other digital messaging software, to also transmit this latitude and longitude information of housing **12** to other cellular phones in the communication network via cellular communications, WiFi or radio. The device **10** includes a pair of cellular phone hardware activating buttons **20** to turn the cellular phone on and **22** to turn the cellular

5

phone off. Navigation pad actuator **18** is similar to a joy or force stick in that the actuator **18** manually provides movement commands that can be used by the PDA's software to move a cursor on display **16**. Switches **26** and **28** are designed to quickly select an operator specified software program. Speaker **24** and microphone **38** are used for audio messages. Switch **19** at the top left of device **10** is the power on and power off switch for the entire device.

The heart of the invention lies in the AGIS software applications provided in the device. Mounted within housing **12** as part of the PDA is the display **16** and the CPU. The internal CPU includes databases that provide for a geographical map and georeferenced entities that is shown as display portion **16b** that includes as part of the display various areas of interest in the particular local map section.

When looking at display **16**, the software switches (soft switches) which appear at the very bottom of the display **16d** are used to control by touch many of the software driven functions of the cellular phone and PDA. The software drawn and controlled switches are activated through the operator's use of the navigation pad **18**, or a small track ball, force stick or similar hardware display cursor pointing device. Alternatively, the operator may choose to activate the software switch matrix by touching the screen with a stylus **14** (or finger) at the switches' **16d** locations. When some of the software switches are activated, different software switches appear. The bar display **16d** shows the software switches "ZM IN (zoom in)," "ZM OT (zoom out)," "CENT (center)" and "GRAB (pan/grab)" at the bottom of the screen. These software switches are for the operator to perform these functions. The "SWITH (switch)" software switch at the lower right causes a matrix of layered software switches (soft switches) to appear above the bottom row of switches. Through use of the software switches, the operator can also manipulate the geographical map **16b** or chart display. When looking at FIG. **1**, permanent geographical locations and buildings are shown. For example, the police station is shown and when the symbol is touched by the stylus or finger, the latitude and longitude of the symbol's location, as shown in display section **16c**, is displayed at the bottom left of the screen. The bottom right side of display **16c** is a multifunction inset area that can contain a variety of information including: a) a list of the communication link participants; b) a list of received messages; c) a map, aerial photograph or satellite image with an indication of the zoom and off set location of the main map display, which is indicated by a square that depicts the area actually displayed in the main geographical screen **16b**; d) applicable status information; and e) a list of the communication net participants. Each participant user would have a device **10** shown in FIG. **1**.

Also shown on the display screen **16**, specifically the geographical display **16b**, is a pair of different looking symbols **30** and **34**, a small triangle and a small square, which are not labeled. These symbols **30** and **34** can represent communication net participants having cellular phones in the displayed geographical area that are part of the overall cellular phone communications net having the same device **10** used in this invention. The latitude and longitude of symbol **30** is associated within a database along with a specific phone number and, if available, its IP address and email address. The screen display **16b**, which is a touch screen, provides x and y coordinates of the screen **16b** to the CPU's software from a map in a geographical database. The software has an algorithm that relates the x and y coordinates to latitude and longitude and can access a communications net participant's symbol or a fixed or movable entity's symbol as being the one closest to that point.

6

For describing the network, the operator's phone is cellular phone "one." In order to initiate a telephone call to the cellular phone user (communication net participant) represented by symbol (triangle) **30** at a specific latitude and longitude display on chart **16b**, the operator touches the triangle **30** symbol with the stylus **14**. The operator then touches a "call" software switch from a matrix of displayed soft switches that would overlay the display area **16c**. Immediately, the cellular phone will initiate a cellular telephone call to the cellular phone user at the geographical location shown that represents symbol **30**. A second cellular phone user (communication net participant) is represented by symbol **34** which is a small square (but could be any shape or icon) to represent an individual cellular phone device in the display area. The ring **32** around symbol **30** indicates that the symbol **30** has been touched and that a telephone call can be initiated by touching the soft switch that says "call." When this is done, the telephone call is initiated. Other types of symbolic elements on the display **16** can indicate that a cellular phone call is in effect. Additionally, the operator can touch both symbol **34** and symbol **30** and can activate a conference call between the two cellular phones and users represented by symbols **30** and **34**. Again, a symbolic ring around symbol **34** indicates that a call has been initiated.

Equally important, the operator of cellular phone "one" can call the police station or any other specific geographical facility displayed on the map, including: (buildings, locations of people, vehicles, facilities, restaurants, etc., (whose cellular phone numbers and, if available, E-mail addresses, IP addresses and their URLs were previously stored in the database) by touching a specific facility location on the map display using the stylus **14** and then touching the cellular phone call switch. As an example, the operator can touch and point to call a restaurant using a soft switch by touching the restaurant location with his stylus and then touching the call soft switch. The cellular phone will then call the restaurant. Thus, using the present invention, each participant can touch and point to call to one or more other net participants symbolically displayed on the map each of whom have a device as shown in FIG. **1** and can also point to call facilities that had been previously stored in the phone's database. Furthermore, this symbol hooking and soft switch technique can be used to go to a fixed facility's website or to automatically enter the fixed facility's E-mail address in an e-mail.

Each cellular phone/PDA/GPS user device is identified on the map display of the other participant user phone devices by a display symbol that is generated on each user phone display to indicate each user's identity. Each symbol is placed at the correct geographical location on the user display and is correlated with the map on the display. The operator of each cellular phone/PDA/GPS device may also enter one or more other fixed entities (buildings, facilities, restaurants, police stations, etc. and geo-referenced events such as fires, accidents, etc.) into its database. This information can be likewise transmitted to all the other participants on the communications net. The map, fixed entities, events and cellular phone/PDA/GPS device communication net participants' latitude and longitude information is related to the "x" and "y" location on the touch screen display map by a mathematical correlation algorithm.

When the cellular phone/PDA/GPS device user uses a stylus or finger to touch one or more of the symbols or a location displayed on the cellular phone map display, the system's software causes the status and latitude and longitude information concerning that symbol or location to be displayed. In order to hook a symbol or "track" such as another net participant which represents an entity on the geo-referenced map display, or a fixed geographical entity such as a restaurant,

US 7,630,724 B2

7

police station or a new entity observed by a cell phone user which is discussed below, the operator points at or near the location of a geo-referenced symbol appearing on the cellular phone/PDA display that represents a specific track or specific participant or other entity. The hook application software determines that the stylus is pointed close to or at the location of the symbol and puts a circle, square or other indication around the symbol indicating that amplification information concerning the track is to be displayed and indicating that additional data or change in data can be made to the indicated symbol. The hook application code then sends a message to the display application code to display the net participant, facility or entity's amplifying data. The display application code retrieves the primary data and amplification data concerning the track or entity from the database and displays the information at the correct screen location. The operator can then read the amplification data that relates to that specific symbol at the specific location. The cell phone operator can also select soft switches on the touch screen display to change the primary data and amplification data or to take actions which could include making cellular phone calls, conference calls, 800 number calls, sending a free text message, operator selected preformatted messages, photographs or videos to the hooked symbol or to drop the symbol.

Each known net participant has a cellular phone number, IP address and, if available, E-mail address that is stored in each participant's device database.

To use the present invention, the operator ("cellular phone one" or "phone one") starts the PDA/cellular phone device system by selecting the software which causes: a) the cellular phone to be activated (if it has not already been activated), b) the GPS interface receiver to be established, c) a map of the geographic area where the operator is located and operator's own unit symbol to appear at the correct latitude and longitude on the map on the display, d) the locations of fixed facilities such as restaurants, hotels, fire departments, police stations, and military barracks, that are part of the database to appear as symbols on the map, e) the device selected item read out area (which provides amplification information for the communications net participant or object that has been touched on the display screen) to appear on the display, f) an insert area that contains various data including: the list of net participants, a list of messages to be read, an indication of what portion of the map is being displayed in major area and other information to appear on the display, and g) a row of primary software created "soft switches" that are always present on the display to appear.

For point to call network units and fixed facilities, the application code detects the x, y display screen location of the symbol that is designated by the user's stylus and translates the x, y coordinates to latitude and longitude and then: (1) searches the database to find the symbol at that location, (2) places a "hook" indicator (a circle, square or other shape) around the symbol, (3) displays any amplifying data and (4) obtains the symbol's associated phone number (or for VoIP calls and IP address) from the database. Upon receiving a "call" designation from the soft switch, the operator's device application code causes the appropriate phone number or IP number to be called. Upon receiving an indication that the phone number is being called, the application code places a box around the symbol (color, dashed or the like). When the call is connected, the box changes to indicate that the connection is made. When the other party hangs up, the box disappears.

As each of the network units reports its identity, location and status to the other participants' devices, the received data is geo-referenced and filed in their databases that are acces-

8

sible by identity and by location. This data is then displayed. When a request for data is received, a location search is made and an indication of the closest track to the x, y position of the stylus is sent back to the display screen and software application code which causes another shape to appear around the unit and the data associated with the unit to be accessed. When the application code receives a soft switch command to place a phone call, the software uses the phone number (or IP address) associated with the unit to place the call or to send data.

If a device receives a digital message that a call is being received, the receiving unit's application code places a box or similar object around the transmitter symbol indicating who the call is from. When the call is answered, the application software changes the visual characteristics of the box. In a similar manner, when a phone receives a digital text message, photograph or video, a box appears around the transmitter's symbol indicating the transmitter of the message. The point to call network devices are participants and each one has a similar device with the same software for use as a total participant network. Other situations for calling facilities that are not part of the network are described below.

Fixed facilities' symbols selectively appear on the user's geo-referenced map display. The facility data can be accessed by identity and by location and type of facility. Device operators are provided the ability to call a facility (such as a restaurant, hotel, fire department, police station, military barracks, or other fixed entity) that appears on the map display. Each entity's phone numbers have been previously associated with that entity and stored in a facility database in the cell phone CPU that contains the identity, location and phone number of fixed entity locations that can be called. Data associated with the selected facility is obtained by the user using the stylus to touch at or near the facility map symbol's location. When a request for data is received by touching the stylus on a particular location, a location search is made and an indication of the closest facility to the x, y position is sent back to the display screen. The application code then causes a circle or other shape to appear around the facility symbol on the screen and its amplification data to appear. When the application code receives a soft switch (or hard switch) command to place a phone call, the software uses the phone number of the facility that was accessed to place the call to the facility. Thus, by using the stylus, the operator can touch a desired location on the screen such as "restaurant" and then use a soft or hard switch to initiate a telephone call directly to the restaurant without having to go to another type of display or without dialing the number.

The system shown in FIG. 1 can also initiate a telephone conference call for a small number of phones using stylus 14 contact to touch all the displayed symbols on display 16 that the initiator desires to conference and then selecting the "conference call" soft switch. The operator can also pre-establish a conference sub-net of selected participants that the operator desires to be able to rapidly call. The operator performs this task by touching the symbols or by selecting participants from a list or a matrix of the participant addresses and assigning the participants to a net software switch. When the operator desires to place a conference call to these participants, the operator simply touches the net soft switch associated with this group. Software is provided in the unit that mimics setting up a normal small conference call from "phone one" to each of the cellular phones or fixed facility phones the user had indicated by touching their symbols or selecting their sub-net soft switch on the screen. Once the first call is complete, the party will be automatically put on hold and other callers will be called or answered in sequence and put on hold until all the

parties are on line at which time the conference call will be established. As each participant is called, the phone will, optionally, announce that a conference call requested by cellular phone "one" is in progress. This will all be done by the application software.

If a conference call is desired that includes more than a small number of phone users, the use of an 800 number conferencing service is required. The initiator or operator of cellular phone "one" would select the "conference 800" call software switch and then use the stylus or finger to touch the cellular phone users' symbols or select the net of the units to whom the calls are to be placed. For example, 50 users are desired on a conference call. The cellular phone "one" would send out a SMS, internet or WiFi message to all of the identified cellular phones that cell "one" requests each cellular phone participant to call an 800 number (the given number for a conference call) to conference with cellular phone "one". Each individual cellular phone user at that point in time would then be verbally notified that a conference call was requested. Automatically, or when the user selected the "accept" software switch, the phone would then call the 800 number and enter its conference participant code.

Thus, the operator device is capable of initiating a cellular phone call by touch only, and initiating conference calls by touching the geo-referenced map symbols. Furthermore, using a similar symbol touching technique cellular phone "one's" application code can send operator selected messages to cause a remote cellular phone to display and optionally announce emergency and other messages and to optionally elicit a response from the remote cellular phone.

The present cell phone/PDA/GPS device to create the communication network wherein all of the participants have the same communication device described herein also includes the ability of a specific operator device to provide polling in which other cellular phones using SMS, internet or WiFi report periodically based on criteria such as time, speed, distance traveled, or a combination of a time, speed and distance traveled. The operator can manually poll any or all of the cell phone devices that are used by all of the participants in the communication network having the same device as described herein for the invention. The receiving cellular phone application code responds to the polling device with the receiving cellular phone's location and status which could include battery level, GPS status, signal strength and entered track data. Optionally, the phone operators can set their phones to report automatically, based on time or distance traveled intervals or another criteria.

The application software includes an application for designating geo-referenced symbols by "hooking" them. The application software determines that the stylus is pointed close to or at the location of the symbol and puts a circle or other indication around the symbol indicating that amplification information concerning the hooked track is to be displayed and indicating that additional primary data and amplifying data is displayed. This indicates to the operator that a change in the data can be made to the indicated symbol. The operator can read the primary and amplification data. The operator can then select soft switches to change the primary data and amplification data or to take other actions that may include making cellular phone calls, conference calls, 800 number calls, sending a free text message or preformatted message, sending photographs or video to the hook symbol, going to the symbol's web site, automatically filling in the symbol's E-mail address in an E-mail or dropping the symbol. In operation, the application code detects the screen location of the touched point and determines if the distance from the touched point to the nearest symbol is indicative that

the operator wants to "hook" the track. If the distance meets the preset constraints, the software places a "hook" indicator such as circle or square or other shape around the symbol and searches the database to find the information associated with the symbol. As each of the participants' network units or devices reports its identity, location and status, the data is filed into a database in the operator's device that is accessible by symbol location and identity.

With respect to hooking a fixed facility such as a restaurant, hotel, fire department, police station, military barrack, or other fixed entity, a database is created as part of the map creation process (or entered by the operator) that is used for the display screen. Optionally, the fixed facility database is contained in an on-line server. The database contains the identity, location, phone number and, if available, the E-mail, IP and URL address of the fixed locations. When a request for data from the operator is received by touching the display screen with the stylus, a location search is made and an indication of the closest facility of the indicated type to the x, y position is sent back to the display screen application code. The application code can then use the data to place a call, to send an E-mail, or to access data from the facility's website.

Another important feature using the present device allows an operator to enter on the cell phone device's geo-referenced map, a new entity or event that can include an observed object, person fire, accident or other event occurring now at a specific geographical location. The observed entity could be an event such as a fire or an explosion that requires notification to other participants. To enter the new entity (new track), the operator points and touches the appropriate location on his cellular phone/PDA's display's geo-reference map with the stylus. The operator then selects a soft switch that indicates the type of observed entity or event indicating, as an example, that the new event is a tank or a fire which causes the symbol to appear on the map representing the tank or fire. The computer application software computes the latitude and longitude of the entity and transmits the newly added symbol and its location to the other participants on the cellular phone, WiFi or by other communication device. Each participant in the communication network who has the cellular phone device, in accordance with the invention, receives the transmission message that identifies the type of new entity or track with a symbol and the current latitude and longitude of the new entity (symbol) and displays the symbol at the correct location. Furthermore, if it is desired to amplify the symbol with text or a photograph or video, the operator can enter the text, take a photograph or video of the object and attach it to the appropriate symbol. When transmitted, that data appears when the receiving cellular phone(s) and the operator(s) hook (s) the symbol. To accomplish this, the receiving phone(s) application code store(s) the track (new entity) symbol, its latitude and longitude and any amplification text, photographs or video in its database. The display application software accesses the new track from the database and converts the latitude and longitude to the display's proper x, y location and displays the track and symbol and amplification data.

Another important feature using the present device is that it can allow completely anonymous phone calling or digital communication where neither party knows the other party's phone number or name but where at least one party knows the other party's location. Calls are placed by hooking the symbol whose identifier (not necessarily the name or phone number) is known and selecting either the call, conference call, send free text, preformatted messages, photographs or video soft switch. The call or digital message is then sent to the server. Since the server receives each network identifier (its symbol's number) along with its dynamic IP address when they sign on,

US 7,630,724 B2

11

the server has the data necessary to send voice and digital data to that network participant. When the server receives a request to send voice or digital data to a symbol number and then an indication of the type of data to be sent VoIP for voice calls or conference calls, a digital message for free text, preformatted messages, photographs, or video, the server routes the VoIP or digital data to the net participant to whom it is addressed. Since both the transmitter and the receiver of the communications send data to and receive the data from the server and not from the sender, neither party knows the phone number or name of the other party. This same implementation can be utilized with standard (non-VoIP) voice calls. This is accomplished through the use of telephony interface cards at the server which permit the server to route the call to the addressee.

Referring now to FIG. 2, the same cellular phone/PDA 10 is shown with the soft switch matrix displayed at 16cc and 16dd. The cellular phone/PDA is capable of an alternative method of contacting the participants. As shown in FIG. 2 and display 16cc, a plurality of squares is displayed having letters and numbers, each square of which indicates a different participant such as "ALSQD." Also, on the right hand side, top line is a switch option called "call." The bottom line 16dd shows ZMIN, ZMOUT, CENT, GRAB and SWIT. Using this alternative telephone method, the initiator can touch individual squares, each having a reference to a participant to initiate one call or a conference call with all of the parties. These can also be joined in a single NET 1 as shown. Subsequent phone calls with the particular designated parties or participants established with NET 1 can subsequently be initiated just by touching NET 1 with the stylus or with a finger. The displayed information can be layered with a plurality of "NETS" on a next layer for contacting groups of participants in each NET. This is used in lieu of the screen symbols for conference calls.

Referring now to FIG. 3, a flow chart is shown of the activities provided by the present invention and the methodology.

In addition, the operator of cellular phone "one" can address text messages, photographs and video for transmission to one or more net participants by either touching their symbols and selecting the appropriate soft switch or selecting the appropriate call net.

Another important feature of the present invention is that the operator of cellular phone "one" can, by touching a switch on the display, send a digital message to all the PDA/cellular phones in the communications net or to designated cellular phone(s), represented by their symbols on the geographic displays, an emergency or other preformatted message which may or may not require a response and may or may not cause a verbal announcement, cause the phone to vibrate or buzz, or cause another alert. When received, the software in the remote cellular phone causes the remote cellular phone to initiate an audio or another alert to the cellular phone user that there is an emergency (or another message) and may or may not indicate that he should call the initiator immediately. This is accomplished by the message sent from cellular phone "one" to the software in the remote cellular phone(s).

In summary, the present invention provides for expeditious data exchange and cellular phone and WiFi calls to one or more users by merely touching the display screen location of a remote cellular phone user's symbol to initiate the call. The same pointing at geo-referenced symbols method is used to send free text, pre-formatted messages, photographs and video. Another method of establishing communications is to assign the participating user units to a net and then select the net to establish the call. Other features include conference

12

calling by using a stylus or finger to sequentially hook symbols or select nets, to rapidly send emergency and other preformatted messages, and to cause remote phones to announce various pre-established messages, execute text to speech software, increase its volume level, vibrate, and show pre-entered photographs or videos. Furthermore, the cell phone/PDA operator can access fixed facilities' web sites or send them E-mail messages by using the same concept of hooking their geo-referenced map symbols and then using soft switches to automatically go to their web site or to automatically fill in their E-mail address in an e-mail.

Referring now to FIG. 4, another embodiment of the invention permits automatic shifting between voice communications and high speed cellular internet communications across the communication network of cellular phone/PDA devices. In FIG. 4, information flow associated with the communications cellular phone system of the present invention is shown. The satellites 40 provide global positioning system (GPS) signals to each of the cellular phones 42, 44, 46 and 48 distributed throughout the communication area. Each of the cellular phones 42, 44, 46 and 48 automatically transmit each location data over the internet communications 52 that is provided by the cellular phone company 50. The data is sent to the command communication website server 54 which subsequently retransmits the data to all other common communication units or if specifically addressed data is received to the addressed specific communication unit such as cellular phones 42, 44, 46 and 48. If one of the cellular phone units, such as cellular phone 42 operator makes a voice call or is called, the system cellular phone automatically drops out of high speed data communications and goes to a slower Short Message Standard (SMS) communications mode which can be used simultaneously with voice communications. When this occurs, the other communication units 44, 46 and 48 detect the fact and transmit data to the communication unit that is in SMS using the SMS technology. When the voice communication is ended at cellular phone 42, then the cell phone again begins transmitting over the internet. The other cellular phones 44, 46 and 48 detect this fact and stop transmitting to it in SMS mode. Thus, automatic shifting from GPRS/EDGE/CDMA/1XEVD0/ to SMS occurs when the voice communication phone is in use and automatic shifting back to GPRS/EDGE/CDMA/1XEVD0 occurs upon completion of the voice communication call. Another method for shifting between high speed and internet is as follows: If one of the cellular phone units, such as cellular phone 42 operator makes a voice call or is called, the system cellular phone automatically drops out of high speed data communications and goes to a SMS communications mode which can be used simultaneously with voice communications. However, instead of sending the SMS messages to the other participants, the phone transmits its data in SMS to the Server which then retransmits the data in GPRS/Edge/1XEVD0 or WiFi to all the other participants. Location, status and text data from the other participants is then retransmitted by the Server to the phone in SMS. Photographs and Video Clip data is held by the Server for retransmission to the phone in SMS until the phone call is completed and the phone has returned to high speed GPRS/1XEVD0. When the phone call is completed, the phone returns to GPRS/EDGE/1XEVD0 and that fact is detected by the Server which then reverts to high speed GPRS/EDGE/1XEVD0 communications with the phone.

Referring now to FIG. 5, which depicts a process flow diagram of the present invention transfer protocol that allows photographs and video transfer across multiple cellular carriers between smart phones and personal computers (PCs). In contrast to existing multimedia services offered by cellular

carriers, the present invention functions across different cellular carriers including carriers using CDMA, GSM and WiFi. The primary key to the invention lies in the command Server which includes a collection of software applications and publicly visible IP addresses that can be accessed by internet capable mobile devices.

Specifically, the present invention transfer is comprised of several key concepts which include the use of a globally accessible Server to facilitate the transfer of photographs and video clips. The specification of a protocol uses distinct control and data ports that are capable of supporting multiple simultaneous transfers. This protocol can be implemented on a variety of intelligent phones and personal computers. As shown in FIG. 5, the hand set is sending to the command Server that listens for connect port 81. The data is sent in one K-blocks (which can be throttled if needed) and then closes the socket to indicate EOF. At the Server, available status is made on port 80 with notification via UL. User picks download in UL. The Server sends out the new command center file available message with available status on port 80. The hand set that is receiving provides notification back to the Server via UL and the user picks download in UL. The hand set receiving then connects to port 81. Once the hand set receiving is prepared, the data is sent in one K-blocks from the Server to the hand set receiving which is closed out to indicate EOF.

By the use of this protocol shown in FIG. 5, photographs, video clips, and video can be transferred between cell phones operated by different cell phone vendors in either CDMA, GSM or a combination of the two.

Referring now to FIG. 6, a flow chart shows how the device operator can switch between voice and SMS and high speed internet data transfer. As shown in FIG. 6, the operator turns the cellular phone on and selects the application software. The application software puts the telephone in a digital data transfer mode. The software operates exchanging position, tracks, text, photographs and video clips. The operator then decides to make a voice telephone call either by hooking a participant unit cellular phones' symbol or a fixed facility symbol and selecting the voice call, conference call, or 800 call soft switch. The application software then puts the phone in voice and SMS mode for that voice call. When the voice transmission is finished, the operator hangs the telephone up. The application software detects the hang up and automatically shifts back to the digital data transfer mode.

The invention also allows an operator to assign text, photographs, or a video to a map symbol that is displayed on the navigation map display. When the operator enters text, takes a photograph or takes a video clip, the operator can then touch the map symbol with which the operator wants to associate the map symbol with the text, photograph or video clip. A soft switch is selected to associate the text, photograph or video. The symbol to which the text, photograph or video clips are assigned, can be moving or stationary. Subsequently, if any other users on the cellular phone network or the operator touches i.e. "hooks" the symbol, the text, photograph or video will be displayed. This is a very important feature in that instead of a participant looking at what would be a symbolic display of, for example, an enemy tank, the sending and receiving participants are able to hook the symbol, view an actual photograph or video of the stationary or moving tank.

The touch screen display includes an activating switch that, when touched, causes a matrix of software driven layered switches (soft switches) to appear on the cellular phone/PDA display in place of the readout and insert areas. Some of these soft switches, when touched, cause the cell phone/PDA device's functions to occur. Other soft switches cause yet

another layer of soft switches to appear, replacing those that were previously displayed. The operator is provided a visual display indicating the specific layer in use from the layers of switches, and is able to return to the previous layer or to cause the layered switches to disappear such that only the basic switches remain. The operator can also use the cell phone's hardware pointing device (navigation pad) to control the soft switches. By using these soft switches and hard switches that are part of the cellular phone, the operator can activate different maps, change map scales, select which fixed entities are desired to be displayed, display the information concerning the symbol the operator has touched, initiate phone voice calls, send messages (free text, preformatted messages, photographs and videos), enter symbols and information representative of other entities, view the locations and statuses of the other communications net participants, establish conference calls, and pre-establish conference sub-nets. The conference sub-nets, when activated, cause all the phone numbers that are specified to be conferenced for voice, text, preformatted messages, photograph and video communications, and transmit messages to remote phones which cause the remote phones to make calls, verbal announcements, vibrate, increase sound levels and other functions. The operator can also use the soft switches to cause the cell phone/PDA or if embodied in a cellular or WiFi enabled personal computer or tablet to automatically access "hooked" fixed facility web sites and to automatically addresses E-mails.

The soft switch application software causes a visual display of a matrix such as five across by six up (or other matrix) in which switch names are placed on the cellular PDA display. The soft switch application software knows the touch screen location of each of the switches in the matrix and the software routines that will be activated upon touching the switch.

The bottom row of soft switches displayed on the touch screen remains visually fixed. These switches concern the functions that are the most often used. One of the switches causes a matrix of other soft switches to appear above the visually fixed soft switches. These switches are function soft switches, the activation of any one of which causes a different matrix of soft switches to appear, which are known as the action soft switches. When the action soft switches appear, the function soft switch which causes the action soft switches to appear as a label in the lower left (or some other standard location) indicating to the operator the types of actions the operator can take. When the operator selects an action soft switch, the appropriate application software to accomplish the action is activated.

Upon receiving a soft switch activation message, the software accesses the appropriate task execution software which accomplishes the required tasks including enter track data, enter track amplification data, send alpha/numeric messages, send photographs, send video, read messages, select map types, voice call, conference call, 800 call, set up selections, display actions, polling units, set up nets such as groups of users or locations, and drop track. By providing a matrix and layers of soft switches which are easily manipulated by a stylus, each cell phone device in the communication network is extremely efficient in accessing and coordinating the appropriate application program for the device to perform.

There are several ways that the network can be established including: A. POLLING—To initialize the communications net, the cellular phone "one" operator selects, from a list, the other users (or all of them), that the operator desires to be part of the communications net. The system then polls the selected phones to activate and become part of the communications net. The selected phones then transmit their GPS positions to all the other phones in the established net. Through interac-

tion with one or more other software enabled cellular phones, symbols are generated on the operators' displays based on the participants' latitude and longitude that is exchanged between the cellular phones. The transmission of this information is based on an algorithm which considers time and/or movement or which is based upon a polling request. B. ALL REPORT—Another method is for each cell phone sets its own transmission times based on time or movement. When its initial message is received by the other participants they report their location and any tracks that they have entered. C. GROUP—IDENTIFIER BY TYPE—Another method is for each phone to have a group identification that is transmitted in its initial message which relates it to a particular group who are their own net, only those with that identifier (i.e. singles, coin collectors, etc.) are permitted to join that net, and yet another method. D. FRIENDS AND FAMILY—Only those who are in an approved list maintained by the server or internal to each phone are permitted to join that network.

Each of the communication net symbols on the display represents a different cellular phone remote from cellular phone "one". Each of the cellular phones has the phone numbers of all the phones that it expects to exchange data with in its database. If additional phones desire to join the net, they transmit their designation and their phone number in their initial message so that they can be identified. The net can be set to either enable these phones to join the net or to be set to exclude them from the net. Each of the phones also has in its database the pre-established phone numbers and, if available, the E-mail addresses and URLs for the fixed locations buildings, facilities, military bases, and other desired locations that can be called or accessed in its database. The touch screen provided with the LCD display in the cellular phone includes x, y coordinates that are correlated with the geo-referenced map on the cellular phone display and the geographic location of the fixed sites and the cellular phones participants in the communications net. The operator of each cellular phone can enter an object of interest by touching the display screen at the object's location on the display screen map. The operator can then assign each object a category (car, person, tank, accident, or other category) and amplification data including: text, photographs and video. The latitude and longitude of each object along with its category and other information is then sent on the communications network. Because each of the receiving cellular phone/PDA devices has software that automatically converts the received data to the correct map location, the transmitted symbols appear at the correct location without operator intervention and their category information and amplification information is available by touching the symbol on the display screen.

Each cellular phone/PDA/GPS device contains the communications hardware, along with the circuitry and software, to initiate a voice telephone call or transmit data messages, photographs, or videos by an operator touching the display screen with a stylus or finger at the symbol location displayed on the screen of the desired cell phone net participant to be called and then selecting the: "call", "free text", "preformatted message", "photograph" or "video" software switch on the display touch screen. The call is then done automatically. Each of the fixed facilities can be called in a similar manner; however, since the fixed facilities' phones are not one of the participating phone devices, they do not have the application code; thus "free text", "preformatted message", "photograph" or "video" type data can not be sent. The software will then cause the participant cellular phone to call or send the appropriate data to the specific phone number represented by the symbol on the screen. This action alleviates completely the steps of looking up a phone number and manually entering

the phone number required or IP address to make a cellular phone call or a WiFi, VoIP call, or to send data. Each cell phone device can use software for VoIP calls. The database in the cellular phone/PDA devices includes the phone numbers of each the other network participant symbols and, if available, the E-mail and URL address of each fixed facility on the map. The fixed facility E-mail and URL address enable the operator to go to the fixed facilities' web sites or to automatically fill in their E-mail addresses by hooking the fixed site's symbol and selecting the appropriate soft switch.

Using the application software on a cellular phone/PDA device in accordance with the present invention, permits the cellular phone user to enter and transmit data such as text, preformatted messages, photographs or video clips associated with a symbol on the geo-referenced map display and to then transmit the data associated with the symbol to other net participants automatically or by hooking the symbol and selecting transmit. The touch screen symbol can be stationary or moving. When the receiving participant points at the symbol, the symbol is hooked. The associated data (text, preformatted message, photographs or video clips) that was entered by the participant and transmitted will appear on a portion or on the whole touch screen of the receiving participant's display. Thus, if the operator of a cell phone device were in a situation where the operator observed a moving target, such as a tank, that had a symbol representative of a target on the operator screen, the operator can enter the text data or preformatted message, a photograph of the actual tank that is being observed, or a video clip of the actual tank that is being observed, which can all be transmitted rapidly to a recipient participant involved in the entire situation. Thus, when the recipient participant hooks the symbol he can view the free text, preformatted message, photograph or video of the actual target that has been sent by the operator. In this case, the cell phone software program generates the moving symbol and stores the entered text message or has a selected preformatted message stored, or captures and stores the photographs or video clips using a video camera into memory, and associates the entered data with the symbol that was generated that represents the moving target and transmits the data to one or more participants of the net.

Another embodiment of the present invention provides for full transfer of photographs, video clips, and high speed data between any cellular phone vendors in either CDMA, GSM, WiFi or a combination of these. Thus, using the present invention, photographs and video can be transferred across multiple cellular carriers between smart phones and personal computers. This is accomplished by a command server which includes a collection of machines publicly visible IP addresses which can be accessed by internet capable mobile devices. With the present invention, there is the use of a globally accessible server to facilitate the transfer of photographs and video clips between each of the cellular phone users in the communication network. The method and communication network also includes the specification of a protocol that uses distinct control and data ports capable of supporting multiple simultaneous transfers. This protocol is implemented on a variety of intelligent phones and personal computers.

The software in the present communication device can provide to each user participating with the same software the ability to make voice calls and to send free text, operator selected messages, photographs, and video to all other user participants within a certain distance to be determined by the initiator of the call or data. The software enables the initiating user to indicate the farthest recipient within the geographical range to whom the initiating user wants to call, and to send

free text, operator selected preformatted messages, photographs or video, by selecting an appropriate soft switch. The initiating user's device will then call or transmit the free text, operator selected preformatted message, photograph or video to the farthest participant in the selected range and all other participants that are closer. This is similar to the conference voice call discussed above but, in this particular software managed situation, all of the parties, from the farthest to the nearest, within that range can receive the same call, free text message, operator selected preformatted message, photograph and video. Again, this action is a tremendous time saver for the initiating user to get these types of messages to all of the participants within a given range. The operator "hooks" a track that is stationary or moving and selects a soft switch specifying that the operator desires to conference call all network participants or to send free text, operator selected preformatted message, photographs or video that are the same distance or closer than the range of the hooked track. The application software then searches the geo-referenced database (containing latitude and longitude or similar positional attribute) for all the network participants within the specified range. Upon finding them, the application software: (1) sends a message to the cell phone to call or conference call the identified participant's network, (If the number of participants is greater than the number permitted by the phone's conferencing capability, the application software instructs the phone to make a call to an 800 number and cause all of the other phones to make a similar call and to automatically enter their participant code) or (2) sends a free text message, an operator selected preformatted message, a photograph or a video to all the participants within the specified range. The operator can use the same technique to call fixed facilities, but because the fixed facilities do not have the application software, the operator can not send text, preformatted messages, photographs or videos.

The present invention includes other features for a cellular telephone communications device that provides calling all other people on the communications network that have a specific attribute such as all of the squad leaders within a company or all the company commanders within a battalion. Also, the device will notify one or more of the users within a variable range when someone else using the software approaches and provides for automatic calling within a specified range of a particular user's cellular phone.

Another feature of the present communication system is to enable the cellular user to use a Smart Phone or a personal computer such as a desktop, a laptop computer or a tablet computer that is equipped with a CDMA, GSM cellular telephone or WiFi card, a global positioning system (GPS) receiver and a digital camera that can accomplish all of the communications that have been described in the application. Thus, the PDA software provided for this communication system is readily adaptable into a personal computer, laptop computer or tablet along with a digital camera and GPS once the cellular telephone or WiFi card is installed in the system. The present communication system is also capable, based on the software and hardware of the present invention, of using wireless communications (WiFi) in lieu of the cellular communications that have been described herein. The system can use an integrated wireless capability or a wireless card that allows transmission and receipt of wireless communications in accordance with any conventional wireless protocol.

Automatic Identification System (AIS) is a communication system that is used between ships for identifying the name, position, heading, and velocity of nearby ships. Each ship has its own display and receives constant signals from all the other ships within line of sight. The AIS constantly trans-

mits updates of each ship's current location, course and speed and other pertinent data within line of sight. The AIS reports are transmitted at a variable rate. With the software in the present communication system, a remote server receives, processes and correlates the AIS reports. The server then transmits the AIS ship locations to all the cellular/PDA phones (and PC/tablets) that are network participants. Each network participant is able to view the location of all of the other participants in the net and to also view the location of the AIS equipped ships on each participant's display. Furthermore, the AIS data content (ship name and other data) of the AIS reports are displayed when the AIS symbol is hooked on a participant's cell phone/PDA display. The server application code receives the AIS digital message, determines the type of AIS message and processes the data appropriately, storing the AIS data into a database organized by MMSI number or another unique AIS ship identification means. The AIS data is then retrieved from the database using one of several criteria including the: (a) time since last transmitted and (b) speed of the ship. The retrieved AIS data is then processed by a transmission routine which transforms the data into a format that is compatible with the cellular Internet transmission means or SMS or WiFi and outputs the data to net participant cellular phones/PDA (and PC/Tablets) at the correct latitude and longitude. The AIS cellular phone/PDA (and PC/Tablet) application software receives the server formatted AIS data and stores the data in a database. The data associated with each AIS track is then retrieved from the database by the cell phone device display software and transformed to the correct x, y display position to correspond to each track's latitude and longitude. When the track is hooked, the AIS amplification data, or a subset of it, is displayed to the user.

The software program contained in the cellular phone/PDA using the present invention can generate a display indication of a symbol's speed and heading. The speed and heading are indicated by a small line attached to the symbol. The line's direction indicates the symbol's heading and line's length indicates the symbol's speed. When the cell phone generated symbol's speed and heading are transmitted, the receiving participant's device also displays the speed and heading in the same manner. When the user notices that a track has moved from the location that the user first observed, the user can point by touch screen to the display location where the track has moved to on his cellular/PDA display. This new location data is then converted to the appropriate latitude and longitude. The velocity generation application code then computes the speed and heading, taking into account the time interval between the time the track's previous position was entered and the time that the new location was entered. The velocity generation application code then passes the velocity (heading and speed) to the display generation code. When the display generation application code receives the speed and heading data from the velocity generation application code, the display generation code attaches a line to the symbol. The line's length indicates the track's speed and the line's direction indicates the track's heading.

The cell phone/PDA map display in accordance with the map software program provides a geophysical display using a geo-referenced map, chart, satellite image or aerial photograph of a given area or location. This map can be based upon and received from the worldwide databases that are maintained by the U.S. Government and others and loaded on to the cellular phone CPU database. The cell phone device application software, however, can also provide to a user the ability to request a specific geo-referenced map or chart, aerial photograph or satellite image from a remote image server by pointing at the specific location desired for the map, aerial

19

photograph or satellite image and selecting the display range and selecting the request image soft switch. Activation of the request soft switch causes a message to be sent to the remote server that causes a geo-referenced chart, map, aerial photograph or satellite image to be sent to the requestor's cell phone/PDA device where the image is geo-referenced and displayed.

Another feature of the present communication system is to provide to each user's cell phone device geographic notification on the touch screen display of the location of the sender of a message to the user. With two or more of the cellular phone/PDA devices in the network, a message recipient can hear an audible voice alert, or beep or tone that alerts the participating recipient to an incoming message. The additional feature is that a different color box or circle will appear around the symbol on the geographic display that represents the participating sender of the incoming message. Thus, the participating recipient is immediately apprised of the specific location and, thus the importance, of the party who is calling or transmitting a message to the recipient. In the case of a battle or disaster scenario, it could be that the geographical display screen will show an incoming message from someone who is right along the forward battle line or in an area of a recent disaster. This will tell the recipient to immediately read the message. The recipient can either select the read message soft switch and then select the message from the message list or hook the indicated symbol to display the message whether it is text, preformatted message, photographs, or video. Thus, the internal software program in each cell phone device can alert the recipient that a message is being received and the location of the sender on the display by a color or other type of indicia surrounding the symbol that represents the message sender for rapid notification to the recipient of who is sending the message.

The present cell phone/PDA devices used in the communication network system can provide to each user the ability to cause a text, preformatted message, photograph, video clip and high speed data to be "pushed" to other participants' cell phones so that the data sent does not have to go to a website to pull off the photograph or video clips.

Another feature of the cell phone device used in the present communication system is to provide to each user the ability to go to a fixed faculty's web site (such as a restaurant) by hooking fixed site's symbol (and thus obtaining its URL) and selecting a soft switch that requests that specific web site. This same feature can be used to automatically address E-mails by hooking a fixed site's symbol (and thus obtaining their E-mail address) and selecting a soft switch that requests an E-mail form and automatically fills in the fixed site's E-mail address.

The software with the present communication system provides to each user the ability to cause an alert (verbal, vibrate, or text) to emanate from or appear on the user's display when another user is within a predetermined distance of the user and, furthermore, to be able to automatically call that individual by selecting the call soft switch.

The cellular phone/PDA device can provide the user with the ability to select a soft switch that causes the cell phone to call the geographically nearest member of a particular group of members such as the nearest police station, fire station, EMT unit, or other member that can include services such as plumbers or electricians. The software can be set up so that the cellular phone/PDA's software searches the database to find the nearest geographic police station or fire station, or whatever the selected group is, and would automatically make a cell phone call to that number. The GPS application software is constantly updating the database with the GPS location of the user which is then superimposed on the display

20

map. Fixed facility locations of interest to the user are stored in a non-network facility location database along with their phone numbers and, if available, their email addresses and their URLs. These groups and member locations include types of facilities such as: restaurants, police stations, fire departments, gas stations, restaurants and military installations. When the operator selects to call the nearest facility location, the position application software searches the non-network fixed facility database to determine the closest facility of the type that the operator has selected. When the nearest facility of interest is found, the position application software sends a message containing the nearest facility's phone number, (and if available URL and E-mail address) to the application software. When the application software receives the nearest location of interest, the software places a modifier around the symbol that is associated with the location of interest and places the call or if different soft switches have been selected goes to their web site or automatically addresses an E-mail.

The data link application software is constantly updating the database with information concerning the position, identity and status information of the network participants' devices in each cell phone CPU transmitting on the cellular, WiFi or SMS network. Tracks that are entered are being constantly repositioned as the tracks move. The database is constantly sending the cell phone device and track data to the display database so that the display can be updated with new device positions and track data received from the participants in the network. The position application software computes the range from the user to the other network participants and tracks "entities" received from the other net participants and creates an alert if the range is less than the range specified by the operator as the notification range. When the alert is created, the alert is sent to the display and voice announcement application code. When the display application code receives the alert, the code then posts a visual indication such as a modifier around or near the cell phone device or track that is within range. When the voice alert application code receives the alert, the code either accesses a prerecorded voice announcement or utilizes a speech to text software application to make a verbal announcement.

The instant invention has been shown and described herein in what is considered to be the most practical and preferred embodiment. It is recognized, however, that departures may be made there from within the scope of the invention and that obvious modifications will occur to a person skilled in the art.

What is claimed is:

1. A method of providing a PDA cellular phone communication network for designating participating users displayed symbolically on a geographical map, each user having a similarly equipped cellular phone that includes CPU, GPS navigational system symbol generator and a touch screen display comprising the steps of:

selecting screen icons for establishing rapid voice initiation and communication to the users of the cellular telephone PDA/GPS network system using a touch screen; transmitting high speed internet selected text messages, photographs and video to other cellular phone users by touching each user's geo-located symbol on the touch screen;

establishing a network of cellular phone PDA devices for said users having the same operating software that permits either voice communication and low speed communication or high speed internet communications;

communicating by icon selection with a remote server for receiving and transmitting over the internet high speed

US 7,630,724 B2

21

internet communications or low speed communications to each of the user's cellular phones in the cellular phone network;

selecting symbols on said display touch screen representing other participants having similar cellular phones forming a communication network;

selecting by screen icon application software in each cell phone or a server for automatic triggering of stored selectable individual criteria and subject type and range for netting of said cell phone in a like group;

selecting icons for communicating with said remote server with the selectable criteria and subject matter and cell phone numbers and IP addresses of the selected user's having the criteria and subject matter;

selecting application software in each cell phone or server for utilizing a list of approved net participants that can join a net;

selecting screen icons for communicating a position report and status information from one among all of the other users equipped with cellular phone/PDA/GPS system and its associated software and displaying the user's symbol on the map display at the correct location;

selecting a screen icon for transmitting rapid voice call initiation to the users of the cellular phone/PDA/GPS navigational system using a touch screen and the users' symbols; and

selecting a screen icon for transmitting rapid transmission of free, operator selected text messages, photographs and video to another cellular phone using the touch screen.

2. A communication system as in claim 1, including: displaying the symbol's velocity as a line emanating from the symbol whose direction is representative of heading and whose length is representative of speed that is seen by the other participants in the communication networks as in claim 1 when the symbol's velocity is transmitted to them.

3. A method for providing a cellular phone communication networked for designated participating users, each having a similarly equipped cellular PDA phone that includes a CPU, a GPS navigational system, and a touch screen display comprising:

Selectively activating one or more touch screen icons for activating transmission of selectively polling and status information from one user among all of the other users equipped with said cellular phones and its associated software;

activating a touch screen icon for automatically reporting position and status to a server for appropriate transmission or directly to one or more other participant users' cell PDA phones in said communication network based on predetermining condition;

activating a touch screen icon for reporting position and status based on a predetermined condition that includes distance traveled since last report; and

selecting a touch screen icon establishing voice conference calls and sending free text, operator selected messages, photographs, and video to all other network participants within a distance determined by the initiator of the voice call, free text, operator selected messages, photographs, and video.

4. A method for providing a communication network for designated participating users as in claim 3, wherein:

selecting an icon for creating a predetermined condition having specific users automatically reporting at specific times and/or distances traveled by the reporting user.

22

5. A method for providing a cellular phone communication network for designated participating users as in claim 3, wherein:

transmitting an alert automatically activated by previously entered information, or obtained from a database about fixed facilities or entered tracks that reach a minimum predetermined distance from a cellular phone user.

6. A method for providing cellular phone communication network for designated participating users, each having a similarly equipped cellular phone that includes a CPU, a GPS navigational system, and a touch screen display comprising:

generating a map of a geographical display on each user's cell phone display screen;

selectively polling position and status information from one participating user between one or more of the other participant users equipped with similarly configured cellular phones and its associated software;

providing rapid voice call initiation from one participating cell phone user between and among the participating users of the cellular phone network system using a touch screen;

providing one or more symbols on said map displayed on touch screen representing other user participants, each user having a similar cell phone forming the communication network;

calling one or more participant users by touching the screen symbol representing another participant user on the touch screen and touching a call switch;

adding a new track symbol representing an object, person or event, fixed or mobile, to the geographical display by touching the geographical display at the location of the new track to be added;

assigning a category to the new track to be added on the geographical display screen, said category being an object, person or event;

selecting an appropriate category switch for identifying the new track selected;

selectively attaching text, photographs video clips, voice recording, Email address and URL address to the track so that when the user receiver of the track touches the symbol associated with the track, the user receives this information; and

sending to one or more of the other participant users of the cellular telephone network information concerning the new track including the new track's location and category to the other participant users.

7. A method for providing a cellular phone communication network as in claim 6 including the additional steps:

displaying tracks symbols received from other network participants on the cell phone's touch display screen at the correct geographic location superimposed on a geographic map and further display the identity of the symbol and the text of the transmitted location and other received data when the track symbol is touched or selected by a different means.

8. A method for providing a cellular phone communication network as in claim 6 including the additional steps of:

amplifying an entered track symbol on a user's touch screen display with free text, preformatted messages, photographs or video or other digital files and transmitting the data to the other participants either directly or through a Server so that each of the participating network user's can receive and view the information associated with the track symbol by touching the geographic located map symbol.

9. A method for providing a cellular phone communication network for designated participating users, each user having

US 7,630,724 B2

23

a similarly equipped cellular phone that includes a CPU, GPS navigational system, an interact message transmitter and receiver and a touch screen display comprising:

accessing a database in each cell phone that includes a geographical map of a predetermined area for user viewing on the touch screen display; 5
 accessing an application program in each cell phone for generating one or more symbols representative of one or more participating users, each of whom have a similarly equipped cellular phone; 10
 accessing a database in each cell phone that includes cellular telephone numbers of each of the participating users having similarly equipped cellular phones, said database including the generation of one or more symbols associated with a particular participating user; 15
 calling a participating user by touching the symbol on the map display and touching a call switch;
 connecting each of the cell phones to an internet connection;
 exchanging IP addresses using SMS or other digital message format between and among each of the network participant users so that communications between participants is established via IP or transmission of a network participant's IP address to a server which then transmits data to other network participants using the IP address previously. 20

10. A method for providing a cellular phone communication network as in claim 9 comprising the additional steps of: pushing photographs or video clips files between and among each of the cellular telephone participants users across multiple cellular carriers and between smart phone and PCs. 30

11. A method for providing a cellular phone communication network as in claim 9 comprising the additional steps of: enabling data exchange between network participants who have common cellular phone numbers in their phone's or PC's database. 35

12. A method for providing a cellular phone communication network as in claim 9 including the additional steps of: adding a new cell phone participant into a communication network of participating users by having the new cell phone participant transmit an identifier, a cell phone number and an IP address in an initial message to other participant users or to a server for retransmission of the data other network participants. 40

24

13. A method for providing a cellular phone communication network as in claim 9 including the additional steps of: sending each participating user directly or to a server for retransmission the geographic location of the sender of a message.

14. A method for providing a cellular phone communication network as in claim 9 including the additional steps of: automatically calling the nearest fixed location from a particular group including: police stations, fire stations, or EMTs or other fixed locations by one or more of the cellular phone network participants.

15. A method for providing a cellular phone communication network as in claim 9 including the additional steps of: entering on a user's touch display screen a new track by touching the display screen at the correct map location and selecting the type of symbol to be displayed, causing that symbol identifier to be transmitted to the other network participants either directly or through a server and as the track's location moves, sending new location data to the other participants relative to the new track so that each of the participating user's display is updated with the new track's position.

16. A method of providing a cellular phone communication network for designated participating users, each having a similarly equipped PDA cellular phone that includes a CPU, a GPS navigational system and a touch screen display comprising:

selecting an icon that establishes rapid voice call initiation and communication to the users of the cellular telephone PDA/GPS network system by touching their symbol on the phone's a touch screen;

transmitting high speed internet rapid transmission of operator selected text messages, photographs, voice recordings and video to other cellular phone users using the touch screen;

accessing a server for establishing high speed internet communications between said cellular phone network users and said server; and

generating at the server networks enabling anonymous voice and data communications so that neither the originator of the phone call or data transmission nor the receiver of the phone call or data transmission need to know the other's phone number, name or other identifier other than a symbol location on a map.

* * * * *

Exhibit C



US008213970B2

(12) **United States Patent**
Beyer

(10) **Patent No.:** **US 8,213,970 B2**
(45) **Date of Patent:** **Jul. 3, 2012**

(54) **METHOD OF UTILIZING FORCED ALERTS FOR INTERACTIVE REMOTE COMMUNICATIONS**

(75) Inventor: **Malcolm K. Beyer**, Jupiter Inlet Colony, FL (US)

(73) Assignee: **Advanced Ground Information Systems, Inc.**, Jupiter, FL (US)

(*) Notice: Subject to any disclaimer, the term of this patent is extended or adjusted under 35 U.S.C. 154(b) by 367 days.

(21) Appl. No.: **12/324,122**

(22) Filed: **Nov. 26, 2008**

(65) **Prior Publication Data**
US 2009/0075685 A1 Mar. 19, 2009

Related U.S. Application Data
(63) Continuation-in-part of application No. 11/612,830, filed on Dec. 19, 2006, which is a continuation-in-part of application No. 11/308,648, filed on Apr. 17, 2006, now Pat. No. 7,630,724, which is a continuation-in-part of application No. 10/711,490, filed on Sep. 21, 2004, now Pat. No. 7,031,728.

(51) **Int. Cl.**
H04W 4/00 (2009.01)

(52) **U.S. Cl.** **455/466**; 455/88; 455/404.2; 455/412.1; 455/412.2; 455/414.4; 455/415; 455/416; 455/418; 455/419; 455/420; 455/456.1; 455/456.3; 455/457; 455/458; 455/463; 455/500; 455/517; 455/518; 455/519; 455/556.2; 701/213; 701/482

(58) **Field of Classification Search** 455/41.1, 455/416, 518, 519, 41.3, 88, 404.2, 412.1, 455/414.4, 415, 418, 419, 420, 456.1, 456.3, 455/457, 458, 463; 701/213, 482

See application file for complete search history.

(56) **References Cited**

U.S. PATENT DOCUMENTS

7,031,728 B2	4/2006	Beyer, Jr.	
2002/0061762 A1 *	5/2002	Maggenti et al.	455/519
2004/0082352 A1 *	4/2004	Keating et al.	455/519
2004/0192365 A1 *	9/2004	Dalton et al.	455/517
2005/0241026 A1 *	10/2005	Esler et al.	D24/100
2006/0199612 A1	9/2006	Beyer, Jr. et al.	
2008/0076410 A1	3/2008	Beyer	

* cited by examiner

Primary Examiner — Nick Corsaro

Assistant Examiner — Amanuel Lebassi

(74) *Attorney, Agent, or Firm* — Malin Haley Dimaggio Bowen & Lhota, P.A.

(57) **ABSTRACT**

The system and method having a specialized software application on a personal computer or a PDA/cell phone that that enables a participant to force an automatic acknowledgement and a manual response to a text or voice message from other participants within the same network. Each participant's PDA/cell phone includes a force message alert software application program for both creating and processing these forced message alerts. The system and method enabled by the force message alert software application program provides the ability to (a) allow an operator to create and transmit a forced message alert from a sender PDA/cell phone to one or more recipient PCs and PDA/cell phones within the communication network; (b) automatically transmit an acknowledgement of receipt to the sender PDA cell phone upon the receipt of the forced message alert; (c) periodically resend the message to the recipient PCs and PDA/cell phones that have not sent an acknowledgement; (d) provide an indication of which recipient PCs and PDA/cell phones have acknowledged the forced message alert; (e) provide a manual response list on the display of the recipient PC and PDA/cell phone's display that can only be cleared by manually transmitting a response; and (f) provide an indication on the sender PDA/cell phone of the status and content the manual responses.

13 Claims, 6 Drawing Sheets

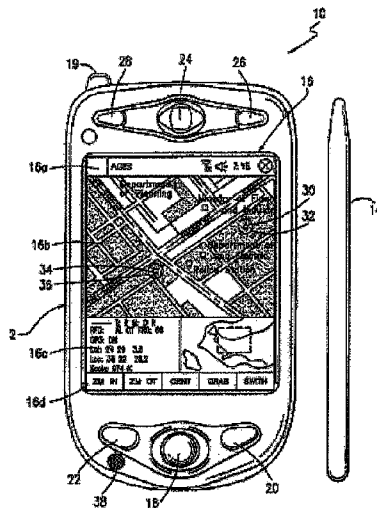

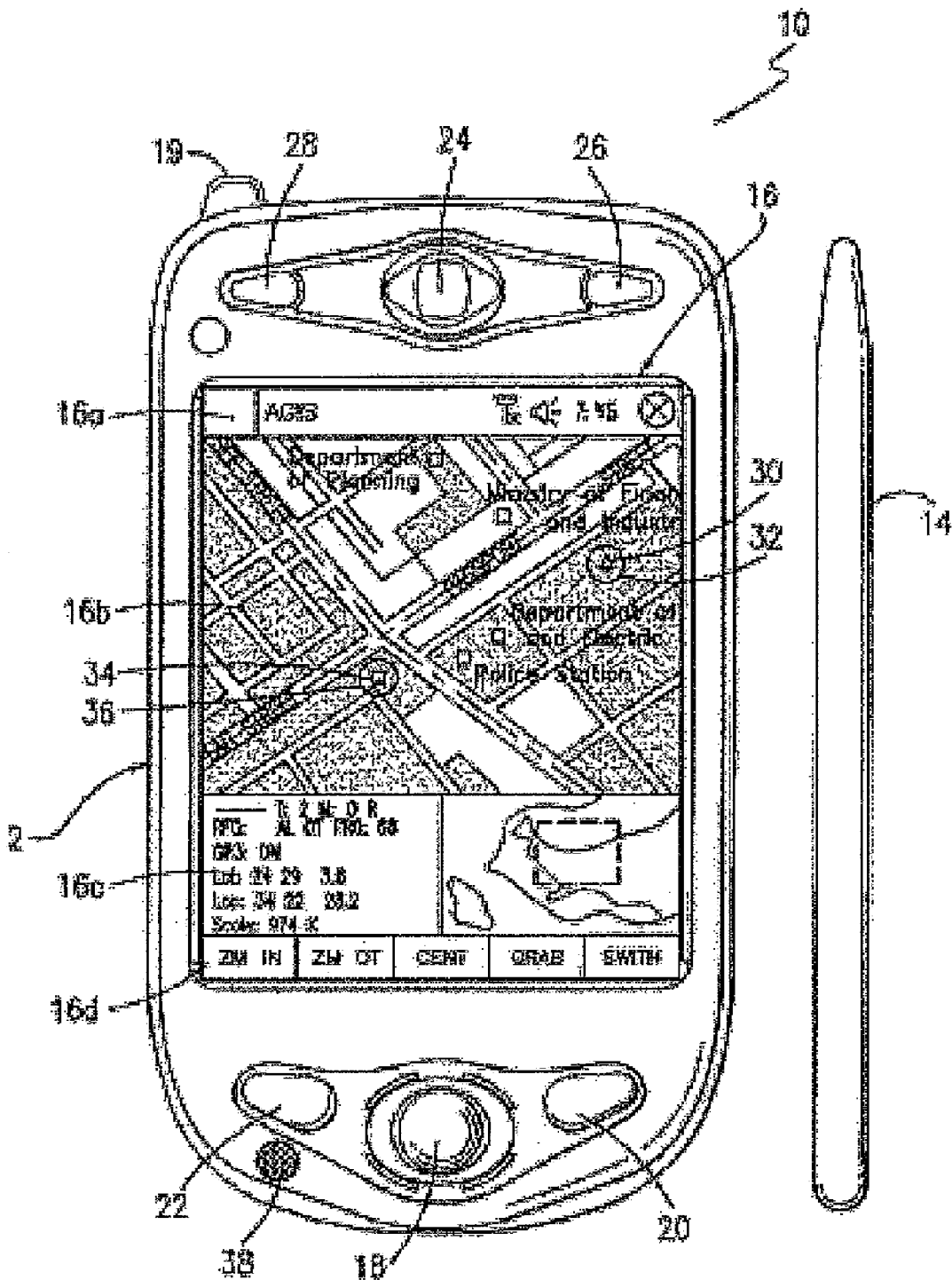

Fig 1a

***Fig 1b***

Fig. 2

Fig. 3A

Fig. 3B

Fig. 4

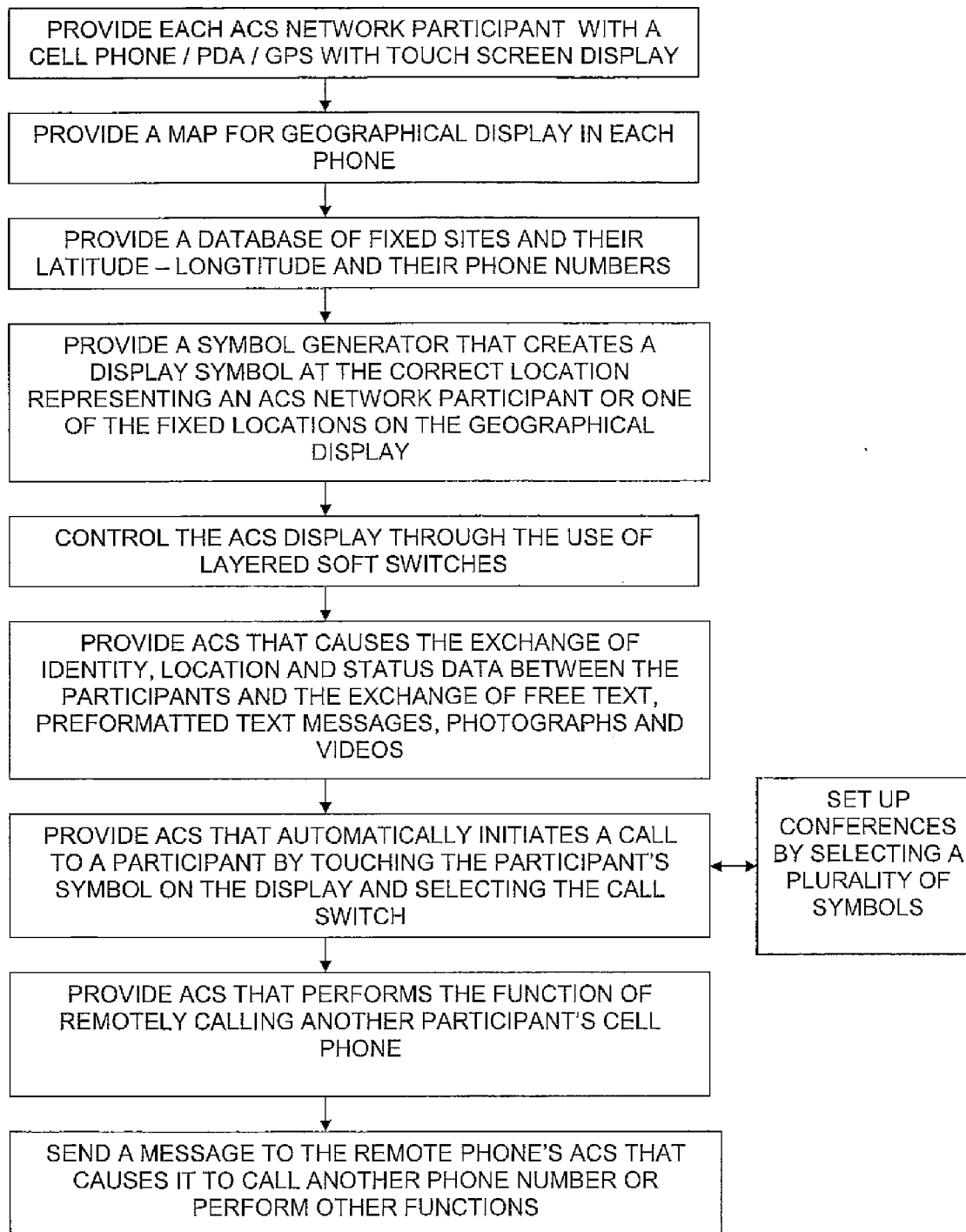
US 8,213,970 B2

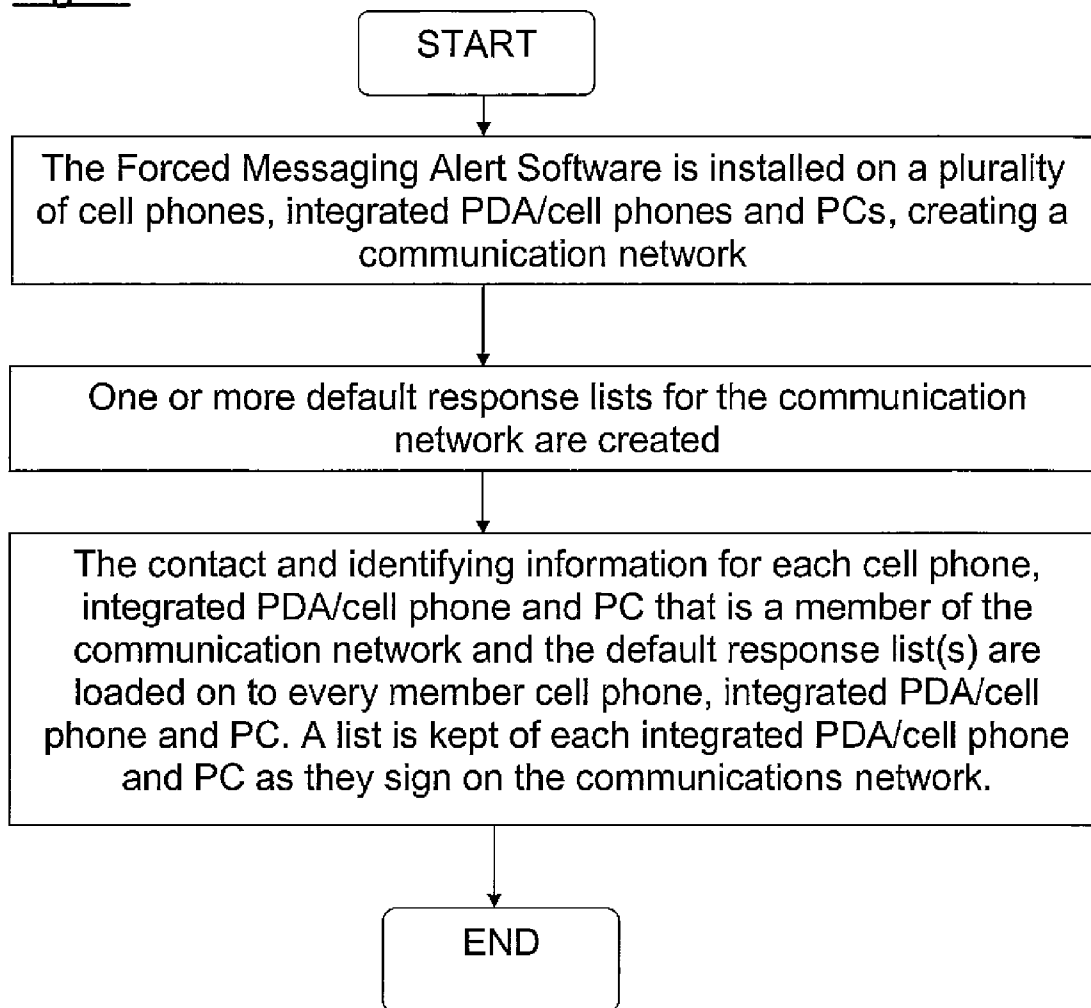
1

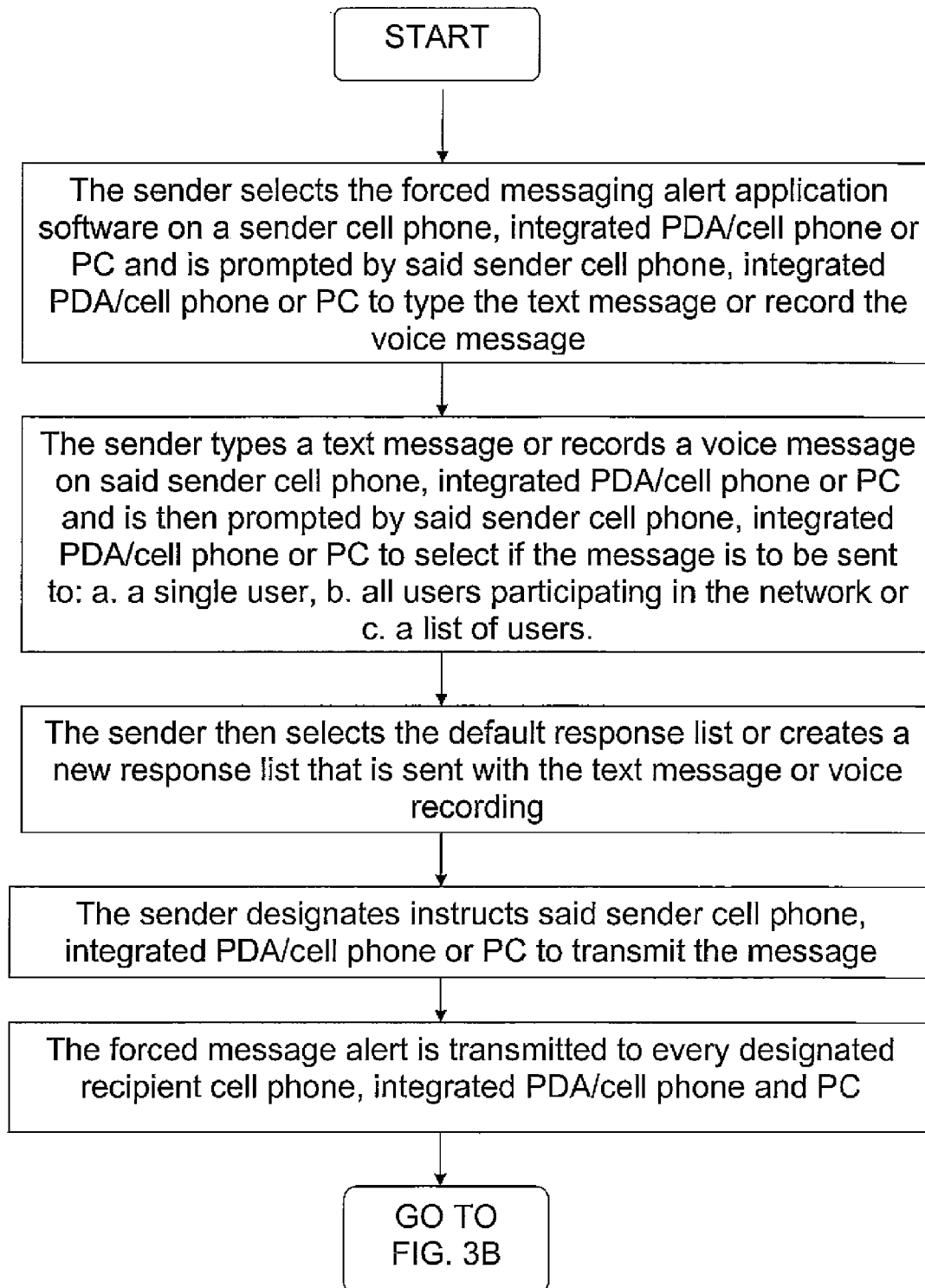
**METHOD OF UTILIZING FORCED ALERTS
FOR INTERACTIVE REMOTE
COMMUNICATIONS**

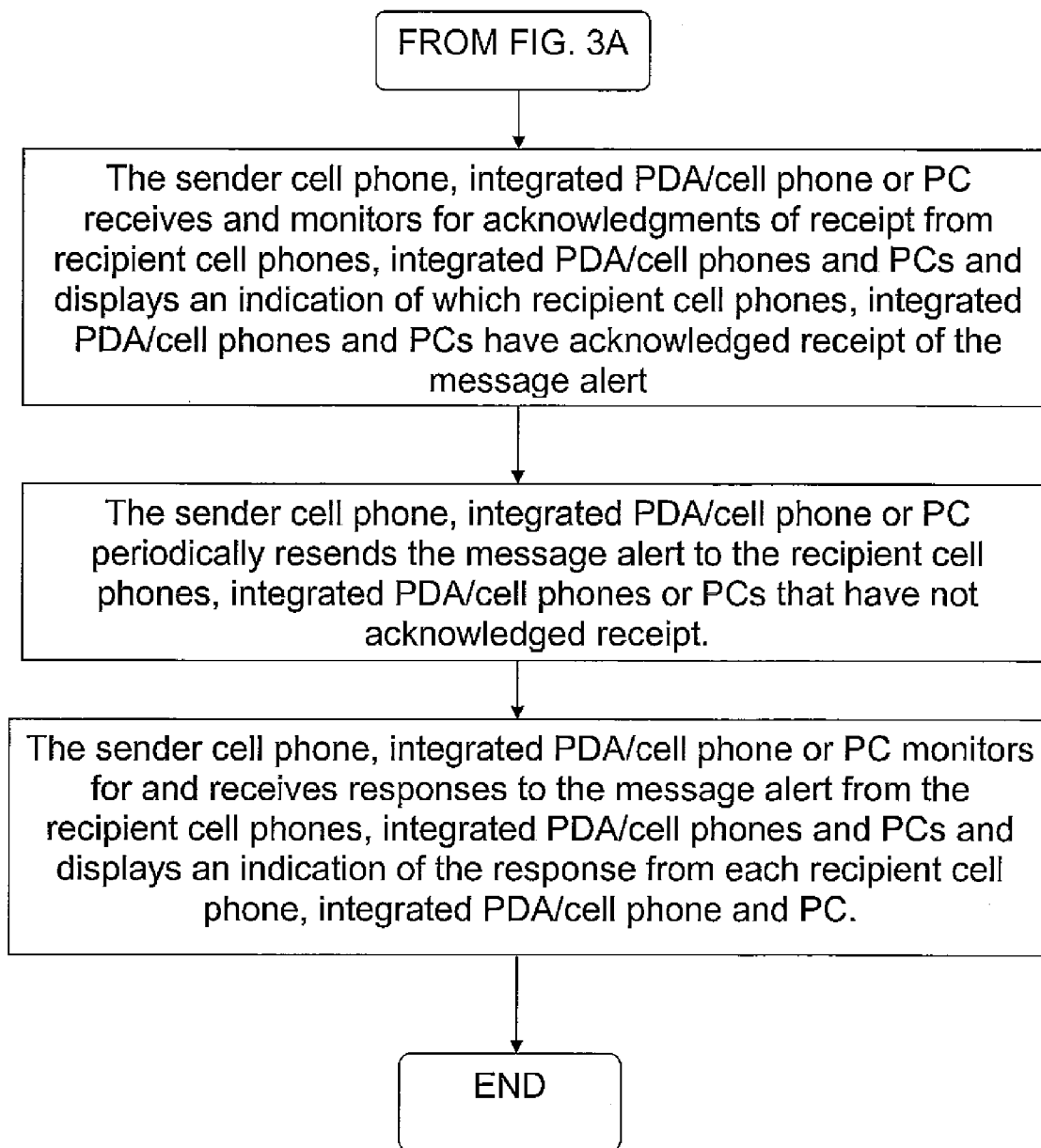
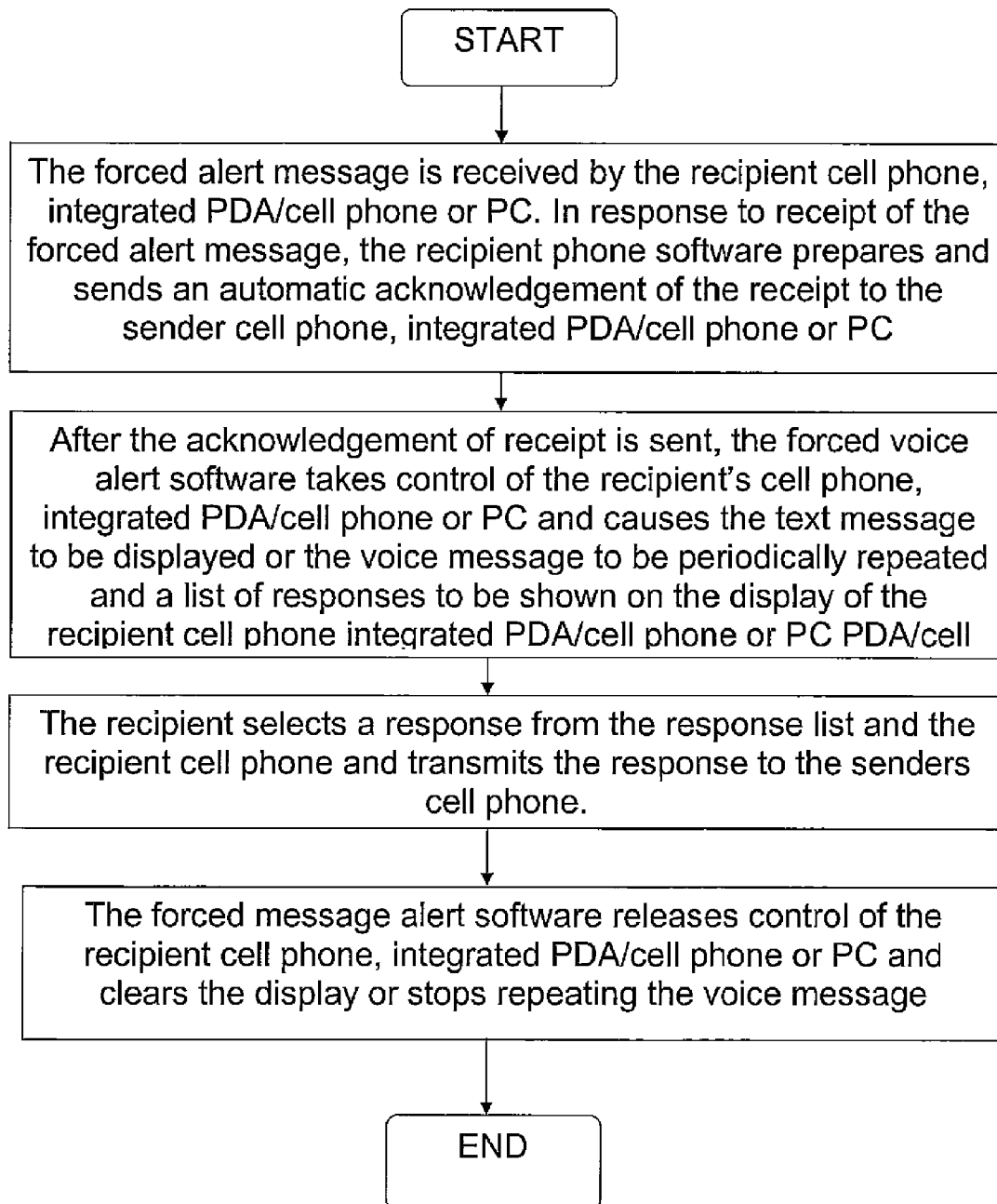
This application is a continuation-in-part of U.S. patent application Ser. No. 11/612,830 filed on Dec. 19, 2006 which is a continuation-in-part of U.S. patent application Ser. No. 11/308,648 filed Apr. 17, 2006 which is a continuation-in-part of U.S. patent application Ser. No. 10/711,490 now U.S. Pat. No. 7,031,728.

BACKGROUND OF THE INVENTION

1. Field of the Invention

A communications system and method that uses a plurality of PCs and PDA/cell phones for the coordination of two or more people through the use of a communications network. The system and method provide each user with a PC or PDA/cell phone that has forced message alert software that enables a user to create and send a voice or text message alert that forces an automatic acknowledgement upon receipt and a manual response from the recipient.

2. Description of Related Art

The purpose of a communications system is to transmit information bearing digital messages from a source, located at one point, to a user destination, located at another point some distance away. A communications system is generally comprised of three basic elements: transmitter, information channel and receiver. One form of communication in recent years is cellular phone telephony. A network of cellular communication systems set up around an area such as the United States allows multiple users to talk to each other, either on individual calls or on group calls, with handheld devices. Some cellular phone services enable a cellular phone to engage in conference calls with a small number of users. Furthermore, cellular conference calls can be established through 800 number services. Cellular telephony also now includes the ability to access local WiFi connections, allowing the devices to utilize cellular phone data transmission technology as well as the data transmission ability of the Internet.

The method and operation of the integrated PDA/cell phones (cell phone/PDA/GPS with touch screen) used herein is described in U.S. Pat. No. 7,031,728, which is hereby incorporated by reference, pending U.S. patent application Ser. No. 11/308,648, and pending U.S. patent application Ser. No. 11/612,830, and are usually discussed herein as a cell phone.

In many situations it is desirable for a user to be able to simultaneously send a message to the cell phones or PCs of a large group of people. This can be typically accomplished using Digital SMS (Smart Message Service) and TCP/IP messages that are transmitted using cellular technology such as the various versions of GSM and CDMA or via a WiFi local area network. However, in some situations it is additionally desirable to know: (a) which people received the message on their cell phone or PC, (b) which people did not receive the message on their cell phone or PC, and (c) the response of each person receiving the message. Digital SMS and TCP/IP messages do not provide each of those functions. As a result, what is needed is a method in which a sender of a text or voice message can force an automatic acknowledgement upon receipt from a recipient's cell phone or PC and a manual response from the recipient via the recipient's cell phone or PC when sending the text or voice message.

2

SUMMARY OF THE INVENTION

Applicant's communication system and method described herein is embodied in the forced alert software developed by applicant and installed in the PCs and PDA/cell phones used herein.

A plurality of PCs and PDA/cell phones each having forced alert software installed providing a communication network of PCs and PDA/cell phones with the ability to: a) allow an operator to create and transmit (via TCP/IP or another digital transmission means) a forced voice alert, wherein said forced voice alert is comprised of a text or voice message file and a forced alert software packet, from a sender PC or PDA/cell phone to one or more recipient PCs and PDA/cell phones within said communication network; (b) automatically transmit an acknowledgement of receipt from said recipient PCs and PDA/cell phones to the sender PCs or PDA/cell phones upon receipt of the forced message alert by the recipient PCs and PDA/cell phones; (c) periodically resend the message to the recipient PCs and PDA/cell phones that have not sent an acknowledgement until an acknowledgement is received from every recipient PC and PDA/cell phone; (d) provide an indication on the display of the sender PC or PDA/cell phone of which recipient PCs and PDA/cell phones have acknowledged the forced message alert; (e) provide a manual response list on the display of the recipient PC and PDA/cell phone's display that can only be cleared by manually selecting and transmitting a response from the list or recording and transmitting a voice response after sending said automatic acknowledgment; and (f) provide an indication on the sender PC or PDA/cell phone of the status the manual response and the content of the manual response from each recipient PCs and PDA/cell phones.

A communication network server can act as a forwarder for TCP/IP communications between any combination of PC users or PDA/cell phone users. The server can also act as a forwarder of data addressed from one participant to one or more addressed participants, thus permitting the transmission of forced text or voice messages, other messages, photographs, video, E-mail and URL data from one network participant to other selected network participants.

The above functions can also be accomplished using WiFi, WiMax or other peer to peer communications. However, for use with cellular communications and to assure the level of security that cell phone companies require, a centralized static IP routable server is used.

It is the object of this invention provide to a method in which by sending a forced text or voice message to a recipient or a group of recipients, a sender can compel an automatic acknowledgement of receipt from each recipient's PC or PDA/cell phone and require a manual response from the recipient via the recipient's cell phone before the message can be cleared.

In accordance with these and other objects which will become apparent hereinafter, the instant invention will now be described with particular reference to the accompanying drawings.

BRIEF DESCRIPTION OF THE DRAWINGS

FIG. 1a shows a front elevational view of an integrated PDA/cell phone having a touch screen that includes forced message alert software described herein.

FIG. 1b shows a flow chart that explains the device shown in FIG. 1a.

3

FIG. 2 shows the installation and set up of the forced message alert software on a communication network of cell phones, integrated PDA/cell phones, and PCs.

FIG. 3A shows the first section of a flow chart showing a process of sending a forced message alert to one or more recipients as well as for ascertaining which recipients received the forced message alert and which recipients responded to the forced message alert.

FIG. 3B shows the second section of a flow chart showing a process of sending a forced message alert to one or more recipients as well as for ascertaining which recipients received the forced message alert and which recipients responded to the forced message alert.

FIG. 4 shows a flow chart showing a process of receiving a forced message alert as well as providing an acknowledgment of receipt and a response by the recipient.

PREFERRED EMBODIMENT OF THE INVENTION

A communication system and method that joins participants in a communications network using personal computers ("PC") and handheld cell phones having integrated personal digital assistant ("PDA/cell phone") with a forced message alert software application program that allows a participant to send a text or voice message to a group of people and force an automatic acknowledgment of receipt and a manual response.

Each PDA/cell phone described herein for the participant network has its own individual on/off power and can function just as any other cell phone. It can also function with its PDA. To operate on the network, obviously the PDA/cell phone power switch has to be on. If the PDA/cell phone is completely turned off, then it is not part of the participating network and cannot send or receive any forced message alerts. In addition to its own on and off power switch, it has the forced message alert software application program that is activated manually when preparing to send a text or voice message or is activated automatically when receiving a forced message alert from another PC or PDA/cell phone.

Each PC described herein is like any other contemporary PC, except that it has the forced message alert software application program installed on it. To operate on the network, obviously the PC must be on and have an active connection to the Internet or other digital transmission means. If the PC is completely turned off, then it is not part of the participating network and cannot send or receive any forced message alerts. The forced message alert software application program on the PC is activated manually when preparing to send a text or voice message or is activated automatically when receiving a forced message alert from another PC or PDA/cell phone.

The communication system also includes a server that acts as a forwarder for IP communications between any combination of PDA/cell phone users and/or PC based users. Network participant location, identity and status messages are sent to the server by each user. The users are the network participants. Network participant entered tracks are also sent to the server. Because this data is of interest to all the network participants, the server forwards the data received from one participant to all other participants, thus providing the information necessary for all network participants to know the identity, location and status of all other network participants. In addition, the server keeps all of the network participants updated on information kept in its databases, such as all of the participants' telephone numbers, E-mail addresses and other information necessary to carry on the communications described herein.

4

The server also acts as a forwarder of data addressed from one participant to one or more addressed participants, thus permitting the transmission of forced message alerts, other text and voice messages, photographs, video, E-mail and URL data from one network participant to other selected network participants.

The above functions can also be accomplished using WiFi, WiMax, or other peer to peer communications. However, for use with cellular communications and to assure the level of security that cell phone companies require, a centralized static IP routable server is used.

Referring now to the drawings and, in particular, FIGS. 1a and 1b, a small handheld cellular phone 10 is shown that includes a PDA integrated in housing 12 that includes an on/off power switch 19, a microphone 38, and an LCD display 16 that is also a touch screen system. The small area 16a is the navigation bar that depicts the telephone, GPS and other status data and the active software. Each cell phone includes a CPU and databases that store information useful in the communication network. With the touch screen 16, data can be entered through the operator using a stylus 14 (or operator finger) by manipulatively directing the stylus 14 to literally touch display 16. Soft switches 16d displayed on the display 16 are likewise activated by using a stylus 14 and physically and manipulatively directing the stylus to literally touch display 16. The display x, y coordinates of the touched point are known by a CPU in the PDA section of the communication system in housing 12 that can coordinate various information contained in the PDA relative to the x, y coordinate position on the display 16. Inside housing 12 is contained the conventional cellular phone elements including a modem, a CPU for use with a PDA and associated circuitry connected to speaker 24 and microphone 38. Conventional PDA/cellular phones are currently on sale and sold as a unit that can be used for cellular telephone calls and sending cellular SMS and TCP/IP or other messages using the PDA's display 16 and CPU. The device 10 includes a pair of cellular phone hardware activating buttons 20 to turn the cellular phone on and 22 to turn the cellular phone off. Navigation pad actuator 18 is similar to a joy or force stick in that the actuator 18 manually provides movement commands that can be used by the PDA's software to move a cursor on display 16. Switches 26 and 28 are designed to quickly select an operator specified network software program. Speaker 24 and microphone 38 are used for audio messages. Switch 19 at the top left of device 10 is the power on and power off switch for the entire device.

The heart of the invention lies in the forced message alert software application program provided in each PC or PDA/cell phone. The forced message alert software application program is activated through use of a screen drawn soft switch or by clicking on an icon on the PC or PDA/cell phone display screen or when a forced message alert transmission is received by another PC or PDA/cell phone. The display 16 is mounted within the housing 12 as part of the PDA and the CPU (not shown). The internal CPU includes databases and software application programs that provide for a geographical map and georeferenced entities that are shown as display portion 16b that includes as part of the display various areas of interest in the particular local map section.

When looking at display 16, the software switches (soft switches) which appear at the very bottom of the display 16d are used to control by touch many of the software driven functions of the PDA/cell phone. The soft switches are activated through the operator's use of the navigation pad 18, or a small track ball, force stick or similar hardware display cursor pointing device. Alternatively, the operator may choose to activate the software switches by touching the

US 8,213,970 B2

5

screen with a stylus **14** (or finger) at the switches' **16d** locations. When some of the software switches are activated, different software switches appear. The bar display **16d** shows the software switches "ZM IN (zoom in)," "ZM OT (zoom out)," "CENT (center)" and "GRAB (pan/grab)" at the bottom of the screen. These software switches enable the operator to perform these functions. The "SWITH (switch)" software switch at the lower right causes a matrix of layered software switches (soft switches) to appear above the bottom row of switches. Through use of the software switches, the operator can also manipulate the geographical map **16b** or chart display. When looking at FIG. **1a**, display symbols depict permanent geographical locations and buildings are shown. For example, the police station is shown and, when the symbol is touched by the stylus or finger, the latitude and longitude of the symbol's location, as shown in display section **16c**, is displayed at the bottom left of the screen. The bottom right side of display **16c** is a multifunction inset area that can contain a variety of information including: a) a list of the communication link participants; b) a list of received messages; a) a map, aerial photograph or satellite image with an indication of the zoom and offset location of the main map display, which is indicated by a square that depicts the area actually displayed in the main geographical screen **16b**; d) applicable status information; and e) a list of the communication net participants. Each participant user would have a device **10** shown in FIGS. **1a** and **1b**.

Also shown on the display screen **16**, specifically the geographical display **16b**, is a pair of different looking symbols **30** and **34**, a small triangle and a small square, which are not labeled. These symbols **30** and **34** can represent communication net participants having cellular phones in the displayed geographical area that are part of the overall cellular phone communications net, each participant having the same device **10** used. The latitude and longitude of symbol **30** is associated within a database with a specific cell phone number and, if available, its IP address and E-mail address. The screen display **16b**, which is a touch screen, provides x and y coordinates of the screen **16b** to the CPU's software from a map in a geographical database. The software has an algorithm that relates the x and y coordinates to latitude and longitude and can access a communications net participant's symbol or a fixed or movable entity's symbol as being the one closest to that point.

In order to initiate a telephone call to the PDA/cell phone user (communication net participant) represented by symbol (triangle) **30** at a specific latitude and longitude displayed on chart **16b**, the operator touches the triangle **30** symbol with the stylus **14**. The operator then touches a "call" software switch from a matrix of displayed soft switches that would overlay the display area **16c**. Immediately, the PDA/cell phone will initiate a cellular telephone call to the PDA/cell phone user at the geographical location shown that represents symbol **30**. A second PDA/cell phone user (communication net participant) is represented by symbol **34** which is a small square (but could be any shape or icon) to represent an individual cellular phone device in the display area. The ring **32** around symbol **30** indicates that the symbol **30** has been touched and that a telephone call can be initiated by touching the soft switch that says "call." When this is done, the telephone call is initiated. Other types of symbolic elements on the display **16** can indicate that a cellular phone call is in effect. Additionally, the operator can touch both symbol **34** and symbol **30** and can activate a conference call between the two cellular phones and users represented by symbols **30** and **34**. Again, a symbolic ring around symbol **34** indicates that a call has been initiated.

6

Equally important, an operator/user with a PDA/cell phone call the police station or any other specific geographical facility displayed on the cell display map, including: buildings, locations of people, vehicles, facilities, restaurants, and the like, whose PDA/cell phone numbers and, if available, E-mail addresses, IP addresses and their URLs are previously stored in the database, by touching a specific facility location on the map display using the stylus **14** and then touching the cellular phone call switch. As an example, the operator/user can touch and point to call a restaurant using a soft switch by touching the restaurant location on the display with a stylus and then touching the call soft switch. The cellular phone will then call the restaurant. Thus, using the present invention, each participant can touch and point to call to one or more other net participants symbolically displayed on the map, each of whom has a device as shown in FIG. **1a** and can also point to call facilities and regular phone numbers that had been previously stored in the phone's database. Furthermore, this symbol hooking and soft switch technique can be used to go to a fixed facility's website or to automatically enter the fixed facility's E-mail address in an e-mail.

Each PDA/cell phone user device is identified on the map display of the other participants users' phone devices by a display symbol that is generated on each user phone display to indicate each user's identity. Each symbol is placed at the correct geographical location on the user display and is correlated with the map on the display. The operator of each PDA/cell phone device may also enter one or more other fixed entities (buildings, facilities, restaurants, police stations, etc.) and geo-referenced events such as fires, accidents, or other events into its database. This information can be likewise transmitted to all the other participants on the communications net. The map, fixed entities, events and PDA/cell phone device communication net participants' latitude and longitude information is related to the "x" and "y" location on the touch screen display map by a mathematical correlation algorithm.

When the PDA/cell phone device user uses a stylus or finger to touch one or more of the symbols or a location displayed on the cellular phone map display, the system's software causes the status and latitude and longitude information concerning that symbol or location to be displayed. In order to hook a symbol or "track" such as another net participant which represents an entity on the geo-referenced map display, or a fixed geographical entity such as a restaurant, police station or a new entity observed by a cell phone user which is discussed below, the operator points at or near the location of a geo-referenced symbol appearing on the PDA/cell phone display that represents a specific track or specific participant or other entity. The hook application software determines that the stylus is pointed close to or at the location of the symbol and puts a circle, square or other indication around the symbol indicating that amplification information concerning the symbol is to be displayed and indicating that additional data or change in data can be made to the indicated symbol. The hook application code then sends a message to the display application code to display the net participant, facility or entity's amplifying data. The display application code retrieves the primary data and amplification data concerning the symbol or entity from the database and displays the information at the correct screen location. The operator can then read the amplification data that relates to that specific symbol at the specific location. The PDA/cell phone operator can also select soft switches on the touch screen display to change the primary data and amplification data. Furthermore, the operator can use a similar method of hooking and selecting to activate particular soft switches to take other actions

US 8,213,970 B2

7

which could include: making cellular phone calls, conference calls, 800 number calls; sending a free text message, operator selected preformatted messages, photographs or videos to the hooked symbol; or to drop a entered symbol.

Each known net participant has a PDA/cell phone number, IP address and, if available, E-mail address that is stored in each participant's device database.

Referring now to FIG. 2, in order to set up a communication network that utilizes the forced message alert system, the forced message alert software application program must be installed on a plurality of PCs and/or PDA/cell phones. The application will provide for a forced alert message that can be designated for transmission according to several criteria: a.) A single PC and/or PDA/cell phone, b.) The list of users currently participating in the network, and c.) A user or administrator predefined list of network participants.

A required response list which will be either preinstalled in the phone application software or sent with the forced message alert will be presented to the user operator upon receipt of the forced message. When the forced text or voice alert is received, the user operator is presented with the required response list. In order to clear the forced text message alert from the user operator's PC or PDA/cell phone display, the user operator is required to select a reply from this list. If the alert is a voice message, the message keeps repeating at a defined rate until the user operator selects from the required response list. A military default response list would typically consist of choices such as, "will comply," "will not comply," and "have complied." However, depending on the nature of the industry in which the users in the communication network are in, this default response list could vary significantly.

The contact and identifying information for each PC and PDA/cell phone that is anticipated to be a member of the communication network and the default response list is loaded on to every member PC and PDA/cell phone in the preferred embodiment. This step makes sure the each user of the communication network has, in addition to the necessary software, the necessary information to send a forced message alert to any and every known member of the communication network. When operating in an open network mode where all that know the password can join the network, the default list is created or expanded as new members join.

Referring now to FIG. 3A and FIG. 3B, the process of sending a forced message alert from a PC or PDA/cell phone begins with a sender selecting the forced message alert software application program on a sender PC or PDA/cell phone. The sender can then select by said sender PC or PDA/cell phone to type a text message or record a voice message or select the text alert or voice alert from a list. Once the sender types a text message or records a voice message or selects a voice or text message on said PC or PDA/cell phone, the sender can then use a soft switch or selection from a list to send the forced alert to: a.) Another network participant, b.) The current PC or PDA/cell phone network participants or c.) A user or administrator predefined list of network participants. The response list from which the message receiver must select can either be included in the forced alert message or be preloaded in each phone. The forced alert message is then transmitted via TCP/IP or other digital transmission means to every PC or PDA/cell phone designated to receive the forced message alert either directly or through a server whose function is to retransmit the messages to the correct users in the communications network.

After the forced message alert is transmitted, the sender PC or PDA/cell phone monitors for and receives electronic transmissions with acknowledgments of receipt from the PCs or PDA/cell phones that have received the forced message alert.

8

Then, the sender PC or PDA/cell phone provides an indication of which of the PC or PDA/cell phone that the forced message alert was sent to have acknowledged receipt and which of the PC or PDA/cell phone that the forced message alert was sent to have not acknowledged receipt on its display. The sender PC or PDA/cell phone will then periodically resend the forced message alert to the PC or PDA/cell phone that have not acknowledged receipt.

The sender PC or PDA/cell phone also monitors for and receives electronic transmissions with manual responses to the forced message alert from the PC or PDA/cell phone that received the message. As these electronic transmissions with manual responses are received, the sender PC or PDA/cell phone displays an indication of the response from each recipient cell phone, integrated PDA/cell phone and PC.

Referring now to FIG. 4, the process of receiving, acknowledging and responding to a forced message alert from the sender PC or PDA/cell phone begins when an electronic transmission is received by a recipient PC or PDA/cell phone. When the electronic transmission is received by the recipient PC or PDA/cell phone, the recipient PC or PDA/cell phone identifies the transmission as a forced message alert and the forced message alert software application program on the recipient PC or PDA/cell phone separates the text or voice message and the forced message alert software packet. Immediately following the detection of the forced message alert, the forced message alert software application program on the recipient PC or PDA/cell phone prepares and electronically transmits an automatic acknowledgement of receipt to the sender PC or PDA/cell phone. However, if the recipient PC or PDA/cell phone is powered off or is not able to receive electronic transmissions, the forced message alert is not received by the recipient PC or PDA/cell phone and no acknowledgement is transmitted. If no acknowledgement is received, the sender PC or PDA/cell phone continues to transmit the forced alert at a predefined rate until acknowledged.

After the acknowledgement of receipt is transmitted, the forced voice alert software application program effectively takes control of the recipient PC or PDA/cell phone. If a text message was received, the forced voice alert software application program causes the text message and the response list to be shown on the display of the recipient PC or PDA/cell phone until a manual response is selected from the response list. Upon selection of the desired response, the forced alert text data is cleared from the recipient PC or PDA/cell phone display. If a voice message was received, the forced voice alert software application program causes the voice message to be periodically repeated using the speakers of the recipient PC or PDA/cell phone while the response list is shown on the display. This voice message cannot be stopped from repeating until one of the entries on the response list is selected.

Once a response is selected or recorded and transmitted to the sender PC or PDA/cell phone, the forced message alert software application program releases effective control of the recipient PC or PDA/cell phone, clears the display, and or stops repeating the voice message and transmits the response to the force alert sender.

The instant invention has been shown and described herein in what is considered to be the most practical and preferred embodiment. It is recognized, however, that departures may be made there from within the scope of the invention and that obvious modifications will occur to a person skilled in the art.

What is claimed is:

1. A communication system for transmitting, receiving, confirming receipt, and responding to an electronic message, comprising:

US 8,213,970 B2

9

a predetermined network of participants, wherein each participant has a similarly equipped PDA/cell phone that includes a CPU and a touch screen display a CPU and memory;

a data transmission means that facilitates the transmission of electronic files between said PDA/cell phones in different locations;

a sender PDA/cell phone and at least one recipient PDA/cell phone for each electronic message;

a forced message alert software application program including a list of required possible responses to be selected by a participant recipient of a forced message response loaded on each participating PDA/cell phone;

means for attaching a forced message alert software packet to a voice or text message creating a forced message alert that is transmitted by said sender PDA/cell phone to the recipient PDA/cell phone, said forced message alert software packet containing a list of possible required responses and requiring the forced message alert software on said recipient PDA/cell phone to transmit an automatic acknowledgment to the sender PDA/cell phone as soon as said forced message alert is received by the recipient PDA/cell phone;

means for requiring a required manual response from the response list by the recipient in order to clear recipient's response list from recipient's cell phone display;

means for receiving and displaying a listing of which recipient PDA/cell phones have automatically acknowledged the forced message alert and which recipient PDA/cell phones have not automatically acknowledged the forced message alert;

means for periodically resending said forced message alert to said recipient PDA/cell phones that have not automatically acknowledged the forced message alert;

and means for receiving and displaying a listing of which recipient PDA/cell phones have transmitted a manual response to said forced message alert and details the response from each recipient PDA/cell phone that responded.

2. The system as in claim 1, wherein the forced message alert software application program on the recipient PDA/cell phone includes:

means for transmitting the acknowledgment of receipt to said sender PDA/cell phone immediately upon receiving a forced message alert from the sender PDA/cell phone;

means for controlling of the recipient PDA/cell phone upon transmitting said automatic acknowledgment and causing, in cases where the force message alert is a text message, the text message and a response list to be shown on the display of the recipient PDA/cell phone or causes, in cases where the forced message alert is a voice message, the voice message being periodically repeated by the speakers of the recipient PDA/cell phone while said response list is shown on the display;

means for allowing a manual response to be manually selected from the response list or manually recorded and transmitting said manual response to the sender PDA/cell phone; and

means for clearing the text message and a response list from the display of the recipient PDA/cell phone or stopping the repeating voice message and clearing the response list from the display of the recipient PDA/cell phone once the manual response is transmitted.

3. The system as in claim 1, wherein said data transmission means is TCP/IP or another communications protocol.

4. The system as in claim 1, wherein the response list that is transmitted within the forced message alert software packet

10

is a default response list that is embedded in the forced message alert software application program.

5. The system as in claim 1, wherein the response list that is transmitted within the forced message alert software packet is a custom response list that is created at the time the specific forced message alert is created on the sender PDA/cell phone.

6. A method of sending a forced message alert to one or more recipient PDA/cell phones within a predetermined communication network, wherein the receipt and response to said forced message alert by each intended recipient PDA/cell phone is tracked, said method comprising the steps of:

accessing a forced message alert software application program on a sender PDA/cell phone;

creating the forced message alert on said sender PDA/cell phone by attaching a voice or text message to a forced message alert application software packet to said voice or text message;

designating one or more recipient PDA/cell phones in the communication network;

electronically transmitting the forced message alert to said recipient PDA/cell phones;

receiving automatic acknowledgements from the recipient PDA/cell phones that received the message and displaying a listing of which recipient PDA/cell phones have acknowledged receipt of the forced message alert and which recipient PDA/cell phones have not acknowledged receipt of the forced message alert;

periodically resending the forced message alert to the recipient PDA/cell phones that have not acknowledged receipt;

receiving responses to the forced message alert from the recipient PDA/cell phones and displaying the response from each recipient PDA/cell phone; and

providing a manual response list on the display of the recipient PDA/cell phone that can only be cleared by the recipient providing a required response from the list;

clearing the recipient's display screen or causing the repeating voice alert to cease upon recipient selecting a response from the response list required that can only be cleared by manually selecting and transmitting a response to the manual response list.

7. The method as in claim 6, wherein each PDA/cell phone within a predetermined communication network is similarly equipped and has the forced message alert software application program loaded on it.

8. The method as in claim 6, wherein said forced message alert application software packet contains a response list, wherein said response list is a default list embedded in the forced message alert software application program.

9. The method as in claim 6, wherein said forced message alert application software packet contains a response list, wherein said response list is a custom response list that is created at the time the specific forced message alert is created on the sender PDA/cell phone.

10. A method of receiving, acknowledging and responding to a forced message alert from a sender PDA/cell phone to a recipient PDA/cell phone, wherein the receipt, acknowledgment, and response to said forced message alert is forced by a forced message alert software application program, said method comprising the steps of:

receiving an electronically transmitted electronic message; identifying said electronic message as a forced message alert, wherein said forced message alert comprises of a voice or text message and a forced message alert application software packet, which triggers the activation of the forced message alert software application program within the recipient PDA/cell phone;

US 8,213,970 B2

11

transmitting an automatic acknowledgment of receipt to the sender PDA/cell phone, which triggers the forced message alert software application program to take control of the recipient PDA/cell phone and show the content of the text message and a required response list on the display recipient PDA/cell phone or to repeat audibly the content of the voice message on the speakers of the recipient PDA/cell phone and show the required response list on the display recipient PDA/cell phone; and
transmitting a selected required response from the response list in order to allow the message required response list to be cleared from the recipient's cell phone display, whether said selected response is a chosen option from the response list, causing the forced message alert software to release control of the recipient PDA/cell phone and stop showing the content of the text message and a response list on the display recipient PDA/cell phone and or stop repeating the content of the voice message on the speakers of the recipient PDA/cell phone;

12

displaying the response received from the PDA cell phone that transmitted the response on the sender of the forced alert PDA/cell phone; and

providing a list of the recipient PDA/cell phones have automatically acknowledged receipt of a forced alert message and their response to the forced alert message.

11. The method as in claim **10**, wherein each PDA/cell phone within a predetermined communication network is similarly equipped and has the forced message alert software application program loaded on it.

12. The method as in claim **10**, wherein said forced message alert application software packet contains a response list, wherein said response list is a default list embedded in the forced message alert software application program.

13. The method as in claim **10**, wherein said forced message alert application software packet contains a response list, wherein said response list is a custom response list that is created at the time the specific forced message alert is created on the sender PDA/cell phone.

* * * * *

Exhibit D



US010299100B2

(12) **United States Patent**
Beyer, Jr. et al.

(10) **Patent No.:** **US 10,299,100 B2**
 (45) **Date of Patent:** **May 21, 2019**

- (54) **METHOD TO PROVIDE AD HOC AND PASSWORD PROTECTED DIGITAL AND VOICE NETWORKS**
- (71) Applicant: **AGIS Software Development LLC**, Marshall, TX (US)
- (72) Inventors: **Malcolm K. Beyer, Jr.**, Jupiter, FL (US); **Christopher R. Rice**, Redmond, WA (US)
- (73) Assignee: **AGIS SOFTWARE DEVELOPMENT LLC**, Marshall, TX (US)

(56) **References Cited**
 U.S. PATENT DOCUMENTS

5,325,310 A 6/1994 Johnson et al.
 5,555,286 A 9/1996 Tendler
 (Continued)

FOREIGN PATENT DOCUMENTS

EP 1148754 A2 10/2001
 EP 1655888 A1 5/2006
 (Continued)

OTHER PUBLICATIONS

Batista, E., "Your Boss May Know Where You Are," Wired News, May 31, 2002; 2pgs.

(*) Notice: Subject to any disclaimer, the term of this patent is extended or adjusted under 35 U.S.C. 154(b) by 0 days.

(21) Appl. No.: **15/722,660**

(22) Filed: **Oct. 2, 2017**

(65) **Prior Publication Data**

US 2018/0027111 A1 Jan. 25, 2018

Related U.S. Application Data

(63) Continuation of application No. 15/469,469, filed on Mar. 24, 2017, which is a continuation of application (Continued)

(51) **Int. Cl.**
H04W 4/90 (2018.01)
H04M 1/725 (2006.01)
 (Continued)

(52) **U.S. Cl.**
 CPC **H04W 4/90** (2018.02); **G01S 19/17** (2013.01); **G06F 3/0482** (2013.01);
 (Continued)

(58) **Field of Classification Search**
 CPC H04W 4/02
 See application file for complete search history.

(Continued)

Primary Examiner — Omoniyi Obayanju
 (74) *Attorney, Agent, or Firm* — Goodwin Procter LLP

(57) **ABSTRACT**

A method and system includes the ability for individuals to set up an ad hoc digital and voice network easily and rapidly to allow users to coordinate their activities by eliminating the need for pre-entry of data into a web or identifying others by name, phone numbers or email. This method is especially useful for police, fire fighters, military, first responders or other emergency situations for coordinating different organizations at the scene of a disaster to elevate conventional communication problems either up and down the chain of command or cross communication between different emergency units. The method and system provides that the users are only required to enter a specific Server IP address and an ad hoc event name, a password and perhaps the name of the particular unit.

31 Claims, 7 Drawing Sheets

ENABLING NON RFID EQUIPPED PDA PHONES TO RECEIVE RFID TAG DATA.

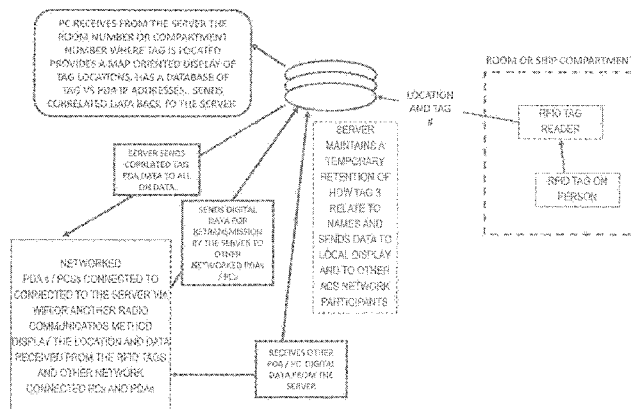

US 10,299,100 B2

Page 2

Related U.S. Application Data

No. 15/287,638, filed on Oct. 6, 2016, now Pat. No. 9,706,381, which is a continuation of application No. 14/529,978, filed on Oct. 31, 2014, now Pat. No. 9,467,838, which is a continuation-in-part of application No. 14/027,410, filed on Sep. 16, 2013, now Pat. No. 8,880,042, which is a continuation of application No. 13/751,453, filed on Jan. 28, 2013, now Pat. No. 8,538,393, which is a continuation-in-part of application No. 12/761,533, filed on Apr. 16, 2010, now Pat. No. 8,364,129, which is a continuation-in-part of application No. 11/615,472, filed on Dec. 22, 2006, now Pat. No. 8,126,441, which is a continuation-in-part of application No. 11/308,648, filed on Apr. 17, 2006, now Pat. No. 7,630,724, which is a continuation-in-part of application No. 10/711,490, filed on Sep. 21, 2004, now Pat. No. 7,031,728.

(51) Int. Cl.

H04W 68/00 (2009.01)
H04W 4/02 (2018.01)
H04W 76/50 (2018.01)
H04W 76/11 (2018.01)
H04M 1/2745 (2006.01)
H04W 4/08 (2009.01)
H04W 64/00 (2009.01)
H04W 84/18 (2009.01)
H04W 12/08 (2009.01)
H04W 12/02 (2009.01)
G06F 3/0482 (2013.01)
G06F 3/0484 (2013.01)
H04L 29/06 (2006.01)
H04L 29/08 (2006.01)
H04W 4/021 (2018.01)
H04L 29/12 (2006.01)
H04M 7/00 (2006.01)
H04W 12/06 (2009.01)
H04W 68/04 (2009.01)
G01S 19/17 (2010.01)
H04M 3/56 (2006.01)
H04W 4/14 (2009.01)
H04W 76/15 (2018.01)
H04W 4/10 (2009.01)
H04W 76/45 (2018.01)
H04W 12/04 (2009.01)
H04W 84/04 (2009.01)

(52) U.S. Cl.

CPC **G06F 3/04842** (2013.01); **H04L 61/605** (2013.01); **H04L 63/065** (2013.01); **H04L 63/083** (2013.01); **H04L 63/104** (2013.01); **H04L 67/18** (2013.01); **H04M 1/27455** (2013.01); **H04M 1/72519** (2013.01); **H04M 1/72536** (2013.01); **H04M 1/72547** (2013.01); **H04M 1/72572** (2013.01); **H04M 1/72583** (2013.01); **H04M 3/56** (2013.01); **H04M 7/006** (2013.01); **H04W 4/02** (2013.01); **H04W 4/021** (2013.01); **H04W 4/023** (2013.01); **H04W 4/026** (2013.01); **H04W 4/027** (2013.01); **H04W 4/08** (2013.01); **H04W 4/14** (2013.01); **H04W 12/02** (2013.01); **H04W 12/06** (2013.01); **H04W 12/08** (2013.01); **H04W 64/00** (2013.01); **H04W 68/00** (2013.01); **H04W 68/04** (2013.01); **H04W 76/11** (2018.02); **H04W 76/15** (2018.02); **H04W 76/50** (2018.02);

H04W 84/18 (2013.01); **H04L 61/2007** (2013.01); **H04M 1/72525** (2013.01); **H04M 2250/10** (2013.01); **H04M 2250/22** (2013.01); **H04M 2250/62** (2013.01); **H04W 4/10** (2013.01); **H04W 12/04** (2013.01); **H04W 76/45** (2018.02); **H04W 84/042** (2013.01)

(56)

References Cited

U.S. PATENT DOCUMENTS

5,563,931 A 10/1996 Bishop et al.
5,692,032 A 11/1997 Seppanen
5,742,905 A 4/1998 Pepe et al.
5,764,898 A 6/1998 Tsuji et al.
5,898,434 A 4/1999 Small et al.
6,104,704 A 8/2000 Buhler et al.
6,108,704 A 8/2000 Hutton
6,119,017 A 9/2000 Cassidy et al.
6,128,291 A 10/2000 Perlman et al.
6,148,332 A 11/2000 Brewer
6,182,114 B1 1/2001 Yap et al.
6,204,844 B1 3/2001 Fumarolo et al.
6,232,971 B1 5/2001 Haynes
6,271,835 B1 8/2001 Hoeksma
6,292,747 B1 9/2001 Amro et al.
6,366,782 B1 4/2002 Fumarolo et al.
6,377,210 B1 4/2002 Moore
6,385,465 B1 5/2002 Yoshioka
6,434,403 B1 8/2002 Ausems et al.
6,459,440 B1 10/2002 Monnes et al.
6,477,387 B1 11/2002 Jackson et al.
6,487,595 B1 11/2002 Turunen et al.
6,490,521 B2 12/2002 Wiener
6,504,503 B1 1/2003 Saint Hilaire et al.
6,518,957 B1 2/2003 Lehtinen et al.
6,542,475 B1 4/2003 Bala et al.
6,549,768 B1 4/2003 Fraccaroli
6,654,683 B2 11/2003 Jin et al.
6,661,353 B1 12/2003 Gopen
6,662,016 B1 12/2003 Buckham et al.
6,665,293 B2 12/2003 Thornton et al.
6,697,734 B1 2/2004 Suomela
6,700,589 B1 3/2004 Canelones et al.
6,704,303 B1 3/2004 Bowman-Amuah
6,716,101 B1 4/2004 Meadows et al.
6,772,142 B1 8/2004 Kelling et al.
6,775,560 B2 8/2004 King et al.
6,816,878 B1 11/2004 Zimmers et al.
6,854,007 B1 2/2005 Hammond
6,867,733 B2 3/2005 Sandhu et al.
6,868,333 B2 3/2005 Melen
6,868,337 B2 3/2005 Muramatsu
6,882,856 B1 4/2005 Alterman et al.
6,885,874 B2 4/2005 Grube et al.
6,941,127 B2 9/2005 Muramatsu
7,002,952 B2 2/2006 Jones
7,024,207 B2 4/2006 Gorday et al.
7,031,700 B1 4/2006 Weaver et al.
7,031,728 B2 4/2006 Beyer, Jr.
7,039,040 B1 5/2006 Burg
7,103,333 B2 9/2006 Lazaridis et al.
7,158,878 B2 1/2007 Rasmussen et al.
7,194,083 B1 3/2007 Tischer et al.
7,219,303 B2 5/2007 Fish
7,271,742 B2 9/2007 Sheha et al.
7,292,935 B2 11/2007 Yoon
7,299,075 B2 11/2007 Gottlieb et al.
7,330,112 B1 2/2008 Emigh et al.
7,353,034 B2 4/2008 Haney
7,386,589 B1 6/2008 Tanumihardja et al.
7,398,551 B2 7/2008 Thomas et al.
7,421,270 B2 9/2008 Serafat et al.
7,426,202 B2 9/2008 Warriar et al.
7,450,003 B2 11/2008 Weber et al.
7,454,233 B2 11/2008 Lu et al.
7,474,627 B2 1/2009 Chheda et al.
7,486,648 B1 2/2009 Baranowski

US 10,299,100 B2

Page 4

(56) **References Cited**

FOREIGN PATENT DOCUMENTS

WO WO-2008027891 A2 3/2008
 WO WO-2008/118878 A2 10/2008

OTHER PUBLICATIONS

Benefon ESC! GSM + GPS Personal Navigation Phone, 1999, Benefon Oyj, Salo, Finland; 4pgs.

Edlund, T. and Ciber, S., "Mobile Services for Truck Drivers," Master Thesis in Mobile Informatics, IT University of Goleborg, Sweden; 2003; 50pgs.

Garmin rino 110 2-way Radio & Personal Navigator; Owner's Manual and Reference Guide; Apr. 2003; 88pgs.

Gate5, "Mobile Community Solution: Context-sensitive Application Suite for Mobile Communities," 2002; 3pgs.

Gate5, "Mobile Guide Solution: Context-sensitive Applications for PDA-based Mobile City and Travel Guides," 2002; 4pgs.

Int'l Preliminary Report on Patentability (IPRP); for Int'l Patent App. No. PCT/JP2004/000250 dated Jul. 5, 2005; 4pgs.

Kim, R., "Find Friends by Cell Phone/Loop! Application's GPS Program can Beam Map Location," SFGate; Nov. 14, 2006; 2pgs. *Life360's Rule 50(a) Motion for Judgment as a Matter of Law; AGIS, Inc. v. Life360, Inc.* (S.D. FL); Mar. 12, 2015; 27pgs.

LocatioNet LBS Applications: MyMap description web page, published before 2004 upon information and belief; 13pgs.

LocatioNet Press Release: "LocatioNet Releases Ground Breaking Mass Market LBS Application Suite—LocatioNet MyMap," Mobile Location Services Congress; May 6, 2003; 2pgs.

Luna, L., "This Man Knows You Live . . . and Work and Play," *Wireless Review*; Sep. 1, 2002; pp. 24-32.

Meggers, J. and Sang-Bum Parl, A., "A Multimedia Communication Architecture for Handheld Devices," IEEE Paper 0-7803-4872-9/98, Sep. 8-11, 1998; pp. 1245-1249.

Memory Map Remote Tracking, available on the Internet at <https://web.archive.org/web/20060202161013/http://memory-map.com/>; 2pgs.

Plaintiff Advanced Ground Information Systems, Inc.'s Motions in *Limine; AGIS, Inc. v. Life360, Inc.* (S.D. FL); Feb. 19, 2015; 54pgs. PRNewswire, "Trimble GPS Technology Enables Seiko Epson; Communication Device and Wireless Data Service," accessed on the internet at: [http://www.printhis.clickability.com/pt/cpt?expire=&title=Trimble+GPS+Technology+Enables+Seiko+Epson+Communication+Device+and+Wireless+Data+S . . .](http://www.printhis.clickability.com/pt/cpt?expire=&title=Trimble+GPS+Technology+Enables+Seiko+Epson+Communication+Device+and+Wireless+Data+S...); downloaded Jun. 16, 2016; 4pgs.

The Gate5 system, which, upon information and belief, was sold and/or publicly used within the U.S. prior to 2004 and at least as early as 2002.

The LocatioNet system which, upon information and belief, was sold and/or publicly used within the U.S. prior to 2004 and at least as early as 2003; 6pgs.

Östman, L., "A Study of Location-Based Services Including a Design and Implementation of an Enhanced Friend Finder Client with Mapping Capabilities," Lulea Tekniska Univeritet; Aug. 31, 2001; 63pgs.

Batayneh, Fahd A., Location Management in Wireless Data Networks. Apr. 21, 2006, 24pgs. Available on the Internet at https://www.cse.wustl.edu/~jain/cse574-06/ftp/wireless_location/index.html.

DIGI, Remote Cellular TCP/IP to Rockwell Ethernet and Serial Devices. 37pgs.

IBM, Transmission Control Protocol / Internet Protocol. 2pgs. Available on the Internet at www.ibm.com/support/knowledgecenter/en/ssw_aix_61/com.ibm.aix.networkcomm/tcpip_intro.htm.

Kutscher, Dirk et al. Drive-thru Internet: IEEE 802.11b for "Automobile" Users. IEEE Infocom, Mar. 7, 2004. 12pgs.

Microsoft Corporation. Communication Services and Networking (Windows CE 5.0). 2006, 6pgs. Available on the Internet at <https://msdn.microsoft.com/en-us/library/ms880996.aspx>.

Ramjee, et al. IP-Based Access Network Infrastructure for Next-Generation Wireless Data Networks. IEEE Personal Communications, Aug. 2000. 8 pgs.

Toppila, Pekka. TCP/IP in Cellular Mobile Environment. 1999, 7pgs.

Zetter, Kim. How Attackers can Use Radio Signals and Mobile Phones to Steal Protected Data. *Wired*, Nov. 3, 2004 5pgs. Available on the Internet at www.wired.com/2014/11/airhopper-hack/.

"911 and E911 Services," Federal Communications Commission, updated Mar. 1, 2018, available at <https://www.fcc.gov/general/9-1-1-and-e9-1-1-services> (last visited May 7, 2018) (6 pages).

"AGIS Introduces Landmark Mobile Networking," dated Jun. 18, 2007, available as of Aug. 7, 2007 according to Wayback Machine Internet Archive Record, obtained from: https://web.archive.org/web/20070807202449/http://www.agisinc.com/AGIS_announcement.pdf (3 pages).

"AGIS Mobile Communication & Collaboration Software Being Used by Naval Coastal Warfare Squadron," available as of Aug. 7, 2007 according to Wayback Machine Internet Archive Record, obtained from: https://web.archive.org/web/20070807202431/http://www.agisinc.com/AGIS_US_Navy_photofeature.pdf (2 pages).

"BuddySpace Downloads," dated May 1, 2007, publication date unknown, available at: <http://projects.kmi.open.ac.uk/buddyspace/downloads/downloads.html> (3 pages).

"Cellular Mobile Pricing Structures and Trends," Organisation for Economic Co-operation and Development, Working Party on Telecommunications and Information Service Policies, May 16, 2000 (103 pages).

"Email," Wikipedia, <https://en.wikipedia.org/wiki/Email> (last visited May 10, 2018) (19 pages).

"Fact Sheet: FCC Wireless 911 Requirements," Federal Communications Commission, Jan. 2001, available at https://transition.fcc.gov/pshs/services/911-services/enhanced911/archives/factsheet_requirements_012001.pdf (4 pages).

"Force XXI Battle Command, Brigade and Below (FBCB2)," available as of Feb. 4, 2017 according to Wayback Machine Internet Archive Record, obtained from: <https://web.archive.org/web/20170204113146/http://www.dote.osd.mil/pub/reports/FY1999/pdf/army/99fbc2.pdf> (4 pages).

"Frequently Asked Questions," BuddySpace.org, available as of Apr. 23, 2007 according to Wayback Machine Internet Archive Record, obtained from: <https://web.archive.org/web/20070423184018/http://kmi.open.ac.uk:80/projects/buddyspace/faq.html> (11 pages).

"Frequently Asked Questions," BuddySpace.org, available as of Feb. 3, 2004 according to Wayback Machine Internet Archive Record, obtained from: <https://web.archive.org/web/20040204032758/http://kmi.open.ac.uk:80/projects/buddyspace/faq.html> (4 pages).

"History of Mobile Phones," Wikipedia, https://en.wikipedia.org/wiki/History_of_Mobile_phones (last visited May 10, 2018) (14 pages).

"How It Works: The Navizon Wireless Positioning System," Navizon.com, available as of Feb. 19, 2006 according to Wayback Machine Internet Archive Record, obtained from: <https://web.archive.org/web/20060219075647/http://www.navizon.com:80/FullFeatures.htm> (8 pages).

"Introduction & Philosophy: Presence in a Nutshell," publication date unknown, available at: <http://projects.kmi.open.ac.uk/buddyspace/intro-philosophy.html> (3 pages).

"MMode Features: Find Friends," AT&T Wireless, available as of Jun. 18, 2003 according to Wayback Machine Internet Archive Record, obtained from: <https://web.archive.org/20030618175223/http://www.attwireless.com:80/mmode/features/findit/FindFriends/> (2 pages).

"Navizon: The first Peer-to-Peer Wireless Positioning System that successfully blends GPS +WiFi + Cellular signals together into one accurate and powerful Mobile Geo-Location System," Navizon.com, available as of Dec. 18, 2005 according to Wayback Machine Internet Archive Record, obtained from: <https://web.archive.org/web/20051218105454/http://www.navizon.com:80/index.htm> (2 pages).

"Palm VII," Wikipedia, https://en.wikipedia.org/wiki/Palm_VII (last visited May 10, 2018) (2 pages).

US 10,299,100 B2

Page 5

(56)

References Cited

OTHER PUBLICATIONS

“Simon Says ‘Here’s How!’ Simon Mobile Communications Made Simple,” Simon Users Manual, IBM Corp., copyright 1994 (41 pages).

“UCSD ActiveCampus,” available as of Feb. 6, 2003 according to Wayback Machine Internet Archive Record, obtained from: <https://web.archive.org/20030206012106/http://activecampus.ucsd.edu/> (3 pages).

“UCSD Active Campus,” available as of Aug. 29, 2004 according to Wayback Machine Internet Archive Record, obtained from: <https://web.archive.org/web/20040829191734/http://activecampus.ucsd.edu/> (3 pages).

“Voice Over Internet Protocol (VoIP),” Federal Communications Commission, publication date unknown, updated at least as recently as May 13, 2009, available at <https://www.fcc.gov/general/voice-over-internet-protocol-voip> (last visited May 10, 2018) (11 pages).

Active Campus, “ActiveCampus—Sustaining Educational Communities through Mobile Technology,” copyright 2002, available as of Nov. 25, 2004 according to Wayback Machine Internet Archive Record, obtained from: <https://web.archive.org/web/20041125060305/http://activecampus.edu/80/slides/active-campus-hpl> (35 pages).

Active Campus, “New Features in Active Campus (Apr. 2003),” available as of Sep. 1, 2006 according to Wayback Machine Internet Archive Record, obtained from: <https://web.archive.org/web/20060901101253/http://activecampus.ucsd.edu/new-features.php> (3 pages).

AGIS, “AGIS First Responders, Mobile Online Group Collaboration,” available as of Jul. 10, 2007 according to Wayback Machine Internet Archive Record, obtained from: <https://web.archive.org/web/20070710230256/http://www.agisinc.com/FirstResponders.asp> (2 pages).

AGIS, “Frequently Asked Questions About AGIS,” available as of Jul. 10, 2007 according to Wayback Machine Internet Archive Record, obtained from: <https://web.archive.org/web/20070710224856/http://www.agisinc.com/Faq.asp> (3 pages).

AGIS, “Mobile Social Networking,” available as of Jul. 10, 2007 according to Wayback Machine Internet Archive Record, obtained from: <http://web.archive.org/web/20070710224939/http://www.agisinc.com/SocialNetworking.asp> (1 page).

AGIS, “Track and Collaborate with Your Entire Team,” available as of Jul. 10, 2007 according to Wayback Machine Internet Archive Record, obtained from: <http://web.archive.org/web/20070710225045/http://www.agisinc.com/Business.asp> (2 pages.).

Apple Newton, Wikipedia, https://en.wikipedia.org/wiki/Apple_Newton (last visited May 10, 2018) (10 pages).

APRS Working Group. “Automatic Position Reporting System: APRS Protocol Reference, Protocol Version 1.0,” Aug. 29, 2000, available at: <http://studylib.net/doc/18674143/aprs-protocol-specification> (128 pages).

Baard, M. “A Connection in Every Spot,” *Wired News*, Oct. 16, 2003, available at: <https://web.archive.org/web/20031127042047/http://www.wired.com:80/news/print/0,1294,60831,00.html> (3 pages).

Bachler, M. et al. “Collaboration in the Semantic Grid: a Basis for e-Learning,” publication date unknown, available at: http://oro.open.ac.uk/6202/1/aai_coacting-2005-preprint-krp.pdf (19 pages).

Bruninga, B. “APRS SPEC Addendum 1.1,” publication date unknown, available at: <http://www.aprs.org/aprs11.html> (4 pages).

Bruninga, B. “APRS Tiny Web Pages,” Sep. 2000, available at: <http://aprs.org/TWP.html> (7 pages).

Bruninga, B. “Automatic Packet/Position Reporting System (APRS),” dated Sep. 18, 2002, available at: <http://aprs.org/APRS-docs/APRS.TXT> (6 pages).

Bruninga, B. “Cellular Automatic Position Reporting System (APRS),” dated Jul. 7, 1999, available as of Jul. 25, 2004 according to Wayback Machine Internet Archive Record, obtained from: <https://web.archive.org/web/20040725024219/http://web.usna.navy.mil:80/~bruninga/APRS-docs/CELLULAR.TXT> (1 page).

Bruninga, B. “Generic Callsigns for National APRS Events,” dated Oct. 20, 2005, available at: <http://aprs.org/aprs-jota.txt> (1 page).

Bruninga, B. “Potential APRS Map of JOTA Contacts,” publication date unknown, obtained from: <http://www.aprs.org/cgsrvr.html> (last visited Nov. 28, 2017) (4 pages).

Bruninga, B. “Tips for Mobile APRS Users,” dated Jan. 2, 2004, available as of Jul. 25, 2004 according to Wayback Machine Internet Archive Record, obtained from: <https://web.archive.org/web/20040725035443/http://web.usna.navy.mil:80/~bruninga/APRS-docs/MOBILE.TXT> (4 Pages).

Bruninga, B. “Touch Screen Display mods in APRStch.EXE,” dated Apr. 17, 2000, available as of Jul. 25, 2004 according to Wayback Machine Internet Archive Record, obtained from: <https://web.archive.org/web/20040725034727/http://web.usna.navy.mil:80/~bruninga/APRS-docs/TOUCH.TXT> (2 pages).

Carter, J. “Build an APRS Encoder Tracker,” *QST*, Feb. 2002 (5 pages).

Charny, B. “Find a Wireless Friend—for a fee,” *Cnet*, Jun. 24, 2002, available at: <https://www.cnet.com/news/find-a-wireless-friend-for-a-fee/> (2 pages).

Charny, B. “New cell feature helps find friends,” *Cnet*, Jun. 25, 2002, available at: <https://www.cnet.com/news/new-cell-feaure-helps-find-friends/> (5 pages).

Chen, Ching-Chen et al. “Automatically and Accurately Conflating Satellite Imagery and Maps,” In Proceedings of the International Workshop on Next Generation Geospatial Information, Oct. 2003 (4 pages).

Christie, Jock et al. “Development and Deployment of GPS Wireless Devices for E911 and Location Based Services,” Position, Location and Navigation Symposium, Palm Springs California, Apr. 15-18, 2002 (6 pages).

Cohen, Deborah. “Digital note-passing gains respect among adults,” *USA Today.com*, Nov. 26, 2004, available at: https://usatoday30.usatoday.com/tech/products/services/2004-11-26-im-gains-cred_x.htm (2 pages).

Conatser, J. et al. “Force XXI Battle Command Brigade and Below-Blue Force Tracking (FBCB2-BFT). A Case Study in the Accelerated Acquisition of a Digital Command and Control System during Operations Enduring Freedom and Iraqi Freedom,” dated Dec. 2005, available at www.dtic.mil/dtic/tr/fulltext/u2/a443273.pdf (73 pages).

Curriculum Vitae of William Griswold, available at: <https://cseweb.ucsd.edu/~wgg/CV.pdf> (29 pages).

Definition of “Subnetting,” *Techopedia*, available at <https://www.techopedia.com/definition/28328/subnetting> as of May 10, 2018 (2 pages).

Dunn, R.J. III. “Blue Force Tracking: The Afghanistan and Iraq Experience and Its Implications for the U.S. Army,” Northrop Grumman, 2003, available at: <http://www.northropgrumman.com/AboutUs/AnalysisCenter/Documents/pdfs/BFT-Afghanistan-and-Iraq-Exper.pdf> (20 pages).

Durso, Fred. “A Decade of Difference,” *NFPA Journal*, Sep. 1, 2011, available at <https://www.nfpa.org/News-and-Research/Publications/NFPA-Journal/2011/September-October-2011/Features/A-Decade-of-Difference> (6 pages).

Eisenstadt, M. et al. “BuddySpace: Enhanced Presence Management for Collaborative Learning, Working, Gaming and Beyond,” submitted to JabberCon Europe 2002, publication date unknown, available at: <https://pdfs.semanticscholar.org/8f3d/d07b4e9f3095b949e78de9a2be439e98e663.pdf> (6 pages).

Grier, Robin. “VoIP—How to Use It to Cut Costs and Enhance Radio Access,” *Radio Resource Magazine*, Jul. 2000 (4 pages).

Griswold, W. et al. “Active Campus—Sustaining Educational Communities through Mobile Technology,” Technical Report CS2002-0714, University of California at San Diego, Jul. 2002, available at: <https://pdfs.semanticscholar.org/2de1/e05b22889171425bca873a66fd9f19ecda0c.pdf> (19 pages).

Griswold, W. et al. “ActiveCampus—Experiments in Community-Oriented Ubiquitous Computing,” University of California at San Diego, published no later than Oct. 2004, available at <https://cseweb.ucsd.edu/~wgg/Abstracts/ac-handhelds.pdf> (8 pages).

Griswold, W. et al. “Using Mobile Technology to Create Opportunistic Interactions on a University Campus,” Technical Report CS2002-0724, University of California at San Diego, Sep. 2002,

US 10,299,100 B2

Page 6

(56)

References Cited

OTHER PUBLICATIONS

available at: <http://citeseerx.ist.psu.edu/viewdoc/download?doi=10.1.1.14.8249&rep=rep1&type=pdf> (6 pages).

Hatfield, Dale N. "A Report on Technical and Operational Issues Impacting the Provision of Wireless Enhanced 911 Services," provided to the Federal Communications Commission on Oct. 15, 2002, (54 pages).

Horzepa, S. "APRS: Moving Hams on Radio and the Internet; A Guide to the Automatic Reporting System," The American Radio Relay League, Inc., copyright 2004 (156 pages).

Horzepa, S. "High-Speed Digital and Multimedia Working Group is on," QST, Jun. 2002 (1 page).

Ion, Florence. "From touch displays to the Surface: A brief history of touchscreen technology," Arstechnica, <https://arstechnica.com/gadgets/2013/04/from-touch-displays-to-the-surface-a-brief-history-of-touchscreen-technology/>, Apr. 4, 2013 (22 pages).

IPR2018-00817, Petition for Inter Partes Review of U.S. Pat. No. 9,445,251, filed on behalf of Apple Inc., Mar. 22, 2018 (85 pages).

IPR2018-00818, Petition for Inter Partes Review of U.S. Pat. No. 9,408,055, filed on behalf of Apple, Inc., Mar. 22, 2018 (86 pages).

IPR2018-00819, Petition for Inter Partes Review of U.S. Pat. No. 9,467,838, filed on behalf of Apple, Inc., Mar. 22, 2018 (91 pages).

IPR2018-00821, Petition for Inter Partes Review of U.S. Pat. No. 8,213,970, filed on behalf of Apple, Inc., Mar. 22, 2018 (85 pages).

IPR2018-01079, Petition for Inter Partes Review of U.S. Pat. No. 8,213,970, filed on behalf of Google, LLC, May 15, 2018 (89 pages).

IPR2018-01080, Petition for Inter Partes Review of U.S. Pat. No. 9,408,055, filed on behalf of Google LLC, May 15, 2018 (87 pages).

IPR2018-01081, Petition for Inter Partes Review of U.S. Pat. No. 9,445,251, filed on behalf of Google, LLC, May 15, 2018 (64 pages).

IPR2018-01082, Petition for Inter Partes Review of U.S. Pat. No. 9,445,251, filed on behalf of Google, LLC, May 15, 2018 (72 pages).

IPR2018-01083, Petition for Inter Partes Review of U.S. Pat. No. 9,445,251, filed on behalf of Google, LLC, May 15, 2018 (72 pages).

IPR2018-01084, Petition for Inter Partes Review of U.S. Pat. No. 9,445,251, filed on behalf of Google, LLC, May 15, 2018 (82 pages).

IPR2018-01085, Petition for Inter Partes Review of U.S. Pat. No. 9,467,838, filed on behalf of Google, LLC, May 15, 2018 (76 pages).

IPR2018-01086, Petition for Inter Partes Review of U.S. Pat. No. 9,467,838, filed on behalf of Google, LLC, May 15, 2018 (82 pages).

IPR2018-01087, Petition for Inter Partes Review of U.S. Pat. No. 9,467,838, filed on behalf of Google, LLC, May 15, 2018 (76 pages).

IPR2018-01088, Petition for Inter Partes Review of U.S. Pat. No. 9,467,838, filed on behalf of Google, LLC, May 15, 2018 (83 pages).

Klabunde, Tim. "The Benefits of a VoIP Dispatch System," Mission Critical Communications, Aug. 2004 (3 pages).

Lehman, J. "APRS and Search and Rescue," QST, Sep. 2003 (3 pages).

Lehman, J. "ARPS and Search and Rescue—Part 2," QST, Oct. 2003 (3 pages).

McKinsey & Company. "Untitled Report," 2002 (133 pages).

Mock, John H. et al. "A voice over IP solution for mobile radio interoperability," In Proceedings of IEEE 56th Vehicular Technology Conference, Sep. 2002 (4 pages).

Perkins, Charles E. "Ad Hoc Networking, An Introduction," Nokia Research Center, Nov. 28, 2000 (28 pages).

Rashbaum, William K. "Report on 9/11 Finds Flaws in Response of Police Dept.," Jul. 27, 2002, available at <https://www.nytimes.com/2002/07/27/nyregion/report-on-9-11-finds-flaws-in-response-of-police-dept.html> (4 pages).

Rotondo, Rick. "Locate—Track—Extract, Wireless Mesh Networking Allows Commanders to Keep Track of Firefighters at an Incident Scene," Public Safety Report, Mar. 2004 (3 pages).

Shareloc's Blog. "In Case You Were Wondering, We've Been Working . . .," Navizon.com, available as of Feb. 20, 2006 according to Wayback Machine Internet Archive Record, obtained from: [https://web.archive.org/web/20060220062317/http://navizon.typepad.com:80/\(7 pages\)](https://web.archive.org/web/20060220062317/http://navizon.typepad.com:80/(7 pages)).

Sharp, Duncan Scott. "Adapting Ad Hoc Network Concepts to Land Mobile Radio Systems," Thesis, Master of Engineering, University of Alberta, copyright Dec. 2002 (98 pages).

Simon, S. "The Pocket PC Goes Tactical," Law Enforcement Technology, May 2006, obtained from: https://web.archive.org/web/20070807202413/http://www.agisinc.com/Eprint_AGIS_4pg.pdf (4 pages).

Subbarao, Madhavi. "Mobile Ad Hoc Data Networks for Emergency Preparedness Telecommunications—Dynamic Power-Conscious Routing Concepts," Wireless Communications Technologies Group, Submitted as an interim project report on Feb. 1, 2000 (16 pages).

The ActiveCampus System, alleged in adverse proceedings to have been made available to the public no later than Oct. 30, 2005 by the University of California San Diego.

The AGIS LifeRing Project and its prototypes, alleged in adverse proceedings to have been made available to the public by Oct. 30, 2005 by AGIS.

The AT&T Find Friends System, alleged in adverse proceedings to have been made available to the public no later than Jun. 24, 2002 by AT&T.

The Automatic Packet/Position Reporting System, alleged in adverse proceedings to have been made available to the public no later than Sep. 21, 2004 by Bob Bruninga.

The BuddySpace system, alleged in adverse proceedings to have been made available to the public at least by Jun. 2002 and no later than Sep. 21, 2004 by the Open University.

The Force XXI Battle Command, Brigade and Below System, alleged in adverse proceedings to have been made available to the public no later than Mar. 21, 2003 by the U.S. Army.

The Navizon System, alleged in adverse proceedings to have been made available to the public at least by Oct. 30, 2005 and no later than Feb. 20, 2006 by Navizon Inc.

Trupiano, Michael. "A Taxonomy for Assessing Fitness of Mobile Data Services in US Consumer Markets," Thesis, Master of Engineering, submitted to Massachusetts Institute of Technology on Feb. 1, 2001 (105 pages).

Vogiazou, Y. et al. "BuddySpace: Large-Scale Presence for Communities at Work and Play," Tech Report KMi-03-14, dated Sep. 2003 (8 pages).

Vogiazou, Y. et al. "From Buddyspace to CitiTag: Large-Scale Symbolic Presence for Community Building and Spontaneous Play," Tech Report KMi-04-25, dated Nov. 2004 (8 pages).

Vriendt, Johan De. et al. "Mobile Network Evolution: A Revolution on the Move," IEEE Communications Magazine, Apr. 2002 (8 pages).

Defendant's Disclosure Pursuant to Patent Local Rule 4-2 of Preliminary Claim Constructions and Extrinsic Evidence, filed in *AGIS Software Development LLC v. Huawei Device USA Inc. et al.* (E.D. Texas), May 18, 2018 (27 pages).

P.R. 4-3—Joint Claim Construction and Prehearing Statement, filed in *AGIS Software Development LLC v. Huawei Device USA, Inc.* on Jun. 15, 2018 (9 pages).

Appendix 1 to P.R. 4-3—Joint Claim Construction and Prehearing Statement—Parties' Proposed Constructions and Supporting Evidence, filed in *AGIS Software Development LLC v. Huawei Device USA, Inc.* on Jun. 15, 2018 (131 pages).

Patent Owner's Preliminary Response, filed in IPR 2018-00817 (*Apple Inc. v. AGIS Software Development LLC*; U.S. Pat. No. 9,445,251), Jul. 5, 2018 (53 pages).

Patent Owner's Preliminary Response, filed in IPR 2018-00818 (*Apple Inc. v. AGIS Software Development LLC*; U.S. Pat. No. 9,408,055), Jul. 5, 2018 (38 pages).

US 10,299,100 B2

Page 7

(56)

References Cited

OTHER PUBLICATIONS

Patent Owner's Preliminary Response, filed in IPR 2018-00821 (*Apple Inc. v. AGIS Software Development LLC*; U.S. Pat. No. 8,213,970), Jul. 24, 2018 (50 pages).

P.R. 4-3—Updated Joint Claim Construction and Prehearing Statement, filed in *AGIS Software Development LLC v. Huawei Device USA, Inc.* on Jul. 23, 2018 (9 pages).

Appendix 1 to P.R. 4-3—Updated Joint Claim Construction and Prehearing Statement—Parties' Proposed Constructions and Supporting Evidence, filed in *AGIS Software Development LLC v. Huawei Device USA, Inc.* on Jul. 23, 2018 (125 pages).

Decision Denying Institution of Inter Partes Review, IPR2018-00817 (*Apple Inc. v. AGIS Software Development LLC*; U.S. Pat. No. 9,445,251), Oct. 3, 2018 (34 pages).

Petitioner's Reply to Patent Owner's Preliminary Response, IPR2018-00817 (*Apple Inc. v. AGIS Software Development LLC*; U.S. Pat. No. 9,445,251), Aug. 10, 2018 (7 pages).

Decision Denying Institution of Inter Partes Review, IPR2018-00818 (*Apple Inc. v. AGIS Software Development LLC*; U.S. Pat. No. 9,408,055), Oct. 3, 2018 (33 pages).

Petitioner's Reply to Patent Owner's Preliminary Response, IPR2018-00818 (*Apple Inc. v. AGIS Software Development LLC*; U.S. Pat. No. 9,408,055), Aug. 10, 2018 (7 pages).

Patent Owner's Preliminary Response, IPR2018-00819 (*Apple Inc. v. AGIS Software Development LLC*; U.S. Pat. No. 9,467,838), Aug. 9, 2018 (51 pages).

Petitioner's Reply to Patent Owner's Preliminary Response, IPR2018-00819 (*Apple Inc. v. AGIS Software Development LLC*; U.S. Pat. No. 9,467,838), Aug. 10, 2018 (7 pages).

Petitioner's Reply to Patent Owner's Preliminary Response, IPR2018-00821 (*Apple Inc. v. AGIS Software Development LLC*; U.S. Pat. No. 8,213,970), Aug. 10, 2018 (7 pages).

Patent Owner's Preliminary Response, IPR2018-01079 (*Google LLC v. AGIS Software Development LLC*; U.S. Pat. No. 8,213,970), Aug. 23, 2018 (59 pages).

Petitioner's Reply to Patent Owner Preliminary Response, IPR2018-01079 (*Google LLC v. AGIS Software Development LLC*; U.S. Pat. No. 8,213,970), Sep. 19, 2018 (8 pages).

Patent Owner's Preliminary Response, IPR2018-01080 (*Google LLC v. AGIS Software Development LLC*; U.S. Pat. No. 9,408,055), Sep. 6, 2018 (41 pages).

Petitioner's Reply to Patent Owner Preliminary Response, IPR2018-01080 (*Google LLC v. AGIS Software Development LLC*; U.S. Pat. No. 9,408,055), Oct. 17, 2018 (9 pages).

Patent Owner's Preliminary Response, IPR2018-01081 (*Google LLC v. AGIS Software Development LLC*; U.S. Pat. No. 9,445,251), Sep. 13, 2018 (43 pages).

Petitioner's Reply to Patent Owner Preliminary Response, IPR2018-01081 (*Google LLC v. AGIS Software Development LLC*; U.S. Pat. No. 9,445,251), Sep. 19, 2018 (9 pages).

Patent Owner's Preliminary Response, IPR2018-01082 (*Google LLC v. AGIS Software Development LLC*; U.S. Pat. No. 9,445,251), Aug. 23, 2018 (38 pages).

Petitioner's Reply to Patent Owner Preliminary Response, IPR2018-01082 (*Google LLC v. AGIS Software Development LLC*; U.S. Pat. No. 9,445,251), Sep. 19, 2018 (9 pages).

Patent Owner's Preliminary Response, IPR2018-01083 (*Google LLC v. AGIS Software Development LLC*; U.S. Pat. No. 9,445,251), Oct. 11, 2018 (42 pages).

Motorola Solutions, Dispatch Console Accessories, 2018 (3 pages).

Patent Owner's Preliminary Response, IPR2018-01084 (*Google LLC v. AGIS Software Development LLC*; U.S. Pat. No. 9,445,251), Oct. 11, 2018 (32 pages).

Patent Owner's Preliminary Response, IPR2018-01085 (*Google LLC v. AGIS Software Development LLC*; U.S. Pat. No. 9,467,838), Aug. 23, 2018 (49 pages).

Petitioner's Reply to Patent Owner Preliminary Response, IPR2018-01084 (*Google LLC v. AGIS Software Development LLC*; U.S. Pat. No. 9,467,838), Sep. 19, 2018 (9 pages).

Patent Owner's Preliminary Response, IPR2018-01086 (*Google LLC v. AGIS Software Development LLC*; U.S. Pat. No. 9,467,838), Sep. 6, 2018 (53 pages).

Petitioner's Reply to Patent Owner Preliminary Response, IPR2018-01086 (*Google LLC v. AGIS Software Development LLC*; U.S. Pat. No. 9,467,838), Oct. 17, 2018 (9 pages).

Patent Owner's Preliminary Response, IPR2018-01087 (*Google LLC v. AGIS Software Development LLC*; U.S. Pat. No. 9,467,838), Oct. 11, 2018 (39 pages).

Patent Owner's Preliminary Response, IPR2018-01088 (*Google LLC v. AGIS Software Development LLC*; U.S. Pat. No. 9,467,838), Sep. 12, 2018 (43 pages).

Petitioner's Reply to Patent Owner Preliminary Response, IPR2018-01088 (*Google LLC v. AGIS Software Development LLC*; U.S. Pat. No. 9,467,838), Oct. 17, 2018 (9 pages).

Defendants' Disclosure Pursuant to Patent Local Rule 4-1 of Proposed Terms and Claim Elements for Construction, filed in *AGIS Software Development LLC v. Huawei Device USA Inc. et al.* (E.D. Texas), Apr. 27, 2018 (16 pages).

Petition for Inter Partes Review of U.S. Pat. No. 9,749,829, IPR-01471, filed on behalf of Apple, Inc., Jul. 31, 2018 (85 pages).

Apple's First Amended Answer to Plaintiff's First Amended Complaint for Patent Infringement, filed in *AGIS Software Development LLC v. Huawei Device USA Inc. et al.* (E.D. Texas), Document 148 in Case 2:17-cv-513, Jun. 15, 2018 (23 pages).

Plaintiff AGIS Software Development LLC's Opening Claim Construction Brief, filed in *AGIS Software Development LLC v. Huawei Device USA Inc. et al.* (E.D. Texas), Document 165 in Case 2:17-cv-513, Jul. 26, 2018 41 pages.

Defendants' Responsive Claim Construction Brief, filed in *AGIS Software Development LLC v. Huawei Device USA Inc. et al.* (E.D. Texas), Document 175 in Case 2:17-cv-513, Aug. 14, 2018 (56 pages).

Plaintiff AGIS Software Development LLC's Reply Claim Construction Brief, filed in *AGIS Software Development LLC v. Huawei Device USA Inc. et al.* (E.D. Texas), Document 186 in Case 2:17-cv-513, Aug. 20, 2018 (29 pages)

Joint Claim Construction Chart Pursuant to P.R. 4-5(D), filed in *AGIS Software Development LLC v. Huawei Device USA Inc. et al.* (E.D. Texas), Document 194 in Case 2:17-cv-513, Aug. 27, 2018 (4 pages)

Declaration of Dr. Jaime G. Carbonell in Support of Plaintiff's Opening Claim Construction Brief; Exhibit H to Plaintiff AGIS Software Development LLC's Opening Claim Construction Brief, filed in *AGIS Software Development LLC v. Huawei Device USA Inc. et al.* (E.D. Texas), Document 165-10 in Case 2:17-cv-513, Jul. 26, 2018 (43 pages)

Declaration of Dr. Benjamin Bederson in Support of Petition for Inter Partes Review of U.S. Pat. No. 8,213,970; Exhibit I to Plaintiff AGIS Software Development LLC's Opening Claim Construction Brief, filed in *AGIS Software Development LLC v. Huawei Device USA Inc. et al.* (E.D. Texas), Case 2:17-cv-513, Jul. 26, 2018 (148 pages)

Declaration of David Hilliard Williams in Support of Petition for Inter Partes Review of U.S. Pat. No. 8,213,970; Exhibit J to Plaintiff AGIS Software Development LLC's Opening Claim Construction Brief, filed in *AGIS Software Development LLC v. Huawei Device USA Inc. et al.* (E.D. Texas), Case 2:17-cv-513, Jul. 26, 2018 (124 pages)

Declaration of Kerri-Ann Limbeed in Support of Defendants' Responsive Claim Construction Brief; Attachment #1 to Defendants' Responsive Claim Construction Brief, filed in *AGIS Software Development LLC v. Huawei Device USA Inc. et al.* (E.D. Texas), Document 175-1 in Case 2:17-cv-513, Aug. 14, 2018 (4 pages)

Oxford American Dictionary of Current English, 1999 (p. 213); Exhibit 3 to Defendants' Responsive Claim Construction Brief, filed in *AGIS Software Development LLC v. Huawei Device USA Inc. et al.* (E.D. Texas), Document 175-4 in Case 2:17-cv-513, Aug. 14, 2018 (5 pages).

Webster's New World Dictionary of Computer Terms, Eighth Edition, 2000 (p. 157); Exhibit 4 to Defendants' Responsive Claim Construction Brief, filed in *AGIS Software Development LLC v.*

US 10,299,100 B2

Page 8

(56)

References Cited

OTHER PUBLICATIONS

Huawei Device USA Inc. et al. (E.D. Texas), Document 175-5 in Case 2:17-cv-513, Aug. 14, 2018 (5 pages)

Microsoft Computer Dictionary, Fifth Edition, 2002 (p. 502); Exhibit 12 to Defendants' Responsive Claim Construction Brief, filed in *AGIS Software Development LLC v. Huawei Device USA Inc. et al.* (E.D. Texas), Document 175-13 in Case 2:17-cv-513, Aug. 14, 2018 (4 pages)

3G TS 23.040 V1 .0.0 (May 1999) Technical Specification (p. 6); Exhibit 20 to Defendants' Responsive Claim Construction Brief, filed in *AGIS Software Development LLC v. Huawei Device USA Inc. et al.* (E.D. Texas), Document 175-21 in Case 2:17-cv-513, Aug. 14, 2018 (4 pages)

Microsoft Computer Dictionary, Fifth Edition, 2002 (p. 479); Exhibit 21 to Defendants' Responsive Claim Construction Brief, filed in *AGIS Software Development LLC v. Huawei Device USA Inc. et al.* (E.D. Texas), Document 175-22 in Case 2:17-cv-513, Aug. 14, 2018 (5 pages)

Declaration of Chris G. Bartone, Ph.D., PE. in Support of Defendants Huawei Device USA Inc. et al.'s Responsive Claim Construction Brief; Attachment #23 to Defendants' Responsive Claim Construction Brief, filed in *AGIS Software Development LLC v. Huawei Device USA Inc. et al.* (E.D. Texas), Document 175-23 in Case 2:17-cv-513, Aug. 14, 2018 (105 pages)

Appendix A: Comparison of Method and "Device" Claims; Attachment #24 to Defendants' Responsive Claim Construction Brief, filed in *AGIS Software Development LLC v. Huawei Device USA Inc. et al.* (E.D. Texas), Document 175-24 in Case 2:17-cv-513, Aug. 14, 2018 (7 pages)

Appendix B: Comparison of '838 Patent Disclosures and Similar Disclosures in '728 Patent; Attachment #25 to Defendants' Responsive Claim Construction Brief, filed in *AGIS Software Development LLC v. Huawei Device USA Inc. et al.* (E.D. Texas), Document 175-25 in Case 2:17-cv-513, Aug. 14, 2018 (3 pages)

HTC Corporation et al.'s PriorArt Listed in Their Invalidity Contentions, *AGIS Software Development LLC v. HTC Corporation et al.* (E.D. Texas), Case 2:17-cv-514, Aug. 30, 2018 (7 pages)

PriorArt Listed in LG Electronics' Invalidity Contentions, *AGIS Software Development LLC v. LG Electronics, Inc. et al.* (E.D. Texas), Case 2:17-cv-514, Aug. 30, 2018 (9 pages)

Index of Exhibits to Apple's Invalidity Contentions, *AGIS Software Development LLC v. LG Electronics, Inc. et al.* (E.D. Texas), Case 2:17-cv-516, Dec. 1, 2017 (11 pages)

Appendix A: Joint Claim Construction Chart; Attachment #1 to Joint Claim Construction Chart Pursuant to P.R. 4-5(D), filed in *AGIS Software Development LLC v. Huawei Device USA Inc. et al.* (E.D. Texas), Document 194 in Case 2:17-cv-513, Aug. 27, 2018 (118 pages)

Declaration of Dr. Benjamin B. Bederson in Support of Petition for Inter Partes Review of U.S. Pat. No. 9,445,251, Exhibit 1002 in IPR2018-00817 (*Apple Inc. v. AGIS Software Development LLC*; U.S. Pat. No. 9,445,251), Mar. 22, 2018 (153 pages).

Exhibit 1010 ("Computer-generated document comparison showing differences in U.S. Appl. No. 11/711,490 and U.S. Appl. No. 11/308,648") in IPR2018-00817, Mar. 22, 2018 (94 pages).

Exhibit 1011 ("Computer-generated document comparison showing differences in U.S. Appl. No. 11/711,490 and U.S. Appl. No. 11/615,472") in IPR2018-00817, Mar. 22, 2018 (122 pages).

Exhibit 1012 ("Computer-generated document comparison showing differences in U.S. Appl. No. 11/615,472 and U.S. Appl. No. 12/761,533") in IPR2018-00817, Mar. 22, 2018 (94 pages).

Exhibit 1017 ("Computer-generated document comparison showing differences in U.S. Appl. No. 14/027,410 and U.S. Appl. No. 11/308,648") in IPR2018-00817, Mar. 22, 2018 (117 pages).

GeoTIFF Format Specification, GeoTIFF Revision 1.0, Specification Version 1.8.1, Oct. 31, 1995 (102 pages); Exhibit 1018 in IPR2018-00817.

Hornbaek, K. et al. Navigation Patterns and Usability of Zoomable User Interfaces with and without an Overview. *ACM Transactions on Computer-Human Interaction*, v. 9, n. 4, Dec. 2002 (pp. 362-369); Exhibit 1019 in IPR2018-00817.

MapInfo. Spatially Enhancing Business Data with Geocoding Solutions: A MapInfo White Paper, 1997 (15 pages); Exhibit 1020 in IPR2018-00817.

MapInfo Professional User's Guide Version 7.0, 2012 (752 pages); Exhibit 1021 in IPR2018-00817.

Python Documentation Release 2.0 Homepage, Oct. 16, 2000 (1 page); Exhibit 1022 in IPR2018-00817.

Python Library Reference, Section 7.2 Socket (4 pages); Exhibit 1023 in IPR2018-00817.

Mockapetris, P. Network Working Group of Internet Engineering Task Force, Request for Comments 1034, Domain Names—Concepts and Facilities, Nov. 1987 (55 pages); Exhibit 1024 in IPR2018-00817.

Claim Construction Order, issued in *Automated Packaging Systems, Inc. v. Free Flow Packaging International, Inc.* (N.D. Cal.), Document 217 in Case 3:18-cv-356, Aug. 2, 2018 (44 pages); Exhibit 1025 in IPR2018-00817.

Declaration of Dr. Benjamin B. Bederson in Support of Petition for Inter Partes Review of U.S. Pat. No. 9,408,055, Exhibit 1002 in IPR2018-00818 (*Apple Inc. v. AGIS Software Development LLC*; U.S. Pat. No. 9,408,055), Mar. 22, 2018 (115 pages).

Declaration of Dr. Benjamin B. Bederson in Support of Petition for Inter Partes Review of U.S. Pat. No. 9,467,838, Exhibit 1002 in IPR2018-00819 (*Apple Inc. v. AGIS Software Development LLC*; U.S. Pat. No. 9,467,838), Mar. 22, 2018 (186 pages).

Apple Computer, Inc. Macintosh Human Interface Guidelines, 1992 (410 pages); Exhibit 1009 in IPR2018-00821 (*Apple Inc. v. AGIS Software Development LLC*; U.S. Pat. No. 8,213,970).

Bederson, Benjamin B. Fisheye Menus. Proceedings of the ACM Symposium on User Interface Software and Technology, 2000 (pp. 217-225); Exhibit 1015 in IPR2018-00821.

Norman, Donald A. The Psychology of Everyday Things, Chapter 1, The Psychopathology of Everyday Things, 1999 (pp. 1-33); Exhibit 1016 in IPR2018-00821.

Nielsen, J. Usability Engineering, 1993 (pp. 129-148); Exhibit 1017 in IPR2018-00821.

Shneiderman, B. Designing the User Interface: Strategies for Effective Human-Computer Interaction, Third Edition, 1998 (252 pages); Exhibit 1018 in IPR2018-00821.

Ball, D. et al. How to Do Everything with Your Treo 600, 2004 (pp. 25-30); Exhibit 1019 in IPR2018-00821.

Exhibit 1020 in IPR2018-00821 ("Redline comparison between the specifications of U.S. Appl. No. 11/612,830 and U.S. Pat. No. 8,213,970"), Mar. 22, 2018 (90 pages).

Declaration of Dr. Benjamin B. Bederson in Support of Petition for Inter Partes Review of U.S. Pat. No. 9,749,829, Exhibit 1002 in IPR2018-01471 (*Apple Inc. v. AGIS Software Development LLC*; U.S. Pat. No. 9,749,829), Jul. 31, 2018 (114 pages).

Declaration of David Hilliard Williams in Support of Petition for Inter Partes Review of U.S. Pat. No. 9,408,055; Exhibit 1003 in IPR2018-01080 (*Google LLC v. AGIS Software Development LLC*; U.S. Pat. No. 9,408,055), May 15, 2018 (138 pages).

Declaration of David Hilliard Williams in Support of Petition for Inter Partes Review of U.S. Pat. No. 9,445,251; Exhibit 1003 in IPR2018-01081 (*Google LLC v. AGIS Software Development LLC*; U.S. Pat. No. 9,445,251), May 15, 2018 (93 pages).

Exhibit 1009 in IPR2018-01081 ("Microsoft Word document compare of specifications between U.S. Pat. No. 7,630,724 to Beyer, Jr. et al. and U.S. Pat. No. 7,031,728 to Beyer, Jr. et al."), May 15, 2018 (33 pages) 10.

Declaration of David Hilliard Williams in Support of Petition for Inter Partes Review of U.S. Pat. No. 9,445,251; Exhibit 1003 in IPR2018-01082 (*Google LLC v. AGIS Software Development LLC*; U.S. Pat. No. 9,445,251), May 15, 2018 (102 pages).

Declaration of David Hilliard Williams in Support of Petition for Inter Partes Review of U.S. Pat. No. 9,445,251; Exhibit 1003 in IPR2018-01083 (*Google LLC v. AGIS Software Development LLC*; U.S. Pat. No. 9,445,251), May 15, 2018 (105 pages).

US 10,299,100 B2

Page 9

(56)

References Cited

OTHER PUBLICATIONS

Declaration of David Hilliard Williams in Support of Petition for Inter Partes Review of U.S. Pat. No. 9,445,251; Exhibit 1003 in IPR2018-01084 (*Google LLC v. AGIS Software Development LLC*; U.S. Pat. No. 9,445,251), May 15, 2018 (116 pages).

Declaration of David Hilliard Williams in Support of Petition for Inter Partes Review of U.S. Pat. No. 9,467,838; Exhibit 1003 in IPR2018-01085 (*Google LLC v. AGIS Software Development LLC*; U.S. Pat. No. 9,467,838), May 15, 2018 (102 pages).

Declaration of David Hilliard Williams in Support of Petition for Inter Partes Review of U.S. Pat. No. 9,467,838; Exhibit 1003 in IPR2018-01086 (*Google LLC v. AGIS Software Development LLC*; U.S. Pat. No. 9,467,838), May 15, 2018 (111 pages).

Declaration of David Hilliard Williams in Support of Petition for Inter Partes Review of U.S. Pat. No. 9,467,838; Exhibit 1003 in IPR2018-01087 (*Google LLC v. AGIS Software Development LLC*; U.S. Pat. No. 9,467,838), May 15, 2018 (106 pages).

Declaration of David Hilliard Williams in Support of Petition for Inter Partes Review of U.S. Pat. No. 9,467,838; Exhibit 1003 in IPR2018-01088 (*Google LLC v. AGIS Software Development LLC*; U.S. Pat. No. 9,467,838), May 15, 2018 (125 pages).

Plaintiff's First Amended Complaint for Patent Infringement, filed in *AGIS Software Development LLC v. Apple, Inc.* (E.D. Texas), Document 32 in Case 2:17-cv-516, Sep. 18, 2017; also Exhibit 1013 in IPR2018-00817 (33 pages).

Exhibit C for U.S. Pat. No. 9,445,251 Against Apple Accused Products; Attachment to Plaintiff's Preliminary Infringement Contentions in *AGIS Software Development LLC v. Apple, Inc.* (E.D. Texas), Case 2:17-cv-516; also Exhibit 1014 in IPR2018-00817, Mar. 22, 2018 (120 pages).

Plaintiff's Original Complaint for Patent Infringement, filed in *AGIS Software Development LLC v. HTC Corp.* (E.D. Texas), Document 1 in Case 2:17-cv-514, Jun. 21, 2017; also Exhibit 1015 in IPR2018-00817 (24 pages).

Plaintiff's Disclosure of Asserted Claims and Infringement Contentions, *AGIS Software Development LLC v. Apple Inc.* (E.D. Texas), Case 2:17-cv-516, Sep. 18, 2017; also Exhibit 1016 in IPR2018-00817 (12 pages).

Exhibit D—Claim Chart for U.S. Pat. No. 9,467,838 Against Apple Accused Products; Attachment to Plaintiff's Preliminary Infringement Contentions in *AGIS Software Development LLC v. Apple, Inc.* (E.D. Texas), Case 2:17-cv-516; also Exhibit in IPR2018-00819, Mar. 22, 2018 (381 pages).

Exhibit A for U.S. Pat. No. 8,213,970 Against Apple Accused Products; Attachment to Plaintiff's Preliminary Infringement Contentions in *AGIS Software Development LLC v. Apple, Inc.* (E.D. Texas), Case 2:17-cv-516, also Exhibit 1008 in IPR2018-00821, Mar. 22, 2018 (39 pages).

Exhibit B for U.S. Pat. No. 9,408,055 Against HUAWEI Accused Products; Attachment to Plaintiff's Infringement Contentions in *AGIS Software Development LLC v. Huawei Device USA Inc., et al.* (E.D. Texas), Case 2:17-cv-513; also Exhibit 1010 in IPR2018-01080, May 15, 2018 (889 pages).

Claim Construction Memorandum and Order, issued in *AGIS Software Development LLC v. Huawei Device USA Inc., et al.* (E.D. Texas), Document 205 in Case 2:17-cv-513, Oct. 10, 2018; also Exhibit 1041 in IPR2018-01080 (60 pages).

Plaintiff's Original Complaint for Patent Infringement, filed in *AGIS Software Development LLC v. Huawei Device USA Inc., et al.* (E.D. Texas), Document 2 in Case 2:17-cv-513, Jun. 21, 2017; also Exhibit 1008 in IPR2018-01081 (24 pages).

Plaintiff's First Amended Complaint for Patent Infringement, filed in *AGIS Software Development LLC v. Huawei Device USA Inc. et al.* (E.D. Texas), Document 32 in Case 2:17-cv-513, Aug. 17, 2017 (26 pages).

Defendants Huawei Device USA Inc. et al.'s Answer to Plaintiff's First Amended Complaint for Patent Infringement, filed in *AGIS Software Development LLC v. Huawei Device USA Inc. et al.* (E.D. Texas), Document 29 in Case 2:17-cv-513, Oct. 5, 2017 (20 pages).

Plaintiff's Original Complaint Infringement, filed in *AGIS Software Development LLC v. LG Electronics, Inc.* (E.D. Texas), Document 1 in Case 2:17-cv-515, Jun. 21, 2017 (24 pages).

Plaintiff's Original Complaint for Patent Infringement, filed in *AGIS Software Development LLC v. Apple, Inc.* (E.D. Texas), Document 1 in Case 2:17-cv-516, Jun. 21, 2017 (26 pages).

Plaintiff's Original Complaint for Patent Infringement, filed in *AGIS Software Development LLC v. ZTE Corp. et al.* (E.D. Texas), Document 1 in Case 2:17-cv-517, Jun. 21, 2017 (25 pages).

Apple's Answer to AGIS's Original Complaint For Patent Infringement, filed in *AGIS Software Development LLC v. Apple Inc.* (E.D. Texas), Document 20 in Case 2:17-cv-516, Aug. 28, 2017 (14 pages).

Apple's Answer to Plaintiff's First Amended Complaint For Patent Infringement, filed in *AGIS Software Development LLC v. Apple Inc.* (E.D. Texas), Document 36 in Case 2:17-cv-516, Oct. 2, 2017 (16 pages).

Plaintiff's First Amended Complaint for Patent Infringement, filed in *AGIS Software Development LLC v. ZTE Corp. et al.* (E.D. Texas), Document 32 in Case 2:17-cv-517, Oct. 17, 2017 (33 pages).

HTC Corporation's Answer, Defenses, and Counterclaims to AGIS Software Development, LLC's Complaint for Patent Infringement, filed in *AGIS Software Development LLC v. HTC Corp. Inc.* (E.D. Texas), Document 82 in Case 2:17-cv-514, Oct. 12, 2018 (19 pages).

Defendant LG Electronics Inc.'s Answer to Plaintiff's Complaint for Patent Infringement, filed in *AGIS Software Development LLC v. LG Electronics, Inc.* (E.D. Texas), Document 83 in Case 2:17-cv-514, Oct. 12, 2018 (22 pages).

Decision: Institution of Inter Partes Review, IPR2018-01079 (*Google LLC v. AGIS Software Development LLC*; U.S. Pat. No. 8,213,970), Nov. 20, 2018 (38 pages).

Decision Denying Institution of Inter Partes Review, IPR2018-01081 (*Google LLC v. AGIS Software Development LLC*; U.S. Pat. No. 9,445,251), Nov. 20, 2018 (38 pages).

Decision Denying Institution of Inter Partes Review, IPR2018-01082 (*Google LLC v. AGIS Software Development LLC*; U.S. Pat. No. 9,445,251), Nov. 20, 2018 (39 pages).

Decision Denying Institution of Inter Partes Review, IPR2018-01085 (*Google LLC v. AGIS Software Development LLC*; U.S. Pat. No. 9,467,838), Nov. 19, 2018 (22 pages).

Patent Owner's Preliminary Response, IPR2018-01471 (*Apple Inc. v. AGIS Software Development LLC*; U.S. Pat. No. 9,749,829), Nov. 28, 2018 (24 pages).

ZTE (USA) Inc., and ZTE (TX), Inc.'s Second Edition of Prior Art References, *AGIS Software Development LLC v. ZTE Corp. et al.* (E.D. Texas), 2:17-cv-514, Aug. 29, 2018 (7 pages).

HTC Corporation's Preliminary Election of Prior Art References, *AGIS Software Development LLC v. Huawei Device USA Inc. et al.* (E.D. Texas), 2:17-cv-514, Apr. 30, 2018 (6 pages).

Defendants Huawei Devices USA Inc. et al.'s Preliminary Election of Prior Art References, *AGIS Software Development LLC v. Huawei Device USA Inc. et al.* (E.D. Texas), 2:17-cv-513, Apr. 30, 2018 (7 pages).

Apple Inc.'s Final Election of Prior Art References, *AGIS Software Development LLC v. Apple Inc.* (E.D. Texas), 2:17-cv-513, Aug. 29, 2018 (15 pages).

Claim Construction Hearing Before the Honorable Chief Judge Rodney Gilstrap (United States District Judge), *AGIS Software Development LLC v. Huawei Device USA Inc. et al.* (E.D. Texas), 2:17-cv-513, Sep. 13, 2018 (109 pages).

Plaintiff's Disclosure of Assorted Claims and Infringement Contentions, *AGIS Software Development LLC v. Huawei Device USA Inc. et al.* (E.D. Texas), 2:17-cv-513, Nov. 28, 2017 (18 pages).

Exhibit A for U.S. Pat. No. 8,213,970 Against Huawei Accused Products; Attachment to Plaintiff's Disclosure of Asserted Claims and Infringement Contentions in *AGIS Software Development LLC v. Huawei Device USA Inc. et al.* (E.D. Texas), Case 2:17-cv-513, Nov. 28, 2017 (36 pages).

Exhibit C for U.S. Pat. No. 9,445,251 Against Huawei Accused Products; Attachment to Plaintiff's Disclosure of Asserted Claims

US 10,299,100 B2

Page 10

(56) References Cited

OTHER PUBLICATIONS

and Infringement Contentions in *AGIS Software Development LLC v. Huawei Device USA Inc. et al.* (E.D. Texas), Case 2:17-cv-513, Nov. 28, 2017 (314 pages).

Exhibit D—Claim Chart for U.S. Pat. No. 9,467,838 Against Huawei; Attachment to Plaintiff's Disclosure of Asserted Claims and Infringement Contentions in *AGIS Software Development LLC v. Huawei Device USA Inc. et al.* (E.D. Texas), Case 2:17-cv-513, Nov. 28, 2017 (312 pages).

Plaintiff's Disclosure of Asserted Claims and Infringement Contentions, *AGIS Software Development LLC v. LG Electronics, Inc.* (E.D. Texas), 2:17-cv-515, Nov. 28, 2017 (16 pages).

Exhibit A for U.S. Pat. No. 8,213,970 Against LG Accused Products; Attachment to Plaintiff's Disclosure of Asserted Claims and Infringement Contentions in *AGIS Software Development LLC v. LG Electronics, Inc.* (E.D. Texas), 2:17-cv-515, Nov. 28, 2017 (36 pages).

Exhibit B for U.S. Pat. No. 9,408,055 Against LG Accused Products; Attachment to Plaintiff's Disclosure of Asserted Claims and Infringement Contentions in *AGIS Software Development LLC v. LG Electronics, Inc.* (E.D. Texas), 2:17-cv-515, Nov. 28, 2017 (902 pages).

Exhibit C for U.S. Pat. No. 9,445,251 Against LG Accused Products; Attachment to Plaintiff's Disclosure of Asserted Claims and Infringement Contentions in *AGIS Software Development LLC v. LG Electronics, Inc.* (E.D. Texas), 2:17-cv-515, Nov. 28, 2017 (335 pages).

Exhibit D—Claim Chart for U.S. Pat. No. 9,467,838 Against LG; Attachment to Plaintiff's Disclosure of Asserted Claims and Infringement Contentions in *AGIS Software Development LLC v. LG Electronics, Inc.* (E.D. Texas), 2:17-cv-515, Nov. 28, 2017 (329 pages).

Plaintiff's Disclosure of Asserted Claims and Infringement Contentions, *AGIS Software Development LLC v. HTC Corp.* (E.D. Texas), 2:17-cv-514, Jan. 19, 2018 (23 pages).

Exhibit A for U.S. Pat. No. 8,213,970 Against HTC Accused Products; Attachment to Plaintiff's Disclosure of Asserted Claims and Infringement Contentions in *AGIS Software Development LLC v. HTC Corp.* (E.D. Texas), 2:17-cv-514, Jan. 19, 2018 (42 pages).

Exhibit B for U.S. Pat. No. 9,408,055 Against HTC Accused Products; Attachment to Plaintiff's Disclosure of Asserted Claims and Infringement Contentions in *AGIS Software Development LLC v. HTC Corp.* (E.D. Texas), 2:17-cv-514, Jan. 19, 2018 (979 pages).

Exhibit C for U.S. Pat. No. 9,445,251 Against HTC Accused Products; Attachment to Plaintiff's Disclosure of Asserted Claims and Infringement Contentions in *AGIS Software Development LLC v. HTC Corp.* (E.D. Texas), 2:17-cv-514, Jan. 19, 2018 (313 pages).

Exhibit D—Claim Chart for U.S. Pat. No. 9,467,838 Against HTC; Accused Products; Attachment to Plaintiff's Disclosure of Asserted Claims and Infringement Contentions in *AGIS Software Development LLC v. HTC Corp.* (E.D. Texas), 2:17-cv-514, Jan. 19, 2018 (329 pages).

Plaintiff's Disclosure of Asserted Claims and Infringement Contentions, *AGIS Software Development LLC v. ZTE Corp et al.* (E.D. Texas), 2:17-cv-517, Jan. 19, 2018 (20 pages).

Exhibit A for U.S. Pat. No. 8,213,970 Against ZTE Accused Products; Attachment to Plaintiff's Disclosure of Asserted Claims and Infringement Contentions in *AGIS Software Development LLC v. ZTE Corp et al.* (E.D. Texas), 2:17-cv-517, Jan. 19, 2018 (41 pages).

Exhibit B for U.S. Pat. No. 9,408,055 Against ZTE Accused Products; Attachment to Plaintiff's Disclosure of Asserted Claims and Infringement Contentions in *AGIS Software Development LLC v. ZTE Corp et al.* (E.D. Texas), 2:17-cv-517, Jan. 19, 2018 (1001 pages).

Exhibit C for U.S. Pat. No. 9,445,251 Against ZTE Accused Products; Attachment to Plaintiff's Disclosure of Asserted Claims and Infringement Contentions in *AGIS Software Development LLC v. ZTE Corp et al.* (E.D. Texas), 2:17-cv-517, Jan. 19, 2018 (314 pages).

Exhibit D—Claims Chart for U.S. Pat. No. 9,467,838 Against ZTE; Accused Products; Attachment to Plaintiff's Disclosure of Asserted Claims and Infringement Contentions in *AGIS Software Development LLC v. ZTE Corp et al.* (E.D. Texas), 2:17-cv-517, Jan. 19, 2018 (329 pages).

Plaintiff's Disclosure of Asserted Claims and Infringement Contentions, *AGIS Software Development LLC v. ZTE Corp. et al.* (E.D. Texas), 2:17-cv-517, Aug. 28, 2018 (21 pages).

Defendant Apple's Amended Patent Rule 3-3 Invalidity Contentions, *AGIS Software Development LLC v. Huawei Device USA Inc. et al.* (E.D. Texas), 2:17-cv-513, Apr. 16, 2018 (49 pages).

Decision: Institution of Inter Partes Review, IPR2018-00819 (*Apple Inc. v. AGIS Software Development LLC*; U.S. Pat. No. 9,467,838), Nov. 7, 2018 (38 pages).

Decision Denying Institution of Inter Partes Review, IRP2018-00821 (*Apple Inc. v. AGIS Software Development LLC*; U.S. Pat. No. 8,213,970), Oct. 23, 2018 (35 pages).

Petitioner's Reply to Patent Owner Preliminary Response, IRP2018-01083 (*Google LLC v. AGIS Software Development LLC*; U.S. Pat. No. 9,445,251), Nov. 1, 2018 (9 pages).

Petitioner's Reply to Patent Owner Preliminary Response, IRP2018-01085 (*Google LLC v. AGIS Software Development LLC*; U.S. Pat. No. 9,467,838), Sep. 19, 2018 (9 pages).

Corrected Petition for Inter Partes Review of U.S. Pat. No. 9,467,838, IPR2018-01087 (*Google LLC v. AGIS Software Development LLC*; U.S. Pat. No. 9,467,838), Oct. 31, 2018 (76 pages).

Exhibit 1031 in IPR2018-01087 (*Google LLC v. AGIS Software Development LLC*; U.S. Pat. No. 9,467,838), Transcript of teleconference between Board and Parties, Oct. 26, 2018 (22 pages).

Exhibit 1032 in IPR2018-01087 (*Google LLC v. AGIS Software Development LLC*; U.S. Pat. No. 9,467,838), Document showing differences between Petition and Corrected Petition in redline, Oct. 31, 2018 (77 pages).

Petitioner's Motion Under 37 C.F.R. § 42.104(C) to Corrected Clerical Errors in the Petition, ISPR2018-01087 9 (*Google LLC v. AGIS Software Development LLC*; U.S. Pat. No. 9,467,838), Oct. 31, 2018 (7 pages).

Petitioner's Reply to Patent Owner Preliminary Response, IPR2018-01087 (*Google LLC v. AGIS Software Development LLC*; U.S. Pat. No. 9,467,838), Nov. 1, 2018 (6 pages).

Patent Owner's Supplemental Preliminary Response to Petition for Inter Partes Review, IPR2018-01087 (*Google LLC v. AGIS Software Development LLC*; U.S. Pat. No. 9,467,838), Nov. 7, 2018 (6 pages).

Corrected Petition for Inter Partes Review of U.S. Pat. No. 9,467,838, IPR2018-01088 (*Google LLC v. AGIS Software Development LLC*; U.S. Pat. No. 9,467,838), Oct. 31, 2018 (83 pages).

Exhibit 1032 in IPR2018-01088 (*Google LLC v. AGIS Software Development LLC*; U.S. Pat. No. 9,467,838), Document showing differences between Petition and Corrected Petition in redline, Oct. 31, 2018 (84 pages).

Petitioner's Motion Under 37 C.F.R. § 42.104(C) to Correct Clerical Errors in the Petition, IPR2018-01088 (*Google LLC v. AGIS Software Development LLC*; U.S. Pat. No. 9,467,838), PCT. 31, 2018 (7 pages).

Patent Owner's Supplemental Preliminary Response to Corrected Petition for Inter Partes Review, IPR2018-01088 (*Google LLC v. AGIS Software Development LLC*; U.S. Pat. No. 9,467,838), Nov. 7, 2018 (6 pages).

Joint Motion to Stay All Deadlines and Notice of Settlement and Regarding Huawei Defendants, filed in *AGIS Software Development LLC v. Huawei Device USA Inc. et al.* (E.D. Texas), Document 221 in Case 2:17-cv-513, Nov. 5, 2018 (6 pages).

Plaintiff/Counterclaim-Defendant AGIS Software Development LLC Answer to Declaratory Judgement Counterclaims of Defendant/Counterclaim-Plaintiff HTC Corporation, filed in *AGIS Software Development LLC v. HTC Corp. et al.* (E.D. Texas), Document 86 in Case 2:17-cv-514, Nov. 2, 2018 (8 pages).

Decision Instituting Inter Partes Review, IPR2018-01080 (*Google LLC v. AGIS Software Development LLC*; U.S. Pat. No. 9,408,055), Dec. 4, 2018 (38 pages).

US 10,299,100 B2

Page 11

(56)

References Cited

OTHER PUBLICATIONS

Decision Denying Institution Inter Partes Review, IPR2018-01086 (*Google LLC v. AGIS Software Development LLC*; U.S. Pat. No. 9,467,838), Dec. 4, 2018 (23 pages).

Decision Denying Institution Inter Partes Review, IPR2018-01088 (*Google LLC v. AGIS Software Development LLC*; U.S. Pat. No. 9,467,838), Dec. 10, 2018 (30 pages).

Exhibit 3001 in IPR2018-01471 (*Apple Inc. v. AGIS Software Development LLC*; U.S. Pat. No. 9,749,829), PTAB Conference Call, Dec. 18, 2018 (26 pages).

Joint Statement of Stipulation Regarding Claim Construction, filed in *AGIS Software Development LLC v. HTC Corp. et al.* (E.D. Texas), Document 91 in Case 2:17-cv-514, Dec. 8, 2018 (5 pages).

Claim Construction Order, filed in *AGIS Software Development LLC v. HTC Corp. et al.* (E.D. Texas), Document 93 in Case 2:17-cv-514, Dec. 18, 2018 (2 pages).

Rebuttal Expert Report of Joseph C. McAlexander III Regarding Validity of U.S. Pat. No. 8,213,970; 9,408,055; 9,445,251; 9,467,838; and 9,749,829, IPR2018-01471 (*Apple Inc. v. AGIS Software Development LLC*; U.S. Pat. No. 9,749,829), Jan. 10, 2019 (400 pages).

Decision Denying Institution of Inter Partes Review, IPR2018-

01083 (*Google LLC v. AGIS Software Development LLC*; U.S. Pat. No. 9,445,251), Jan. 10, 2019 (29 pages).

Decision Denying Institution of Inter Partes Review, IPR2018-01084 (*Google LLC v. AGIS Software Development LLC*; U.S. Pat. No. 9,445,251), Jan. 9, 2019 (27 pages).

Decision Denying Institution of Inter Partes Review, IPR2018-01087 (*Google LLC v. AGIS Software Development LLC*; U.S. Pat. No. 9,467,838), Jan. 9, 2019 (28 pages).

Decision: Institution of Inter Partes Review, IPR2018-01471 (*Apple Inc. v. AGIS Software Development LLC*; U.S. Pat. No. 9,749,829), Feb. 27, 2019 (29 pages).

Order: Conduct of the Proceeding, IPR2018-01471 (*Apple Inc. v. AGIS Software Development LLC*; U.S. Pat. No. 9,749,829), Jan. 3, 2019 (4 pages).

Petitioner's Reply to Patent Owner's Preliminary Response Pursuant to Board's Order (Paper 7), IPR 2018-01471 (*Apple Inc. v. AGIS Software Development LLC*; U.S. Pat. No. 9,749,829), Jan. 10, 2019 (11 pages).

Patent Owner's Sur-Reply to Petitioner's Reply, IPR 2018-01471 (*Apple Inc. v. AGIS Software Development LLC*; U.S. Pat. No. 9,749,829), Jan. 18, 2019 (9 pages).

* cited by examiner

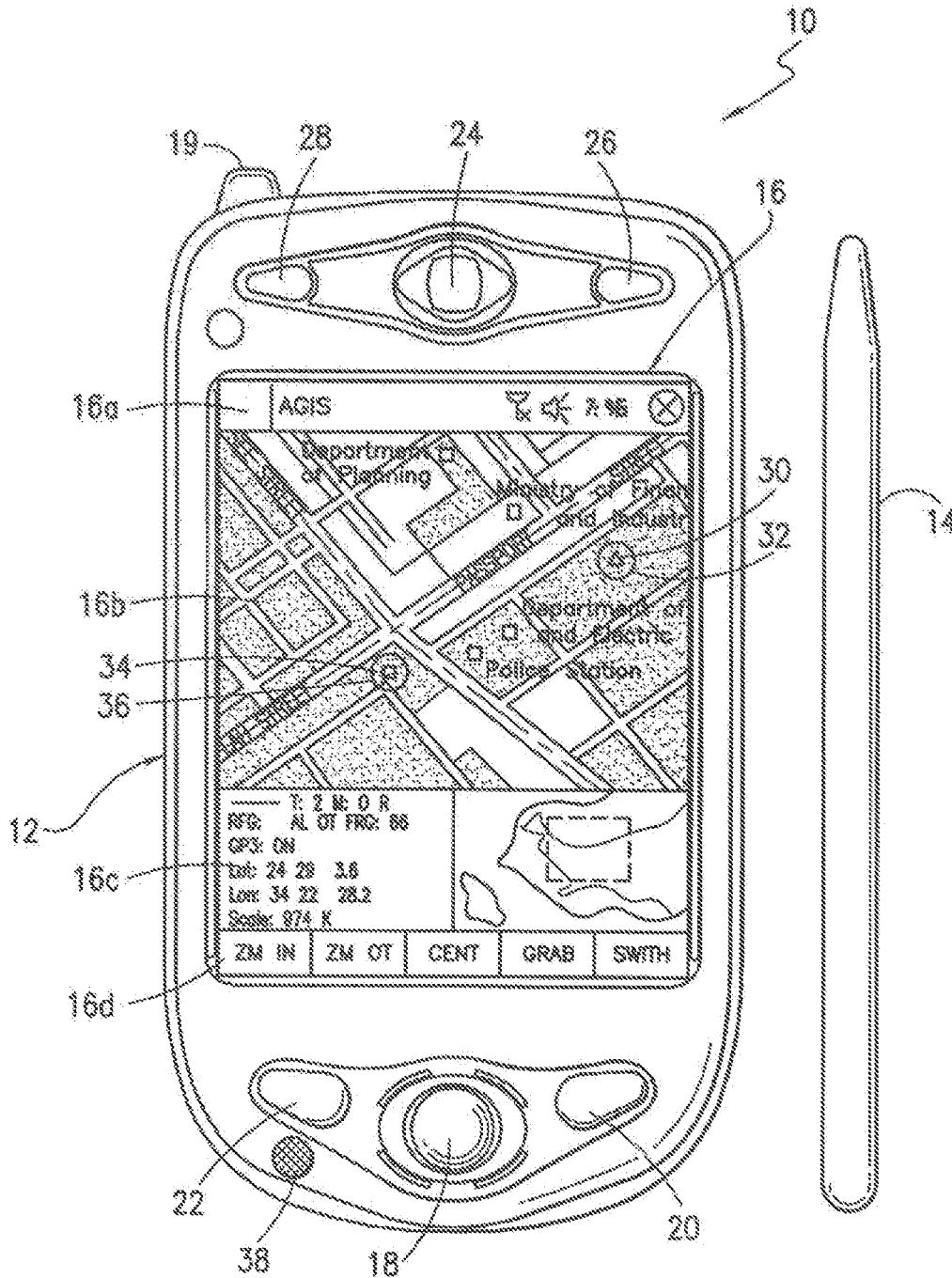

FIG. 1

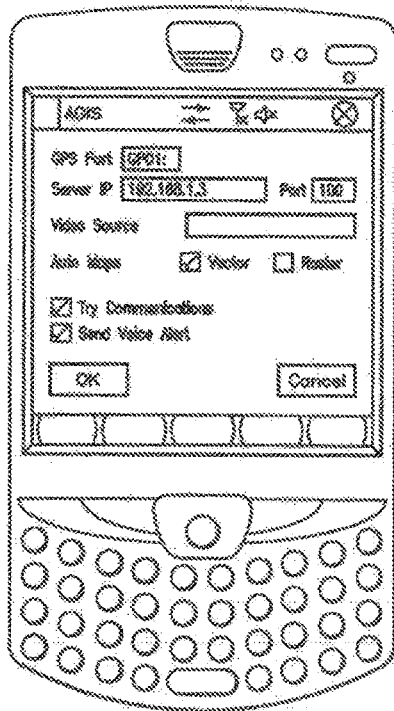

FIG. 2

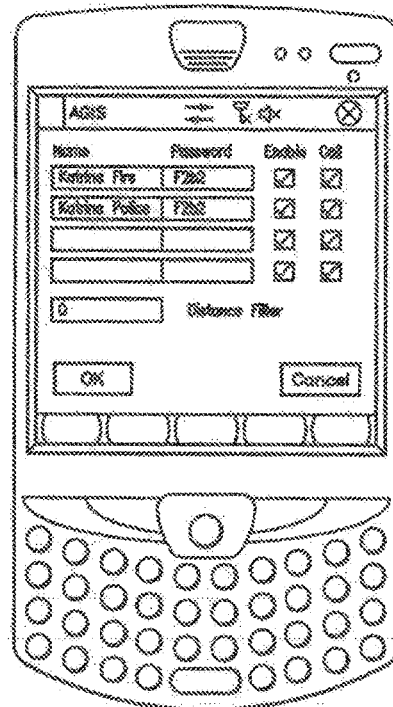

FIG. 3

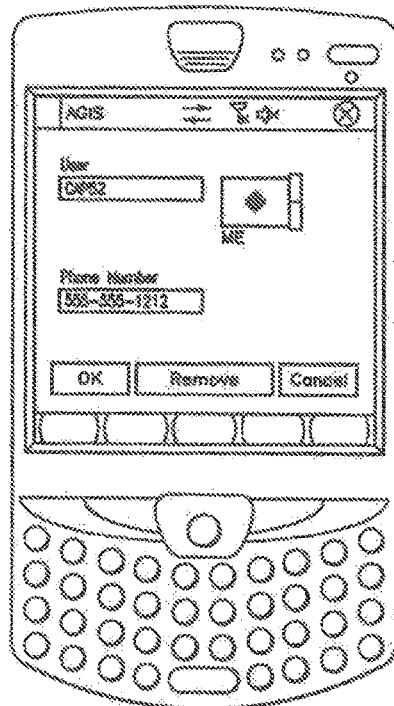

FIG. 4

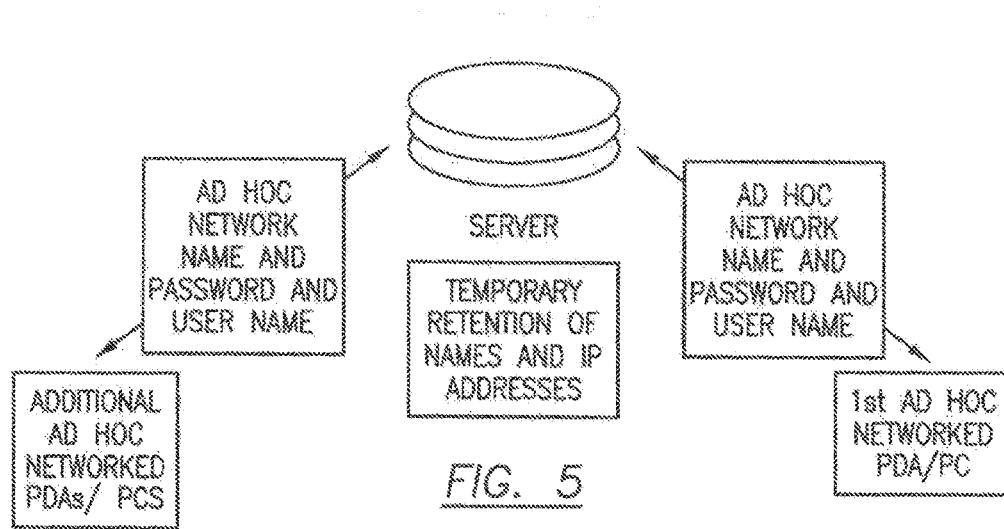
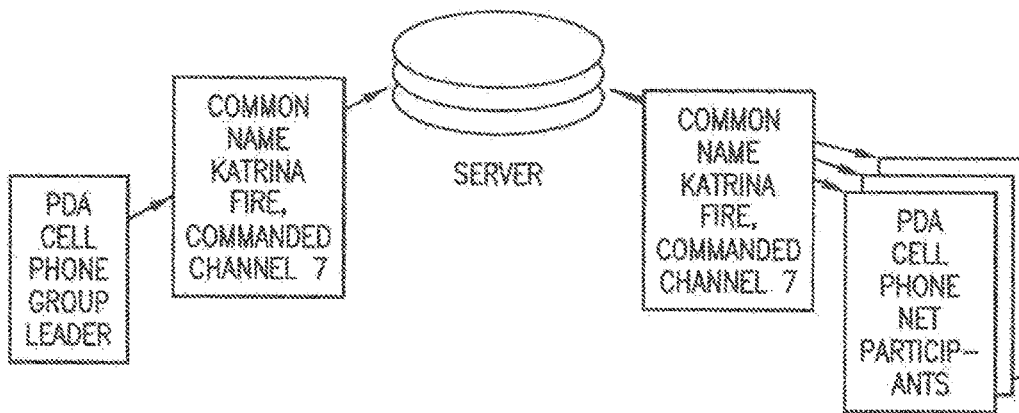

FIG. 5



LEADER SIGNS ON TO THE AD HOC PASSWORD PROTECTED KATRINA FIRE NETWORK AND ENTERS A PTT GROUP CHANNEL.

AS NET PARTICIPANTS SIGN ON TO THE AD HOC PASSWORD PROTECTED KATRINA FIRE NETWORK THEY RECEIVE A PTT GROUP DESIGNATOR. THEIR PDA AUTOMATICALLY USES THE PTT DATA TO SHIFT TO THE COMMANDED VOICE CHANNEL.

FIG. 6

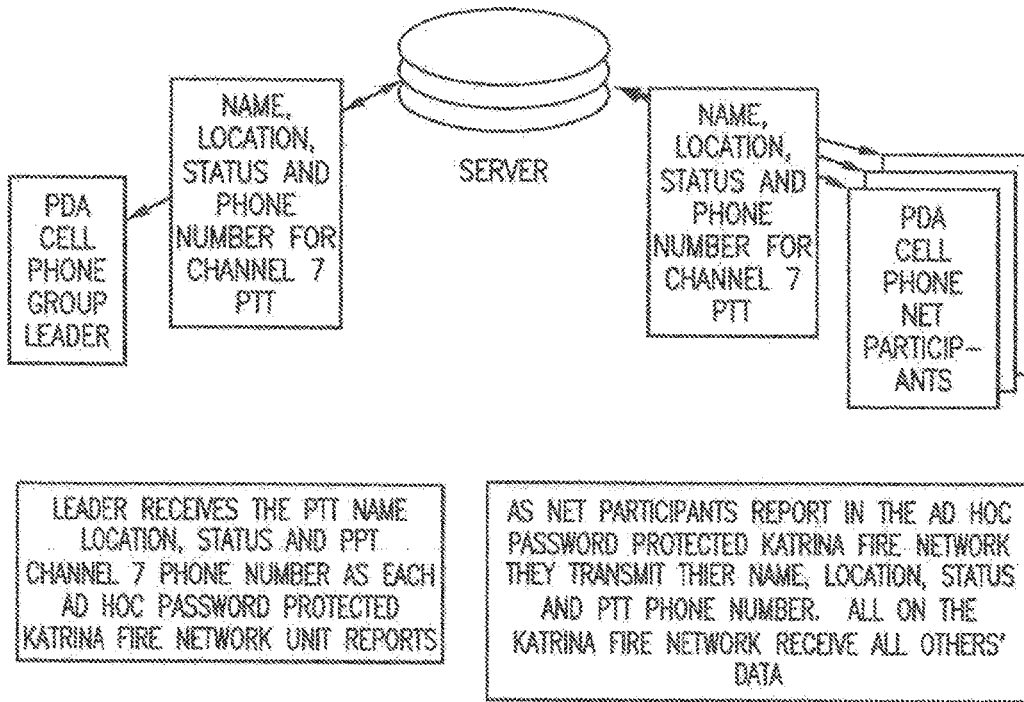

FIG. 7

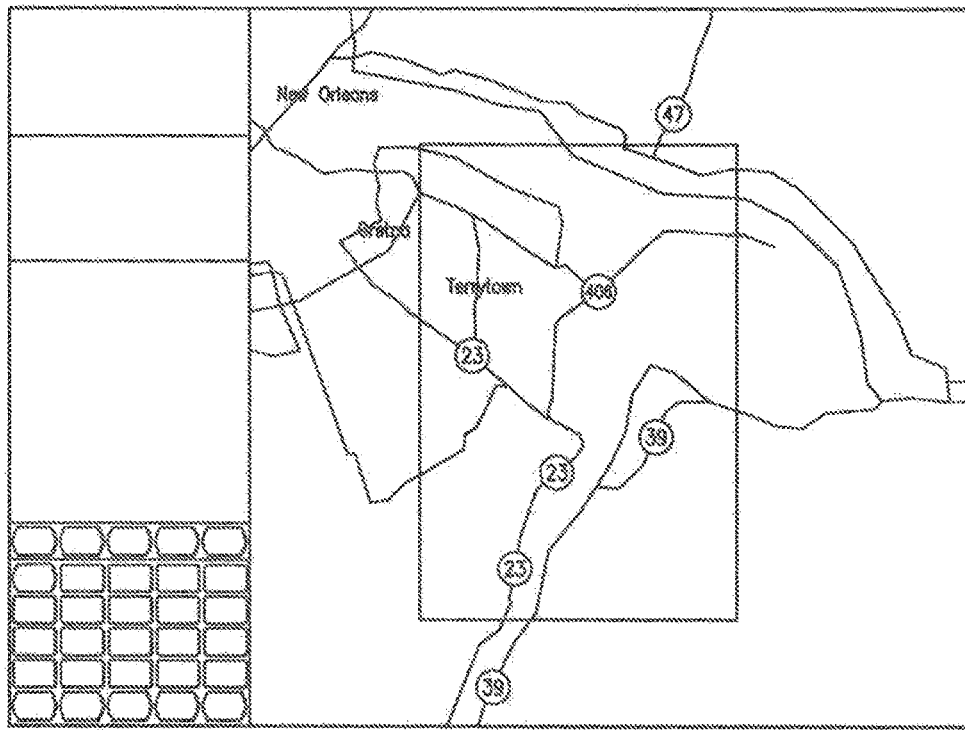

FIG. 8

ENABLING LOCATION, STATUS, VOIP, PTT AND VIDEO COMMUNICATIONS BETWEEN
RADIO AND CELL PHONES

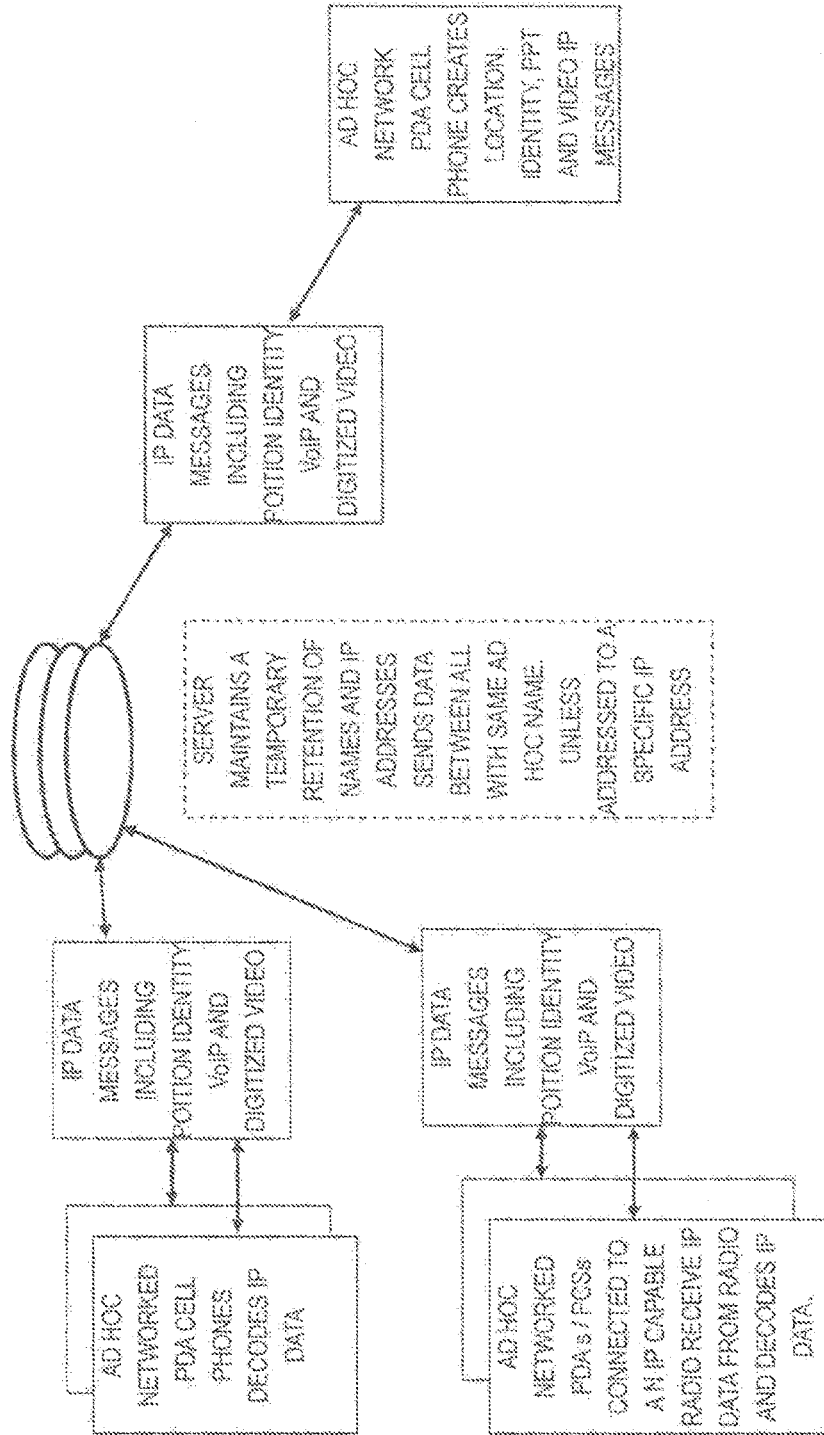

FIG. 9

ENABLING NON RFID EQUIPPED PDA PHONES TO RECEIVE RFID TAG DATA.

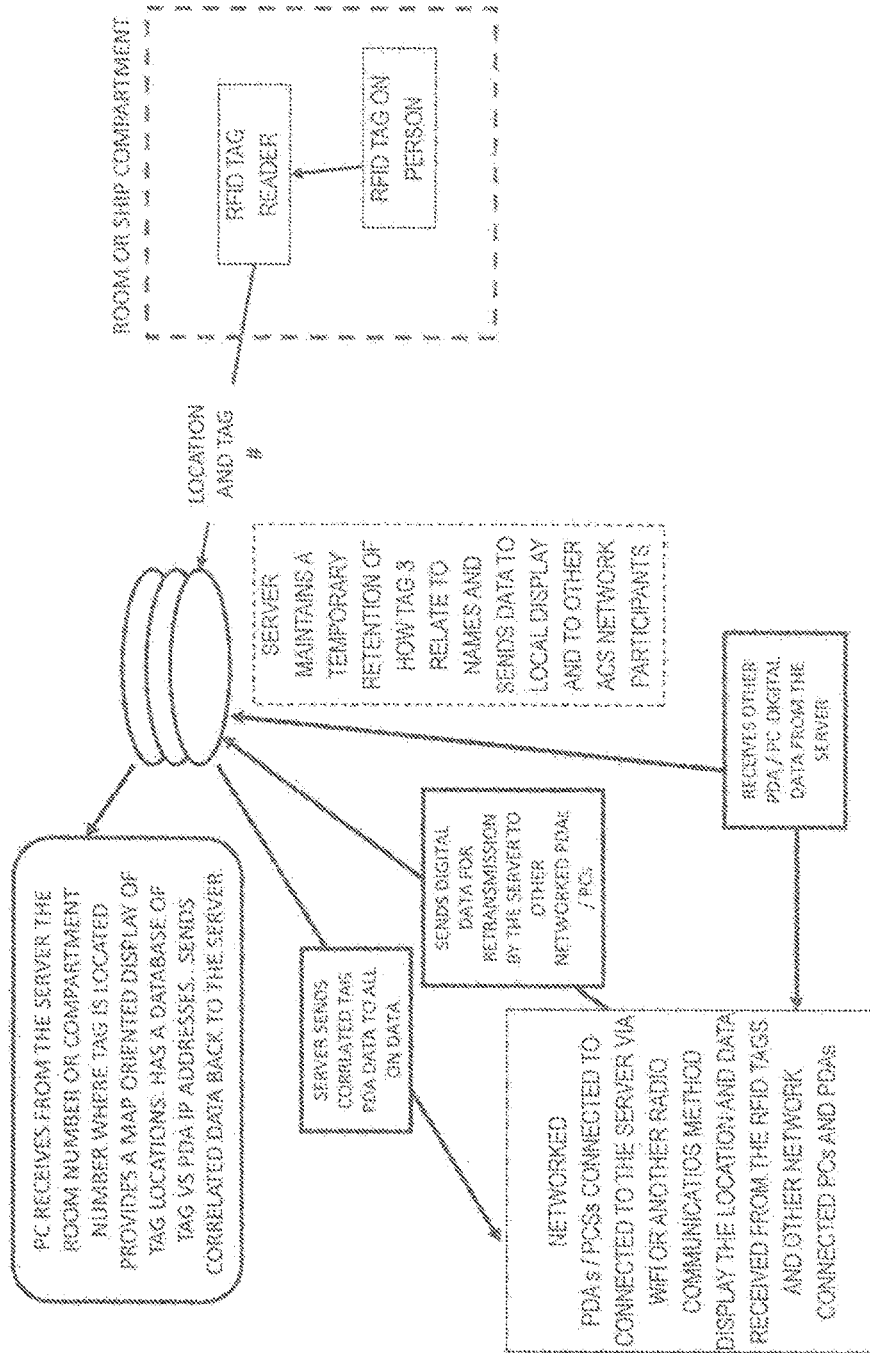

FIG. 10

US 10,299,100 B2

1

**METHOD TO PROVIDE AD HOC AND
PASSWORD PROTECTED DIGITAL AND
VOICE NETWORKS**

CROSS REFERENCE TO RELATED
APPLICATIONS

This application is a continuation of U.S. patent application Ser. No. 15/469,469, on Mar. 24, 2017, which is a continuation of U.S. patent application Ser. No. 15/287,638, on Oct. 6, 2016, now U.S. Pat. No. 9,706,381 issued on Jul. 11, 2017, which is a continuation of U.S. patent application Ser. No. 14/529,978, filed on Oct. 31, 2014, now U.S. Pat. No. 9,467,838 issued Oct. 11, 2016, which is a continuation-in-part of U.S. patent application Ser. No. 14/027,410, filed on Sep. 16, 2013, now U.S. Pat. No. 8,880,042 issued Nov. 4, 2014, which is a continuation of U.S. patent application Ser. No. 13/751,453, filed Jan. 28, 2013, now U.S. Pat. No. 8,538,393 issued Sep. 17, 2013, which is a continuation-in-part of U.S. patent application Ser. No. 12/761,533 filed on Apr. 16, 2010, now U.S. Pat. No. 8,364,129 issued Jan. 29, 2013, which is a continuation-in-part of U.S. patent application Ser. No. 11/615,472 filed on Dec. 22, 2006, now U.S. Pat. No. 8,126,441 issued on Feb. 28, 2012, which is a continuation-in-part of U.S. patent application Ser. No. 11/308,648 filed Apr. 17, 2006, now U.S. Pat. No. 7,630,724 issued on Dec. 8, 2009, which is a continuation-in-part of U.S. patent application Ser. No. 10/711,490, filed on Sep. 21, 2004, now U.S. Pat. No. 7,031,728 issued on Apr. 18, 2006. All of the preceding applications are incorporated herein by reference in their entirety.

BACKGROUND OF THE INVENTION

Field of the Invention

A communications method and system using a plurality of cellular phones each having an integrated Personal Digital Assistant (PDA) and Global Positioning System (GPS) receiver for the management of two or more people through the use of a communications network. The method and system provide each user with an integrated handheld cellular/PDA/GPS/phone that has Advanced Communication Software application programs (hereinafter referred to as ACS) and databases used in conjunction with a remote Server that enable a user to quickly establish a communication network of cell phone participants having a common temporary ad hoc network using mobile wireless communication devices.

The invention includes a method and communication system to quickly set up and provide ad hoc, password protected, digital and voice networks to allow a group of people to be able to set up a network easily and rapidly, especially in an emergency situation.

Description of Related Art

The purpose of a communications system is to transmit digital messages from a source, located at one point, to user destination(s), located at other point(s) some distance away. A communications system is generally comprised of three basic elements: transmitter, information channel and receiver. One form of communication in recent years is cellular phone telephony. A network of cellular communication systems set up around an area such as the United States allows multiple users to talk to each other, either on individual calls or on group calls. Some cellular phone

2

services enable a cellular phone to engage in conference calls with a small number of users. Furthermore, cellular conference calls can be established through 800 number services. Cellular telephony also now includes systems that include GPS navigation that utilizes satellite navigation. These devices thus unite cellular phone technology with navigation information, computer information transmission and receipt of data.

The method and operation of communication devices used herein are described in U.S. Pat. No. 7,031,728 which is hereby incorporated by reference and U.S. Pat. No. 7,630,724.

Military, first responder, and other public and private emergency groups need to be able to set up ad hoc digital and voice networks easily and rapidly. These private networks may be temporary or longer lasting in nature. The users need to be able to rapidly coordinate their activities eliminating the need for pre-entry of data into a web and or identifying others by name, phone numbers or email addresses so that all intended participants that enter the agreed ad hoc network name and password are both digitally and voice interconnected. When a user or users leave the network, no data concerning the network participants need be retained.

Coordinating different organizations at the scene of a disaster presents several problems as there are voice and digital data (text messages) communications that need to be constantly occurring up and down the chain of command. As an example, communications are required from a police chief to a police captain to a police lieutenant to a police sergeant to a policeman and then back up the same chain of command. Digital data exchange of GPS data or other means provides the location component of the units. Digital chat, text messages, white boards and photo video exchange provide extensive collaboration. However, during a disaster, other first responders such as fire departments must become engaged. While the fire department users may have voice and digital data (text messages) communications up and down their chain of command, these individuals do not have the ability to cross communicate necessarily with police units without a substantial degree of immediate coordination. The method and system in accordance with the present invention described herein discloses how digital communications along with Personal Computer (PC) and PDA devices can be used to quickly establish user specific password protected private ad hoc voice and data networks to enable both data and voice communications up and down their chain of command and simultaneously with different, not pre-known, organizations responding to a disaster. The invention defines a method of accomplishing this by providing all personnel that need to communicate with each other with a PC or PDA which are interconnected to a Server using cellular or other communications.

SUMMARY OF THE INVENTION

Applicant's communication system and method described herein is embodied in the Advanced Communication Software (ACS) application programs developed by applicant and installed in the integrated PDA/GPS cell phones used herein and remote Servers.

A plurality of Internet Protocol (IP) capable PDA/GPS devices each having ACS application programs and databases provides a communication network in conjunction with a remote Server that provides the ability to: a) establish an ad hoc network of devices so that the devices can either broadcast to a group or selectively transmit to each of the

US 10,299,100 B2

3

other; each PDA/GPS phone starts by requesting access to the Server and identifying a mutually agreed to network name and password and once granted, reports its GPS position and status; the Server then routes the data to all signed on network participants so that each of the devices exchange location, status and other information; (b) force the received information to the recipient's display and enable the recipient to acquire additional information by touching the display screen at a remote phone's location on the PDA display; (c) make calls to or send data to remote phones by touching their display symbols and selecting the appropriate soft switch; (d) layer a sufficient number of soft switches or buttons on the PDA display to perform the above functions without overlaying the map; and (e) allow a polling mode in each cell phone that permits a user to contact other cell phone users that have a common interest or relationship with a password and identifier for communication and to establish quickly a temporary ad hoc network especially in an emergency.

A communication Server acts as a forwarder for IP communications between any combination of cell phone/PDA users and/or PC based users. Network participant location, identity and status messages are sent to the Server by each user. Network participant entered tracks are also sent to the Server. Because this network participant location and track data is of interest to all the network participants, the Server forwards the data received from one participant to all other participants, causing their displays automatically, without any operator action, to display the received information, thus providing the information necessary for all network participants to know the identity, location and status of all other network participants.

The Server also acts as a forwarder of data addressed from one participant to one or more addressed participants, thus permitting the transmission of free text, preformatted messages, photographs, video, Email and Uniform Resource Locator (URL) data from one network participant to other selected network participants.

The above functions can also be accomplished using peer to peer WiFi, WiMax or other peer to peer communications. However, for use with cellular communications and to assure the level of security that cell phone companies require, a centralized static IP routable Server is used.

The IP Server also fills another role of being a database from which data can be requested by network participants (i.e. maps, satellite images, and the like) or can be pushed to network participants (i.e. symbology and soft switch changes, and the like). The Server is used to establish an ad hoc network within certain groups using an ad hoc event name and password.

This invention provides a method and a system establishing an ad hoc password protected digital and voice network that can be temporarily set up or longer lasting in nature. The invention described herein allows users to rapidly coordinate their activities without having to pre-enter data into a web or identify others by name, E mail addresses or phone numbers. Essentially the users that establish the ad hoc and password protected digital and voice networks are required to enter the Server's IP address and an ad hoc event name and a password. In the case of military and first responders, the name of the user's unit may also be used. This action causes the specific PDA or PC of the user to commence reporting directly to the Server's IP address. Once the Server receives the initial IP message from the user's PDA or PC, the server can commence to exchange data with the user's PDA or PC. The initial IP message may also contain additional data such as a license number and, if desired, a phone number manu-

4

ally entered or automatically acquired by the ACS. The IP address of the PDA and PC unit sending the initial IP message is stored by the Server. The Server then responds with a message notifying the user that his PC/PDA is connected to the Server. The user PDA/PC then reports its GPS location and other status information directly to the Server. This information is retained by the Server even when there are no other devices initially communicating with the Server. When the other user's devices sign on to the Server with the same ad hoc event name and password, the Server software then recognizes all the users and stores their IP addresses in the Server. Thus the Server has all the users IP addresses stored and can pass location and status information among the ad hoc network participants even though the network participants have not entered other network participants' names, phone numbers or email addresses. Thus one of the purposes of the invention is to allow an ad hoc network to be formed on a temporary basis in a rapid manner.

When using the PTT feature, the ACS can enable the network participant to: 1. PTT with all that are in the ad hoc digital network, or 2. PTT with select specific network participants, by touching their symbols) and then selecting PTT soft switch or 3. Specify a group of the network participants by assigning their symbols or unit names to a list of network participants and then associating the list with a soft switch whose function is to enable the operator to have PTT communications with all in the list.

Since only one person is transmitting on a PTT voice network at any given time, the receiving network participant's ACS can relate the PTT IP address to the IP address of the unit transmitting his identification on the digital ad hoc network. This information can then be used by the other PTT networked participant's ACS to: 1. flash the transmitting unit's name on their PDA/PC screens or 2. if a photograph has been attached to the ad hoc digital network symbol of the PTT transmitting person, to flash that photograph on the receiving unit's PDA/PC display.

It is an object of this invention to enable each participant in the communication network to join other ad hoc network participants to form an ad hoc digital and voice network with other cell phone users rapidly for coordinating member activities.

In accordance with these and other objects which will become apparent hereinafter, the instant invention will now be described with particular reference to the accompanying drawings.

BRIEF DESCRIPTION OF THE DRAWINGS

FIG. 1 shows a front plan view of a cellular phone/PDA/GPS having a touch screen.

FIG. 2 shows the screen IP address entry menu.

FIG. 3 shows ad hoc net names and password screen entry name.

FIG. 4 shows a screen entry identifying user.

FIG. 5 shows a flow chart of the network as users sign on to the network.

FIG. 6 shows a flow chart that depicts how a group commander can command networked PDAs/PCS and radios to load a Push To Talk (PTT) channel.

FIG. 7 shows a flow chart that depicts how networked radio units respond to receipt of the Push-to-Talk (PTT) Commanded Channel.

FIG. 8 shows a PDA screen geographical display that represents the area covered by the network.

US 10,299,100 B2

5

FIG. 9 shows a diagram that enables determining location, status, ViOP, PTT, and video communication between adios and cell phones.

FIG. 10 shows a diagram that describes enabling non RFID equipped PDA phones to receive RFID tag data.

PREFERRED EMBODIMENT OF THE INVENTION

A method and communication system that joins a communications network of participants using handheld cell phones having integrated PDA and GPS circuitry with ACS application programs that allow a participant having an ACS equipped cell phone to provide an ad hoc and password protected digital and voice network.

A communication Server acts as a forwarder for IP communications between any combination of cell phone/PDA users and/or PC based user. Network participant location, identity and status messages are sent to the Server by each user. Network participant entered tracks are also sent to the Server. Because this data is of interest to all the network participants, the Server forwards the data received from one participant to all other participants, thus providing the information necessary for all network participants to know the identity, location and status of all other network participants.

The Server allows the set up of the ad hoc network with an ad hoc event name and a password.

The Server also acts as a forwarder of data addressed from one participant to one or more addressed participants, thus permitting the transmission of free text, preformatted messages, photographs, video, email and URL data from one network participant to other selected network participants.

Referring now to the drawings and, in particular, to FIG. 1, a small handheld cellular phone 10 is shown that includes a PDA and a GPS communications device integrated in housing 12 that includes an on/off power switch 19, a microphone 38, and a Liquid Crystal Display (LCD) display 16 that is also a touch screen system. The small area 16a is the navigation bar that depicts the telephone, GPS and other status data and the active software. Each cell phone includes a Central Processing Unit (CPU) and databases that store information useful in the communication network. The CPU also includes a symbol generator for creating touch screen display symbols discussed herein. With the touch screen 16, the screen symbols are entered through GPS inputs or by the operator using a stylus 14 (or operator finger) by manipulatively directing the stylus 14 to literally touch display 16. The soft switches 16d displayed on the display 16 are likewise activated by using a stylus 14 and physically and manipulatively directing the stylus to literally touch display 16. The display x, y coordinates of the touched point are known by a CPU in the PDA section of the communication system in housing 12 that can coordinate various information contained in the PDA relative to the x, y coordinate position on the display 16. Inside housing 12 is contained the conventional cellular phone elements including a modem, a CPU for use with a PDA and associated circuitry connected to speaker 24 and microphone 38. A GPS navigational receiver that receives signals from satellites that can determine the latitude and longitude of the cellular phone housing 12 can be internal or external to the housing 12. Conventional PDA/cellular phones are currently on sale and sold as a unit (or with an external connected GPS) that can be used for cellular telephone calls and sending cellular Short Message Service (SMS) and Transmission Control Protocol (TCP) TCP/IP or other messages using the FDA's display 16 and computer CPU. The GPS system including a receiver in

6

housing 12 is capable of determining the latitude and longitude and through SMS, TCP/IP, WiFi or other digital messaging software, to also transmit this latitude and longitude information of housing 12 to other cellular phones in the communication network via cellular communications, WiFi or radio. The device 10 includes a pair of cellular phone hardware activating buttons 20 to turn the cellular phone on and 22 to turn the cellular phone off. Navigation pad actuator 18 is similar to a joy or force stick in that the actuator 18 manually provides movement commands that can be used by the RDA's software to move a cursor on display 16. Switches 26 and 28 are designed to quickly select an operator specified network software program. Speaker 24 and microphone 38 are used for audio messages. Switch 19 at the top left of device 10 is the power on and power off switch for the entire device.

The heart of the invention lies in the applicant's ACS application programs provided in the device. The ACS programs are activated by clicking on an icon on the display to turn the ACS programs on or off. Mounted within housing 12 as part of the PDA is the display 16 and the CPU. The internal CPU includes databases and software application programs that provide for a geographical map and georeferenced entities that are shown as display portion 16b that includes as part of the display various areas of interest in the particular local map section.

When looking at display 16, the software switches (soft switches) which appear at the very bottom of the display 16d are used to control by touch many of the software driven functions of the cellular phone and PDA. The soft switches are activated through the operator's use of the navigation pad 18, or a small track ball, force stick or similar hardware display cursor pointing device. Alternatively, the operator may choose to activate the software switches by touching the screen with a stylus 14 (or finger) at the switches' 16d locations. When some of the software switches are activated, different software switches appear. The bar display 16d shows the software switches "ZM IN (zoom in)," "ZM OT (zoom out)," "CENT (center)" and "GRAB (pan/grab)" at the bottom of the screen. These software switches enable the operator to perform these functions. The "SWITH (switch)" software switch at the lower right causes a matrix of layered software switches (soft switches) to appear above the bottom row of switches. Through use of the software switches, the operator can also manipulate the geographical map 16b or chart display. When looking at FIG. 1, display symbols depicting permanent geographical locations and buildings are shown. For example, the police station is shown and, when the symbol is touched by the stylus or finger, the latitude and longitude of the symbol's location, as shown in display section 16c, is displayed at the bottom left of the screen. The bottom right side of display 16c is a multifunction inset area that can contain a variety of information including: a) a list of the communication link participants; b) a list of received messages; c) a map, aerial photograph or satellite image with an indication of the zoom and offset location of the main map display, which is indicated by a square that depicts the area actually displayed in the main geographical screen 16b; d) applicable status information; and e) a list of the communication net participants. Each participant user would have a device 10 shown in FIG. 1.

Also shown on the display screen 16, specifically the geographical display 16b, is a pair of different looking symbols 30 and 34, a small triangle and a small square, which are not labeled. These symbols 30 and 34 can represent communication net participants having cellular phones in the displayed geographical area that are part of the

US 10,299,100 B2

7

overall cellular phone communications net, each participant having the same device **10** used. The latitude and longitude of symbol **30** is associated within a database with a specific cell phone number and, if available, its IP address and email address. The screen display **16b**, which is a touch screen, provides x and y coordinates of the screen **16b** to the CPU's software from a map in a geographical database. The software has an algorithm that relates the x and y coordinates to latitude and longitude and can access a communications net participant's symbol or a fixed or movable entity's symbol as being the one closest to that point.

In order to initiate a telephone call to the cellular phone user (communication net participant) represented by symbol (triangle) **30** at a specific latitude and longitude display on chart **16b**, the operator touches the triangle **30** symbol with the stylus **14**. The user then touches a "call" software switch from a matrix of displayed soft switches that would overlay the display area **16c**. Immediately, the cellular phone will initiate a cellular telephone call to the cellular phone user at the geographical location shown that represents symbol **30**. A second cellular phone user (communication net participant) is represented by symbol **34** which is a small square (but could be any shape or icon) to represent an individual cellular phone device in the display area. The ring **32** around symbol **30** indicates that the symbol **30** has been touched and that a telephone call can be initiated by touching the soft switch that says "call." When this is done, the telephone call is initiated. Other types of symbolic elements on the display **16** can indicate that a cellular phone call is in effect. Additionally, the operator can touch both symbol **34** and symbol **30** and can activate a conference call between the two cellular phones and users represented by symbols **30** and **34**. Again, a symbolic ring around symbol **34** indicates that a call has been initiated.

Equally important, a user can call the police station, or any other specific geographical facility displayed on the map including: buildings, locations of people, vehicles, facilities, restaurants, or the like, whose cellular phone numbers and, if available, Email addresses, IP addresses and their URLs (previously stored in the database) by touching a specific facility location on the map display using the stylus **14** and then touching the cellular phone call switch. As an example, the operator can touch and point to call a restaurant using a soft switch by touching the restaurant location with a stylus and then touching the call soft switch. The cellular phone will then call the restaurant. Thus, using the present invention, each participant can touch and point to call to one or more other net participants symbolically displayed on the map, each of whom has a device as shown in FIG. 1, and can also point to call facilities that had been previously stored in the phone's database. Furthermore, this symbol hooking and soft switch technique can be used to go to a fixed facility's website or to automatically enter the fixed facility's email address in an email.

Each cellular phone/PDA/GPS user device is identified on the map display of the other network participant user's phone devices by a display symbol that is generated on each user phone display to indicate each user's own location and identity. Each symbol is placed at the correct geographical location on the user display and is correlated with the map on the display and is transmitted and automatically displayed on the other network participant's PC and PDA devices. The operator of each cellular phone/PDA/GPS device may also enter one or more other fixed entities (buildings, facilities, restaurants, police stations, etc.) and geo-referenced events such as fires, accidents, etc., into its database. This information can be likewise transmitted to all

8

the other participants on the communications net and automatically displayed. The map, fixed entities, events and cellular phone/PDA/GPS device communication net participants' latitude and longitude information is related to the "x" and "y" location on the touch screen display map by a mathematical correlation algorithm.

When the cellular phone/PDA/GPS device user uses a stylus or finger to touch one or more of the symbols or a location displayed on the cellular phone map display, the system's software causes the status and latitude and longitude information concerning that symbol or location to be displayed. In order to hook a symbol or "track" such as another net participant which represents an entity on the geo-referenced map display, or a fixed geographical entity such as a restaurant, police station or a new entity observed by a cell phone user which is discussed below, the operator touches at or near the location of a geo-referenced symbol appearing on the cellular phone/PDA display that represents a specific track or specific participant or other entity. The hook application software determines that the stylus (or finger) is pointed close to or at the location of the symbol and puts a circle, square or other indication around the symbol indicating that amplification information concerning the symbol is to be displayed. The operator can hook entered tracks or his own track symbol and add data or change data associated with the indicated symbol. The hook application code then sends a message to the database application code to store the facility or entity's updated data. The display application code retrieves the primary data and amplification data concerning the symbol or entity from the database and displays the information at the correct screen location. The operator can then read the amplification data that relates to that specific symbol at the specific location. The cell phone operator can also select soft switches on the touch screen display to change the primary data and amplification data. Furthermore, the operator can use a similar method of hooking and selecting to activate particular soft switches to take other actions which could include: making cellular phone calls, conference calls, 800 number calls; sending a free text message, operator selected preformatted messages, photographs or videos to the hooked symbol; or to drop an entered symbol.

Each known net participant has a cellular phone number, IP address and, if available, Email address that is stored in each participant's device database.

To use the communication system, a user starts the PDA/cellular phone device system by turning on the cell phone power and selecting the cell phone and network software which causes: a) the cellular phone to be activated (if it has not already been activated); b) the GPS interface receiver to be established; c) a map of the geographic area where the operator is located and operator's own unit symbol to appear at the correct latitude and longitude on the map on the display; d) the locations of fixed facilities such as restaurants, hotels, fire departments, police stations, and military barracks, that are part of the database to appear as symbols on the map; e) the device selected item read out area which provides amplification information for the communications net participants or the entity that has been hooked (on the display screen) to appear on the display; f) an insert area that contains various data including: the list of net participants, a list of messages to be read, an indication of what portion of the map is being displayed in major map area and other information to appear on the display; and g) a row of primary software created "soft switches" that are always present on the display to appear.

US 10,299,100 B2

9

For point to call network units and fixed facilities, the application code detects the x, y display screen location of the symbol that is designated by the user's stylus and translates the x, y coordinates to latitude and longitude and then: (1) searches the database to find the symbol at that location, (2) places a "hook" indicator (a circle, square or other shape) around the symbol, (3) displays any amplifying data and (4) obtains the symbol's associated phone number (or, for Voice over IP (VoIP) an IP address) from the database. Upon receiving a "call" designation from the soft switch, the operator's device's ACS causes the appropriate phone number or IP address to be called. Upon receiving an indication that the phone number is being called, the application code places a box around the symbol (color, dashed or the like). When the call is connected, the box changes to indicate that the connection is made. When the other party hangs up, the box disappears.

As each of the cell phone participants reports its identity, location and status to the other participants' devices, the received data is automatically geo-referenced and filed in their databases that are accessible by identity and by location. This data is then displayed on each cell phone display. When a request for data is received by touching the display screen, a location search is made by the ACS and a symbol modifier (circle, square, etc.) is generated around the symbol closest to the x, y position of the stylus. When the application code receives a soft switch command to place a phone call or send data, the software uses the phone number (or IP address) associated with the unit to place the call or to send data.

If a cell phone device receives a digital message that a call is being received, the receiving cell phone's ACS application code places a box or similar object around the transmitter symbol indicating who the call is from. When the call is answered, the application software changes the visual characteristics of the box. In a similar manner, when a phone receives a digital text message, photograph or video, a box appears around the transmitter's symbol indicating the transmitter of the message. The point to call network devices are network participants and each one has a PC/PDA device with the same software for use as a total participant network. Other situations for calling facilities that are not network participants are also described below.

Thus, a user is capable of initiating a cellular phone call by touch only and initiating conference calls by touching the geo-referenced map symbols. Furthermore, by using a similar symbol touching technique, a cellular phone can send user selected messages to cause a remote cellular phone to display and optionally announce emergency and other messages and to optionally elicit a response from the remote cellular phone.

All of the network participants have the same communication cell phone/PDA/GPS device described herein. The method and system include the ability of a specific user to provide polling in which other cellular phones, using SMS, internet or WiFi, report periodically based on criteria such as time, speed, distance traveled, or a combination of time, speed and distance traveled. A user can manually poll any or all other cell phone devices that are used by all of the participants in the communication network having the same devices. The receiving cellular phone application code responds to the polling command with the receiving cellular phone's location and status which could include battery level, GPS status, signal strength and entered track data. Optionally, the phone operators can set their phones to report automatically, based on time or distance traveled intervals or another criterion.

10

The soft switch application software causes a visual display of a matrix such as five across by six up (or another matrix) in which switch names are placed on the cellular/PDA display. The soft switch network application software knows the touch screen location of each of the switches in the matrix and the software routines that will be activated upon touching the switch.

The bottom row of soft switches displayed on the touch screen remains visually fixed. These switches concern the functions that are the most often used. One of the switches causes a matrix of other soft switches to appear above the visually fixed soft switches. These switches are function soft switches, the activation of any one of which causes a different matrix of soft switches to appear, which are known as the action soft switches. When the action soft switches appear, the function soft switch, which caused the action soft switches to appear, itself appears as a label in the lower left (or some other standard location) indicating to the operator the function soft switch that has been selected. When the operator selects an action soft switch, the appropriate application software to accomplish the action is activated.

Upon receiving a soft switch activation message, the ACS accesses the appropriate task execution software which accomplishes the required tasks including: entry of track data, entry of track amplification data, transmission of alpha/numeric messages, photographs, videos, display of messages to be read, selection of map types, placing voice calls, placing conference calls and 800 conference calls, presenting different potential operator selections, control of the display actions, polling network participants, establishing nets of participants (groups) so that communications with all in the group can be accomplished with a single soft switch action, and dropping a previously entered track. By providing a matrix and layers of soft switches which are easily manipulated by a stylus, each cell phone device in the communication network is extremely efficient in accessing and coordinating the appropriate application program for the device to perform.

Users such as emergency groups, police, fire personal, military, first responders and other groups need to be able to set up ad hoc digital and voice networks easily and rapidly. The users need to be able to rapidly coordinate activities eliminating the need for pre-entry data as discussed above. Users are required to enter the Servers' IP address and an ad hoc event name, a password and, for first responders and military, the names of their units. This will normally be controlled by the PDA/PC user's position in the chain of command. For others it can be any selected name and, if desired, password.

Referring now to FIG. 2, the PDA/PC screen displays an IP address entry menu. The user inserts the Server's IP address. Thus, as shown in FIG. 2, the user has entered in the cell phone/PDA the Server IP address and port number along with the GPS port listing and other information. Once that information is entered, referring now to FIG. 3, the user now enters the ad hoc event network name which is shown in this example as "Katrina" along with a password. Referring now to FIG. 4, the user then enters the user name or a unit name. FIG. 4 shows the entered user name and a phone number. The phone number may be automatically entered by the ACS or manually entered. The phone number is not required unless using the phone system (not VoIP) to make calls. These are the initial user steps required to establish an ad hoc network or to join onto an existing ad hoc network.

Referring now to FIG. 5, these actions cause the user cell phone/PDA or PC to commence reporting to the Server. Upon receipt of the initial message from the user's PDA/PC,

US 10,299,100 B2

11

which may also contain additional data such as a license number, the Server stores the IP address of the user's PDA/PC unit and responds with a message notifying the user that he or she is connected to the Server. The PDA/PC then automatically commences to report its GPS derived location and other status information to the Server. Since there are no other devices initially communicating with the Server, the Server just retains the information. When other devices sign on to the Server with the same ad hoc event name and password, the Server's software recognizes this and stores their IP addresses. Since the Server has all parties' IP addresses, the server is able to pass location and status information automatically between the ad hoc network participants. This can occur even though the ad hoc network participants have not entered other network participants names, telephone numbers or Email addresses and do not have the other network participants' IP addresses, phone numbers or Email addresses. Once this connection is made, data types that are entered on one display that is of interest to all is sent from the server to all others in the network. Such data types include track location and track amplification data, geo-referenced white boards, and chat.

When the PDA/PC user wants to address particular data (a text message, photograph, video clip, voice recording, white board, or chat), the user enters the name of the other ad hoc network participant by either entering a name or touching his or her symbol. Since the Server knows the IP address of the name or symbol, the Server forwards the data appropriately to that network participant. When a unit signs off the network, it transmits a message to the Server which then transmits a message to all the network participants to drop the unit and its associated tracks. If a unit loses communications for a variable time period, the unit's data is flushed from each of the recipient network participants systems according to a variable time period. After a separate variable time period, the Server also flushes the non-reporting units data.

As can be seen in FIG. 6, provisions have been made for the PDA/PC to report on multiple networks thus allowing both digital communications up and down the chain of command and with adjacent units that have entered a common ad hoc network name and password.

Typically military and First Responder units use Push-to-Talk (PTT) communications. Units in an organization's chain of command typically have instituted a method to establish voice communications between themselves for they know each other's cellular phone numbers, PTT cellular group identifiers and radio frequencies or channel numbers. However, in a disaster there are many different units (fire, police, EMS, Military, and the like) involved all of whom need to establish voice communications between each other. The issue then becomes how to coordinate these PTT voice communications with the ad hoc digital communications so that all on the digital data network automatically also have PTT voice communications with each other. If the PCs and PDAs in a group have manually entered their phone numbers, or the ACS has automatically entered their phone numbers, and sent their phone numbers as part of their initial message to the Server, this data is then sent by the Server to all others in the network. Upon receiving the phone number data, the recipients' ACS loads the cell phones numbers into their databases creating a phone number PTT group common with the digital IP network group.

The issue when using radios, however, is different. PTT radio coordination between multiple people is achieved by using a common radio frequency "Channel".

12

Furthermore, it is desirable to enable it so that, when new network participants join the digital network, they are automatically included in the voice network and, when they leave the digital network, they are automatically dropped from the digital network.

As can be seen in FIG. 6 and FIG. 7, a network participant currently can establish a new ad hoc digital network or join an existing ad hoc digital network by entering the ad hoc network name and password into his PDA/PC. To enable voice coordination with all that are a part of the ad hoc digital network, the user then enters (if user is authorized to do so) a Channel or Group number that the user is commanding all in the ad hoc network to establish as their PTT voice net. As seen in FIG. 6, the operator has commanded all to shift to Radio Channel or to a specific PTT cellular or radio channel; i.e. Group 7.

This action causes the PTT Channel, or PTT Group 7, to be sent to the other PDA/PC users in the ad hoc password protected network through the Server.

As shown in FIG. 6 and FIG. 7, the Group leader enters the Katrina Fire ad hoc network and issues a command which is sent to the Server to cause the PDAs/PCs that are in the Katrina Fire Group to automatically shift their Radio or cellular device to Channel 7. Each PDA cell phone can connect to the user's Radio for control with a USB cable, or WiFi, Bluetooth, or Near Field Communications (NFC) signals or other communications that are contained in the PDA/PC cellular device. This enables the Radios to shift to a common channel. This action is received by the Server which then sends the "Shift to Channel 7 Command" to all network participants in the Katrina Fire ad hoc network. When the PDA/PC/Tablet Katrina Fire network participant's software receives the command to shift its Radio Channel PTT to Group 7, this action causes the PDA's ACS to establish a new Channel 7 group (or to override an old Channel 7 group) that consists of all on the digital ad hoc network. The PC and PDAs then send their radios' digital interfaces messages to shift to Channel 7 or to the frequency associated with Channel 7. The digitally networked PC's and PDA's ACS devices then send a message to all on the digital network that they have shifted to Channel 7 (or to the appropriate frequency) and also further send the Group Leader's identifier and Command to shift to Channel 7 so that the ACS' devices associated with new users joining the digital network will automatically digitally set their radios to Channel 7 or the appropriate frequency.

As shown in FIG. 7, each time one of the network participants reports to the Katrina Fire network its Name, Position and Status, it now also reports that it is in PTT Channel 7 enabling the PTT group to grow in size until it encompasses all in the ad hoc password protected digital network. When units drop out of the Common Interest Network or lose communications because they are no longer active or they are out of range, their PTT Channel data is likewise dropped as they dropped out of the digital because their reports have not been received for a set, but adjustable, time period. If a unit rejoins the network, their PTT Name and Phone number is again automatically added to the Katrina Fire Interest Group as they are accepted by the Server into the Katrina Fire Interest digital Group.

When using the PTT feature, the ACS can enable the network participant to: 1. PTT with all that are in the ad hoc digital network, or 2. PTT with select specific network participants, by touching their symbol(s) and then selecting PTT soft switch or 3. Specify a group of the network participants by assigning their symbol or unit name to a list of network participants and then associating the list with a

US 10,299,100 B2

13

soft switch whose function is to enable the operator to have PTT communications with all in the list.

Since only one person is transmitting on a PTT voice network at any given time, the receiving network participant's ACS can relate the PTT IP address to the IP address of the unit transmitting his identification on the digital ad hoc network. This information can then be used by the other PTT networked participant's ACS to: 1. flash the transmitting unit's name on their FDA/PC screens or 2. if a photograph has been attached to the ad hoc digital network symbol of the PTT transmitting person, to flash that photograph on the receiving unit's PDA/PC display.

Referring now to FIG. 8, for some Emergency events, and in particular military operations, it is desirable to further define ad hoc networks so that the networks encompass only a certain geographical area defined by boundary lines on a map. To accomplish this, an enhancement to the ad hoc digital and voice PTT password protected network is provided. As an example, once the Katrina Fire digital and PTT network is established, the ad hoc network can be further refined by the Group Leader defining a map area that limits the participating group to only those users within a geographically defined area by the Group Leader, creating on his PC/PDA display a box that defines a geographic area on a map.

As shown in FIG. 8, the Latitude/Longitude points that define the rectangle of the boundary area are sent from the Group Leader's device to the Server which relays the data to the other participating unit PC/FDA devices in the Katrina Fire network. When the participating unit devices receive the Latitude/Longitude points, their software computes whether their PC/PDA unit is inside or outside a boundary area. If the users are inside the defined area, the users retain but disregard the Latitude/Longitude data and continue to report on the digital password protected network and to use the commanded PTT channel/frequency. However, if the users are outside the area, the users send a "drop me message" to the Katrina Fire PDA/PC digital network Server and cease reporting on the network. When Katrina Fire network PDA/PC user units leave the defined area or lose communications for a specified, but adjustable, time period, the Server drops the unit from the network and informs all network users that the unit is dropped from the digital network and from voice PTT Channel 7 which causes all others on the network to drop them. When Katrina Fire networked PDA/PC user units re-enter the area, the unit's ACS detects the fact and commences reporting as it receives reports from other network participants it will receive the current PTT channel or frequency.

In disasters, battery life is essential as there may not be extra batteries available or a power available to recharge the battery. It is therefore essential to lessen battery utilization. The normal method by which this is accomplished is to not use software that keeps the display on, uses the GPS or transmits on the communications. However, deactivating any one of these processes produces a problem with providing location data to all on the network.

With location sharing there are essentially two times when the location information is essential: a) Where the user wants all to know his/her location and status and the location and status of others and b) When the commander wants to know the location and status of all or of a particular unit.

When the user wants others to know the user location and status, the user can simply turn on location reporting software which then turns on the display, the GPS and the communications reporting software causing the reporting of the user location to the ad hoc password protected digital

14

network. However, when the commander or someone else wants to know the location and status of the PDA/PC unit that is conserving battery usage by having user display, GPS and communications transmission turned on, the commander has no method to accomplish this.

This problem is overcome by enabling the commander to transmit a "turn on" IP message to the battery conserving(s) unit(s) by addressing the message to the ad hoc network Server which then sends an SMS message to the addressed phone. The SMS message will be received as long as the phone is powered on, as SMS is integrated with the cell phone's voice communications. The Server could also send a turn on IP message to networked radios, which will then cause the radio's computer to send a digital message to the receiving PC/PDA to activate the user display and location and status reporting software.

Referring now to FIG. 9, the diagram illustrates the enabling of location, status, VoIP, PTT, and video communications between radios and cell phones. The server maintains a temporary retention of names and IP addresses and sends data between all with the same ad hoc name unless addressed to a specific IP address. This requires that there is a radio with digital capabilities attached to the server shown in FIGS. 5, 6, and 7. These radios are set so that they each have a unique IP address. All of the participants have either PDA cell phones or PDAs without cellular. Those that also have PDAs without cellular (or choose not to use cellular) are connected to their radios via a USB cable or Wi-Fi, Bluetooth, or near field communications (NFC) that is part of the PDA/PC OR PDA cell phone. This is illustrated in FIG. 9.

Referring now to FIG. 10 the diagram shows enabling non-RFID equipped PDA phones to receive RFID tag data. The server maintains a temporary retention of how Tags relate to names and sends data to local display and to other ACS network participants. Currently RFID tags are used for many functions, one of which is to track personnel inside a building to the room or compartment in which they are located. This is accomplished by RFID readers that are in each of the rooms. When personnel with an RFID tag get within a particular distance or range of the RFID reader, the reader detects their presence and sends it to a central site server via a USB cable or Wi-Fi. The PC connected to the server displays the personnel room locations. With the invention described herein, the server would then send the location to the ACS PDA/PC phones that would be carried by individuals located throughout the building or ship. The PDA/PC phones would display the room or ships compartments and the location of individuals with RFID tags and simultaneously enable PTT, chat, messaging, whiteboards, commands geo-fence penetration alerts or other types of messages between each of the PDA cell phones. The RFID tag would provide room location data of all to all that are on the ACS Wi-Fi network without their PDA cell phone having an RFID Reader attached to it. The operation is explained in detail in FIG. 10.

The instant invention has been shown and described herein in what is considered to be the most practical and preferred embodiment. It is recognized, however, that departures may be made there from within the scope of the invention and that obvious modifications will occur to a person skilled in the art.

What is claimed is:

1. A method performed by a mobile device having a display and one or more processors, the method comprising: executing operations on the one or more processors of the mobile device, the operations comprising:

US 10,299,100 B2

15

associating the mobile device with an identifier, wherein the identifier corresponds to a network participant;

determining a device location corresponding to a geographical location of the mobile device;

receiving, from a server, mapping data including a map and coordinate translation data correlating coordinates of positions on the map with corresponding coordinates of geographical locations;

receiving, from a server, location data indicating vehicle locations of one or more vehicles;

marking the map with a plurality of symbols comprising: a participant symbol corresponding to the device location, one or more facility symbols corresponding to respective facility locations of one or more facilities, and one or more vehicle symbols corresponding to the respective vehicle locations of the one or more vehicles, wherein marking the map comprises:

determining, based at least in part on the vehicle locations and the coordinate translation data, positions on the map corresponding to the vehicle locations,

displaying the map on the display of the mobile device, and

placing the vehicle symbols on the map at the determined positions corresponding to the vehicle locations;

responsive to user selection of a portion of the display corresponding to a position on the map, identifying a selected facility symbol based on the selected position, comprising: initiating a search of a set of symbols including the facility symbols for a symbol located nearest to the selected position and, based on a result of the search, identifying the selected facility symbol as the symbol located nearest to the selected position;

responsive to user input, transmitting first information to a first vehicle of the one or more vehicles; and receiving second information corresponding to the first vehicle and displaying the received second information on the display of the mobile device,

wherein the mobile device does not have access to a phone number associated with a computing device corresponding to the first vehicle, an Internet Protocol (IP) address associated with the computing device corresponding to the first vehicle, and an e-mail address associated with the computing device corresponding to the first vehicle.

2. The method of claim 1, wherein:

determining the device location comprises obtaining geographical coordinates representing the geographical location of the mobile device from a global positioning system (GPS) receiver located within the mobile device; and

marking the map further comprises placing the participant symbol at a position on the map corresponding to the geographical coordinates representing the geographical location of the mobile device.

3. The method of claim 1, wherein transmitting the first information to the first vehicle comprises sending data comprising at least one of the identifier and the device location to a server.

4. The method of claim 1, further comprising updating the map by updating at least one item selected from the group consisting of: a position of the participant symbol, positions of the one or more vehicle symbols, and a portion of the map displayed on the display of the mobile device.

16

5. The method of claim 1, further comprising:

receiving, from a server, updated respective vehicle locations of the one or more vehicles; and

updating, based on the received updated vehicle locations and the coordinate translation data, positions of the one or more vehicle symbols on the map.

6. The method of claim 1, further comprising:

receiving, from a GPS receiver, updated device locations; and

updating, based on the received device locations and the coordinate translation data, a position of the participant symbol on the map.

7. The method of claim 1, wherein the received second information is sent by the computing device corresponding to the first vehicle based on at least one criterion selected from the group consisting of: (1) passage of time, and (2) movement of the first vehicle.

8. The method of claim 1, wherein the received second information comprises one or more messages.

9. The method of claim 8, wherein the one or more messages comprise data to facilitate the mobile device transmitting the first information to the first vehicle without the mobile device using the phone number, IP address, and e-mail address associated with the first vehicle.

10. The method of claim 1, further comprising:

communicating the identifier to a server; and

joining a communication network after the communication of the identifier to the server.

11. The method of claim 10, wherein the communication network comprises one or more communication devices corresponding, respectively, to the one or more vehicles, and wherein each of the one or more communication devices is associated with a respective identifier.

12. The method of claim 1, further comprising determining a location-reporting status of the mobile device, wherein the location-reporting status is one of a reporting state and a non-reporting state, and wherein transmitting the first information to the first vehicle comprises sending the device location to a server only when the location-reporting status is in the reporting state.

13. The method of claim 1, wherein transmitting the first information to the first vehicle comprises transmitting data including the first information to a server using an Internet Protocol, wherein the second information corresponding to the first vehicle is transmitted by the server to the mobile device using the Internet Protocol, and wherein an IP address of the server is accessible to the mobile device.

14. The method of claim 13, wherein the data transmitted to the server further includes a second identifier corresponding to a second network participant associated with the computing device corresponding to the first vehicle.

15. The method of claim 14, wherein:

the server stores an IP address of the computing device associated with the second network participant identified by the second identifier; and

the server transmits the first information to the computing device corresponding to the first vehicle in a message addressed to the stored IP address of the computing device corresponding to the first vehicle.

16. The method of claim 1, further comprising determining coordinates of the selected position on the map, wherein data associated with the set of symbols include coordinates of positions on the map of the symbols in the set,

US 10,299,100 B2

17

wherein the search of the set of symbols includes a search of the coordinates of the positions of the symbols in the set for coordinates located nearest to the coordinates of the selected position, and

wherein the selected facility symbol is identified as the symbol located nearest to the selected position based on a result of the search of the coordinates of the positions on the map of the symbols.

17. The method of claim 1, further comprising determining coordinates of the selected portion of the display,

wherein data associated with the set of symbols include coordinates of portions of the display corresponding to the symbols in the set,

wherein the search of the set of symbols includes a search of the coordinates of the portions of the display corresponding to the symbols in the set for coordinates located nearest to the coordinates of the selected portion of the display, and

wherein the selected facility symbol is identified as the symbol located nearest to the selected position based on a result of the search of the coordinates of the portions of the display corresponding to the symbols.

18. The method of claim 1, further comprising determining coordinates of a location represented by the selected position on the map,

wherein data associated with the set of symbols include coordinates of locations of entities represented by the symbols in the set,

wherein the search of the set of symbols includes a search of the coordinates of the locations of the entities represented by the symbols in the set for coordinates located nearest to the coordinates of the location represented by the selected position on the map, and

wherein the selected facility symbol is identified as the symbol located nearest to the selected position based on a result of the search of the coordinates of the locations of the entities represented by the symbols.

19. The method of claim 1, further comprising: after identifying the selected facility symbol, displaying an address of the facility represented by the facility symbol.

20. The method of claim 1, wherein the mobile device is a first mobile device, wherein the map is a first map, and wherein the method further comprises:

receiving second user input via user interaction with a second portion of the display of the first mobile device, the second user input specifying a position on the first map of an event symbol representing an event; and based on the second user input:

determining coordinates of a location of the event based on coordinates of the specified position on the first map and the coordinate translation data;

associating the location of the event with the event symbol;

displaying the event symbol at the specified position on the first map; and

transmitting the location of the event to a second mobile device corresponding to the first vehicle, wherein the second mobile device is operable to display a second map and to place the event symbol on the second map.

21. The method of claim 20, wherein the coordinates of the location of the event are determined based on coordinates of the position of the event symbol on the map and the coordinate translation data.

18

22. The method of claim 20, wherein the coordinates of the location of the event are determined based on coordinates of the second portion of the display and the coordinate translation data.

23. The method of claim 1, wherein the map is first map, wherein the coordinate translation data are first coordinate translation data, wherein an area depicted in the first map represents a first portion of an area depicted in a second map, and wherein the method further comprises:

receiving, from a server, a third map representing a second portion of the area depicted in the second map and second coordinate translation data correlating coordinates of positions on the second map with corresponding coordinates of geographical locations.

24. A system comprising a mobile device contained in a portable housing, the mobile device comprising:

a touch screen display, non-transitory computer-readable media, and a central processing unit (CPU);

a mobile device transmitter communicatively coupled to the CPU;

a mobile device receiver communicatively coupled to the CPU;

a global positioning system (GPS) receiver, communicatively coupled to the CPU, configured to obtain geographical coordinates corresponding to a geographical location of the mobile device;

the CPU configured to execute instructions to perform operations comprising:

associating the mobile device with an identifier, wherein the identifier corresponds to a network participant; determining, by the CPU, a device location corresponding to the geographical location of the mobile device based on the geographical coordinates obtained by the GPS receiver located within the mobile device;

receiving, from a server, mapping data including a map and coordinate translation data correlating coordinates of positions on the map with corresponding coordinates of geographical locations;

receiving, from a server, location data indicating vehicle locations of one or more vehicles;

marking the map with a plurality of symbols comprising: a participant symbol corresponding to the device location, one or more facility symbols corresponding to respective facility locations of one or more facilities, and one or more vehicle symbols corresponding to respective vehicle locations of the one or more vehicles, wherein marking the map comprises:

determining, based at least in part on the vehicle locations and the coordinate translation data, positions on the map corresponding to the vehicle locations,

displaying the map on the display of the mobile device, and

placing the vehicle symbols on the map at the determined positions corresponding to the vehicle locations;

responsive to user selection of a portion of the display corresponding to a position on the map, identifying a selected facility symbol based on the selected position, comprising: initiating a search of a set of symbols including the facility symbols for a symbol located nearest to the selected position and, based on a result of the search, identifying the selected facility symbol as the symbol located nearest to the selected position;

US 10,299,100 B2

19

after receiving user input on the touch screen display, transmitting, by the mobile device transmitter, first information to a first vehicle of the one or more vehicles; and

after transmitting the first information to the first vehicle, receiving, at the mobile device receiver, second information corresponding to the first vehicle and displaying the received second information on the touch screen display of the mobile device,

wherein the mobile device does not have access to a phone number associated with a computing device corresponding to the first vehicle, an Internet Protocol (IP) address associated with the computing device corresponding to the first vehicle, and an e-mail address associated with the computing device corresponding to the first vehicle.

25. The system of claim 24, wherein the operations further comprise:

receiving, from a server, at the mobile device receiver, updated respective vehicle locations of the one or more vehicles; and

updating, based on the received updated vehicle locations and the coordinate translation data, positions of the one or more vehicle symbols on the map displayed on the touch screen display.

26. The system of claim 24, wherein the operations further comprise:

communicating, by the mobile device transmitter, the identifier to a server; and

joining a communication network after the communication of the first identifier to the server.

27. The system of claim 26, wherein the identifier is a first identifier, and wherein the communication network comprises one or more communication devices corresponding, respectively, to one or more second vehicles, and wherein each of the one or more communication devices is associated with a respective second identifier.

28. The system of claim 27, wherein the operations further comprise:

20

receiving, by the mobile device receiver, the second identifiers corresponding to one or more communication devices; and

displaying, on the map displayed on the touch screen display, one or more second vehicle symbols corresponding to the second identifiers corresponding to the second vehicles.

29. The system of claim 24, wherein:

the operations further comprise determining, by the CPU, a location-reporting status of the mobile device, wherein the location-reporting status is one of a reporting state and a non-reporting state; and

transmitting, by the mobile device transmitter, the first information to the first vehicle further comprises sending the device location to a server only when the location-reporting status is in the reporting state.

30. The system of claim 24, wherein:

transmitting the first information to the first vehicle comprises transmitting data to a server using an Internet Protocol;

the data transmitted to the server includes the first information and a second identifier corresponding to a second network participant associated with the computing device corresponding to the first vehicle;

the second information corresponding to the first vehicle is transmitted by the server to the mobile device using the Internet Protocol; and

an IP address of the server is accessible to the mobile device.

31. The system of claim 30, wherein:

the server stores an IP address of the computing device associated with the second network participant identified by the second identifier; and

the server transmits the first information to the computing device corresponding to the first vehicle in a message addressed to the stored IP address of the computing device corresponding to the first vehicle.

* * * * *

Exhibit E



US010341838B2

(12) **United States Patent**
Beyer, Jr. et al.

(10) **Patent No.:** **US 10,341,838 B2**
 (45) **Date of Patent:** ***Jul. 2, 2019**

(54) **METHOD TO PROVIDE AD HOC AND PASSWORD PROTECTED DIGITAL AND VOICE NETWORKS**

(58) **Field of Classification Search**
 CPC H04W 4/02
 See application file for complete search history.

(71) Applicant: **AGIS Software Development LLC,**
 Marshall, TX (US)

(56) **References Cited**
 U.S. PATENT DOCUMENTS

(72) Inventors: **Malcolm K. Beyer, Jr.,** Jupiter, FL
 (US); **Christopher R. Rice,** Redmond, WA (US)

5,325,310 A 6/1994 Johnson et al.
 5,555,286 A 9/1996 Tendler
 (Continued)

(73) Assignee: **AGIS Software Development LLC,**
 Marshall, TX (US)

FOREIGN PATENT DOCUMENTS

(*) Notice: Subject to any disclaimer, the term of this patent is extended or adjusted under 35 U.S.C. 154(b) by 0 days.

EP 1148754 A2 10/2001
 EP 1655888 A1 5/2006
 (Continued)

This patent is subject to a terminal disclaimer.

OTHER PUBLICATIONS

U.S. Appl. No. 15/722,660, Method to Provide Ad Hoc and Password Protected Digital and Voice Networks, filed Oct. 2, 2017.

(21) Appl. No.: **15/809,102**

(Continued)

(22) Filed: **Nov. 10, 2017**

Primary Examiner — Omoniyi Obayanju

(65) **Prior Publication Data**

(74) *Attorney, Agent, or Firm* — Goodwin Procter LLP

US 2018/0152556 A1 May 31, 2018

(57) **ABSTRACT**

Related U.S. Application Data

A method and system includes the ability for individuals to set up an ad hoc digital and voice network easily and rapidly to allow users to coordinate their activities by eliminating the need for pre-entry of data into a web or identifying others by name, phone numbers or email. This method is especially useful for police, fire fighters, military, first responders or other emergency situations for coordinating different organizations at the scene of a disaster to elevate conventional communication problems either up and down the chain of command or cross communication between different emergency units. The method and system provides that the users are only required to enter a specific Server IP address and an ad hoc event name, a password and perhaps the name of the particular unit.

(63) Continuation of application No. 15/722,660, filed on Oct. 2, 2017, now Pat. No. 10,299,100, which is a (Continued)

(51) **Int. Cl.**
H04W 4/00 (2018.01)
H04W 4/90 (2018.01)

(Continued)

(52) **U.S. Cl.**
 CPC **H04W 4/90** (2018.02); **G01S 19/17** (2013.01); **G06F 3/0482** (2013.01);
 (Continued)

26 Claims, 7 Drawing Sheets

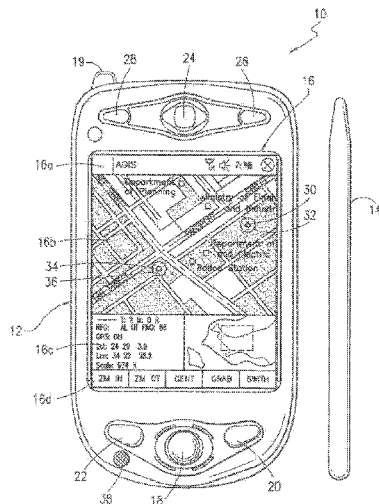

US 10,341,838 B2

Page 2

Related U.S. Application Data

continuation of application No. 15/469,469, filed on Mar. 24, 2017, now Pat. No. 10,292,033, which is a continuation of application No. 15/287,638, filed on Oct. 6, 2016, now Pat. No. 9,706,381, which is a continuation of application No. 14/529,978, filed on Oct. 31, 2014, now Pat. No. 9,467,838, which is a continuation-in-part of application No. 14/027,410, filed on Sep. 16, 2013, now Pat. No. 8,880,042, which is a continuation of application No. 13/751,453, filed on Jan. 28, 2013, now Pat. No. 8,538,393, which is a continuation-in-part of application No. 12/761,533, filed on Apr. 16, 2010, now Pat. No. 8,364,129, which is a continuation-in-part of application No. 11/615,472, filed on Dec. 22, 2006, now Pat. No. 8,126,441, which is a continuation-in-part of application No. 11/308,648, filed on Apr. 17, 2006, now Pat. No. 7,630,724, which is a continuation-in-part of application No. 10/711,490, filed on Sep. 21, 2004, now Pat. No. 7,031,728.

- (51) **Int. Cl.**
H04M 1/725 (2006.01)
H04W 68/00 (2009.01)
H04W 4/02 (2018.01)
H04W 76/50 (2018.01)
H04W 76/11 (2018.01)
H04M 1/2745 (2006.01)
H04W 4/08 (2009.01)
H04W 64/00 (2009.01)
H04W 84/18 (2009.01)
H04W 12/08 (2009.01)
H04W 12/02 (2009.01)
G06F 3/0482 (2013.01)
G06F 3/0484 (2013.01)
H04L 29/06 (2006.01)
H04L 29/08 (2006.01)
H04W 4/021 (2018.01)
H04L 29/12 (2006.01)
H04M 7/00 (2006.01)
H04W 12/06 (2009.01)
H04W 68/04 (2009.01)
G01S 19/17 (2010.01)
H04M 3/56 (2006.01)
H04W 4/14 (2009.01)
H04W 76/15 (2018.01)
H04W 4/10 (2009.01)
H04W 76/45 (2018.01)
H04W 12/04 (2009.01)
H04W 84/04 (2009.01)

- (52) **U.S. Cl.**
 CPC *G06F 3/04842* (2013.01); *H04L 61/605* (2013.01); *H04L 63/065* (2013.01); *H04L 63/083* (2013.01); *H04L 63/104* (2013.01); *H04L 67/18* (2013.01); *H04M 1/27455* (2013.01); *H04M 1/72519* (2013.01); *H04M 1/72536* (2013.01); *H04M 1/72547* (2013.01); *H04M 1/72572* (2013.01); *H04M 1/72583* (2013.01); *H04M 3/56* (2013.01); *H04M 7/006* (2013.01); *H04W 4/02* (2013.01); *H04W 4/021* (2013.01); *H04W 4/023* (2013.01); *H04W 4/026* (2013.01); *H04W 4/027* (2013.01); *H04W 4/08* (2013.01); *H04W 4/14* (2013.01); *H04W 12/02* (2013.01); *H04W 12/06* (2013.01); *H04W*

12/08 (2013.01); *H04W 64/00* (2013.01); *H04W 68/00* (2013.01); *H04W 68/04* (2013.01); *H04W 76/11* (2018.02); *H04W 76/15* (2018.02); *H04W 76/50* (2018.02); *H04W 84/18* (2013.01); *H04L 61/2007* (2013.01); *H04M 1/72525* (2013.01); *H04M 2250/10* (2013.01); *H04M 2250/22* (2013.01); *H04M 2250/62* (2013.01); *H04W 4/10* (2013.01); *H04W 12/04* (2013.01); *H04W 76/45* (2018.02); *H04W 84/042* (2013.01)

(56)

References Cited

U.S. PATENT DOCUMENTS

5,563,931	A	10/1996	Bishop et al.
5,692,032	A	11/1997	Seppanen
5,742,905	A	4/1998	Pepe et al.
5,764,898	A	6/1998	Tsuji et al.
5,898,434	A	4/1999	Small et al.
6,104,704	A	8/2000	Buhler et al.
6,108,704	A	8/2000	Hutton
6,119,017	A	9/2000	Cassidy et al.
6,128,291	A	10/2000	Perlman et al.
6,182,114	B1	1/2001	Yap et al.
6,204,844	B1	3/2001	Fumarolo et al.
6,232,971	B1	5/2001	Haynes
6,271,835	B1	8/2001	Hoeksma
6,292,747	B1	9/2001	Amro et al.
6,366,782	B1	4/2002	Fumarolo et al.
6,377,210	B1	4/2002	Moore
6,385,465	B1	5/2002	Yoshioka
6,434,403	B1	8/2002	Ausems et al.
6,459,440	B1	10/2002	Monnes et al.
6,477,387	B1	11/2002	Jackson et al.
6,487,595	B1	11/2002	Turunen et al.
6,490,521	B2	12/2002	Wiener
6,504,503	B1	1/2003	Saint Hilaire et al.
6,518,957	B1	2/2003	Lehtinen et al.
6,542,475	B1	4/2003	Bala et al.
6,549,768	B1	4/2003	Fraccaroli
6,654,683	B2	11/2003	Jin et al.
6,661,353	B1	12/2003	Gopen
6,662,016	B1	12/2003	Buckham et al.
6,665,293	B2	12/2003	Thornton et al.
6,697,734	B1	2/2004	Suomela
6,700,589	B1	3/2004	Canelones et al.
6,704,303	B1	3/2004	Bowman-Amuah
6,716,101	B1	4/2004	Meadows et al.
6,772,142	B1	8/2004	Kelling et al.
6,775,560	B2	8/2004	King et al.
6,816,878	B1	11/2004	Zimmers et al.
6,854,007	B1	2/2005	Hammond
6,867,733	B2	3/2005	Sandhu et al.
6,868,333	B2	3/2005	Melen
6,868,337	B2	3/2005	Muramatsu
6,882,856	B1	4/2005	Alterman et al.
6,885,874	B2	4/2005	Grube et al.
6,941,127	B2	9/2005	Muramatsu
7,002,952	B2	2/2006	Jones
7,024,207	B2	4/2006	Gorday et al.
7,031,700	B1	4/2006	Weaver et al.
7,031,728	B2	4/2006	Beyer, Jr.
7,039,040	B1	5/2006	Burg
7,103,333	B2	9/2006	Lazaridis et al.
7,158,878	B2	1/2007	Rasmussen et al.
7,194,083	B1	3/2007	Tischer et al.
7,219,303	B2	5/2007	Fish
7,271,742	B2*	9/2007	Sheha G01C 21/3664 340/995.19
7,292,935	B2	11/2007	Yoon
7,299,075	B2	11/2007	Gottlieb et al.
7,330,112	B1	2/2008	Emigh et al.
7,353,034	B2	4/2008	Haney
7,386,589	B1	6/2008	Tanumihardja et al.
7,398,551	B2	7/2008	Thomas et al.
7,421,270	B2	9/2008	Serafat et al.

US 10,341,838 B2

Page 4

(56)

References Cited

FOREIGN PATENT DOCUMENTS

WO	WO-03/074973	A2	9/2003
WO	WO-2003/096660	A1	11/2003
WO	WO-2008/030702	A2	3/2008
WO	WO-2008027891	A2	3/2008
WO	WO-2008/118878	A2	10/2008

OTHER PUBLICATIONS

U.S. Appl. No. 15/469,469, Method to Provide Ad Hoc and Password Protected Digital and Voice Networks, filed Mar. 24, 2017.

U.S. Appl. No. 15/255,046, Method to Provide Ad Hoc and Password Protected Digital and Voice Networks, filed Sep. 1, 2016.

Batayneh, Fahd A., Location Management in Wireless Data Networks. Apr. 21, 2006, 24pgs. Available on the Internet at https://www.cse.wustl.edu/~jain/cse574-06/ftp/wireless_location/index.html.

Ramjee, et al. IP-Based Access Network Infrastructure for Next-Generation Wireless Data Networks. IEEE Personal Communications, Aug. 2000. 8 pgs.

Toppila, Pekka. TCP/IP in Cellular Mobile Environment. 1999, 7pgs.

IBM, Transmission Control Protocol / Internet Protocol. 2pgs. Available on the Internet at www.ibm.com/support/knowledgecenter/en/ssw_aix_61/com.ibm.aix.networkcomm/tcpip_intro.htm.

Microsoft Corporation. Communication Services and Networking (Windows CE 5.0). 2006, 6pgs. Available on the Internet at <https://msdn.microsoft.com/en-us/library/ms880996.aspx>.

Zetter, Kim. How Attackers Can Use Radio Signals and Mobile Phones to Steal Protected Data. WIRED, Nov. 3, 2004. 5pgs. Available on the Internet at www.wired.com/2014/11/airhopperhack/.

Kutscher, Dirk et al. Drive-thru Internet: IEEE 802.11b for "Automobile" Users. IEEE Infocom, Mar. 7, 2004. 12pgs.

DIGI, Remote Cellular TCP/IP to Rockwell Ethernet and Serial Devices. 37pgs.

Batista, E., "Your Boss May Know Where You Are," Wired News, May 31, 2002; 2pgs.

Benefon ESC! GSM + GPS Personal Navigation Phone, 1999, Benefon Oyj, Salo, Finland; 4pgs.

Edlund, T. and Ciber, S., "Mobile Services for Truck Drivers," Master Thesis in Mobile Informatics, IT University of Goleborg, Sweden; 2003; 50pgs.

Garmin rino 110 2-way Radio & Personal Navigator; Owner's Manual and Reference Guide; Apr. 2003; 88pgs.

Gate5, "Mobile Community Solution: Context-sensitive Application Suite for Mobile Communities," 2002; 3pgs.

Gate5, "Mobile Guide Solution: Context-sensitive Applications for PDA-based Mobile City and Travel Guides," 2002; 4pgs.

Int'l Preliminary Report on Patentability (IPRP); for Int'l Patent App. No. PCT/JP2004/000250 dated Jul. 5, 2005; 4pgs.

Kim, R., "Find Friends by Cell Phone/Loop! Application's GPS Program Can Beam Map Location," SFGate; Nov. 14, 2006; 2pgs.

Life360's Rule 50(a) Motion for Judgment as a Matter of Law; *AGIS, Inc. v. Life360, Inc.* (S.D. FL); Mar. 12, 2015; 27pgs.

LocatioNet LBS Applications: MyMap description web page, published before 2004 upon information and belief; 13pgs.

LocatioNet Press Release: "LocatioNet Releases Ground Breaking Mass Market LBS Application Suite—LocatioNet MyMap," Mobile Location Services Congress; May 6, 2003; 2pgs.

Luna, L., "This Man Knows You Live . . . and Work and Play," Wireless Review; Sep. 1, 2002; pp. 24-32.

Meggers, J. And Sang-Bum Parl, A., "A Multimedia Communication Architecture for Handheld Devices," IEEE Paper 0-7803-4872-9/98, Sep. 8-11, 1998; pp. 1245-1249.

Memory Map Remote Tracking, available on the Internet at <https://web.archive.org/web/20060202161013/http://memory-map.com/>; 2pgs.

Plaintiff Advanced Ground Information Systems, Inc.'s Motions in Limine; *AGIS, Inc. v. Life360, Inc.* (S.D. FL); Feb. 19, 2015; 54pgs.

PRNewswire, "Trimble GPS Technology Enables Seiko Epson; Communication Device and Wireless Data Service," accessed on the internet at: [http://www.printhis.clickability.com/pt/cpt?expire=&title=Trimble+GPS+Technology+Enables+Seiko+Epson+Communication+Device+and+Wireless+Data+S.](http://www.printhis.clickability.com/pt/cpt?expire=&title=Trimble+GPS+Technology+Enables+Seiko+Epson+Communication+Device+and+Wireless+Data+S.;); downloaded Jun. 16, 2016; 4pgs.;

The Gate5 system, which, upon information and belief, was sold and/or publicly used within the U.S. prior to 2004 and at least as early as 2002.

The LocatioNet system which, upon information and belief, was sold and/or publicly used within the U.S. prior to 2004 and at least as early as 2003; 6pgs.

Östman, L., "A Study of Location-Based Services Including a Design and Implementation of an Enhanced Friend Finder Client with Mapping Capabilities," Lulea Tekniska Univeritet; Aug. 31, 2001; 63pgs.

"911 and E911 Services," Federal Communications Commission, updated Mar. 1, 2018, available at <https://www.fcc.gov/general/9-1-1-and-e9-1-1-services> (last visited May 7, 2018) (6 pages).

"AGIS Introduces Landmark Mobile Networking," dated Jun. 18, 2007, available as of Aug. 7, 2007 according to Wayback Machine Internet Archive Record, obtained from: https://web.archive.org/web/20070807202449/http://www.agisinc.com/AGIS_announcement.pdf (3 pages).

"AGIS Mobile Communication & Collaboration Software Being Used by Naval Coastal Warfare Squadron," available as of Aug. 7, 2007 according to Wayback Machine Internet Archive Record, obtained from: https://web.archive.org/web/20070807202431/http://www.agisinc.com/AGIS_US_Navy_photofeature.pdf (2 pages).

"BuddySpace Downloads," dated May 1, 2007, publication date unknown, available at: <http://projects.kmi.open.ac.uk/buddyspace/downloads/downloads.html> (3 pages).

"Cellular Mobile Pricing Structures and Trends," Organisation for Economic Co-operation and Development, Working Party on Telecommunications and Information Service Policies, May 16, 2000 (103 pages).

"Email," Wikipedia, <https://en.wikipedia.org/wiki/Email> (last visited May 10, 2018) (19 pages).

"Fact Sheet: FCC Wireless 911 Requirements," Federal Communications Commission, Jan. 2001, available at https://transition.fcc.gov/pshs/services/911-services/enhanced911/archives/factsheet_requirements_012001.pdf (4 pages).

"Force XXI Battle Command, Brigade and Below (FBCB2)," available as of Feb. 4, 2017 according to Wayback Machine Internet Archive Record, obtained from: <https://web.archive.org/web/20170204113146/http://www.dote.osd.mil/pub/reports/FY1999/pdf/army/99fbc2.pdf> (4 pages).

"Frequently Asked Questions," BuddySpace.org, available as of Apr. 23, 2007 according to Wayback Machine Internet Archive Record, obtained from: <https://web.archive.org/web/20070423184018/http://kmi.open.ac.uk:80/projects/buddyspace/faq.html> (11 pages).

"Frequently Asked Questions," BuddySpace.org, available as of Feb. 3, 2004 according to Wayback Machine Internet Archive Record, obtained from: <https://web.archive.org/web/20040204032758/http://kmi.open.ac.uk:80/projects/buddyspace/faq.html> (4 pages).

"History of Mobile Phones," Wikipedia, https://en.wikipedia.org/wiki/History_of_Mobile_phones (last visited May 10, 2018) (14 pages).

"How It Works: The Navizon Wireless Positioning System," Navizon.com, available as of Feb. 19, 2006 according to Wayback Machine Internet Archive Record, obtained from: <https://web.archive.org/web/20060219075647/http://www.navizon.com:80/FullFeatures.htm> (8 pages).

"Introduction & Philosophy: Presence in a Nutshell," publication date unknown, available at: <http://projects.kmi.open.ac.uk/buddyspace/intro-philosophy.html> (3 pages).

"mMode Features: Find Friends," AT&T Wireless, available as of Jun. 18, 2003 according to Wayback Machine Internet Archive Record, obtained from: <https://web.archive.org/20030618175223/http://www.attwireless.com:80/mmode/features/findit/FindFriends/> (2 pages).

US 10,341,838 B2

Page 5

(56)

References Cited

OTHER PUBLICATIONS

“Navizon: The first Peer-to-Peer Wireless Positioning System that successfully blends GPS +WiFi + Cellular signals together into one accurate and powerful Mobile Geo-Location System,” Navizon.com, available as of Dec. 18, 2005 according to Wayback Machine Internet Archive Record, obtained from: <https://web.archive.org/web/20051218105454/http://www.navizon.com:80/index.htm> (2 pages). “Palm VII,” Wikipedia, https://en.wikipedia.org/wiki/Palm_VII (last visited May 10, 2018) (2 pages).

“Simon Says ‘Here’s How!’ Simon Mobile Communications Made Simple,” Simon Users Manual, IBM Corp., copyright 1994 (41 pages).

“UCSD ActiveCampus,” available as of Feb. 6, 2003 according to Wayback Machine Internet Archive Record, obtained from: <https://web.archive.org/20030206012106/http://activecampus.ucsd.edu/> (3 pages).

“USCD Active Campus,” available as of Aug. 29, 2004 according to Wayback Machine Internet Archive Record, obtained from: <https://web.archive.org/web/20040829191734/http://activecampus.ucsd.edu/> (3 pages).

“Voice Over Internet Protocol (VoIP),” Federal Communications Commission, publication date unknown, updated at least as recently as May 13, 2009, available at <https://www.fcc.gov/general/voice-over-internet-protocol-voip> (last visited May 10, 2018) (11 pages). Active Campus, “ActiveCampus—Sustaining Educational Communities through Mobile Technology,” copyright 2002, available as of Nov. 25, 2004 according to Wayback Machine Internet Archive Record, obtained from: <https://web.archive.org/web/20041125060305/http://activecampus.edu:80/slides/active-campus-hpl> (35 pages).

Active Campus, “New Features in Active Campus (Apr. 2003),” available as of Sep. 1, 2006 according to Wayback Machine Internet Archive Record, obtained from: <https://web.archive.org/web/20060901101253/https://activecampus.ucsd.edu/new-features.php> (3 pages).

AGIS, “AGIS First Responders, Mobile Online Group Collaboration,” available as of Jul. 10, 2007 according to Wayback Machine Internet Archive Record, obtained from: <https://web.archive.org/web/20070710230256/http://www.agisinc.com/FirstResponders.asp> (2 pages).

AGIS, “Frequently Asked Questions About AGIS,” available as of Jul. 10, 2007 according to Wayback Machine Internet Archive Record, obtained from: <https://web.archive.org/web/20070710224856/http://www.agisinc.com/Faq.asp> (3 pages).

AGIS, “Mobile Social Networking,” available as of Jul. 10, 2007 according to Wayback Machine Internet Archive Record, obtained from: <http://web.archive.org/web/20070710224939/http://www.agisinc.com/SocialNetworking.asp> (1 page).

AGIS, “Track and Collaborate with Your Entire Team,” available as of Jul. 10, 2007 according to Wayback Machine Internet Archive Record, obtained from: <http://web.archive.org/web/20070710225045/http://www.agisinc.com/Business.asp> (2 pages).

Apple Newton, Wikipedia, https://en.wikipedia.org/wiki/Apple_Newton (last visited May 10, 2018) (10 pages).

APRS Working Group. “Automatic Position Reporting System: APRS Protocol Reference, Protocol Version 1.0,” Aug. 29, 2000, available at: <http://studylib.net/doc/18674143/aprs-protocol-specification> (128 pages).

Baard, M. “A Connection in Every Spot,” *Wired News*, Oct. 16, 2003, available at: <https://web.archive.org/web/20031127042047/http://www.wired.com:80/news/print/0,1294,60831,00.html> (3 pages).

Bachler, M. et al. “Collaboration in the Semantic Grid: a Basis for e-Learning,” publication date unknown, available at: http://oro.open.ac.uk/6202/1/aai_coaking-2005-preprint-krp.pdf (19 pages).

Bruninga, B. “APRS SPEC Addendum 1.1,” publication date unknown, available at: <http://www.aprs.org/aprs11.html> (4 pages).

Bruninga, B. “APRS Tiny Web Pages,” Sep. 2000, available at: <http://aprs.org/TWP.html> (7 pages).

Bruninga, B. “Automatic Packet/Position Reporting System (APRS),” dated Sep. 18, 2002, available at: <http://aprs.org/APRS-docs/APRS.TXT> (6 pages).

Bruninga, B. “Cellular Automatic Position Reporting System (APRS),” dated Jul. 7, 1999, available as of Jul. 25, 2004 according to Wayback Machine Internet Archive Record, obtained from: <https://web.archive.org/web/20040725024219/http://web.usna.navy.mil:80/~bruninga/APRS-docs/CELLULAR.TXT> (1 page).

Bruninga, B. “Generic Callsigns for National APRS Events,” dated Oct. 20, 2005, available at: <http://aprs.org/aprs-jota.txt> (1 page).

Bruninga, B. “Potential APRS Map of JOTA Contacts,” publication date unknown, obtained from: <http://www.aprs.org/cgsrvr.html> (last visited Nov. 28, 2017) (4 pages).

Bruninga, B. “Tips for Mobile APRS Users,” dated Jan. 2, 2004, available as of Jul. 25, 2004 according to Wayback Machine Internet Archive Record, obtained from: <https://web.archive.org/web/20040725035443/http://web.usna.navy.mil:80/~bruninga/APRS-docs/MOBILE.TXT> (4 pages).

Bruninga, B. “Touch Screen Display mods in APRStch.EXE,” dated Apr. 17, 2000, available as of Jul. 25, 2004 according to Wayback Machine Internet Archive Record, obtained from: <https://web.archive.org/web/20040725034727/http://web.usna.navy.mil:80/~bruninga/APRS-docs/TOUCH.TXT> (2 pages).

Carter, J. “Build an APRS Encoder Tracker,” *QST*, Feb. 2002 (5 pages).

Charny, B. “Find a Wireless Friend—for a fee,” *Cnet*, Jun. 24, 2002, available at: <https://www.cnet.com/news/find-a-wireless-friend-for-a-fee/> (2 pages).

Charny, B. “New cell feature helps find friends,” *Cnet*, Jun. 25, 2002, available at: <https://www.cnet.com/news/new-cell-feaure-helps-find-friends/> (5 pages).

Chen, Ching-Chen et al. “Automatically and Accurately Conflating Satellite Imagery and Maps,” In Proceedings of the International Workshop on Next Generation Geospatial Information, Oct. 2003 (4 pages).

Christie, Jock et al. “Development and Deployment of GPS Wireless Devices for E911 and Location Based Services,” Position, Location and Navigation Symposium, Palm Springs California, Apr. 15-18, 2002 (6 pages).

Cohen, Deborah. “Digital note-passing gains respect among adults,” *USAToday.com*, Nov. 26, 2004, available at: https://usatoday30.usatoday.com/tech/products/services/2004-11-26-im-gains-cred_x.htm (2 pages).

Conatser, J. et al. “Force XXI Battle Command Brigade and Below-Blue Force Tracking (FBCB2-BFT). A Case Study in the Accelerated Acquisition of a Digital Command and Control System during Operations Enduring Freedom and Iraqi Freedom,” dated Dec. 2005, available at www.dtic.mil/dtic/tr/fulltext/u2/a443273.pdf (73 pages).

Curriculum Vitae of William Griswold, available at: <https://cseweb.ucsd.edu/~wgg/CV.pdf> (29 pages).

Definition of “Subnetting,” *Techopedia*, available at <https://www.techopedia.com/definition/28328/subnetting> as of May 10, 2018 (2 pages).

Dunn, R.J. III. “Blue Force Tracking: The Afghanistan and Iraq Experience and Its Implications for the U.S. Army,” Northrop Grumman, 2003, available at: <http://www.northropgrumman.com/AboutUs/AnalysisCenter/Documents/pdfs/BFT-Afghanistan-and-Iraq-Exper.pdf> (20 pages).

Durso, Fred. “A Decade of Difference,” *NFPA Journal*, Sep. 1, 2011, available at <https://www.nfpa.org/News-and-Research/Publications/NFPA-Journal/2011/September-October-2011/Features/A-Decade-of-Difference> (6 pages).

Eisenstadt, M. et al. “BuddySpace: Enhanced Presence Management for Collaborative Learning, Working, Gaming and Beyond,” submitted to *JabberCon Europe 2002*, publication date unknown, available at: <https://pdfs.semanticscholar.org/8f3d/d07b4e9f3095b949e78de9a2be439e98e663.pdf> (6 pages).

Grier, Robin. “VoIP—How to Use It to Cut Costs and Enhance Radio Access,” *Radio Resource Magazine*, Jul. 2000 (4 pages).

Griswold, W. et al. “Active Campus—Sustaining Educational Communities through Mobile Technology,” Technical Report CS2002-0714, University of California at San Diego, Jul. 2002, available at: <https://pdfs.semanticscholar.org/2de1/e05b22889171425bca873a66fd9f19ecda0c.pdf> (19 pages).

US 10,341,838 B2

Page 6

(56)

References Cited

OTHER PUBLICATIONS

Griswold, W. et al. "ActiveCampus—Experiments in Community-Oriented Ubiquitous Computing," University of California at San Diego, published no later than Oct. 2004, available at <https://cseweb.ucsd.edu/~wgg/Abstracts/ac-handhelds.pdf> (8 pages).

Griswold, W. et al. "Using Mobile Technology to Create Opportunistic Interactions on a University Campus" Technical Report CS2002-0724, University of California at San Diego, Sep. 2002, available at: <http://citeseerx.ist.psu.edu/viewdoc/download?doi=10.1.1.14.8249&rep=rep1&type=pdf> (6 pages).

Hatfield, Dale N. "A Report on Technical and Operational Issues Impacting the Provision of Wireless Enhanced 911 Services," provided to the Federal Communications Commission on Oct. 15, 2002, (54 pages).

Horzepa, S. "APRS: Moving Hams on Radio and the Internet; A Guide to the Automatic Reporting System," The American Radio Relay League, Inc., copyright 2004 (156 pages).

Horzepa, S. "High-Speed Digital and Multimedia Working Group Is On," QST, Jun. 2002 (1 page).

Ion, Florence. "From touch displays to the Surface: A brief history of touchscreen technology," Arstechnica, <https://arstechnica.com/gadgets/2013/04/from-touch-displays-to-the-surface-a-brief-history-of-touchscreen-technology/>, Apr. 4, 2013 (22 pages).

IPR2018-00817, Petition for Inter Partes Review of U.S. Pat. No. 9,445,251, filed on behalf of Apple Inc., Mar. 22, 2018 (85 pages).

IPR2018-00818, Petition for Inter Partes Review of U.S. Pat. No. 9,408,055, filed on behalf of Apple, Inc., Mar. 22, 2018 (86 pages).

IPR2018-00819, Petition for Inter Partes Review of U.S. Pat. No. 9,467,838, filed on behalf of Apple, Inc., Mar. 22, 2018 (91 pages).

IPR2018-00821, Petition for Inter Partes Review of U.S. Pat. No. 8,213,970, filed on behalf of Apple, Inc., Mar. 22, 2018 (85 pages).

IPR2018-01079, Petition for Inter Partes Review of U.S. Pat. No. 8,213,970, filed on behalf of Google, LLC, May 15, 2018 (89 pages).

IPR2018-01080, Petition for Inter Partes Review of U.S. Pat. No. 9,408,055, filed on behalf of Google LLC, May 15, 2018 (87 pages).

IPR2018-01081, Petition for Inter Partes Review of U.S. Pat. No. 9,445,251, filed on behalf of Google, LLC, May 15, 2018 (64 pages).

IPR2018-01082, Petition for Inter Partes Review of U.S. Pat. No. 9,445,251, filed on behalf of Google, LLC, May 15, 2018 (72 pages).

IPR2018-01083, Petition for Inter Partes Review of U.S. Pat. No. 9,445,251, filed on behalf of Google, LLC, May 15, 2018 (72 pages).

IPR2018-01084, Petition for Inter Partes Review of U.S. Pat. No. 9,445,251, filed on behalf of Google, LLC, May 15, 2018 (82 pages).

IPR2018-01085, Petition for Inter Partes Review of U.S. Pat. No. 9,467,838, filed on behalf of Google, LLC, May 15, 2018 (76 pages).

IPR2018-01086, Petition for Inter Partes Review of U.S. Pat. No. 9,467,838, filed on behalf of Google, LLC, May 15, 2018 (82 pages).

IPR2018-01087, Petition for Inter Partes Review of U.S. Pat. No. 9,467,838, filed on behalf of Google, LLC, May 15, 2018 (76 pages).

IPR2018-01088, Petition for Inter Partes Review of U.S. Pat. No. 9,467,838, filed on behalf of Google, LLC, May 15, 2018 (83 pages).

Klabunde, Tim. "The Benefits of a VoIP Dispatch System," Mission Critical Communications, Aug. 2004 (3 pages).

Lehman, J. "APRS and Search and Rescue," QST, Sep. 2003 (3 pages).

Lehman, J. "ARPS and Search and Rescue—Part 2," QST, Oct. 2003 (3 pages).

McKinsey & Company. "Untitled Report," 2002 (133 pages).

Mock, John H. et al. "A voice over IP solution for mobile radio interoperability," In Proceedings of IEEE 56th Vehicular Technology Conference, Sep. 2002 (4 pages).

Perkins, Charles E. "Ad Hoc Networking, An Introduction," Nokia Research Center, Nov. 28, 2000 (28 pages).

Rashbaum, William K. "Report on 9/11 Finds Flaws in Response of Police Dept.," Jul. 27, 2002, available at <https://www.nytimes.com/2002/07/27/nyregion/report-on-9-11-finds-flaws-in-response-of-police-dept.html> (4 pages).

Rotondo, Rick. "Locate—Track—Extract, Wireless Mesh Networking Allows Commanders to Keep Track of Firefighters at an Incident Scene," Public Safety Report, Mar. 2004 (3 pages).

Shareloc's Blog. "In Case You Were Wondering, We've Been Working . . .," Navizon.com, available as of Feb. 20, 2006 according to Wayback Machine Internet Archive Record, obtained from: <https://web.archive.org/web/20060220062317/http://navizon.typepad.com:80/> (7 pages).

Sharp, Duncan Scott. "Adapting Ad Hoc Network Concepts to Land Mobile Radio Systems," Thesis, Master of Engineering, University of Alberta, copyright Dec. 2002 (98 pages).

Simon, S. "The Pocket PC Goes Tactical," Law Enforcement Technology, May 2006, obtained from: https://web.archive.org/web/20070807202413/http://www.agisinc.com/Eprint_AGIS_4pg.pdf (4 pages).

Subbarao, Madhavi. "Mobile Ad Hoc Data Networks for Emergency Preparedness Telecommunications—Dynamic Power-Conscious Routing Concepts," Wireless Communications Technologies Group, Submitted as an interim project report on Feb. 1, 2000 (16 pages).

The ActiveCampus System, alleged in adverse proceedings to have been made available to the public no later than Oct. 30, 2005 by the University of California San Diego.

The AGIS LifeRing Project and its prototypes, alleged in adverse proceedings to have been made available to the public by Oct. 30, 2005 by AGIS.

The AT&T Find Friends System, alleged in adverse proceedings to have been made available to the public no later than Jun. 24, 2002 by AT&T.

The Automatic Packet/Position Reporting System, alleged in adverse proceedings to have been made available to the public no later than Sep. 21, 2004 by Bob Bruninga.

The BuddySpace system, alleged in adverse proceedings to have been made available to the public at least by Jun. 2002 and no later than Sep. 21, 2004 by the Open University.

The Force XXI Battle Command, Brigade and Below System, alleged in adverse proceedings to have been made available to the public no later than Mar. 21, 2003 by the U.S. Army.

The Navizon System, alleged in adverse proceedings to have been made available to the public at least by Oct. 30, 2005 and no later than Feb. 20, 2006 by Navizon Inc.

Trupiano, Michael. "A Taxonomy for Assessing Fitness of Mobile Data Services in US Consumer Markets," Thesis, Master of Engineering, submitted to Massachusetts Institute of Technology on Feb. 1, 2001 (105 pages).

Vogiazou, Y. et al. "BuddySpace: Large-Scale Presence for Communities at Work and Play," Tech Report KMi-03-14, dated Sep. 2003 (8 pages).

Vogiazou, Y. et al. "From Buddyspace to CitiTag: Large-Scale Symbolic Presence for Community Building and Spontaneous Play," Tech Report KMi-04-25, dated Nov. 2004 (8 pages).

Vriendt, Johan De. et al. "Mobile Network Evolution: A Revolution on the Move," IEEE Communications Magazine, Apr. 2002 (8 pages).

Defendant's Disclosure Pursuant to Patent Local Rule 4-2 of Preliminary Claim Constructions and Extrinsic Evidence, filed in *AGIS Software Development LLC v. Huawei Device USA Inc. et al. (E.D. Texas)*, May 18, 2018 (27 pages).

P.R. R 4-3—Joint Claim Construction and Prehearing Statement, filed in *AGIS Software Development LLC v. Huawei Device USA, Inc.* on Jun. 15, 2018 (9 pages).

Appendix 1 to P.R. 4-3—Joint Claim Construction and Prehearing Statement—Parties' Proposed Constructions and Supporting Evidence, filed in *AGIS Software Development LLC v. Huawei Device USA, Inc.* on Jun. 15, 2018 (131 pages).

US 10,341,838 B2

Page 7

(56)

References Cited

OTHER PUBLICATIONS

Patent Owner's Preliminary Response, filed in IPR 2018-00817 (*Apple Inc. v. AGIS Software Development LLC*; U.S. Pat. No. 9,445,251), Jul. 5, 2018 (53 pages).

Patent Owner's Preliminary Response, filed in IPR 2018-00818 (*Apple Inc. v. AGIS Software Development LLC*; U.S. Pat. No. 9,408,055), Jul. 5, 2018 (38 pages).

Patent Owner's Preliminary Response, filed in IPR 2018-00821 (*Apple Inc. v. AGIS Software Development LLC*; U.S. Pat. No. 8,213,970), Jul. 24, 2018 (50 pages).

P.R. R 4-3—Updated Joint Claim Construction and Prehearing Statement, filed in *AGIS Software Development LLC v. Huawei Device USA, Inc.* on Jul. 23, 2018 (9 pages).

Appendix 1 to P.R. 4-3—Updated Joint Claim Construction and Prehearing Statement—Parties' Proposed Constructions and Supporting Evidence, filed in *AGIS Software Development LLC v. Huawei Device USA, Inc.* on Jul. 23, 2018 (125 pages).

Petitioner's Motion Under 37 C.F.R. § 42.104(C) to Correct Clerical Errors in the Petition, IPR2018-01088 (*Google LLC v. AGIS Software Development LLC*; U.S. Pat. No. 9,467,838), Oct. 31, 2018 (7 pages).

3G TS 23.040 V1.0.0 (May 1999) Technical Specification (p. 6); Exhibit 20 to Defendants' Responsive Claim Construction Brief, filed in *AGIS Software Development LLC v. Huawei Device USA Inc. et al. (E.D. Texas)*, Document 175-21 in Case 2:17-cv-513, Aug. 14, 2018 (4 pages).

Appendix A: Comparison of Method and "Device" Claims; Attachment #24 to Defendants' Responsive Claim Construction Brief, filed in *AGIS Software Development LLC v. Huawei Device USA Inc. et al. (E.D. Texas)*, Document 175-24 in Case 2:17-cv-513, Aug. 14, 2018 (7 pages).

Appendix A: Joint Claim Construction Chart; Attachment #1 to Joint Claim Construction Chart Pursuant to P.R. 4-5(D), filed in *AGIS Software Development LLC v. Huawei Device USA Inc. et al. (E.D. Texas)*, Document 194 in Case 2:17-cv-513, Aug. 27, 2018 (118 pages).

Appendix B: Comparison of '838 Patent Disclosures and Similar Disclosures in '728 Patent; Attachment #25 to Defendants' Responsive Claim Construction Brief, filed in *AGIS Software Development LLC v. Huawei Device USA Inc. et al. (E.D. Texas)*, Document 175-25 in Case 2:17-cv-513, Aug. 14, 2018 (3 pages).

Apple Computer, Inc. Macintosh Human Interface Guidelines, 1992 (410 pages); Exhibit 1009 in IPR2018-00821 (*Apple Inc. v. AGIS Software Development LLC*; U.S. Pat. No. 8,213,970).

Apple Inc.'s Final Election of Prior Art References, *AGIS Software Development LLC v. Apple Inc. (E.D. Texas)*, 2:17-cv-513, Aug. 29, 2018 (15 pages).

Apple's Answer to AGIS's Original Complaint for Patent Infringement, filed in *AGIS Software Development LLC v. Apple Inc. (E.D. Texas)*, Document 20 in Case 2:17-cv-516, Aug. 28, 2017 (14 pages).

Apple's Answer to Plaintiff's First Amended Complaint for Patent Infringement, filed in *AGIS Software Development LLC v. Apple Inc. (E.D. Texas)*, Document 36 in Case 2:17-cv-516, Oct. 2, 2017 (16 pages).

Apple's First Amended Answer to Plaintiff's First Amended Complaint for Patent Infringement, filed in *AGIS Software Development LLC v. Huawei Device USA Inc. et al. (E.D. Texas)*, Document 148 in Case 2:17-cv-513, Jun. 15, 2018 (23 pages).

D. Ball et al. How to Do Everything with Your Treo 600, 2004 (pp. 25-30); Exhibit 1019 in IPR2018-00821.

Bederson, Benjamin B. Fisheye Menus. Proceedings of the ACM Symposium on User Interface Software and Technology, 2000 (pp. 217-225); Exhibit 1015 in IPR2018-00821.

Claim Construction Hearing Before the Honorable Chief Judge Rodney Gilstrap (United States District Judge), *AGIS Software Development LLC v. Huawei Device USA Inc. et al. (E.D. Texas)*, 2:17-cv-513, Sep. 13, 2018 (109 pages).

Claim Construction Memorandum and Order, issued in *AGIS Software Development LLC v. Huawei Device USA Inc., et al. (E.D. Texas)*, Document 205 in Case 2:17-cv-513, Oct. 10, 2018; also Exhibit 1041 in IPR2018-01080 (60 pages).

Claim Construction Order, issued in *Automated Packaging Systems, Inc. v. Free Flow Packaging International, Inc. (N. D. Cal.)*, Document 217 in Case 3:18-cv-356, Aug. 2, 2018 (44 pages); Exhibit 1025 in IPR2018-00817.

Corrected Petition for Inter Partes Review of U.S. Pat. No. 9,467,838, IPR2018-01087 (*Google LLC v. AGIS Software Development LLC*; U.S. Pat. No. 9,467,838), Oct. 31, 2018 (76 pages).

Corrected Petition for Inter Partes Review of U.S. Pat. No. 9,467,838, IPR2018-01088 (*Google LLC v. AGIS Software Development LLC*; U.S. Pat. No. 9,467,838), Oct. 31, 2018 (83 pages).

Decision Denying Institution of Inter Partes Review, IPR2018-00821 (*Apple Inc. v. AGIS Software Development LLC*; U.S. Pat. No. 8,213,970), Oct. 23, 2018 (35 pages).

Decision: Institution of Inter Partes Review, IPR2018-00819 (*Apple Inc. v. AGIS Software Development LLC*; U.S. Pat. No. 9,467,838), Nov. 7, 2018 (38 pages).

Declaration of Chris G. Bartone, Ph.D., P.E. in Support of Defendants Huawei Device USA Inc. et al.'s Responsive Claim Construction Brief; Attachment #23 to Defendants' Responsive Claim Construction Brief, filed in *AGIS Software Development LLC v. Huawei Device USA Inc. et al. (E.D. Texas)*, Document 175-23 in Case 2:17-cv-513, Aug. 14, 2018 (105 pages).

Declaration of David Hilliard Williams in Support of Petition for Inter Partes Review of U.S. Pat. No. 8 213 970. Exhibit J to Plaintiff AGIS Software Development LLC's Opening Claim Construction Brief, filed in *AGIS Software Development LLC v. Huawei Device USA Inc. et al. (E.D. Texas)*, Case 2:17-cv-513, Jul. 26, 2018 (124 pages).

Declaration of David Hilliard Williams in Support of Petition for Inter Partes Review of U.S. Pat. No. 9,408,055; Exhibit 1003 in IPR2018-01080 (*Google LLC v. AGIS Software Development LLC*; U.S. Pat. No. 9,408,055), May 15, 2018 (138 pages).

Declaration of David Hilliard Williams in Support of Petition for Inter Partes Review of U.S. Pat. No. 9,445,251; Exhibit 1003 in IPR2018-01081 (*Google LLC v. AGIS Software Development LLC*; U.S. Pat. No. 9,445,251), May 15, 2018 (93 pages).

Declaration of David Hilliard Williams in Support of Petition for Inter Partes Review of U.S. Pat. No. 9,445,251; Exhibit 1003 in IPR2018-01082 (*Google LLC v. AGIS Software Development LLC*; U.S. Pat. No. 9,445,251), May 15, 2018 (102 pages).

Declaration of David Hilliard Williams in Support of Petition for Inter Partes Review of U.S. Pat. No. 9,445,251; Exhibit 1003 in IPR2018-01083 (*Google LLC v. AGIS Software Development LLC*; U.S. Pat. No. 9,445,251), May 15, 2018 (105 pages).

Declaration of David Hilliard Williams in Support of Petition for Inter Partes Review of U.S. Pat. No. 9,445,251; Exhibit 1003 in IPR2018-01084 (*Google LLC v. AGIS Software Development LLC*; U.S. Pat. No. 9,445,251), May 15, 2018 (116 pages).

Declaration of David Hilliard Williams in Support of Petition for Inter Partes Review of U.S. Pat. No. 9,467,838; Exhibit 1003 in IPR2018-01085 (*Google LLC v. AGIS Software Development LLC*; U.S. Pat. No. 9,467,838), May 15, 2018 (102 pages).

Declaration of David Hilliard Williams in Support of Petition for Inter Partes Review of U.S. Pat. No. 9,467,838; Exhibit 1003 in IPR2018-01086 (*Google LLC v. AGIS Software Development LLC*; U.S. Pat. No. 9,467,838), May 15, 2018 (111 pages).

Declaration of David Hilliard Williams in Support of Petition for Inter Partes Review of U.S. Pat. No. 9,467,838; Exhibit 1003 in IPR2018-01087 (*Google LLC v. AGIS Software Development LLC*; U.S. Pat. No. 9,467,838), May 15, 2018 (106 pages).

Declaration of David Hilliard Williams in Support of Petition for Inter Partes Review of U.S. Pat. No. 9,467,838; Exhibit 1003 in IPR2018-01088 (*Google LLC v. AGIS Software Development LLC*; U.S. Pat. No. 9,467,838), May 15, 2018 (125 pages).

Declaration of Dr. Benjamin B. Bederson in Support of Petition for Inter Partes Review of U.S. Pat. No. 9,445,251, Exhibit 1002 in IPR2018-00817 (*Apple Inc. v. AGIS Software Development LLC*; U.S. Pat. No. 9,445,251), Mar. 22, 2018 (153 pages).

US 10,341,838 B2

Page 8

(56)

References Cited

OTHER PUBLICATIONS

Declaration of Dr. Benjamin B. Bederson in Support of Petition for Inter Partes Review of U.S. Pat. No. 9,408,055, Exhibit 1002 in IPR2018-00818 (*Apple Inc. v. AGIS Software Development LLC*; U.S. Pat. No. 9,408,055), Mar. 22, 2018 (115 pages).

Declaration of Dr. Benjamin B. Bederson in Support of Petition for Inter Partes Review of U.S. Pat. No. 9,467,838, Exhibit 1002 in IPR2018-00819 (*Apple Inc. v. AGIS Software Development LLC*; U.S. Pat. No. 9,467,838), Mar. 22, 2018 (186 pages).

Declaration of Dr. Benjamin B. Bederson in Support of Petition for Inter Partes Review of U.S. Pat. No. 9,749,829, Exhibit 1002 in IPR2018-01471 (*Apple Inc. v. AGIS Software Development LLC*; U.S. Pat. No. 9,749,829), Jul. 31, 2018 (114 pages).

Declaration of Dr. Benjamin Bederson in Support of Petition for Inter Partes Review of U.S. Pat. No. 8 213 970. Exhibit I to Plaintiff AGIS Software Development LLC's Opening Claim Construction Brief, filed in *AGIS Software Development LLC v. Huawei Device USA Inc. et al.* (E.D. Texas), Case 2:17-cv-513, Jul. 26, 2018 (148 pages).

Declaration of Dr. Jaime G. Carbonell in Support of Plaintiff's Opening Claim Construction Brief; Exhibit H to Plaintiff AGIS-Software Development LLC's Opening Claim Construction Brief, filed in *AGIS Software Development LLC v. Huawei Device USA Inc. et al.* (E.D. Texas), Document 16510 in Case 2:17-cv-513, Jul. 26, 2018 (43 pages).

Declaration of Kerri-Ann Limbeed in Support of Defendants' Responsive Claim Construction Brief; Attachment #1 to Defendants' Responsive Claim Construction Brief, filed in *AGIS Software Development LLC v. Huawei Device USA Inc. et al.* (E.D. Texas), Document 175-1 in Case 2:17-cv-513, Aug. 14, 2018 (4 pages).

Defendant Apple's Amended Patent Rule 3-3 Invalidity Contentions, *AGIS Software Development LLC v. Huawei Device USA Inc. et al.* (E.D. Texas), 2:17-cv-513, Apr. 16, 2018 (49 pages).

Defendant LG Electronics Inc.'s Answer to Plaintiff's Complaint for Patent Infringement, filed in *AGIS Software Development LLC v. LG Electronics, Inc.* (E.D. Texas), Document 83 in Case 2:17-cv-514, Oct. 12, 2018 (22 pages).

Defendants Huawei Device USA Inc. et al.'s Answer to Plaintiff's First Amended Complaint for Patent Infringement, filed in *AGIS Software Development LLC v. Huawei Device USA Inc. et al.* (E.D. Texas), Document 29 in Case 2:17-cv-513, Oct. 5, 2017 (20 pages).

Defendants Huawei Device USA Inc. et al.'s Preliminary Election of Prior Art References, *AGIS Software Development LLC v. Huawei Device USA Inc. et al.* (E.D. Texas), 2:17-cv-513, Apr. 30, 2018 (7 pages).

Defendants' Responsive Claim Construction Brief, filed in *AGIS Software Development LLC v. Huawei Device USA Inc. et al.* (E.D. Texas), Document 175 in Case 2:17-cv-513, Aug. 14, 2018 (56 pages).

Exhibit 1009 in IPR2018-01081 ("Microsoft Word document compare of specifications between U.S. Pat. No. 7,630,724 to Beyer, Jr. et al. and U.S. Pat. No. 7,031,728 to Beyer, Jr. et al."), May 15, 2018 (33 pages)10.

Exhibit 1010 ("Computer-generated document comparison showing differences in U.S. Appl. No. 11/711,490 and U.S. Appl. No. 11/308,648") in IPR2018-00817, Mar. 22, 2018 (94 pages).

Exhibit 1011 ("Computer-generated document comparison showing differences in U.S. Appl. No. 11/308,648 and U.S. Appl. No. 11/615,472") in IPR2018-00817, Mar. 22, 2018 (122 pages).

Exhibit 1012 ("Computer-generated document comparison showing differences in U.S. Appl. No. 11/615,472 and U.S. Appl. No. 12/761,533") in IPR2018-00817, Mar. 22, 2018 (94 pages).

Exhibit 1017 ("Computer-generated document comparison showing differences in U.S. Appl. No. 14/027,410 and U.S. Appl. No. 11/308,648") in IPR2018-00817, Mar. 22, 2018 (117 pages).

Exhibit 1020 in IPR2018-00821 ("Redline comparison between the specifications of U.S. Appl. No. 11/612,830 and U.S. Pat. No. 8,213,970"), Mar. 22, 2018 (90 pages).

Exhibit 1031 in IPR2018-01087 (*Google LLC v. AGIS Software Development LLC*; U.S. Pat. No. 9,467,838), Transcript of teleconference between Board and Parties, Oct. 26, 2018 (22 pages).

Exhibit 1032 in IPR2018-01087 (*Google LLC v. AGIS Software Development LLC*; U.S. Pat. No. 9,467,838), Document showing differences between Petition and Corrected Petition in redline, Oct. 31, 2018 (77 pages).

Exhibit 1032 in IPR2018-01088 (*Google LLC v. AGIS Software Development LLC*; U.S. Pat. No. 9,467,838), Document showing differences between Petition and Corrected Petition in redline, Oct. 31, 2018 (84 pages).

Exhibit A for U.S. Pat. No. 8,213,970 Against Apple Accused Products; Attachment to Plaintiff's Preliminary Infringement Contentions in *AGIS Software Development LLC v. Apple, Inc.* (E.D. Texas), Case 2:17-cv-516, also Exhibit 1008 in IPR2018-00821, Mar. 22, 2018 (39 pages).

Exhibit A for U.S. Pat. No. 8,213,970 Against HTC Accused Products; Attachment to Plaintiff's Disclosure of Asserted Claims and Infringement Contentions in *AGIS Software Development LLC v. HTC Corp.* (E.D. Texas), 2:17-cv-514, Jan. 19, 2018 (42 pages).

Exhibit A for U.S. Pat. No. 8,213,970 Against Huawei Accused Products; Attachment to Plaintiff's Disclosure of Asserted Claims and Infringement Contentions in *AGIS Software Development LLC v. Huawei Device USA Inc. et al.* (E.D. Texas), Case 2:17-cv-513, Nov. 28, 2017 (36 pages).

Exhibit A for U.S. Pat. No. 8,213,970 Against LG Accused Products; Attachment to Plaintiff's Disclosure of Asserted Claims and Infringement Contentions in *AGIS Software Development LLC v. LG Electronics, Inc.* (E.D. Texas), 2:17-cv-515, Nov. 28, 2017 (36 pages).

Exhibit A for U.S. Pat. No. 8,213,970 Against ZTE Accused Products; Attachment to Plaintiff's Disclosure of Asserted Claims and Infringement Contentions in *AGIS Software Development LLC v. ZTE Corp et al.* (E.D. Texas), 2:17-cv-517, Jan. 19, 2018 (41 pages).

Exhibit B for U.S. Pat. No. 9,408,055 Against HTC Accused Products; Attachment to Plaintiff's Disclosure of Asserted Claims and Infringement Contentions in *AGIS Software Development LLC v. HTC Corp.* (E.D. Texas), 2:17-cv-514, Jan. 19, 2018 (979 pages).

Exhibit B for U.S. Pat. No. 9,408,055 Against HUAWEI Accused Products; Attachment to Plaintiff's Infringement Contentions in *AGIS Software Development LLC v. Huawei Device USA Inc., et al.* (E.D. Texas), Case 2:17-cv-513; also Exhibit 1010 in IPR2018-01080, May 15, 2018 (889 pages).

Exhibit B for U.S. Pat. No. 9,408,055 Against LG Accused Products; Attachment to Plaintiff's Disclosure of Asserted Claims and Infringement Contentions in *AGIS Software Development LLC v. LG Electronics, Inc.* (E.D. Texas), 2:17-cv-515, Nov. 28, 2017 (902 pages).

Exhibit B for U.S. Pat. No. 9,408,055 Against ZTE Accused Products; Attachment to Plaintiff's Disclosure of Asserted Claims and Infringement Contentions in *AGIS Software Development LLC v. ZTE Corp et al.* (E.D. Texas), 2:17-cv-517, Jan. 19, 2018 (1001 pages).

Exhibit C for U.S. Pat. No. 9,445,251 Against Apple Accused Products; Attachment to Plaintiff's Preliminary Infringement Contentions in *AGIS Software Development LLC v. Apple, Inc.* (E.D. Texas), Case 2:17-cv-516; also Exhibit 1014 in IPR2018-00817, Mar. 22, 2018 (120 pages).

Exhibit C for U.S. Pat. No. 9,445,251 Against HTC Accused Products; Attachment to Plaintiff's Disclosure of Asserted Claims and Infringement Contentions in *AGIS Software Development LLC v. HTC Corp.* (E.D. Texas), 2:17-cv-514, Jan. 19, 2018 (313 pages).

Exhibit C for U.S. Pat. No. 9,445,251 Against Huawei Accused Products; Attachment to Plaintiff's Disclosure of Asserted Claims and Infringement Contentions in *AGIS Software Development LLC v. Huawei Device USA Inc. et al.* (E.D. Texas), Case 2:17-cv-513, Nov. 28, 2017 (314 pages).

Exhibit C for U.S. Pat. No. 9,445,251 Against LG Accused Products; Attachment to Plaintiff's Disclosure of Asserted Claims and Infringement Contentions in *AGIS Software Development LLC v. LG Electronics, Inc.* (E.D. Texas), 2:17-cv-515, Nov. 28, 2017 (335 pages).

US 10,341,838 B2

Page 9

(56)

References Cited

OTHER PUBLICATIONS

Exhibit C for U.S. Pat. No. 9,445,251 Against ZTE Accused Products; Attachment to Plaintiff's Disclosure of Asserted Claims and Infringement Contentions in *AGIS Software Development LLC v. ZTE Corp et al. (E.D. Texas)*, 2:17-cv-517, Jan. 19, 2018 (314 pages).

Exhibit D—Claim Chart for U.S. Pat. No. 9,467,838 Against Apple Accused Products; Attachment to Plaintiff's Preliminary Infringement Contentions in *AGIS Software Development LLC v. Apple, Inc. (E.D. Texas)*, Case 2:17-cv-516; also Exhibit 1014 in IPR2018-00819, Mar. 22, 2018 (381 pages).

Exhibit D—Claim Chart for U.S. Pat. No. 9,467,838 Against HTC; Attachment to Plaintiff's Disclosure of Asserted Claims and Infringement Contentions in *AGIS Software Development LLC v. HTC Corp. (E.D. Texas)*, 2:17-cv-514, Jan. 19, 2018 (329 pages).

Exhibit D—Claim Chart for U.S. Pat. No. 9,467,838 Against Huawei; Attachment to Plaintiff's Disclosure of Asserted Claims and Infringement Contentions in *AGIS Software Development LLC v. Huawei Device USA Inc. et al. (E.D. Texas)*, Case 2:17-cv-513, Nov. 28, 2017 (312 pages).

Exhibit D—Claim Chart for U.S. Pat. No. 9,467,838 Against LG; Attachment to Plaintiff's Disclosure of Asserted Claims and Infringement Contentions in *AGIS Software Development LLC v. LG Electronics, Inc. (E.D. Texas)*, 2:17-cv-515, Nov. 28, 2017 (329 pages).

Exhibit D—Claim Chart for U.S. Pat. No. 9,467,838 Against ZTE; Attachment to Plaintiff's Disclosure of Asserted Claims and Infringement Contentions in *AGIS Software Development LLC v. ZTE Corp et al. (E.D. Texas)*, 2:17-cv-517, Jan. 19, 2018 (329 pages).

GeoTIFF Format Specification, GeoTIFF Revision 1.0, Specification Version 1.8.1, Oct. 31, 1995 (102 pages); Exhibit 1018 in IPR2018-00817.

Hornbaek, K. et al. Navigation Patterns and Usability of Zoomable User Interfaces with and without an Overview. *ACM Transactions on Computer-Human Interaction*, v. 9, n. 4, Dec. 2002 (pp. 362-369); Exhibit 1019 in IPR2018-00817.

HTC Corporation et al.'s Prior Art Listed in Their Invalidity Contentions, *AGIS Software Development LLC v. HTC Corporation et al. (E.D. Texas)*, Case 2:17-cv-514, Aug. 30, 2018 (7 pages).

HTC Corporation's Answer, Defenses, and Counterclaims to AGIS Software Development, LLC's Complaint for Patent Infringement, filed in *AGIS Software Development LLC v. HTC Corp. Inc. (E.D. Texas)*, Document 82 in Case 2:17-cv-514, Oct. 12, 2018 (19 pages).

HTC Corporation's Preliminary Election of Prior Art References, *AGIS Software Development LLC v. Huawei Device USA Inc. et al. (E.D. Texas)*, 2:17-cv-514, Apr. 30, 2018 (6 pages).

Index of Exhibits to Apple's Invalidity Contentions, *AGIS Software Development LLC v. LG Electronics, Inc. et al. (E.D. Texas)*, Case 2:17-cv-516, Dec. 1, 2017 (11 pages).

Joint Claim Construction Chart Pursuant to P.R. 4-5(D), filed in *AGIS Software Development LLC v. Huawei Device USA Inc. et al. (E.D. Texas)*, Document 194 in Case 2:17-cv-513, Aug. 27, 2018 (4 pages).

Joint Motion to Stay All Deadlines and Notice of Settlement Regarding Huawei Defendants, filed in *AGIS Software Development LLC v. Huawei Device USA Inc. et al. (E.D. Texas)*, Document 221 in Case 2:17-cv-513, Nov. 5, 2018 (6 pages).

MapInfo Professional User's Guide Version 7.0, 2002 (752 pages); Exhibit 1021 in IPR2018-00817.

MapInfo. Spatially Enhancing Business Data with Geocoding Solutions: A MapInfo White Paper, 1997 (15 pages); Exhibit 1020 in IPR2018-00817.

Microsoft Computer Dictionary, Fifth Edition, 2002 (p. 479); Exhibit 21 to Defendants' Responsive Claim Construction Brief, filed in *AGIS Software Development LLC v. Huawei Device USA Inc. et al. (E.D. Texas)*, Document 175-22 in Case 2:17-cv-513, Aug. 14, 2018 (5 pages).

Microsoft Computer Dictionary, Fifth Edition, 2002 (p. 502); Exhibit 12 to Defendants' Responsive Claim Construction Brief, filed in *AGIS Software Development LLC v. Huawei Device USA Inc. et al. (E.D. Texas)*, Document 175-13 in Case 2:17-cv-513, Aug. 14, 2018 (4 pages).

Mockapetris, P. Network Working Group of Internet Engineering Task Force, Request for Comments 1034, Domain Names—Concepts and Facilities, Nov. 1987 (55 pages); Exhibit 1024 in IPR2018-00817.

Nielsen, J. Usability Engineering, 1993 (pp. 129-148); Exhibit 1017 in IPR2018-00821.

Norman, Donald A. The Psychology of Everyday Things, Chapter 1, The Psychopathology of Everyday Things, 1999 (pp. 1-33); Exhibit 1016 in IPR2018-00821.

Oxford American Dictionary of Current English, 1999 (p. 213); Exhibit 3 to Defendants' Responsive Claim Construction Brief, filed in *AGIS Software Development LLC v. Huawei Device USA Inc. et al. (E.D. Texas)*, Document 175-4 in Case 2:17-cv-513, Aug. 14, 2018 (5 pages).

Patent Owner's Supplemental Preliminary Response to Corrected Petition for Inter Partes Review, IPR2018-01087 (*Google LLC v. AGIS Software Development LLC*; U.S. Pat. No. 9,467,838), Nov. 7, 2018 (6 pages).

Patent Owner's Supplemental Preliminary Response to Corrected Petition for Inter Partes Review, IPR2018-01088 (*Google LLC v. AGIS Software Development LLC*; U.S. Pat. No. 9,467,838), Nov. 7, 2018 (6 pages).

Petitioner's Motion Under 37 C.F.R. § 42.104(C) to Correct Clerical Errors in the Petition, IPR2018-01087 (*Google LLC v. AGIS Software Development LLC*; U.S. Pat. No. 9,467,838), Oct. 31, 2018 (7 pages).

Petitioner's Reply to Patent Owner Preliminary Response, IPR2018-01083 (*Google LLC v. AGIS Software Development LLC*; U.S. Pat. No. 9,445,251), Nov. 1, 2018 (9 pages).

Petitioner's Reply to Patent Owner Preliminary Response, IPR2018-01085 (*Google LLC v. AGIS Software Development LLC*; U.S. Pat. No. 9,467,838), Sep. 19, 2018 (9 pages).

Petitioner's Reply to Patent Owner Preliminary Response, IPR2018-01087 (*Google LLC v. AGIS Software Development LLC*; U.S. Pat. No. 9,467,838), Nov. 1, 2018 (6 pages).

Plaintiff / Counterclaim-Defendant AGIS Software Development LLC Answer to Declaratory Judgment Counterclaims of Defendant / Counterclaim-Plaintiff HTC Corporation, filed in *AGIS Software Development LLC v. HTC Corp. et al. (E.D. Texas)*, Document 86 in Case 2:17-cv-514, Nov. 2, 2018 (8 pages).

Plaintiff AGIS Software Development LLC's Opening Claim Construction Brief, filed in *AGIS Software Development LLC v. Huawei Device USA Inc. et al. (E.D. Texas)*, Document 165 in Case 2:17-cv-513, Jul. 26, 2018 (41 pages).

Plaintiff AGIS Software Development LLC's Reply Claim Construction Brief, filed in *AGIS Software Development LLC v. Huawei Device USA Inc. et al. (E.D. Texas)*, Document 186 in Case 2:17-cv-513, Aug. 20, 2018 (29 pages).

Plaintiff's Disclosure of Asserted Claims and Infringement Contentions, *AGIS Software Development LLC v. Apple, Inc. (E.D. Texas)*, Case 2:17-cv-516, Sep. 18, 2017; also Exhibit 1016 in IPR2018-00817 (12 pages).

Plaintiff's Disclosure of Asserted Claims and Infringement Contentions, *AGIS Software Development LLC v. Huawei Device USA Inc. et al. (E.D. Texas)*, 2:17-cv-513, Nov. 28, 2017 (18 pages).

Plaintiff's Disclosure of Asserted Claims and Infringement Contentions, *AGIS Software Development LLC v. LG Electronics, Inc. (E.D. Texas)*, 2:17-cv-515, Nov. 28, 2017 (16 pages).

Plaintiff's Disclosure of Asserted Claims and Infringement Contentions, *AGIS Software Development LLC v. HTC Corp. (E.D. Texas)*, 2:17-cv-514, Jan. 19, 2018 (23 pages).

Plaintiff's Disclosure of Asserted Claims and Infringement Contentions, *AGIS Software Development LLC v. ZTE Corp et al. (E.D. Texas)*, 2:17-cv-517, Jan. 19, 2018 (20 pages).

Plaintiff's Disclosure of Asserted Claims and Infringement Contentions, *AGIS Software Development LLC v. ZTE Corp et al. (E.D. Texas)*, 2:17-cv-517, Aug. 28, 2018 (21 pages).

US 10,341,838 B2

Page 10

(56)

References Cited

OTHER PUBLICATIONS

Plaintiff's First Amended Complaint for Patent Infringement, filed in *AGIS Software Development LLC v. Apple, Inc. (E.D. Texas)*, Document 32 in Case 2:17-cv-516, Sep. 18, 2017; also Exhibit 1013 in IPR2018-00817 (33 pages).

Plaintiff's First Amended Complaint for Patent Infringement, filed in *AGIS Software Development LLC v. Huawei Device USA Inc. et al. (E.D. Texas)*, Document 32 in Case 2:17-cv-513, Aug. 17, 2017 (26 pages).

Plaintiff's First Amended Complaint for Patent Infringement, filed in *AGIS Software Development LLC v. ZTE Corp. et al. (E.D. Texas)*, Document 32 in Case 2:17-cv-517, Oct. 17, 2017 (33 pages).

Plaintiff's Original Complaint for Patent Infringement, filed in *AGIS Software Development LLC v. HTC Corp. (E.D. Texas)*, Document 1 in Case 2:17-cv-514, Jun. 21, 2017; also Exhibit 1015 in IPR2018-00817 (24 pages).

Plaintiff's Original Complaint for Patent Infringement, filed in *AGIS Software Development LLC v. Huawei Device USA Inc., et al. (E.D. Texas)*, Document 2 in Case 2:17-cv-513, Jun. 21, 2017; also Exhibit 1008 in IPR2018-01081 (24 pages).

Plaintiff's Original Complaint for Patent Infringement, filed in *AGIS Software Development LLC v. LG Electronics, Inc. (E.D. Texas)*, Document 1 in Case 2:17-cv-515, Jun. 21, 2017 (24 pages).

Plaintiff's Original Complaint for Patent Infringement, filed in *AGIS Software Development LLC v. Apple, Inc. (E.D. Texas)*, Document 1 in Case 2:17-cv-516, Jun. 21, 2017 (26 pages).

Plaintiff's Original Complaint for Patent Infringement, filed in *AGIS Software Development LLC v. ZTE Corp. et al. (E.D. Texas)*, Document 1 in Case 2:17-cv-517, Jun. 21, 2017 (25 pages).

Prior Art Listed in LG Electronics' Invalidity Contentions, *AGIS Software Development LLC v. LG Electronics, Inc. et al. (E.D. Texas)*, Case 2:17-cv-514, Aug. 30, 2018 (9 pages).

Python Documentation Release 2.0 Homepage, Oct. 16, 2000 (1 page); Exhibit 1022 in IPR2018-00817.

Python Library Reference, Section 7.2 Socket (4 pages); Exhibit 1023 in IPR2018-00817.

Shneiderman, B. *Designing the User Interface: Strategies for Effective Human-Computer Interaction*, Third Edition, 1998 (252 pages); Exhibit 1018 in IPR2018-00821.

Webster's New World Dictionary of Computer Terms, Eighth Edition, 2000 (p. 157); Exhibit 4 to Defendants' Responsive Claim Construction Brief, filed in *AGIS Software Development LLC v. Huawei Device USA Inc. et al. (E.D. Texas)*, Document 175-5 in Case 2:17-cv-513, Aug. 14, 2018 (5 pages).

ZTE (USA) Inc., and ZTE (TX), Inc.'s Second Election of Prior Art References, *AGIS Software Development LLC v. ZTE Corp. et al. (E.D. Texas)*, 2:17-cv-514, Aug. 29, 2018 (7 pages).

Rebuttal Expert Report of Joseph C. McAlexander III Regarding Validity of U.S. Pat. Nos. 8,213,970; 9,408,055; 9,445,251; 9,467,838; and 9,749,829, IPR2018-01471 (*Apple Inc. v. AGIS Software Development LLC*; U.S. Pat. No. 9,749,829), Jan. 10, 2019 (400 pages).

Decision Denying Institution of Inter Partes Review, IPR2018-01083 (*Google LLC v. AGIS Software Development LLC*; U.S. Pat. No. 9,445,251), Jan. 10, 2019 (29 pages).

Decision Denying Institution of Inter Partes Review, IPR2018-01084 (*Google LLC v. AGIS Software Development LLC*; U.S. Pat. No. 9,445,251), Jan. 9, 2019 (27 pages).

Decision Denying Institution of Inter Partes Review, IPR2018-01087 (*Google LLC v. AGIS Software Development LLC*; U.S. Pat. No. 9,467,838), Jan. 9, 2019 (28 pages).

Decision: Institution of Inter Partes Review, IPR2018-01471 (*Apple Inc. v. AGIS Software Development LLC*; U.S. Pat. No. 9,749,829), Feb. 27, 2019 (29 pages).

Order: Conduct of the Proceeding, IPR 2018-01471 (*Apple Inc. v. AGIS Software Development LLC*; U.S. Pat. No. 9,749,829), Jan. 3, 2019 (4 pages).

Petitioner's Reply to Patent Owner's Preliminary Response Pursuant to Board's Order (Paper 7), IPR 2018-01471 (*Apple Inc. v. AGIS Software Development LLC*; U.S. Pat. No. 9,749,829), Jan. 10, 2019 (11 pages).

Patent Owner's Sur-Reply to Petitioner's Reply, IPR 2018-01471 (*Apple Inc. v. AGIS Software Development LLC*; U.S. Pat. No. 9,749,829), Jan. 18, 2019 (9 pages).

Decision Denying Institution of Inter Partes Review, IPR2018-00817 (*Apple Inc. v. AGIS Software Development LLC*; U.S. Pat. No. 9,445,251), Oct. 3, 2018 (34 pages).

Petitioner's Reply to Patent Owner's Preliminary Response, IPR2018-00817 (*Apple Inc. v. AGIS Software Development LLC*; U.S. Pat. No. 9,445,251), Aug. 10, 2018 (7 pages).

Decision Denying Institution of Inter Partes Review, IPR2018-00818 (*Apple Inc. v. AGIS Software Development LLC*; U.S. Pat. No. 9,408,055), Oct. 3, 2018 (33 pages).

Petitioner's Reply to Patent Owner's Preliminary Response, IPR2018-00818 (*Apple Inc. v. AGIS Software Development LLC*; U.S. Pat. No. 9,408,055), Aug. 10, 2018 (7 pages).

Patent Owner's Preliminary Response, IPR2018-00819 (*Apple Inc. v. AGIS Software Development LLC*; U.S. Pat. No. 9,467,838), Aug. 9, 2018 (51 pages).

Petitioner's Reply to Patent Owner's Preliminary Response, IPR2018-00819 (*Apple Inc. v. AGIS Software Development LLC*; U.S. Pat. No. 9,467,838), Aug. 10, 2018 (7 pages).

Petitioner's Reply to Patent Owner's Preliminary Response, IPR2018-00821 (*Apple Inc. v. AGIS Software Development LLC*; U.S. Pat. No. 8,213,970), Aug. 10, 2018 (7 pages).

Patent Owner's Preliminary Response, IPR2018-01079 (*Google LLC v. AGIS Software Development LLC*; U.S. Pat. No. 8,213,970), Aug. 23, 2018 (59 pages).

Petitioner's Reply to Patent Owner Preliminary Response, IPR2018-01079 (*Google LLC v. AGIS Software Development LLC*; U.S. Pat. No. 8,213,970), Sep. 19, 2018 (8 pages).

Patent Owner's Preliminary Response, IPR2018-01080 (*Google LLC v. AGIS Software Development LLC*; U.S. Pat. No. 9,408,055), Sep. 6, 2018 (41 pages).

Petitioner's Reply to Patent Owner Preliminary Response, IPR2018-01080 (*Google LLC v. AGIS Software Development LLC*; U.S. Pat. No. 9,408,055), Oct. 17, 2018 (9 pages).

Patent Owner's Preliminary Response, IPR2018-01081 (*Google LLC v. AGIS Software Development LLC*; U.S. Pat. No. 9,445,251), Sep. 13, 2018 (43 pages).

Petitioner's Reply to Patent Owner Preliminary Response, IPR2018-01081 (*Google LLC v. AGIS Software Development LLC*; U.S. Pat. No. 9,445,251), Sep. 19, 2018 (9 pages).

Patent Owner's Preliminary Response, IPR2018-01082 (*Google LLC v. AGIS Software Development LLC*; U.S. Pat. No. 9,445,251), Aug. 23, 2018 (38 pages).

Petitioner's Reply to Patent Owner Preliminary Response, IPR2018-01082 (*Google LLC v. AGIS Software Development LLC*; U.S. Pat. No. 9,445,251), Sep. 19, 2018 (9 pages).

Patent Owner's Preliminary Response, IPR2018-01083 (*Google LLC v. AGIS Software Development LLC*; U.S. Pat. No. 9,445,251), Oct. 11, 2018 (42 pages).

Motorola Solutions, Dispatch Console Accessories, 2018 (3 pages).

Patent Owner's Preliminary Response, IPR2018-01084 (*Google LLC v. AGIS Software Development LLC*; U.S. Pat. No. 9,445,251), Oct. 11, 2018 (32 pages).

Patent Owner's Preliminary Response, IPR2018-01085 (*Google LLC v. AGIS Software Development LLC*; U.S. Pat. No. 9,467,838), Aug. 23, 2018 (49 pages).

Patent Owner's Preliminary Response, IPR2018-01086 (*Google LLC v. AGIS Software Development LLC*; U.S. Pat. No. 9,467,838), Sep. 6, 2018 (53 pages).

Petitioner's Reply to Patent Owner Preliminary Response, IPR2018-01086 (*Google LLC v. AGIS Software Development LLC*; U.S. Pat. No. 9,467,838), Oct. 17, 2018 (9 pages).

Patent Owner's Preliminary Response, IPR2018-01087 (*Google LLC v. AGIS Software Development LLC*; U.S. Pat. No. 9,467,838), Oct. 11, 2018 (39 pages).

Patent Owner's Preliminary Response, IPR2018-01088 (*Google LLC v. AGIS Software Development LLC*; U.S. Pat. No. 9,467,838), Sep. 12, 2018 (43 pages).

Petitioner's Reply to Patent Owner Preliminary Response, IPR2018-01088 (*Google LLC v. AGIS Software Development LLC*; U.S. Pat. No. 9,467,838), Oct. 17, 2018 (9 pages).

US 10,341,838 B2

Page 11

(56)

References Cited

OTHER PUBLICATIONS

Defendants' Disclosure Pursuant to Patent Local Rule 4-1 of Proposed Terms and Claim Elements for Construction, filed in *AGIS Software Development LLC v. Huawei Device USA Inc. et al. (E.D. Texas)*, Apr. 27, 2018 (16 pages).

Petition for Inter Partes Review of U.S. Pat. No. 9,749,829, IPR-01471, filed on behalf of Apple, Inc., Jul. 31, 2018 (85 pages).

Petitioner's Reply to Patent Owner Preliminary Response, IPR2018-01084 (*Google LLC v. AGIS Software Development LLC*; U.S. Pat. No. 9,467,838), Sep. 19, 2018 (9 pages).

Decision Instituting Inter Partes Review, IPR2018-01080 (*Google LLC v. AGIS Software Development LLC*; U.S. Pat. No. 9,408,055), Dec. 4, 2018 (38 pages).

Decision Denying Institution of Inter Partes Review, IPR2018-01086 (*Google LLC v. AGIS Software Development LLC*; U.S. Pat. No. 9,467,838), Dec. 4, 2018 (23 pages).

Decision Denying Institution of Inter Partes Review, IPR2018-01088 (*Google LLC v. AGIS Software Development LLC*; U.S. Pat. No. 9,467,838), Dec. 10, 2018 (30 pages).

Exhibit 3001 in IPR2018-01471 (*Apple Inc. v. AGIS Software Development LLC*; U.S. Pat. No. 9,749,829), PTAB Conference Call, Dec. 18, 2018 (26 pages).

Joint Statement of Stipulation Regarding Claim Construction, filed in *AGIS Software Development LLC v. HTC Corp. et al. (E.D. Texas)*, Document 91 in Case 2:17-cv-514, Dec. 8, 2018 (5 pages). Claim Construction Order, filed in *AGIS Software Development LLC v. HTC Corp. et al. (E.D. Texas)*, Document 93 in Case 2:17-cv-514, Dec. 18, 2018 (2 pages).

Decision: Institution of Inter Partes Review, IPR2018-01079 (*Google LLC v. AGIS Software Development LLC*; U.S. Pat. No. 8,213,970), Nov. 20, 2018 (38 pages).

Decision Denying Institution of Inter Partes Review, IPR2018-01081 (*Google LLC v. AGIS Software Development LLC*; U.S. Pat. No. 9,445,251), Nov. 20, 2018 (38 pages).

Decision Denying Institution of Inter Partes Review, IPR2018-01082 (*Google LLC v. AGIS Software Development LLC*; U.S. Pat. No. 9,445,251), Nov. 20, 2018 (39 pages).

Decision Denying Institution of Inter Partes Review, IPR2018-01085 (*Google LLC v. AGIS Software Development LLC*; U.S. Pat. No. 9,467,838), Nov. 19, 2018 (22 pages).

Patent Owner's Preliminary Response, IPR2018-01471 (*Apple Inc. v. AGIS Software Development LLC*; U.S. Pat. No. 9,749,829), Nov. 28, 2018 (24 pages).

* cited by examiner

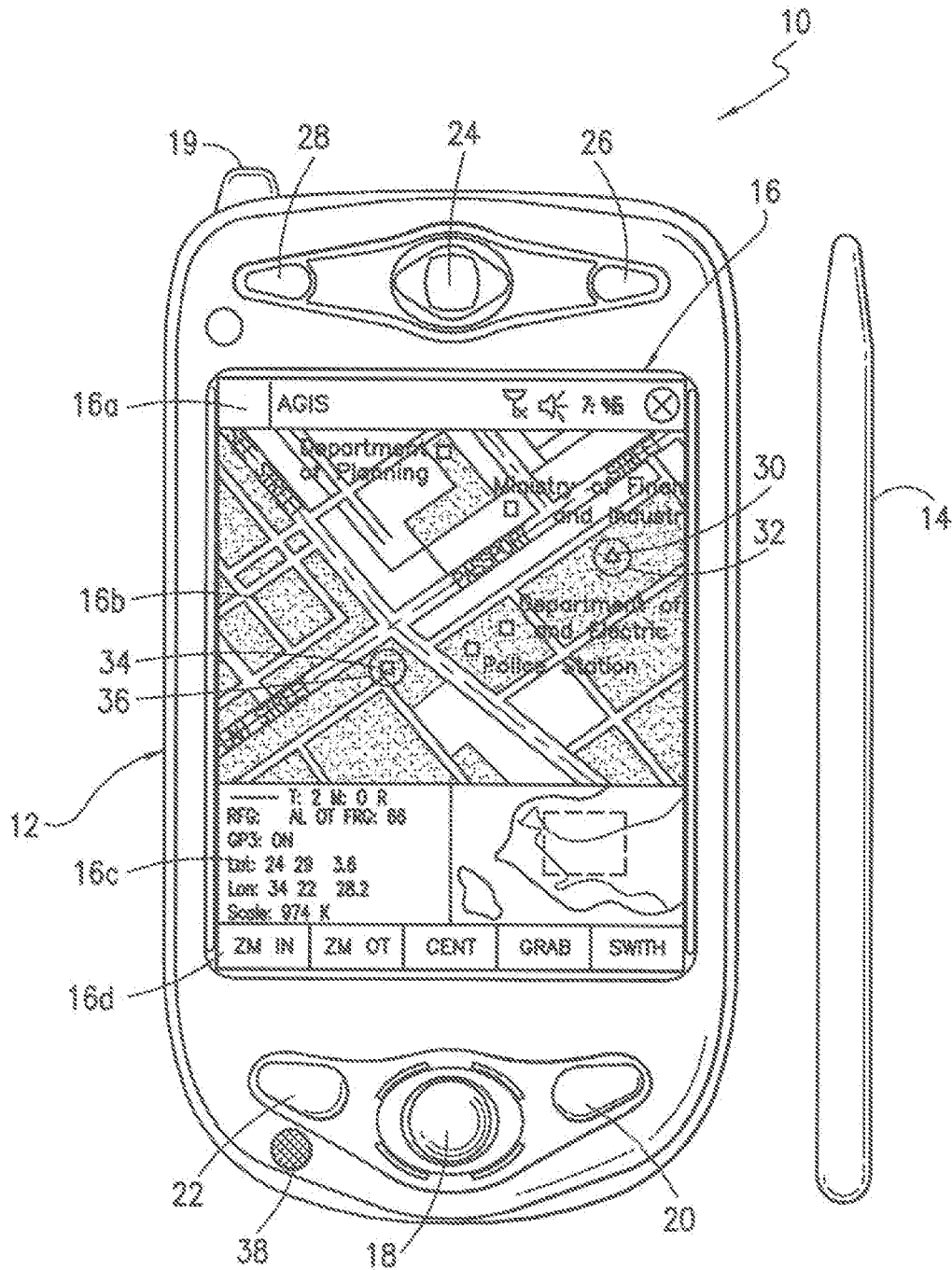

FIG. 1

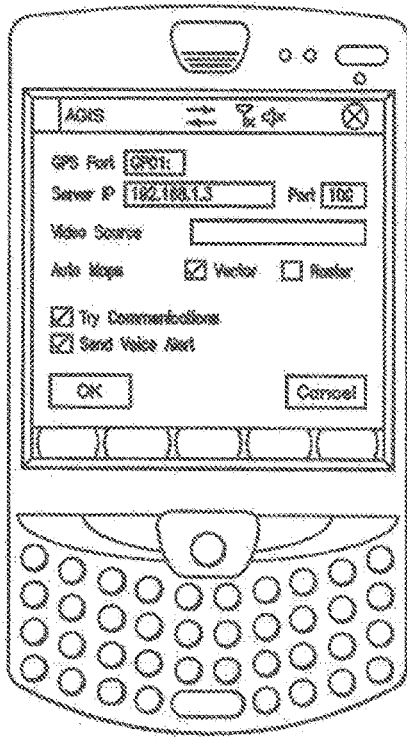

FIG. 2

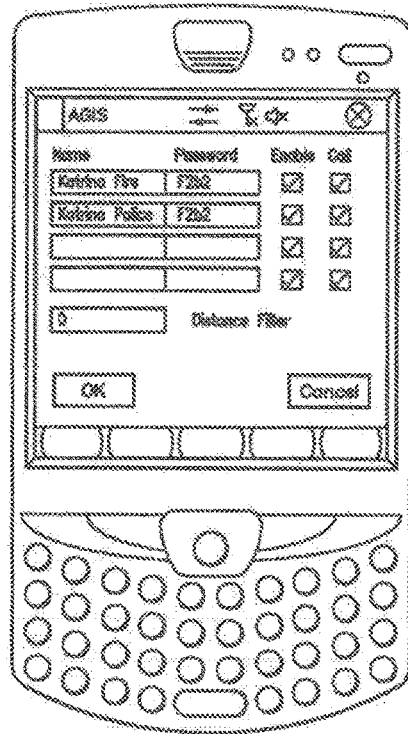

FIG. 3

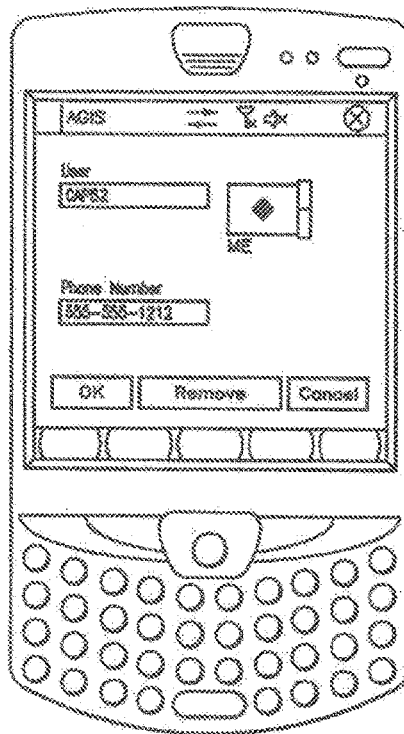
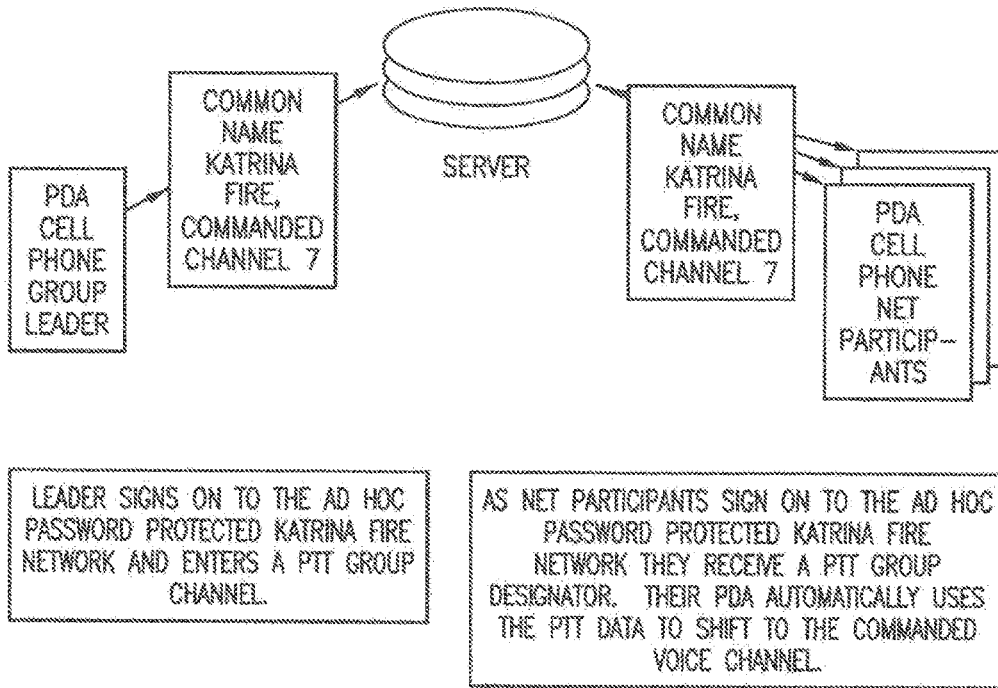
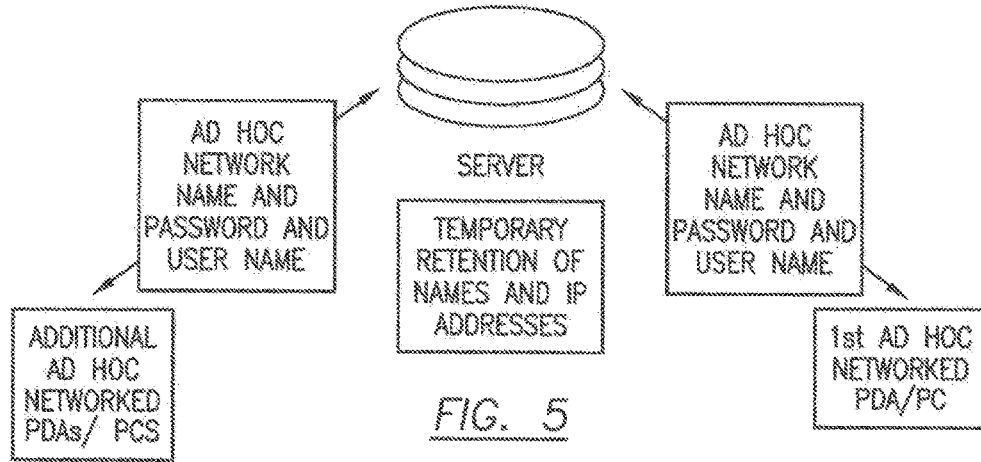

FIG. 4



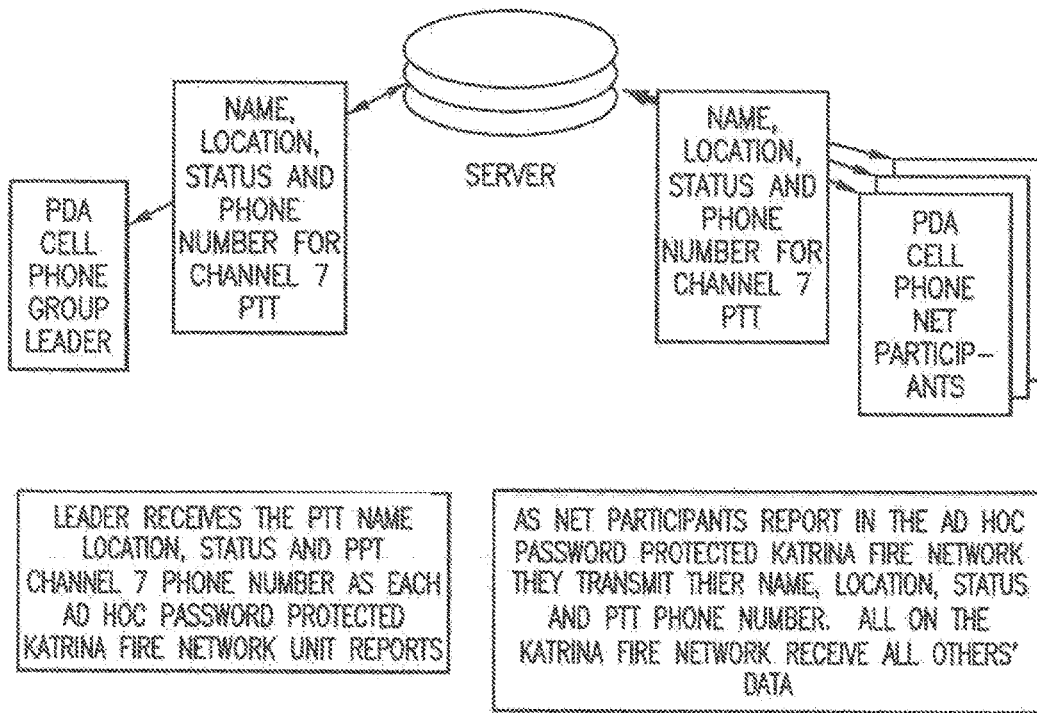

FIG. 7

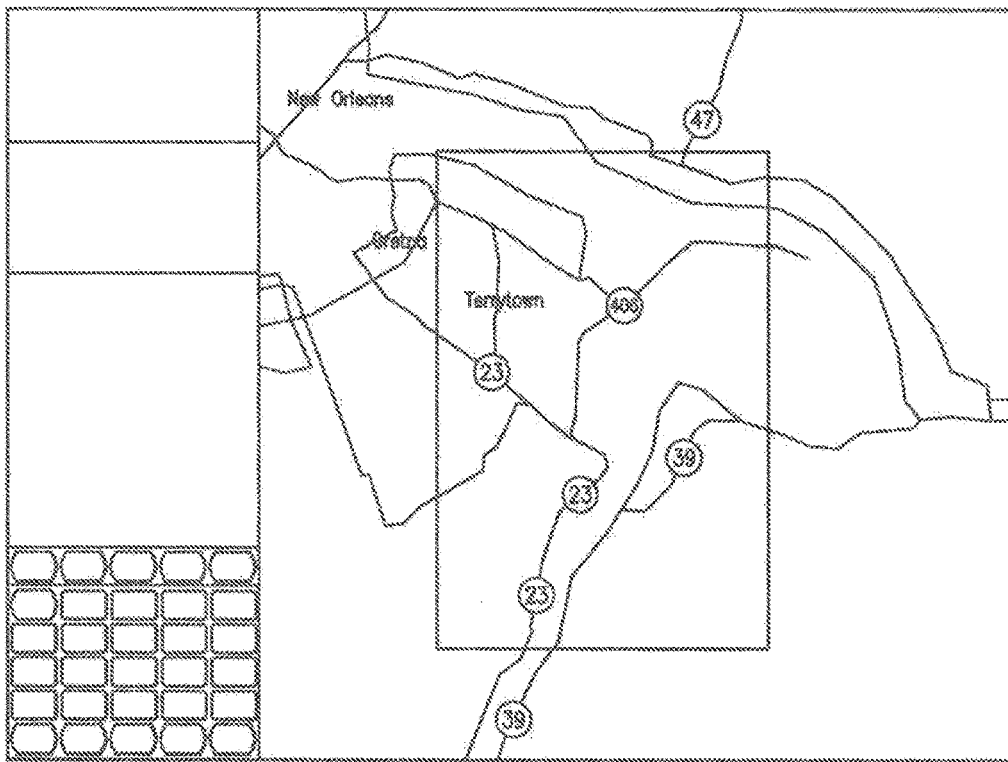

FIG. 8

ENABLING LOCATION, STATUS, VoIP, PTT AND VIDEO COMMUNICATIONS BETWEEN
RADIO AND CELL PHONES

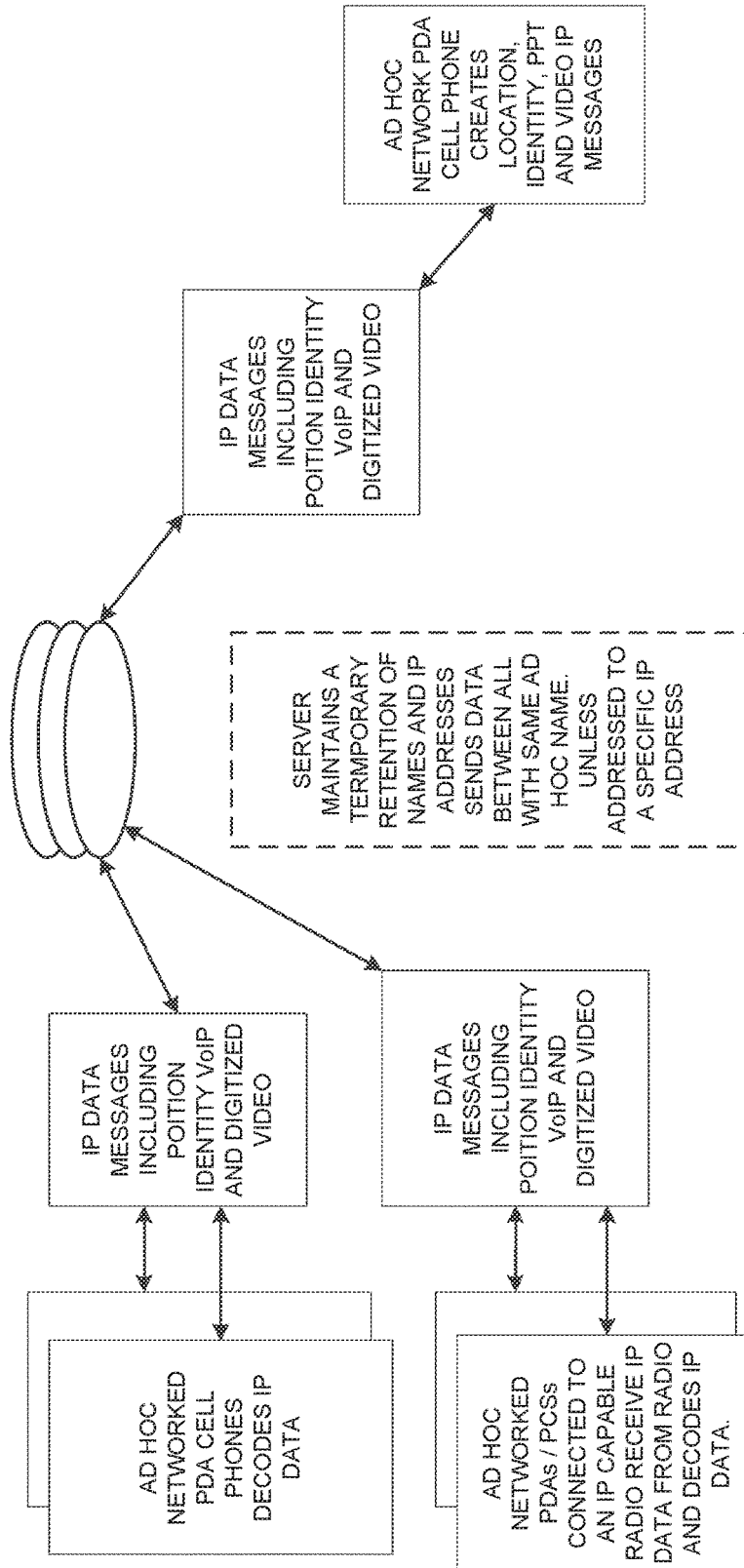

FIG. 9

ENABLING NON RFID EQUIPPED PDA PHONES TO RECEIVE RFID TAG DATA.

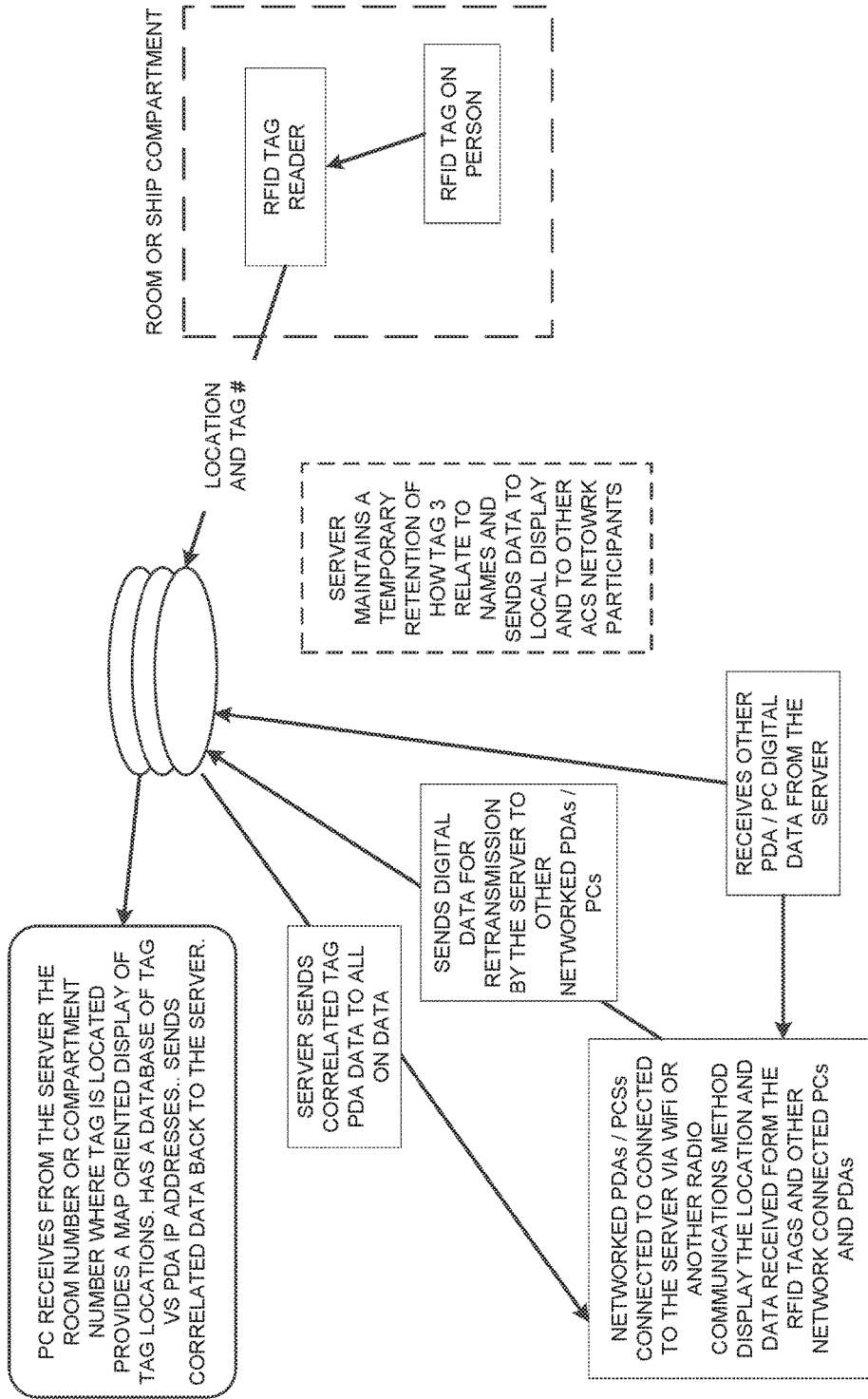

FIG. 10

US 10,341,838 B2

1

**METHOD TO PROVIDE AD HOC AND
PASSWORD PROTECTED DIGITAL AND
VOICE NETWORKS**

CROSS REFERENCE TO RELATED
APPLICATIONS

This application is a continuation of co-pending U.S. patent application Ser. No. 15/722,660, which is a continuation of U.S. patent application Ser. No. 15/469,469, on Mar. 24, 2017, which is a continuation of U.S. patent application Ser. No. 15/287,638, on Oct. 6, 2016, now U.S. Pat. No. 9,706,381 issued on Jul. 11, 2017, which is a continuation of U.S. patent application Ser. No. 14/529,978, filed on Oct. 31, 2014, now U.S. Pat. No. 9,467,838 issued Oct. 11, 2016 which is a continuation-in-part of U.S. patent application Ser. No. 14/027,410, filed on Sep. 16, 2013, now U.S. Pat. No. 8,880,042 issued Nov. 4, 2014, which is a continuation of U.S. patent application Ser. No. 13/751,453, filed Jan. 28, 2013, now U.S. Pat. No. 8,538,393 issued Sep. 17, 2013, which is a continuation-in-part of U.S. patent application Ser. No. 12/761,533 filed on Apr. 16, 2010, now U.S. Pat. No. 8,364,129 issued Jan. 29, 2013, which is a continuation-in-part of U.S. patent application Ser. No. 11/615,472 filed on Dec. 22, 2006, now U.S. Pat. No. 8,126,441 issued on Feb. 28, 2012, which is a continuation-in-part of U.S. patent application Ser. No. 11/308,648 filed Apr. 17, 2006, now U.S. Pat. No. 7,630,724 issued on Dec. 8, 2009, which is a continuation-in-part of U.S. patent application Ser. No. 10/711,490, filed on Sep. 21, 2004, now U.S. Pat. No. 7,031,728 issued on Apr. 18, 2006. All of the proceeding preceding applications are incorporated herein by reference in their entirety.

BACKGROUND OF THE INVENTION

Field of the Invention

A communications method and system using a plurality of cellular phones each having an integrated Personal Digital Assistant (PDA) and Global Positioning System (GPS) receiver for the management of two or more people through the use of a communications network. The method and system provide each user with an integrated handheld cellular/PDA/GPS/phone that has Advanced Communication Software application programs (hereinafter referred to as ACS) and databases used in conjunction with a remote Server that enable a user to quickly establish a communication network of cell phone participants having a common temporary ad hoc network using mobile wireless communication devices.

The invention includes a method and communication system to quickly set up and provide ad hoc, password protected, digital and voice networks to allow a group of people to be able to set up a network easily and rapidly, especially in an emergency situation.

Description of Related Art

The purpose of a communications system is to transmit digital messages from a source, located at one point, to user destination(s), located at other point(s) some distance away. A communications system is generally comprised of three basic elements: transmitter, information channel and receiver. One form of communication in recent years is cellular phone telephony. A network of cellular communication systems set up around an area such as the United

2

States allows multiple users to talk to each other, either on individual calls or on group calls. Some cellular phone services enable a cellular phone to engage in conference calls with a small number of users. Furthermore, cellular conference calls can be established through 800 number services. Cellular telephony also now includes systems that include GPS navigation that utilizes satellite navigation. These devices thus unite cellular phone technology with navigation information, computer information transmission and receipt of data.

The method and operation of communication devices used herein are described in U.S. Pat. No. 7,031,728 which is hereby incorporated by reference and U.S. Pat. No. 7,630,724.

Military, first responder, and other public and private emergency groups need to be able to set up ad hoc digital and voice networks easily and rapidly. These private networks may be temporary or longer lasting in nature. The users need to be able to rapidly coordinate their activities eliminating the need for pre-entry of data into a web and or identifying others by name, phone numbers or email addresses so that all intended participants that enter the agreed ad hoc network name and password are both digitally and voice interconnected. When a user or users leave the network, no data concerning the network participants need be retained.

Coordinating different organizations at the scene of a disaster presents several problems as there are voice and digital data (text messages) communications that need to be constantly occurring up and down the chain of command. As an example, communications are required from a police chief to a police captain to a police lieutenant to a police sergeant to a policeman and then back up the same chain of command. Digital data exchange of GPS data or other means provides the location component of the units. Digital chat, text messages, white boards and photo video exchange provide extensive collaboration. However, during a disaster, other first responders such as fire departments must become engaged. While the fire department users may have voice and digital data (text messages) communications up and down their chain of command, these individuals do not have the ability to cross communicate necessarily with police units without a substantial degree of immediate coordination. The method and system in accordance with the present invention described herein discloses how digital communications along with Personal Computer (PC) and PDA devices can be used to quickly establish user specific password protected private ad hoc voice and data networks to enable both data and voice communications up and down their chain of command and simultaneously with different, not pre-known, organizations responding to a disaster. The invention defines a method of accomplishing this by providing all personnel that need to communicate with each other with a PC or PDA which are interconnected to a Server using cellular or other communications.

SUMMARY OF THE INVENTION

Applicant's communication system and method described herein is embodied in the Advanced Communication Software (ACS) application programs developed by applicant and installed in the integrated PDA/GPS cell phones used herein and remote Servers.

A plurality of Internet Protocol (IP) capable PDA/GPS devices each having ACS application programs and databases provides a communication network in conjunction with a remote Server that provides the ability to: a) establish

US 10,341,838 B2

3

an ad hoc network of devices so that the devices can either broadcast to a group or selectively transmit to each of the other; each PDA/GPS phone starts by requesting access to the Server and identifying a mutually agreed to network name and password and once granted, reports its GPS position and status; the Server then routes the data to all signed on network participants so that each of the devices exchange location, status and other information; (b) force the received information to the recipient's display and enable the recipient to acquire additional information by touching the display screen at a remote phone's location on the PDA display; (c) make calls to or send data to remote phones by touching their display symbols and selecting the appropriate soft switch; (d) layer a sufficient number of soft switches or buttons on the PDA display to perform the above functions without overlaying the map; and (e) allow a polling mode in each cell phone that permits a user to contact other cell phone users that have a common interest or relationship with a password and identifier for communication and to establish quickly a temporary ad hoc network especially in an emergency.

A communication Server acts as a forwarder for IP communications between any combination of cell phone/PDA users and/or PC based users. Network participant location, identity and status messages are sent to the Server by each user. Network participant entered tracks are also sent to the Server. Because this network participant location and track data is of interest to all the network participants, the Server forwards the data received from one participant to all other participants, causing their displays automatically, without any operator action, to display the received information, thus providing the information necessary for all network participants to know the identity, location and status of all other network participants.

The Server also acts as a forwarder of data addressed from one participant to one or more addressed participants, thus permitting the transmission of free text, preformatted messages, photographs, video, Email and Uniform Resource Locator (URL) data from one network participant to other selected network participants.

The above functions can also be accomplished using peer to peer WiFi, WiMax or other peer to peer communications. However, for use with cellular communications and to assure the level of security that cell phone companies require, a centralized static IP routable Server is used.

The IP Server also fills another role of being a database from which data can be requested by network participants (i.e. maps, satellite images, and the like) or can be pushed to network participants (i.e. symbology and soft switch changes, and the like). The Server is used to establish an ad hoc network within certain groups using an ad hoc event name and password.

This invention provides a method and a system establishing an ad hoc password protected digital and voice network that can be temporarily set up or longer lasting in nature. The invention described herein allows users to rapidly coordinate their activities without having to pre-enter data into a web or identify others by name, E mail addresses or phone numbers. Essentially the users that establish the ad hoc and password protected digital and voice networks are required to enter the Server's IP address and an ad hoc event name and a password. In the case of military and first responders, the name of the user's unit may also be used. This action causes the specific PDA or PC of the user to commence reporting directly to the Server's IP address. Once the Server receives the initial IP message from the user's PDA or PC, the server can commence to exchange data with the user's PDA or PC.

4

The initial IP message may also contain additional data such as a license number and, if desired, a phone number manually entered or automatically acquired by the ACS. The IP address of the PDA and PC unit sending the initial IP message is stored by the Server. The Server then responds with a message notifying the user that his PC/PDA is connected to the Server. The user PDA/PC then reports its GPS location and other status information directly to the Server. This information is retained by the Server even when there are no other devices initially communicating with the Server. When the other user's devices sign on to the Server with the same ad hoc event name and password, the Server software then recognizes all the users and stores their IP addresses in the Server. Thus the Server has all the users IP addresses stored and can pass location and status information among the ad hoc network participants even though the network participants have not entered other network participants' names, phone numbers or email addresses. Thus one of the purposes of the invention is to allow an ad hoc network to be formed on a temporary basis in a rapid manner.

When using the PTT feature, the ACS can enable the network participant to: 1. PTT with all that are in the ad hoc digital network, or 2. PTT with select specific network participants, by touching their symbols) and then selecting PTT soft switch or 3. Specify a group of the network participants by assigning their symbols or unit names to a list of network participants and then associating the list with a soft switch whose function is to enable the operator to have PTT communications with all in the list.

Since only one person is transmitting on a PTT voice network at any given time, the receiving network participant's ACS can relate the PTT IP address to the IP address of the unit transmitting his identification on the digital ad hoc network. This information can then be used by the other PTT networked participant's ACS to: 1. flash the transmitting unit's name on their PDA/PC screens or 2. if a photograph has been attached to the ad hoc digital network symbol of the PTT transmitting person, to flash that photograph on the receiving unit's PDA/PC display.

It is an object of this invention to enable each participant in the communication network to join other ad hoc network participants to form an ad hoc digital and voice network with other cell phone users rapidly for coordinating member activities.

In accordance with these and other objects which will become apparent hereinafter, the instant invention will now be described with particular reference to the accompanying drawings.

BRIEF DESCRIPTION OF THE DRAWINGS

FIG. 1 shows a front plan view of a cellular phone/PDA/GPS having a touch screen.

FIG. 2 shows the screen IP address entry menu.

FIG. 3 shows ad hoc net names and password screen entry name.

FIG. 4 shows a screen entry identifying user.

FIG. 5 shows a flow chart of the network as users sign on to the network.

FIG. 6 shows a flow chart that depicts how a group commander can command networked PDAs/PCS and radios to load a Push To Talk (PTT) channel.

FIG. 7 shows a flow chart that depicts how networked radio units respond to receipt of the Push-to-Talk (PTT) Commanded Channel.

US 10,341,838 B2

5

FIG. 8 shows a PDA screen geographical display that represents the area covered by the network.

FIG. 9 shows a diagram that enables determining location, status, ViOP, PTT, and video communication between adios and cell phones.

FIG. 10 shows a diagram that describes enabling non RFID equipped PDA phones to receive RFID tag data.

PREFERRED EMBODIMENT OF THE INVENTION

A method and communication system that joins a communications network of participants using handheld cell phones having integrated PDA and GPS circuitry with ACS application programs that allow a participant having an ACS equipped cell phone to provide an ad hoc and password protected digital and voice network.

A communication Server acts as a forwarder for IP communications between any combination of cell phone/PDA users and/or PC based user. Network participant location, identity and status messages are sent to the Server by each user. Network participant entered tracks are also sent to the Server. Because this data is of interest to all the network participants, the Server forwards the data received from one participant to all other participants, thus providing the information necessary for all network participants to know the identity, location and status of all other network participants.

The Server allows the set up of the ad hoc network with an ad hoc event name and a password.

The Server also acts as a forwarder of data addressed from one participant to one or more addressed participants, thus permitting the transmission of free text, preformatted messages, photographs, video, email and URL data from one network participant to other selected network participants.

Referring now to the drawings and, in particular, to FIG. 1, a small handheld cellular phone 10 is shown that includes a PDA and a GPS communications device integrated in housing 12 that includes an on/off power switch 19, a microphone 38, and a Liquid Crystal Display (LCD) display 16 that is also a touch screen system. The small area 16a is the navigation bar that depicts the telephone, GPS and other status data and the active software. Each cell phone includes a Central Processing Unit (CPU) and databases that store information useful in the communication network. The CPU also includes a symbol generator for creating touch screen display symbols discussed herein. With the touch screen 16, the screen symbols are entered through GPS inputs or by the operator using a stylus 14 (or operator finger) by manipulatively directing the stylus 14 to literally touch display 16. The soft switches 16d displayed on the display 16 are likewise activated by using a stylus 14 and physically and manipulatively directing the stylus to literally touch display 16. The display x, y coordinates of the touched point are known by a CPU in the PDA section of the communication system in housing 12 that can coordinate various information contained in the PDA relative to the x, y coordinate position on the display 16. Inside housing 12 is contained the conventional cellular phone elements including a modem, a CPU for use with a PDA and associated circuitry connected to speaker 24 and microphone 38. A GPS navigational receiver that receives signals from satellites that can determine the latitude and longitude of the cellular phone housing 12 can be internal or external to the housing 12. Conventional PDA/cellular phones are currently on sale and sold as a unit (or with an external connected GPS) that can be used for cellular telephone calls and sending cellular Short Message Service (SMS) and Transmission Control Protocol

6

(TCP) TCP/IP or other messages using the PDA's display 16 and computer CPU. The GPS system including a receiver in housing 12 is capable of determining the latitude and longitude and through SMS, TCP/IP, WiFi or other digital messaging software, to also transmit this latitude and longitude information of housing 12 to other cellular phones in the communication network via cellular communications, WiFi or radio. The device 10 includes a pair of cellular phone hardware activating buttons 20 to turn the cellular phone on and 22 to turn the cellular phone off. Navigation pad actuator 18 is similar to a joy or force stick in that the actuator 18 manually provides movement commands that can be used by the RDA's software to move a cursor on display 16. Switches 26 and 28 are designed to quickly select an operator specified network software program. Speaker 24 and microphone 38 are used for audio messages. Switch 19 at the top left of device 10 is the power on and power off switch for the entire device.

The heart of the invention lies in the applicant's ACS application programs provided in the device. The ACS programs are activated by clicking on an icon on the display to turn the ACS programs on or off. Mounted within housing 12 as part of the PDA is the display 16 and the CPU. The internal CPU includes databases and software application programs that provide for a geographical map and georeferenced entities that are shown as display portion 16b that includes as part of the display various areas of interest in the particular local map section.

When looking at display 16, the software switches (soft switches) which appear at the very bottom of the display 16d are used to control by touch many of the software driven functions of the cellular phone and PDA. The soft switches are activated through the operator's use of the navigation pad 18, or a small track ball, force stick or similar hardware display cursor pointing device. Alternatively, the operator may choose to activate the software switches by touching the screen with a stylus 14 (or finger) at the switches' 16d locations. When some of the software switches are activated, different software switches appear. The bar display 16d shows the software switches "ZM IN (zoom in)," "ZM OT (zoom out)," "CENT (center)" and "GRAB (pan/grab)" at the bottom of the screen. These software switches enable the operator to perform these functions. The "SWITH (switch)" software switch at the lower right causes a matrix of layered software switches (soft switches) to appear above the bottom row of switches. Through use of the software switches, the operator can also manipulate the geographical map 16b or chart display. When looking at FIG. 1, display symbols depicting permanent geographical locations and buildings are shown. For example, the police station is shown and, when the symbol is touched by the stylus or finger, the latitude and longitude of the symbol's location, as shown in display section 16c, is displayed at the bottom left of the screen. The bottom right side of display 16c is a multifunction inset area that can contain a variety of information including: a) a list of the communication link participants; b) a list of received messages; c) a map, aerial photograph or satellite image with an indication of the zoom and offset location of the main map display, which is indicated by a square that depicts the area actually displayed in the main geographical screen 16b; d) applicable status information; and e) a list of the communication net participants. Each participant user would have a device 10 shown in FIG. 1.

Also shown on the display screen 16, specifically the geographical display 16b, is a pair of different looking symbols 30 and 34, a small triangle and a small square, which are not labeled. These symbols 30 and 34 can

US 10,341,838 B2

7

represent communication net participants having cellular phones in the displayed geographical area that are part of the overall cellular phone communications net, each participant having the same device 10 used. The latitude and longitude of symbol 30 is associated within a database with a specific cell phone number and, if available, its IP address and email address. The screen display 16b, which is a touch screen, provides x and y coordinates of the screen 16b to the CPU's software from a map in a geographical database. The software has an algorithm that relates the x and y coordinates to latitude and longitude and can access a communications net participant's symbol or a fixed or movable entity's symbol as being the one closest to that point.

In order to initiate a telephone call to the cellular phone user (communication net participant) represented by symbol (triangle) 30 at a specific latitude and longitude display on chart 16b, the operator touches the triangle 30 symbol with the stylus 14. The user then touches a "call" software switch from a matrix of displayed soft switches that would overlay the display area 16c. Immediately, the cellular phone will initiate a cellular telephone call to the cellular phone user at the geographical location shown that represents symbol 30. A second cellular phone user (communication net participant) is represented by symbol 34 which is a small square (but could be any shape or icon) to represent an individual cellular phone device in the display area. The ring 32 around symbol 30 indicates that the symbol 30 has been touched and that a telephone call can be initiated by touching the soft switch that says "call." When this is done, the telephone call is initiated. Other types of symbolic elements on the display 16 can indicate that a cellular phone call is in effect. Additionally, the operator can touch both symbol 34 and symbol 30 and can activate a conference call between the two cellular phones and users represented by symbols 30 and 34. Again, a symbolic ring around symbol 34 indicates that a call has been initiated.

Equally important, a user can call the police station, or any other specific geographical facility displayed on the map including: buildings, locations of people, vehicles, facilities, restaurants, or the like, whose cellular phone numbers and, if available, Email addresses, IP addresses and their URLs (previously stored in the database) by touching a specific facility location on the map display using the stylus 14 and then touching the cellular phone call switch. As an example, the operator can touch and point to call a restaurant using a soft switch by touching the restaurant location with a stylus and then touching the call soft switch. The cellular phone will then call the restaurant. Thus, using the present invention, each participant can touch and point to call to one or more other net participants symbolically displayed on the map, each of whom has a device as shown in FIG. 1, and can also point to call facilities that had been previously stored in the phone's database. Furthermore, this symbol hooking and soft switch technique can be used to go to a fixed facility's website or to automatically enter the fixed facility's email address in an email.

Each cellular phone/PDA/GPS user device is identified on the map display of the other network participant user's phone devices by a display symbol that is generated on each user phone display to indicate each user's own location and identity. Each symbol is placed at the correct geographical location on the user display and is correlated with the map on the display and is transmitted and automatically displayed on the other network participant's PC and PDA devices. The operator of each cellular phone/PDA/GPS device may also enter one or more other fixed entities (buildings, facilities, restaurants, police stations, etc.) and

8

geo-referenced events such as fires, accidents, etc., into its database. This information can be likewise transmitted to all the other participants on the communications net and automatically displayed. The map, fixed entities, events and cellular phone/PDA/GPS device communication net participants' latitude and longitude information is related to the "x" and "y" location on the touch screen display map by a mathematical correlation algorithm.

When the cellular phone/PDA/GPS device user uses a stylus or finger to touch one or more of the symbols or a location displayed on the cellular phone map display, the system's software causes the status and latitude and longitude information concerning that symbol or location to be displayed. In order to hook a symbol or "track" such as another net participant which represents an entity on the geo-referenced map display, or a fixed geographical entity such as a restaurant, police station or a new entity observed by a cell phone user which is discussed below, the operator touches at or near the location of a geo-referenced symbol appearing on the cellular phone/PDA display that represents a specific track or specific participant or other entity. The hook application software determines that the stylus (or finger) is pointed close to or at the location of the symbol and puts a circle, square or other indication around the symbol indicating that amplification information concerning the symbol is to be displayed. The operator can hook entered tracks or his own track symbol and add data or change data associated with the indicated symbol. The hook application code then sends a message to the database application code to store the facility or entity's updated data. The display application code retrieves the primary data and amplification data concerning the symbol or entity from the database and displays the information at the correct screen location. The operator can then read the amplification data that relates to that specific symbol at the specific location. The cell phone operator can also select soft switches on the touch screen display to change the primary data and amplification data. Furthermore, the operator can use a similar method of hooking and selecting to activate particular soft switches to take other actions which could include: making cellular phone calls, conference calls, 800 number calls; sending a free text message, operator selected preformatted messages, photographs or videos to the hooked symbol; or to drop an entered symbol.

Each known net participant has a cellular phone number, IP address and, if available, Email address that is stored in each participant's device database.

To use the communication system, a user starts the PDA/cellular phone device system by turning on the cell phone power and selecting the cell phone and network software which causes: a) the cellular phone to be activated (if it has not already been activated); b) the GPS interface receiver to be established; c) a map of the geographic area where the operator is located and operator's own unit symbol to appear at the correct latitude and longitude on the map on the display; d) the locations of fixed facilities such as restaurants, hotels, fire departments, police stations, and military barracks, that are part of the database to appear as symbols on the map; e) the device selected item read out area which provides amplification information for the communications net participants or the entity that has been hooked (on the display screen) to appear on the display; f) an insert area that contains various data including: the list of net participants, a list of messages to be read, an indication of what portion of the map is being displayed in major map area and other information to appear on the display; and g)

US 10,341,838 B2

9

a row of primary software created “soft switches” that are always present on the display to appear.

For point to call network units and fixed facilities, the application code detects the x, y display screen location of the symbol that is designated by the user’s stylus and translates the x, y coordinates to latitude and longitude and then: (1) searches the database to find the symbol at that location, (2) places a “hook” indicator (a circle, square or other shape) around the symbol, (3) displays any amplifying data and (4) obtains the symbol’s associated phone number (or, for Voice over IP (VoIP) an IP address) from the database. Upon receiving a “call” designation from the soft switch, the operator’s device’s ACS causes the appropriate phone number or IP address to be called. Upon receiving an indication that the phone number is being called, the application code places a box around the symbol (color, dashed or the like). When the call is connected, the box changes to indicate that the connection is made. When the other party hangs up, the box disappears.

As each of the cell phone participants reports its identity, location and status to the other participants’ devices, the received data is automatically geo-referenced and filed in their databases that are accessible by identity and by location. This data is then displayed on each cell phone display. When a request for data is received by touching the display screen, a location search is made by the ACS and a symbol modifier (circle, square, etc.) is generated around the symbol closest to the x, y position of the stylus. When the application code receives a soft switch command to place a phone call or send data, the software uses the phone number (or IP address) associated with the unit to place the call or to send data.

If a cell phone device receives a digital message that a call is being received, the receiving cell phone’s ACS application code places a box or similar object around the transmitter symbol indicating who the call is from. When the call is answered, the application software changes the visual characteristics of the box. In a similar manner, when a phone receives a digital text message, photograph or video, a box appears around the transmitter’s symbol indicating the transmitter of the message. The point to call network devices are network participants and each one has a PC/PDA device with the same software for use as a total participant network. Other situations for calling facilities that are not network participants are also described below.

Thus, a user is capable of initiating a cellular phone call by touch only and initiating conference calls by touching the geo-referenced map symbols. Furthermore, by using a similar symbol touching technique, a cellular phone can send user selected messages to cause a remote cellular phone to display and optionally announce emergency and other messages and to optionally elicit a response from the remote cellular phone.

All of the network participants have the same communication cell phone/PDA/GPS device described herein. The method and system include the ability of a specific user to provide polling in which other cellular phones, using SMS, internet or WiFi, report periodically based on criteria such as time, speed, distance traveled, or a combination of time, speed and distance traveled. A user can manually poll any or all other cell phone devices that are used by all of the participants in the communication network having the same devices. The receiving cellular phone application code responds to the polling command with the receiving cellular phone’s location and status which could include battery level, GPS status, signal strength and entered track data.

10

Optionally, the phone operators can set their phones to report automatically, based on time or distance traveled intervals or another criterion.

The soft switch application software causes a visual display of a matrix such as five across by six up (or another matrix) in which switch names are placed on the cellular/PDA display. The soft switch network application software knows the touch screen location of each of the switches in the matrix and the software routines that will be activated upon touching the switch.

The bottom row of soft switches displayed on the touch screen retracts visually fixed. These switches concern the functions that are the most often used. One of the switches causes a matrix of other soft switches to appear above the visually fixed soft switches. These switches are function soft switches, the activation of any one of which causes a different matrix of soft switches to appear, which are known as the action soft switches. When the action soft switches appear, the function soft switch, which caused the action soft switches to appear, itself appears as a label in the lower left (or some other standard location) indicating to the operator the function soft switch that has been selected. When the operator selects an action soft switch, the appropriate application software to accomplish the action is activated.

Upon receiving a soft switch activation message, the ACS accesses the appropriate task execution software which accomplishes the required tasks including: entry of track data, entry of track amplification data, transmission of alpha/numeric messages, photographs, videos, display of messages to be read, selection of map types, placing voice calls, placing conference calls and 800 conference calls, presenting different potential operator selections, control of the display actions, polling network participants, establishing nets of participants (groups) so that communications with all in the group can be accomplished with a single soft switch action, and dropping a previously entered track. By providing a matrix and layers of soft switches which are easily manipulated by a stylus, each cell phone device in the communication network is extremely efficient in accessing and coordinating the appropriate application program for the device to perform.

Users such as emergency groups, police, fire personal, military, first responders and other groups need to be able to set up ad hoc digital and voice networks easily and rapidly. The users need to be able to rapidly coordinate activities eliminating the need for pre-entry data as discussed above. Users are required to enter the Servers’ IP address and an ad hoc event name, a password and, for first responders and military, the names of their units. This will normally be controlled by the PDA/PC user’s position in the chain of command. For others it can be any selected name and, if desired, password.

Referring now to FIG. 2, the PDA/PC screen displays an IP address entry menu. The user inserts the Server’s IP address. Thus, as shown in FIG. 2, the user has entered in the cell phone/PDA the Server IP address and port number along with the GPS port listing and other information. Once that information is entered, referring now to FIG. 3, the user now enters the ad hoc event network name which is shown in this example as “Katrina” along with a password. Referring now to FIG. 4, the user then enters the user name or a unit name. FIG. 4 shows the entered user name and a phone number. The phone number may be automatically entered by the ACS or manually entered. The phone number is not required unless using the phone system (not VoIP) to make calls. These are the initial user steps required to establish an ad hoc network or to join onto an existing ad hoc network.

US 10,341,838 B2

11

Referring now to FIG. 5, these actions cause the user cell phone/PDA or PC to commence reporting to the Server. Upon receipt of the initial message from the user's PDA/PC, which may also contain additional data such as a license number, the Server stores the IP address of the user's PDA/PC unit and responds with a message notifying the user that he or she is connected to the Server. The PDA/PC then automatically commences to report its GPS derived location and other status information to the Server. Since there are no other devices initially communicating with the Server, the Server just retains the information. When other devices sign on to the Server with the same ad hoc event name and password, the Server's software recognizes this and stores their IP addresses. Since the Server has all parties' IP addresses, the server is able to pass location and status information automatically between the ad hoc network participants. This can occur even though the ad hoc network participants have not entered other network participants names, telephone numbers or Email addresses and do not have the other network participants' IP addresses, phone numbers or Email addresses. Once this connection is made, data types that are entered on one display that is of interest to all is sent from the server to all others in the network. Such data types include track location and track amplification data, geo-referenced white boards, and chat.

When the PDA/PC user wants to address particular data (a text message, photograph, video clip, voice recording, white board, or chat), the user enters the name of the other ad hoc network participant by either entering a name or touching his or her symbol. Since the Server knows the IP address of the name or symbol, the Server forwards the data appropriately to that network participant. When a unit signs off the network, it transmits a message to the Server which then transmits a message to all the network participants to drop the unit and its associated tracks. If a unit loses communications for a variable time period, the unit's data is flushed from each of the recipient network participants systems according to a variable time period. After a separate variable time period, the Server also flushes the non-reporting units data.

As can be seen in FIG. 6, provisions have been made for the PDA/PC to report on multiple networks thus allowing both digital communications up and down the chain of command and with adjacent units that have entered a common ad hoc network name and password.

Typically military and First Responder units use Push-to-Talk (PTT) communications. Units in an organization's chain of command typically have instituted a method to establish voice communications between themselves for they know each other's cellular phone numbers, PTT cellular group identifiers and radio frequencies or channel numbers. However, in a disaster there are many different units (fire, police, EMS, Military, and the like) involved all of whom need to establish voice communications between each other. The issue then becomes how to coordinate these PTT voice communications with the ad hoc digital communications so that all on the digital data network automatically also have PTT voice communications with each other. If the PCs and PDAs in a group have manually entered their phone numbers, or the ACS has automatically entered their phone numbers, and sent their phone numbers as part of their initial message to the Server, this data is then sent by the Server to all others in the network. Upon receiving the phone number data, the recipients' ACS loads the cell phones numbers into their databases creating a phone number PTT group common with the digital IP network group.

12

The issue when using radios, however, is different. PTT radio coordination between multiple people is achieved by using a common radio frequency "Channel".

Furthermore, it is desirable to enable it so that, when new network participants join the digital network, they are automatically included in the voice network and, when they leave the digital network, they are automatically dropped from the digital network.

As can be seen in FIG. 6 and FIG. 7, a network participant currently can establish a new ad hoc digital network or join an existing ad hoc digital network by entering the ad hoc network name and password into his PDA/PC. To enable voice coordination with all that are a part of the ad hoc digital network, the user then enters (if user is authorized to do so) a Channel or Group number that the user is commanding all in the ad hoc network to establish as their PTT voice net. As seen in FIG. 6, the operator has commanded all to shift to Radio Channel or to a specific PTT cellular or radio channel; i.e. Group 7.

This action causes the PTT Channel, or PTT Group 7, to be sent to the other PDA/PC users in the ad hoc password protected network through the Server.

As shown in FIG. 6 and FIG. 7, the Group leader enters the Katrina Fire ad hoc network and issues a command which is sent to the Server to cause the PDAs/PCs that are in the Katrina Fire Group to automatically shift their Radio or cellular device to Channel 7. Each PDA cell phone can connect to the user's Radio for control with a USB cable, or WiFi, Bluetooth, or Near Field Communications (NFC) signals or other communications that are contained in the PDA/PC cellular device. This enables the Radios to shift to a common channel. This action is received by the Server which then sends the "Shift to Channel 7 Command" to all network participants in the Katrina Fire ad hoc network. When the PDA/PC/Tablet Katrina Fire network participant's software receives the command to shift its Radio Channel PPT to Group 7, this action causes the PDA's ACS to establish a new Channel 7 group (or to override an old Channel 7 group) that consists of all on the digital ad hoc network. The PC and PDAs then send their radios' digital interfaces messages to shift to Channel 7 or to the frequency associated with Channel 7. The digitally networked PC's and PDA's ACS devices then send a message to all on the digital network that they have shifted to Channel 7 (or to the appropriate frequency) and also further send the Group Leader's identifier and Command to shift to Channel 7 so that the ACS' devices associated with new users joining the digital network will automatically digitally set their radios to Channel 7 or the appropriate frequency.

As shown in FIG. 7, each time one of the network participants reports to the Katrina Fire network its Name, Position and Status, it now also reports that it is in PTT Channel 7 enabling the PTT group to grows in size until it encompasses all in the ad hoc password protected digital network. When units drop out of the Common Interest Network or lose communications because they are no longer active or they are out of range, their PTT Channel data is likewise dropped as they dropped out of the digital because their reports have not been received for a set, but adjustable, time period. If a unit rejoins the network, their PTT Name and Phone number is again automatically added to the Katrina Fire Interest Group as they are accepted by the Server into the Katrina Fire Interest digital Group.

When using the PTT feature, the ACS can enable the network participant to: 1. PTT with all that are in the ad hoc digital network, or 2. PTT with select specific network participants, by touching their symbol(s) and then selecting

US 10,341,838 B2

13

PTT soft switch or 3. Specify a group of the network participants by assigning their symbol or unit name to a list of network participants and then associating the list with a soft switch whose function is to enable the operator to have PTT communications with all in the list.

Since only one person is transmitting on a PTT voice network at any given time, the receiving network participant's ACS can relate the PTT IP address to the IP address of the unit transmitting his identification on the digital ad hoc network. This information can then be used by the other PTT networked participant's ACS to: 1. flash the transmitting unit's name on their PDA/PC screens or 2. if a photograph has been attached to the ad hoc digital network symbol of the PTT transmitting person, to flash that photograph on the receiving unit's PDA/PC display.

Referring now to FIG. 8, for some Emergency events, and in particular military operations, it is desirable to further define ad hoc networks so that the networks encompass only a certain geographical area defined by boundary lines on a map. To accomplish this, an enhancement to the ad hoc digital and voice PTT password protected network is provided. As an example, once the Katrina Fire digital and PTT network is established, the ad hoc network can be further refined by the Group Leader defining a map area that limits the participating group to only those users within a geographically defined area by the Group Leader, creating on his PC/PDA display a box that defines a geographic area on a map.

As shown in FIG. 8, the Latitude/Longitude points that define the rectangle of the boundary area are sent from the Group Leader's device to the Server which relays the data to the other participating unit PC/PDA devices in the Katrina Fire network. When the participating unit devices receive the Latitude/Longitude points, their software computes whether their PC/PDA unit is inside or outside a boundary area. If the users are inside the defined area, the users retain but disregard the Latitude/Longitude data and continue to report on the digital password protected network and to use the commanded PTT channel/frequency. However, if the users are outside the area, the users send a "drop me message" to the Katrina Fire PDA/PC digital network Server and cease reporting on the network. When Katrina Fire network PDA/PC user units leave the defined area or lose communications for a specified, but adjustable, time period, the Server drops the unit from the network and informs all network users that the unit is dropped from the digital network and from voice PTT Channel 7 which causes all others on the network to drop them. When Katrina Fire networked PDA/PC user units re-enter the area, the unit's ACS detects the fact and commences reporting as it receives reports from other network participants it will receive the current PTT channel or frequency.

In disasters, battery life is essential as there may not be extra batteries available or a power available to recharge the battery. It is therefore essential to lessen battery utilization. The normal method by which this is accomplished is to not use software that keeps the display on, uses the GPS or transmits on the communications. However, deactivating any one of these processes produces a problem with providing location data to all on the network.

With location sharing there are essentially two times when the location information is essential: a) Where the user wants all to know his/her location and status and the location and status of others and b) When the commander wants to know the location and status of all or of a particular unit.

14

When the user wants others to know the user location and status, the user can simply turn on location reporting software which then turns on the display, the GPS and the communications reporting software causing the reporting of the user location to the ad hoc password protected digital network. However, when the commander or someone else wants to know the location and status of the PDA/PC unit that is conserving battery usage by having user display, GPS and communications transmission turned on, the commander has no method to accomplish this.

This problem is overcome by enabling the commander to transmit a "turn on" IP message to the battery conserving(s) unit(s) by addressing the message to the ad hoc network Server which then sends an SMS message to the addressed phone. The SMS message will be received as long as the phone is powered on, as SMS is integrated with the cell phone's voice communications. The Server could also send a turn on IP message to networked radios, which will then cause the radio's computer to send a digital message to the receiving PC/PDA to activate the user display and location and status reporting software.

Referring now to FIG. 9, the diagram illustrates the enabling of location, status, VoIP, PTT, and video communications between radios and cell phones. The server maintains a temporary retention of names and IP addresses and sends data between all with the same ad hoc name unless addressed to a specific IP address. This requires that there is a radio with digital capabilities attached to the server shown in FIGS. 5, 6, and 7. These radios are set so that they each have a unique IP address. All of the participants have either PDA cell phones or PDAs without cellular. Those that also have PDAs without cellular (or choose not to use cellular) are connected to their radios via a USB cable or Wi-Fi, Bluetooth, or near field communications (NFC) that is part of the PDA/PC OR PDA cell phone. This is illustrated in FIG. 9.

Referring now to FIG. 10 the diagram shows enabling non-RFID equipped PDA phones to receive RFID tag data. The server maintains a temporary retention of how Tags relate to names and sends data to local display and to other ACS network participants. Currently RFID tags are used for many functions, one of which is to track personnel inside a building to the room or compartment in which they are located. This is accomplished by RFID readers that are in each of the rooms. When personnel with an RFID tag get within a particular distance or range of the RFID reader, the reader detects their presence and sends it to a central site server via a USB cable or Wi-Fi. The PC connected to the server displays the personnel room locations. With the invention described herein, the server would then send the location to the ACS PDA/PC phones that would be carried by individuals located throughout the building or ship. The PDA/PC phones would display the room or ships compartments and the location of individuals with RFID tags and simultaneously enable PTT, chat, messaging, whiteboards, commands geo-fence penetration alerts or other types of messages between each of the PDA cell phones. The RFID tag would provide room location data of all to all that are on the ACS Wi-Fi network without their PDA cell phone having an RFID Reader attached to it. The operation is explained in detail in FIG. 10.

The instant invention has been shown and described herein in what is considered to be the most practical and preferred embodiment. It is recognized, however, that departures may be made there from within the scope of the invention and that obvious modifications will occur to a person skilled in the art.

US 10,341,838 B2

15

What is claimed is:

1. A method performed by one or more servers each having one or more processors, the method comprising: executing operations on the one or more processors, the operations comprising: 5
 obtaining first data provided by a first mobile device corresponding to a vehicle, the first data including a first identifier;
 permitting the first mobile device corresponding to the vehicle to join a communication network, the permitting based on a determination regarding the first data; 10
 obtaining second data provided by a second mobile device corresponding to a participant, the second data including a second identifier associated with the participant; 15
 allowing the second mobile device corresponding to the participant to join the communication network, the allowing based on a determination regarding the second data;
 receiving vehicle location data provided by the first mobile device corresponding to the vehicle, wherein the vehicle location data are associated with the first identifier and indicate coordinates of a geographical location of the first mobile device; 20
 receiving participant location data provided by the second mobile device corresponding to the participant, wherein the participant location data are associated with the second identifier and indicate coordinates of a geographical location of the second mobile device; 25
 sending participant data to the second mobile device corresponding to the participant, wherein the participant data comprise the vehicle location data, wherein the second mobile device corresponding to the participant is configured to (1) determine coordinates of a position on the participant map corresponding to the coordinates of the geographical location of the second mobile device, (2) display the participant map, and (3) place a first symbol on the participant map at the determined coordinates of the position on the participant map corresponding to the coordinates of the geographical location of the second mobile device; 30
 sending vehicle data to the first mobile device corresponding to the vehicle, wherein the vehicle data comprise the participant location data, wherein the first mobile device corresponding to the vehicle is configured to (1) determine coordinates of a position on the vehicle map corresponding to the coordinates of the geographical location of the first mobile device, (2) display the vehicle map, and (3) place a second symbol on the vehicle map at the determined coordinates of the position on the vehicle map corresponding to the coordinates of the geographical location of the first mobile device; 35
 receiving participant selection data provided by the second mobile device corresponding to the participant, the participant selection data corresponding to user input provided via a display of the second mobile device; 40
 based on the participant selection data, performing one or more acts selected from the group consisting of: sending updated vehicle data to the first mobile device corresponding to the vehicle, sending updated participant data to the second mobile device corresponding to the participant, and sending a message to the first mobile device corresponding to the vehicle; 45
 receiving entity-of-interest data transmitted by the second mobile device, the entity-of-interest data comprising coordinates of a geographical location of a new entity of interest, wherein the second mobile device is con-

16

figured to (1) identify participant interaction with a display of the second mobile device, the participant interaction indicating selection of a position on the participant map and entry of the new entity of interest at the selected position, (2) display an entity symbol representing the new entity of interest at the selected position on the participant map, (3) determine coordinates of a geographical location of the new entity of interest based on coordinates of the selected position on the participant map, and (4) transmit the entity-of-interest data; and
 sending the entity-of-interest data to the first mobile device corresponding to the vehicle, wherein the first mobile device is configured to place the entity symbol representing the new entity of interest on the vehicle map at a position on the vehicle map corresponding to the geographical location of the new entity of interest.
 2. The method of claim 1, wherein performing the one or more acts comprises sending, based on the participant selection data, the updated participant data to the second mobile device corresponding to the participant, wherein the second mobile device is configured to display the updated participant data within the participant map.
 3. The method of claim 2, wherein the updated participant data comprise updated vehicle location data indicating coordinates of an updated geographical location of the first mobile device corresponding to the vehicle.
 4. The method of claim 1, wherein performing the one or more acts comprises sending, based on the participant selection data, the updated participant data to the second mobile device corresponding to the participant, wherein the second mobile device is configured to replace the participant map with an updated participant map on the display of the second mobile device based at least in part on the updated participant data.
 5. The method of claim 1, wherein performing the one or more acts comprises sending, based on the participant selection data, the message to the first mobile device corresponding to the vehicle.
 6. The method of claim 5, wherein the message to the first mobile device corresponding to the vehicle includes the second identifier and updated participant location data.
 7. The method of claim 1, wherein performing the one or more acts comprises sending, based on the participant selection data, the updated vehicle data to the first mobile device corresponding to the vehicle, wherein the first mobile device is configured to display the updated vehicle data within the vehicle map.
 8. The method of claim 1, wherein performing the one or more acts comprises sending, based on the participant selection data, the updated vehicle data to the first mobile device corresponding to the vehicle, wherein the first mobile device is configured to replace the vehicle map with an updated vehicle map on the display of the first mobile device based at least in part on the updated vehicle data.
 9. The method of claim 1, wherein the vehicle map is interactive.
 10. The method of claim 1, wherein the participant map is interactive.
 11. The method of claim 1, wherein the new entity of interest is an event and the location of the new entity of interest is a location of the event.
 12. The method of claim 1, wherein the new entity of interest location is different from the locations of the first and second mobile devices.

US 10,341,838 B2

17

13. The method of claim 5, wherein the message comprises at least one of a text message, a photograph, or a video.

14. A system comprising:

one or more servers each having one or more processors, the processors configured to execute instructions to perform operations comprising:

obtaining first data provided by a first mobile device corresponding to a vehicle, the first data including a first identifier;

permitting the first mobile device corresponding to the vehicle to join a communication network, the permitting based on a determination regarding the first data;

obtaining second data provided by a second mobile device corresponding to a participant, the second data including a second identifier associated with the participant;

allowing the second mobile device corresponding to the participant to join the communication network, the allowing based on a determination regarding the second data;

receiving vehicle location data provided by the first mobile device corresponding to the vehicle, wherein the vehicle location data are associated with the first identifier and indicate coordinates of a geographical location of the first mobile device;

receiving participant location data provided by the second mobile device corresponding to the participant, wherein the participant location data are associated with the second identifier and indicate coordinates of a geographical location of the second mobile device;

sending participant data to the second mobile device corresponding to the participant, wherein the participant data comprise the vehicle location data, wherein the second mobile device corresponding to the participant is configured to (1) determine coordinates of a position on the participant map corresponding to the coordinates of the geographical location of the second mobile device, (2) display the participant map, and (3) place a first symbol on the participant map at the determined coordinates of the position on the participant map corresponding to the coordinates of the geographical location of the second mobile device;

sending vehicle data to the first mobile device corresponding to the vehicle, wherein the vehicle data comprise the participant location data, wherein the first mobile device corresponding to the vehicle is configured to (1) determine coordinates of a position on the vehicle map corresponding to the coordinates of the geographical location of the first mobile device, (2) display the vehicle map, and (3) place a second symbol on the vehicle map at the determined coordinates of the position on the vehicle map corresponding to the coordinates of the geographical location of the first mobile device;

receiving participant selection data provided by the second mobile device corresponding to the participant, the participant selection data corresponding to user input provided via a display of the second mobile device;

based on the participant selection data, performing one or more acts selected from the group consisting of: sending updated vehicle data to the first mobile device corresponding to the vehicle, sending updated participant data to the second mobile device corresponding to the participant, and sending a message to the first mobile device corresponding to the vehicle;

receiving entity-of-interest data transmitted by the second mobile device, the entity-of-interest data comprising

18

coordinates of a geographical location of a new entity of interest, wherein the second mobile device is configured to (1) identify participant interaction with a display of the second mobile device, the participant interaction indicating selection of a position on the participant map and entry of the new entity of interest at the selected position, (2) display an entity symbol representing the new entity of interest at the selected position on the participant map, (3) determine coordinates of a geographical location of the new entity of interest based on coordinates of the selected position on the participant map, and (4) transmit the entity-of-interest data; and

sending the entity-of-interest data to the first mobile device corresponding to the vehicle, wherein the first mobile device is configured to place the entity symbol representing the new entity of interest on the vehicle map at a position on the vehicle map corresponding to the geographical location of the new entity of interest.

15. The system of claim 14, wherein performing the one or more acts comprises sending, based on the participant selection data, the updated participant data to the second mobile device corresponding to the participant, wherein the second mobile device is configured to display the updated participant data within the participant map.

16. The system of claim 15, wherein the updated participant data comprise updated vehicle location data indicating coordinates of an updated geographical location of the first mobile device corresponding to the vehicle.

17. The system of claim 14, wherein performing the one or more acts comprises sending, based on the participant selection data, the updated participant data to the second mobile device corresponding to the participant, wherein the second mobile device is configured to replace the participant map with an updated participant map on the display of the second mobile device based at least in part on the updated participant data.

18. The system of claim 14, wherein performing the one or more acts comprises sending, based on the participant selection data, the message to the first mobile device corresponding to the vehicle.

19. The system of claim 18, wherein the message to the first mobile device corresponding to the vehicle includes the second identifier and updated participant location data.

20. The system of claim 14, wherein performing the one or more acts comprises sending, based on the participant selection data, the updated vehicle data to the first mobile device corresponding to the vehicle, wherein the first mobile device is configured to display the updated vehicle data within the vehicle map.

21. The system of claim 14, wherein performing the one or more acts comprises sending, based on the participant selection data, the updated vehicle data to the first mobile device corresponding to the vehicle, wherein the first mobile device is configured to replace the vehicle map with an updated vehicle map on the display of the first mobile device based at least in part on the updated vehicle data.

22. The system of claim 14, wherein the vehicle map is interactive.

23. The system of claim 14, wherein the participant map is interactive.

24. The system of claim 14, wherein the new entity of interest is an event and the location of the new entity of interest is a location of the event.

25. The system of claim 14, wherein the new entity of interest location is different from the locations of the first and second mobile devices.

US 10,341,838 B2

19

26. The system of claim **18**, wherein the message comprises at least one of a text message, a photograph, or a video.

* * * * *

20

Exhibit F

**IN THE UNITED STATES DISTRICT COURT
FOR THE EASTERN DISTRICT OF TEXAS
MARSHALL DIVISION**

AGIS SOFTWARE DEVELOPMENT LLC,	§	Case No. 2:21-cv-00072-JRG
	§	(LEAD CASE)
Plaintiff,	§	
	§	<u>JURY TRIAL DEMANDED</u>
v.	§	
	§	
T-MOBILE USA, INC. and T-MOBILE US,	§	
INC.,	§	
	§	
Defendants.	§	

AGIS SOFTWARE DEVELOPMENT LLC,	§	Case No. 2:21-cv-00024-JRG
	§	(CONSOLIDATED CASE)
Plaintiff,	§	
	§	<u>JURY TRIAL DEMANDED</u>
v.	§	
	§	
LYFT, INC.,	§	
	§	
Defendant.	§	

**PLAINTIFF’S DISCLOSURE OF ASSERTED CLAIMS
AND INFRINGEMENT CONTENTIONS**

Plaintiff AGIS Software Development LLC (“AGIS”) hereby makes the following infringement disclosures under the Patent Local Rules with respect to United States Patent Nos. 7,031,728; 7,630,724; 8,213,970; 10,299,100, and 10,341,838 (collectively, “Patents-in-Suit”). AGIS’s investigation is ongoing and discovery has not yet commenced. Accordingly, these disclosures are based on information available to AGIS at this time. AGIS reserves the right to supplement this disclosure after further discovery from defendant and non-parties, particularly documents and other discovery regarding the Lyft Accused Products set forth below. AGIS also reserves the right to assert additional claims of the Patents-in-Suit, accuse different

products, or find alternative literal and/or equivalent infringing elements in the Lyft Accused Products.

I. DISCLOSURE OF ASSERTED CLAIMS AND INFRINGEMENT CONTENTIONS PURSUANT TO PATENT LOCAL RULE 3-1

A. ASSERTED CLAIMS

Defendant Lyft, Inc. (“Defendant” or “Lyft”) has infringed and continues to infringe at least the following claims of the Patents-in-Suit in connection with the Lyft Accused Products set forth below:

- Claim 7 of the ’728 Patent;
- Claims 9, 12-16 of the ’724 Patent;
- Claims 2, 10-13 of the ’970 Patent;
- Claims 1-31 of the ’100 Patent; and
- Claims 1-26 of the ’838 Patent.

AGIS reserves the right to seek leave of court to add, delete, substitute, or otherwise amend this list of asserted claims should further discovery, the Court’s claim construction, or other circumstances so merit.

B. ACCUSED INSTRUMENTALITIES

AGIS is currently aware that the following Lyft Products infringe each of the Patents-in-Suit, either alone or in concert with one or more other Lyft Accused Products:

- Lyft applications, services, and servers; and
- Lyft Driver applications, services, and servers.

AGIS reserves the right to amend this list of accused instrumentalities, as well as other information contained in this document and the exhibits hereto, to incorporate new information

learned during the course of discovery including, but not limited to, the inclusion of newly-released products or any other equivalent devices ascertained through discovery.

C. CLAIM CHARTS

Claim charts identifying a location of every element of every asserted claim of the Patents-in-Suit within Lyft Accused Products are attached hereto as Exhibits A-E. AGIS believes that the citations in the claim charts are representative of all Lyft Accused Products. For example, where AGIS cites reference material or images representing an application, service, or server that citation is representative for all other such applications, services, or servers including all prior and future versions unless otherwise noted. AGIS reserves the right to amend these claim charts as well as other information contained in this document and the exhibits hereto, to incorporate new information learned during the course of discovery including, but not limited to, information that is not publicly available or readily discernible without discovery. AGIS further reserves the right to amend these claim charts, as well as other information contained in this document and the exhibits attached hereto, pursuant to Patent Local Rules 3-1(g) and 3-6.

D. LITERAL INFRINGEMENT AND DOCTRINE OF EQUIVALENTS

AGIS asserts that, under the proper construction of the asserted claims and their claim terms, the limitations of the asserted claims of the Patents-in-Suit are literally present in the Lyft Accused Products as set forth in the claim charts attached hereto as Exhibits A-E. AGIS contends that any and all elements found not to be literally infringed are infringed under the doctrine of equivalents because the differences between the claimed inventions and the accused instrumentalities, if any, are insubstantial.

AGIS contends that Lyft directly infringes the asserted claims by making, using, offering for sale, selling, and importing into the United States the accused instrumentalities as well as indirectly infringe by contributing to and/or inducing others (*e.g.*, Lyft customers or its Lyft

customers' customers) to directly infringe those claims by making, using, offering for sale, or selling the Lyft Accused Products. AGIS contends that Lyft directly infringes the asserted claims by testing the Lyft Accused Products in the United States.

Pursuant to Patent Local Rule 3-6(a)(1), AGIS reserves the right to amend its Infringement Contentions as to literal infringement or infringement under the doctrine of equivalents, *e.g.*, in light of the Court's claim construction.

E. PRIORITY DATES

Under P.R. 3-1(e), each of the asserted claims of the Patents-in-Suit are entitled to a priority date of at least as early as September 21, 2004.¹ AGIS reserves the right to establish an earlier date of invention based upon actions related to conception and reduction to practice of the claimed inventions.

F. AGIS'S OWN PRODUCTS

Pursuant to P.R. 3-1(f), AGIS contends that AGIS, Inc.'s LifeRing products are covered by at least one of claim 7 of the '728 Patent; claims 9, 12-16 of the '724 Patent; claims 2, 10-13 of the '970 Patent; claims 1-31 of the '100 Patent; and claims 1-26 of the '838 Patent. AGIS's investigation is ongoing and AGIS reserves the right to supplement, amend, or amend these contentions in view of facts learned during discovery, the release of new products, or the modification of current products, and/or the Court's claim construction.

II. PRODUCTION OF DOCUMENTS PURSUANT TO PATENT LOCAL RULE 3-2

¹ AGIS continues to rely on interim priority dates identified in each of the Patents-in-Suit to establish priority prior to the actual filing date of the Patents-in-Suit (*e.g.*, interim priority date April 17, 2006 which corresponds to the filing date of U.S. Patent No. 7,630,724).

AGIS is producing or making available for inspection documents that are in AGIS's possession, custody, or control as set forth in Patent Local Rule 3-2. An AGIS 3-2 Production Index identifying these documents is attached hereto.

This preliminary identification of documents is for convenience and is not an admission that each document falls within any exemplary categories in the Patent Local Rules, or that any document qualifies as prior art. AGIS is continuing with its investigation, particularly with respect to ESI. Thus, AGIS reserves its right to add to, delete from, or otherwise modify its disclosures in this section as its investigation proceeds.

Production of these documents is governed by Patent Local Rule 2-2, and, with the exception of documents produced pursuant to P.R. 3.2(c) and public documents listed in the infringement charts, are considered "Confidential – Outside Attorneys Eyes Only" and disclosure of the confidential document or information shall be limited to each party's outside attorney(s) of record and the employees of such outside attorney(s).

Dated: May 19, 2021

Respectfully submitted,

FABRICANT LLP

/s/ Alfred R. Fabricant

Alfred R. Fabricant

NY Bar No. 2219392

Email: ffabricant@fabricantllp.com

Peter Lambrianakos

NY Bar No. 2894392

Email: plambrianakos@fabricantllp.com

Vincent J. Rubino, III

NY Bar No. 4557435

Email: vrubino@fabricantllp.com

FABRICANT LLP

411 Theodore Fremd Road, Suite 206 South
Rye, New York 10580

Telephone: (212) 257-5797

Facsimile: (212) 257-5796

**ATTORNEYS FOR PLAINTIFF,
AGIS SOFTWARE DEVELOPMENT
LLC**

CERTIFICATE OF SERVICE

The undersigned hereby certifies that, on May 19, 2021, all counsel of record are being served with a copy of this document via electronic mail.

/s/ Alfred R. Fabricant _____
Alfred R. Fabricant

AGIS 3-2 PRODUCTION INDEX

3-2(a)	Bates Start AGISSOFTWARE_0000001	Bates End AGISSOFTWARE_0000062
3-2(b)	Bates Start AGISSOFTWARE_0007713	Bates End AGISSOFTWARE_0007871
3-2(c)	Bates Start AGISSOFTWARE_0000063	Bates End AGISSOFTWARE_0007712

Public Documents Listed in Infringement Charts

Bates Start AGIS-LYFT0000001	Bates End AGIS-LYFT0000114
--	--------------------------------------

Exhibit A for US Patent No. 10,341,838 Against Lyft Accused Products

Based on information presently available, AGIS Software Development LLC (“AGIS”) contends that Defendant Lyft Inc. (collectively “Lyft” or “Defendant”) infringes claims 1-26 (the “Asserted Claims”) of U.S. Patent No. 10,341,838 (the “’838 Patent”) through the Accused Products which are manufactured, sold, offered for sale, and/or used by Lyft.

The Accused Products comprise all versions of the Lyft Application made, used, sold, offered for sale, or otherwise provided, after September 21, 2004. For example, the Accused Products comprise the Lyft application installed on all Android, iOS, Blackberry, and Windows Mobile based mobile devices (e.g. smartphones, tablets, laptops, and smart watches), and any variants thereof. AGIS reserves the right to amend this list of Accused Products as discovery progresses.

Lyft directly infringes each of the Asserted Claims by using, importing, testing, selling, and/or offering for sale the Accused Products in violation of 35 U.S.C. § 271(a).

Lyft indirectly infringes the Asserted Claims in violation of 35 U.S.C. § 271(b) by inducing third parties, including its users and/or customers, to directly infringe through their operation and use of the Accused Products. Lyft has knowingly and intentionally induced this direct infringement by, *inter alia*, (i) selling, importing, or otherwise providing the Accused Products to third parties with the intent that the Accused Products will be operated and used in a manner that practices the Asserted Claims; and (ii) marketing and advertising the Accused Products. Lyft’s marketing and promotional materials for the Accused Products are found, for example, on Lyft’s website, and in App stores of operating systems for which the Accused Products are made available. For example, Lyft’s website offers customers instructions and/or manuals for the Accused Products that instruct customers to, among other things, use the accused services in the Accused Products. Lyft’s website also offers support to customers, including instruction to, among other things, use the Accused Products share location information with a group of users. On information and belief, Lyft knows that its actions will result in infringement of the Asserted Claims, or subjectively believes that there is a high probability that its actions will result in infringement of the Asserted Claims but has taken deliberate actions to avoid learning these facts.

Lyft also contributorily infringes each of the Asserted Claims in violation of 35 U.S.C. § 271(c) by selling, importing, offering for sale, and otherwise providing the Accused Products, which when used directly infringe the Asserted Claims. The Accused Products constitute a material part of the Asserted Claims.

On information and belief, the charted version of the Lyft application is representative of all versions of the Accused Products, including all variants of the Accused Products made, sold, offered for sale, or used on any version of the Android, iOS, Blackberry, and Windows Mobile operating systems.

Exhibit A for US Patent No. 10,341,838 Against Lyft Accused Products

AGIS does not concede that any claims of the '838 Patent that are not listed below are not infringed by the identified Accused Products. Moreover, the citations to certain documents and other information below are intended to be exemplary only and in no way foreclose AGIS from citing or relying on additional documents, information, source code, and/or testimony at a later time. These contentions are preliminary in nature, and an analysis of Lyft's products, internal documentation, source code, and/or testimony from relevant witnesses may more fully and accurately describe the infringing features of its Accused Products. Accordingly, AGIS reserves the right to supplement, correct, modify, and/or amend these contentions once such additional information is made available to AGIS. Furthermore, AGIS reserves the right to supplement, correct, modify, and/or amend these contentions as discovery in this case progresses; in view of the Court's claim construction order(s); in view of any positions taken by Lyft, including, but not limited to, positions on claim construction,¹ invalidity, and/or non-infringement; and in connection with the preparation and exchange of expert reports.

The contents of each claim cell below on which another claim cell depends are expressly incorporated by reference in that dependent cell, as if set forth in their entirety therein.

¹ The construction of claim terms herein is consistent with the constructions in *AGIS Software Dev. LLC v. Huawei Device USA, Inc.*, No. 2:17-cv-00513-JRG, Dkt. No. 205 (Lead Case) (E.D. Tex. Oct. 10, 2018) and *AGIS Software Dev. LLC v. Google LLC*, No. 2:19-cv-00361-JRG, Dkt. No. 147 (Lead Case) (E.D. Tex. Dec. 20, 2020). AGIS reserves the right to update its constructions and contentions in view of this Court's claim construction order.

Exhibit A for US Patent No. 10,341,838 Against Lyft Accused Products

Claim 10,341,838	Exemplary Supporting Evidence Regarding Accused Products
<p>1[P]. A method performed by one or more servers each having one or more processors, the method comprising:</p>	<p>The Lyft Accused Products perform the computer implemented method as set forth below. Lyft further infringes directly and/or indirectly by performing, inducing others to perform, and/or contributing to the performance of: a method performed by one or more servers each having one or more processors</p> <p>This element is infringed literally, or in the alternative, under the doctrine of equivalents.</p> <p>For example, Lyft provides the Lyft app for passengers and the Lyft Driver app for drivers. The Lyft apps for riders and drivers, in conjunction with Lyft’s servers and services, provide users with interactive methods to request, view, and track locations of passengers/riders using real-time maps and communications. Lyft provides one or more servers with processors (either hardware or software). The Lyft server(s) and their services communicate with the Lyft apps for riders and drivers. The Lyft server(s) and their services host information related to and instructions for processing user/device/vehicle accounts, location data, and map data.</p> <h2 style="margin: 0;">Lyft Driver app</h2> <div style="border: 2px solid red; padding: 5px; margin: 10px 0;"> <p>We’ve separated the passenger and driver experiences into two separate mobile apps — one exclusively for passengers (named the Lyft app) and the other exclusively for drivers (named the Lyft Driver app).</p> </div> <p>The Lyft Driver app will eventually be standard for all drivers and required for driving. At this time, drivers can keep using the Lyft app to give rides. Don’t worry! While we have some planned improvements to the Lyft Driver app, we’ve kept its features the same.</p> <p>https://help.lyft.com/hc/en-ca/articles/115013079208-Lyft-Driver-app</p> <h2 style="margin: 0;">What is Lyft?</h2> <p>Lyft is a platform that connects drivers with individuals and organizations that need rides.</p> <p>https://www.lyft.com/drive-with-lyft</p>

Exhibit A for US Patent No. 10,341,838 Against Lyft Accused Products

Claim 10,341,838	- Exemplary Supporting Evidence Regarding Accused Products
	 <p data-bbox="445 699 569 727">Go online</p> <p data-bbox="445 764 1640 873">Open your Lyft Driver app and tap the steering wheel icon. Lyft will now find the closest passenger to your location requesting a ride. Turn on some music and get comfortable: that first ride request may come quickly or may take a while, depending on the number of current passenger requests.</p> <p data-bbox="445 878 1104 911">https://www.lyft.com/hub/posts/how-to-give-a-ride</p>

Exhibit A for US Patent No. 10,341,838 Against Lyft Accused Products

Claim 10,341,838	- Exemplary Supporting Evidence Regarding Accused Products
	<p data-bbox="493 300 709 457">Driver's device displaying passenger's ride request message</p>  <p data-bbox="445 919 1360 954">https://www.youtube.com/watch?v=jVUy9poJDng at 10:24, Annotated</p>

Exhibit A for US Patent No. 10,341,838 Against Lyft Accused Products

Claim 10,341,838	- Exemplary Supporting Evidence Regarding Accused Products
	<div style="text-align: center;">  </div> <p style="text-align: center; color: blue;"> https://www.youtube.com/watch?v=j0RDMLcmOgU at 4:01 </p> <p>Further, to the extent this element is performed at least in part by Lyft's software source code, AGIS reserves the right to supplement these contentions pursuant to production of such source code by Lyft and to the extent Defendant requires additional information in accordance with P.R. 3-1 and for any other reasons.</p>
<p>1[A]. executing operations on the one or more processors, the</p>	<p>The Lyft Accused Products infringe directly and/or indirectly by performing, inducing others to perform, and/or contributing to the performance of: executing operations on the one or more processors, the operations.</p> <p>This element is infringed literally, or in the alternative, under the doctrine of equivalents.</p>

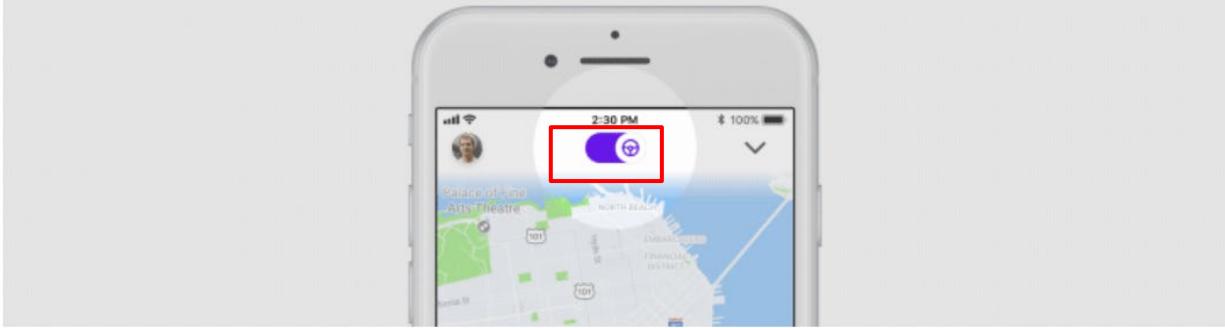
Exhibit A for US Patent No. 10,341,838 Against Lyft Accused Products

Claim 10,341,838	- Exemplary Supporting Evidence Regarding Accused Products
operations comprising:	<p>For example, Lyft servers comprise processors which receive passenger's request for a ride and communicate the request to the nearby drivers. The nearby drivers receive the request for a ride from the passengers which they accept or decline. The servers further facilitate the communication between the passenger and the allocated driver during a ride.</p>  <p>https://www.youtube.com/watch?v=jVUy9poJDng at 10:24, Annotated</p>

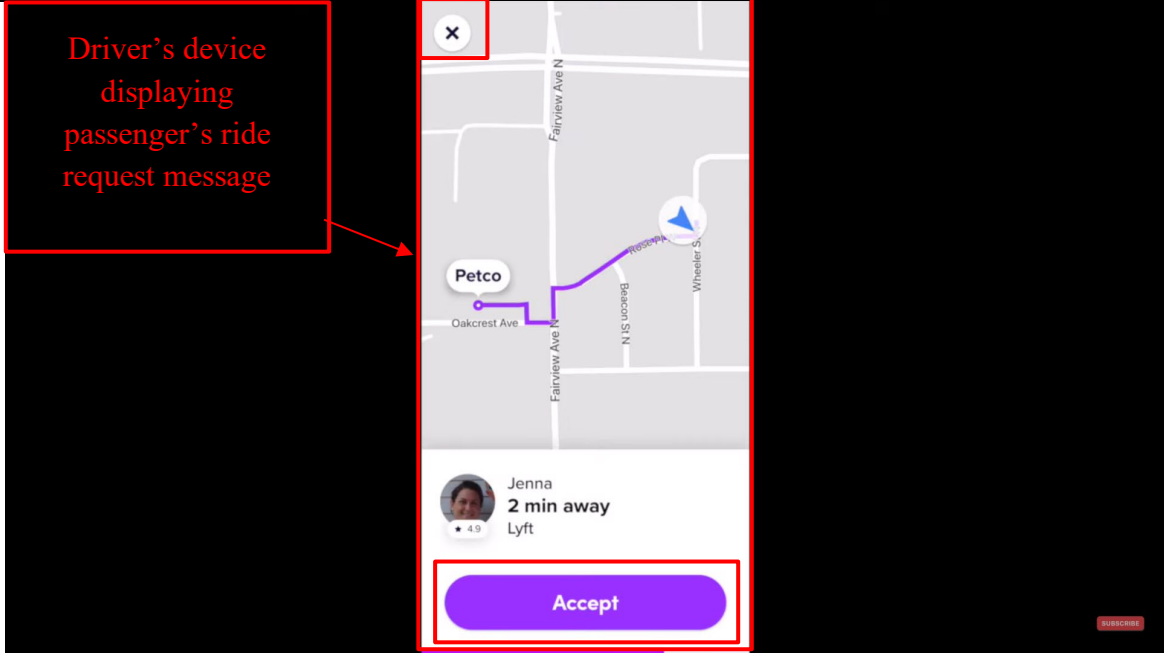
Exhibit A for US Patent No. 10,341,838 Against Lyft Accused Products

Claim 10,341,838	- Exemplary Supporting Evidence Regarding Accused Products
	 <p>https://www.youtube.com/watch?v=j0RDMLcmOgU at 4:01</p> <p>Further, to the extent this element is performed at least in part by Lyft's software source code, AGIS reserves the right to supplement these contentions pursuant to production of such source code by Lyft and to the extent Defendant requires additional information in accordance with P.R. 3-1 and for any other reasons.</p>
1[B]. obtaining first data provided by a first mobile	The Lyft Accused Products infringe directly and/or indirectly by performing, inducing others to perform, and/or contributing to the performance of: obtaining first data provided by a first mobile device corresponding to a vehicle, the first data including a first identifier.

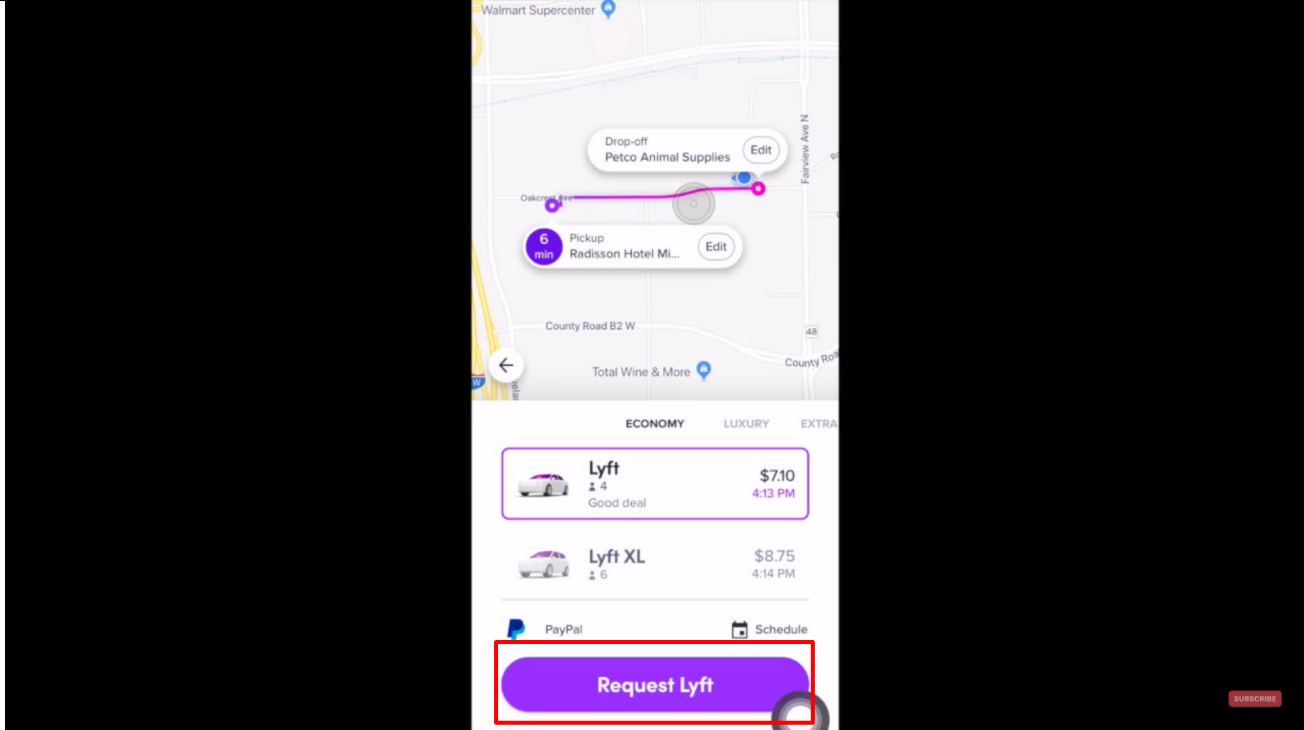
Exhibit A for US Patent No. 10,341,838 Against Lyft Accused Products

Claim 10,341,838	- Exemplary Supporting Evidence Regarding Accused Products
<p>device corresponding to a vehicle, the first data including a first identifier</p>	<p>This element is infringed literally, or in the alternative, under the doctrine of equivalents.</p> <p>For example, the Lyft driver sets up his/her account by providing information including but not limited to name, email address, phone number, driver’s license and vehicle information. On information and belief, Lyft assigns one or more indentifications associated with the account.</p> <p>For example, the Lyft Driver app installed in a driver’s mobile device allows a driver to set up his/her account by providing information including but not limited to name, email address, phone number, driver’s license and vehicle information. The Lyft server(s) perform this limitation when they obtain the account creation data from the Lyft app for drivers. The Lyft server(s) also perform this limitation, after account creation, when they obtain the data during the sign-in or log-in process from the Lyft app for drivers. On information and belief, the Lyft server(s) also perform this limitation when they obtain the data by requesting status or other data via the Lyft app for drivers. In all cases, the first identifier is information associated with the identity of the driver, account, vehicle, or Lyft app for drivers.</p>

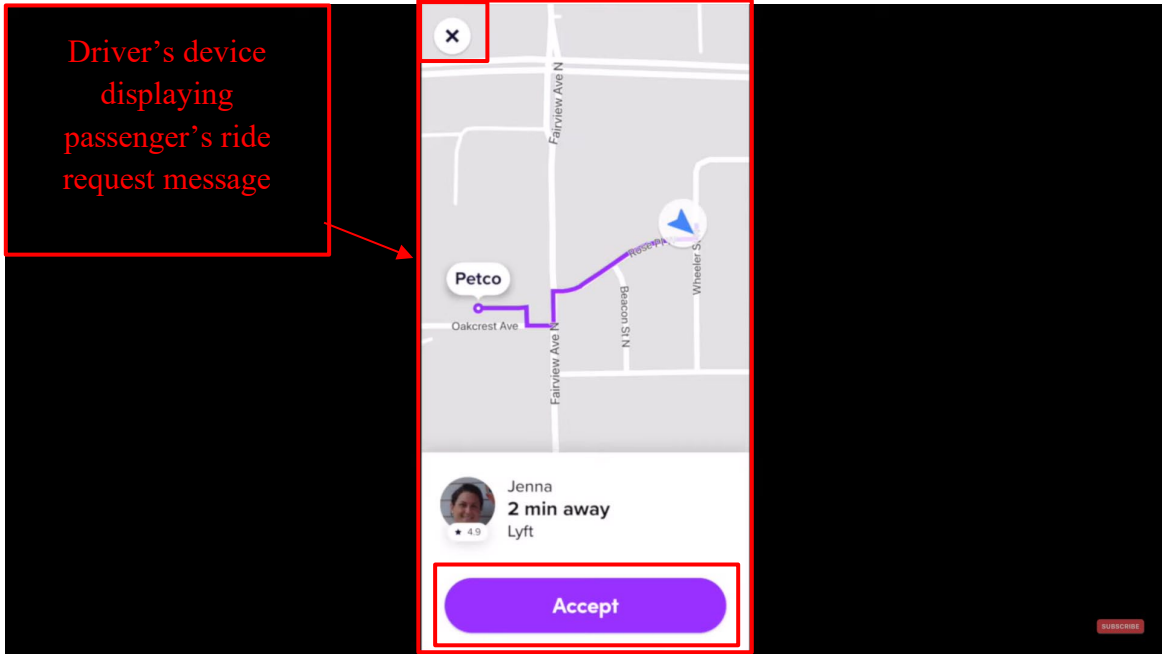
Exhibit A for US Patent No. 10,341,838 Against Lyft Accused Products

Claim 10,341,838	- Exemplary Supporting Evidence Regarding Accused Products
 <p>Source: https://www.lyft.com/driver.</p>	

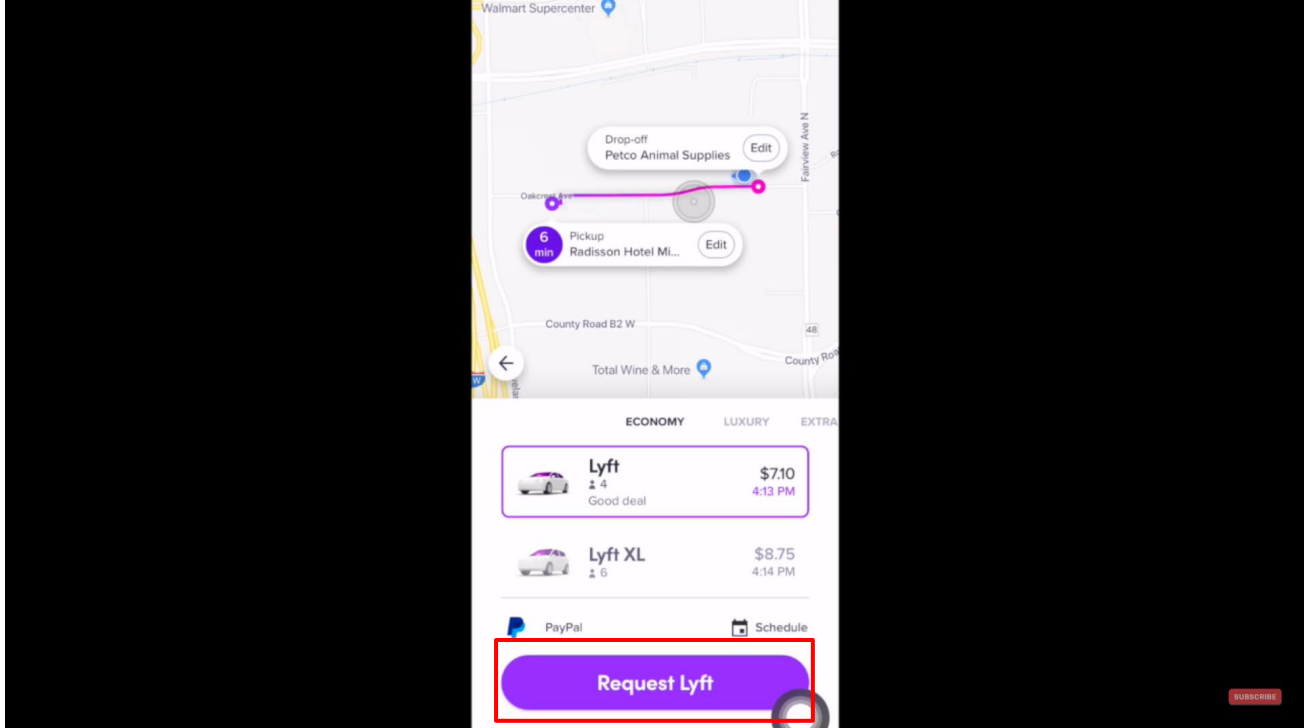
Exhibit A for US Patent No. 10,341,838 Against Lyft Accused Products

Claim 10,341,838	- Exemplary Supporting Evidence Regarding Accused Products
	 <p>The screenshot shows a mobile app interface for Lyft. At the top left is the Lyft logo. Below it, the text reads "Welcome back to Lyft!". Underneath, it says "We'll send a text to verify your phone." There is a text input field containing a dropdown menu with a US flag icon and the text "+1 Phone number". Below the input field is a checkbox labeled "Keep me signed in". At the bottom of the screen is a large purple button labeled "Next". Below the button, it asks "Have a new number?" and provides a link "Find your account" with a magnifying glass icon.</p>

Exhibit A for US Patent No. 10,341,838 Against Lyft Accused Products

Claim 10,341,838	- Exemplary Supporting Evidence Regarding Accused Products
	<p>Source: https://account.lyft.com/auth?next=https%3A%2F%2Fwww.lyft.com%2Flogin%2Fjump.</p> <h1 data-bbox="457 354 1146 428">Driver requirements</h1> <p data-bbox="457 477 1751 542">All Lyft drivers must meet certain requirements to drive on the platform. Applicant and vehicle requirements can vary depending on your City or State.</p> <p data-bbox="457 574 1339 607">To start an application, see How to apply to become a driver for instructions.</p> <p data-bbox="457 639 554 672">Skip to:</p> <ul data-bbox="520 704 1094 1094" style="list-style-type: none"><li data-bbox="520 704 890 737">• State and local requirement<ul data-bbox="625 753 957 883" style="list-style-type: none"><li data-bbox="625 753 869 786">◦ Age requirement<li data-bbox="625 802 957 834">◦ Vehicle requirements<li data-bbox="625 850 848 883">◦ Driving history<li data-bbox="520 915 785 948">• Background check<li data-bbox="520 964 701 997">• DMV check<li data-bbox="520 1013 1094 1045">• Driver license, license plates, and insurance<li data-bbox="520 1062 1003 1094">• Community Safety Education program <p data-bbox="449 1127 1339 1159">https://help.lyft.com/hc/e/articles/115012925687-Driver-requirements</p>

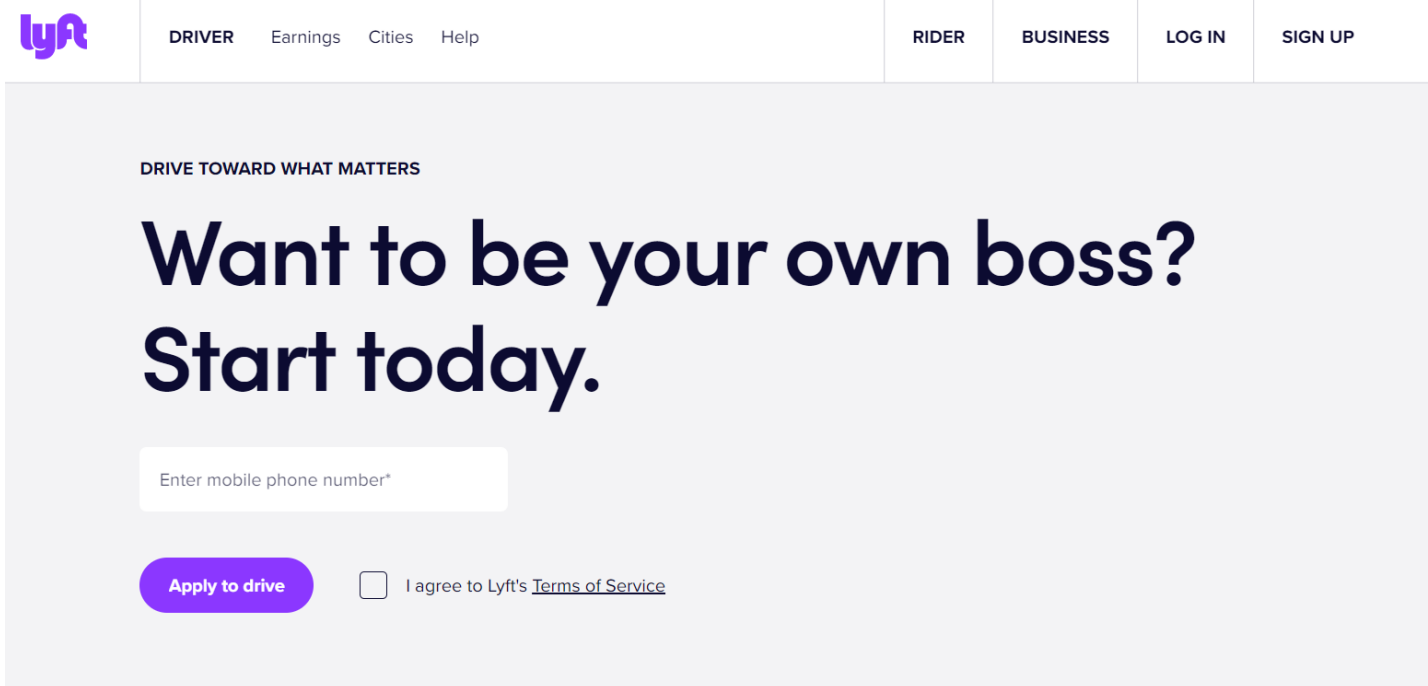
Exhibit A for US Patent No. 10,341,838 Against Lyft Accused Products

Claim 10,341,838	- Exemplary Supporting Evidence Regarding Accused Products
	<p>How to start an application</p> <p>Create a Lyft account through the app or on the web at lyft.com/drivers.</p> <p>Enter your name, phone number, and email address, then submit all the info we need to ensure you meet the requirements. If you sign out of your account, any application info you've submitted will be saved.</p> <p>If you have a promo code, enter it when creating an account. If you apply through a link on a website, the code will be added automatically.</p> <p>Back to top</p> <p>https://help.lyft.com/hc/e/articles/115013081188</p> <p>Applicant Waitlist</p> <p>New applicants will be automatically added to our waitlist. This makes sure there's a better balance of drivers and passengers in your region.</p> <p>The waitlist is a hold on your application request that will be removed when additional spots for new drivers open up in your city. It's hard to say exactly how long you'll be on the waitlist due to a variety of factors that affect demand in certain areas. The waitlist doesn't impact existing drivers. We'll send you a notification as soon as a spot opens up!</p> <p>As soon as you're removed from the waitlist you'll be able to complete all necessary application steps. Once your application and documents are approved, you can start driving.</p> <p>https://help.lyft.com/hc/e/articles/115013081188</p> <p>Further, to the extent this element is performed at least in part by Lyft's software source code, AGIS reserves the right to supplement these contentions pursuant to production of such source code by Lyft and to the extent Defendant requires additional information in accordance with P.R. 3-1 and for any other reasons.</p>

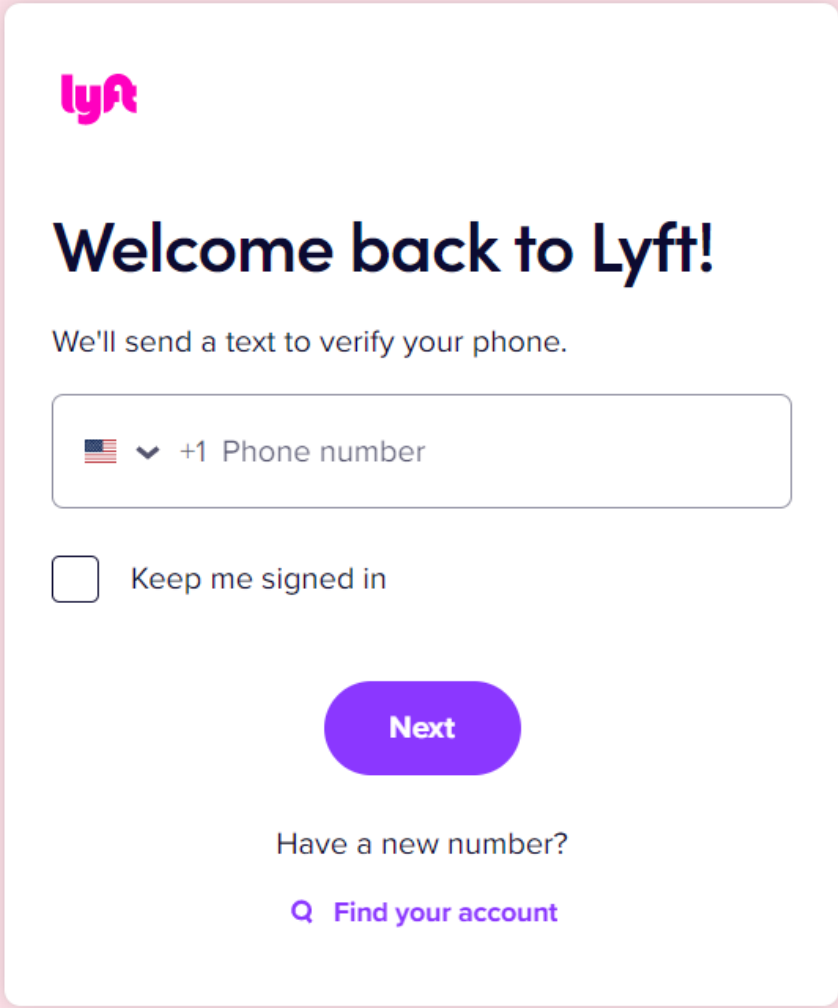
Exhibit A for US Patent No. 10,341,838 Against Lyft Accused Products

Claim 10,341,838	- Exemplary Supporting Evidence Regarding Accused Products
<p>1[C]. permitting the first mobile device corresponding to the vehicle to join a communication network, the permitting based on a determination regarding the first data</p>	<p>The Lyft Accused Products infringe directly and/or indirectly by performing, inducing others to perform, and/or contributing to the performance of: permitting the first mobile device corresponding to the vehicle to join a communication network, the permitting based on a determination regarding the first data.</p> <p>This element is infringed literally, or in the alternative, under the doctrine of equivalents.</p> <p>The Lyft server(s) perform this limitation when the server uses the account or identity information described above to add the account/driver/vehicle to the Lyft platform or network of drivers and passengers. The Lyft server(s) also perform this limitation when the server uses the account or identity information to create or activate or update an account using the account or identity information described above. The Lyft server(s) also perform this limitation when a driver completes the sign-in or log-in process. On information and belief, the Lyft server(s) also perform this step using a verification or validation process within sign-up, sign-in, or status request process. On information and belief, the account or identity information is associated with the Lyft platform or network of drivers and passengers or a subset of the platform or network.</p>

Exhibit A for US Patent No. 10,341,838 Against Lyft Accused Products

Claim 10,341,838	- Exemplary Supporting Evidence Regarding Accused Products
	 <p>Source: https://www.lyft.com/driver.</p>

Exhibit A for US Patent No. 10,341,838 Against Lyft Accused Products

Claim 10,341,838	- Exemplary Supporting Evidence Regarding Accused Products
	

Exhibit A for US Patent No. 10,341,838 Against Lyft Accused Products

Claim 10,341,838	- Exemplary Supporting Evidence Regarding Accused Products
	<p>Source: https://account.lyft.com/auth?next=https%3A%2F%2Fwww.lyft.com%2Flogin%2Fjump.</p> <h1>Driver requirements</h1> <p>All Lyft drivers must meet certain requirements to drive on the platform. Applicant and vehicle requirements can vary depending on your City or State.</p> <p>To start an application, see How to apply to become a driver for instructions.</p> <p>Skip to:</p> <ul style="list-style-type: none">• State and local requirement<ul style="list-style-type: none">◦ Age requirement◦ Vehicle requirements◦ Driving history• Background check• DMV check• Driver license, license plates, and insurance• Community Safety Education program <p>https://help.lyft.com/hc/e/articles/115012925687-Driver-requirements</p>

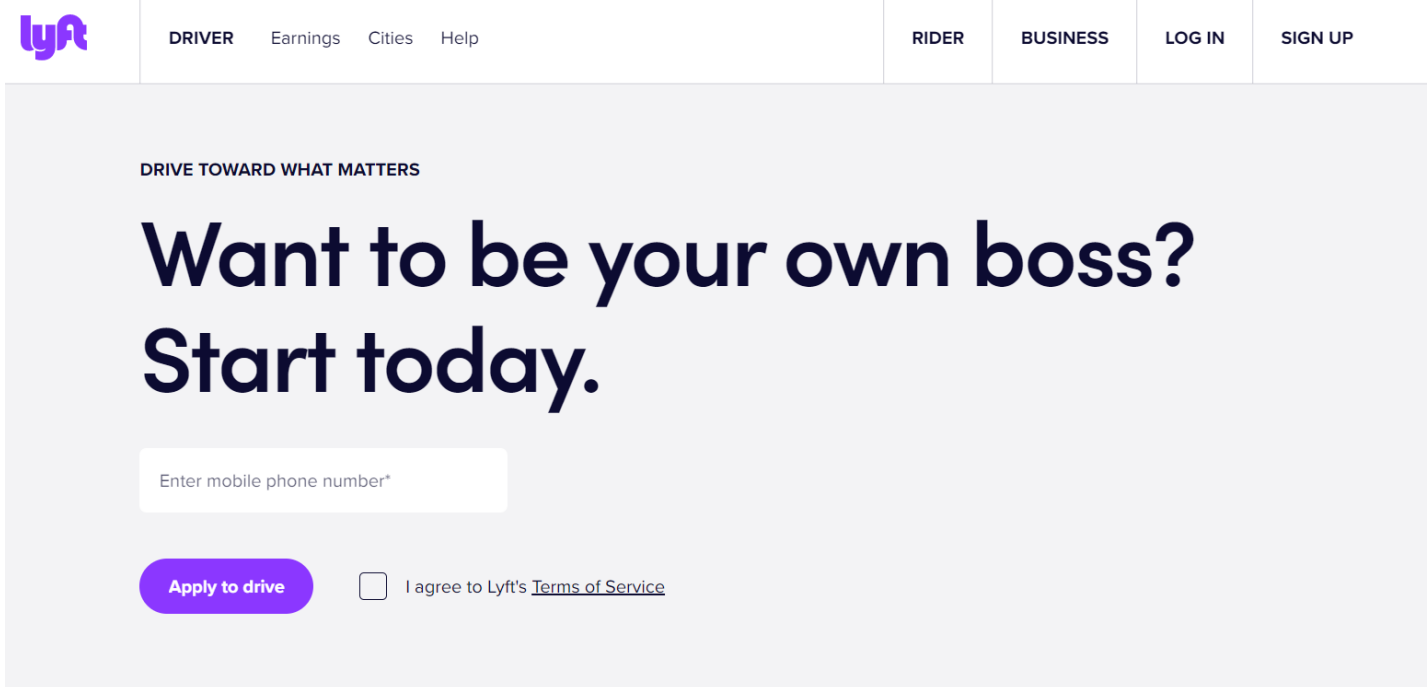
Exhibit A for US Patent No. 10,341,838 Against Lyft Accused Products

Claim 10,341,838	- Exemplary Supporting Evidence Regarding Accused Products
	<h3 data-bbox="453 277 968 318">How to start an application</h3> <p data-bbox="453 354 1289 378">Create a Lyft account through the app or on the web at lyft.com/drivers.</p> <p data-bbox="453 415 1703 477">Enter your name, phone number, and email address, then submit all the info we need to ensure you meet the requirements. If you sign out of your account, any application info you've submitted will be saved.</p> <p data-bbox="453 514 1724 576">If you have a promo code, enter it when creating an account. If you apply through a link on a website, the code will be added automatically.</p> <p data-bbox="453 613 583 638">Back to top</p> <p data-bbox="453 659 1073 683">https://help.lyft.com/hc/e/articles/115013081188</p> <h3 data-bbox="453 732 793 773">Applicant Waitlist</h3> <p data-bbox="453 810 1713 872">New applicants will be automatically added to our waitlist. This makes sure there's a better balance of drivers and passengers in your region.</p> <p data-bbox="453 909 1745 1037">The waitlist is a hold on your application request that will be removed when additional spots for new drivers open up in your city. It's hard to say exactly how long you'll be on the waitlist due to a variety of factors that affect demand in certain areas. The waitlist doesn't impact existing drivers. We'll send you a notification as soon as a spot opens up!</p> <p data-bbox="453 1075 1703 1136">As soon as you're removed from the waitlist you'll be able to complete all necessary application steps. Once your application and documents are approved, you can start driving.</p> <p data-bbox="453 1174 1073 1198">https://help.lyft.com/hc/e/articles/115013081188</p> <p data-bbox="443 1245 1894 1346">Further, to the extent this element is performed at least in part by Lyft's software source code, AGIS reserves the right to supplement these contentions pursuant to production of such source code by Lyft and to the extent Defendant requires additional information in accordance with P.R. 3-1 and for any other reasons.</p>

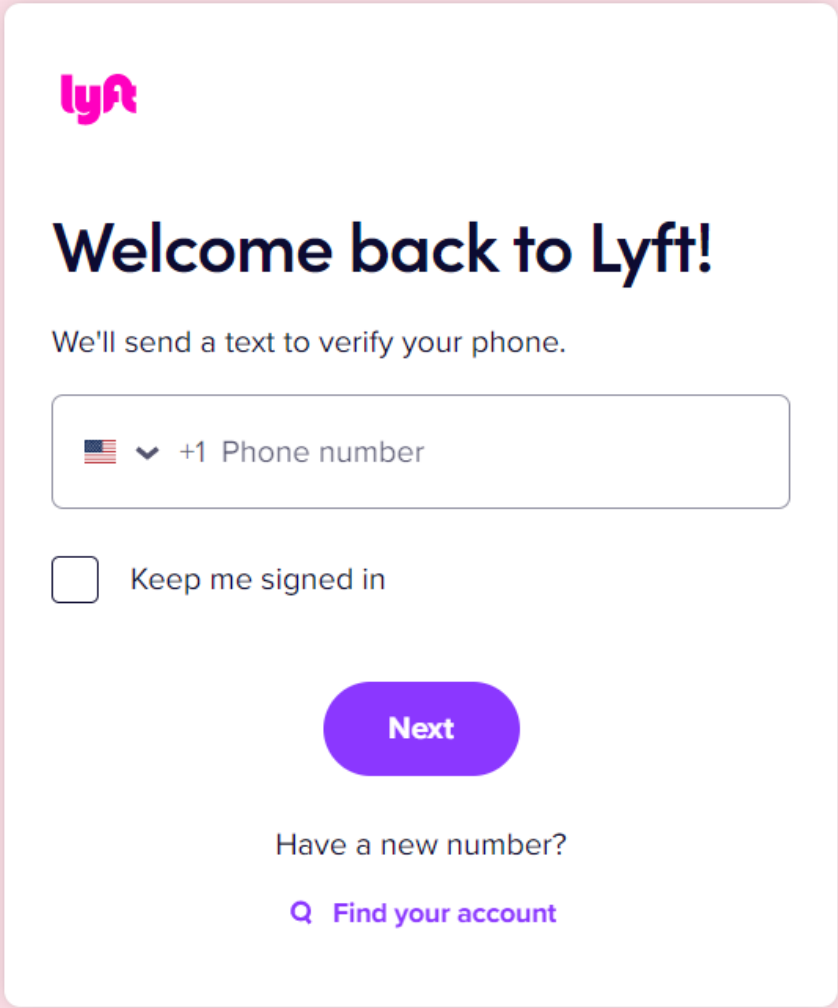
Exhibit A for US Patent No. 10,341,838 Against Lyft Accused Products

Claim 10,341,838	- Exemplary Supporting Evidence Regarding Accused Products
<p>1[D]. obtaining second data provided by a second mobile device corresponding to a participant, the second data including a second identifier associated with the participant</p>	<p>The Lyft Accused Products infringe directly and/or indirectly by performing, inducing others to perform, and/or contributing to the performance of: obtaining second data provided by a second mobile device corresponding to a participant, the second data including a second identifier associated with the participant.</p> <p>This element is infringed literally, or in the alternative, under the doctrine of equivalents.</p> <p>For example, the Lyft app installed on a passenger’s mobile device allows a passenger to set up his/her account by providing information including but not limited to name, email address and phone number. The Lyft server(s) perform this limitation when they obtain the account creation data from the Lyft app for riders. The Lyft server(s) also perform this limitation, after account creation, when they obtain the data during the sign-in or log-in process from the Lyft app for riders. On information and belief, the Lyft server(s) also perform this limitation when they obtain the data by requesting status or other data via the Lyft app for riders. In all cases, the second identifier is information associated with the identity of the rider, account, device, phone number, or Lyft app for riders.</p>

Exhibit A for US Patent No. 10,341,838 Against Lyft Accused Products

Claim 10,341,838	- Exemplary Supporting Evidence Regarding Accused Products
	<p data-bbox="478 297 911 337">Sign up for a Lyft account</p> <p data-bbox="478 365 997 389">Before you begin, be sure you have the following:</p> <ul data-bbox="537 418 779 532" style="list-style-type: none">• Your phone number• Your email address• A photo of yourself <p data-bbox="478 574 600 599">Get started</p> <ol data-bbox="537 630 1808 829" style="list-style-type: none">1. Type in your device's phone number2. To verify your identity, we'll send a verification code via text to your phone number. We want to make sure you're human!3. The text message should arrive immediately. If you don't see it after a bit, tap 'Resend code.'4. Type in your name, email address, and take a selfie so your driver knows who to pick up5. That's it! Once you've set up your account, you'll be able to request a ride (Learn How to request a ride). <p data-bbox="478 872 1052 896">Log-in troubles? Read How to fix log-in issues for more.</p> <p data-bbox="478 927 1755 951">Age requirement: You must be at least 18 years old to create a Lyft account, request a ride, or have a ride requested for you.</p> <p data-bbox="478 982 600 1006">Back to top</p> <p data-bbox="438 1036 1566 1060">Source: https://help.lyft.com/hc/e/articles/115012926947-How-to-create-a-Lyft-account.</p>

Exhibit A for US Patent No. 10,341,838 Against Lyft Accused Products

Claim 10,341,838	- Exemplary Supporting Evidence Regarding Accused Products
	 <p>The screenshot shows a mobile app interface for Lyft. At the top left is the Lyft logo. Below it, the text reads "Welcome back to Lyft!". Underneath, it says "We'll send a text to verify your phone." There is a text input field with a dropdown menu showing a US flag and "+1 Phone number". Below the input field is a checkbox labeled "Keep me signed in". At the bottom of the screen is a large purple button labeled "Next". Below the button, it asks "Have a new number?" and provides a link "Find your account" with a magnifying glass icon.</p>

Exhibit A for US Patent No. 10,341,838 Against Lyft Accused Products

Claim 10,341,838	- Exemplary Supporting Evidence Regarding Accused Products
	<p>Source: https://account.lyft.com/auth?next=https%3A%2F%2Fwww.lyft.com%2Flogin%2Fjump.</p> <p>Further, to the extent this element is performed at least in part by Lyft's software source code, AGIS reserves the right to supplement these contentions pursuant to production of such source code by Lyft and to the extent Defendant requires additional information in accordance with P.R. 3-1 and for any other reasons.</p>
<p>1[E]. allowing the second mobile device corresponding to the participant to join the communication network, the allowing based on a determination regarding the second data</p>	<p>The Lyft Accused Products infringe directly and/or indirectly by performing, inducing others to perform, and/or contributing to the performance of: allowing the second mobile device corresponding to the participant to join the communication network, the allowing based on a determination regarding the second data.</p> <p>This element is infringed literally, or in the alternative, under the doctrine of equivalents.</p> <p>The Lyft server(s) perform this limitation when the server uses the account or identity information described above to add the account/rider/phone number/Lyft app for riders to the Lyft platform or network of drivers and passengers. The Lyft server(s) also perform this limitation when the server uses the account or identity information to create or activate or update an account using the account or identity information described above. The Lyft server(s) also perform this limitation when a rider completes the sign-in or log-in process. On information and belief, the Lyft server(s) also perform this step using a verification or validation process within sign-up, sign-in, or status request process. On information and belief, the account or identity information is associated with the Lyft platform or network of drivers and passengers or a subset of the platform or network.</p>

Exhibit A for US Patent No. 10,341,838 Against Lyft Accused Products

Claim 10,341,838	- Exemplary Supporting Evidence Regarding Accused Products
	<p data-bbox="478 293 926 334">Sign up for a Lyft account</p> <p data-bbox="478 363 1014 388">Before you begin, be sure you have the following:</p> <ul data-bbox="537 420 789 537" style="list-style-type: none"><li data-bbox="537 420 789 444">• Your phone number<li data-bbox="537 464 789 488">• Your email address<li data-bbox="537 508 789 532">• A photo of yourself <p data-bbox="478 578 604 602">Get started</p> <ol data-bbox="537 634 1850 841" style="list-style-type: none"><li data-bbox="537 634 963 659">1. Type in your device's phone number<li data-bbox="537 678 1850 703">2. To verify your identity, we'll send a verification code via text to your phone number. We want to make sure you're human!<li data-bbox="537 722 1545 747">3. The text message should arrive immediately. If you don't see it after a bit, tap 'Resend code.'<li data-bbox="537 766 1507 790">4. Type in your name, email address, and take a selfie so your driver knows who to pick up<li data-bbox="537 810 1671 834">5. That's it! Once you've set up your account, you'll be able to request a ride (Learn How to request a ride). <p data-bbox="478 883 1068 907">Log-in troubles? Read How to fix log-in issues for more.</p> <p data-bbox="478 940 1793 964">Age requirement: You must be at least 18 years old to create a Lyft account, request a ride, or have a ride requested for you.</p> <p data-bbox="478 997 604 1021">Back to top</p> <p data-bbox="438 1053 1562 1078">Source: https://help.lyft.com/hc/e/articles/115012926947-How-to-create-a-Lyft-account</p>

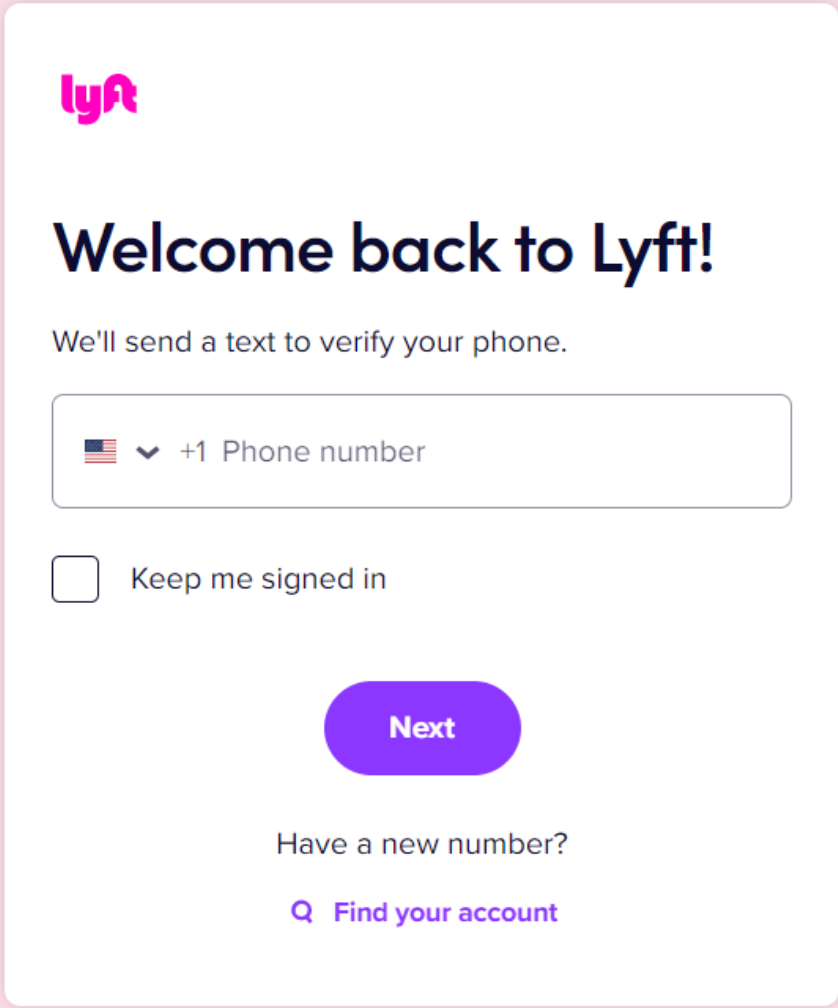
Exhibit A for US Patent No. 10,341,838 Against Lyft Accused Products





Claim 10,341,838	- Exemplary Supporting Evidence Regarding Accused Products
	 <p>lyft</p> <h3>Welcome back to Lyft!</h3> <p>We'll send a text to verify your phone.</p> <p>  +1 Phone number</p> <p><input type="checkbox"/> Keep me signed in</p> <p>Next</p> <p>Have a new number?</p> <p> Find your account</p>

Exhibit A for US Patent No. 10,341,838 Against Lyft Accused Products

Claim 10,341,838	- Exemplary Supporting Evidence Regarding Accused Products
	<p>Source: https://account.lyft.com/auth?next=https%3A%2F%2Fwww.lyft.com%2Flogin%2Fjump.</p> <p>Further, to the extent this element is performed at least in part by Lyft's software source code, AGIS reserves the right to supplement these contentions pursuant to production of such source code by Lyft and to the extent Defendant requires additional information in accordance with P.R. 3-1 and for any other reasons.</p>
<p>1[F]. receiving vehicle location data provided by the first mobile device corresponding to the vehicle, wherein the vehicle location data are associated with the first identifier and indicate coordinates of a geographical location of the first mobile device</p>	<p>The Lyft Accused Products infringe directly and/or indirectly by performing, inducing others to perform, and/or contributing to the performance of: receiving vehicle location data provided by the first mobile device corresponding to the vehicle, wherein the vehicle location data are associated with the first identifier and indicate coordinates of a geographical location of the first mobile device.</p> <p>This element is infringed literally, or in the alternative, under the doctrine of equivalents.</p> <p>The Lyft server(s) perform this limitation when they receive driver location data associated with the account or identity information described above. This information is received at the Lyft server(s) via the Lyft app for drivers. For example, when a driver is online and ready to take request for rides, the driver's app sends its location coordinates to the Lyft servers enabling the servers to match the driver with the nearby passengers. The location data of the driver is associated with his/her account or identity data described above, including but not limited to name, phone number and vehicle information. On information and belief, the driver's location data comprises geographical coordinates or geotagged/geocoded/georeferenced information related to a driver's geographical location.</p>

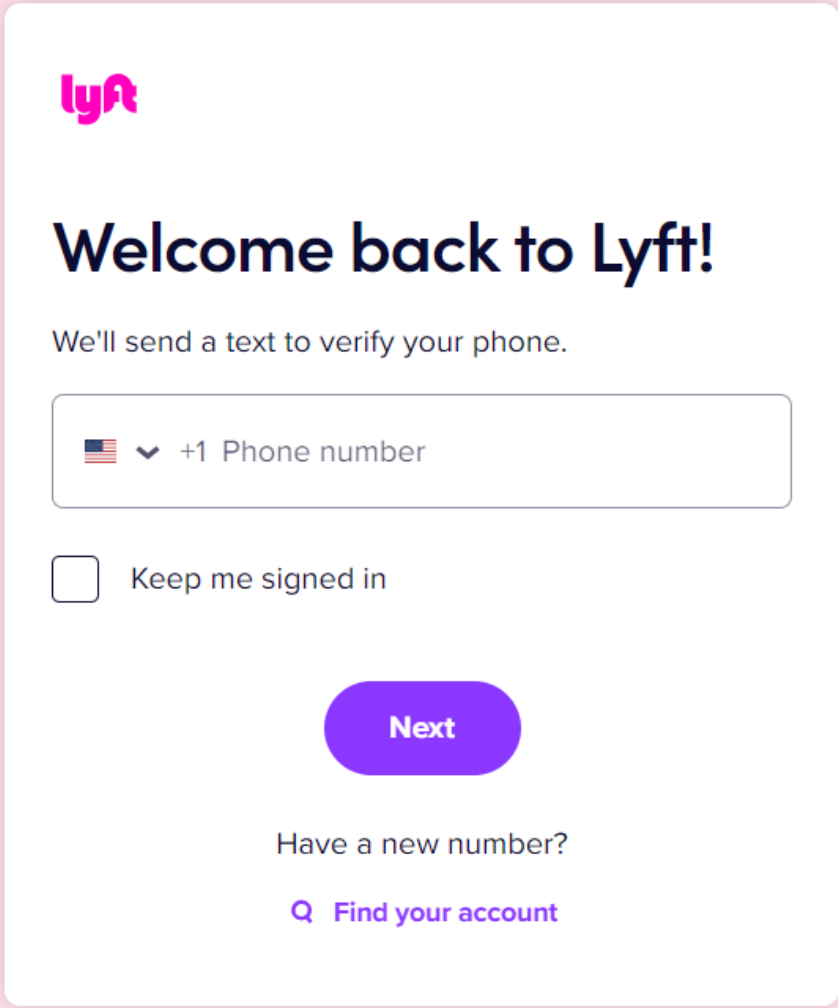
Exhibit A for US Patent No. 10,341,838 Against Lyft Accused Products

Claim 10,341,838	- Exemplary Supporting Evidence Regarding Accused Products
	 <p>https://www.youtube.com/watch?v=jVUy9poJDng at 10:24, Annotated</p> <p>Further, to the extent this element is performed at least in part by Lyft's software source code, AGIS reserves the right to supplement these contentions pursuant to production of such source code by Lyft and to the extent Defendant requires additional information in accordance with P.R. 3-1 and for any other reasons.</p>
<p>1[G]. receiving participant location data provided by the second mobile device corresponding to the</p>	<p>The Lyft Accused Products infringe directly and/or indirectly by performing, inducing others to perform, and/or contributing to the performance of: receiving participant location data provided by the second mobile device corresponding to the participant, wherein the participant location data are associated with the second identifier and indicate coordinates of a geographical location of the second mobile device.</p> <p>This element is infringed literally, or in the alternative, under the doctrine of equivalents.</p>

Exhibit A for US Patent No. 10,341,838 Against Lyft Accused Products

Claim 10,341,838	- Exemplary Supporting Evidence Regarding Accused Products
<p>participant, wherein the participant location data are associated with the second identifier and indicate coordinates of a geographical location of the second mobile device</p>	<p>The Lyft server(s) perform this limitation when they receive rider location data associated with the account or identity information described above. This information is received at the Lyft server(s) via the Lyft app for riders. For example, when a passenger books a ride, the passenger's Lyft app for riders sends its current location coordinates to the Lyft servers enabling the servers to match the passenger with the nearby drivers. The location data of the passenger is associated with his/her account or identity data described above including but not limited to username, email address and phone number. On information and belief, the rider's location data comprises geographical coordinates or geotagged/geocoded/georeferenced information related to a rider's geographical location.</p> <div style="text-align: center; margin-top: 20px;">  </div> <p style="text-align: center; margin-top: 10px;"> https://www.youtube.com/watch?v=j0RDMLcmOgU at 3:27 </p>

Exhibit A for US Patent No. 10,341,838 Against Lyft Accused Products

Claim 10,341,838	- Exemplary Supporting Evidence Regarding Accused Products
	 <p>https://www.youtube.com/watch?v=j0RDMLcmOgU at 3:49</p>

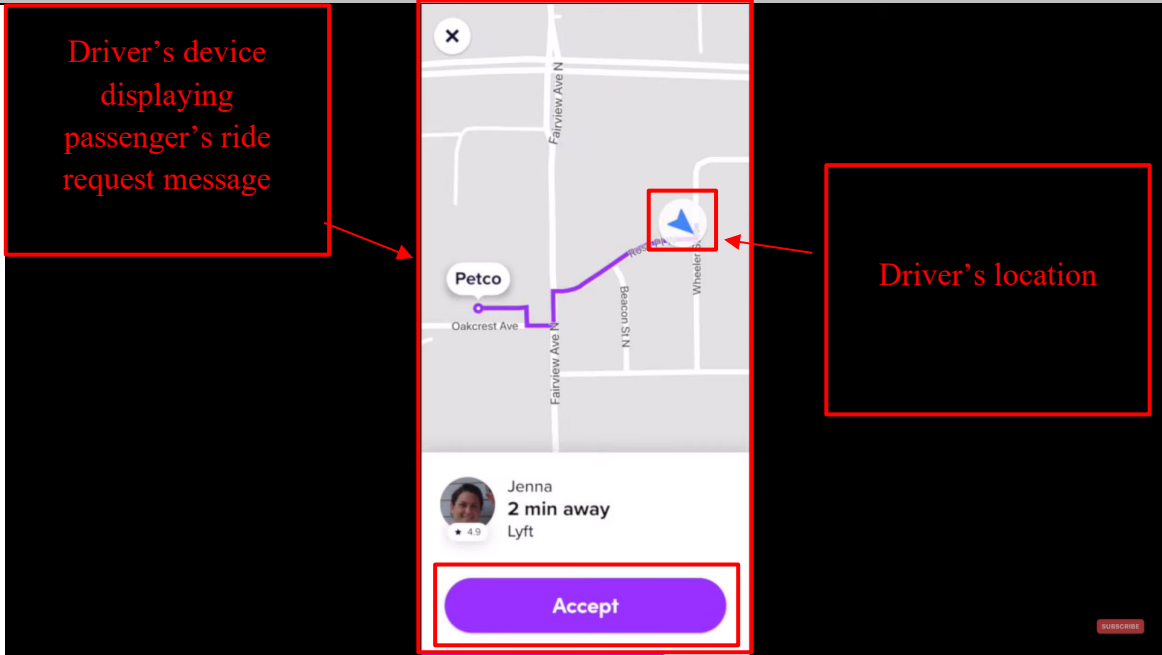
Exhibit A for US Patent No. 10,341,838 Against Lyft Accused Products



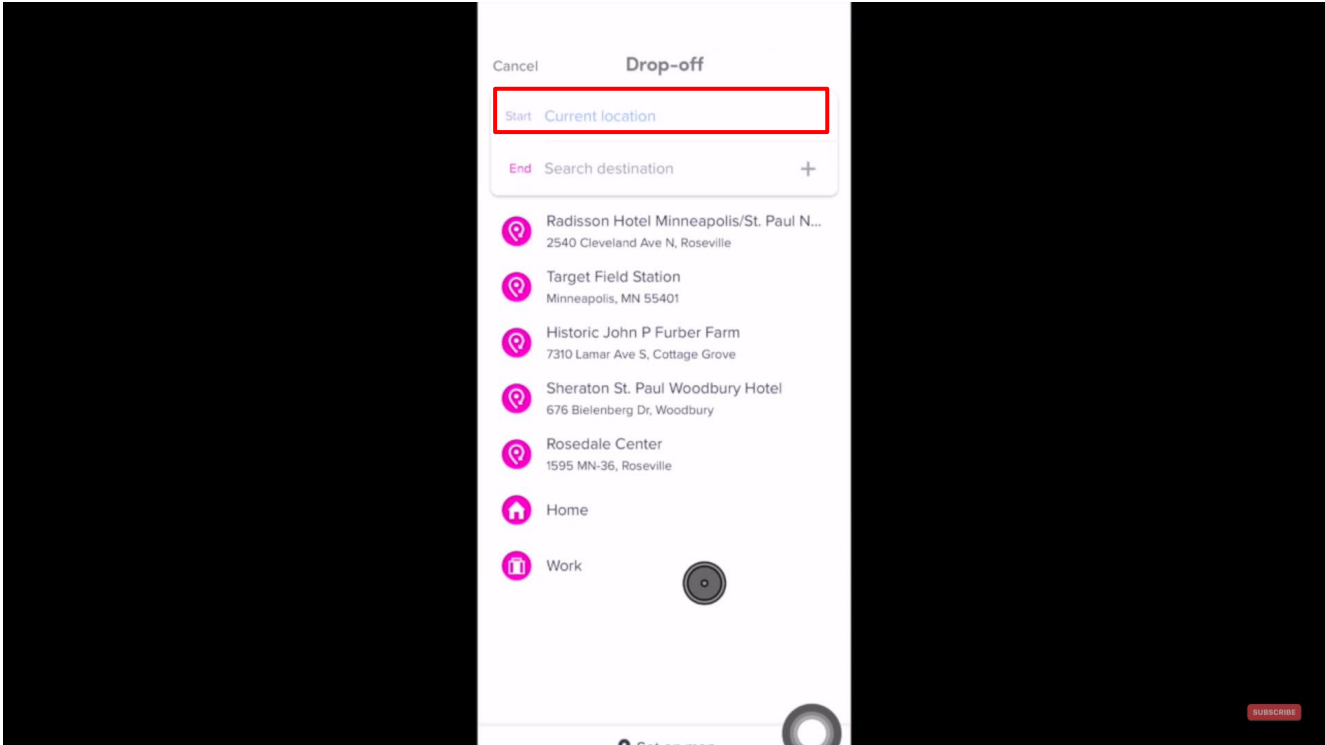





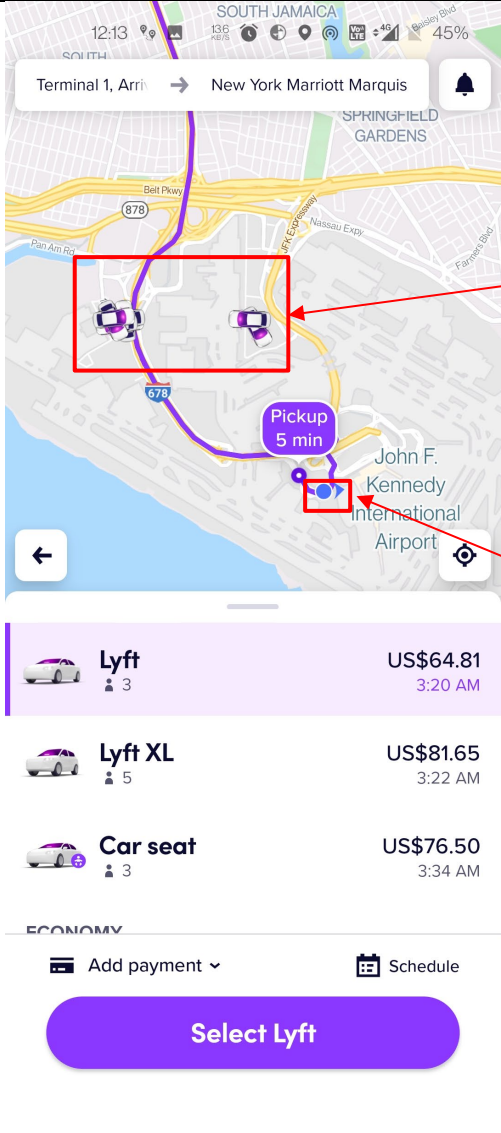

Claim 10,341,838	- Exemplary Supporting Evidence Regarding Accused Products						
	 <p data-bbox="1096 386 1297 587">Nearby Drivers' location</p> <p data-bbox="1073 711 1306 906">Passenger's location</p> <table border="1" data-bbox="443 885 934 1193"><tr><td> Lyft</td><td>US\$64.81 3:20 AM</td></tr><tr><td> Lyft XL</td><td>US\$81.65 3:22 AM</td></tr><tr><td> Car seat</td><td>US\$76.50 3:34 AM</td></tr></table> <p data-bbox="457 1185 934 1242">ECONOMY Add payment Schedule</p> <p data-bbox="483 1258 892 1331">Select Lyft</p>	 Lyft	US\$64.81 3:20 AM	 Lyft XL	US\$81.65 3:22 AM	 Car seat	US\$76.50 3:34 AM
 Lyft	US\$64.81 3:20 AM						
 Lyft XL	US\$81.65 3:22 AM						
 Car seat	US\$76.50 3:34 AM						

Exhibit A for US Patent No. 10,341,838 Against Lyft Accused Products

Claim 10,341,838	- Exemplary Supporting Evidence Regarding Accused Products
	<p>Further, to the extent this element is performed at least in part by Lyft's software source code, AGIS reserves the right to supplement these contentions pursuant to production of such source code by Lyft and to the extent Defendant requires additional information in accordance with P.R. 3-1 and for any other reasons.</p>
<p>1[H]. sending participant data to the second mobile device corresponding to the participant, wherein the participant data comprise the vehicle location data, wherein the second mobile device corresponding to the participant is configured to (1) determine coordinates of a position on the participant map corresponding to the coordinates of the geographical</p>	<p>The Lyft Accused Products infringe directly and/or indirectly by performing, inducing others to perform, and/or contributing to the performance of: sending participant data to the second mobile device corresponding to the participant, wherein the participant data comprise the vehicle location data, wherein the second mobile device corresponding to the participant is configured to (1) determine coordinates of a position on the participant map corresponding to the coordinates of the geographical location of the second mobile device, (2) display the participant map, and (3) place a first symbol on the participant map at the determined coordinates of the position on the participant map corresponding to the coordinates of the geographical location of the second mobile device.</p> <p>This element is infringed literally, or in the alternative, under the doctrine of equivalents.</p> <p>The Lyft server(s) communicates driver geographical location to the rider's Lyft app. The rider's lyft app is programmed to receive the driver location data and process it to display a map with a symbol indicating the driver's location on the map. The rider's Lyft app includes instructions for placing the symbol at the map location corresponding to the geographical coordinates of the driver (i.e. its vehicle). For example, when the Lyft passenger uses the Lyft app, the passenger views the location of the vehicle/driver because the Lyft server(s) transmits the current location data of the drivers for display on a map showing nearby drivers' vehicles ("vehicle location data") as per their location coordinates. In another example, after the passenger requests a ride or begins a ride, the Lyft server(s) communicate the driver's location to the passenger's Lyft app for riders and this location is displayed as a symbol on the map to the passenger. Further, the Lyft app for riders determines the passenger location coordinates from the location data received from the server and adds a symbol corresponding to the coordinates on the map.</p>

Exhibit A for US Patent No. 10,341,838 Against Lyft Accused Products

Claim 10,341,838	Exemplary Supporting Evidence Regarding Accused Products
<p>location of the second mobile device, (2) display the participant map, and (3) place a first symbol on the participant map at the determined coordinates of the position on the participant map corresponding to the coordinates of the geographical location of the second mobile device</p>	 <p>The screenshot shows a mobile application interface for a ride-sharing service. At the top, it displays the destination 'New York Marriott Marquis' and the pickup location 'Terminal 1, Arrivals'. A map below shows the area around JFK Airport with several driver icons (purple car icons) and a passenger icon (blue location pin). A red box highlights the driver icons, labeled 'Nearby Drivers' location'. Another red box highlights the passenger icon, labeled 'Passenger's location'. Below the map, there are three ride options: 'Lyft' (US\$64.81, 3:20 AM), 'Lyft XL' (US\$81.65, 3:22 AM), and 'Car seat' (US\$76.50, 3:34 AM). At the bottom, there is a large purple button labeled 'Select Lyft'.</p>

Exhibit A for US Patent No. 10,341,838 Against Lyft Accused Products

Claim 10,341,838	- Exemplary Supporting Evidence Regarding Accused Products
	Further, to the extent this element is performed at least in part by Lyft's software source code, AGIS reserves the right to supplement these contentions pursuant to production of such source code by Lyft and to the extent Defendant requires additional information in accordance with P.R. 3-1 and for any other reasons.
1[I]. sending vehicle data to the first mobile device corresponding to the vehicle, wherein the vehicle data comprise the participant location data, wherein the first mobile device corresponding to the vehicle is configured to (1) determine coordinates of a position on the vehicle map corresponding to the coordinates of the geographical location of the first mobile device	<p>The Lyft Accused Products infringe directly and/or indirectly by performing, inducing others to perform, and/or contributing to the performance of: sending vehicle data to the first mobile device corresponding to the vehicle, wherein the vehicle data comprise the participant location data, wherein the first mobile device corresponding to the vehicle is configured to (1) determine coordinates of a position on the vehicle map corresponding to the coordinates of the geographical location of the first mobile device, (2) display the vehicle map, and (3) place a second symbol on the vehicle map at the determined coordinates of the position on the vehicle map corresponding to the coordinates of the geographical location of the first mobile device;</p> <p>This element is infringed literally, or in the alternative, under the doctrine of equivalents.</p> <p>The Lyft server(s) communicates rider/passenger geographical location to the driver's Lyft app. The driver's lyft app is programmed to receive the driver location data and process it to display a map with a symbol indicating the rider's location on the map. The driver's Lyft app includes instructions for placing the symbol at the map location corresponding to the geographical coordinates of the rider.</p> <p>For example, when the Lyft driver uses the Lyft app, the driver can see the location of a passenger/rider because the server transmits the location data of the passenger/rider. The driver, when using the Lyft app for drivers, receives messages from the passengers requesting rides. The message comprises the passenger's location on the map. The Driver's Lyft app determines the location coordinates from the rider location data received from the Lyft server and places a symbol corresponding to the coordinates of the rider's location on the map in the driver's Lyft app.</p>

Exhibit A for US Patent No. 10,341,838 Against Lyft Accused Products

<p>Claim 10,341,838</p>	<p>- Exemplary Supporting Evidence Regarding Accused Products</p>
<p>device, (2) display the vehicle map, and (3) place a second symbol on the vehicle map at the determined coordinates of the position on the vehicle map corresponding to the coordinates of the geographical location of the first mobile device</p>	<div data-bbox="443 264 1591 914" style="border: 1px solid black; padding: 10px;"> </div> <p>https://www.youtube.com/watch?v=jVUy9poJDng at 10:24, Annotated</p> <p>Further, to the extent this element is performed at least in part by Lyft's software source code, AGIS reserves the right to supplement these contentions pursuant to production of such source code by Lyft and to the extent Defendant requires additional information in accordance with P.R. 3-1 and for any other reasons.</p>
<p>1[J]. receiving participant selection data provided by the second mobile device corresponding to the</p>	<p>The Lyft Accused Products infringe directly and/or indirectly by performing, inducing others to perform, and/or contributing to the performance of: receiving participant selection data provided by the second mobile device corresponding to the participant, the participant selection data corresponding to user input provided via a display of the second mobile device.</p> <p>This element is infringed literally, or in the alternative, under the doctrine of equivalents.</p>

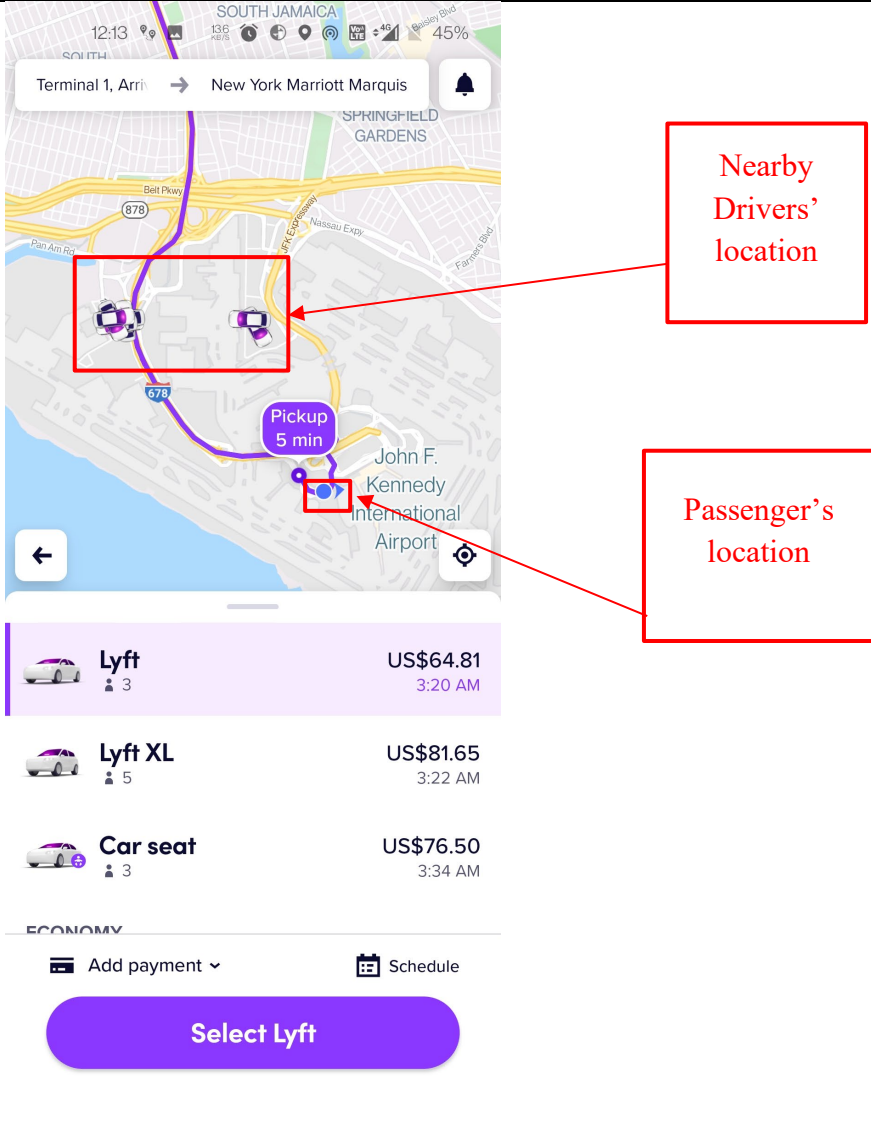
Exhibit A for US Patent No. 10,341,838 Against Lyft Accused Products

Claim 10,341,838	Exemplary Supporting Evidence Regarding Accused Products
<p>participant, the participant selection data corresponding to user input provided via a display of the second mobile device</p>	<p>The Lyft server(s) receives data indicating input from the rider/passenger via the Lyft app for riders. For example, the Lyft passenger provides input such as data related to a pickup location (current location or any specific location) and destination when booking a ride. The Lyft server(s) also receives user input regarding a vehicle or vehicle type, a time or schedule, a cost or estimate, a change in destination, an addition of a stop or multiple destinations, a share ride option, a share ETA option, and/or a route, view, or map selection. The Lyft server(s) also receives user input data indicating an acceptance or booking of a ride alone or in combination with other user inputs. The Lyft server(s) also receives user input regarding a message from the rider to the driver. The rider input via the Lyft app rider which is received at the server may be performed in multiple inputs.</p> <div style="text-align: center;">  </div> <p>https://www.youtube.com/watch?v=j0RDMLcmOgU at 3:27</p>

Exhibit A for US Patent No. 10,341,838 Against Lyft Accused Products

Claim 10,341,838	- Exemplary Supporting Evidence Regarding Accused Products
	 <p>https://www.youtube.com/watch?v=j0RDMLcmOgU at 3:43</p>

Exhibit A for US Patent No. 10,341,838 Against Lyft Accused Products

Claim 10,341,838	- Exemplary Supporting Evidence Regarding Accused Products
	<div style="text-align: center;">  </div> <p style="text-align: center; color: blue;"> https://www.youtube.com/watch?v=j0RDMLcmOgU at 3:49 </p> <p>Further, to the extent this element is performed at least in part by Lyft's software source code, AGIS reserves the right to supplement these contentions pursuant to production of such source code by Lyft and to the extent Defendant requires additional information in accordance with P.R. 3-1 and for any other reasons.</p>
<p>1[K]. based on the participant selection data, performing one or more acts</p>	<p>The Lyft Accused Products infringe directly and/or indirectly by performing, inducing others to perform, and/or contributing to the performance of: based on the participant selection data, performing one or more acts selected from the group consisting of: sending updated vehicle data to the first mobile device corresponding to the vehicle, sending updated participant data to the second mobile device corresponding to the participant, and sending a message to the first mobile device corresponding to the vehicle.</p>

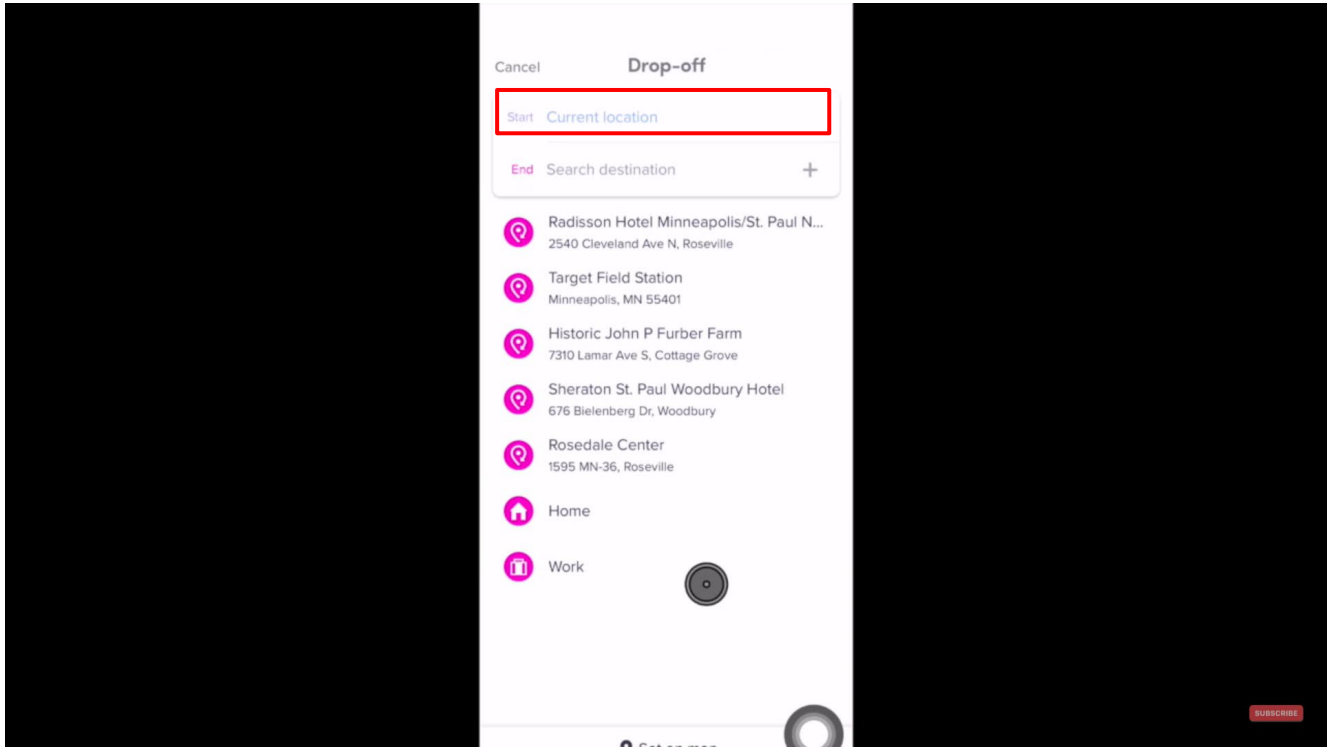
Exhibit A for US Patent No. 10,341,838 Against Lyft Accused Products

Claim - 10,341,838	Exemplary Supporting Evidence Regarding Accused Products
<p>selected from the group consisting of: sending updated vehicle data to the first mobile device corresponding to the vehicle, sending updated participant data to the second mobile device corresponding to the participant, and sending a message to the first mobile device corresponding to the vehicle</p>	<p>This element is infringed literally, or in the alternative, under the doctrine of equivalents.</p> <p>The Lyft server(s) communicate data based on the rider’s user input selections described above. For example, the Lyft server(s) communicates location/ride/status data and updates for the driver/vehicle to the passenger/rider. The Lyft server(s) also communicates location/ride/status and updates for the rider/passenger to the driver/vehicle. The Lyft server(s) also communicates messages from the rider to the driver as described above. The Lyft server(s) also communicates updated locations to the rider/driver and updated directions/routes to the driver. The Lyft server(s) communications are sent to the Lyft apps for driver and/or rider.</p>

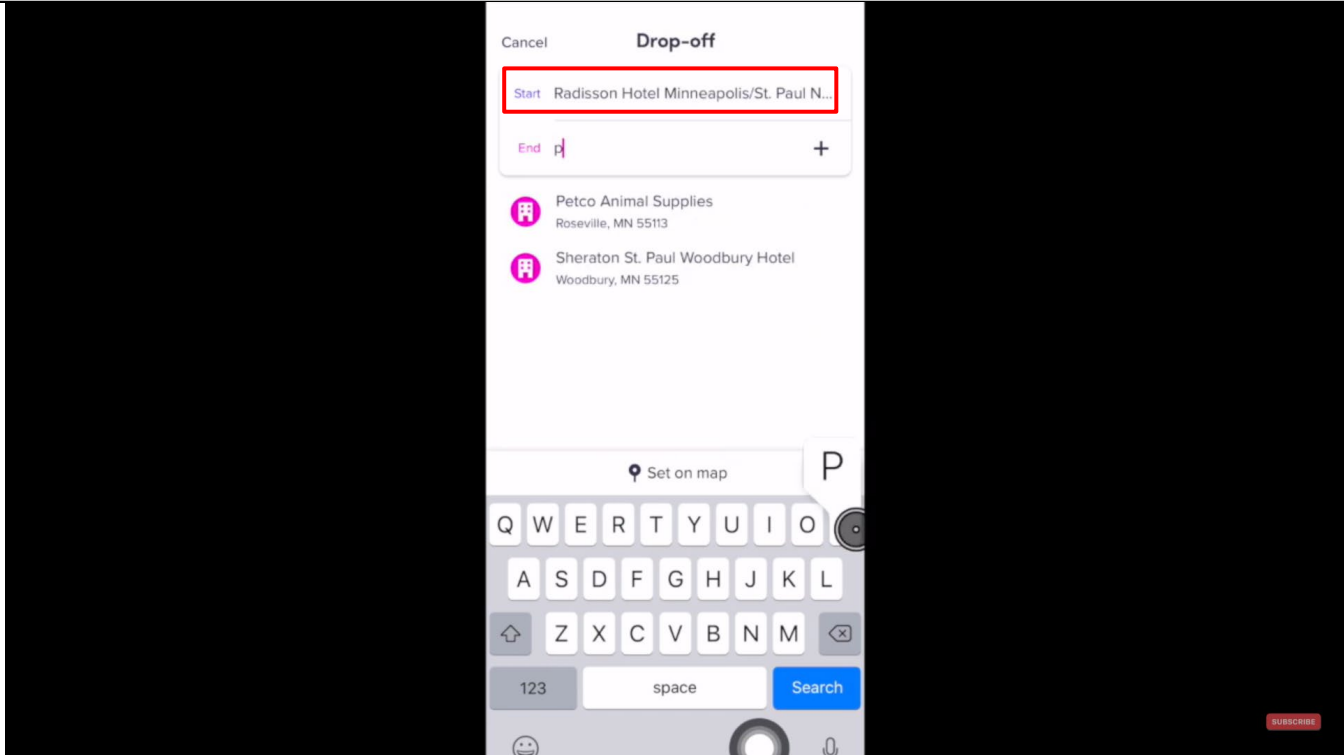
Exhibit A for US Patent No. 10,341,838 Against Lyft Accused Products



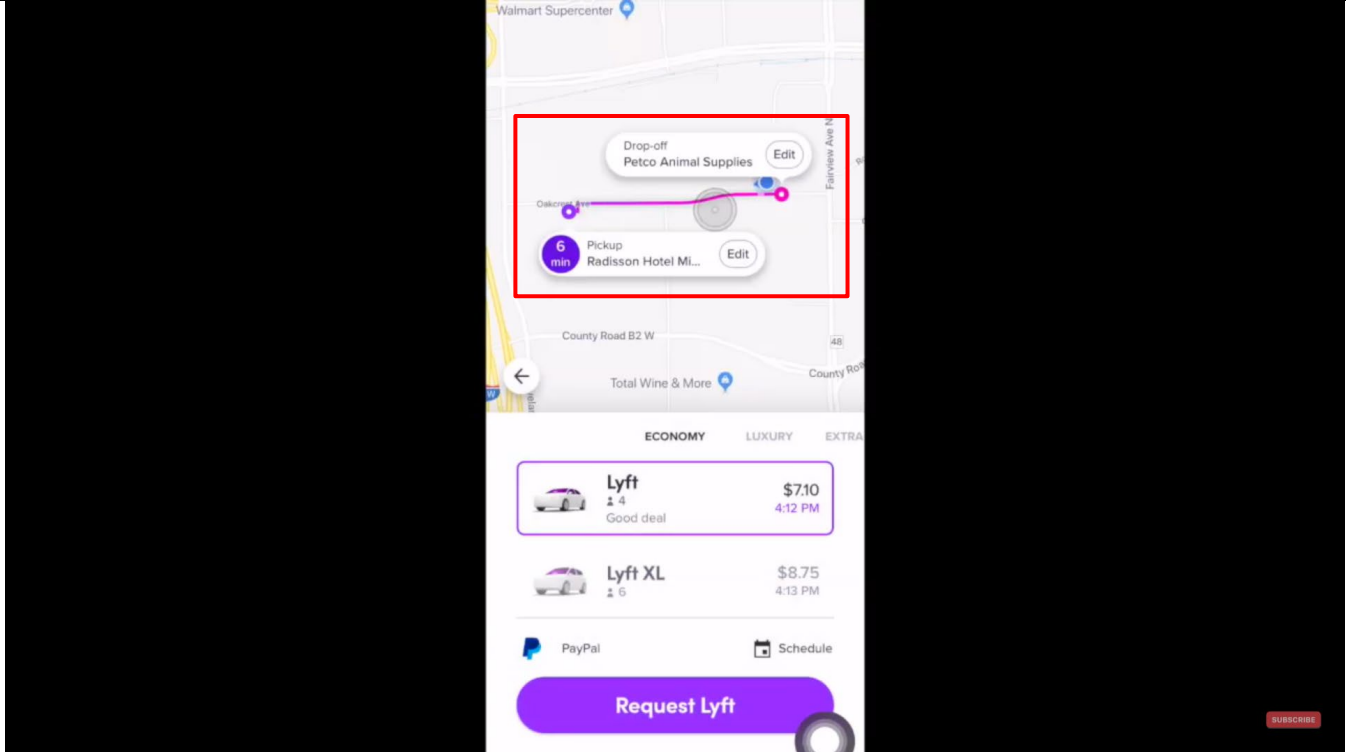







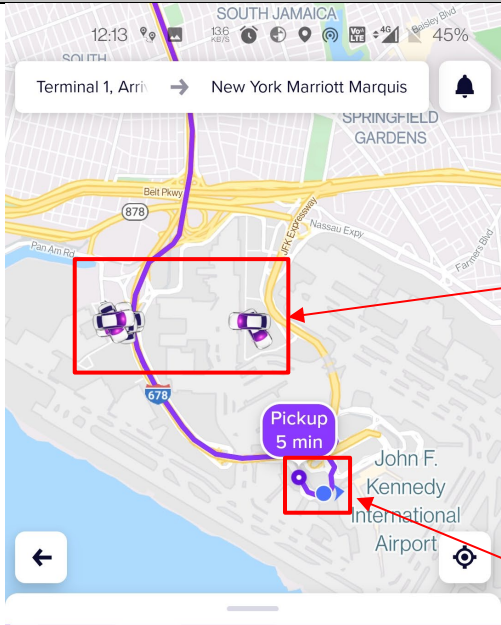

Claim 10,341,838	- Exemplary Supporting Evidence Regarding Accused Products						
	 <p>The screenshot shows the Lyft app interface. At the top, the destination is set to "New York Marriott Marquis". The map displays the area around John F. Kennedy International Airport. A red box highlights two nearby driver icons. A blue dot and a purple icon are also visible on the map, representing the passenger's current location and the pickup location. A callout box points to these icons with the text "Passenger's current location (blue dot) and pickup location". Another callout box points to the nearby driver icons with the text "Nearby Drivers' location".</p> <table border="1" data-bbox="436 885 934 1185"><tbody><tr><td> Lyft</td><td>US\$64.81 3:20 AM</td></tr><tr><td> Lyft XL</td><td>US\$81.65 3:22 AM</td></tr><tr><td> Car seat</td><td>US\$76.50 3:34 AM</td></tr></tbody></table> <p>ECONOMY</p> <p> Add payment  Schedule</p> <p>Select Lyft</p>	 Lyft	US\$64.81 3:20 AM	 Lyft XL	US\$81.65 3:22 AM	 Car seat	US\$76.50 3:34 AM
 Lyft	US\$64.81 3:20 AM						
 Lyft XL	US\$81.65 3:22 AM						
 Car seat	US\$76.50 3:34 AM						

Exhibit A for US Patent No. 10,341,838 Against Lyft Accused Products

Claim 10,341,838	- Exemplary Supporting Evidence Regarding Accused Products
	 <p>Driver's device displaying passenger's ride request message</p> <p>Driver's location</p> <p>https://www.youtube.com/watch?v=jVUy9poJDng at 10:24, Annotated</p>

Exhibit A for US Patent No. 10,341,838 Against Lyft Accused Products

Claim 10,341,838	- Exemplary Supporting Evidence Regarding Accused Products
	 <p>https://www.youtube.com/watch?v=j0RDMLcmOgU at 3:49</p> <p>Further, to the extent this element is performed at least in part by Lyft's software source code, AGIS reserves the right to supplement these contentions pursuant to production of such source code by Lyft and to the extent Defendant requires additional information in accordance with P.R. 3-1 and for any other reasons.</p>
<p>1[L]. receiving entity-of-interest data transmitted by the second</p>	<p>The Lyft Accused Products infringe directly and/or indirectly by performing, inducing others to perform, and/or contributing to the performance of: receiving entity-of-interest data transmitted by the second mobile device, the entity-of-interest data comprising coordinates of a geographical location of a new entity of interest, wherein the second mobile device is configured to (1) identify participant interaction with a display of the second mobile device, the participant interaction indicating selection of a position on the participant map and entry of the new entity of</p>

Exhibit A for US Patent No. 10,341,838 Against Lyft Accused Products

Claim - 10,341,838	Exemplary Supporting Evidence Regarding Accused Products
<p>mobile device, the entity-of-interest data comprising coordinates of a geographical location of a new entity of interest, wherein the second mobile device is configured to (1) identify participant interaction with a display of the second mobile device, the participant interaction indicating selection of a position on the participant map and entry of the new entity of interest at the selected position, (2) display an entity</p>	<p>interest at the selected position, (2) display an entity symbol representing the new entity of interest at the selected position on the participant map, (3) determine coordinates of a geographical location of the new entity of interest based on coordinates of the selected position on the participant map, and (4) transmit the entity-of-interest data.</p> <p>This element is infringed literally, or in the alternative, under the doctrine of equivalents.</p> <p>The Lyft server(s) performs this limitation because it receives user input data regarding pickups, stops or destinations entered by a user and those pickups, stops or destinations correspond to geographical locations on a map. For example, the Lyft passenger uses the Lyft app for riders to select a pickup location and a destination location. The Lyft passenger can add entities of interest and select one or more entities of interest as a pickup or destination. The Lyft passenger can choose the pickup/stop/destination location by entering an address/location/shortcut or by choosing it on a map which will add/enter a symbol on the map and the passenger can change the location of the added/enter symbol to specify the location of the added/entered symbol as a pickup/stop/destination. Each of these methods will cause a symbol corresponding to the pickup/stop/destination to be added/entered on the map at the corresponding location. When the passenger completes this process, data associated with the added/entered symbol as a pickup/stop/destination is communicated to the Lyft server(s). Adding/entering the symbol for a pickup/stop/destination can occur before or during a ride.</p> <p>The passenger provides the pickup location (current address or any specific location) and the destination when booking a ride using the Lyft app for riders indicating selection of a position on the map and entry of the entity at that position. The Lyft passenger can add a second stop or destination via user input in the Lyft app for riders. The Lyft app for riders receives user input regarding the selected location, displays a symbol on the map and determines the geographical location corresponding to the selected location and its coordinates. The rider is also able to edit or add additional stops/destinations and change the order of stops/destinations. The stops/destinations are displayed on the map using symbols.</p>

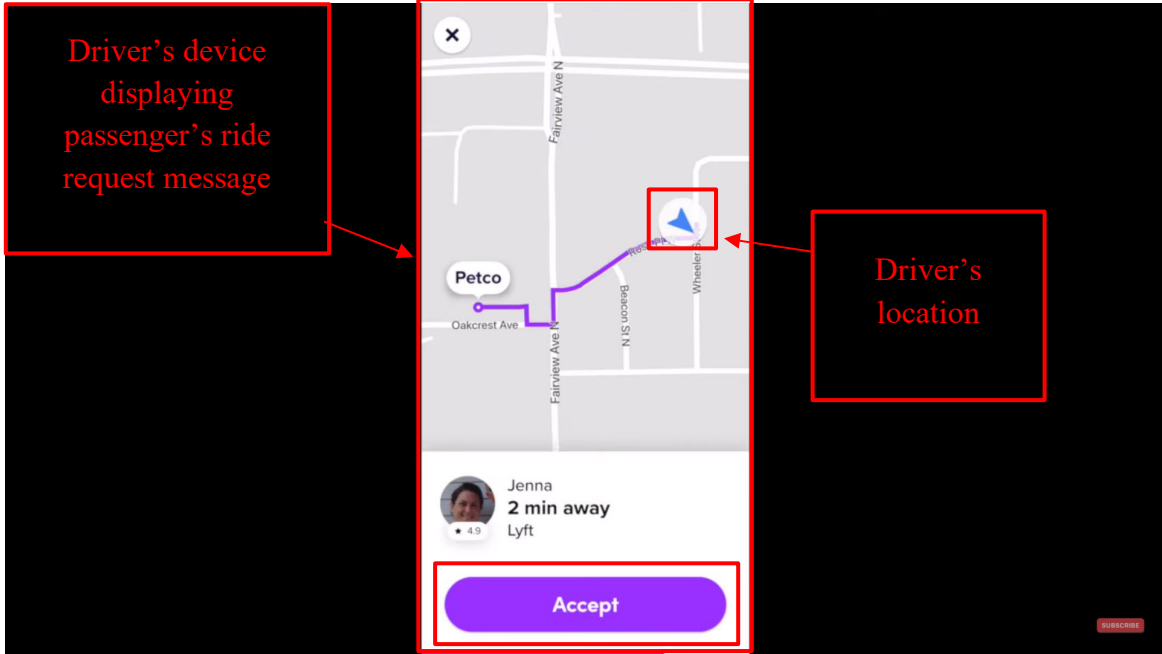
Exhibit A for US Patent No. 10,341,838 Against Lyft Accused Products

Claim 10,341,838	- Exemplary Supporting Evidence Regarding Accused Products
<p>symbol representing the new entity of interest at the selected position on the participant map, (3) determine coordinates of a geographical location of the new entity of interest based on coordinates of the selected position on the participant map, and (4) transmit the entity-of-interest data; and</p>	<div style="text-align: center;">  </div> <p style="text-align: center; color: blue;"> https://www.youtube.com/watch?v=j0RDMLcmOgU at 3:27 </p>

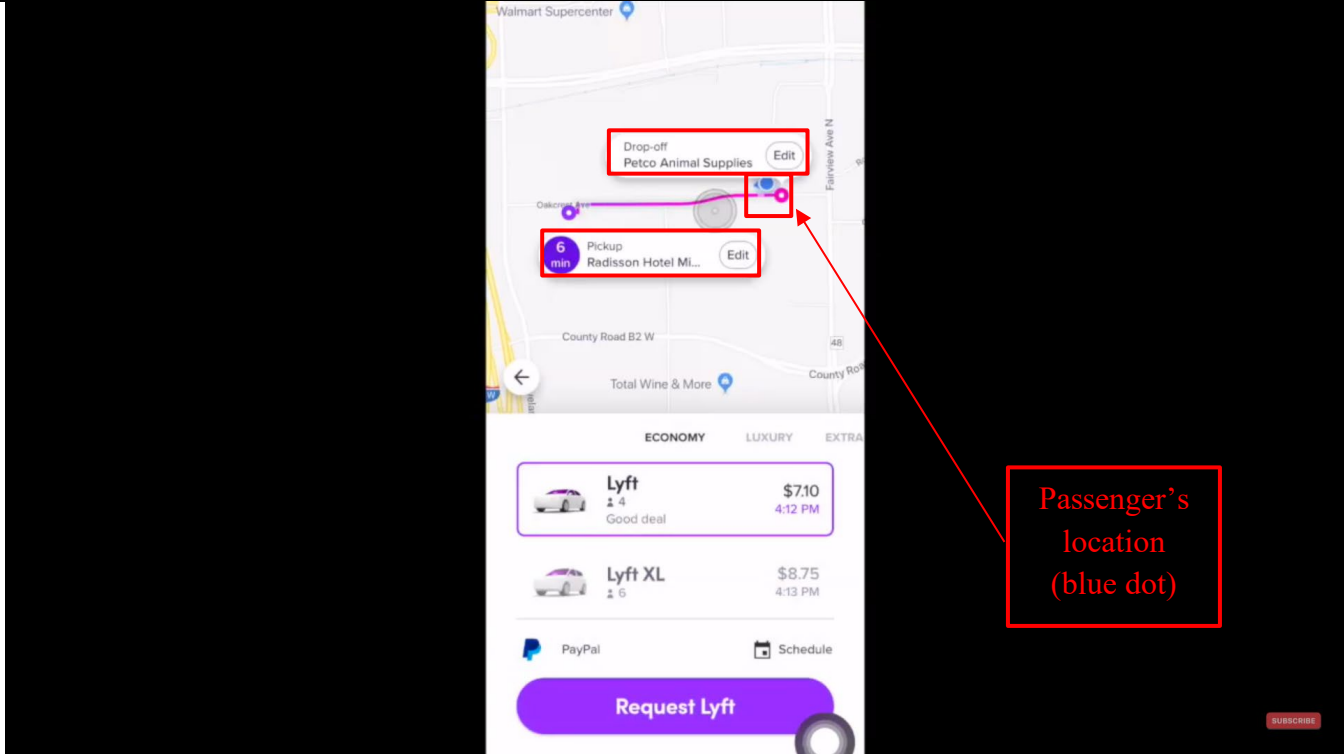
Exhibit A for US Patent No. 10,341,838 Against Lyft Accused Products

Claim 10,341,838	- Exemplary Supporting Evidence Regarding Accused Products
	 <p>https://www.youtube.com/watch?v=j0RDMLcmOgU at 3:43</p>

Exhibit A for US Patent No. 10,341,838 Against Lyft Accused Products

Claim 10,341,838	- Exemplary Supporting Evidence Regarding Accused Products
	<div style="text-align: center;">  </div> <p>https://www.youtube.com/watch?v=j0RDMLcmOgU at 3:49</p> <p>Further, to the extent this element is performed at least in part by Lyft's software source code, AGIS reserves the right to supplement these contentions pursuant to production of such source code by Lyft and to the extent Defendant requires additional information in accordance with P.R. 3-1 and for any other reasons.</p>
<p>1[M]. sending the entity-of-interest data to the first mobile device</p>	<p>The Lyft Accused Products infringe directly and/or indirectly by performing, inducing others to perform, and/or contributing to the performance of: sending the entity-of-interest data to the first mobile device corresponding to the vehicle, wherein the first mobile device is configured to place the entity symbol representing the new entity of interest on the vehicle map at a position on the vehicle map corresponding to the geographical location of the new entity of interest.</p>

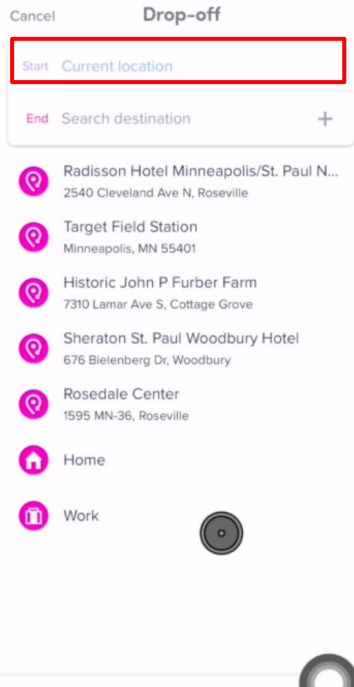
Exhibit A for US Patent No. 10,341,838 Against Lyft Accused Products

Claim 10,341,838	- Exemplary Supporting Evidence Regarding Accused Products
<p>corresponding to the vehicle, wherein the first mobile device is configured to place the entity symbol representing the new entity of interest on the vehicle map at a position on the vehicle map corresponding to the geographical location of the new entity of interest.</p>	<p>This element is infringed literally, or in the alternative, under the doctrine of equivalents.</p> <p>The Lyft server(s) performs this limitation because the Lyft server(s) communicate data corresponding to the added/entered pickup/stops/destinations to the Lyft app of the driver and symbols are placed at the geographical locations corresponding to the added/entered pickup/destinations/stops. This can occur before or during the acceptance of the ride. The added/entered symbols are displayed on the map at the Lyft app for drivers.</p> <div style="text-align: center; margin-top: 20px;">  <p>The screenshot shows a map with a purple route line. A red box labeled 'Passenger pickup location' points to a 'Petco' marker. Another red box labeled 'Driver's location' points to a blue location marker. A third red box labeled 'Driver's device displaying passenger's ride request message' points to the top of the screen. A fourth red box labeled 'Accept' points to a purple button at the bottom. Below the map, a driver profile for 'Jenna' is shown with '2 min away' and 'Lyft' text.</p> </div> <p>https://www.youtube.com/watch?v=jVUy9poJDng at 10:24, Annotated</p>

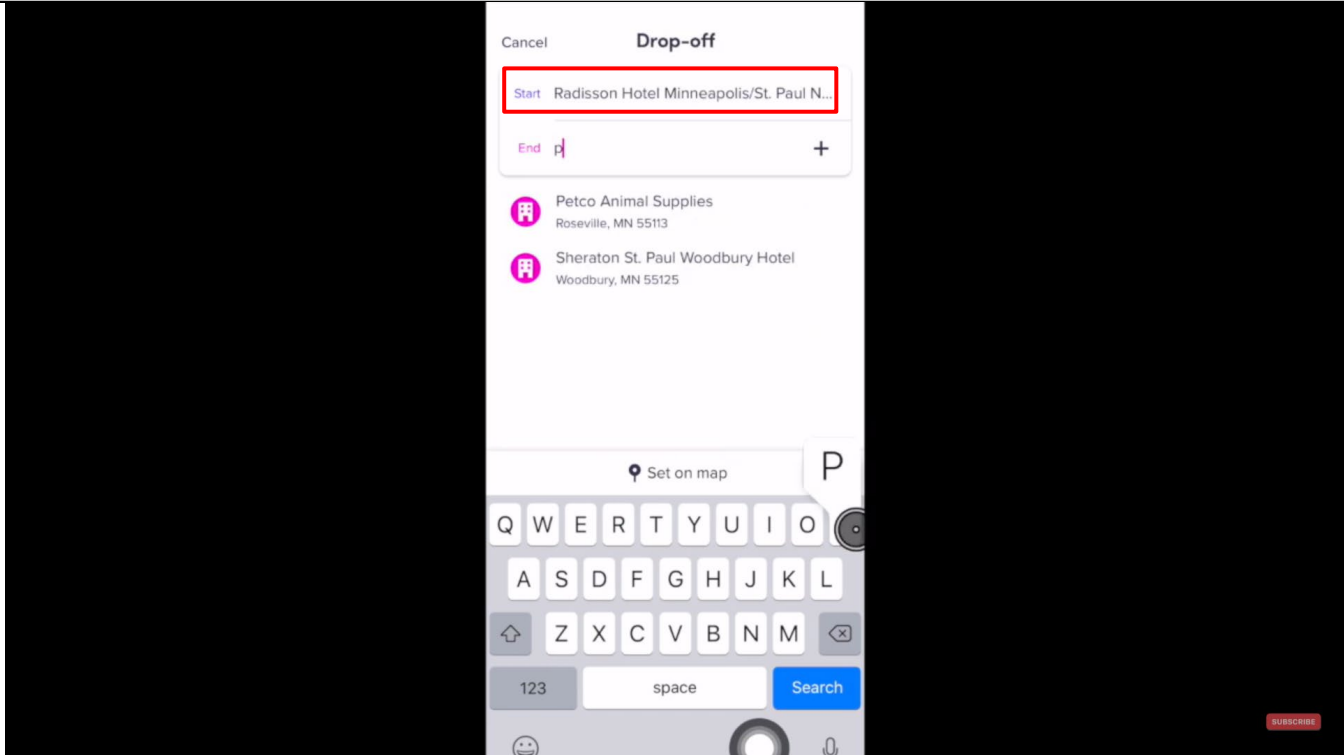
Exhibit A for US Patent No. 10,341,838 Against Lyft Accused Products

Claim 10,341,838	- Exemplary Supporting Evidence Regarding Accused Products
	 <p>The screenshot shows the Lyft mobile application interface. At the top, the status bar displays '1-Mobile LTE', '8:54 PM', and '20%' battery. The Lyft logo is in the top left, with a toggle switch and a dropdown arrow to its right. Below this, the destination is listed as 'DoubleTree by Hilton Hotel Denver - Aurora, 13696 E Il...' with an 'Edit destination' link and a '2 Min' estimated time. A map shows a pink route starting from a location near S Kananda Way and heading towards the destination. At the bottom, a driver profile for 'Kevin' is shown with a circular photo. Below the name is a large purple button with a right-pointing arrow and the text 'Slide to drop off'.</p> <p>https://www.youtube.com/watch?v=b31WorLlcqE at 9:40</p>

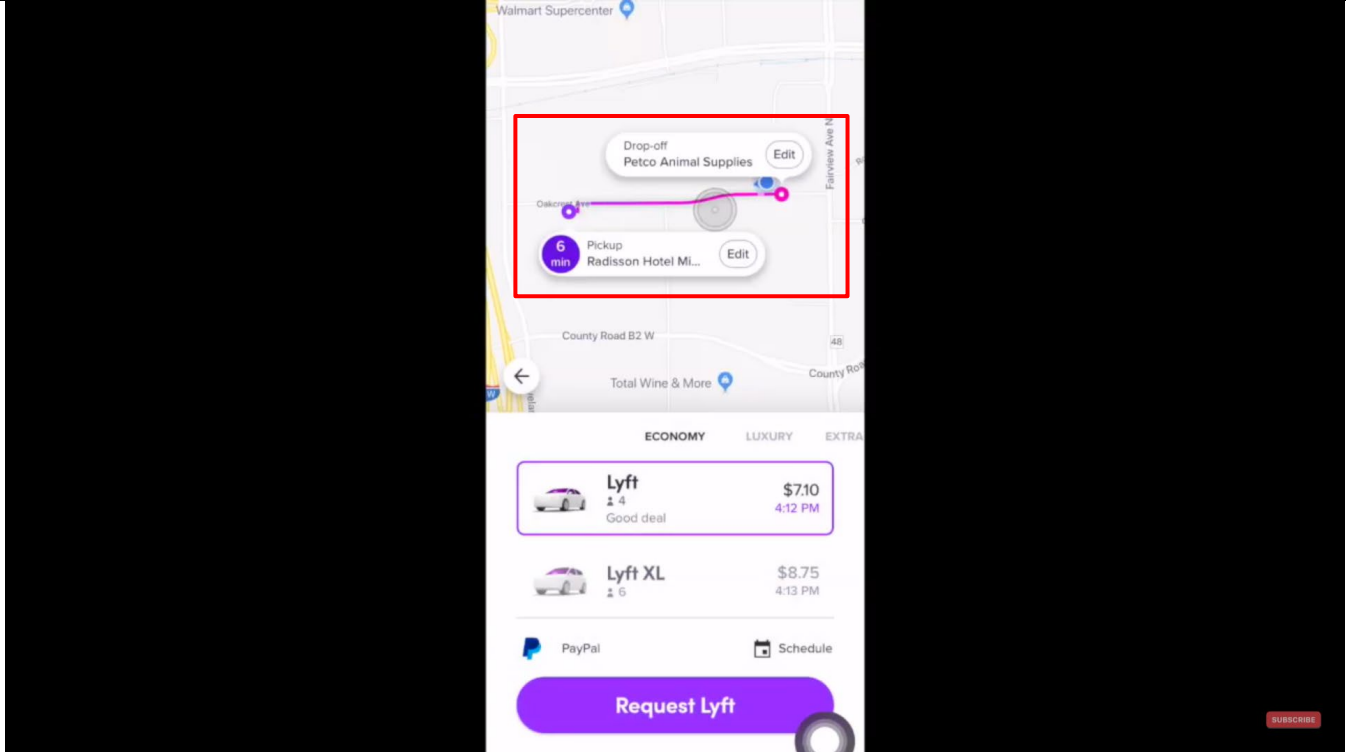
Exhibit A for US Patent No. 10,341,838 Against Lyft Accused Products

Claim 10,341,838	- Exemplary Supporting Evidence Regarding Accused Products
	<p>Further, to the extent this element is performed at least in part by Lyft's software source code, AGIS reserves the right to supplement these contentions pursuant to production of such source code by Lyft and to the extent Defendant requires additional information in accordance with P.R. 3-1 and for any other reasons.</p>
<p>2. The method of claim 1, wherein performing the one or more acts comprises sending, based on the participant selection data, the updated participant data to the second mobile device corresponding to the participant, wherein the second mobile device is configured to display the updated participant data within the participant map.</p>	<p>The Lyft Accused Products infringe directly and/or indirectly by performing, inducing others to perform, and/or contributing to the performance of: wherein performing the one or more acts comprises sending, based on the participant selection data, the updated participant data to the second mobile device corresponding to the participant, wherein the second mobile device is configured to display the updated participant data within the participant map.</p> <p>This element is infringed literally, or in the alternative, under the doctrine of equivalents.</p> <p>See claim 1. The Lyft server(s) meets this limitation because it sends updated driver/vehicle locations to the Lyft app for riders and that updated driver/vehicle location is provided for display to the rider via the Lyft app. For example, while the passenger is booking a ride, the server sends the updated current location of the vehicle to the passenger's Lyft app. The updated current location of the vehicle is loaded on the map in the Lyft app. The server also highlights the pickup location and destination address on the map in the Lyft app.</p>

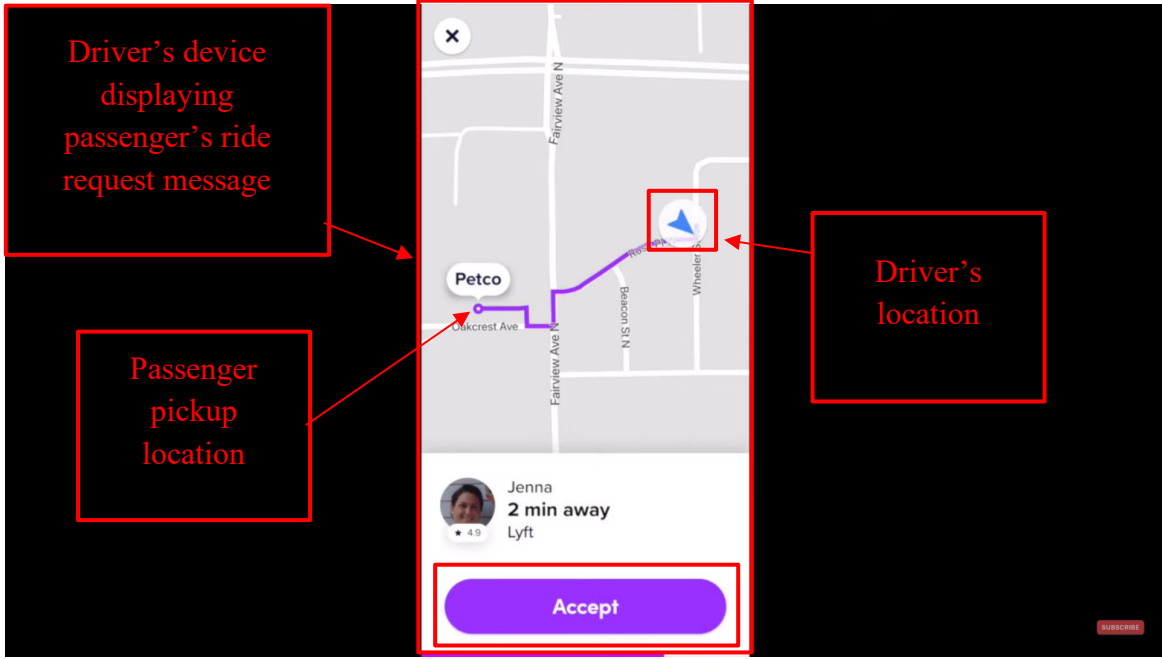
Exhibit A for US Patent No. 10,341,838 Against Lyft Accused Products

Claim 10,341,838	- Exemplary Supporting Evidence Regarding Accused Products
	 <p>The screenshot shows the Lyft app interface. At the top, the destination is set to "New York Marriott Marquis". The map displays the area around South Jamaica, NY, with a red box highlighting two nearby driver icons. A blue dot and a purple icon are highlighted with a red box, representing the passenger's current location and the pickup location. The pickup time is indicated as "5 min". Below the map, three ride options are listed: "Lyft" (US\$64.81, 3:20 AM), "Lyft XL" (US\$81.65, 3:22 AM), and "Car seat" (US\$76.50, 3:34 AM). At the bottom, there is a "Select Lyft" button.</p> <p>Nearby Drivers' location</p> <p>Passenger's current location (blue dot) and pickup location</p>

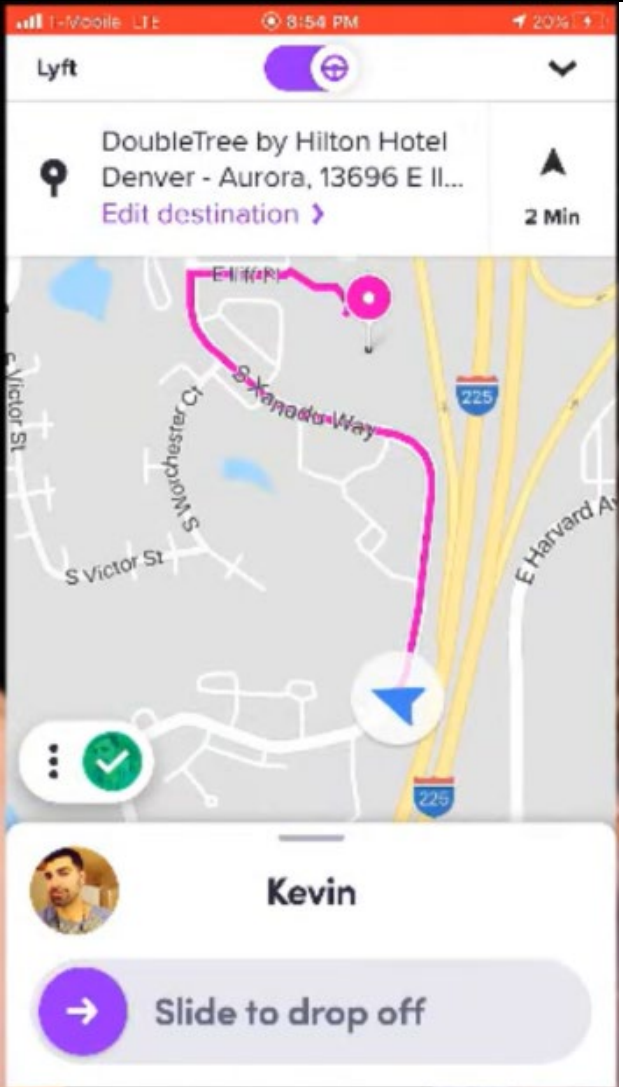
Exhibit A for US Patent No. 10,341,838 Against Lyft Accused Products

Claim 10,341,838	- Exemplary Supporting Evidence Regarding Accused Products
	 <p>https://www.youtube.com/watch?v=j0RDMLcmOgU at 3:49</p> <p>Further, to the extent this element is performed at least in part by Lyft's software source code, AGIS reserves the right to supplement these contentions pursuant to production of such source code by Lyft and to the extent Defendant requires additional information in accordance with P.R. 3-1 and for any other reasons.</p>
<p>3. The method of claim 2, wherein the updated participant data</p>	<p>The Lyft Accused Products infringe directly and/or indirectly by performing, inducing others to perform, and/or contributing to the performance of: wherein the updated participant data comprise updated vehicle location data indicating coordinates of an updated geographical location of the first mobile device corresponding to the vehicle.</p> <p>This element is infringed literally, or in the alternative, under the doctrine of equivalents.</p>

Exhibit A for US Patent No. 10,341,838 Against Lyft Accused Products

Claim 10,341,838	- Exemplary Supporting Evidence Regarding Accused Products
<p>comprise updated vehicle location data indicating coordinates of an updated geographical location of the first mobile device corresponding to the vehicle.</p>	<p>See claims 1 and 2. The Lyft server(s) meets this limitation because it sends updated driver/vehicle locations to the Lyft app for riders and that updated driver/vehicle location is provided for display to the rider via the Lyft app. The updated driver/vehicle location is presented on the geographical map at the geographical location. The geographical location on the map indicates coordinates for the vehicle.</p>

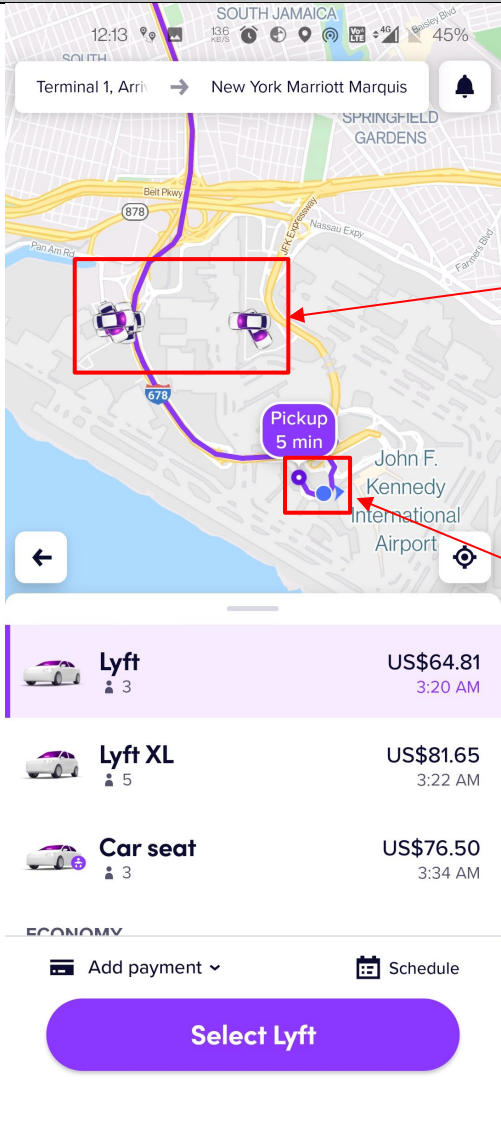
Exhibit A for US Patent No. 10,341,838 Against Lyft Accused Products

Claim 10,341,838	- Exemplary Supporting Evidence Regarding Accused Products												
	 <p>The screenshot shows the Lyft app interface. At the top, the destination is set to "New York Marriott Marquis". The map displays the area around John F. Kennedy International Airport. A red box highlights two nearby driver icons. A blue dot and a purple icon represent the passenger's current location and the pickup location, respectively. A callout box points to these icons with the text "Passenger's current location (blue dot) and pickup location". Another callout box points to the nearby driver icons with the text "Nearby Drivers' location". Below the map, the pricing options are listed:</p> <table border="1"><thead><tr><th>Option</th><th>Price</th><th>Time</th></tr></thead><tbody><tr><td>Lyft (3 seats)</td><td>US\$64.81</td><td>3:20 AM</td></tr><tr><td>Lyft XL (5 seats)</td><td>US\$81.65</td><td>3:22 AM</td></tr><tr><td>Car seat (3 seats)</td><td>US\$76.50</td><td>3:34 AM</td></tr></tbody></table> <p>At the bottom, there is a "Select Lyft" button.</p>	Option	Price	Time	Lyft (3 seats)	US\$64.81	3:20 AM	Lyft XL (5 seats)	US\$81.65	3:22 AM	Car seat (3 seats)	US\$76.50	3:34 AM
Option	Price	Time											
Lyft (3 seats)	US\$64.81	3:20 AM											
Lyft XL (5 seats)	US\$81.65	3:22 AM											
Car seat (3 seats)	US\$76.50	3:34 AM											

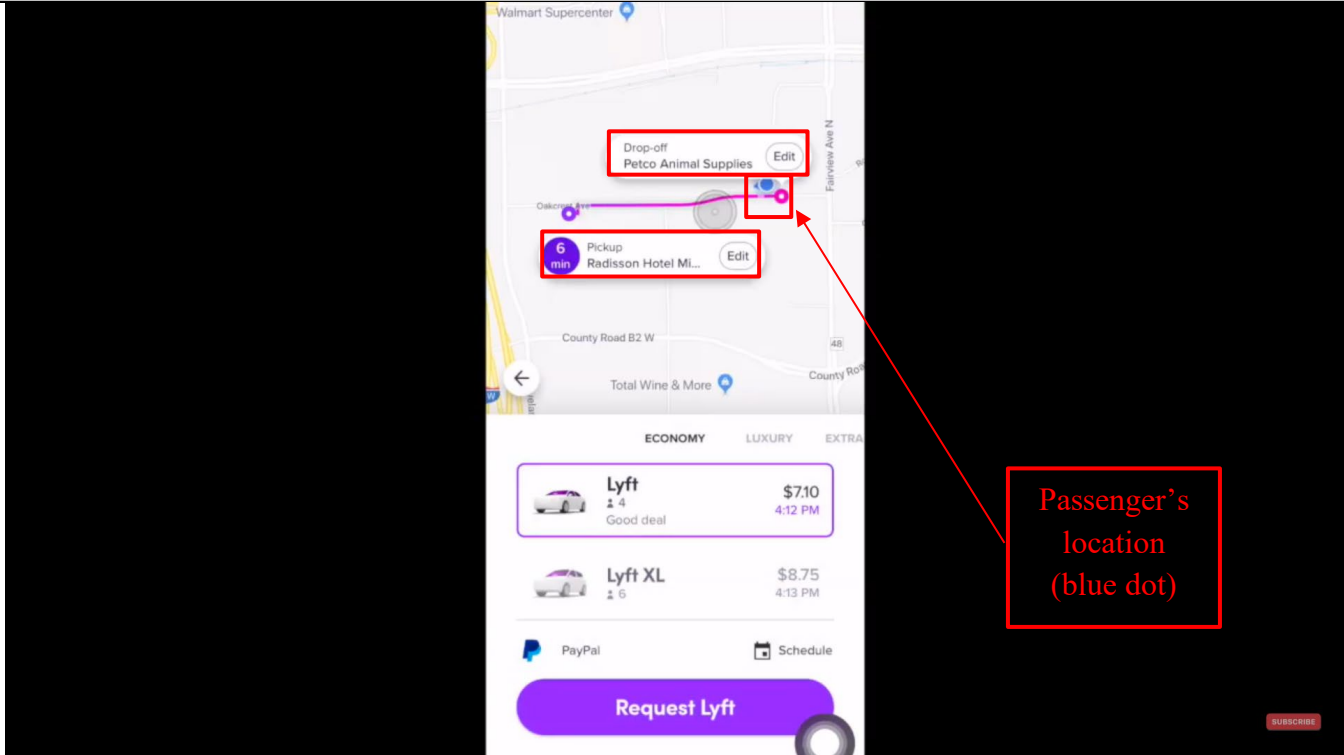
Exhibit A for US Patent No. 10,341,838 Against Lyft Accused Products

Claim 10,341,838	- Exemplary Supporting Evidence Regarding Accused Products
	<p>Further, to the extent this element is performed at least in part by Lyft's software source code, AGIS reserves the right to supplement these contentions pursuant to production of such source code by Lyft and to the extent Defendant requires additional information in accordance with P.R. 3-1 and for any other reasons.</p>
<p>4. The method of claim 1, wherein performing the one or more acts comprises sending, based on the participant selection data, the updated participant data to the second mobile device corresponding to the participant, wherein the second mobile device is configured to replace the participant map with an updated participant map on the display of</p>	<p>The Lyft Accused Products infringe directly and/or indirectly by performing, inducing others to perform, and/or contributing to the performance of: wherein performing the one or more acts comprises sending, based on the participant selection data, the updated participant data to the second mobile device corresponding to the participant, wherein the second mobile device is configured to replace the participant map with an updated participant map on the display of the second mobile device based at least in part on the updated participant data.</p> <p>This element is infringed literally, or in the alternative, under the doctrine of equivalents.</p> <p>See claim 1. The Lyft server(s) meets this limitation because it sends the driver/vehicle locations to the Lyft app for riders and that updated driver/vehicle location is provided for display to the rider via the Lyft app. The Lyft server sends updated map data or maps to the Lyft app for riders when a new location requires the presentation of a new map, i.e. when the location is changed or when the user moves/pans/modifies the map or when the user navigates within or outside the Lyft app and returns to the app.</p>

Exhibit A for US Patent No. 10,341,838 Against Lyft Accused Products

Claim 10,341,838	Exemplary Supporting Evidence Regarding Accused Products
the second mobile device based at least in part on the updated participant data.	 <p>The screenshot shows a Lyft app interface. At the top, it displays the destination 'New York Marriott Marquis' and the pickup location 'Terminal 1, Arrivals'. A map shows the area around JFK Airport with several driver icons (purple car icons) and a blue dot representing the passenger's current location. A red box highlights two driver icons, with a red arrow pointing to a text box labeled 'Nearby Drivers' location'. Another red box highlights the blue dot and a purple 'Pickup 5 min' icon, with a red arrow pointing to a text box labeled 'Passenger's current location (blue dot) and pickup location'. Below the map, three ride options are listed: 'Lyft' (US\$64.81, 3:20 AM), 'Lyft XL' (US\$81.65, 3:22 AM), and 'Car seat' (US\$76.50, 3:34 AM). At the bottom, there is a 'Select Lyft' button.</p>

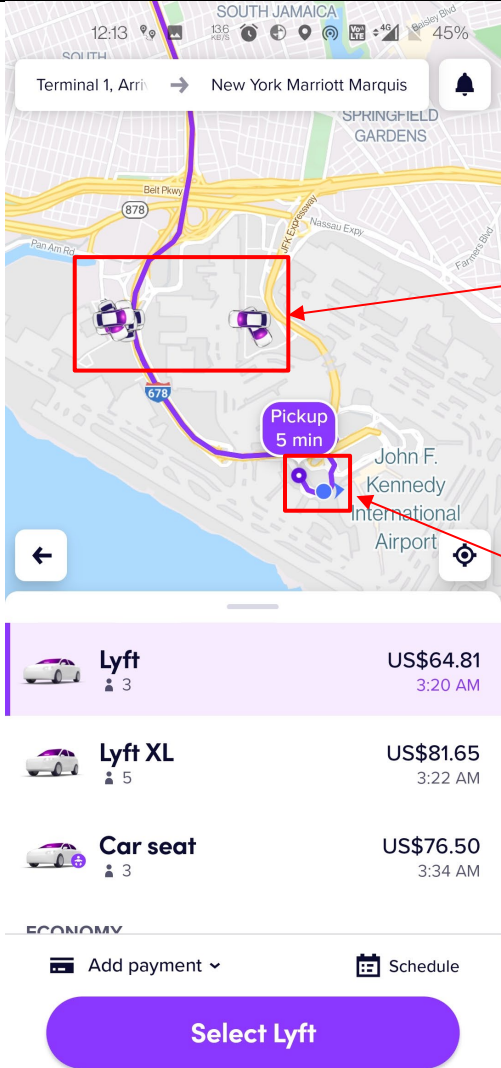
Exhibit A for US Patent No. 10,341,838 Against Lyft Accused Products

<p>Claim 10,341,838</p>	<p>- Exemplary Supporting Evidence Regarding Accused Products</p>
	 <p>https://www.youtube.com/watch?v=j0RDMLcmOgU at 3:49</p> <p>Further, to the extent this element is performed at least in part by Lyft's software source code, AGIS reserves the right to supplement these contentions pursuant to production of such source code by Lyft and to the extent Defendant requires additional information in accordance with P.R. 3-1 and for any other reasons.</p>
<p>5. The method of claim 1, wherein performing the</p>	<p>The Lyft Accused Products infringe directly and/or indirectly by performing, inducing others to perform, and/or contributing to the performance of: wherein performing the one or more acts comprises sending, based on the participant selection data, the message to the first mobile device corresponding to the vehicle.</p>

Exhibit A for US Patent No. 10,341,838 Against Lyft Accused Products

Claim 10,341,838	- Exemplary Supporting Evidence Regarding Accused Products
<p>one or more acts comprises sending, based on the participant selection data, the message to the first mobile device corresponding to the vehicle</p>	<p>This element is infringed literally, or in the alternative, under the doctrine of equivalents.</p> <p>See claim 1. The Lyft server(s) meets this limitation because it sends data corresponding to selections made in the Lyft app for riders to the Lyft app for drivers. For example, when the passenger books a ride by providing a pickup location and destination address (“participant selection data”), the server communicates the ride request message to the Lyft apps of the nearby drivers asking them to either accept or decline the ride. In other examples, the Lyft server receives selections from the riders’s Lyft app before or during a ride and communicates messages to the Lyft app for drivers.</p>

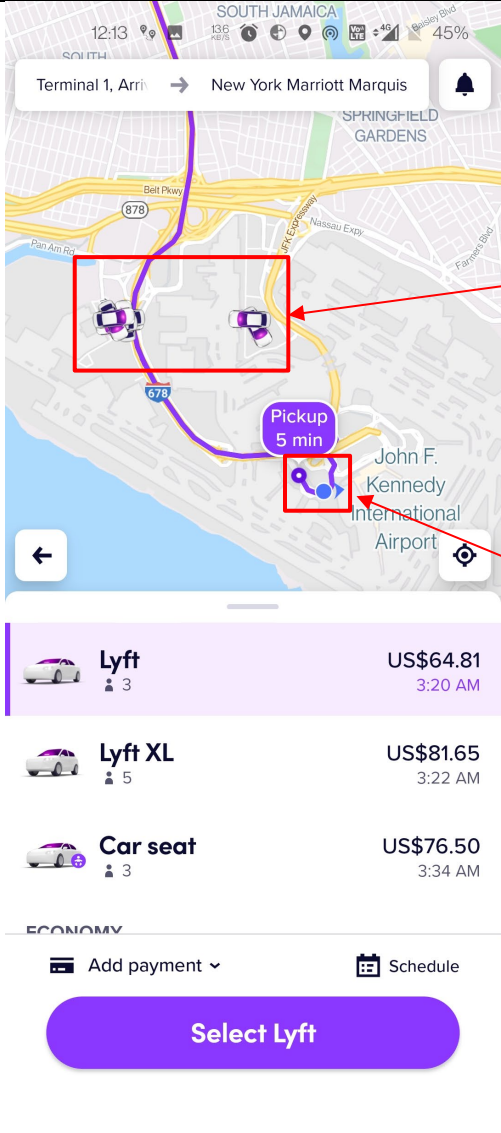
Exhibit A for US Patent No. 10,341,838 Against Lyft Accused Products

Claim 10,341,838	- Exemplary Supporting Evidence Regarding Accused Products												
	 <p>The screenshot displays a Lyft app interface. At the top, the destination is 'New York Marriott Marquis' and the pickup location is 'Terminal 1, Arrivals'. The map shows the area around John F. Kennedy International Airport. Two driver icons are highlighted with a red box, and a red box labeled 'Nearby Drivers' has an arrow pointing to them. Below the map, the Lyft service is selected, showing a price of US\$64.81 and a pickup time of 3:20 AM. Other options include Lyft XL (US\$81.65) and Car seat (US\$76.50). A 'Select Lyft' button is at the bottom.</p> <table border="1"><thead><tr><th>Service</th><th>Price</th><th>Pickup Time</th></tr></thead><tbody><tr><td>Lyft</td><td>US\$64.81</td><td>3:20 AM</td></tr><tr><td>Lyft XL</td><td>US\$81.65</td><td>3:22 AM</td></tr><tr><td>Car seat</td><td>US\$76.50</td><td>3:34 AM</td></tr></tbody></table>	Service	Price	Pickup Time	Lyft	US\$64.81	3:20 AM	Lyft XL	US\$81.65	3:22 AM	Car seat	US\$76.50	3:34 AM
Service	Price	Pickup Time											
Lyft	US\$64.81	3:20 AM											
Lyft XL	US\$81.65	3:22 AM											
Car seat	US\$76.50	3:34 AM											

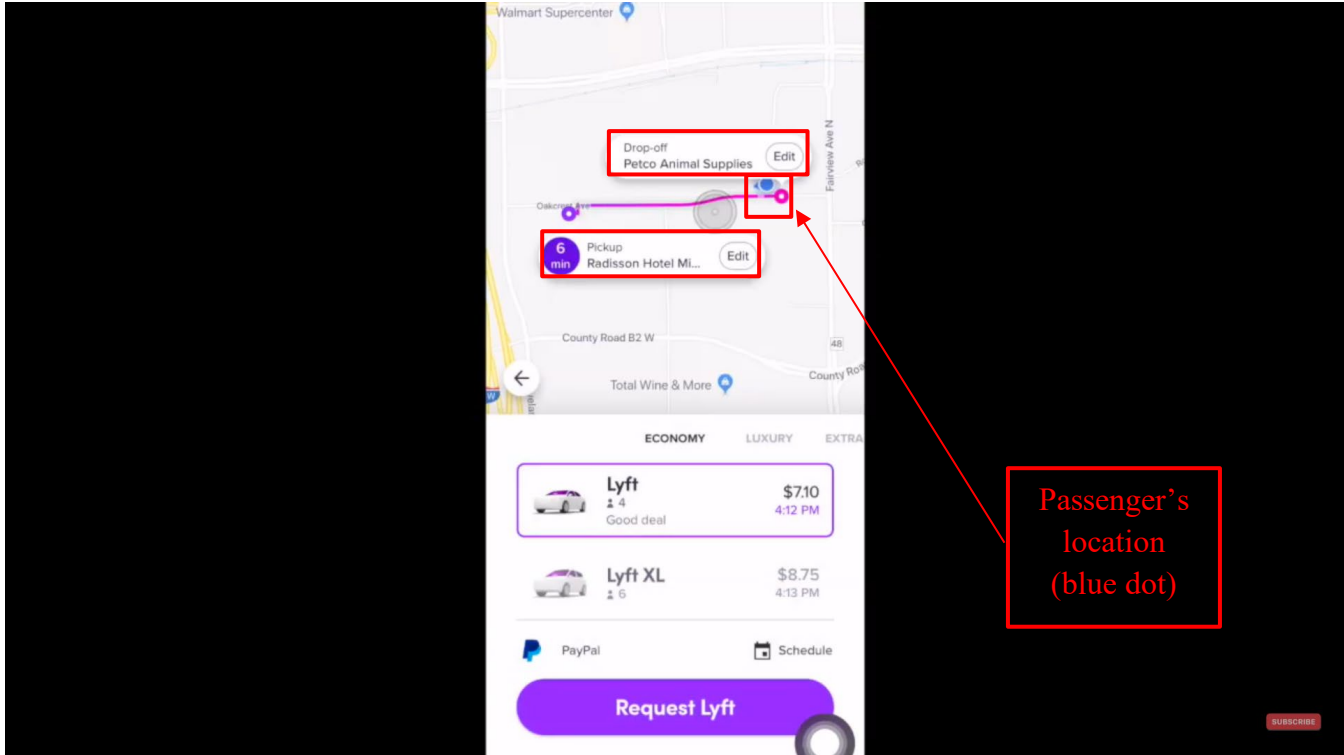
Exhibit A for US Patent No. 10,341,838 Against Lyft Accused Products

Claim 10,341,838	- Exemplary Supporting Evidence Regarding Accused Products
	 <p>https://www.youtube.com/watch?v=jVUy9poJDng at 10:24, Annotated</p> <p>Further, to the extent this element is performed at least in part by Lyft's software source code, AGIS reserves the right to supplement these contentions pursuant to production of such source code by Lyft and to the extent Defendant requires additional information in accordance with P.R. 3-1 and for any other reasons.</p>
<p>6. The method of claim 5, wherein the message to the first mobile device</p>	<p>The Lyft Accused Products infringe directly and/or indirectly by performing, inducing others to perform, and/or contributing to the performance of: wherein the message to the first mobile device corresponding to the vehicle includes the second identifier and updated participant location data.</p> <p>This element is infringed literally, or in the alternative, under the doctrine of equivalents.</p>

Exhibit A for US Patent No. 10,341,838 Against Lyft Accused Products

Claim 10,341,838	- Exemplary Supporting Evidence Regarding Accused Products
<p>corresponding to the vehicle includes the second identifier and updated participant location data.</p>	<p>See claim 1 and 5. The Lyft server(s) meets this limitation because it sends data corresponding to selections made in the Lyft app for riders to the Lyft app for drivers. The Lyft server communicates information including the account/identity information for the rider and the updated location of the rider to the Lyft app for driver. This can occur during the ride request or during the ride.</p> <div style="text-align: center; margin: 10px 0;">  </div> <p>https://www.youtube.com/watch?v=jVUy9poJDng at 10:24, Annotated</p>

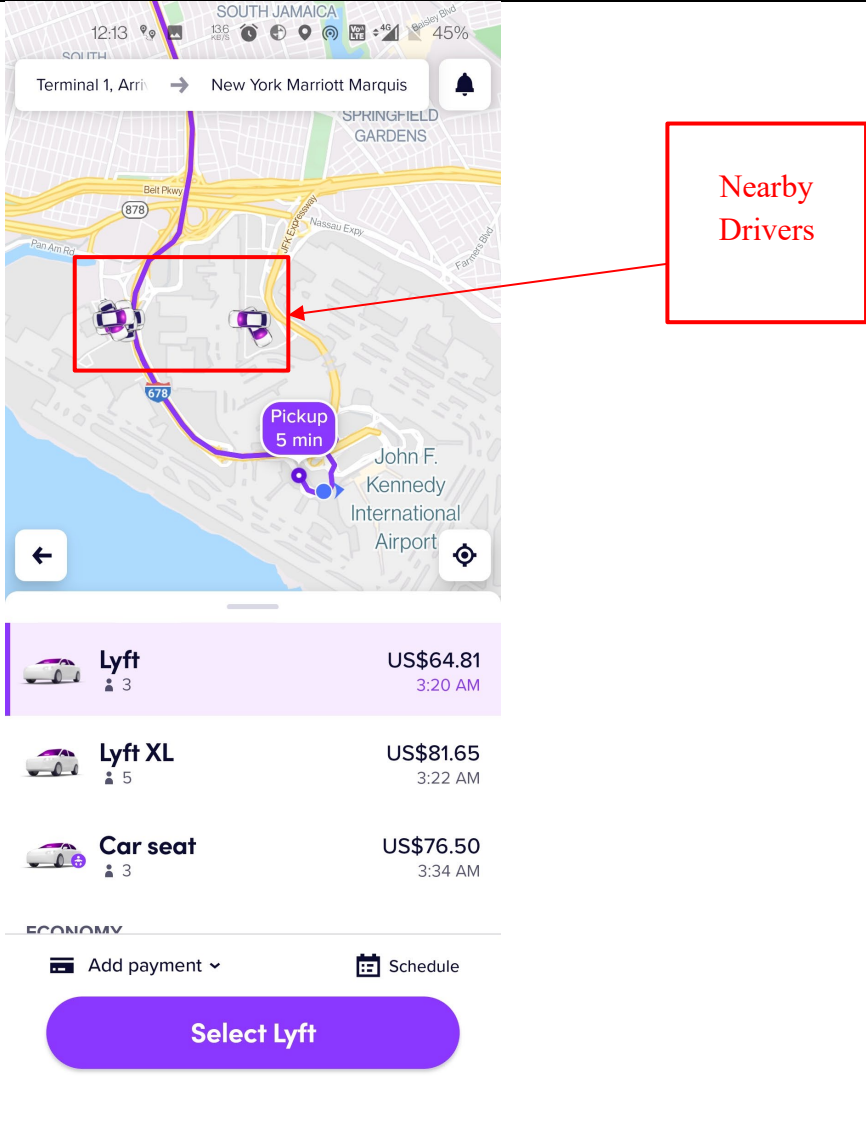
Exhibit A for US Patent No. 10,341,838 Against Lyft Accused Products

Claim 10,341,838	- Exemplary Supporting Evidence Regarding Accused Products
	<div style="text-align: center;">  </div> <p style="text-align: center; color: blue; text-decoration: underline;"> https://www.youtube.com/watch?v=j0RDMLcmOgU at 3:27 </p> <p>Further, to the extent this element is performed at least in part by Lyft's software source code, AGIS reserves the right to supplement these contentions pursuant to production of such source code by Lyft and to the extent Defendant requires additional information in accordance with P.R. 3-1 and for any other reasons.</p>
<p>7. The method of claim 1, wherein performing the one or more acts</p>	<p>The Lyft Accused Products infringe directly and/or indirectly by performing, inducing others to perform, and/or contributing to the performance of: wherein performing the one or more acts comprises sending, based on the participant selection data, the updated vehicle data to the first mobile device corresponding to the vehicle, wherein the first mobile device is configured to display the updated vehicle data within the vehicle map.</p>

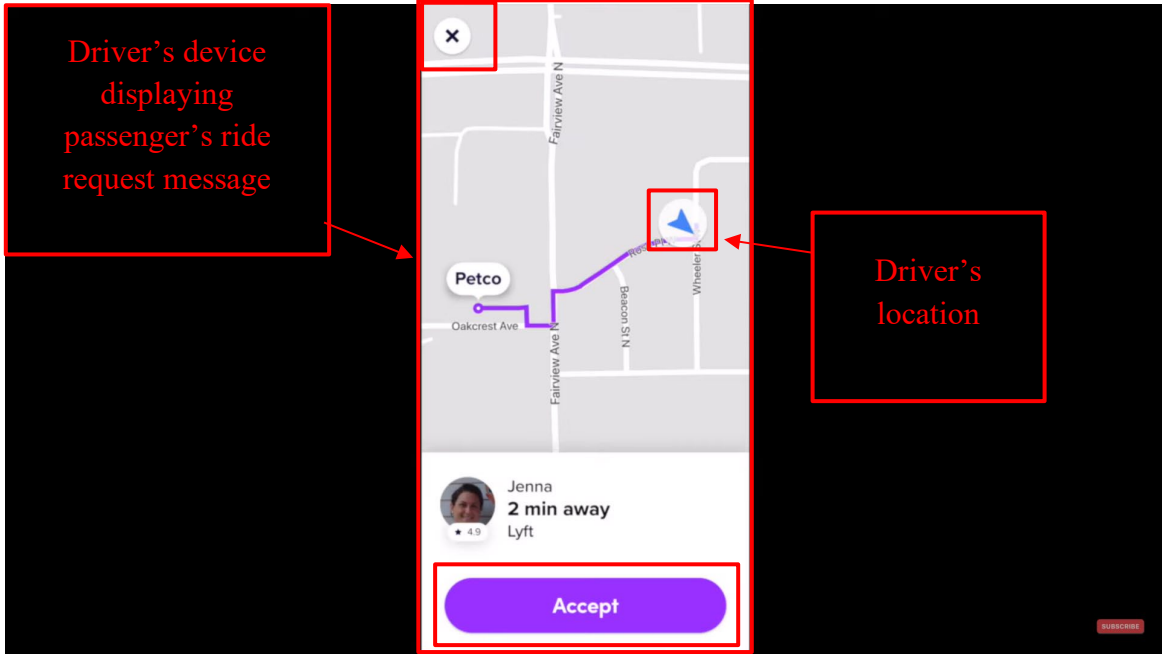
Exhibit A for US Patent No. 10,341,838 Against Lyft Accused Products

Claim 10,341,838	Exemplary Supporting Evidence Regarding Accused Products
<p>comprises sending, based on the participant selection data, the updated vehicle data to the first mobile device corresponding to the vehicle, wherein the first mobile device is configured to display the updated vehicle data within the vehicle map.</p>	<p>This element is infringed literally, or in the alternative, under the doctrine of equivalents.</p> <p>See claim 1. The Lyft server(s) meets this limitation because it sends updated rider location to the Lyft app for drivers and the location is displayed in the Lyft app for drivers. This can occur before or during a ride. For example, after the passenger books the ride by providing the pickup address and destination address (“participant selection data”), the server sends the updated current location of the rider to the driver’s Lyft app. Also, the rider can update this selection data or can transmit a new location to the driver’s Lyft app for display.</p> <div style="text-align: center; margin: 10px 0;">  </div> <p>https://www.youtube.com/watch?v=jVUy9poJDng at 10:24, Annotated</p> <p>Further, to the extent this element is performed at least in part by Lyft's software source code, AGIS reserves the right to supplement these contentions pursuant to production of such source code by Lyft and to the extent Defendant requires additional information in accordance with P.R. 3-1 and for any other reasons.</p>

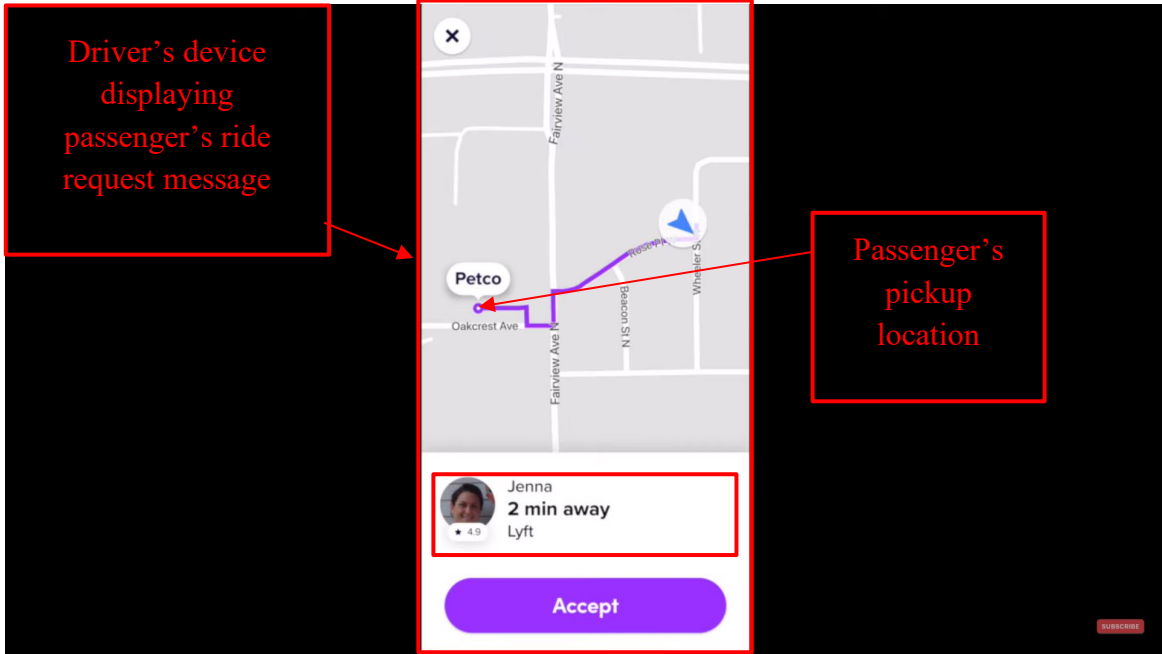
Exhibit A for US Patent No. 10,341,838 Against Lyft Accused Products

Claim 10,341,838	- Exemplary Supporting Evidence Regarding Accused Products
<p>8. The method of claim 1, wherein performing the one or more acts comprises sending, based on the participant selection data, the updated vehicle data to the first mobile device corresponding to the vehicle, wherein the first mobile device is configured to replace the vehicle map with an updated vehicle map on the display of the first mobile device based at least in part on the updated vehicle data.</p>	<p>The Lyft Accused Products infringe directly and/or indirectly by performing, inducing others to perform, and/or contributing to the performance of: wherein performing the one or more acts comprises sending, based on the participant selection data, the updated vehicle data to the first mobile device corresponding to the vehicle, wherein the first mobile device is configured to replace the vehicle map with an updated vehicle map on the display of the first mobile device based at least in part on the updated vehicle data.</p> <p>This element is infringed literally, or in the alternative, under the doctrine of equivalents.</p> <p>See claim 1. The Lyft server(s) meets this limitation because it sends the rider locations to the Lyft app for drivers and that updated rider location is provided for display to the driver via the Lyft app. The Lyft server sends updated map data or maps to the Lyft app for drivers when a new location requires the presentation of a new map, i.e. when the location/route/direction is changed or when the user moves/pans/modifies the map or when the user navigates within or outside the Lyft app and returns to the app.</p>

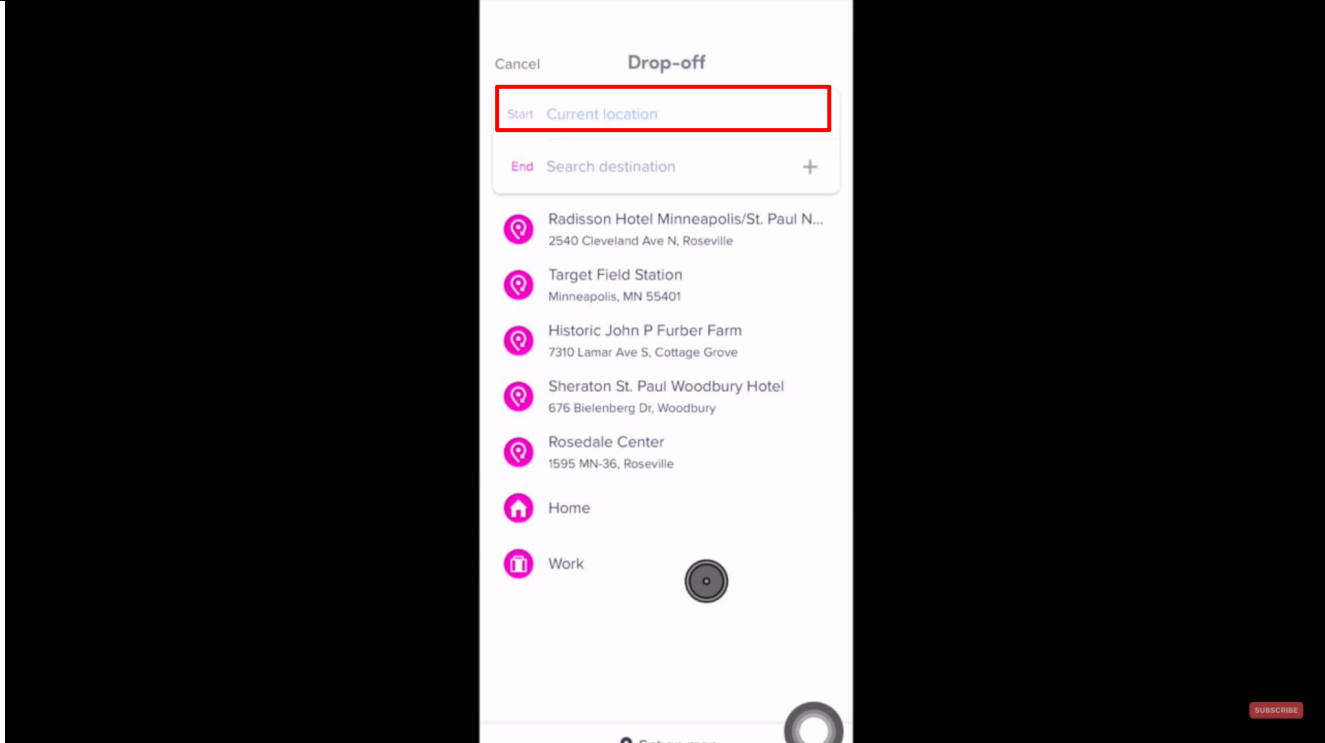
Exhibit A for US Patent No. 10,341,838 Against Lyft Accused Products

Claim 10,341,838	- Exemplary Supporting Evidence Regarding Accused Products
	<div style="display: flex; align-items: center; justify-content: center;"> <div style="border: 2px solid red; padding: 5px; margin-right: 10px; color: red; text-align: center;"> Driver's device displaying passenger's ride request message </div>  <div style="border: 2px solid red; padding: 5px; margin-left: 10px; color: red; text-align: center;"> Driver's location </div> </div> <p style="color: blue; text-decoration: underline;"> https://www.youtube.com/watch?v=jVUy9poJDng at 10:24, Annotated </p> <p>Further, to the extent this element is performed at least in part by Lyft's software source code, AGIS reserves the right to supplement these contentions pursuant to production of such source code by Lyft and to the extent Defendant requires additional information in accordance with P.R. 3-1 and for any other reasons.</p>
<p>9. The method of claim 1, wherein the vehicle map is interactive.</p>	<p>The Lyft Accused Products infringe directly and/or indirectly by performing, inducing others to perform, and/or contributing to the performance of: wherein the vehicle map is interactive.</p> <p>This element is infringed literally, or in the alternative, under the doctrine of equivalents.</p> <p>See claim 1. The Lyft server(s) meets this limitation because the user of the Lyft app can interact with the maps provided by the server.</p>

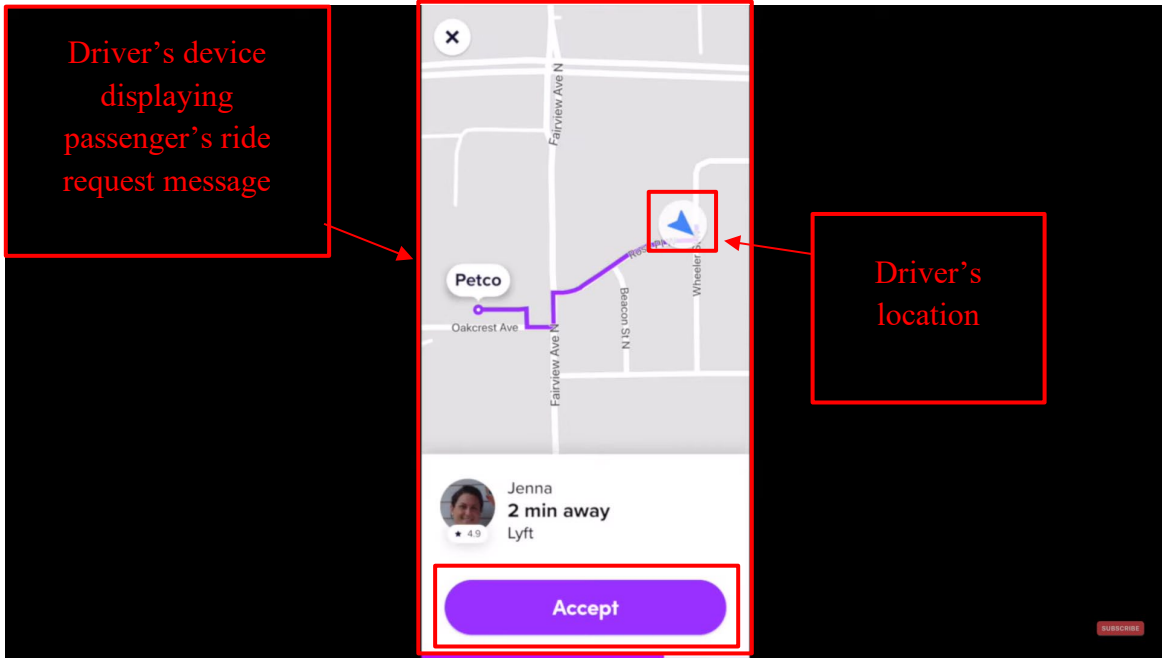
Exhibit A for US Patent No. 10,341,838 Against Lyft Accused Products

Claim 10,341,838	- Exemplary Supporting Evidence Regarding Accused Products
	<div style="text-align: center;">  </div> <p style="text-align: center; color: blue; text-decoration: underline;"> https://www.youtube.com/watch?v=jVUy9poJDng at 10:24 </p> <p>Further, to the extent this element is performed at least in part by Lyft's software source code, AGIS reserves the right to supplement these contentions pursuant to production of such source code by Lyft and to the extent Defendant requires additional information in accordance with P.R. 3-1 and for any other reasons.</p>
<p>10. The method of claim 1, wherein the participant map is interactive.</p>	<p>The Lyft Accused Products infringe directly and/or indirectly by performing, inducing others to perform, and/or contributing to the performance of: wherein the participant map is interactive.</p> <p>This element is infringed literally, or in the alternative, under the doctrine of equivalents.</p> <p>See claim 1. The Lyft server(s) meets this limitation because the user of the Lyft app can interact with the maps provided by the server.</p>

Exhibit A for US Patent No. 10,341,838 Against Lyft Accused Products

Claim 10,341,838	- Exemplary Supporting Evidence Regarding Accused Products
	 <p>The screenshot shows the Lyft mobile application interface. At the top, the status bar displays the time 12:10, signal strength, Wi-Fi, cellular data, and 46% battery. Below the status bar, there is a 'Trip' header with a close button (x) and a 'Change rider' dropdown menu. The main area contains a 'Start' field with a location pin icon and a plus sign, and a 'Destination' field with a location pin icon and a plus sign. Below these fields are four location suggestions: 'Work', 'Home', 'Current location', and 'Set on map'. The 'Set on map' option is highlighted with a red rectangular box. At the bottom of the screen, there is a navigation bar with four icons: a magnifying glass (search), a bicycle (ride), a bus (share), and a person (profile).</p> <p>Further, to the extent this element is performed at least in part by Lyft's software source code, AGIS reserves the right to supplement these contentions pursuant to production of such source code by Lyft and to the extent Defendant requires additional information in accordance with P.R. 3-1 and for any other reasons.</p>

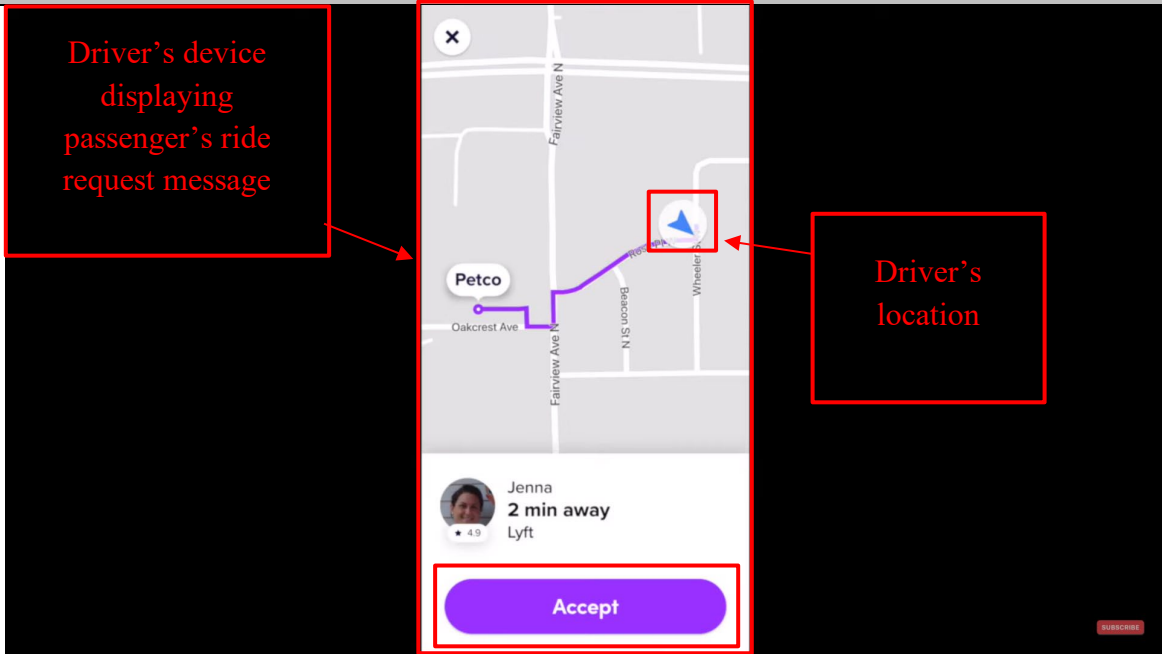
Exhibit A for US Patent No. 10,341,838 Against Lyft Accused Products

Claim 10,341,838	- Exemplary Supporting Evidence Regarding Accused Products
<p>11. The method of claim 1, wherein the new entity of interest is an event and the location of the new entity of interest is a location of the event.</p>	<p>The Lyft Accused Products infringe directly and/or indirectly by performing, inducing others to perform, and/or contributing to the performance of: wherein the new entity of interest is an event and the location of the new entity of interest is a location of the event.</p> <p>This element is infringed literally, or in the alternative, under the doctrine of equivalents.</p> <p>See claim 1. The Lyft server(s) meets this limitation because the rider can schedule a pickup or ride with a location using the Lyft app for riders. The Lyft app can also be used to request a ride from a calendar/schedule which can include the location. For example, the destination address added by the passenger is a location added by the passenger before requesting a ride.</p>

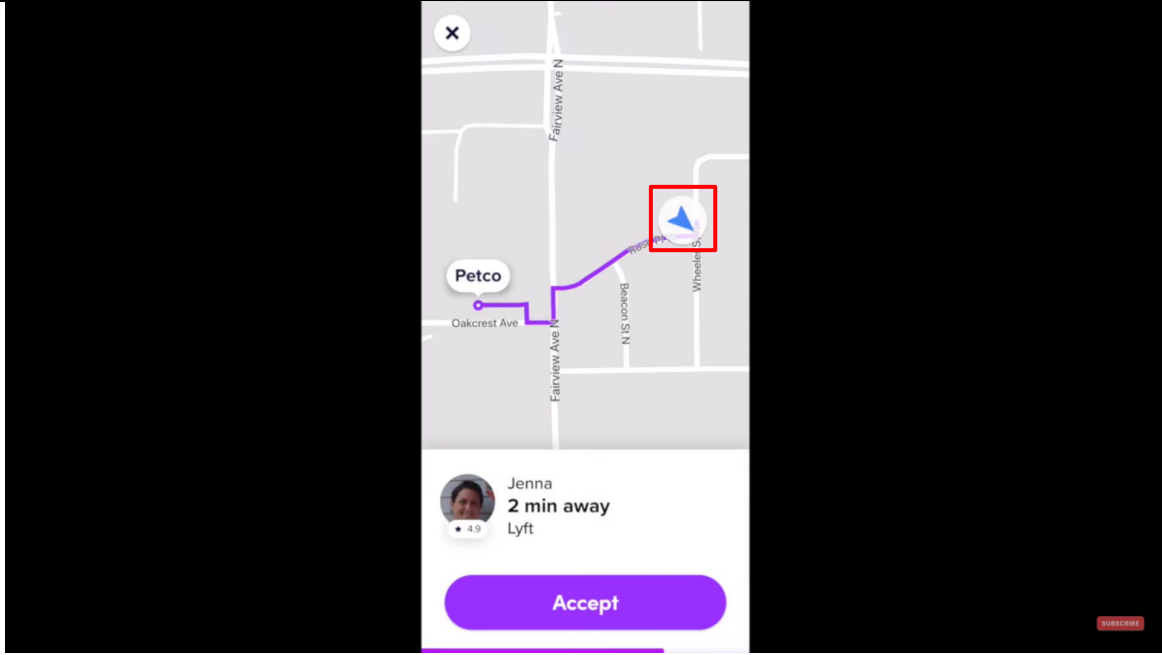
Exhibit A for US Patent No. 10,341,838 Against Lyft Accused Products

Claim 10,341,838	- Exemplary Supporting Evidence Regarding Accused Products
	 <p>The screenshot shows the Lyft mobile application interface. At the top, the status bar displays the time 12:10, signal strength, Wi-Fi, cellular service, and 46% battery. Below the status bar, the app header shows 'Trip' with a close button and a 'Change rider' dropdown menu. The main content area features a 'Start' field and a 'Destination' field, both with location selection icons. The 'Destination' field is highlighted with a red rectangular box. Below these fields are four location suggestions: 'Work', 'Home', 'Current location', and 'Set on map'. At the bottom of the screen, there is a navigation bar with icons for search, bicycle, car, and a person icon.</p> <p>Further, to the extent this element is performed at least in part by Lyft's software source code, AGIS reserves the right to supplement these contentions pursuant to production of such source code by Lyft and to the extent Defendant requires additional information in accordance with P.R. 3-1 and for any other reasons.</p>

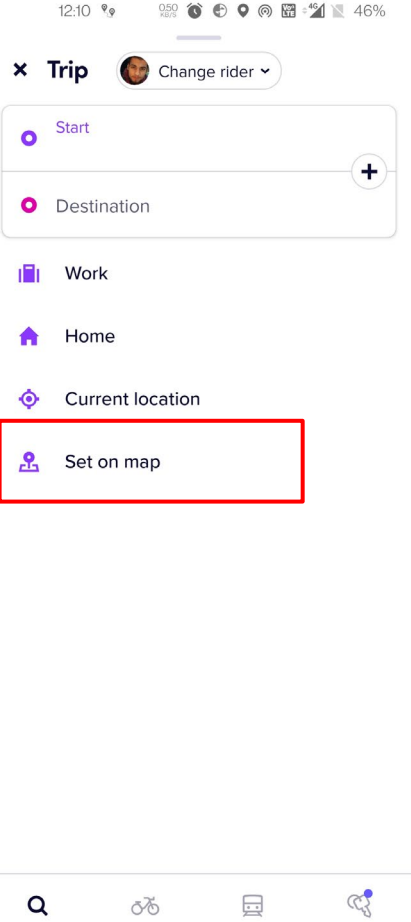
Exhibit A for US Patent No. 10,341,838 Against Lyft Accused Products

Claim 10,341,838	Exemplary Supporting Evidence Regarding Accused Products
<p>12. The method of claim 1, wherein the new entity of interest location is different from the locations of the first and second mobile devices.</p>	<p>The Lyft Accused Products infringe directly and/or indirectly by performing, inducing others to perform, and/or contributing to the performance of: wherein the new entity of interest location is different from the locations of the first and second mobile devices.</p> <p>This element is infringed literally, or in the alternative, under the doctrine of equivalents.</p> <p>See claim 1. The Lyft server(s) meets this limitation because a user can specify a new entity of interest that is not the same location of the rider location or driver location. For example, the user can specify another pickup/stop/destination which is different from the rider/driver locations.</p> <div style="text-align: center; margin-top: 20px;">  </div> <p style="text-align: center; margin-top: 10px;"> https://www.youtube.com/watch?v=j0RDMLcmOgU at 3:49 </p>

Exhibit A for US Patent No. 10,341,838 Against Lyft Accused Products

Claim 10,341,838	- Exemplary Supporting Evidence Regarding Accused Products
	 <p>https://www.youtube.com/watch?v=jVUy9poJDng at 10:24, Annotated</p> <p>Further, to the extent this element is performed at least in part by Lyft's software source code, AGIS reserves the right to supplement these contentions pursuant to production of such source code by Lyft and to the extent Defendant requires additional information in accordance with P.R. 3-1 and for any other reasons.</p>
<p>13. The method of claim 5, wherein the message comprises at least one of a text message, a</p>	<p>The Lyft Accused Products infringe directly and/or indirectly by performing, inducing others to perform, and/or contributing to the performance of: wherein the message comprises at least one of a text message, a photograph, or a video.</p> <p>This element is infringed literally, or in the alternative, under the doctrine of equivalents.</p>

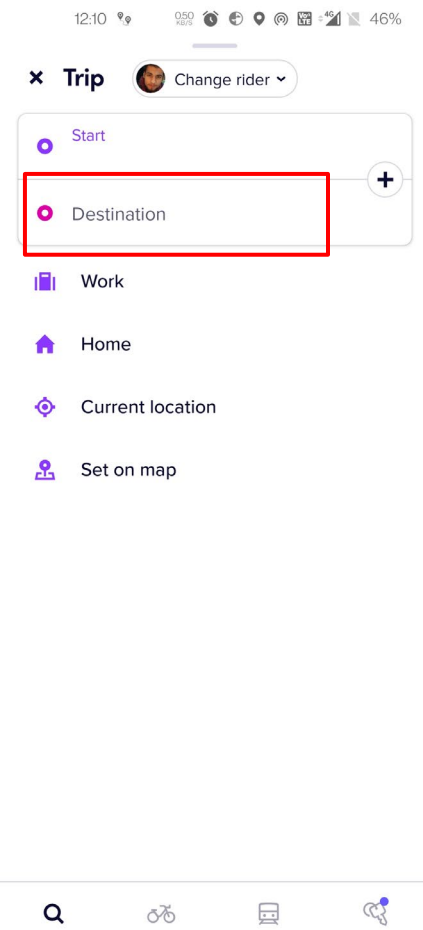
Exhibit A for US Patent No. 10,341,838 Against Lyft Accused Products

Claim 10,341,838	- Exemplary Supporting Evidence Regarding Accused Products
<p>photograph, or a video.</p>	<p>The Lyft server(s) meets this limitation because it can communicate at least text messages between riders/drivers via the Lyft apps. The Lyft server(s) also communicate profile photos to/from the apps.</p> <div style="text-align: center;">  </div> <p>https://www.youtube.com/watch?v=jVUy9poJDng at 10:24, Annotated</p> <p>Further, to the extent this element is performed at least in part by Lyft's software source code, AGIS reserves the right to supplement these contentions pursuant to production of such source code by Lyft and to the extent Defendant requires additional information in accordance with P.R. 3-1 and for any other reasons.</p>
<p>14[P]. A system comprising:</p>	<p><i>See Claims 1[P] and 1[A] above.</i></p>
<p>14[A]. one or more servers each having one</p>	<p><i>See Claims 1[P] and 1[A] above.</i></p>

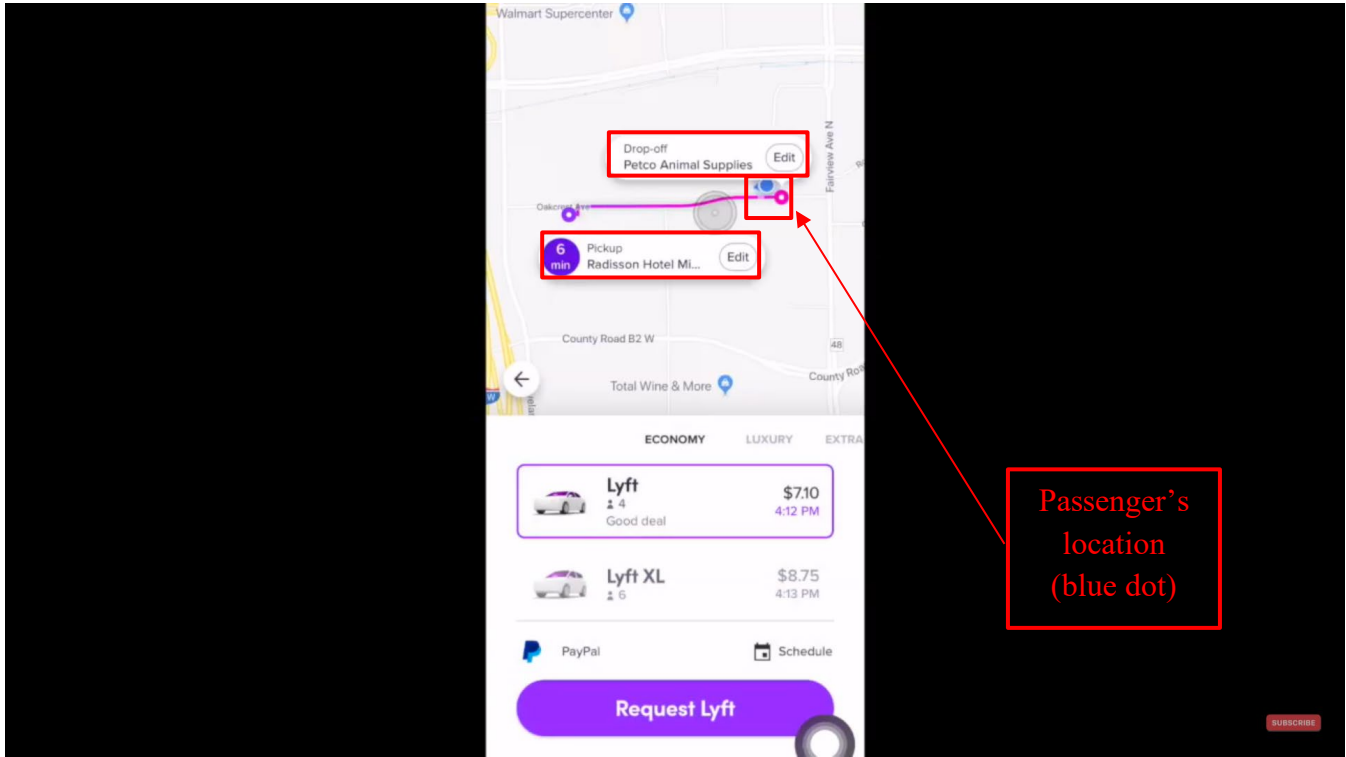
Exhibit A for US Patent No. 10,341,838 Against Lyft Accused Products

Claim 10,341,838	- Exemplary Supporting Evidence Regarding Accused Products
or more processors, the processors configured to execute instructions to perform operations comprising:	
14[B]. obtaining first data provided by a first mobile device corresponding to a vehicle, the first data including a first identifier	<i>See Claim 1[B] above.</i>
14 [C]. permitting the first mobile device corresponding to the vehicle to join a communication network, the permitting based on a determination	<i>See Claim 1[C] above.</i>

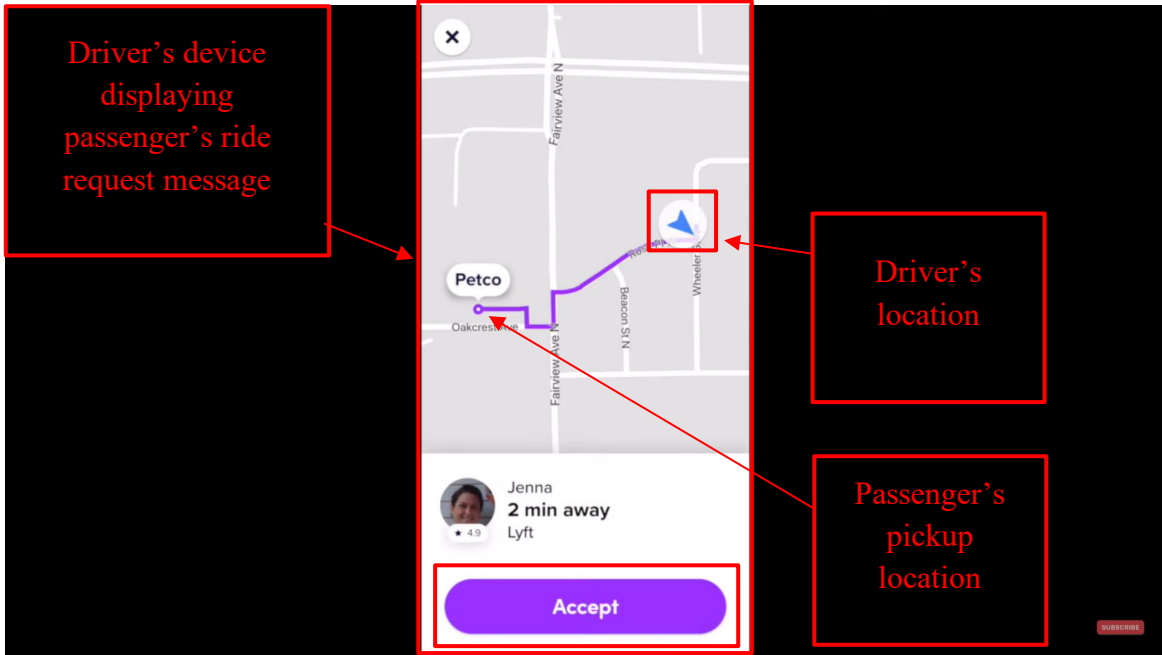
Exhibit A for US Patent No. 10,341,838 Against Lyft Accused Products

Claim 10,341,838	- Exemplary Supporting Evidence Regarding Accused Products
regarding the first data	
14[D]. obtaining second data provided by a second mobile device corresponding to a participant, the second data including a second identifier associated with the participant	<i>See Claim 1[D] above.</i>
14[E]. allowing the second mobile device corresponding to the participant to join the communication network, the allowing based on a determination regarding the second data	<i>See Claim 1[E] above.</i>

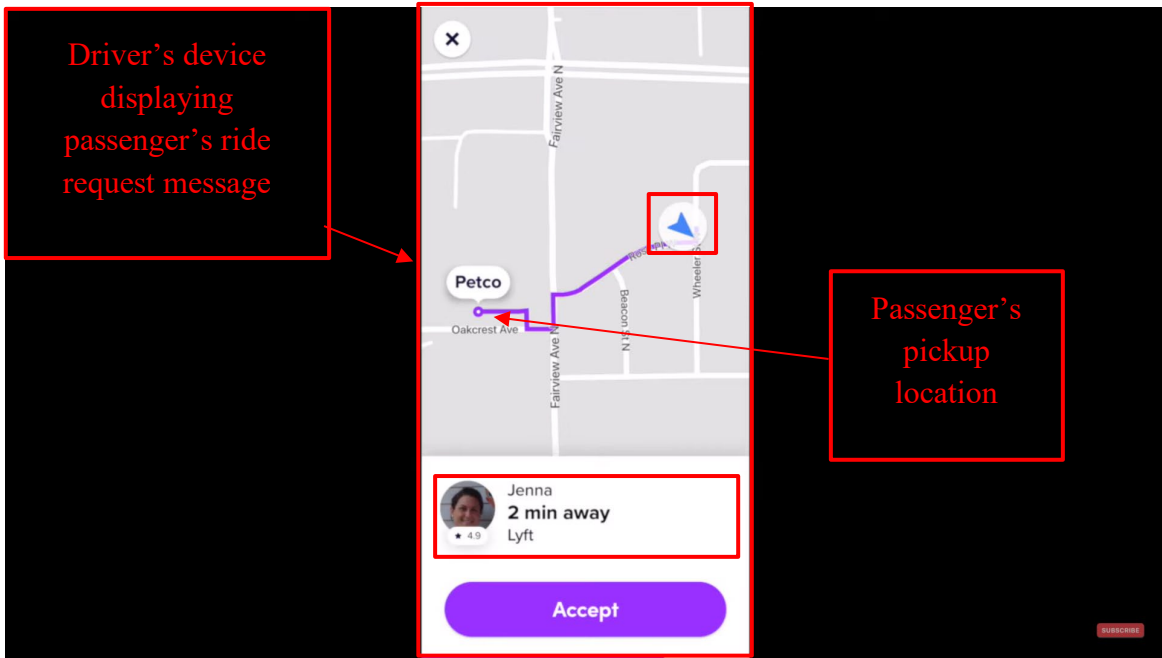
Exhibit A for US Patent No. 10,341,838 Against Lyft Accused Products

Claim 10,341,838	- Exemplary Supporting Evidence Regarding Accused Products
14[F]. receiving vehicle location data provided by the first mobile device corresponding to the vehicle, wherein the vehicle location data are associated with the first identifier and indicate coordinates of a geographical location of the first mobile device	<i>See Claim 1[F] above.</i>
14[G]. receiving participant location data provided by the second mobile device corresponding to the participant, wherein the participant	<i>See Claim 1[G] above.</i>

Exhibit A for US Patent No. 10,341,838 Against Lyft Accused Products

Claim 10,341,838	- Exemplary Supporting Evidence Regarding Accused Products
location data are associated with the second identifier and indicate coordinates of a geographical location of the second mobile device	
14[H]. sending participant data to the second mobile device corresponding to the participant, wherein the participant data comprise the vehicle location data, wherein the second mobile device corresponding to the participant is configured to (1) determine coordinates of a position on the	<i>See Claim 1[H] above.</i>

Exhibit A for US Patent No. 10,341,838 Against Lyft Accused Products

Claim 10,341,838	- Exemplary Supporting Evidence Regarding Accused Products
participant map corresponding to the coordinates of the geographical location of the second mobile device, (2) display the participant map, and (3) place a first symbol on the participant map at the determined coordinates of the position on the participant map corresponding to the coordinates of the geographical location of the second mobile device	
14[I]. sending vehicle data to the first mobile	<i>See Claim 1[I] above.</i>

Exhibit A for US Patent No. 10,341,838 Against Lyft Accused Products

Claim 10,341,838	- Exemplary Supporting Evidence Regarding Accused Products
<p>device corresponding to the vehicle, wherein the vehicle data comprise the participant location data, wherein the first mobile device corresponding to the vehicle is configured to (1) determine coordinates of a position on the vehicle map corresponding to the coordinates of the geographical location of the first mobile device, (2) display the vehicle map, and (3) place a second symbol on the vehicle map at the</p>	

Exhibit A for US Patent No. 10,341,838 Against Lyft Accused Products

Claim 10,341,838	- Exemplary Supporting Evidence Regarding Accused Products
determined coordinates of the position on the vehicle map corresponding to the coordinates of the geographical location of the first mobile device	
14[J]. receiving participant selection data provided by the second mobile device corresponding to the participant, the participant selection data corresponding to user input provided via a display of the second mobile device	<i>See Claim 1[J] above.</i>
14[K]. based on the participant	<i>See Claim 1[K] above.</i>

Exhibit A for US Patent No. 10,341,838 Against Lyft Accused Products

Claim - 10,341,838	Exemplary Supporting Evidence Regarding Accused Products
<p>selection data, performing one or more acts selected from the group consisting of: sending updated vehicle data to the first mobile device corresponding to the vehicle, sending updated participant data to the second mobile device corresponding to the participant, and sending a message to the first mobile device corresponding to the vehicle</p>	
<p>14[L]. receiving entity-of-interest data transmitted by the second mobile device,</p>	<p><i>See Claim 1[L] above.</i></p>

Exhibit A for US Patent No. 10,341,838 Against Lyft Accused Products

Claim - 10,341,838	Exemplary Supporting Evidence Regarding Accused Products
<p>the entity-of-interest data comprising coordinates of a geographical location of a new entity of interest, wherein the second mobile device is configured to (1) identify participant interaction with a display of the second mobile device, the participant interaction indicating selection of a position on the participant map and entry of the new entity of interest at the selected position, (2) display an entity symbol</p>	

Exhibit A for US Patent No. 10,341,838 Against Lyft Accused Products

Claim 10,341,838	- Exemplary Supporting Evidence Regarding Accused Products
<p>representing the new entity of interest at the selected position on the participant map, (3) determine coordinates of a geographical location of the new entity of interest based on coordinates of the selected position on the participant map, and (4) transmit the entity-of-interest data; and</p>	
<p>14[M]. sending the entity-of-interest data to the first mobile device corresponding to the vehicle, wherein the first mobile device is configured to place the entity</p>	<p><i>See Claim 1[M] above.</i></p>

Exhibit A for US Patent No. 10,341,838 Against Lyft Accused Products

Claim - 10,341,838	Exemplary Supporting Evidence Regarding Accused Products
<p>symbol representing the new entity of interest on the vehicle map at a position on the vehicle map corresponding to the geographical location of the new entity of interest.</p>	
<p>15. The system of claim 14, wherein performing the one or more acts comprises sending, based on the participant selection data, the updated participant data to the second mobile device corresponding to the participant, wherein the</p>	<p><i>See Claim 2 above.</i></p>

Exhibit A for US Patent No. 10,341,838 Against Lyft Accused Products

Claim 10,341,838	- Exemplary Supporting Evidence Regarding Accused Products
second mobile device is configured to display the updated participant data within the participant map.	
16. The system of claim 15, wherein the updated participant data comprise updated vehicle location data indicating coordinates of an updated geographical location of the first mobile device corresponding to the vehicle.	<i>See Claim 3 above.</i>
17. The system of claim 14, wherein performing the one or more acts comprises	<i>See Claim 4 above.</i>

Exhibit A for US Patent No. 10,341,838 Against Lyft Accused Products

Claim - 10,341,838	Exemplary Supporting Evidence Regarding Accused Products
<p>sending, based on the participant selection data, the updated participant data to the second mobile device corresponding to the participant, wherein the second mobile device is configured to replace the participant map with an updated participant map on the display of the second mobile device based at least in part on the updated participant data.</p>	
<p>18. The system of claim 14, wherein performing the one or more acts</p>	<p><i>See Claim 5 above.</i></p>

Exhibit A for US Patent No. 10,341,838 Against Lyft Accused Products

Claim 10,341,838	- Exemplary Supporting Evidence Regarding Accused Products
comprises sending, based on the participant selection data, the message to the first mobile device corresponding to the vehicle.	
19. The system of claim 18, wherein the message to the first mobile device corresponding to the vehicle includes the second identifier and updated participant location data.	<i>See Claim 6 above.</i>
20. The system of claim 14, wherein performing the one or more acts comprises sending, based	<i>See Claim 7 above.</i>

Exhibit A for US Patent No. 10,341,838 Against Lyft Accused Products

Claim 10,341,838	- Exemplary Supporting Evidence Regarding Accused Products
<p>on the participant selection data, the updated vehicle data to the first mobile device corresponding to the vehicle, wherein the first mobile device is configured to display the updated vehicle data within the vehicle map.</p>	
<p>21. The system of claim 14, wherein performing the one or more acts comprises sending, based on the participant selection data, the updated vehicle data to the first mobile device corresponding</p>	<p><i>See Claim 8 above.</i></p>

Exhibit A for US Patent No. 10,341,838 Against Lyft Accused Products

Claim 10,341,838	- Exemplary Supporting Evidence Regarding Accused Products
to the vehicle, wherein the first mobile device is configured to replace the vehicle map with an updated vehicle map on the display of the first mobile device based at least in part on the updated vehicle data.	
22. The system of claim 14, wherein the vehicle map is interactive.	<i>See Claim 9 above</i>
23. The system of claim 14, wherein the participant map is interactive.	<i>See Claim 10 above.</i>
24. The system of claim 14, wherein the new entity of interest is an event and the location of the new entity	<i>See Claim 11 above.</i>

Exhibit A for US Patent No. 10,341,838 Against Lyft Accused Products

Claim 10,341,838	- Exemplary Supporting Evidence Regarding Accused Products
of interest is a location of the event.	
25. The system of claim 14, wherein the new entity of interest location is different from the locations of the first and second mobile devices.	<i>See Claim 12 above.</i>
26. The system of claim 18, wherein the message comprises at least one of a text message, a photograph, or a video.	<i>See Claim 13 above.</i>

Exhibit B for US Patent No. 7,630,724 Against Lyft Accused Products

Based on information presently available, AGIS Software Development LLC (“AGIS”) contends that Defendant Lyft Technologies Inc. (collectively “Lyft” or “Defendant”) infringes claims 9, 12-16 (the “Asserted Claims”) of U.S. Patent No. 7,630,724 (the “724 Patent”) through the Accused Products, Services which are manufactured, sold, offered for sale, and/or used by Lyft.

The Accused Products comprise all versions of the Lyft Application made, used, sold, offered for sale, or otherwise provided, after September 21, 2004. For example, the Accused Products comprise the Lyft application installed on all Android, iOS, Blackberry, and Windows Mobile based mobile devices (e.g. smartphones, tablets, laptops, and smart watches), and any variants thereof. AGIS reserves the right to amend this list of Accused Products as discovery progresses.

Lyft directly infringes each of the Asserted Claims by using, importing, testing, selling, and/or offering for sale the Accused Products in violation of 35 U.S.C. § 271(a).

Lyft indirectly infringes the Asserted Claims in violation of 35 U.S.C. § 271(b) by inducing third parties, including its users and/or customers, to directly infringe through their operation and use of the Accused Products. Lyft has knowingly and intentionally induced this direct infringement by, *inter alia*, (i) selling, importing, or otherwise providing the Accused Products to third parties with the intent that the Accused Products will be operated and used in a manner that practices the Asserted Claims; and (ii) marketing and advertising the Accused Products. Lyft’s marketing and promotional materials for the Accused Products are found, for example, on Lyft’s website, and in App stores of operating systems for which the Accused Products are made available. For example, Lyft’s website offers customers instructions and/or manuals for the Accused Products that instruct customers to, among other things, use the accused services in the Accused Products. Lyft’s website also offers support to customers, including instruction to, among other things, use the Accused Products share location information with a group of users. On information and belief, Lyft knows that its actions will result in infringement of the Asserted Claims, or subjectively believes that there is a high probability that its actions will result in infringement of the Asserted Claims but has taken deliberate actions to avoid learning these facts.

Lyft also contributorily infringes each of the Asserted Claims in violation of 35 U.S.C. § 271(c) by selling, importing, offering for sale, and otherwise providing the Accused Products, which when used directly infringe the Asserted Claims. The Accused Products constitute a material part of the Asserted Claims.

On information and belief, the charted version of the Lyft application is representative of all versions of the Accused Products, including all variants of the Accused Products made, sold, offered for sale, or used on any version of the Android, iOS, Blackberry, and Windows Mobile operating systems.

Exhibit B for US Patent No. 7,630,724 Against Lyft Accused Products

AGIS does not concede that any claims of the '724 Patent that are not listed below are not infringed by the identified Accused Products. Moreover, the citations to certain documents and other information below are intended to be exemplary only and in no way foreclose AGIS from citing or relying on additional documents, information, source code, and/or testimony at a later time. These contentions are preliminary in nature, and an analysis of Lyft's products, internal documentation, source code, and/or testimony from relevant witnesses may more fully and accurately describe the infringing features of its Accused Products. Accordingly, AGIS reserves the right to supplement, correct, modify, and/or amend these contentions once such additional information is made available to AGIS. Furthermore, AGIS reserves the right to supplement, correct, modify, and/or amend these contentions as discovery in this case progresses; in view of the Court's claim construction order(s); in view of any positions taken by Lyft, including, but not limited to, positions on claim construction,¹ invalidity, and/or non-infringement; and in connection with the preparation and exchange of expert reports.

The contents of every below claim cell on which another claim cell depends are expressly incorporated by reference in that dependent cell, as if set forth in their entirety therein.

¹ The construction of claim terms herein is consistent with the constructions in *AGIS Software Dev. LLC v. Huawei Device USA, Inc.*, No. 2:17-cv-00513-JRG, Dkt. No. 205 (Lead Case) (E.D. Tex. Oct. 10, 2018) and *AGIS Software Dev. LLC v. Google LLC*, No. 2:19-cv-00361-JRG, Dkt. No. 147 (Lead Case) (E.D. Tex. Dec. 20, 2020). AGIS reserves the right to update its constructions and contentions in view of this Court's claim construction order.

Exhibit B for US Patent No. 7,630,724 Against Lyft Accused Products

Claim – 7,630,724	Exemplary Supporting Evidence Regarding Lyft’s Accused Products
<p>9[P]. A method for providing a cellular phone communication network for designated participating users, each user having a similarly equipped cellular phone that includes a CPU, GPS navigational system, an interact message transmitter and receiver and a touch screen display comprising:</p>	<p>The Lyft Accused Products perform a computer implemented method as set forth below. Lyft further infringes directly and/or indirectly by performing, inducing others to perform, and/or contributing to the performance of: a method for providing a cellular phone communication network for designated participating users, each user having a similarly equipped cellular phone that includes a CPU, GPS navigational system, an interact message transmitter and receiver and a touch screen display.</p> <p>This element is infringed literally, or in the alternative, under the doctrine of equivalents.</p> <p>For example, Lyft provides Lyft app for passengers and Lyft Driver app for drivers. The Lyft apps for riders and drivers, in conjunction with Lyft’s servers and services, provide users with interactive methods to request, view, and track locations of passengers/riders using real-time maps and communications. The Lyft server(s) and their services communicate with the Lyft apps for riders and drivers. The Lyft server(s) and their services host information related to and instructions for processing user/device/vehicle accounts, location data, and map data. The claimed methods are distributed by Lyft in the Lyft apps. The claimed methods are used/tested by Lyft using the Lyft apps. The claimed methods are downloaded and installed by Lyft’s customers (riders) and personnel (drivers, personnel) at the direction/encouragement of Lyft and used by Lyft’s customers and Lyft’s personnel.</p> <p>. Each of the driver and the passenger’s mobile phones which are installed with the Lyft and Lyft driver apps comprises a CPU, GPS, a navigational system symbol generator (Lyft App and Lyft Driver App) and a touch screen display. The Lyft and Lyft Driver application is supported by smart devices including but not limited to smartphones and tablets, which have an antenna in them for both transmission and reception.</p> <h3 style="margin-top: 20px;">Lyft Driver app</h3> <div style="border: 1px solid red; padding: 5px; margin-top: 10px;"> <p>We’ve separated the passenger and driver experiences into two separate mobile apps — one exclusively for passengers (named the Lyft app) and the other exclusively for drivers (named the Lyft Driver app).</p> </div> <p>The Lyft Driver app will eventually be standard for all drivers and required for driving. At this time, drivers can keep using the Lyft app to give rides. Don’t worry! While we have some planned improvements to the Lyft Driver app, we’ve kept its features the same.</p>

Exhibit B for US Patent No. 7,630,724 Against Lyft Accused Products

Claim – 7,630,724	Exemplary Supporting Evidence Regarding Lyft's Accused Products
	<p data-bbox="577 272 1470 305">https://help.lyft.com/hc/en-ca/articles/115013079208-Lyft-Driver-app</p> <h3 data-bbox="577 354 892 402">What is Lyft?</h3> <p data-bbox="577 456 1654 526">Lyft is a platform that connects drivers with individuals and organizations that need rides.</p> <p data-bbox="577 553 1050 586">https://www.lyft.com/drive-with-lyft</p>  <p data-bbox="577 1019 703 1052">Go online</p> <p data-bbox="577 1084 1774 1192">Open your Lyft Driver app and tap the steering wheel icon. Lyft will now find the closest passenger to your location requesting a ride. Turn on some music and get comfortable: that first ride request may come quickly or may take a while, depending on the number of current passenger requests.</p> <p data-bbox="577 1198 1228 1230">https://www.lyft.com/hub/posts/how-to-give-a-ride</p>

Exhibit B for US Patent No. 7,630,724 Against Lyft Accused Products

Claim – 7,630,724	Exemplary Supporting Evidence Regarding Lyft's Accused Products
	<p data-bbox="625 261 840 423">Driver's device displaying passenger's ride request message</p>  <p data-bbox="575 883 1491 915">https://www.youtube.com/watch?v=jVUy9poJDng at 10:24, Annotated</p>

Exhibit B for US Patent No. 7,630,724 Against Lyft Accused Products

Claim – 7,630,724	Exemplary Supporting Evidence Regarding Lyft's Accused Products
	 <p>https://www.youtube.com/watch?v=j0RDMLcmOgU at 4:01</p>

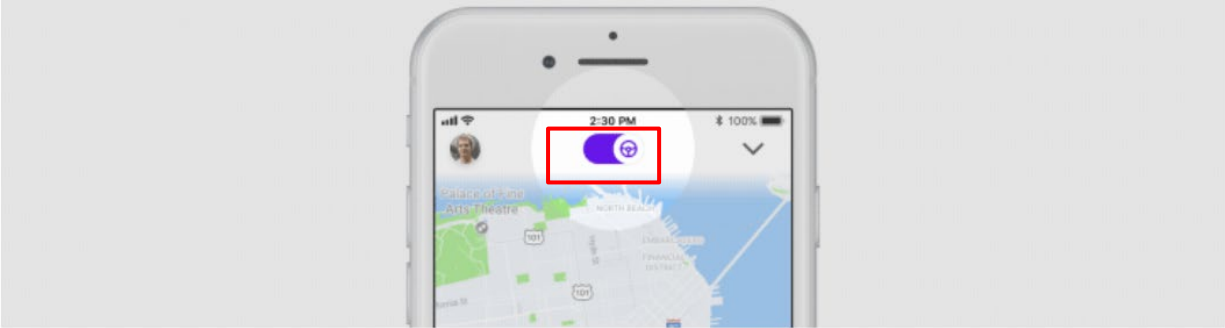
Exhibit B for US Patent No. 7,630,724 Against Lyft Accused Products

Claim – 7,630,724	Exemplary Supporting Evidence Regarding Lyft's Accused Products
	 <p>https://apps.apple.com/in/app/lyft/id529379082</p>

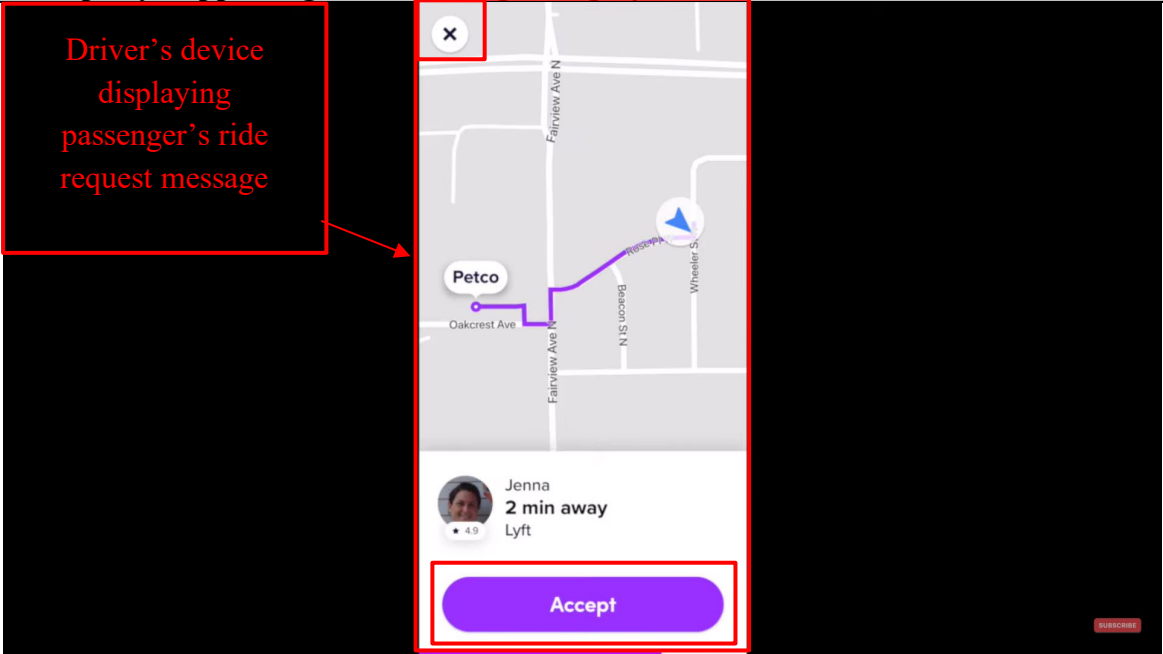
Exhibit B for US Patent No. 7,630,724 Against Lyft Accused Products

Claim – 7,630,724	Exemplary Supporting Evidence Regarding Lyft’s Accused Products
	<p>Combining multiple components into a single chip saves on space, cost, and power consumption. Essentially, an SoC is the brain of your smartphone that handles everything from the Android operating system to detecting when you press the power off button. SoCs connect to other components too, such as cameras, a display, RAM, flash storage, and much more.</p> <p>The list below contains the most common components that you will find inside a smartphone System-on-a-Chip. We’re going to cover a few of the most important ones later on in this article.</p> <ul style="list-style-type: none"> • Central Processing Unit (CPU) — The “brains” of the SoC. Runs most of the code for the Android OS and most of your apps. • Graphics Processing Unit (GPU) — Handles graphics-related tasks, such as visualizing an app’s user interface and 2D/3D gaming. • Image Processing Unit (ISP) — Converts data from the phone’s camera into image and video files. • Digital Signal Processor (DSP) — Handles more mathematically intensive functions than a CPU. Includes decompressing music files and analyzing gyroscope sensor data. • Neural Processing Unit (NPU) — Used in high-end smartphones to accelerate machine learning (AI) tasks. These include voice recognition and camera processing. • Video encoder/decoder — Handles the power-efficient conversion of video files and formats. • Modems — Converts wireless signals into data your phone understands. Components include 4G LTE, 5G, WiFi, and Bluetooth modems. <p>https://www.androidauthority.com/what-is-an-soc-smartphone-chipsets-explained-1051600/</p>

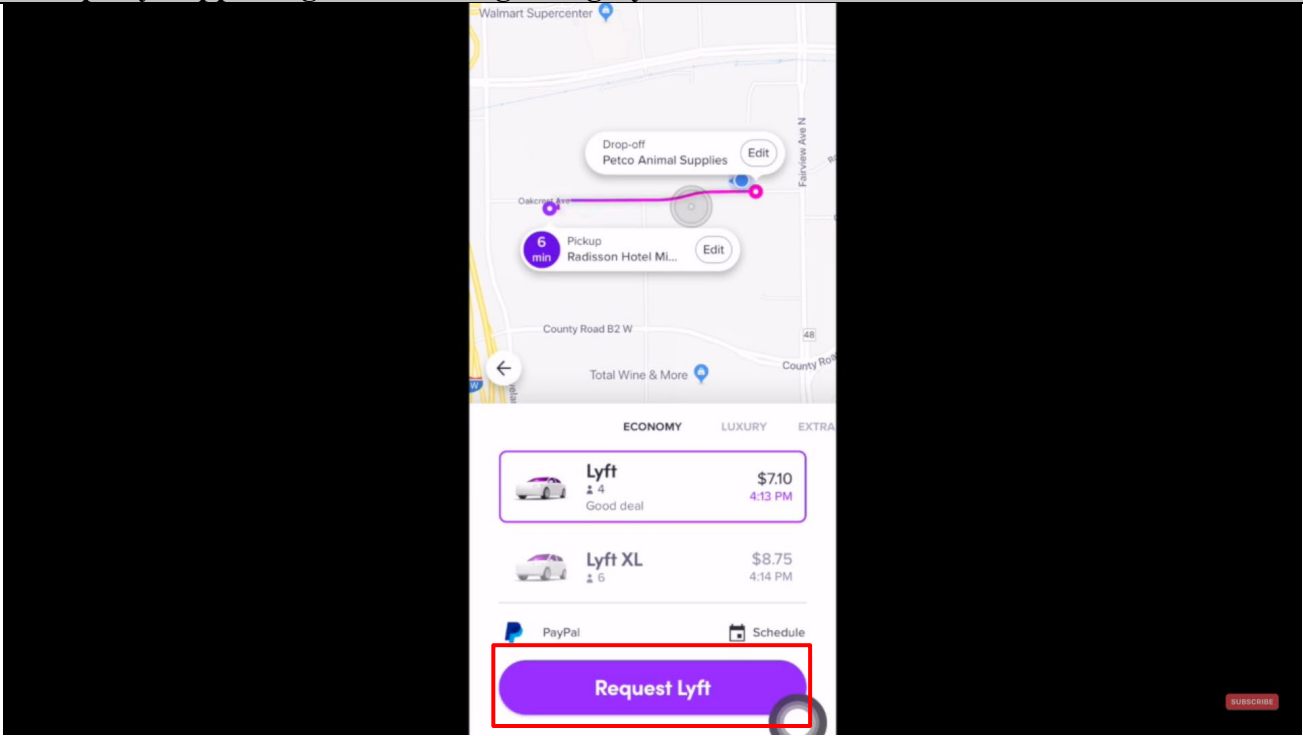
Exhibit B for US Patent No. 7,630,724 Against Lyft Accused Products

Claim – 7,630,724	Exemplary Supporting Evidence Regarding Lyft’s Accused Products
	<p data-bbox="577 235 1738 414">You must have seen that every Android and iOS device in today’s age comes with GPS right inside it. This is one feature that will be there in every smartphone no matter what the price of that device might be. And that is because of the fact that GPS is the most basic yet most useful feature on every smartphone.</p> <p data-bbox="577 462 1766 730">Just for information, the GPS stands for Global Positioning System and it provides accurate geolocation and time information for every equipment that is equipped with a GPS receiver. Now, the best example of using GPS is with services such as Google Maps, Apple Maps, and others where you can see where exactly you are right now on the Map. This is thanks to the GPS receiver which sends a signal to the GPS satellite.</p> <p data-bbox="577 738 1520 776">https://www.cashify.in/how-to-turn-off-gps-on-any-android-or-ios-device</p>

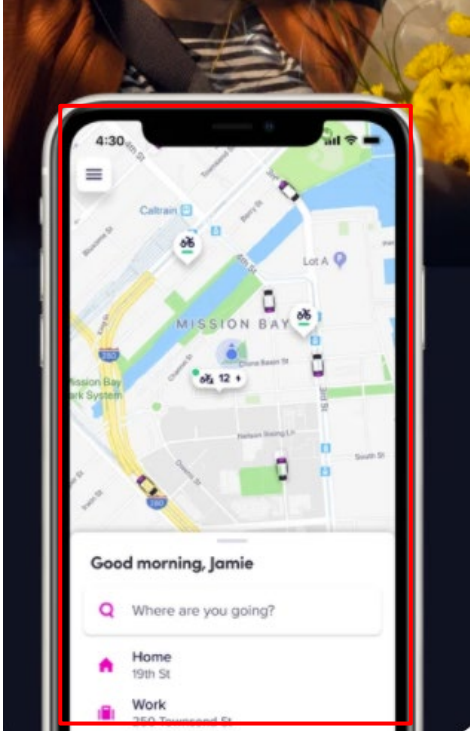
Exhibit B for US Patent No. 7,630,724 Against Lyft Accused Products

Claim – 7,630,724	Exemplary Supporting Evidence Regarding Lyft’s Accused Products
	<p data-bbox="577 245 1108 305">Mobile phone contents</p> <p data-bbox="577 337 1858 483">Mobile phones contain a large amount of circuitry, each of which is carefully designed to optimise its performance. The cell phone comprises analogue electronics as well as digital circuits ranging from processors to display and keypad electronics. A mobile phone typically consists of a single board, but within this there are a number of distinct functional areas, but designed to integrate to become a complete mobile phone:</p> <ul data-bbox="598 505 1129 829" style="list-style-type: none"> <li data-bbox="598 505 1129 553">• Radio frequency - receiver and transmitter <li data-bbox="598 570 919 602">• Digital signal processing <li data-bbox="598 626 968 659">• Analogue / digital conversion <li data-bbox="598 683 842 716">• Control processor <li data-bbox="598 740 831 773">• SIM or USIM card <li data-bbox="598 797 926 829">• Power control and battery <p data-bbox="577 857 1879 927">https://www.electronics-notes.com/articles/connectivity/cellular-mobile-phone/how-cellphone-works-inside-components.php</p> <p data-bbox="577 967 1900 1105">Further, to the extent this element is performed at least in part by Lyft’s software source code, AGIS reserves the right to supplement these contentions pursuant to production of such source code by Lyft and to the extent Defendant requires additional information in accordance with P.R. 3-1 and for any other reasons.</p>
<p data-bbox="199 1154 548 1365">9[A] accessing a database in each cell phone that includes a geographical map of a predetermined area for user viewing on the touch screen display;</p>	<p data-bbox="577 1154 1900 1292">The Lyft Accused Products perform a computer implemented method as set forth below. Lyft further infringes directly and/or indirectly by performing, inducing others to perform, and/or contributing to the performance of: accessing a database in each cell phone that includes a geographical map of a predetermined area for user viewing on the touch screen display.</p> <p data-bbox="577 1333 1703 1365">This element is infringed literally, or in the alternative, under the doctrine of equivalents.</p>

Exhibit B for US Patent No. 7,630,724 Against Lyft Accused Products

Claim – 7,630,724	Exemplary Supporting Evidence Regarding Lyft’s Accused Products
	<p>For example, in the Lyft app for passengers, the passenger will receive a geographical location on the map on the display of their mobile phone. The geographical map is accessed through the database of the Lyft app. Through this geographical map, the passenger is able to make a ride request to a particular location and see the location of different nearby drivers before making the request and viewing the location of the driver after a driver accepts the passenger’s ride request.</p> <p>For example, in the Lyft driver app, the driver will receive a geographical map of their location, which is accessed through the database of the Lyft driver application. Through this app, the driver is able to see the location of the rider, when the ride request message of the passenger is broadcasted with the passenger’s pickup location (provided pickup location is set to the current location by the passenger).</p>

Exhibit B for US Patent No. 7,630,724 Against Lyft Accused Products

Claim – 7,630,724	Exemplary Supporting Evidence Regarding Lyft's Accused Products												
	 <p>The screenshot displays the Lyft app interface. At the top, the map shows the route from Terminal 1, Arrivals to New York Marriott Marquis. A red box highlights two driver icons on the map, with a red arrow pointing to a text box labeled "Nearby Drivers' location". Another red box highlights the pickup location at John F. Kennedy International Airport, with a red arrow pointing to a text box labeled "Passenger's location". Below the map, a list of ride options is shown:</p> <table border="1"><thead><tr><th>Ride Type</th><th>Price</th><th>Time</th></tr></thead><tbody><tr><td>Lyft (3 seats)</td><td>US\$64.81</td><td>3:20 AM</td></tr><tr><td>Lyft XL (5 seats)</td><td>US\$81.65</td><td>3:22 AM</td></tr><tr><td>Car seat (3 seats)</td><td>US\$76.50</td><td>3:34 AM</td></tr></tbody></table> <p>At the bottom, there is a "Select Lyft" button.</p>	Ride Type	Price	Time	Lyft (3 seats)	US\$64.81	3:20 AM	Lyft XL (5 seats)	US\$81.65	3:22 AM	Car seat (3 seats)	US\$76.50	3:34 AM
Ride Type	Price	Time											
Lyft (3 seats)	US\$64.81	3:20 AM											
Lyft XL (5 seats)	US\$81.65	3:22 AM											
Car seat (3 seats)	US\$76.50	3:34 AM											

Exhibit B for US Patent No. 7,630,724 Against Lyft Accused Products

Claim – 7,630,724	Exemplary Supporting Evidence Regarding Lyft's Accused Products
	 <p>https://www.youtube.com/watch?v=j0RDMLcmOgU at 3:27</p>

Exhibit B for US Patent No. 7,630,724 Against Lyft Accused Products

Claim – 7,630,724	Exemplary Supporting Evidence Regarding Lyft's Accused Products
	 <p>https://www.youtube.com/watch?v=j0RDMLcmOgU at 4:01</p>

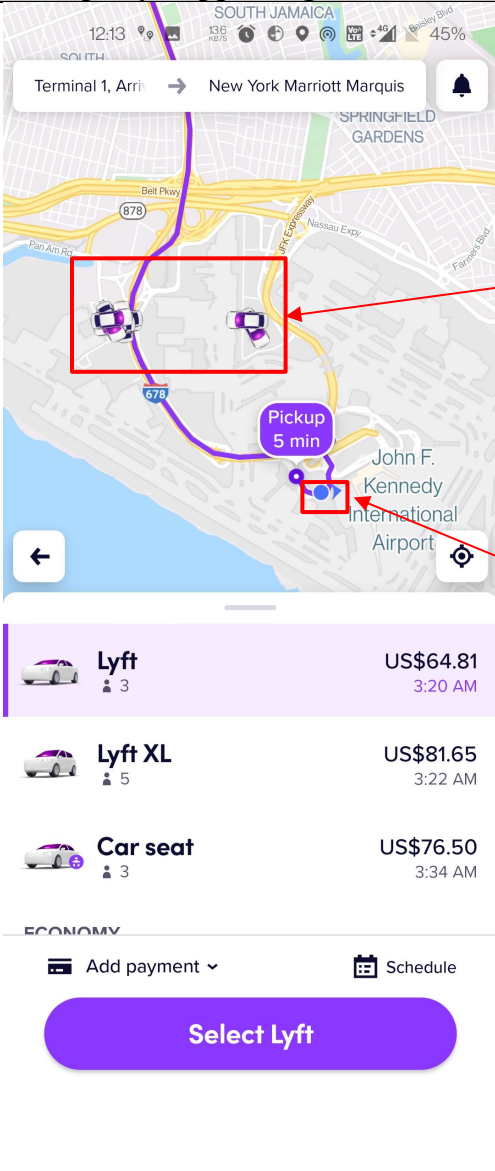
Exhibit B for US Patent No. 7,630,724 Against Lyft Accused Products

Claim – 7,630,724	Exemplary Supporting Evidence Regarding Lyft's Accused Products
	 <p>The screenshot shows a Lyft ride request notification on a mobile device. The notification includes a map showing the pickup location (Petco) and the driver's current location. The driver's name is Jenna, with a 4.9 rating, and the ride is 2 minutes away. A purple 'Accept' button is visible at the bottom of the notification. Red boxes and arrows highlight specific elements: the top left box points to the notification area; the bottom left box points to the pickup location on the map; the right box points to the driver's current location on the map; and the bottom box points to the 'Accept' button.</p> <p>Driver's device displaying passenger's ride request message</p> <p>Passenger's current location (when pickup location is set to current location)</p> <p>Driver's current location</p> <p>https://www.youtube.com/watch?v=jVUy9poJDng at 10:24, Annotated</p>

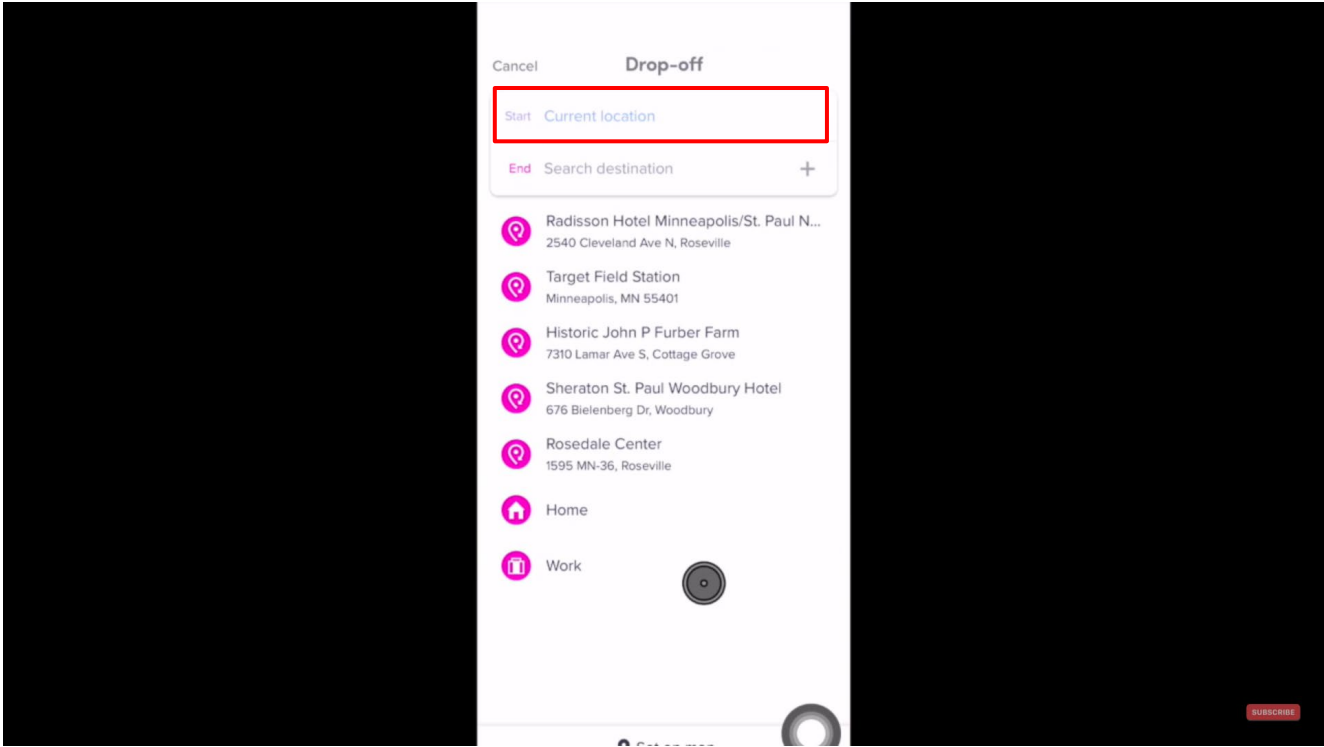
Exhibit B for US Patent No. 7,630,724 Against Lyft Accused Products

Claim – 7,630,724	Exemplary Supporting Evidence Regarding Lyft's Accused Products
	 <p data-bbox="611 358 898 602">Driver's mobile phone screen</p> <p data-bbox="657 646 945 889">Passenger's current location (when pickup location is set to current location)</p> <p data-bbox="1549 456 1837 699">Driver's current location</p> <p data-bbox="575 979 1488 1011">https://www.youtube.com/watch?v=jVUy9poJDng at 10:46, Annotated</p>

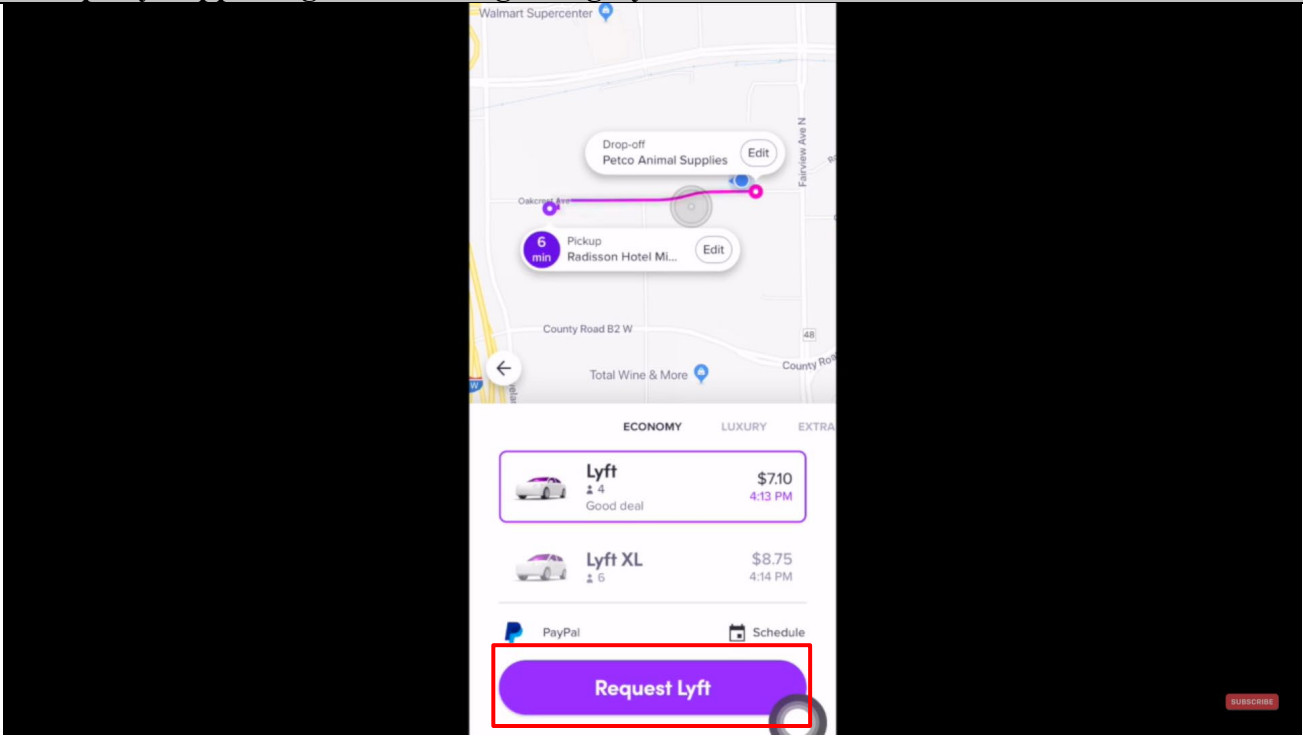
Exhibit B for US Patent No. 7,630,724 Against Lyft Accused Products

Claim – 7,630,724	Exemplary Supporting Evidence Regarding Lyft’s Accused Products
	<div style="text-align: center;">  </div> <p style="text-align: center; color: blue;"> https://www.youtube.com/watch?v=j0RDMLcmOgU at 5:07, Annotated </p> <p> Further, to the extent this element is performed at least in part by Lyft's software source code, AGIS reserves the right to supplement these contentions pursuant to production of such source code by Lyft and to the extent Defendant requires additional information in accordance with P.R. 3-1 and for any other reasons. </p>
<p>9[B]. accessing an application program in each cell phone for generating one or more symbols representative of</p>	<p>The Lyft Accused Product(s) performs a computer implemented method as set forth below. Lyft further infringes directly and/or indirectly by performing, inducing others to perform, and/or contributing to the performance of: accessing an application program in each cell phone for generating one or more symbols representative of one or more participating users, each of whom have a similarly equipped cellular phone.</p>

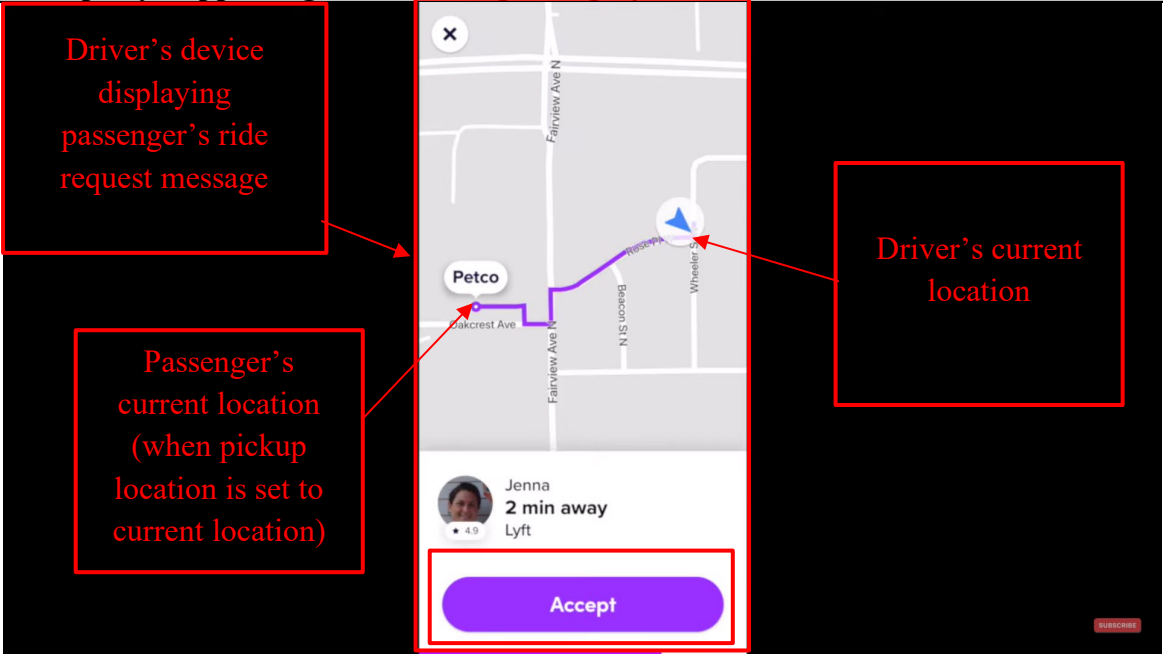
Exhibit B for US Patent No. 7,630,724 Against Lyft Accused Products

Claim – 7,630,724	Exemplary Supporting Evidence Regarding Lyft’s Accused Products
<p>one or more participating users, each of whom have a similarly equipped cellular phone;</p>	<p>This element is infringed literally, or in the alternative, under the doctrine of equivalents.</p> <p>For example, Lyft app displays symbols on the screen representing the passenger as well as the driver’s vehicle.</p> <div style="text-align: center;">  </div> <p>https://www.youtube.com/watch?v=j0RDMLcmOgU at 5:07</p> <p>Further, to the extent this element is performed at least in part by Lyft's software source code, AGIS reserves the right to supplement these contentions pursuant to production of such source code by Lyft and to the extent Defendant requires additional information in accordance with P.R. 3-1 and for any other reasons.</p>

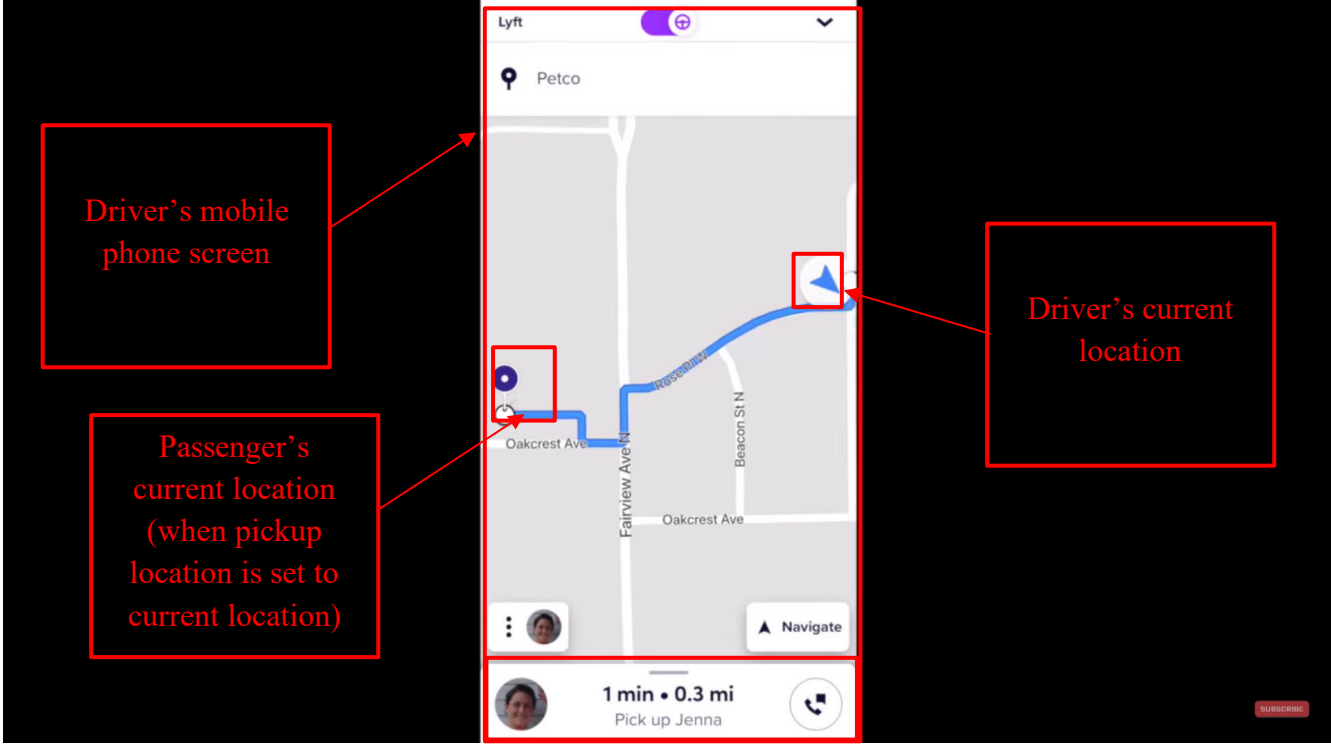
Exhibit B for US Patent No. 7,630,724 Against Lyft Accused Products

Claim – 7,630,724	Exemplary Supporting Evidence Regarding Lyft’s Accused Products
<p>9[C]. accessing a database in each cell phone that includes cellular telephone numbers of each of the participating users having similarly equipped cellular phones, said database including the generation of one or more symbols associated with a particular participating user;</p>	<p>The Lyft Accused Products perform a computer implemented method as set forth below. Lyft further infringes directly and/or indirectly by performing, inducing others to perform, and/or contributing to the performance of: accessing a database in each cell phone that includes cellular telephone numbers of each of the participating users having similarly equipped cellular phones, said database including the generation of one or more symbols associated with a particular participating user.</p> <p>This element is infringed literally, or in the alternative, under the doctrine of equivalents.</p> <p>The Lyft apps meet this limitation because they access the cellular telephone numbers of the riders/drivers of the Lyft platform/network. On information and belief, the telephone numbers are stored on one or more databases either locally or remotely on a Lyft server(s) for access by the Lyft apps. For example, when the driver is matched to the passenger, both the driver and the passenger get the call icon (“rapid voice initiation and communication”) on their respective mobile phones display in the Lyft driver and Lyft app respectively through which both of them call each other by tapping the call icon on their respective touch screen display.</p>

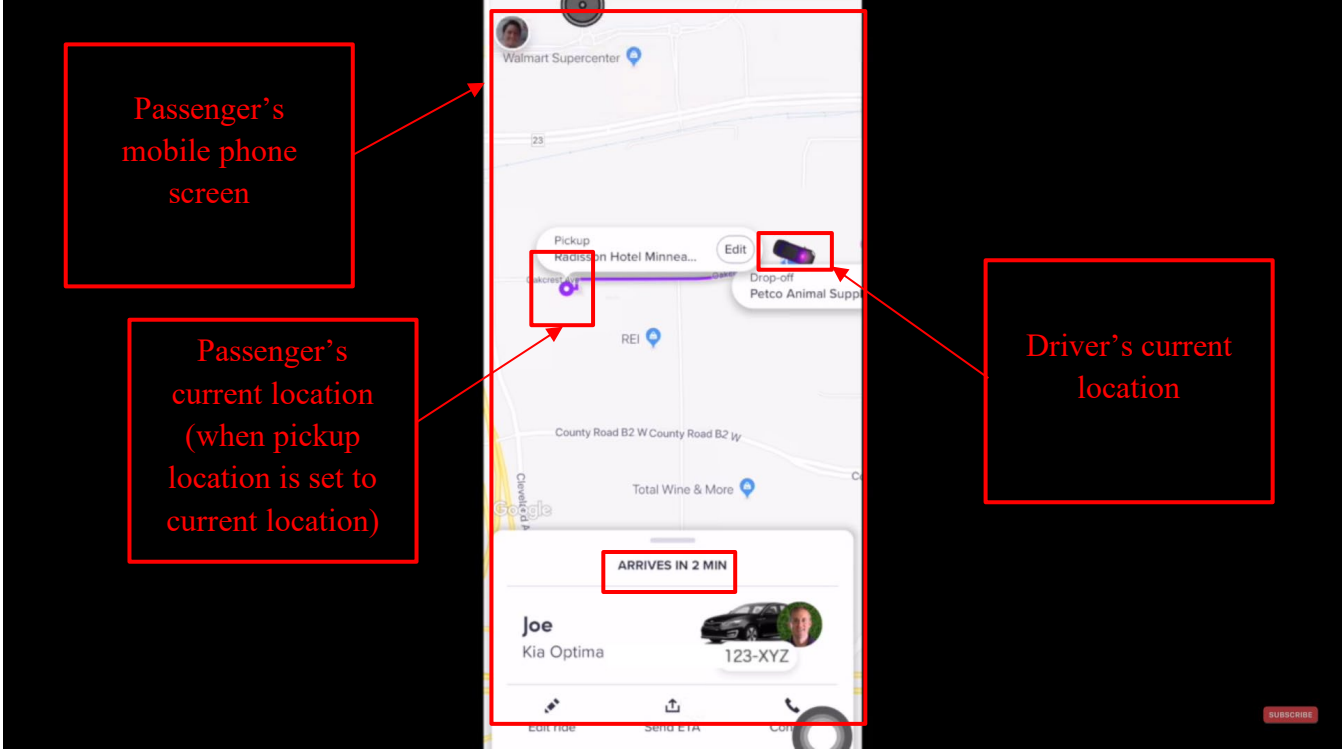
Exhibit B for US Patent No. 7,630,724 Against Lyft Accused Products

Claim – 7,630,724	Exemplary Supporting Evidence Regarding Lyft's Accused Products
	 <p>https://www.youtube.com/watch?v=j0RDMLcmOgU at 5:07</p>

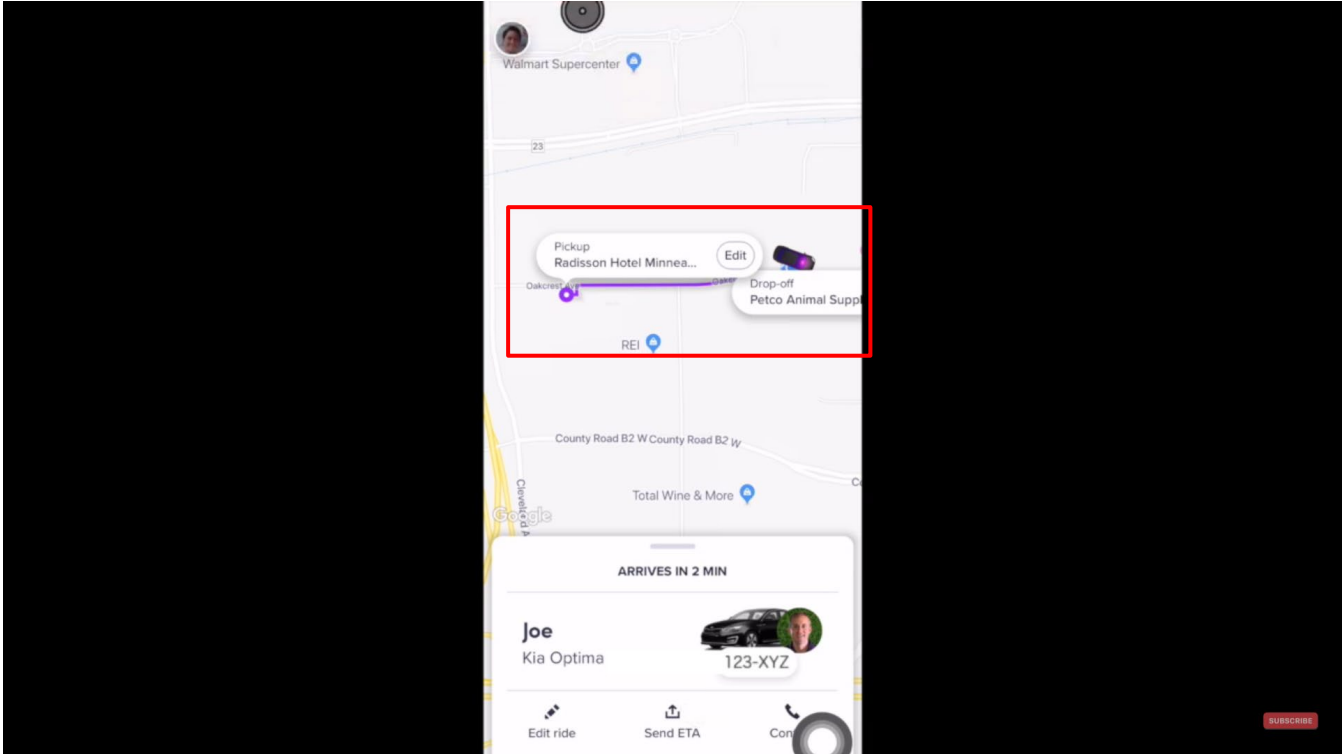
Exhibit B for US Patent No. 7,630,724 Against Lyft Accused Products

Claim – 7,630,724	Exemplary Supporting Evidence Regarding Lyft’s Accused Products
	 <p>The screenshot shows the Lyft app interface. At the top, it says 'Lyft' with a toggle switch and a dropdown arrow. Below that is a location pin for 'Petco'. The main area is a map showing a blue route starting from a location on Oakcrest Ave, going south on Fairview Ave N, then east on Beacon St N, and finally north on Oakcrest Ave. At the bottom, there is a 'Navigate' button and a call button (a telephone handset icon) which is highlighted with a red box. To the left of the call button, it says '1 min • 0.3 mi' and 'Pick up Jenna'. There is also a profile picture of a woman next to the call button.</p> <p>https://www.youtube.com/watch?v=jVUy9poJDng at 10:46</p> <p>Further, to the extent this element is performed at least in part by Lyft's software source code, AGIS reserves the right to supplement these contentions pursuant to production of such source code by Lyft and to the extent Defendant requires additional information in accordance with P.R. 3-1 and for any other reasons..</p>
<p>9[D]. calling a participating user by touching the symbol on the map display and touching a call switch;</p>	<p><i>See</i> claims 9[C].</p> <p>The Lyft Accused Products perform a computer implemented method as set forth below. Lyft further infringes directly and/or indirectly by performing, inducing others to perform, and/or contributing to the performance of: calling a participating user by touching the symbol on the map display and touching a call switch.</p>

Exhibit B for US Patent No. 7,630,724 Against Lyft Accused Products

Claim – 7,630,724	Exemplary Supporting Evidence Regarding Lyft’s Accused Products
	<p>This element is infringed literally, or in the alternative, under the doctrine of equivalents.</p> <p>The Lyft apps meet this limitation because provide selectable interface elements on the Lyft application for calling drivers/riders. For example, when the driver is matched to the passenger, both the driver and the passenger get the call icon (“rapid voice initiation and communication”) on their respective mobile phones display in the Lyft driver and Lyft app respectively through which both of them call each other by tapping the call icon on their respective touch screen display.</p> <div style="text-align: center;">  <p>The screenshot shows a Lyft ride confirmation screen. At the top, it displays the pickup location 'Radisson Hotel Minnea...' and the drop-off location 'Petco Animal Supp...'. Below this, it shows the driver's name 'Joe', the vehicle 'Kia Optima', and the license plate '123-XYZ'. A call icon is visible in the bottom right corner of the ride card. The arrival time is 'ARRIVES IN 2 MIN'. The background is a map showing the route.</p> </div> <p>https://www.youtube.com/watch?v=j0RDMLcmOgU at 5:07</p>

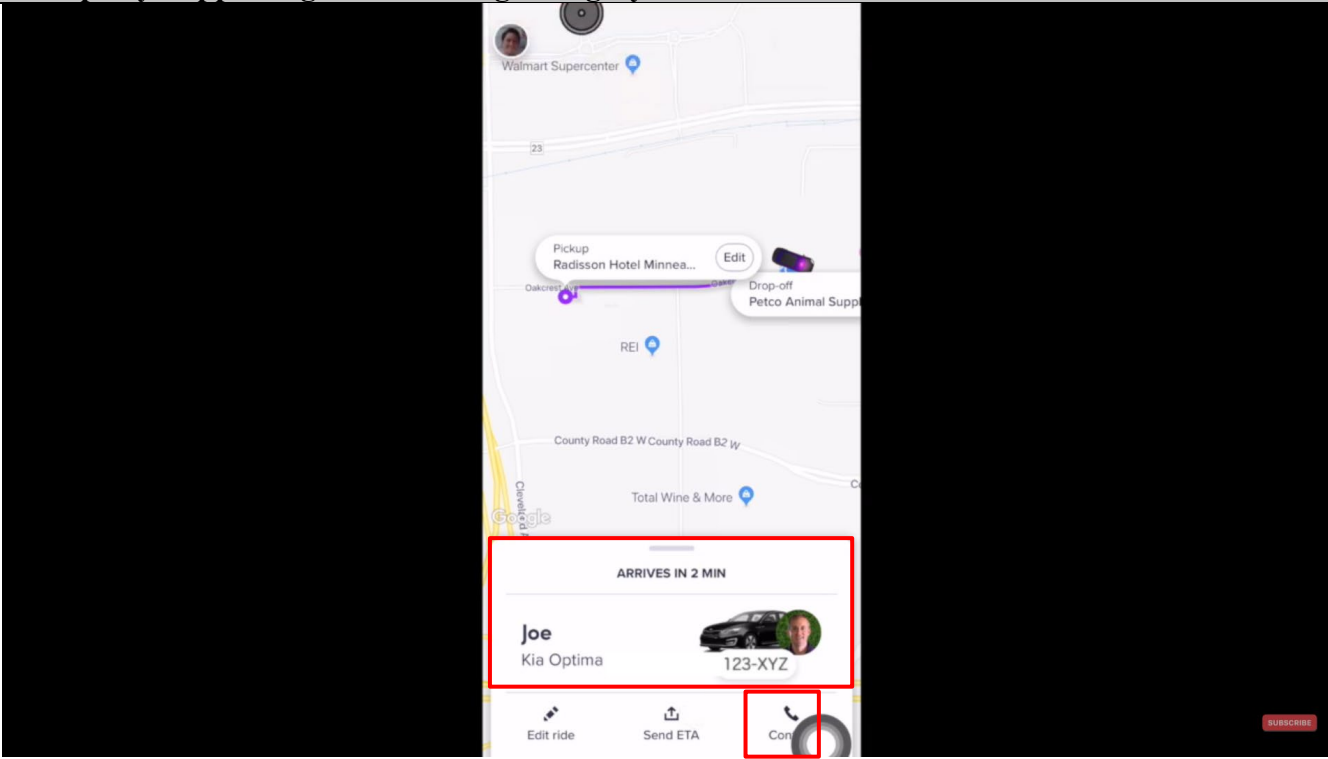
Exhibit B for US Patent No. 7,630,724 Against Lyft Accused Products

Claim – 7,630,724	Exemplary Supporting Evidence Regarding Lyft's Accused Products
	 <p>The screenshot shows the Lyft app interface. At the top, the destination is set to "Petco". A map displays a blue route starting from a pickup location and ending at Petco. The pickup location is labeled "1 min • 0.3 mi Pick up Jenna". A red box highlights this pickup information and a circular icon with a white arrow pointing to the right. Below the screenshot, the URL https://www.youtube.com/watch?v=jVUy9poJDng is provided, along with the timestamp "at 10:46".</p>

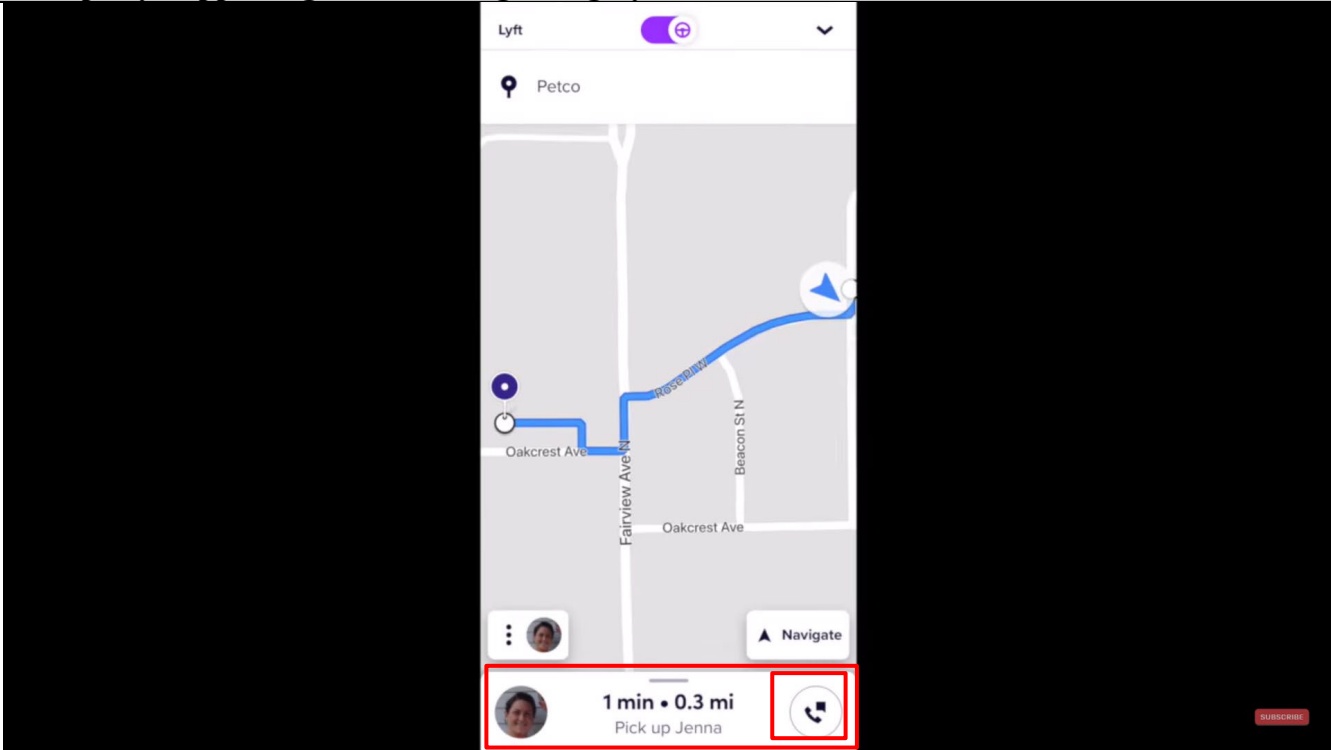
Exhibit B for US Patent No. 7,630,724 Against Lyft Accused Products

Claim – 7,630,724	Exemplary Supporting Evidence Regarding Lyft's Accused Products
	 <p>https://www.youtube.com/watch?v=jVUy9poJDng at 10:46</p>

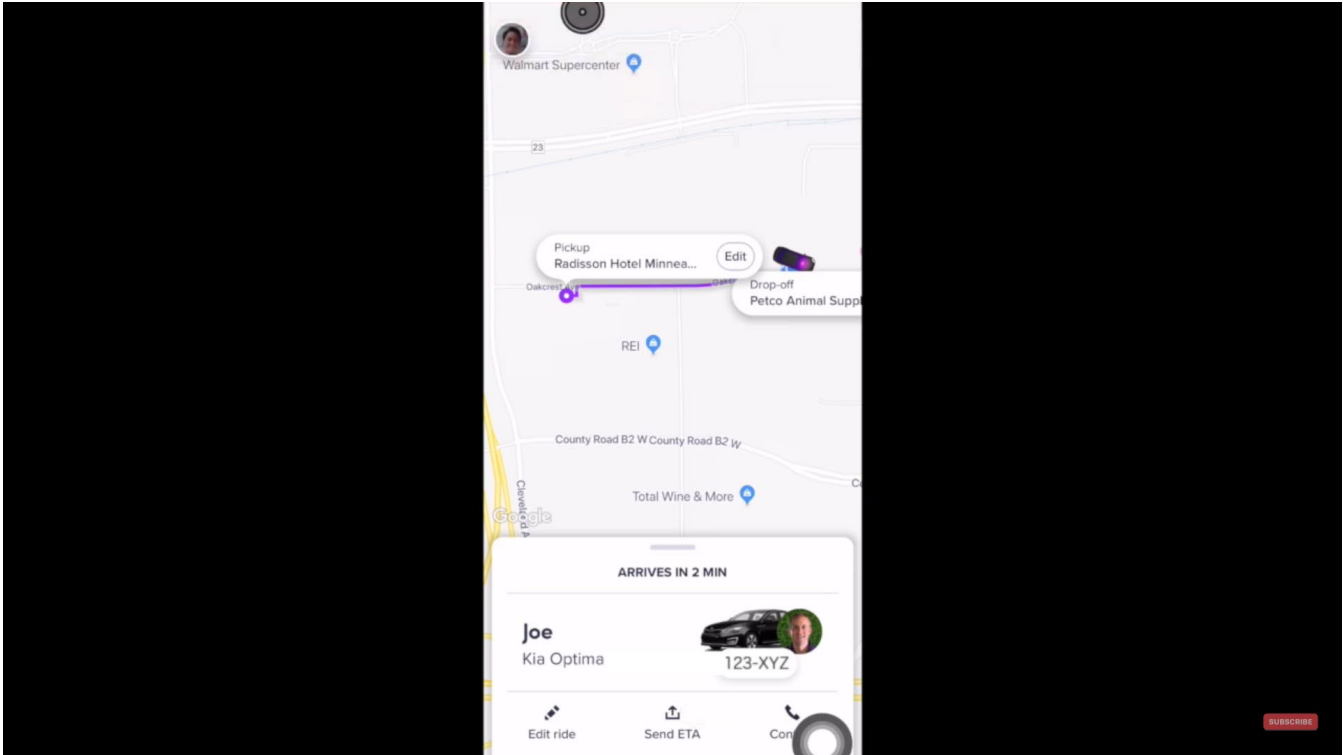
Exhibit B for US Patent No. 7,630,724 Against Lyft Accused Products

Claim – 7,630,724	Exemplary Supporting Evidence Regarding Lyft's Accused Products
	 <p>https://www.youtube.com/watch?v=jVUy9poJDng at 11:21</p>

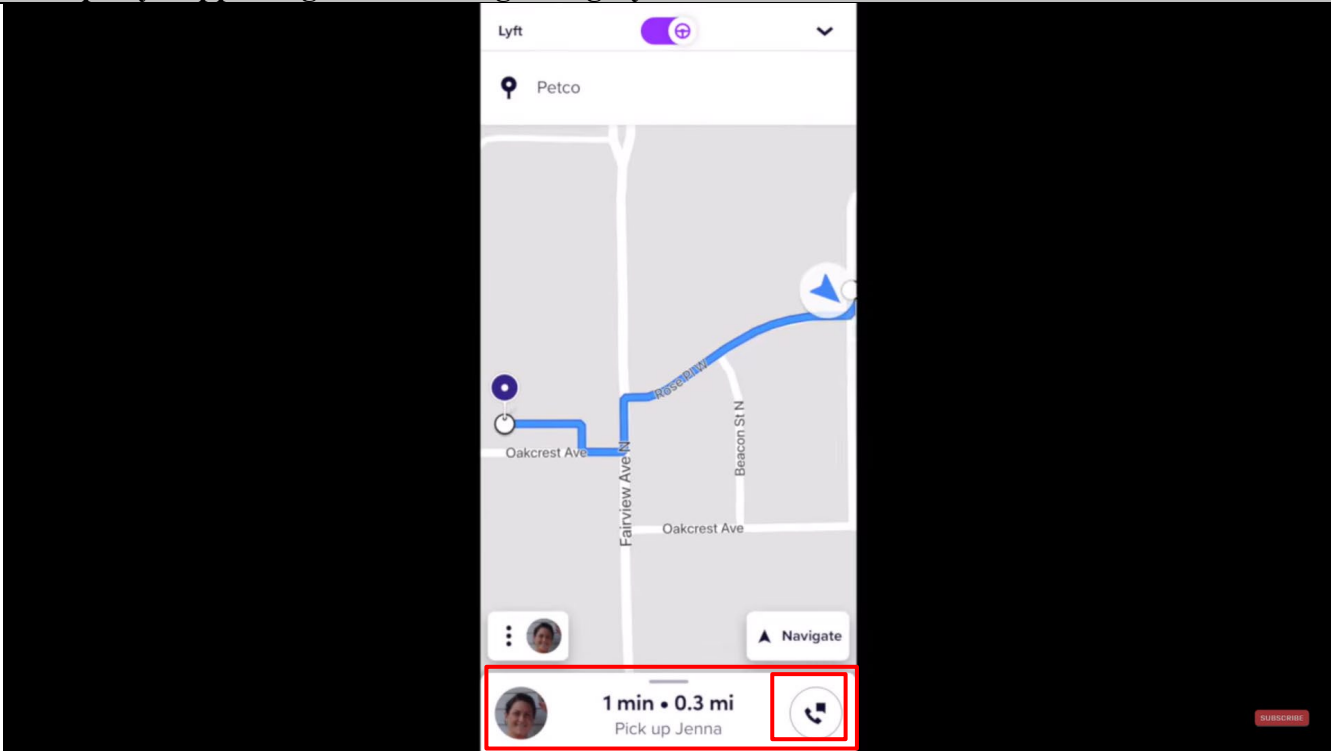
Exhibit B for US Patent No. 7,630,724 Against Lyft Accused Products

Claim – 7,630,724	Exemplary Supporting Evidence Regarding Lyft's Accused Products
	 <p>https://www.youtube.com/watch?v=j0RDMLcmOgU at 5:07</p>

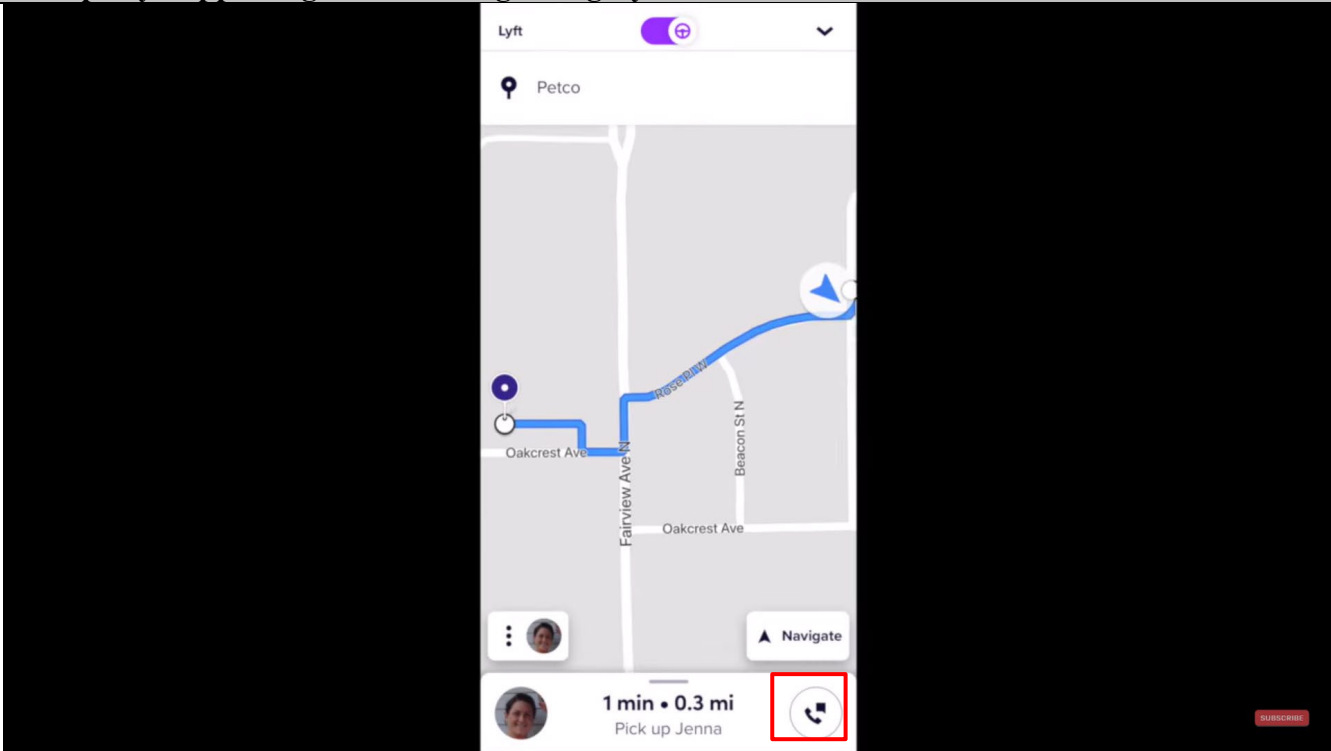
Exhibit B for US Patent No. 7,630,724 Against Lyft Accused Products

Claim – 7,630,724	Exemplary Supporting Evidence Regarding Lyft’s Accused Products
	 <p>https://www.youtube.com/watch?v=j0RDMLcmOgU at 5:32</p> <p>Further, to the extent this element is performed at least in part by Lyft's software source code, AGIS reserves the right to supplement these contentions pursuant to production of such source code by Lyft and to the extent Defendant requires additional information in accordance with P.R. 3-1 and for any other reasons.</p>
<p>9[E]. connecting each of the cell phones to an internet connection;</p>	<p>The Lyft Accused Products infringes directly and/or indirectly by performing, inducing others to perform, and/or contributing to the performance of: connecting each of the cell phones to an internet connection.</p>

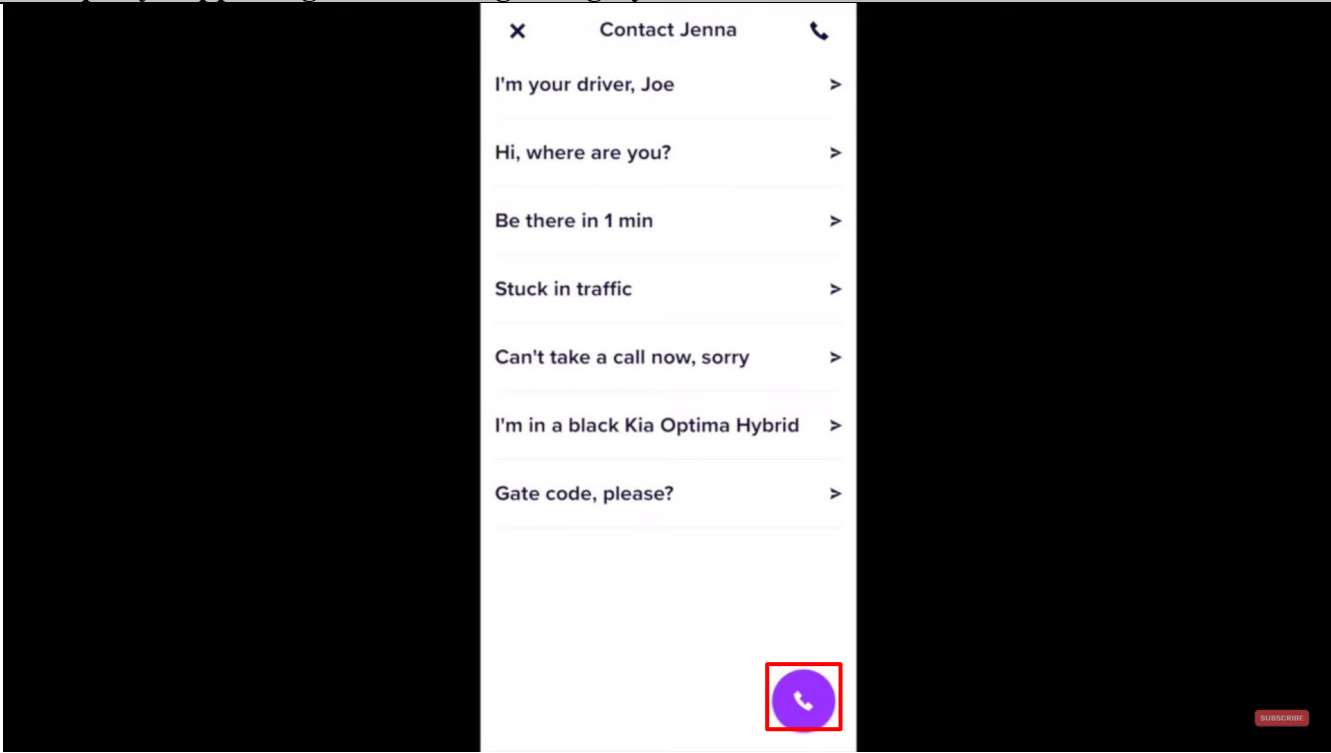
Exhibit B for US Patent No. 7,630,724 Against Lyft Accused Products

Claim – 7,630,724	Exemplary Supporting Evidence Regarding Lyft’s Accused Products
	<p>This element is infringed literally, or in the alternative, under the doctrine of equivalents.</p> <p>For example, when passengers and drivers access the Lyft and Lyft driver apps respectively which are connected to an IP based connection for them to use the Lyft platform (Lyft and Lyft Driver app).</p> <p>Mobile data settings</p> <p>The app must receive data through your mobile network to work. The app will become unresponsive if this setting is turned off. Here are some resources:</p> <p>iOS:</p> <p>Head to Apple Support to learn how to check your cellular data usage.</p> <p>Android:</p> <p>To update the mobile data settings:</p> <ol style="list-style-type: none"> 1. Tap 'Settings' on your phone's menu 2. Tap 'Applications' 3. Select the app on the list 4. Select 'Mobile Data' 5. Tap 'Restrict Background Data' 6. Make sure it isn't toggled to 'Always' <p>https://help.lyft.com/hc/e/articles/115013080508-Phone-software-recommendations-and-settings</p> <p>Further, to the extent this element is performed at least in part by Lyft's software source code, AGIS reserves the right to supplement these contentions pursuant to production of such source code by Lyft and to the extent Defendant requires additional information in accordance with P.R. 3-1 and for any other reasons.</p>

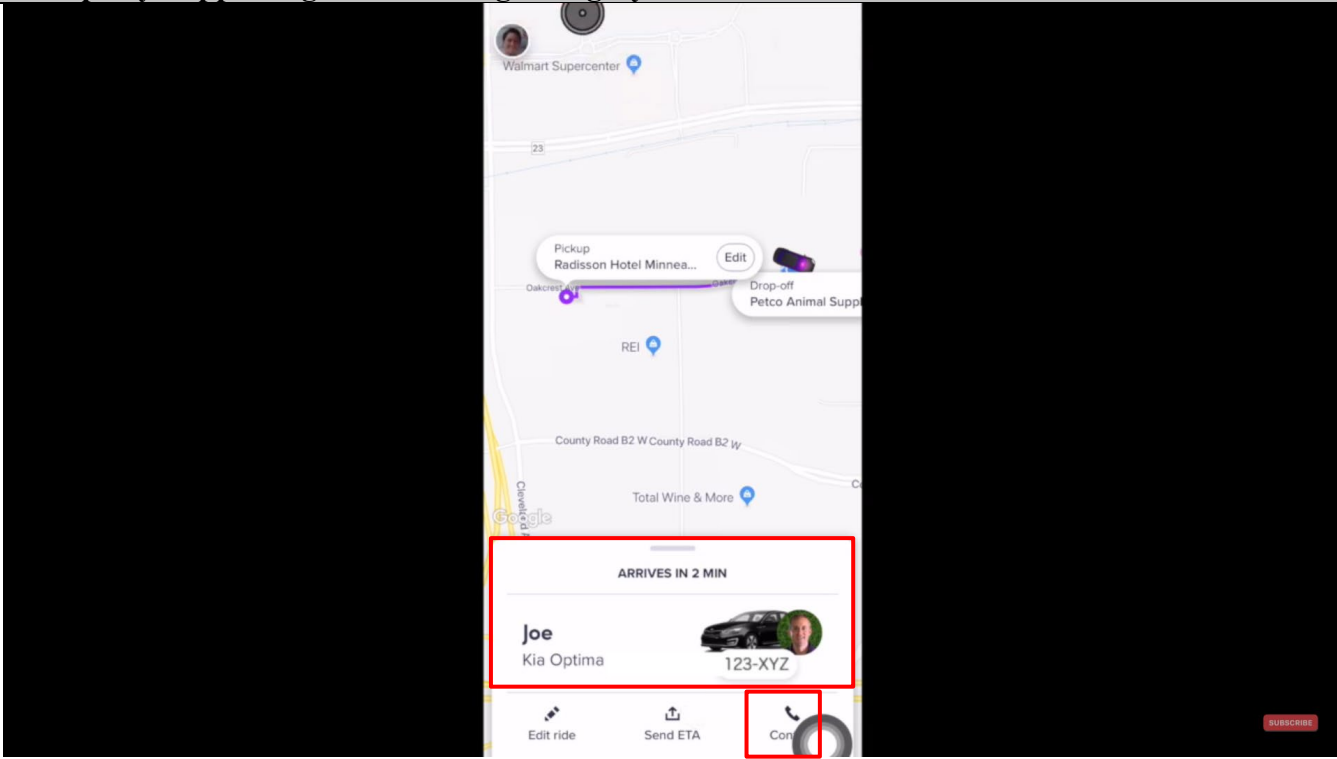
Exhibit B for US Patent No. 7,630,724 Against Lyft Accused Products

Claim – 7,630,724	Exemplary Supporting Evidence Regarding Lyft’s Accused Products
<p>9[F]. exchanging IP addresses using SMS or other digital message format between and among each of the network participant users so that communications between participants is established via IP or transmission of a network participant's IP address to a server which then transmits data to other network participants using the IP address previously.</p>	<p>The Lyft Accused Products infringes directly and/or indirectly by performing, inducing others to perform, and/or contributing to the performance of: exchanging IP addresses using SMS or other digital message format between and among each of the network participant users so that communications between participants is established via IP or transmission of a network participant's IP address to a server which then transmits data to other network participants using the IP address previously.</p> <p>This element is infringed literally, or in the alternative, under the doctrine of equivalents.</p> <p>On information and belief, the Lyft apps meet this limitation because the Lyft apps transmit data (including their IP addresses) to the Lyft server(s) which then communicates data to the other rider/driver. Alternatively, on information and belief, the Lyft apps communicate IP addresses via the Lyft server(s) while communicating data between riders/drivers.</p>

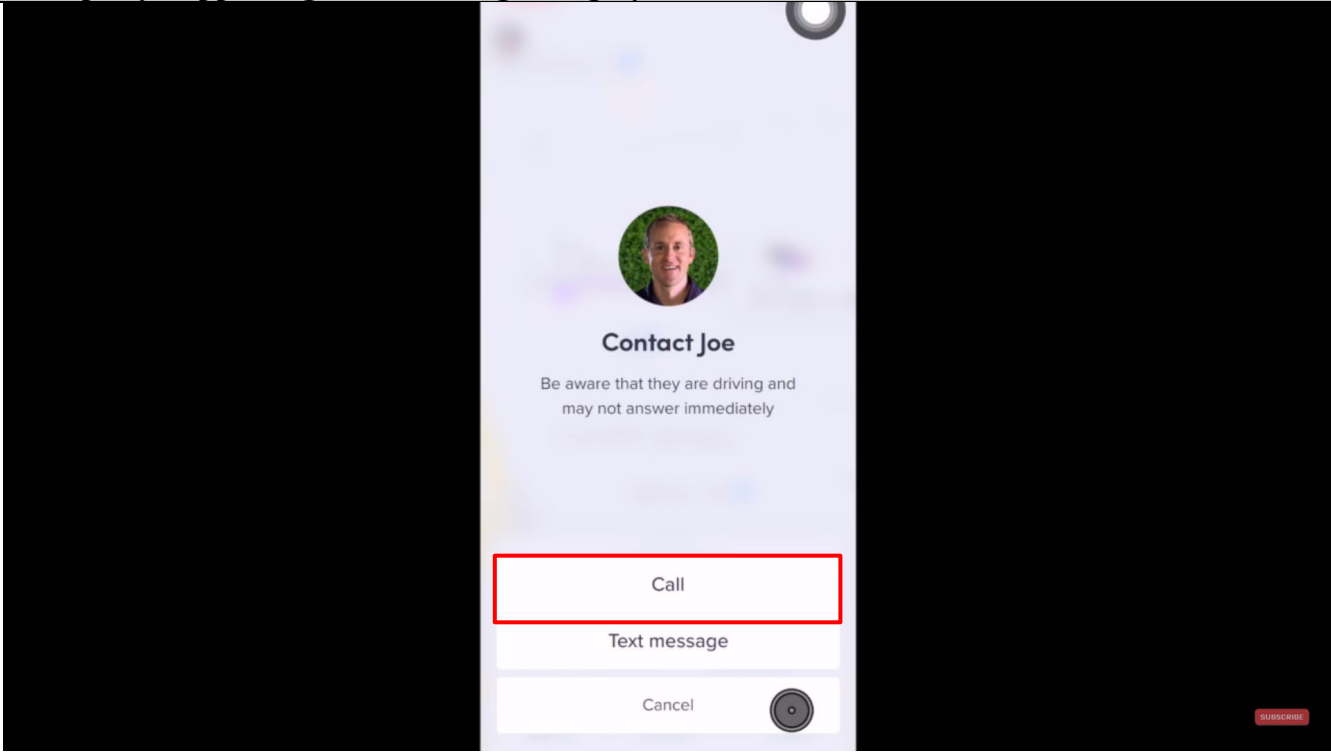
Exhibit B for US Patent No. 7,630,724 Against Lyft Accused Products

Claim – 7,630,724	Exemplary Supporting Evidence Regarding Lyft's Accused Products
	 <p>The screenshot shows the Lyft app interface. At the top, the destination is set to 'Petco'. A map displays a route starting from a pickup location (marked with a blue dot) and ending at Petco. The route is highlighted in blue. Below the map, there is a 'Navigate' button. At the bottom of the screen, a pickup card is visible, showing a driver's profile picture, the text '1 min • 0.3 mi', and 'Pick up Jenna'. A red box highlights the 'Pick up Jenna' button and the driver's profile picture. A 'SUBSCRIBE' button is visible in the bottom right corner of the video frame.</p> <p>https://www.youtube.com/watch?v=jVUy9poJDng at 10:46</p>

Exhibit B for US Patent No. 7,630,724 Against Lyft Accused Products

Claim – 7,630,724	Exemplary Supporting Evidence Regarding Lyft's Accused Products
	 <p>https://www.youtube.com/watch?v=jVUy9poJDng at 11:21</p>

Exhibit B for US Patent No. 7,630,724 Against Lyft Accused Products

Claim – 7,630,724	Exemplary Supporting Evidence Regarding Lyft's Accused Products
	 <p>https://www.youtube.com/watch?v=j0RDMLcmOgU at 5:07</p>

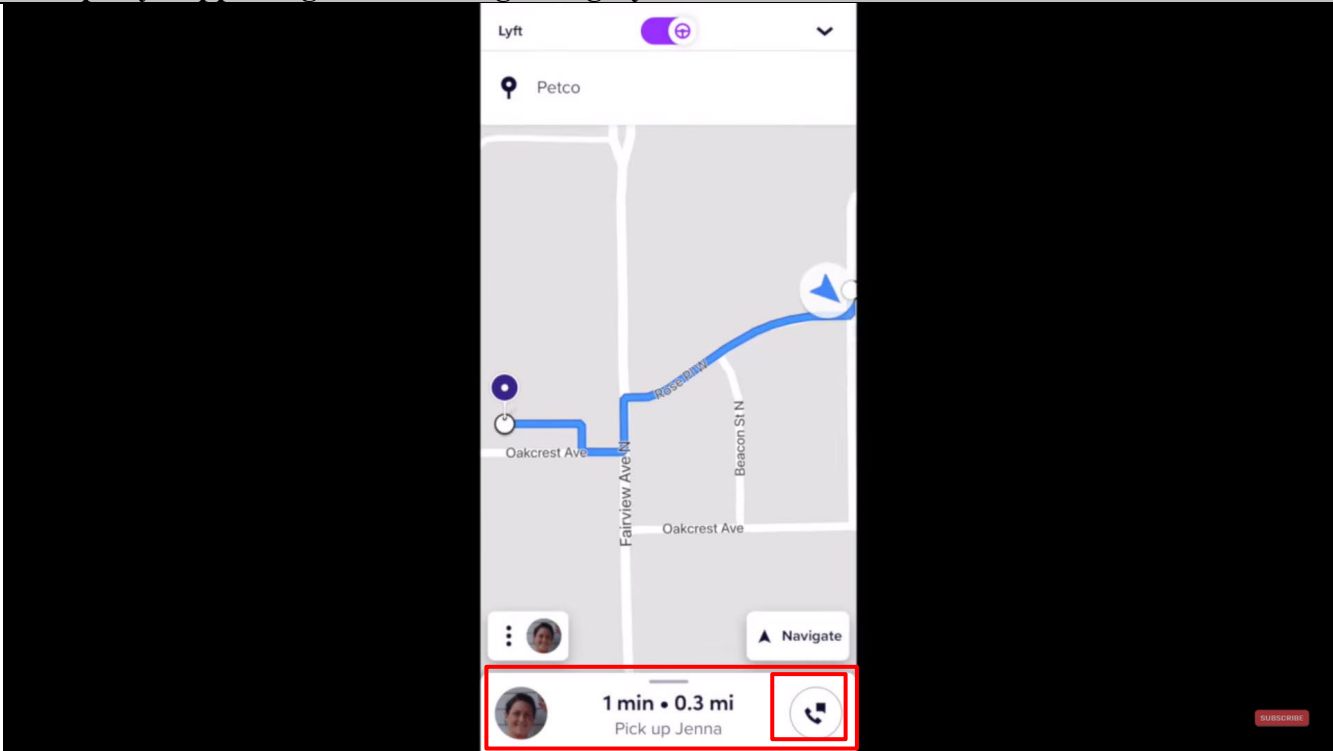
Exhibit B for US Patent No. 7,630,724 Against Lyft Accused Products

Claim – 7,630,724	Exemplary Supporting Evidence Regarding Lyft's Accused Products
	 <p>https://www.youtube.com/watch?v=j0RDMLcmOgU at 5:32</p> <h3>Network addressing</h3> <p>When a 'message' such as a file, image or video is transmitted across a network, it is first broken down into small blocks called <i>segments</i>. These are placed into containers called <i>packets</i>, typically by the Internet Protocol (IP). There are two versions of IP: version 4 and version 6.</p> <p>IP is responsible for delivering the packets from source to destination, and regardless of the version being used, packets must use some form of addressing to uniquely identify the message source and message destination.</p> <p>https://www.open.edu/openlearncreate/mod/oucontent/view.php?id=129584&printable=1</p>

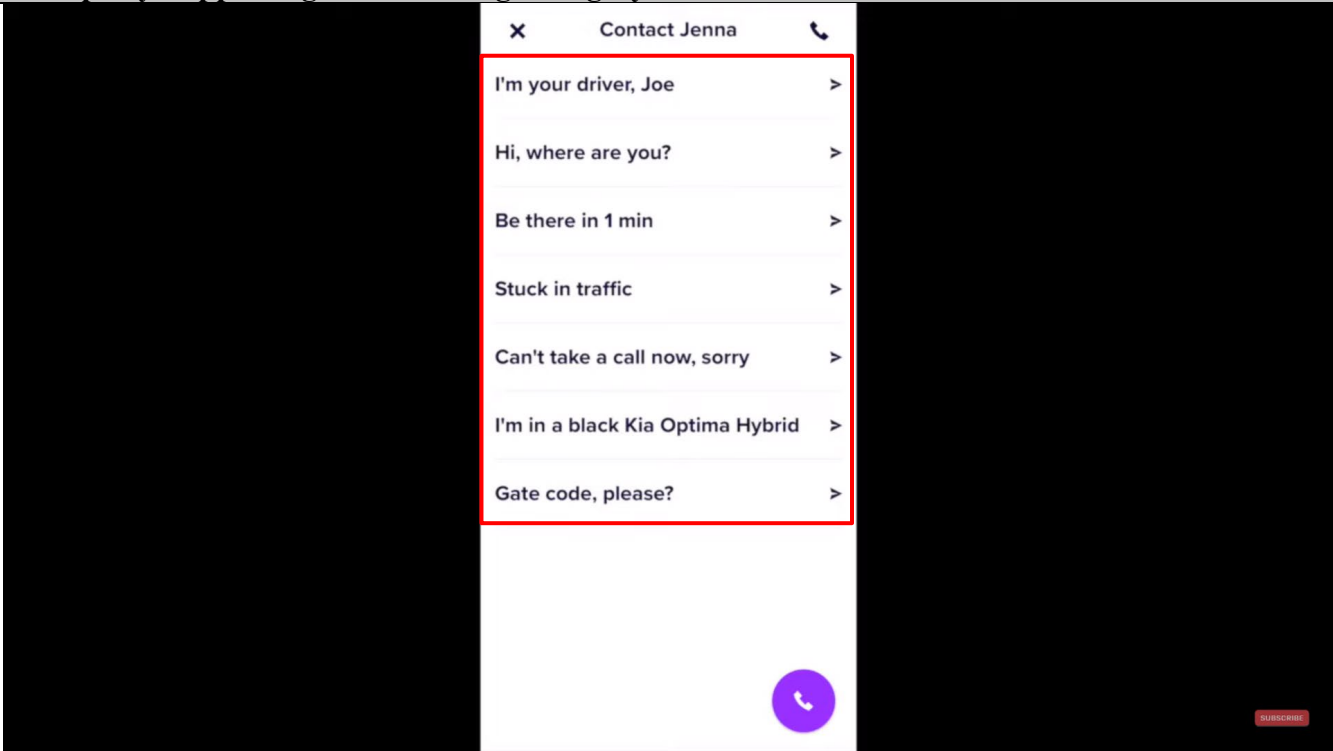
Exhibit B for US Patent No. 7,630,724 Against Lyft Accused Products

Claim – 7,630,724	Exemplary Supporting Evidence Regarding Lyft’s Accused Products
	<p>Further, to the extent this element is performed at least in part by Lyft's software source code, AGIS reserves the right to supplement these contentions pursuant to production of such source code by Lyft and to the extent Defendant requires additional information in accordance with P.R. 3-1 and for any other reasons.</p>
<p>12. A method for providing a cellular phone communication network as in claim 9 including the additional steps of: adding a new cell phone participant into a communication network of participating users by having the new cell phone participant transmit an identifier, a cell phone number and an IP address in an initial message to other participant users or to a server for retransmission of the data other network participants.</p>	<p>The Lyft Accused Products infringes directly and/or indirectly by performing, inducing others to perform, and/or contributing to the performance of: adding a new cell phone participant into a communication network of participating users by having the new cell phone participant transmit an identifier, a cell phone number and an IP address in an initial message to other participant users or to a server for retransmission of the data other network participants.</p> <p>This element is infringed literally, or in the alternative, under the doctrine of equivalents. Lyft meets this limitation because riders/drivers add their account/identity information which includes their cell phone number. Additionally, when using the Lyft app, IP based communication to the Lyft server(s) includes IP addresses.</p> <p>For example, Lyft’s servers provide shared rides where multiple passengers can share a ride using the Lyft app. Through this app, Lyft’s servers add new passengers into the network in which a driver and a passenger may already be present. This new passenger has a cell phone number and IP address associated with their account which is used to match the new passenger with the already existing driver and passenger.</p> <p>Sharing your ride</p> <p>Our goal for Shared rides is to fill the empty seats in cars with riders going in the same direction. Chaining brings us one step closer to achieving that goal by pairing multiple parties together in one ride.</p> <p>It's important that you only request Shared rides for one or two riders and accurately choose the number of people in the app. If you don't follow this rule, the driver will be prompted to cancel your ride upon arrival.</p> <p>https://help.lyft.com/hc/e/articles/115013078848-About-Shared-rides</p>

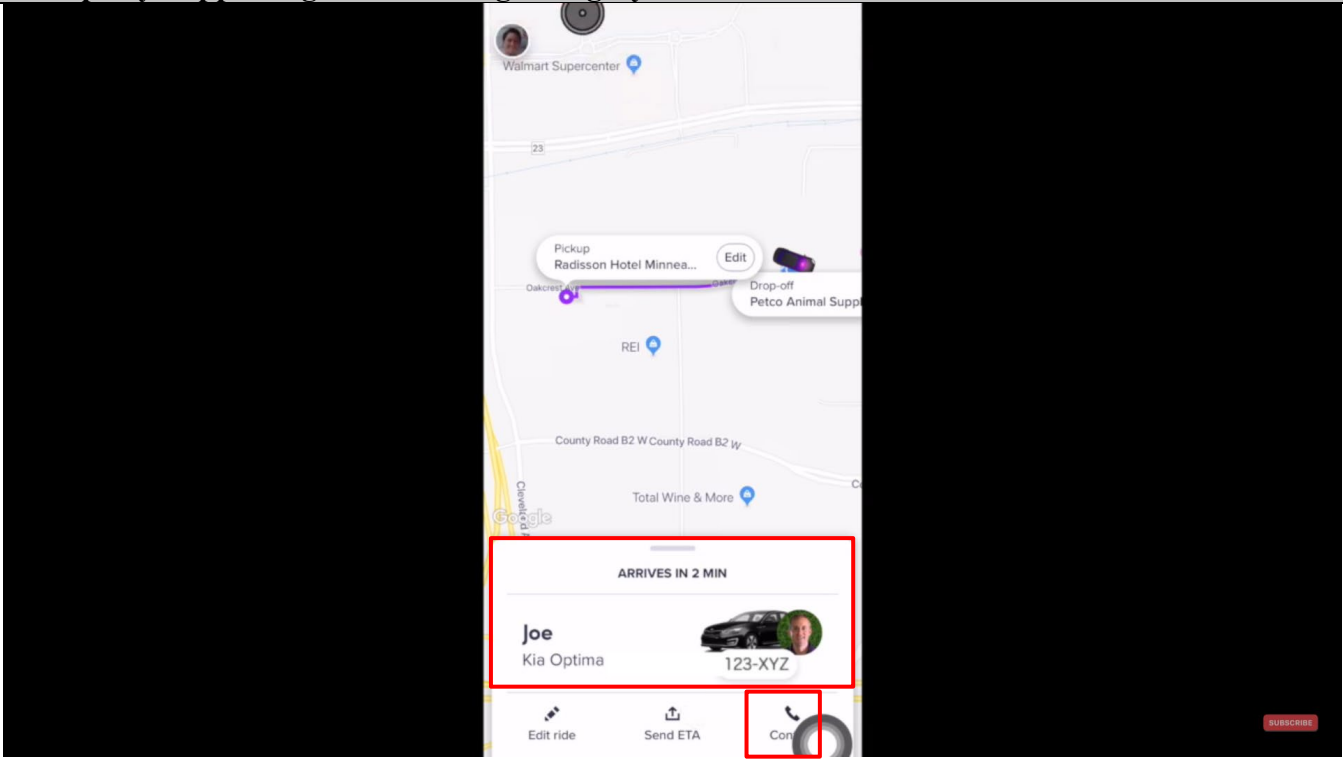
Exhibit B for US Patent No. 7,630,724 Against Lyft Accused Products

Claim – 7,630,724	Exemplary Supporting Evidence Regarding Lyft’s Accused Products
<p>13. A method for providing a cellular phone communication network as in claim 9 including the additional steps of: sending each participating user directly or to a server for retransmission the geographic location of the sender of a message.</p>	<p>The Lyft Accused Products infringes directly and/or indirectly by performing, inducing others to perform, and/or contributing to the performance of: sending each participating user directly or to a server for retransmission the geographic location of the sender of a message.</p> <p>This element is infringed literally, or in the alternative, under the doctrine of equivalents.</p> <p>Lyft meets this limitation because riders/drivers add their account/identity information which includes their cell phone number. Additionally, when using the Lyft app, IP based communication to the Lyft server(s) includes IP addresses. For example, upon information and belief, Lyft’s servers continuously fetch the location information of all the passengers and the driver present in a ride. Therefore, even when a passenger sends a message to the driver, the geographic location is retransmitted from their phone.</p> <p>Further, to the extent this element is performed at least in part by Lyft's software source code, AGIS reserves the right to supplement these contentions pursuant to production of such source code by Lyft and to the extent Defendant requires additional information in accordance with P.R. 3-1 and for any other reasons.</p>
<p>14. A method for providing a cellular phone communication network as in claim 9 including the additional steps of: automatically calling the nearest fixed location from a particular group including: police stations, fire stations, or EMTs or other fixed locations by one or more of the cellular phone network participants.</p>	<p>The Lyft Accused Products infringes directly and/or indirectly by performing, inducing others to perform, and/or contributing to the performance of: automatically calling the nearest fixed location from a particular group including: police stations, fire stations, or EMTs or other fixed locations by one or more of the cellular phone network participants.</p> <p>This element is infringed literally, or in the alternative, under the doctrine of equivalents.</p> <p>For example, Lyft provides an emergency button to its passengers which allows Lyft to automatically place a 911 call to the nearest fixed location such as a police station.</p>

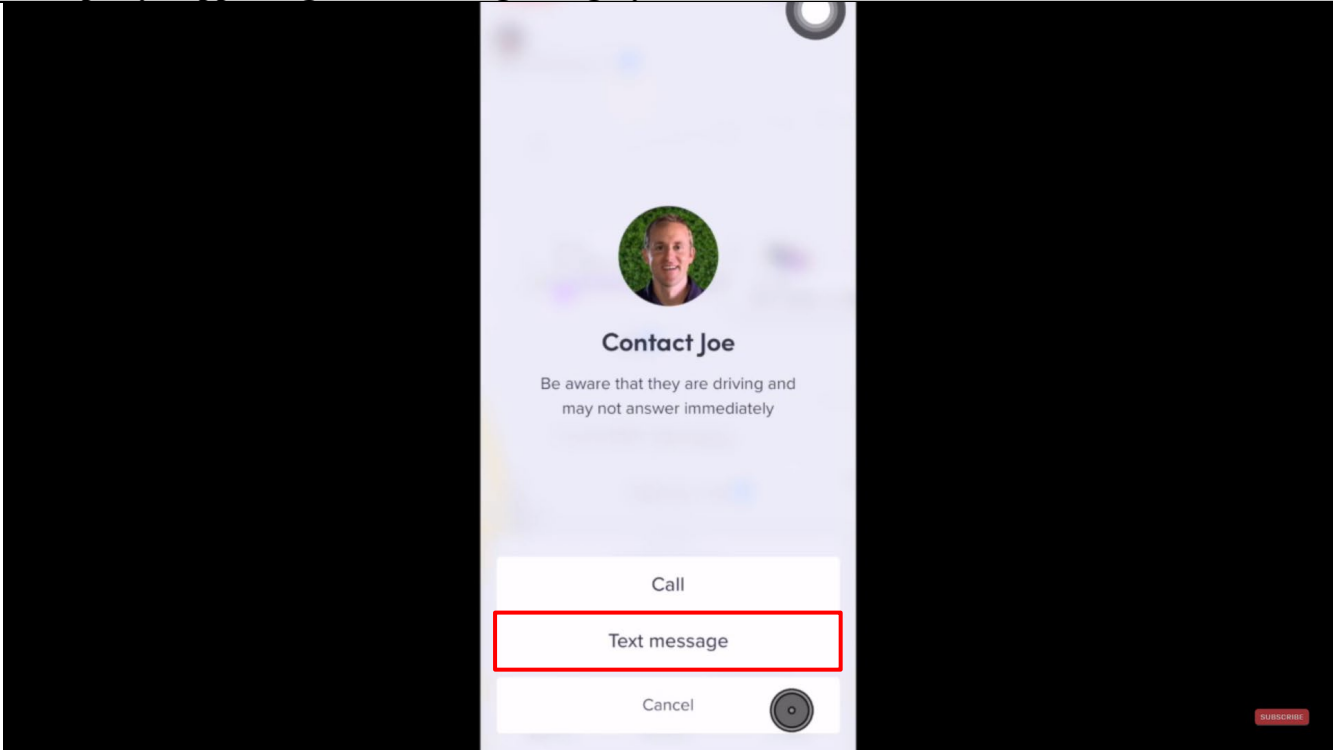
Exhibit B for US Patent No. 7,630,724 Against Lyft Accused Products

Claim – 7,630,724	Exemplary Supporting Evidence Regarding Lyft’s Accused Products
	 <p data-bbox="1373 505 1885 548">911 is just a few taps away</p> <p data-bbox="1373 586 1885 769">To give you immediate access to emergency help in case you ever need it (and to help you ride a little easier even when you don't), we built a 911 button into your app. It's there for both riders and drivers, and when you tap it, the app will display your current location and vehicle info so you can quickly share details with emergency dispatchers.</p> <p data-bbox="569 967 930 995">https://www.lyft.com/safety</p> <p data-bbox="569 1040 1896 1175">Further, to the extent this element is performed at least in part by Lyft’s software source code, AGIS reserves the right to supplement these contentions pursuant to production of such source code by Lyft and to the extent Defendant requires additional information in accordance with P.R. 3-1 and for any other reasons.</p>
<p data-bbox="201 1187 546 1359">15. A method for providing a cellular phone communication network as in claim 9 including the additional steps of:</p>	<p data-bbox="569 1187 1896 1359">The Lyft Accused Products infringes directly and/or indirectly by performing, inducing others to perform, and/or contributing to the performance of: entering on a user's touch display screen a new track by touching the display screen at the correct map location and selecting the type of symbol to be displayed, causing that symbol identifier to be transmitted to the other network participants either directly or through a server and as the track's location moves, sending new location data to the other participants</p>

Exhibit B for US Patent No. 7,630,724 Against Lyft Accused Products

Claim – 7,630,724	Exemplary Supporting Evidence Regarding Lyft’s Accused Products
<p>entering on a user's touch display screen a new track by touching the display screen at the correct map location and selecting the type of symbol to be displayed, causing that symbol identifier to be transmitted to the other network participants either directly or through a server and as the track's location moves, sending new location data to the other participants relative to the new track so that each of the participating user's display is updated with the new track's position.</p>	<p>relative to the new track so that each of the participating user's display is updated with the new track's position.</p> <p>This element is infringed literally, or in the alternative, under the doctrine of equivalents.</p> <p>For example, upon information and belief, Lyft allows passengers to change the destination address while executing a ride. As a result, the new location is transmitted to the co-passengers and the driver on their mobile devices. Further, a new symbol is displayed for the new location selected by the passenger.</p>
<p>entering on a user's touch display screen a new track by touching the display screen at the correct map location and selecting the type of symbol to be displayed, causing that symbol identifier to be transmitted to the other network participants either directly or through a server and as the track's location moves, sending new location data to the other participants relative to the new track so that each of the participating user's display is updated with the new track's position.</p>	<div style="text-align: center;">  </div> <p>https://www.youtube.com/watch?v=j0RDMLcmOgU at 5:07, Annotated</p>

Exhibit B for US Patent No. 7,630,724 Against Lyft Accused Products

Claim – 7,630,724	Exemplary Supporting Evidence Regarding Lyft’s Accused Products
	<p>Further, to the extent this element is performed at least in part by Lyft's software source code, AGIS reserves the right to supplement these contentions pursuant to production of such source code by Lyft and to the extent Defendant requires additional information in accordance with P.R. 3-1 and for any other reasons.</p>
<p>16[P]. A method of providing a cellular phone communication network for designated participating users, each having a similarly equipped PDA cellular phone that includes a CPU, a GPS navigational system and a touch screen display comprising:</p>	<p><i>See claim 9A above</i></p>
<p>16[A]. selecting an icon that establishes rapid voice call initiation and communication to the users of the cellular telephone PDA/GPS network system by touching their symbol on the phone's a touch screen;</p>	<p>The Lyft Accused Product(s) performs a computer implemented method as set forth below. Lyft further infringes directly and/or indirectly by performing, inducing others to perform, and/or contributing to the performance of: selecting an icon that establishes rapid voice call initiation and communication to the users of the cellular telephone PDA/GPS network system by touching their symbol on the phone's a touch screen.</p> <p>This element is infringed literally, or in the alternative, under the doctrine of equivalents.</p> <p>Lyft meets this limitation because riders/drivers are provided with the functionality of selectable interface elements for calling the drivers/riders. For example, when the driver is matched to the passenger, both the driver and the passenger get the call icon (“rapid voice initiation and communication”) on their respective mobile phones display in the Lyft driver and Lyft app respectively through which both of them call each other by tapping the call icon on their respective touch screen display.</p>

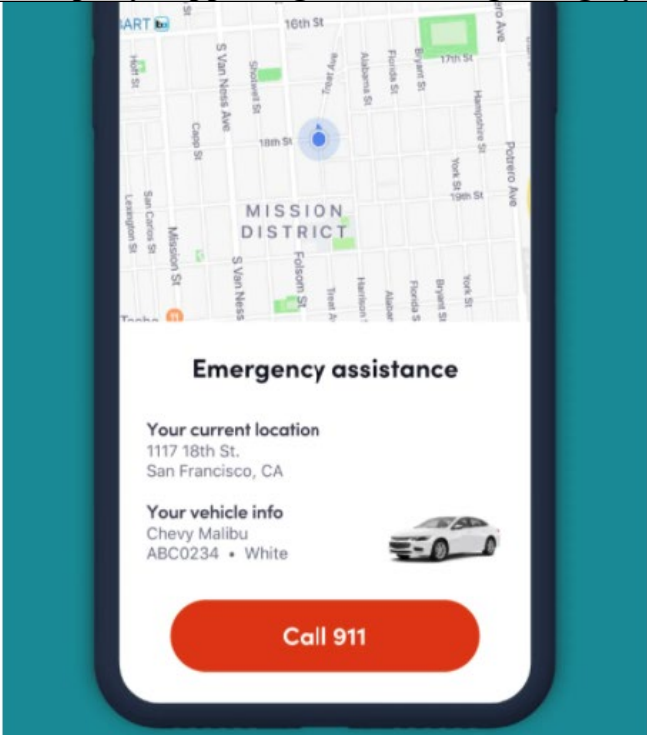
Exhibit B for US Patent No. 7,630,724 Against Lyft Accused Products

Claim – 7,630,724	Exemplary Supporting Evidence Regarding Lyft's Accused Products
	 <p>https://www.youtube.com/watch?v=j0RDMLcmOgU at 5:07</p>

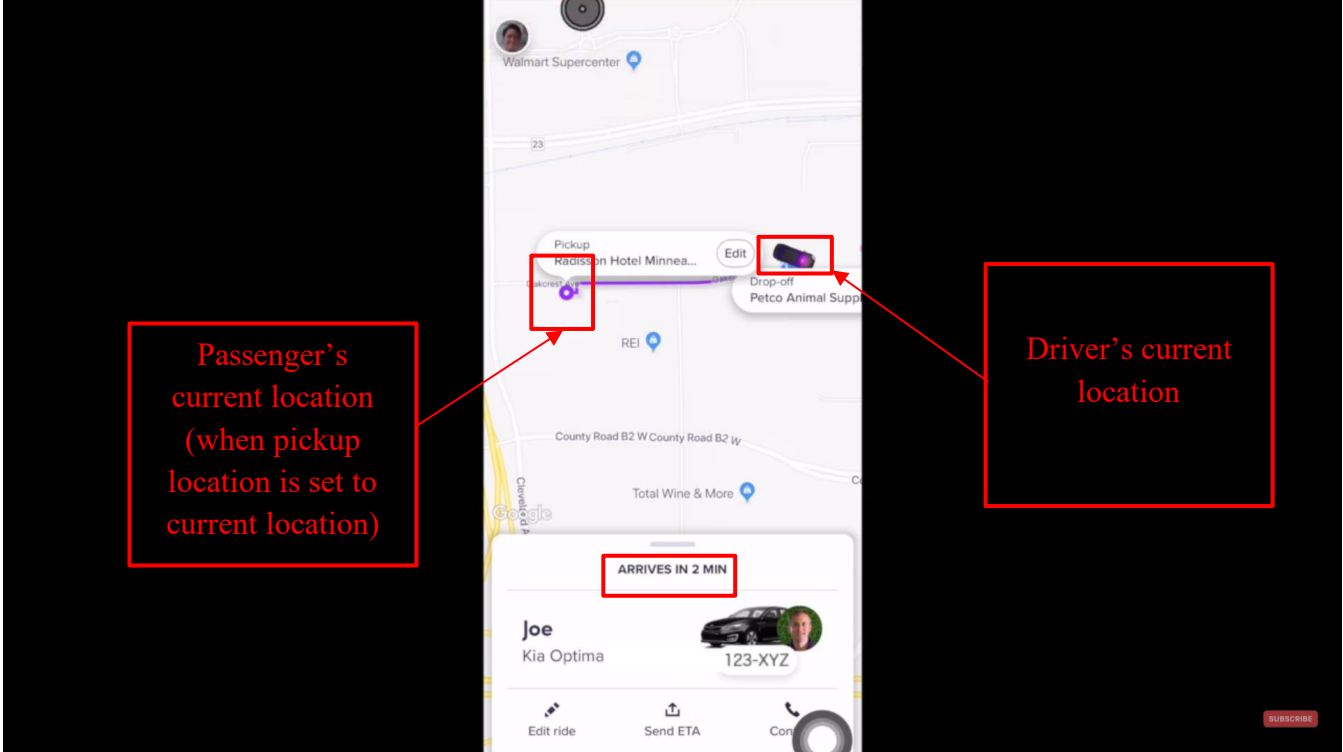
Exhibit B for US Patent No. 7,630,724 Against Lyft Accused Products

Claim – 7,630,724	Exemplary Supporting Evidence Regarding Lyft’s Accused Products
	 <p>https://www.youtube.com/watch?v=jVUy9poJDng at 10:46</p> <p>Further, to the extent this element is performed at least in part by Lyft's software source code, AGIS reserves the right to supplement these contentions pursuant to production of such source code by Lyft and to the extent Defendant requires additional information in accordance with P.R. 3-1 and for any other reasons.</p>
<p>16[B]. transmitting high speed internet rapid transmission of operator selected text messages, photographs, voice recordings and video to</p>	<p>The Lyft Accused Product(s) performs a computer implemented method as set forth below. Lyft further infringes directly and/or indirectly by performing, inducing others to perform, and/or contributing to the performance of: transmitting high speed internet rapid transmission of operator selected text messages, photographs, voice recordings and video to other cellular phone users using the touch screen.</p> <p>This element is infringed literally, or in the alternative, under the doctrine of equivalents.</p>

Exhibit B for US Patent No. 7,630,724 Against Lyft Accused Products

Claim – 7,630,724	Exemplary Supporting Evidence Regarding Lyft’s Accused Products
<p>other cellular phone users using the touch screen;</p>	<p>Lyft meets this limitation because the riders/drivers, via the Lyft apps, are provided with the functionality of communicating messages to drivers/riders using selectable interface elements on the display. On information and belief, the messages include text, voice, and/or video. On information and belief, the messages can be transmitted over IP based communications.</p> <p>For example, when the driver is matched to the passenger, both the driver and the passenger get the call icon on their respective mobile phones display in the Lyft driver and Lyft app respectively through which both of them call each other by tapping the call icon on their respective touch screen display.</p> <div style="text-align: center;">  <p>The screenshot shows the Lyft app interface. At the top, it says 'Lyft' with a toggle switch and a dropdown arrow. Below that is a location pin icon and the name 'Petco'. The main area is a map showing a blue route starting from a white circle and ending at a blue circle. The route goes through Oakcrest Ave, Fairview Ave N, and Beacon St N. At the bottom, there is a 'Navigate' button with an upward arrow. Below the map, there is a profile picture of a woman, the text '1 min • 0.3 mi', and 'Pick up Jenna'. A red box highlights a call icon (a telephone handset inside a circle) on the right side of the bottom bar. There is also a 'SUBSCRIBE' button in the bottom right corner.</p> </div> <p>https://www.youtube.com/watch?v=jVUy9poJDng at 10:46</p>

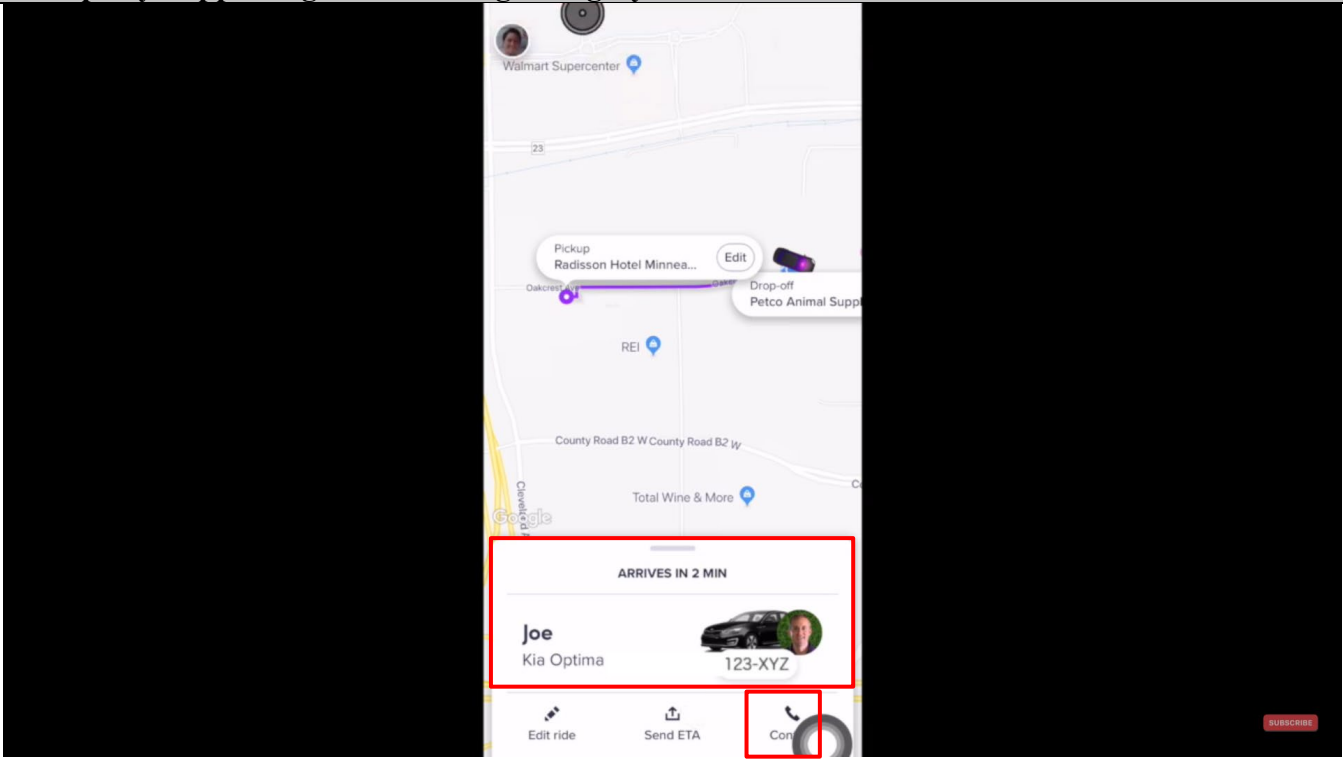
Exhibit B for US Patent No. 7,630,724 Against Lyft Accused Products

Claim – 7,630,724	Exemplary Supporting Evidence Regarding Lyft's Accused Products
	 <p>https://www.youtube.com/watch?v=jVUy9poJDng at 11:21</p>

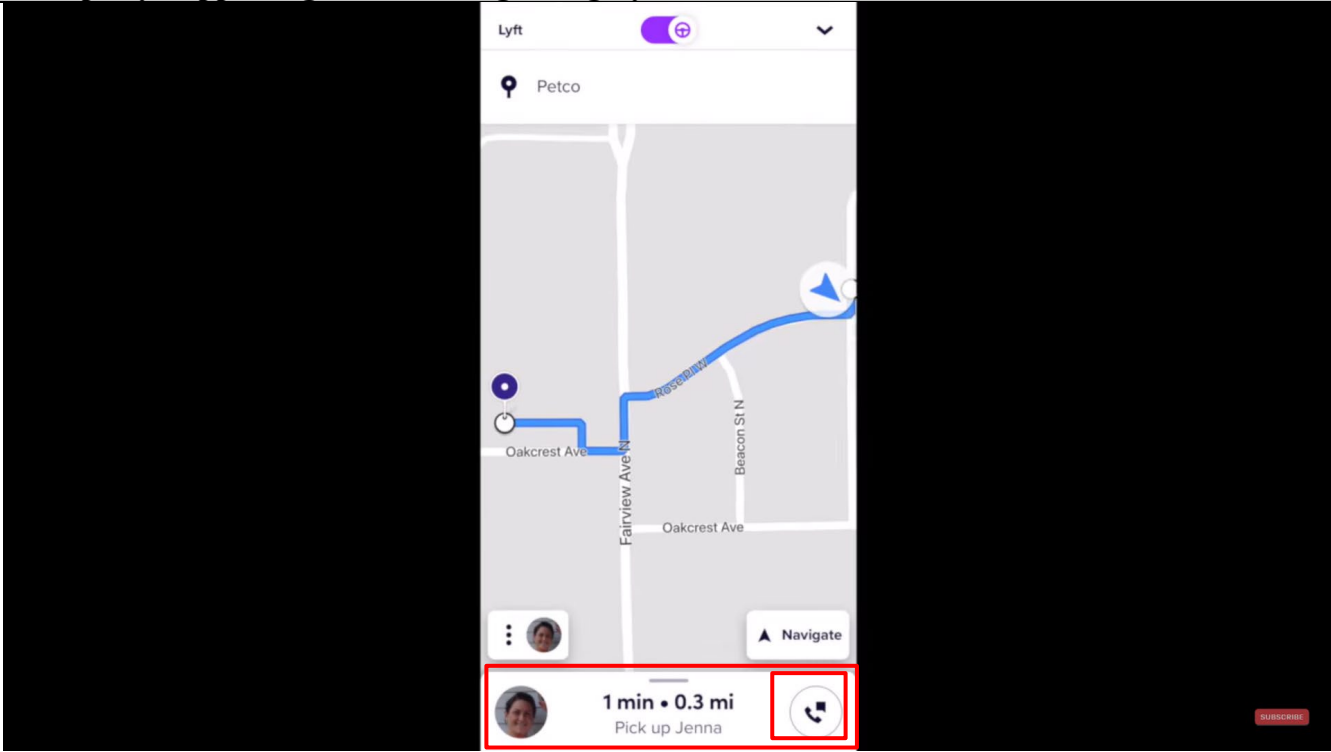
Exhibit B for US Patent No. 7,630,724 Against Lyft Accused Products

Claim – 7,630,724	Exemplary Supporting Evidence Regarding Lyft's Accused Products
	 <p>https://www.youtube.com/watch?v=j0RDMLcmOgU at 5:07</p>

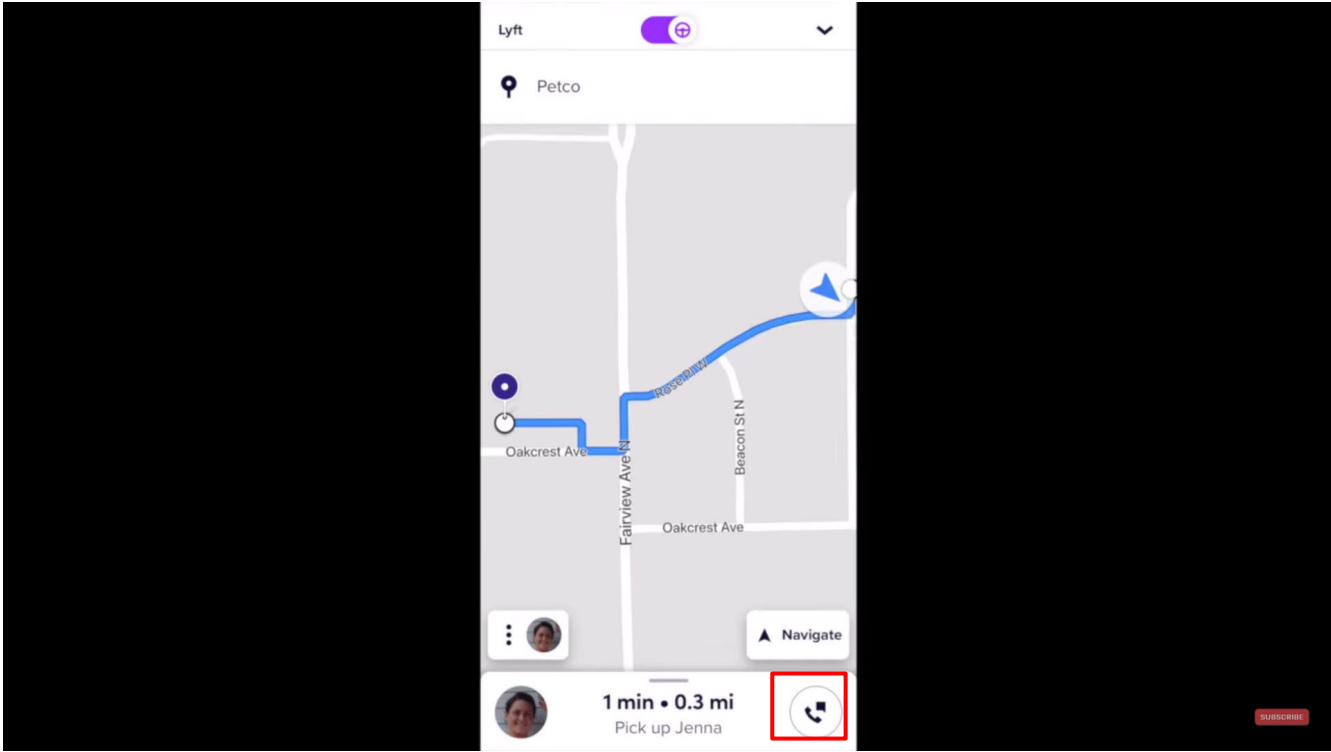
Exhibit B for US Patent No. 7,630,724 Against Lyft Accused Products

Claim – 7,630,724	Exemplary Supporting Evidence Regarding Lyft’s Accused Products
	 <p>https://www.youtube.com/watch?v=j0RDMLcmOgU at 5:32</p> <p>Further, to the extent this element is performed at least in part by Lyft's software source code, AGIS reserves the right to supplement these contentions pursuant to production of such source code by Lyft and to the extent Defendant requires additional information in accordance with P.R. 3-1 and for any other reasons.</p>
<p>16[C]. accessing a server for establishing high speed internet communications between said cellular phone network users and said server; and</p>	<p>The Lyft Accused Product(s) performs a computer implemented method as set forth below. Lyft further infringes directly and/or indirectly by performing, inducing others to perform, and/or contributing to the performance of: accessing a server for establishing high speed internet communications between said cellular phone network users and said server.</p> <p>This element is infringed literally, or in the alternative, under the doctrine of equivalents.</p>

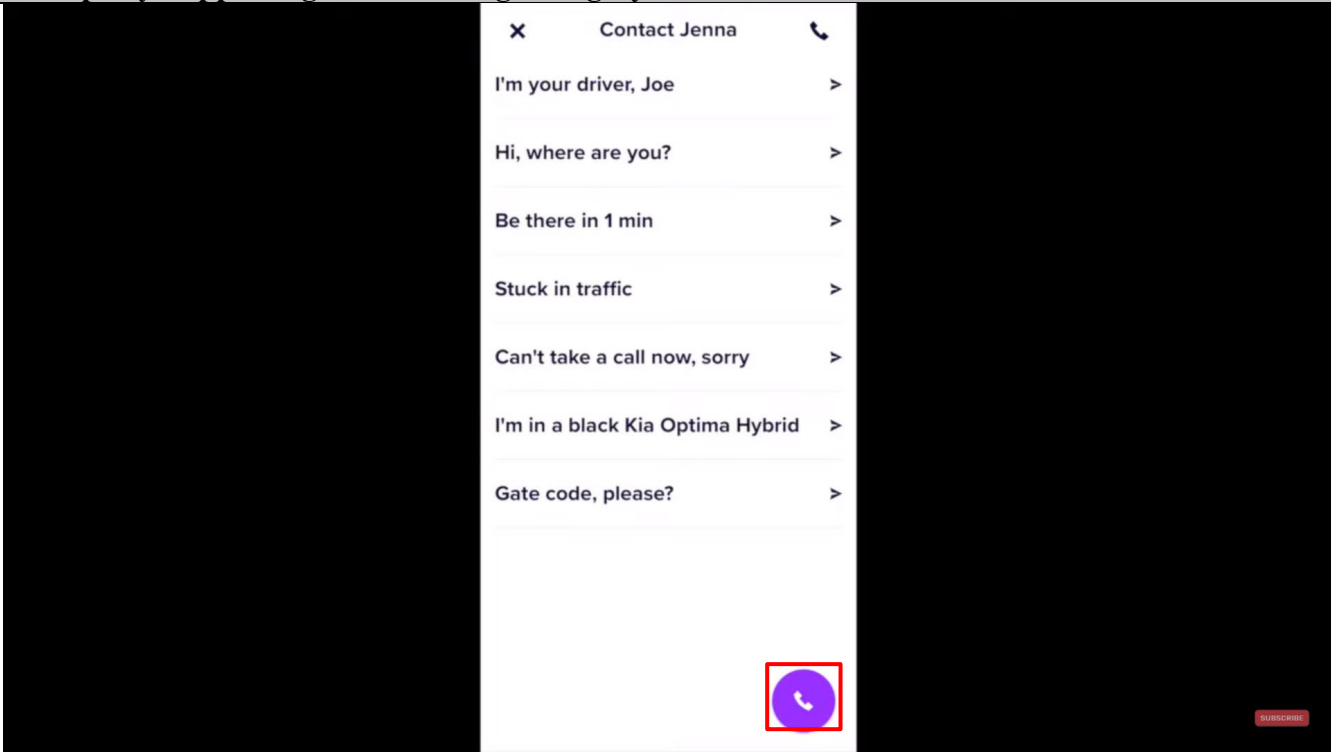
Exhibit B for US Patent No. 7,630,724 Against Lyft Accused Products

Claim – 7,630,724	Exemplary Supporting Evidence Regarding Lyft's Accused Products
	<p>Lyft meets this limitations because the riders/drivers, via the Lyft apps, use IP based communications to/from Lyft server(s). For example, when the passenger requests a ride from the Lyft app installed on their mobile phone, the ride request message is broadcasted to the nearby drivers who are online on the Lyft driver app.</p> <p>For example, when the driver accepts the ride request of the passenger, the passenger's mobile phone receives the driver's information such as name, location, and driver's photo. After the passenger and the driver match, both of them get the option ("icon") to text and call ("low speed communication") each other.</p>  <p>https://www.youtube.com/watch?v=jVUy9poJDng at 10:24, Annotated</p>

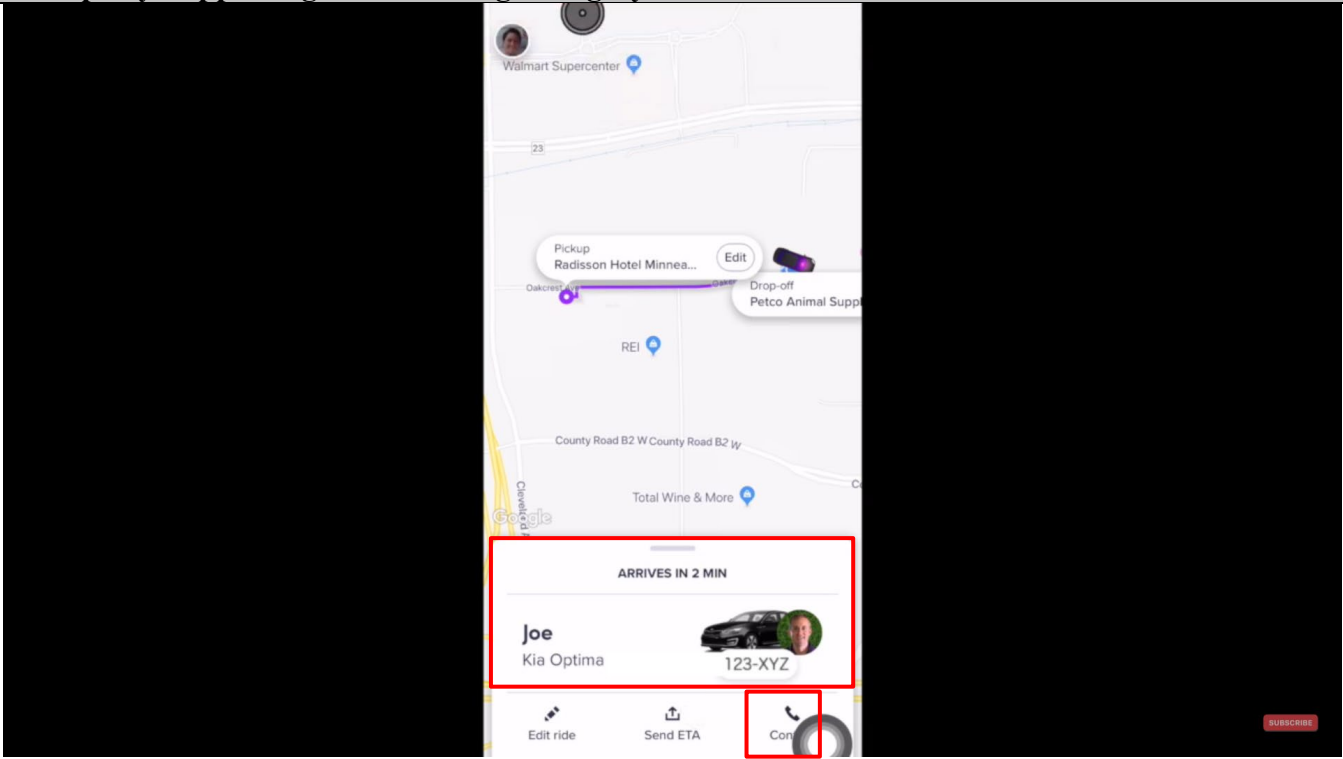
Exhibit B for US Patent No. 7,630,724 Against Lyft Accused Products

Claim – 7,630,724	Exemplary Supporting Evidence Regarding Lyft's Accused Products
	 <p>The screenshot shows the Lyft app interface. At the top, the destination is set to 'Petco'. A map displays a route starting from a pickup location (marked with a blue dot) and ending at Petco. The route is highlighted in blue. Below the map, there is a 'Navigate' button. At the bottom of the screen, a pickup card is visible, showing a driver's profile picture, the text '1 min • 0.3 mi', and 'Pick up Jenna'. A red box highlights the 'Pick up Jenna' button, which includes a circular icon with a white arrow pointing to the right. A 'SUBSCRIBE' button is visible in the bottom right corner of the video frame.</p> <p>https://www.youtube.com/watch?v=jVUy9poJDng at 10:46</p>

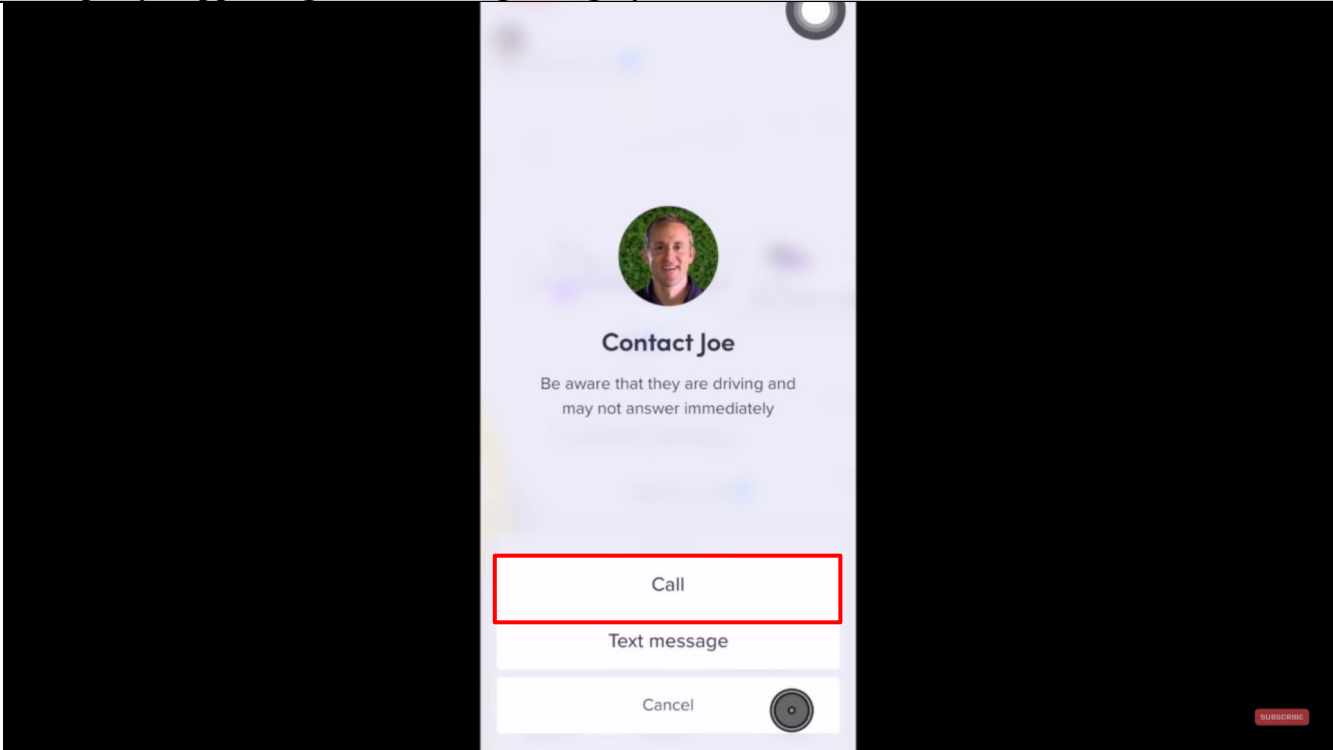
Exhibit B for US Patent No. 7,630,724 Against Lyft Accused Products

Claim – 7,630,724	Exemplary Supporting Evidence Regarding Lyft's Accused Products
	 <p>https://www.youtube.com/watch?v=jVUy9poJDng at 11:21</p>

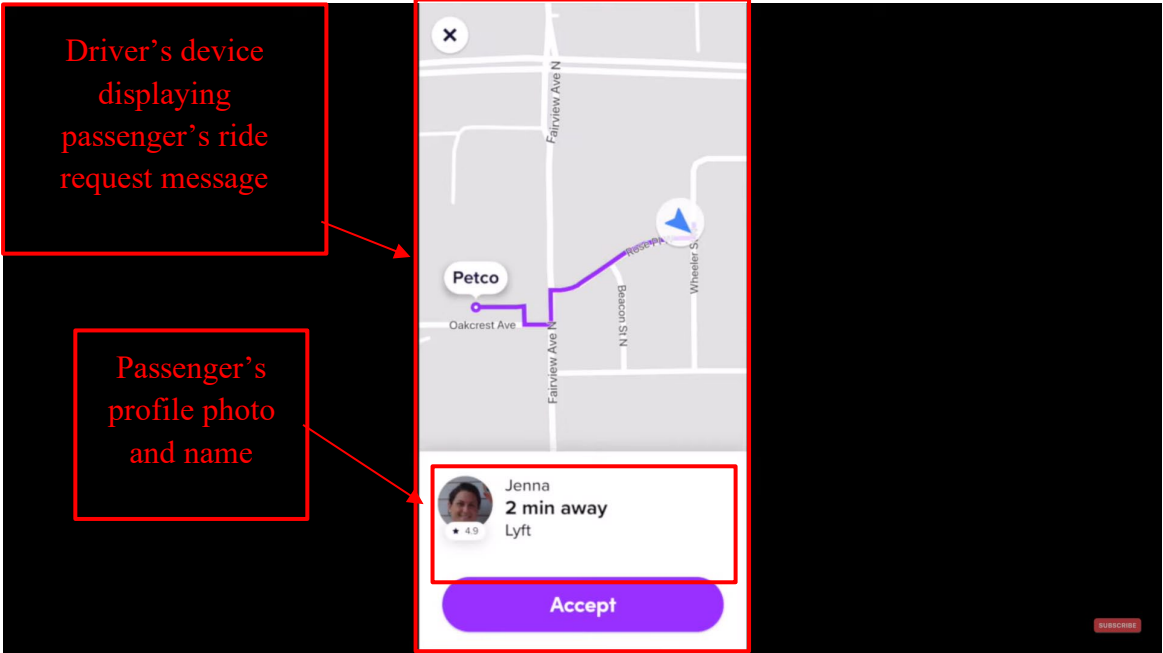
Exhibit B for US Patent No. 7,630,724 Against Lyft Accused Products

Claim – 7,630,724	Exemplary Supporting Evidence Regarding Lyft's Accused Products
	 <p>https://www.youtube.com/watch?v=j0RDMLcmOgU at 5:07</p>

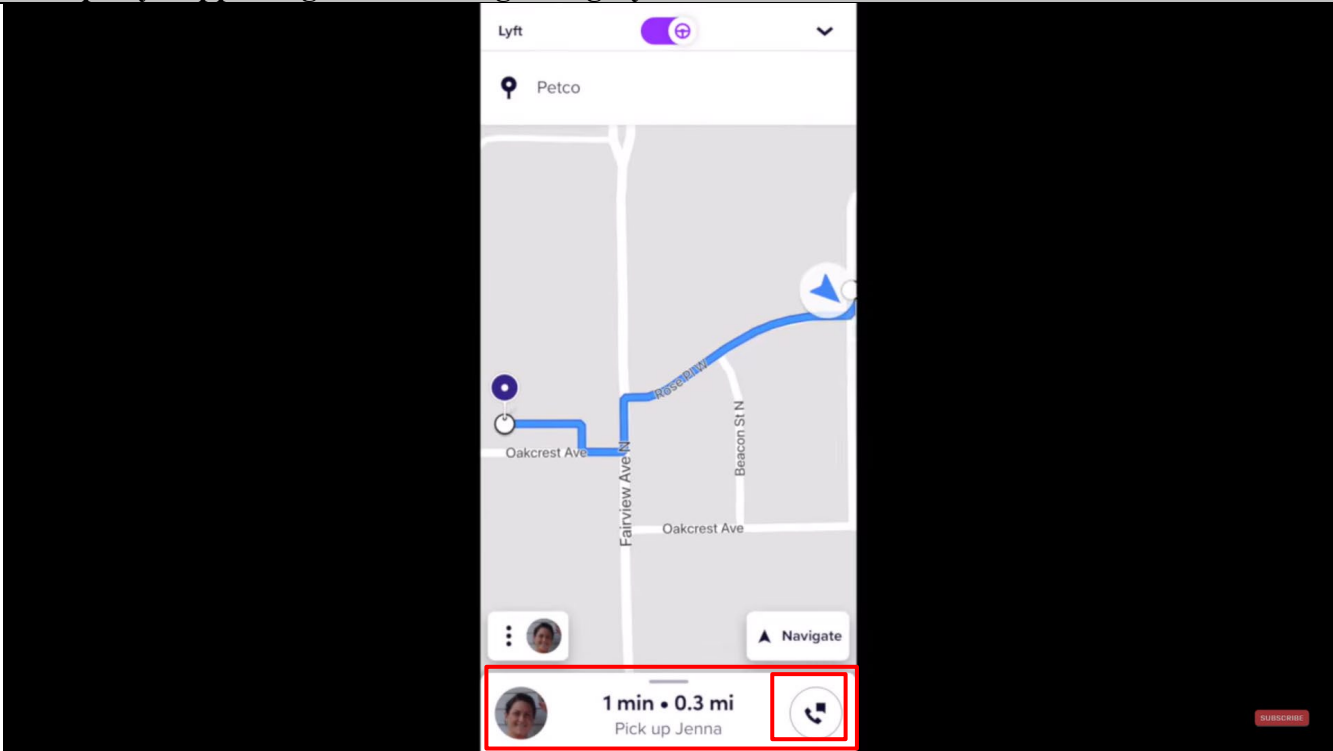
Exhibit B for US Patent No. 7,630,724 Against Lyft Accused Products

Claim – 7,630,724	Exemplary Supporting Evidence Regarding Lyft’s Accused Products
	 <p>https://www.youtube.com/watch?v=j0RDMLcmOgU at 5:32</p> <p>Further, to the extent this element is performed at least in part by Lyft's software source code, AGIS reserves the right to supplement these contentions pursuant to production of such source code by Lyft and to the extent Defendant requires additional information in accordance with P.R. 3-1 and for any other reasons.</p>
16[D]. generating at the server networks enabling anonymous voice and data communications so that neither the originator of the phone call or data	The Lyft Accused Products perform a computer implemented method as set forth below. Lyft further infringes directly and/or indirectly by performing, inducing others to perform, and/or contributing to the performance of: generating at the server networks enabling anonymous voice and data communications so that neither the originator of the phone call or data transmission need to know the other's phone number, name or other identifier other than a symbol location on a map.

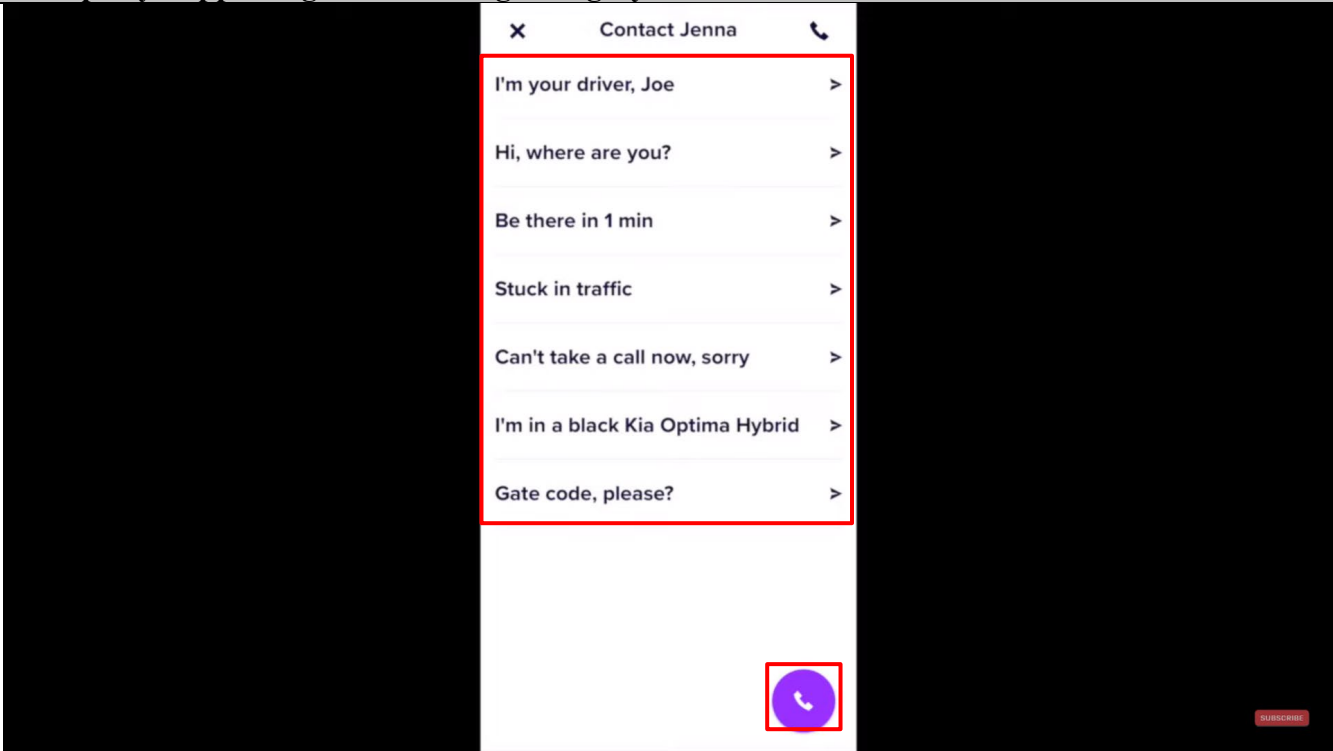
Exhibit B for US Patent No. 7,630,724 Against Lyft Accused Products

Claim – 7,630,724	Exemplary Supporting Evidence Regarding Lyft’s Accused Products
<p>transmission nor the receiver of the phone call or data transmission need to know the other's phone number, name or other identifier other than a symbol location on a map.</p>	<p>This element is infringed literally, or in the alternative, under the doctrine of equivalents.</p> <p>Lyft meets this limitation because the Lyft server(s) is an intermediary between riders/drivers using their respective Lyft apps for communication of data. On information and belief, communications between riders/drivers do not require knowledge of the drivers/riders’ identity or phone number. For example, upon information and belief, Lyft hides the personal phone numbers of the driver as well as the passenger when a call is placed by either the driver or passenger Therefore, Lyft’s servers generate an anonymous voice and data communication where both participants do not see their phone numbers.</p> <p>Further, to the extent this element is performed at least in part by Lyft's software source code, AGIS reserves the right to supplement these contentions pursuant to production of such source code by Lyft and to the extent Defendant requires additional information in accordance with P.R. 3-1 and for any other reasons.</p>

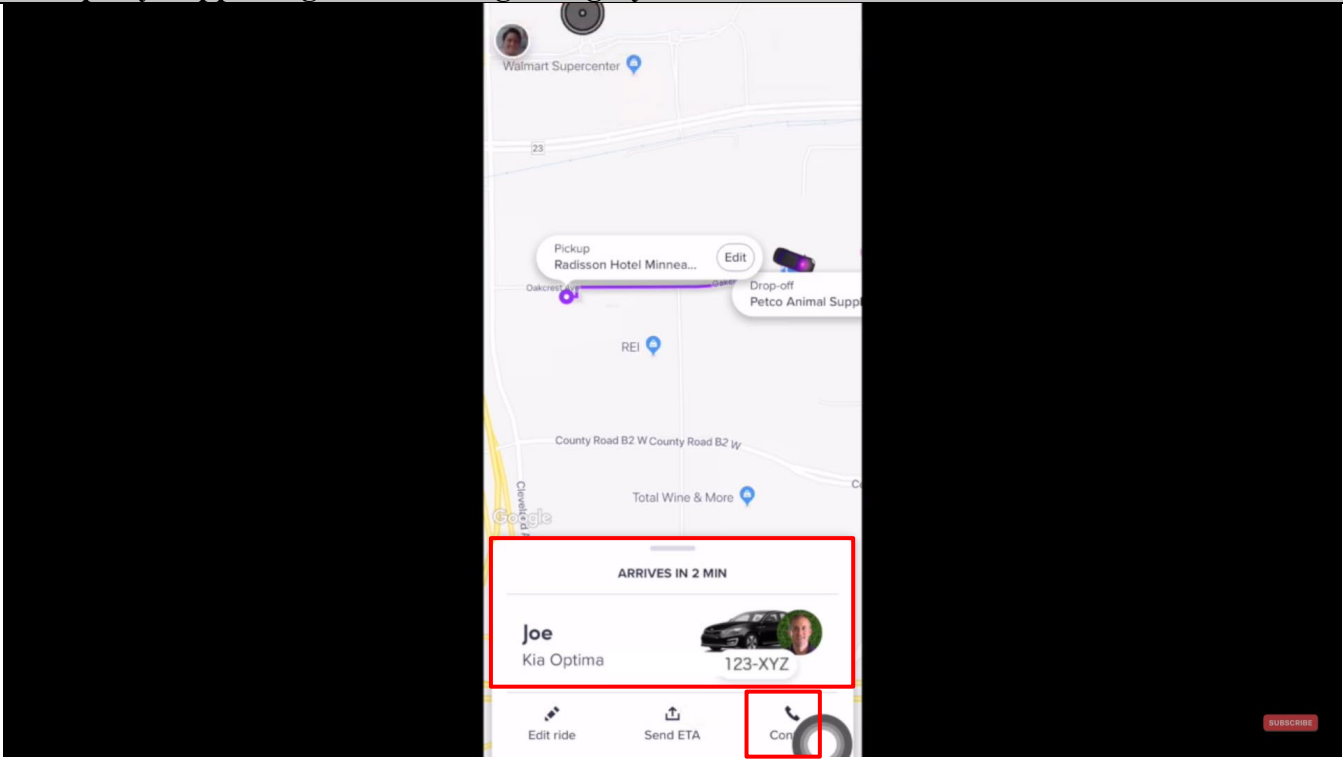
Exhibit C for US Patent No. 10,299,100 Against Lyft Accused Products

Based on information presently available, AGIS Software Development LLC (“AGIS”) contends that Defendant Lyft Inc. (collectively “Lyft” or “Defendant”) infringes claims 1-31 (the “Asserted Claims”) of U.S. Patent No. 10,299,100 (the “100 Patent”) through the Accused Products which are manufactured, sold, offered for sale, and/or used by Lyft.

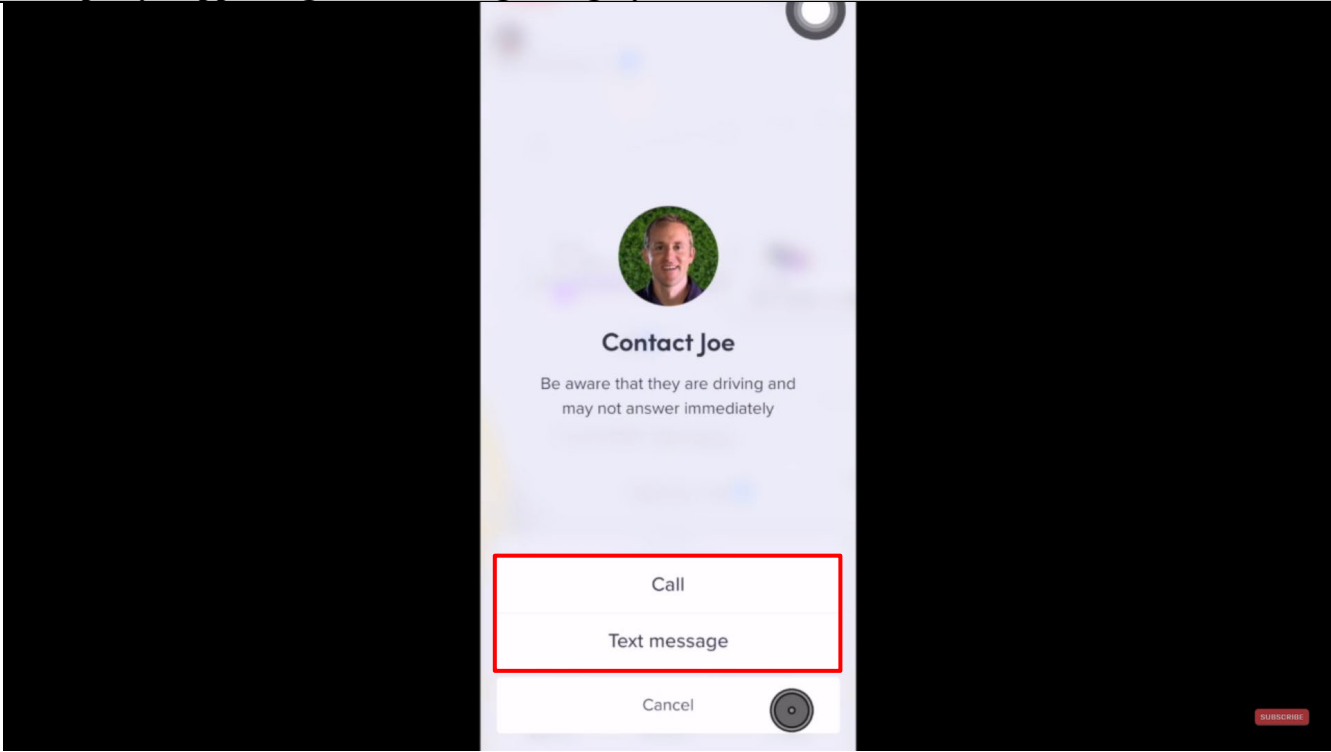
The Accused Products comprise all versions of the Lyft Application made, used, sold, offered for sale, or otherwise provided, after September 21, 2004. For example, the Accused Products comprise the Lyft application installed on all Android, iOS, Blackberry, and Windows Mobile based mobile devices (e.g. smartphones, tablets, laptops, and smart watches), and any variants thereof. AGIS reserves the right to amend this list of Accused Products as discovery progresses.

Lyft directly infringes each of the Asserted Claims by using, importing, testing, selling, and/or offering for sale the Accused Products in violation of 35 U.S.C. § 271(a).

Lyft indirectly infringes the Asserted Claims in violation of 35 U.S.C. § 271(b) by inducing third parties, including its users and/or customers, to directly infringe through their operation and use of the Accused Products. Lyft has knowingly and intentionally induced this direct infringement by, *inter alia*, (i) selling, importing, or otherwise providing the Accused Products to third parties with the intent that the Accused Products will be operated and used in a manner that practices the Asserted Claims; and (ii) marketing and advertising the Accused Products. Lyft’s marketing and promotional materials for the Accused Products are found, for example, on Lyft’s website, and in App stores of operating systems for which the Accused Products are made available. For example, Lyft’s website offers customers instructions and/or manuals for the Accused Products that instruct customers to, among other things, use the accused services in the Accused Products. Lyft’s website also offers support to customers, including instruction to, among other things, use the Accused Products share location information with a group of users. On information and belief, Lyft knows that its actions will result in infringement of the Asserted Claims, or subjectively believes that there is a high probability that its actions will result in infringement of the Asserted Claims but has taken deliberate actions to avoid learning these facts.

Lyft also contributorily infringes each of the Asserted Claims in violation of 35 U.S.C. § 271(c) by selling, importing, offering for sale, and otherwise providing the Accused Products, which when used directly infringe the Asserted Claims. The Accused Products constitute a material part of the Asserted Claims.

On information and belief, the charted version of the Lyft application is representative of all versions of the Accused Products, including all variants of the Accused Products made, sold, offered for sale, or used on any version of the Android, iOS, Blackberry, and Windows Mobile operating systems.

Exhibit C for US Patent No. 10,299,100 Against Lyft Accused Products

AGIS does not concede that any claims of the '100 Patent that are not listed below are not infringed by the identified Accused Products. Moreover, the citations to certain documents and other information below are intended to be exemplary only and in no way foreclose AGIS from citing or relying on additional documents, information, source code, and/or testimony at a later time. These contentions are preliminary in nature, and an analysis of Lyft's products, internal documentation, source code, and/or testimony from relevant witnesses may more fully and accurately describe the infringing features of its Accused Products. Accordingly, AGIS reserves the right to supplement, correct, modify, and/or amend these contentions once such additional information is made available to AGIS. Furthermore, AGIS reserves the right to supplement, correct, modify, and/or amend these contentions as discovery in this case progresses; in view of the Court's claim construction order(s); in view of any positions taken by Lyft, including, but not limited to, positions on claim construction,¹ invalidity, and/or non-infringement; and in connection with the preparation and exchange of expert reports.

The contents of every below claim cell on which another claim cell depends are expressly incorporated by reference in that dependent cell, as if set forth in their entirety therein

¹ The construction of claim terms herein is consistent with the constructions in *AGIS Software Dev. LLC v. Huawei Device USA, Inc.*, No. 2:17-cv-00513-JRG, Dkt. No. 205 (Lead Case) (E.D. Tex. Oct. 10, 2018) and *AGIS Software Dev. LLC v. Google LLC*, No. 2:19-cv-00361-JRG, Dkt. No. 147 (Lead Case) (E.D. Tex. Dec. 20, 2020). AGIS reserves the right to update its constructions and contentions in view of this Court's claim construction order.

Exhibit C for US Patent No. 10,299,100 Against Lyft Accused Products

Claim 10,299,100	- Exemplary Supporting Evidence Regarding Lyft’s Accused Products
<p>1[P]. A method performed by a mobile device having a display and one or more processors, the method comprising:</p>	<p>The Lyft Accused Products perform a computer implemented method as set forth below. Lyft further infringes directly and/or indirectly by performing, inducing others to perform, and/or contributing to the performance of: a method performed by a mobile device having a display and one or more processors.</p> <p>This element is infringed literally, or in the alternative, under the doctrine of equivalents.</p> <p>For example, Lyft provides Lyft app for passengers and Lyft Driver app for drivers. The Lyft apps for riders and drivers, in conjunction with Lyft’s servers and services, provide users with interactive methods to request, view, and track locations of passengers/riders using real-time maps and communications. The Lyft server(s) and their services communicate with the Lyft apps for riders and drivers. The Lyft server(s) and their services host information related to and instructions for processing user/device/vehicle accounts, location data, and map data. The claimed methods are distributed by Lyft in the Lyft apps. The claimed methods are used/tested by Lyft using the Lyft apps. The claimed methods are downloaded and installed by Lyft’s customers (riders) and personnel (drivers, personnel) at the direction/encouragement of Lyft and used by Lyft’s customers and Lyft’s personnel.</p> <h3 style="margin-top: 20px;">Lyft Driver app</h3> <div style="border: 1px solid red; padding: 5px; margin: 10px 0;"> <p>We’ve separated the passenger and driver experiences into two separate mobile apps — one exclusively for passengers (named the Lyft app) and the other exclusively for drivers (named the Lyft Driver app).</p> </div> <p>The Lyft Driver app will eventually be standard for all drivers and required for driving. At this time, drivers can keep using the Lyft app to give rides. Don’t worry! While we have some planned improvements to the Lyft Driver app, we’ve kept its features the same.</p> <p>https://help.lyft.com/hc/en-ca/articles/115013079208-Lyft-Driver-app</p>

Exhibit C for US Patent No. 10,299,100 Against Lyft Accused Products

Claim 10,299,100	- Exemplary Supporting Evidence Regarding Lyft's Accused Products
	<h3 data-bbox="478 282 779 331">What is Lyft?</h3> <p data-bbox="478 384 1545 451">Lyft is a platform that connects drivers with individuals and organizations that need rides.</p> <p data-bbox="468 480 942 513">https://www.lyft.com/drive-with-lyft</p>  <p data-bbox="468 948 592 974">Go online</p> <p data-bbox="468 1013 1665 1118">Open your Lyft Driver app and tap the steering wheel icon. Lyft will now find the closest passenger to your location requesting a ride. Turn on some music and get comfortable: that first ride request may come quickly or may take a while, depending on the number of current passenger requests.</p> <p data-bbox="468 1123 1125 1156">https://www.lyft.com/hub/posts/how-to-give-a-ride</p>

Exhibit C for US Patent No. 10,299,100 Against Lyft Accused Products

Claim 10,299,100	- Exemplary Supporting Evidence Regarding Lyft's Accused Products
	<p data-bbox="520 298 730 456">Driver's device displaying passenger's ride request message</p>  <p data-bbox="470 919 1381 951">https://www.youtube.com/watch?v=jVUy9poJDng at 10:24, Annotated</p>

Exhibit C for US Patent No. 10,299,100 Against Lyft Accused Products

Claim 10,299,100	- Exemplary Supporting Evidence Regarding Lyft’s Accused Products
	 <p>https://www.youtube.com/watch?v=j0RDMLcmOgU at 4:01</p> <p>Further, to the extent this element is performed at least in part by Lyft's software source code, AGIS reserves the right to supplement these contentions pursuant to production of such source code by Lyft and to the extent Defendant requires additional information in accordance with P.R. 3-1 and for any other reasons.</p>
1[A]. executing operations on the one or more	The Lyft Accused Products infringe directly and/or indirectly by performing, inducing others to perform, and/or contributing to the performance of: executing operations on the one or more processors of the mobile device.

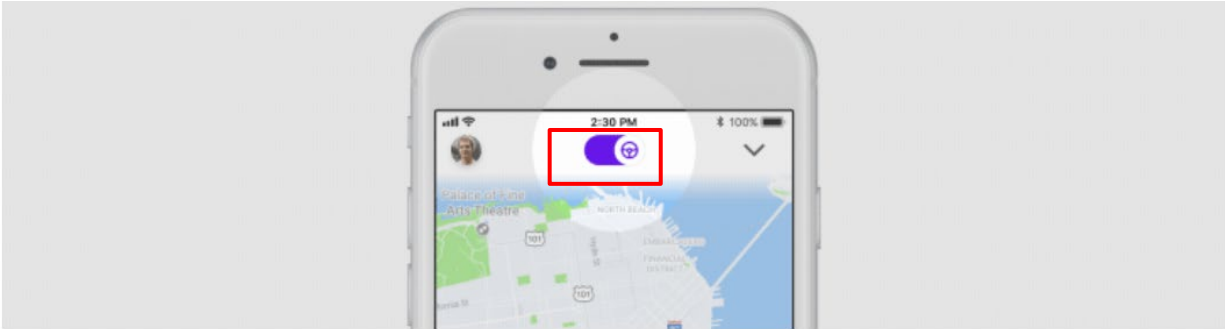
Exhibit C for US Patent No. 10,299,100 Against Lyft Accused Products

Claim 10,299,100	-	Exemplary Supporting Evidence Regarding Lyft’s Accused Products
processors of the mobile device, the operations comprising:	<p>This element is infringed literally, or in the alternative, under the doctrine of equivalents.</p> <p>Lyft’s apps perform the limitations by executing operations on processors (either hardware or software). Lyft’s apps perform the operations in conjunction with Lyft’s servers, which receive passenger’s request for a ride and communicates the request to the nearby drivers. The nearby drivers receive the request for a ride from the passengers which they accept or decline. The servers further facilitate the communication between the passenger and the allocated driver during a ride.</p>	 <p style="text-align: center;">https://www.youtube.com/watch?v=j0RDMLcmOgU at 3:27</p>

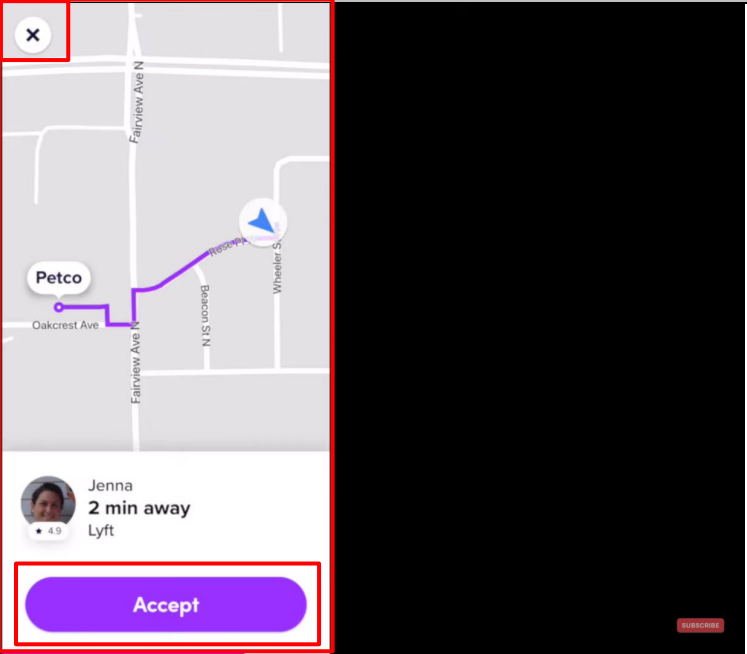
Exhibit C for US Patent No. 10,299,100 Against Lyft Accused Products

Claim 10,299,100	- Exemplary Supporting Evidence Regarding Lyft's Accused Products
	 <p>https://www.youtube.com/watch?v=j0RDMLcmOgU at 4:01</p>

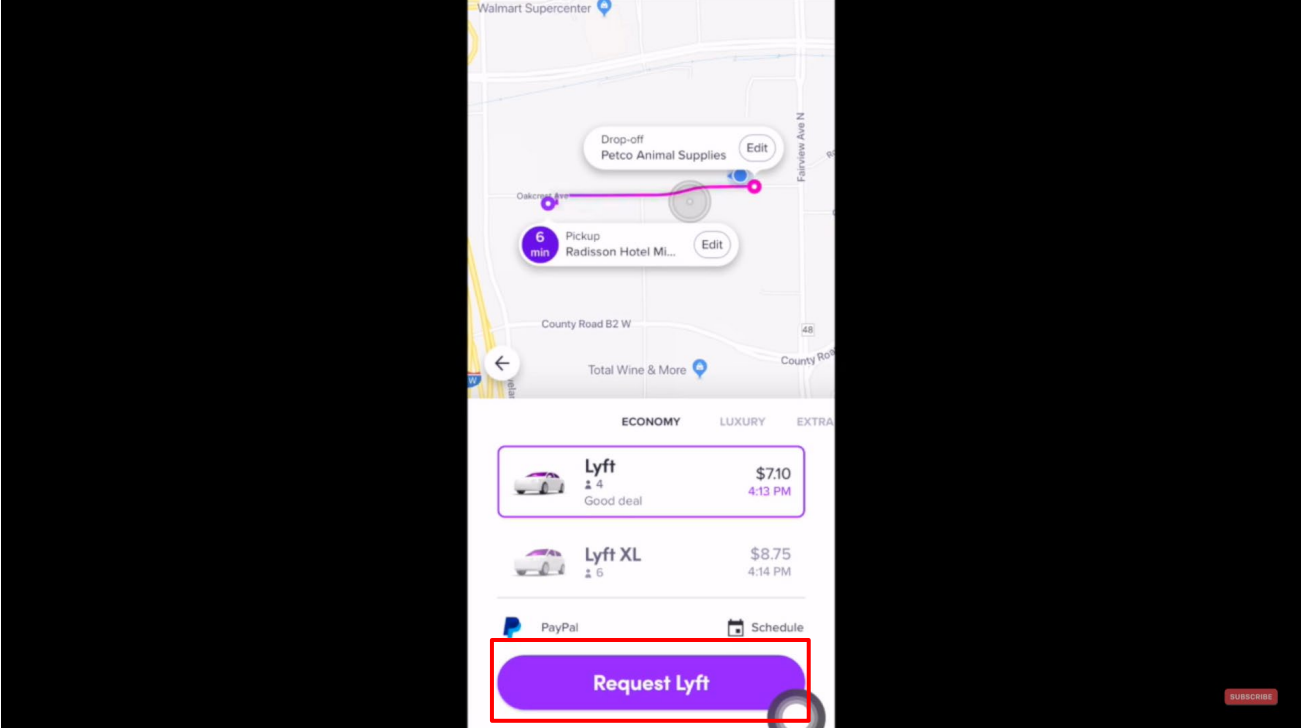
Exhibit C for US Patent No. 10,299,100 Against Lyft Accused Products

Claim 10,299,100	- Exemplary Supporting Evidence Regarding Lyft's Accused Products
	 <p>Driver's device displaying passenger's ride request message</p> <p>Passenger's current location (when pickup location is set to current location)</p> <p>Driver's current location</p> <p>Jenna 2 min away Lyft 4.9</p> <p>Accept</p> <p>https://www.youtube.com/watch?v=jVUy9poJDng at 10:24, Annotated</p>

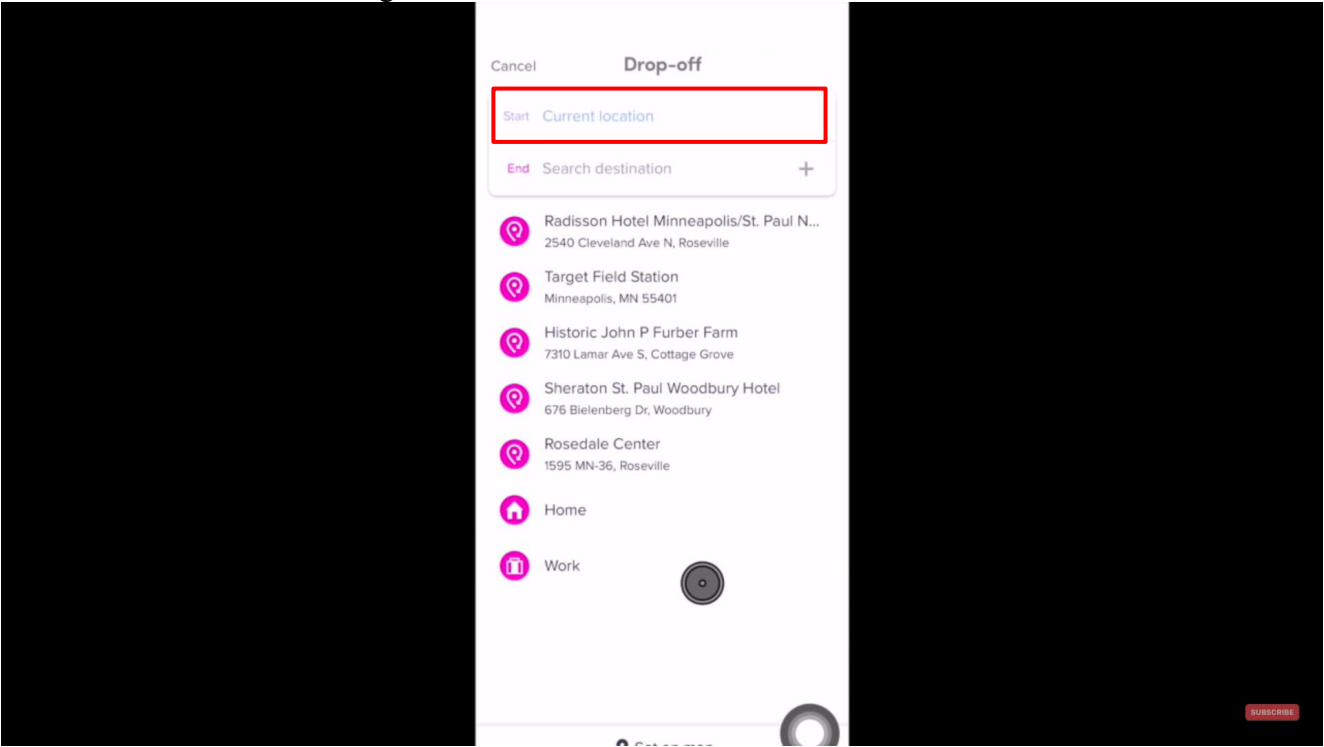
Exhibit C for US Patent No. 10,299,100 Against Lyft Accused Products

Claim 10,299,100	- Exemplary Supporting Evidence Regarding Lyft's Accused Products
	 <p>The screenshot shows the Lyft app's navigation interface. At the top, the destination is 'Petco'. A blue route is displayed on a map, starting from the passenger's location (marked with a red circle and a white car icon) and ending at the driver's location (marked with a blue circle and a white car icon). The route passes through Oakcrest Ave, Fairview Ave N, and Beacon St N. A 'Navigate' button is visible at the bottom right of the map area. Below the map, the estimated time and distance are shown as '1 min • 0.3 mi' and the pickup location is 'Pick up Jenna'. A 'SUBSCRIBE' button is in the bottom right corner.</p> <p>Annotations on the screenshot:</p> <ul style="list-style-type: none">A red box on the left contains the text "Driver's mobile phone screen" with an arrow pointing to the entire screenshot.A red box on the left contains the text "Passenger's current location (when pickup location is set to current location)" with an arrow pointing to the passenger's location marker on the map.A red box on the right contains the text "Driver's current location" with an arrow pointing to the driver's location marker on the map. <p>https://www.youtube.com/watch?v=jVUy9poJDng at 10:46, Annotated</p>

Exhibit C for US Patent No. 10,299,100 Against Lyft Accused Products

Claim 10,299,100	- Exemplary Supporting Evidence Regarding Lyft's Accused Products
	 <p>https://www.youtube.com/watch?v=j0RDMLcmOgU at 5:07, Annotated</p>

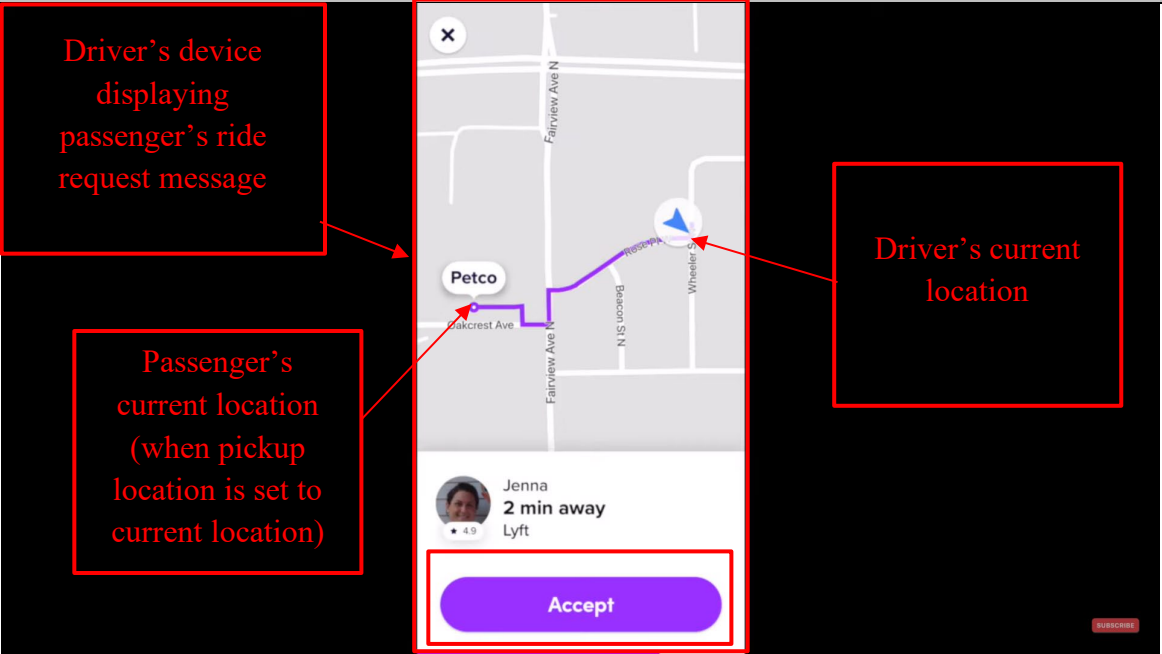
Exhibit C for US Patent No. 10,299,100 Against Lyft Accused Products

Claim 10,299,100	- Exemplary Supporting Evidence Regarding Lyft's Accused Products
	 <p>The screenshot displays the Lyft app interface. At the top, the map shows the route from Terminal 1, Arrivals to New York Marriott Marquis. A red box highlights two car icons on the map, with an arrow pointing to a text box labeled "Nearby Drivers' location". Another red box highlights a blue location pin at John F. Kennedy International Airport, with an arrow pointing to a text box labeled "Passenger's location". Below the map, the app lists three ride options: "Lyft" (US\$64.81, 3:20 AM), "Lyft XL" (US\$81.65, 3:22 AM), and "Car seat" (US\$76.50, 3:34 AM). At the bottom, there is a "Select Lyft" button.</p>

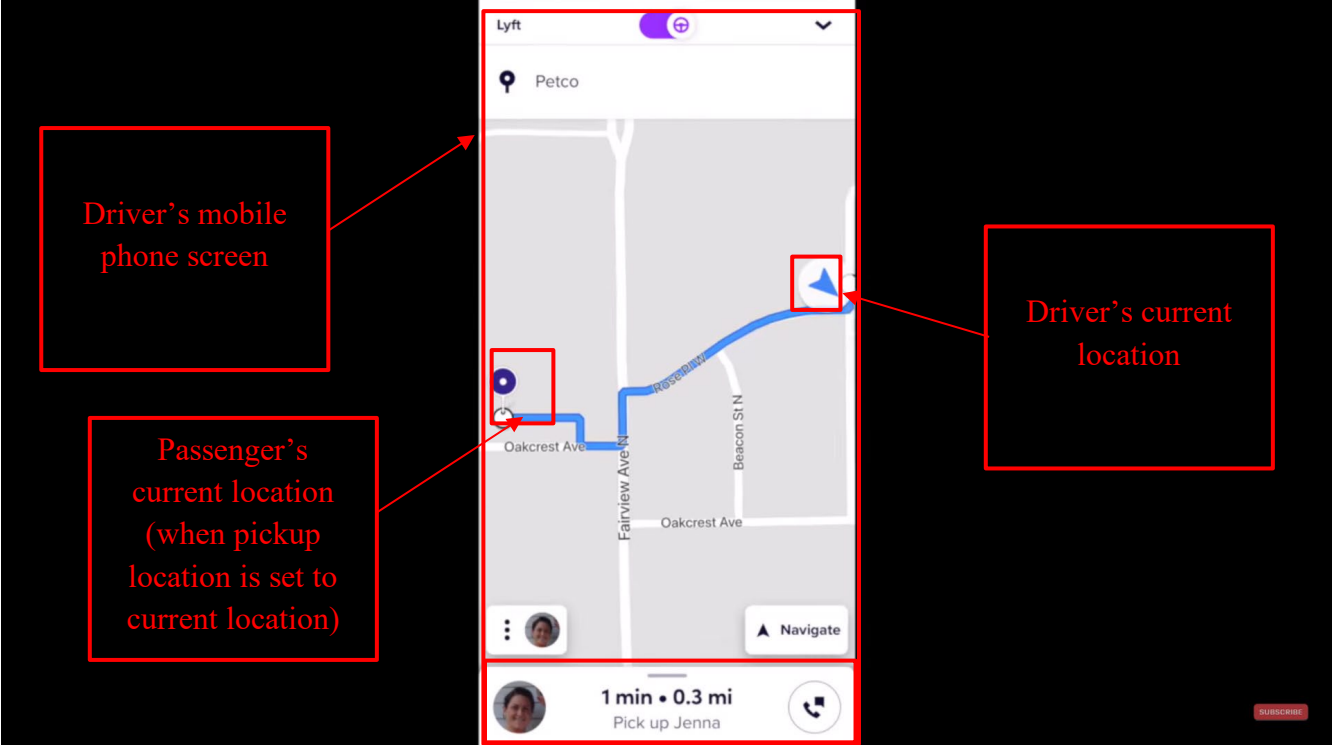
Exhibit C for US Patent No. 10,299,100 Against Lyft Accused Products

Claim 10,299,100	- Exemplary Supporting Evidence Regarding Lyft’s Accused Products
	<p>Further, to the extent this element is performed at least in part by Lyft's software source code, AGIS reserves the right to supplement these contentions pursuant to production of such source code by Lyft and to the extent Defendant requires additional information in accordance with P.R. 3-1 and for any other reasons.</p>
<p>1[B]. associating the mobile device with an identifier, wherein the identifier corresponds to a network participant</p>	<p>The Lyft Accused Products infringe directly and/or indirectly by performing, inducing others to perform, and/or contributing to the performance of: associating the mobile device with an identifier, wherein the identifier corresponds to a network participant.</p> <p>This element is infringed literally, or in the alternative, under the doctrine of equivalents.</p> <p>The Lyft app, either alone or in conjunction with services provided Lyft’s server and/or services, performs this limitation when it receives the account creation data from the Lyft app for riders. The Lyft app also performs this limitation, after account creation, during the sign-in or log-in process from the Lyft app for riders. On information and belief, the Lyft app also performs this limitation when the Lyft server requests status or other data via the Lyft app for riders. In all cases, the identifier is information associated with the identity of the rider, account, device, phone number, or Lyft app for riders. For example, a Lyft passenger sets up their account by providing details including but not limited to name, email address, and phone number. After verifying the details of the passenger, Lyft adds them to the Lyft platform or network of drivers and passengers. Thereafter, the passenger starts booking rides.</p>

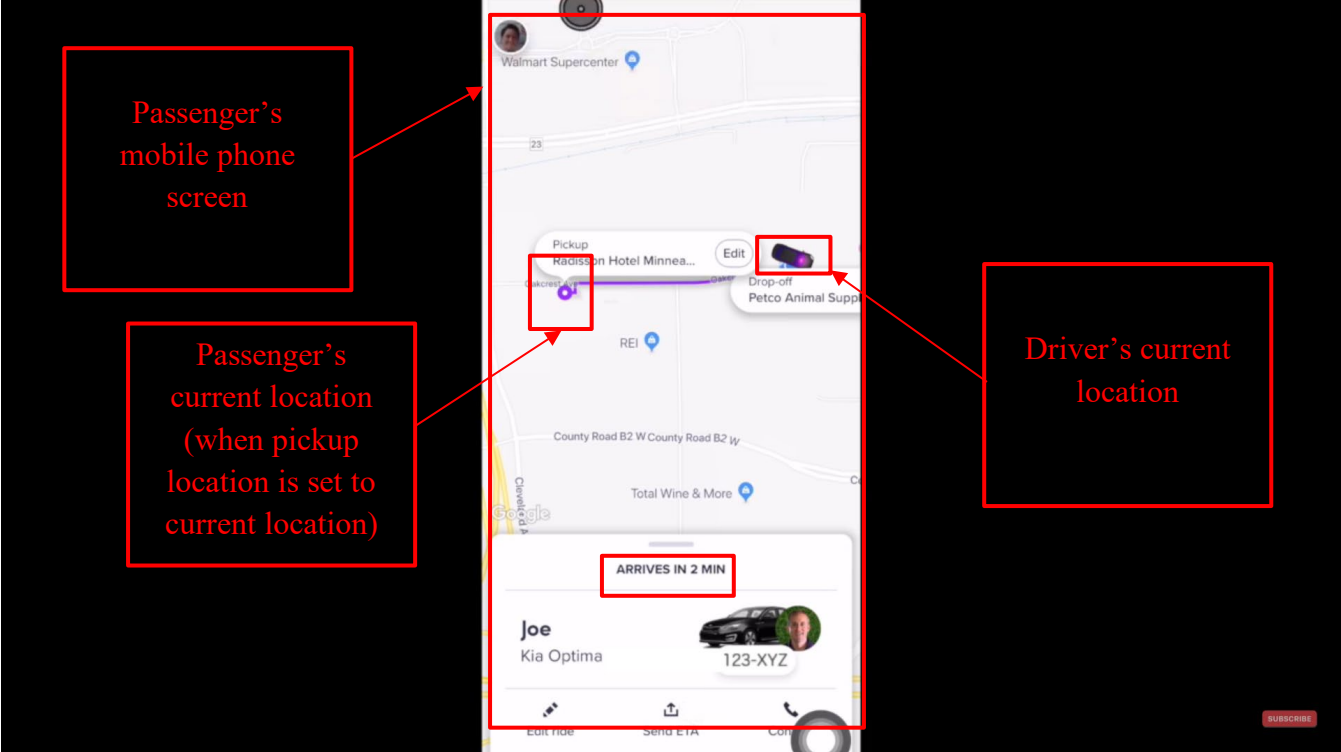
Exhibit C for US Patent No. 10,299,100 Against Lyft Accused Products

Claim 10,299,100	- Exemplary Supporting Evidence Regarding Lyft's Accused Products
	 <p>Source: https://www.lyft.com/driver.</p>

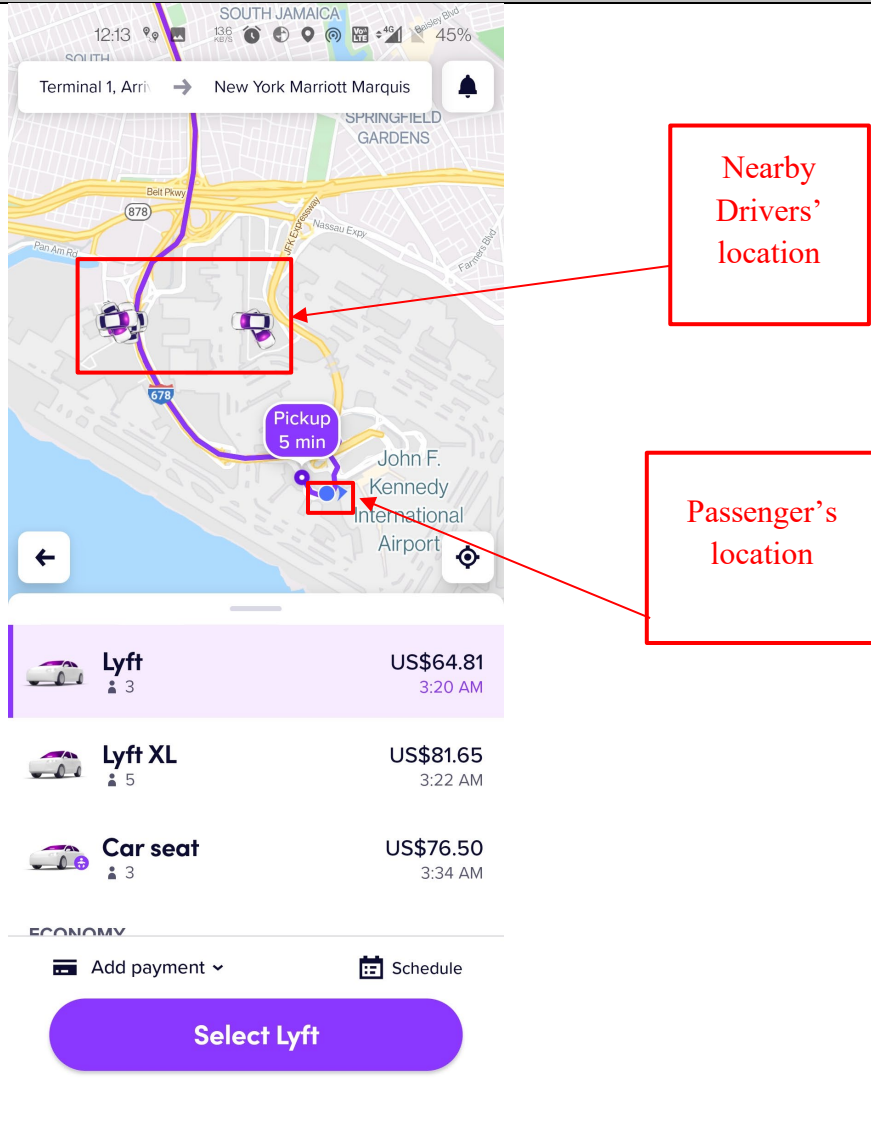
Exhibit C for US Patent No. 10,299,100 Against Lyft Accused Products

Claim 10,299,100	- Exemplary Supporting Evidence Regarding Lyft's Accused Products
	 <p>The screenshot shows a mobile login interface for Lyft. At the top left is the Lyft logo. Below it, the text reads "Welcome back to Lyft!". Underneath, it says "We'll send a text to verify your phone." There is a text input field with a dropdown menu showing a US flag and "+1 Phone number". Below the input field is a checkbox labeled "Keep me signed in". A large purple button labeled "Next" is centered below the checkbox. At the bottom, there is a link that says "Have a new number?" followed by a magnifying glass icon and the text "Find your account".</p> <p>Source: https://account.lyft.com/auth?next=https%3A%2F%2Fwww.lyft.com%2Flogin%2Fjump.</p>

Exhibit C for US Patent No. 10,299,100 Against Lyft Accused Products

Claim 10,299,100	- Exemplary Supporting Evidence Regarding Lyft’s Accused Products
<p>1[C]. determining a device location corresponding to a geographical location of the mobile device</p>	<p>Before you begin, be sure you have the following:</p> <ul style="list-style-type: none"> • Your phone number • Your email address • A photo of yourself <p>Get started</p> <ol style="list-style-type: none"> 1. Type in your device's phone number 2. To verify your identity, we'll send a verification code via text to your phone number. We want to make sure you're human! 3. The text message should arrive immediately. If you don't see it after a bit, tap 'Resend code.' 4. Type in your name, email address, and take a selfie so your driver knows who to pick up 5. That's it! Once you've set up your account, you'll be able to request a ride (Learn How to request a ride). <p>https://help.lyft.com/hc/e/articles/115012926947-How-to-create-a-Lyft-account</p> <p>Further, to the extent this element is performed at least in part by Lyft's software source code, AGIS reserves the right to supplement these contentions pursuant to production of such source code by Lyft and to the extent Defendant requires additional information in accordance with P.R. 3-1 and for any other reasons.</p>
<p>1[C]. determining a device location corresponding to a geographical location of the mobile device</p>	<p>The Lyft Accused Products infringe directly and/or indirectly by performing, inducing others to perform, and/or contributing to the performance of: determining a device location corresponding to a geographical location of the mobile device.</p> <p>This element is infringed literally, or in the alternative, under the doctrine of equivalents.</p> <p>The Lyft app performs this limitation by determining the location of the device associated with the account or identity data described above. For example, the passenger’s Lyft app installed determines the passenger’s</p>

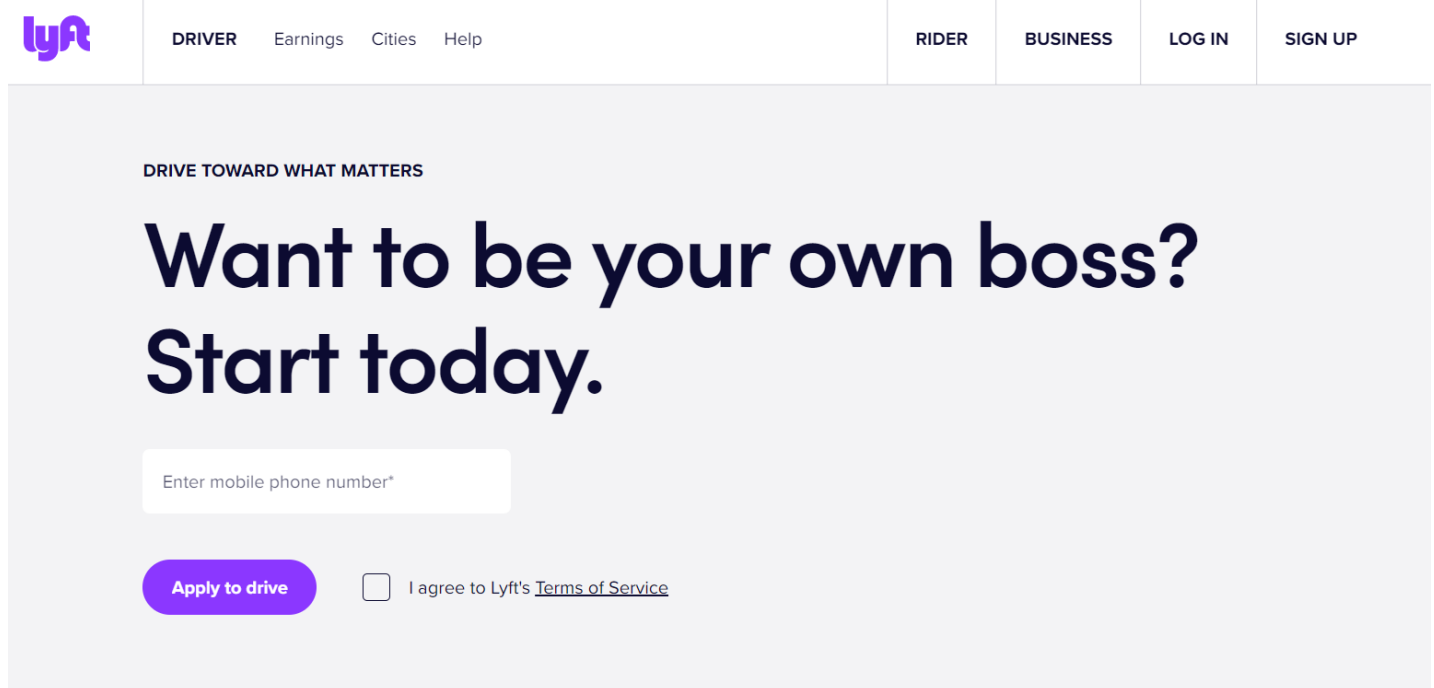
Exhibit C for US Patent No. 10,299,100 Against Lyft Accused Products

Claim 10,299,100	- Exemplary Supporting Evidence Regarding Lyft's Accused Products
	location and displays it on the map in the Lyft app. Similarly, the driver's mobile phone with the Lyft Driver app installed determines the driver's location and displays it on the map in the Lyft Driver app. On information and belief, the rider's location comprises geographical coordinates or geotagged/geocoded/georeferenced information related to a rider's geographical location.

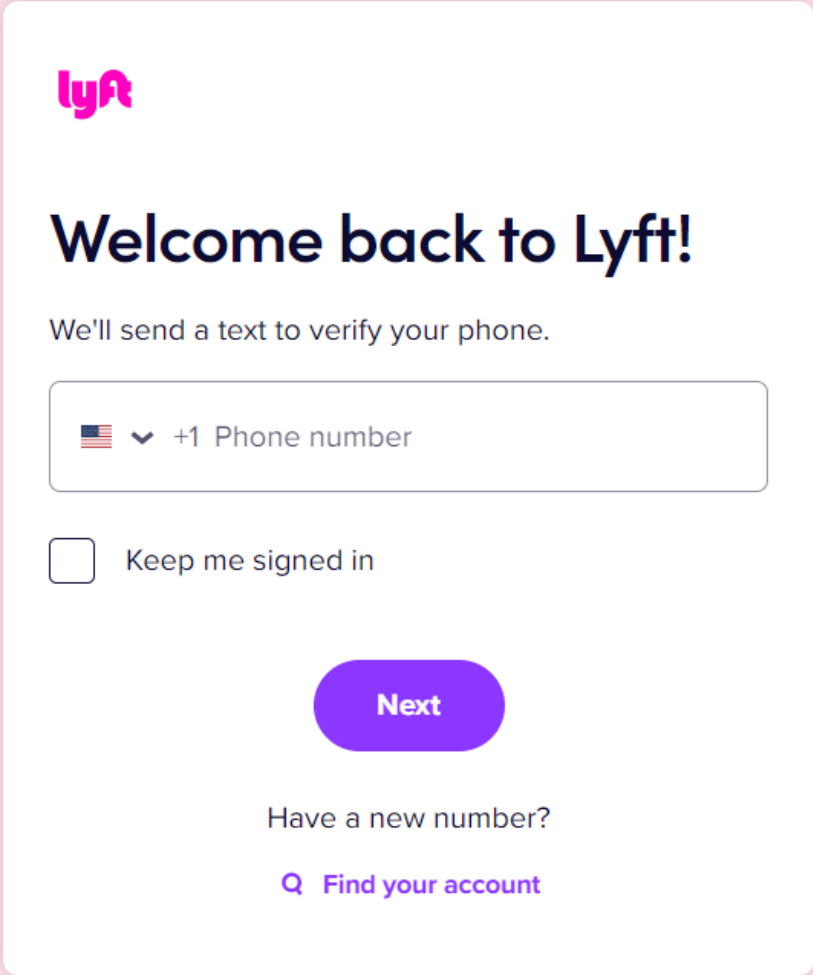
Exhibit C for US Patent No. 10,299,100 Against Lyft Accused Products

Claim 10,299,100	- Exemplary Supporting Evidence Regarding Lyft's Accused Products
	 <p>The screenshot displays the Lyft app interface. At the top, the map shows the route from Terminal 1, Arrivals to New York Marriott Marquis. A red box highlights two car icons on the map, with an arrow pointing to a text box labeled "Nearby Drivers' location". Another red box highlights a blue location pin at John F. Kennedy International Airport, with an arrow pointing to a text box labeled "Passenger's location". Below the map, the app lists three ride options: "Lyft" (US\$64.81, 3:20 AM), "Lyft XL" (US\$81.65, 3:22 AM), and "Car seat" (US\$76.50, 3:34 AM). At the bottom, there is a "Select Lyft" button.</p>

Exhibit C for US Patent No. 10,299,100 Against Lyft Accused Products

Claim 10,299,100	- Exemplary Supporting Evidence Regarding Lyft's Accused Products
	 <p>https://www.youtube.com/watch?v=jVUy9poJDng at 10:24, Annotated</p> <p>Further, to the extent this element is performed at least in part by Lyft's software source code, AGIS reserves the right to supplement these contentions pursuant to production of such source code by Lyft and to the extent Defendant requires additional information in accordance with P.R. 3-1 and for any other reasons.</p>
<p>1[D]. receiving, from a server, mapping data including a map and coordinate translation data correlating</p>	<p>The Lyft Accused Products infringe directly and/or indirectly by performing, inducing others to perform, and/or contributing to the performance of: receiving, from a server, mapping data including a map and coordinate translation data correlating coordinates of positions on the map with corresponding coordinates of geographical locations.</p> <p>This element is infringed literally, or in the alternative, under the doctrine of equivalents.</p>

Exhibit C for US Patent No. 10,299,100 Against Lyft Accused Products

Claim 10,299,100	- Exemplary Supporting Evidence Regarding Lyft’s Accused Products
coordinates of positions on the map with corresponding coordinates of geographical locations	The Lyft app performs this limitation because it receives maps and/or map tiles from a server for displaying a map in the Lyft app display. The Lyft app also receives data for correlating map coordinates to geographical locations. For example, the Lyft server transmits the calculated location coordinates of the passenger and nearby drivers to the passenger’s device and loads them on the map. Further, the location coordinates of the driver and the passenger (pickup location) are transmitted to the driver’s device during the ride request from the passenger. Once the ride is accepted and the passenger is picked up by the driver, the destination address of the passenger is also loaded on the map in the Lyft Driver app on the driver’s device.

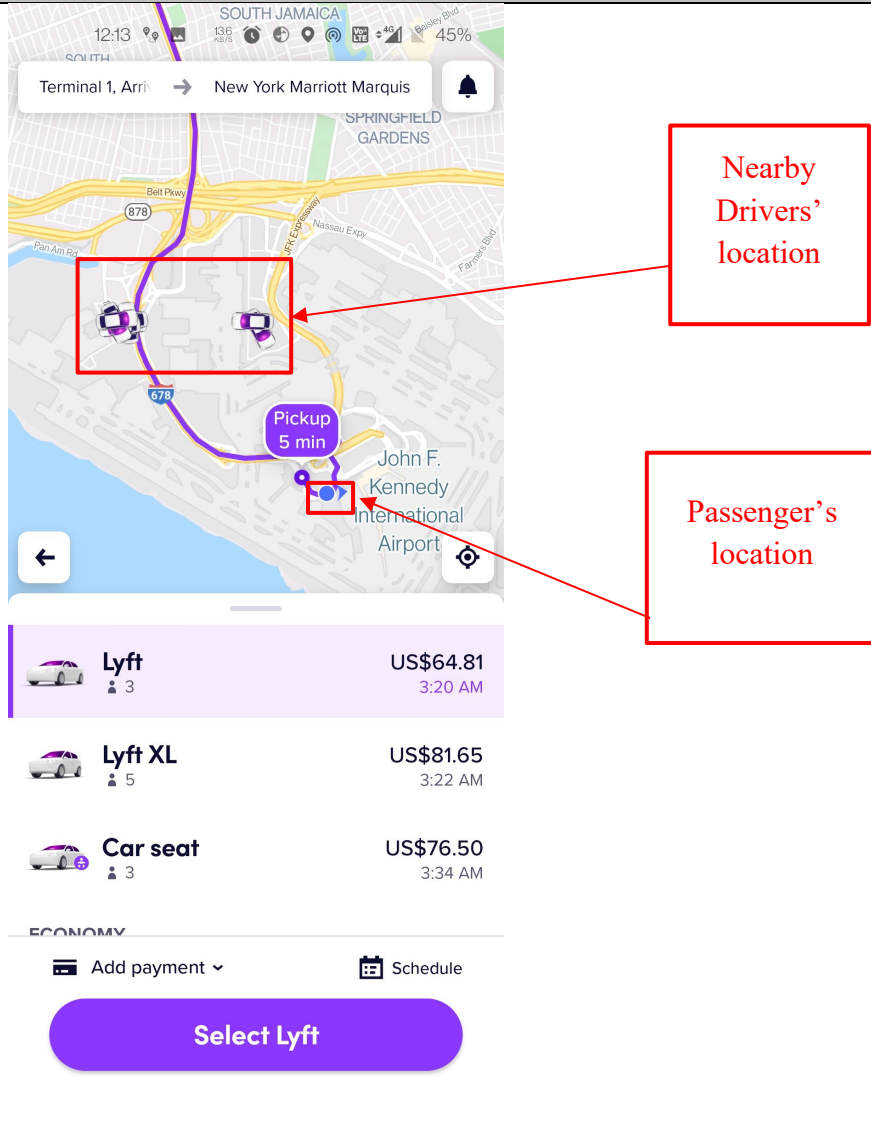
Exhibit C for US Patent No. 10,299,100 Against Lyft Accused Products

Claim 10,299,100	- Exemplary Supporting Evidence Regarding Lyft's Accused Products
	 <p>The screenshot shows a Lyft app interface. At the top, the destination is set to 'New York Marriott Marquis'. The map displays the area around John F. Kennedy International Airport. A red box highlights two car icons representing nearby drivers. Another red box highlights a blue location pin representing the passenger's location. A 'Pickup 5 min' callout is visible near the passenger location. Below the map, three ride options are listed: 'Lyft' (US\$64.81, 3:20 AM), 'Lyft XL' (US\$81.65, 3:22 AM), and 'Car seat' (US\$76.50, 3:34 AM). At the bottom, there are buttons for 'Add payment', 'Schedule', and a large purple 'Select Lyft' button.</p> <p data-bbox="1123 386 1323 587">Nearby Drivers' location</p> <p data-bbox="1098 711 1329 906">Passenger's location</p>

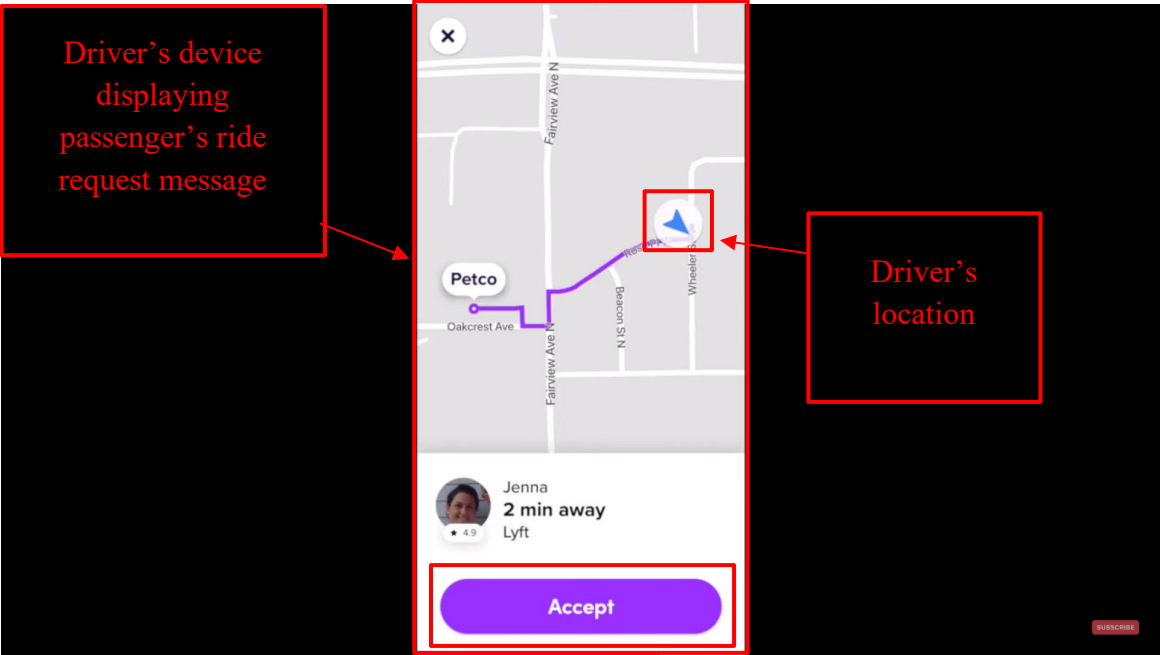
Exhibit C for US Patent No. 10,299,100 Against Lyft Accused Products

Claim 10,299,100	- Exemplary Supporting Evidence Regarding Lyft's Accused Products
	 <p>The screenshot shows a Lyft ride request interface on a driver's device. A map displays a route from a pickup location (Petco) to a destination. A driver's location is indicated by a blue arrow on the map. The driver's name is Jenna, 2 minutes away, with a 4.9 rating. An 'Accept' button is visible at the bottom. Red boxes and arrows highlight the pickup location, the driver's location, and the 'Accept' button.</p> <p>Driver's device displaying passenger's ride request message</p> <p>Passenger pickup location</p> <p>Driver's location</p> <p>https://www.youtube.com/watch?v=jVUy9poJDng at 10:24, Annotated</p>

Exhibit C for US Patent No. 10,299,100 Against Lyft Accused Products

Claim 10,299,100	- Exemplary Supporting Evidence Regarding Lyft's Accused Products
	 <p>https://www.youtube.com/watch?v=j0RDMLcmOgU at 3:49</p>

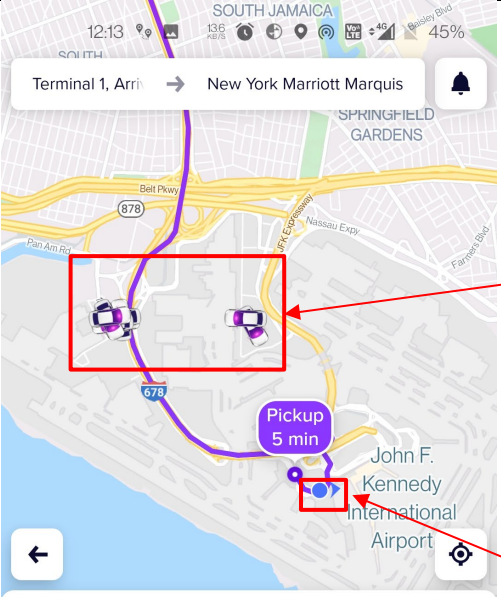
Exhibit C for US Patent No. 10,299,100 Against Lyft Accused Products

Claim 10,299,100	- Exemplary Supporting Evidence Regarding Lyft's Accused Products
	 <p>The screenshot shows the Lyft app interface. At the top, the status bar displays 'T-Mobile LTE', '8:54 PM', and '20%' battery. The Lyft logo is in the top left. A red box highlights the destination information: 'DoubleTree by Hilton Hotel Denver - Aurora, 13696 E Il...' with an 'Edit destination' link and a '2 Min' estimate. Below this, a map shows a route in purple. A red box on the map highlights a pink location pin. A red arrow points from this pin to a text box on the right. The text box contains the text: 'Passenger's destination location loaded after the driver picks him/her up'. At the bottom of the app, a driver profile for 'Kevin' is shown with a 'Slide to drop off' button.</p> <p>https://www.youtube.com/watch?v=b31WorLlcqE at 9:40</p>

Exhibit C for US Patent No. 10,299,100 Against Lyft Accused Products

Claim 10,299,100	- Exemplary Supporting Evidence Regarding Lyft's Accused Products
	Further, to the extent this element is performed at least in part by Lyft's software source code, AGIS reserves the right to supplement these contentions pursuant to production of such source code by Lyft and to the extent Defendant requires additional information in accordance with P.R. 3-1 and for any other reasons.
1[E]. receiving, from a server, location data indicating vehicle locations of one or more vehicles	<p>The Lyft Accused Products infringe directly and/or indirectly by performing, inducing others to perform, and/or contributing to the performance of: receiving, from a server, location data indicating vehicle locations of one or more vehicles.</p> <p>This element is infringed literally, or in the alternative, under the doctrine of equivalents.</p> <p>The Lyft app performs this limitation because it receives vehicle location data from a server and that vehicle location data indicates the locations of drivers/vehicles. For example, the Lyft server transmits the calculated location coordinates of the passenger and nearby drivers ("location data indicating vehicle locations of one or more vehicles") to the passenger's device and loads them on the map in the Lyft app on the passenger's device.</p>

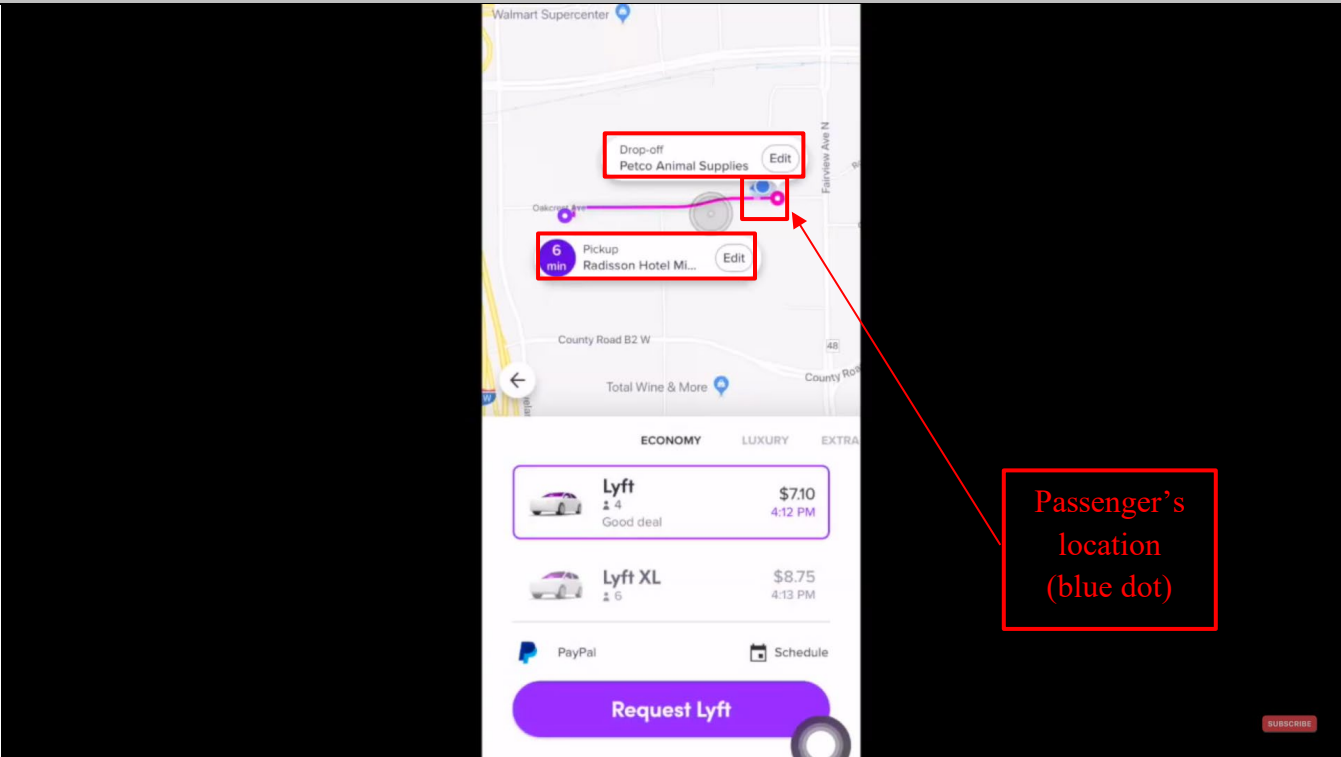
Exhibit C for US Patent No. 10,299,100 Against Lyft Accused Products

Claim 10,299,100	- Exemplary Supporting Evidence Regarding Lyft's Accused Products
	 <p>The screenshot shows a Lyft app interface. At the top, the route is from Terminal 1, Arrivals to New York Marriott Marquis. The map displays the area around John F. Kennedy International Airport. A red box highlights two car icons representing nearby drivers, with an arrow pointing to a text box labeled "Nearby Drivers' location". Another red box highlights a blue location pin representing the passenger's location, with an arrow pointing to a text box labeled "Passenger's location". Below the map, three ride options are listed: Lyft (US\$64.81, 3:20 AM), Lyft XL (US\$81.65, 3:22 AM), and Car seat (US\$76.50, 3:34 AM). A large purple button at the bottom says "Select Lyft".</p>

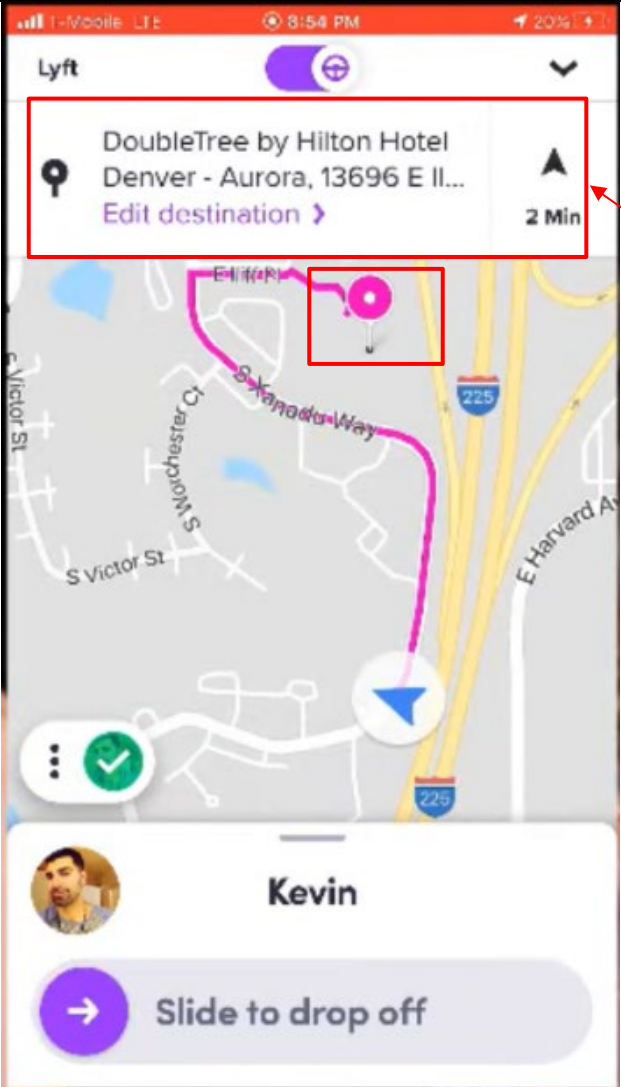
Exhibit C for US Patent No. 10,299,100 Against Lyft Accused Products

Claim 10,299,100	- Exemplary Supporting Evidence Regarding Lyft’s Accused Products
	<p>Further, to the extent this element is performed at least in part by Lyft's software source code, AGIS reserves the right to supplement these contentions pursuant to production of such source code by Lyft and to the extent Defendant requires additional information in accordance with P.R. 3-1 and for any other reasons.</p>
<p>1[F]. marking the map with a plurality of symbols comprising: a participant symbol corresponding to the device location, one or more facility symbols corresponding to respective facility locations of one or more facilities, and one or more vehicle symbols corresponding to the respective vehicle locations of the one or more vehicles, wherein marking the map comprises</p>	<p>The Lyft Accused Products infringe directly and/or indirectly by performing, inducing others to perform, and/or contributing to the performance of: marking the map with a plurality of symbols comprising: a participant symbol corresponding to the device location, one or more facility symbols corresponding to respective facility locations of one or more facilities, and one or more vehicle symbols corresponding to the respective vehicle locations of the one or more vehicles.</p> <p>This element is infringed literally, or in the alternative, under the doctrine of equivalents.</p> <p>The Lyft app performs this limitation because the Lyft app displays multiple symbols on its map, including a symbol for vehicles, facilities, businesses, landmarks, and other points of interest. For example, the map in the Lyft app on the passenger’s device comprises a blue dot (“participant symbol”) depicting the passenger’s current location. Further, the map also highlights locations including but not limited to airports, road names, parks, shops and railway stations (“facility symbol”). The location of the nearby drivers is highlighted on the map in the passenger’s device using vehicle icons.</p>

Exhibit C for US Patent No. 10,299,100 Against Lyft Accused Products

Claim 10,299,100	- Exemplary Supporting Evidence Regarding Lyft's Accused Products
	 <p>The screenshot displays the Lyft app interface. At the top, the map shows the route from Terminal 1, Arrivals to New York Marriott Marquis. A red box highlights two car icons on the map, with an arrow pointing to a text box labeled "Nearby Drivers' location". Another red box highlights a blue location pin at John F. Kennedy International Airport, with an arrow pointing to a text box labeled "Passenger's location". Below the map, three ride options are listed: "Lyft" (US\$64.81, 3:20 AM), "Lyft XL" (US\$81.65, 3:22 AM), and "Car seat" (US\$76.50, 3:34 AM). At the bottom, there is a "Select Lyft" button.</p>

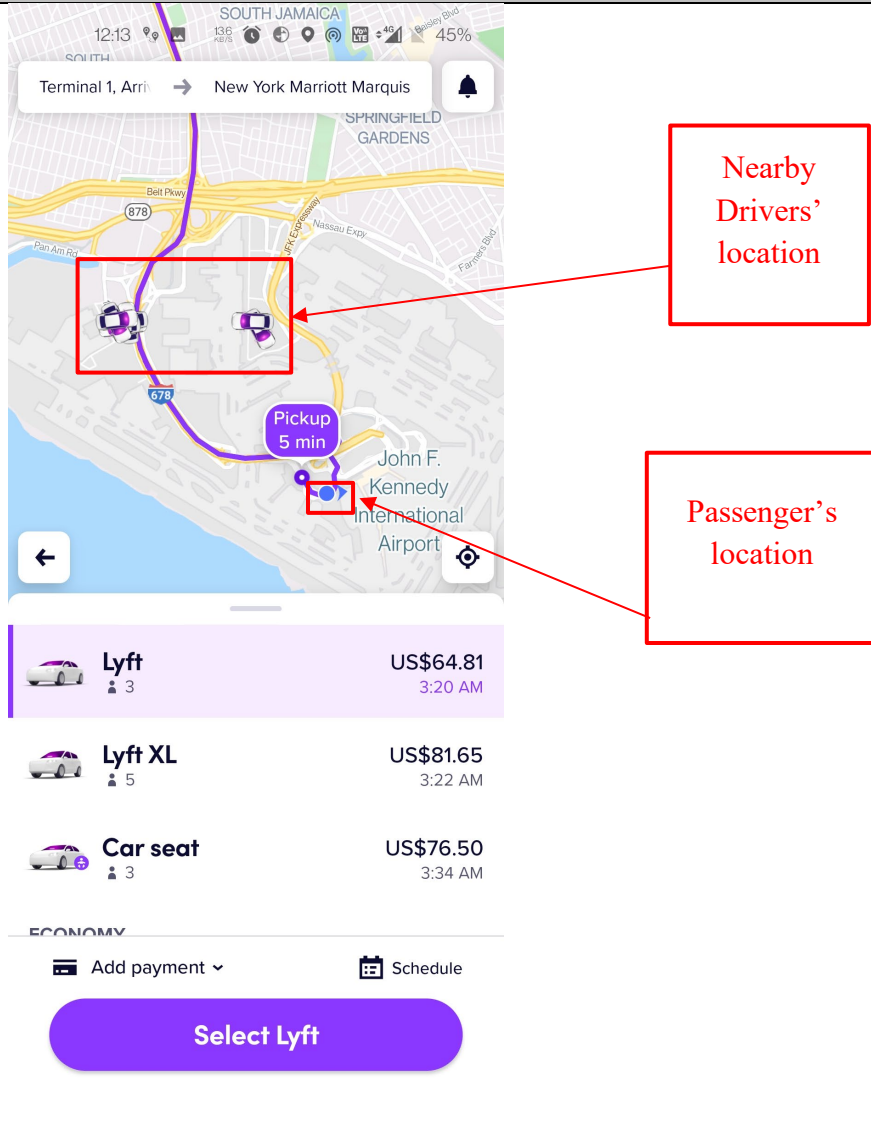
Exhibit C for US Patent No. 10,299,100 Against Lyft Accused Products

Claim 10,299,100	- Exemplary Supporting Evidence Regarding Lyft's Accused Products
	 <p>The screenshot displays a Google Maps interface. The map shows a portion of Queens, New York, with several locations highlighted by red rectangular boxes: Idlewild Park, North Woodmere Park, Inwood Country Club, and JFK International Airport. Below the map, there is a search bar with the text "TGIF, sumit" and a search button. Below the search bar, there are three suggested locations: "New York Marriott Marquis" at "1535 Broadway, New York" and "Work". At the bottom of the screen, there are icons for search, bicycle, train, and a person icon.</p>

Exhibit C for US Patent No. 10,299,100 Against Lyft Accused Products

Claim 10,299,100	- Exemplary Supporting Evidence Regarding Lyft's Accused Products
	Further, to the extent this element is performed at least in part by Lyft's software source code, AGIS reserves the right to supplement these contentions pursuant to production of such source code by Lyft and to the extent Defendant requires additional information in accordance with P.R. 3-1 and for any other reasons.
1[G]. wherein marking the map comprises: determining, based at least in part on the vehicle locations and the coordinate translation data, positions on the map corresponding to the vehicle locations, displaying the map on the display of the mobile device, and placing the vehicle symbols on the map at the determined positions corresponding to the vehicle locations.	<p>The Lyft Accused Products infringe directly and/or indirectly by performing, inducing others to perform, and/or contributing to the performance of: wherein marking the map comprises: determining, based at least in part on the vehicle locations and the coordinate translation data, positions on the map corresponding to the vehicle locations, displaying the map on the display of the mobile device, and placing the vehicle symbols on the map at the determined positions corresponding to the vehicle locations.</p> <p>This element is infringed literally, or in the alternative, under the doctrine of equivalents.</p> <p>The Lyft app performs this limitation because it determines where to place symbols on its map and places those symbols based on the data received from the server. For example, the Lyft server determines the location coordinates of the nearby drivers with respect to the passenger and transmits them to the Lyft app on the passenger's device. The location coordinates of the nearby drivers are loaded on the map and is displayed on the passenger's device. Each vehicle on the map indicates the position of a nearby driver.</p>

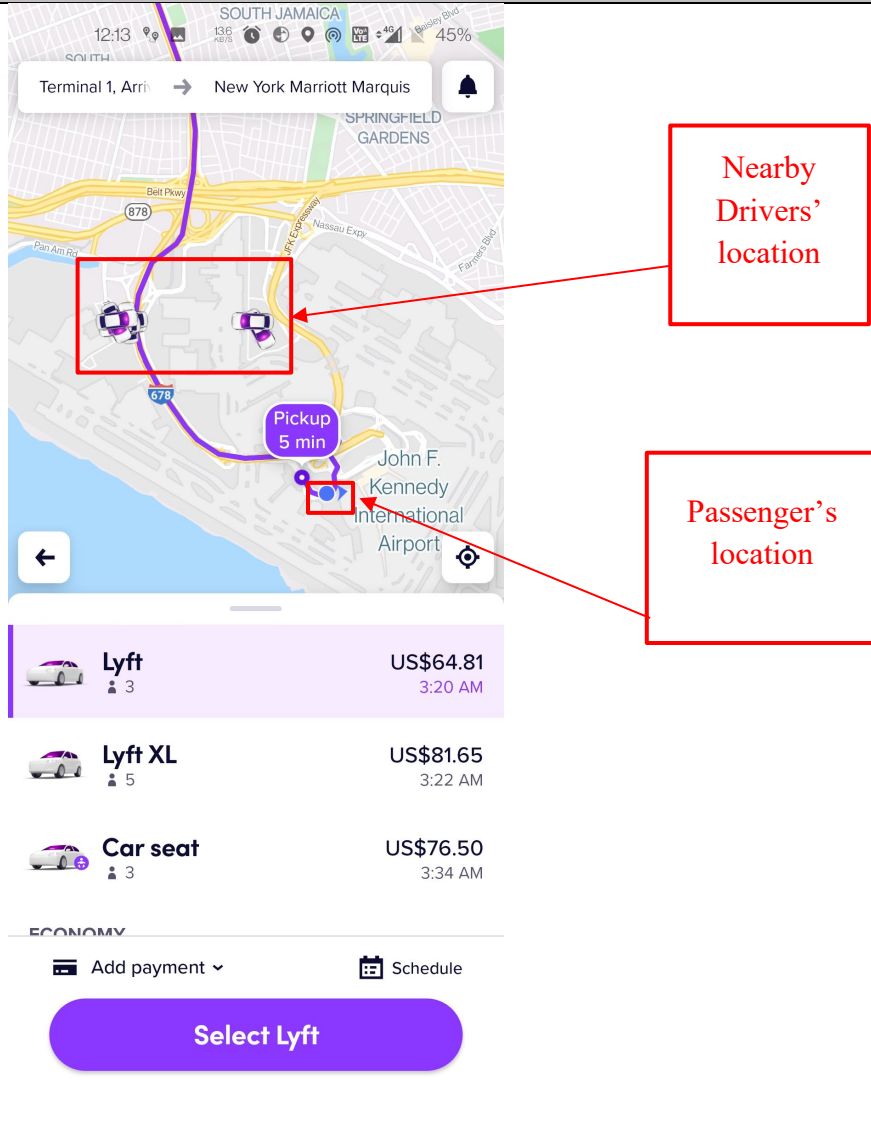
Exhibit C for US Patent No. 10,299,100 Against Lyft Accused Products

Claim 10,299,100	- Exemplary Supporting Evidence Regarding Lyft's Accused Products												
	 <p>The screenshot shows a Lyft app interface. At the top, the route is from Terminal 1, Arrivals to New York Marriott Marquis. The map displays the area around John F. Kennedy International Airport. Two car icons representing drivers are highlighted with a red box and labeled 'Nearby Drivers' location'. A blue dot representing the passenger's location is highlighted with another red box and labeled 'Passenger's location'. Below the map, three ride options are listed: 'Lyft' (US\$64.81, 3:20 AM), 'Lyft XL' (US\$81.65, 3:22 AM), and 'Car seat' (US\$76.50, 3:34 AM). A 'Select Lyft' button is at the bottom.</p> <table border="1" data-bbox="462 876 955 1153"><thead><tr><th>Option</th><th>Price</th><th>ETA</th></tr></thead><tbody><tr><td>Lyft</td><td>US\$64.81</td><td>3:20 AM</td></tr><tr><td>Lyft XL</td><td>US\$81.65</td><td>3:22 AM</td></tr><tr><td>Car seat</td><td>US\$76.50</td><td>3:34 AM</td></tr></tbody></table>	Option	Price	ETA	Lyft	US\$64.81	3:20 AM	Lyft XL	US\$81.65	3:22 AM	Car seat	US\$76.50	3:34 AM
Option	Price	ETA											
Lyft	US\$64.81	3:20 AM											
Lyft XL	US\$81.65	3:22 AM											
Car seat	US\$76.50	3:34 AM											

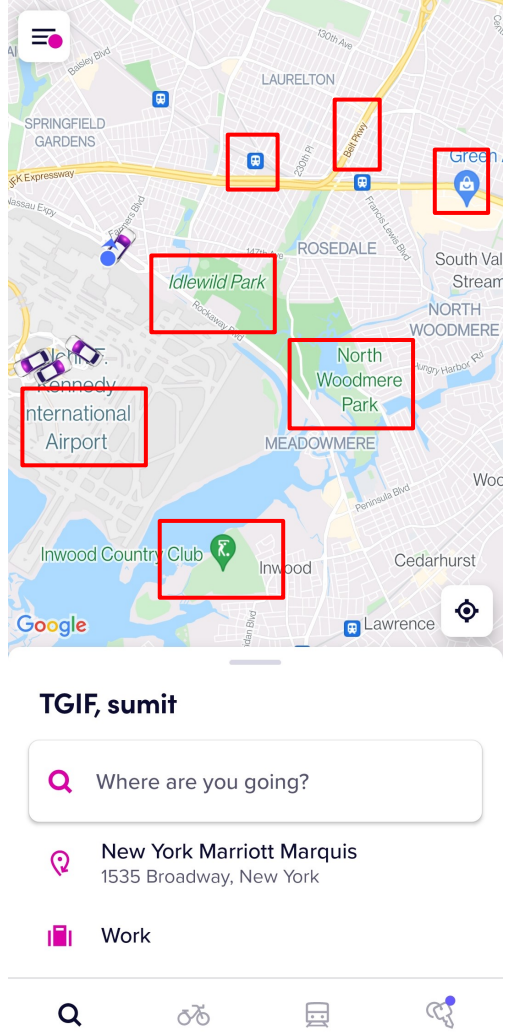
Exhibit C for US Patent No. 10,299,100 Against Lyft Accused Products

Claim 10,299,100	- Exemplary Supporting Evidence Regarding Lyft's Accused Products
	<p>Further, to the extent this element is performed at least in part by Lyft's software source code, AGIS reserves the right to supplement these contentions pursuant to production of such source code by Lyft and to the extent Defendant requires additional information in accordance with P.R. 3-1 and for any other reasons.</p>
<p>1[H]. responsive to user selection of a portion of the display corresponding to a position on the map, identifying a selected facility symbol based on the selected position, comprising: initiating a search of a set of symbols including the facility symbols for a symbol located nearest to the selected position and, based on a result of the search, identifying the selected facility symbol as the symbol located</p>	<p>The Lyft Accused Products infringe directly and/or indirectly by performing, inducing others to perform, and/or contributing to the performance of: responsive to user selection of a portion of the display corresponding to a position on the map, identifying a selected facility symbol based on the selected position, comprising: initiating a search of a set of symbols including the facility symbols for a symbol located nearest to the selected position and, based on a result of the search, identifying the selected facility symbol as the symbol located nearest to the selected position.</p> <p>This element is infringed literally, or in the alternative, under the doctrine of equivalents.</p> <p>The Lyft app performs this limitation because it receives user input data regarding pickups, stops or destinations entered by a user and those pickups, stops or destinations correspond to geographical locations on a map. For example, the Lyft passenger uses the Lyft app for riders to select a pickup location and a destination location. The Lyft passenger can add entities of interest and select one or more entities of interest as a pickup or destination. The Lyft passenger can choose the pickup/stop/destination location by entering an address/location/shortcut or by choosing it on a map which will add/enter a symbol on the map and the passenger can change the location of the added/enter symbol to specify the location of the added/entered symbol as a pickup/stop/destination. Each of these methods will cause a symbol corresponding to the pickup/stop/destination to be added/entered on the map at the corresponding location. When the passenger completes this process, data associated with the added/entered symbol as a pickup/stop/destination is communicated to the Lyft server(s). Adding/entering the symbol for a pickup/stop/destination can occur before or during a ride. On information and belief, when a user enters an address, place, or shortcut, the Lyft app will search for and place a symbol at the nearest position to the address, place or shortcut.</p> <p>The Lyft app performs this limitation because it receives user input identifying a destination/stop. For example, when a passenger is booking the ride, Lyft provides a set location on the map providing an option for which the passenger selects the position on a map. For example, the passenger selects the position for a pickup such as anairport, in response to which Lyft initiates identifying the selected position and searching for all the symbols</p>

Exhibit C for US Patent No. 10,299,100 Against Lyft Accused Products

Claim 10,299,100	- Exemplary Supporting Evidence Regarding Lyft’s Accused Products
nearest to the selected position	located nearby to the airport and identifying them (including but not limited to Terminal 1, Terminal 2 and Terminal 4).

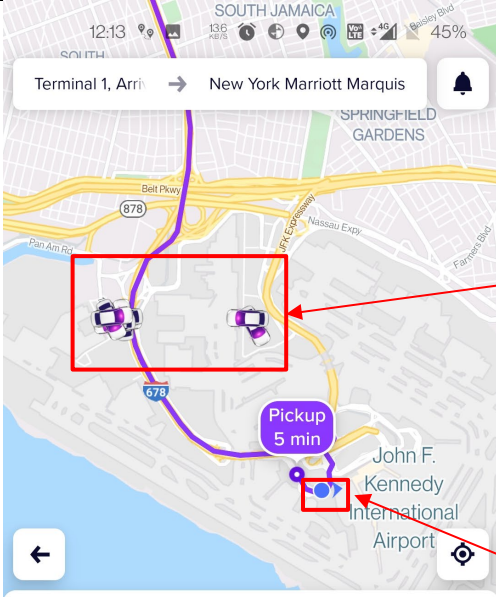
Exhibit C for US Patent No. 10,299,100 Against Lyft Accused Products

Claim 10,299,100	- Exemplary Supporting Evidence Regarding Lyft's Accused Products
	 <p>The screenshot displays the Lyft app's 'Trip' configuration screen. At the top, there is a 'Change rider' dropdown menu. Below it, a 'Start' location field is followed by a '+' icon to add more locations. A 'Destination' field is positioned below the 'Start' field. Further down, there are four location suggestions: 'Work', 'Home', 'Current location', and 'Set on map'. The 'Set on map' option is highlighted with a red rectangular box. At the bottom of the screen, there is a navigation bar with four icons: a magnifying glass (search), a bicycle (bike share), a car icon (ride share), and a person icon (profile).</p>

Exhibit C for US Patent No. 10,299,100 Against Lyft Accused Products

Claim 10,299,100	- Exemplary Supporting Evidence Regarding Lyft's Accused Products
	 <p>Terminal 2, Arrivals, Pick Up A-B</p> <p>Drag map or tap to edit pickup spot</p> <p>John F. Kennedy Int'l Airport</p> <p>Head down to the Arrivals curb and follow signs to Passenger Pick Up</p> <ul style="list-style-type: none">Terminal 1, ArrivalsTerminal 2, Arrivals Pick Up A-BTerminal 4, Arrivals <p>Set pickup</p>

Exhibit C for US Patent No. 10,299,100 Against Lyft Accused Products

Claim 10,299,100	- Exemplary Supporting Evidence Regarding Lyft's Accused Products												
	 <p>The screenshot displays a Lyft ride request. The origin is 'Terminal 1, Arrivals' and the destination is 'New York Marriott Marquis'. The map shows the passenger's location at JFK Airport and several nearby drivers' locations. A 'Pickup 5 min' timer is visible. Below the map are three ride options:</p> <table border="1"><thead><tr><th>Ride Type</th><th>Price</th><th>ETA</th></tr></thead><tbody><tr><td>Lyft</td><td>US\$64.81</td><td>3:20 AM</td></tr><tr><td>Lyft XL</td><td>US\$81.65</td><td>3:22 AM</td></tr><tr><td>Car seat</td><td>US\$76.50</td><td>3:34 AM</td></tr></tbody></table> <p>At the bottom, there is a 'Select Lyft' button.</p>	Ride Type	Price	ETA	Lyft	US\$64.81	3:20 AM	Lyft XL	US\$81.65	3:22 AM	Car seat	US\$76.50	3:34 AM
Ride Type	Price	ETA											
Lyft	US\$64.81	3:20 AM											
Lyft XL	US\$81.65	3:22 AM											
Car seat	US\$76.50	3:34 AM											

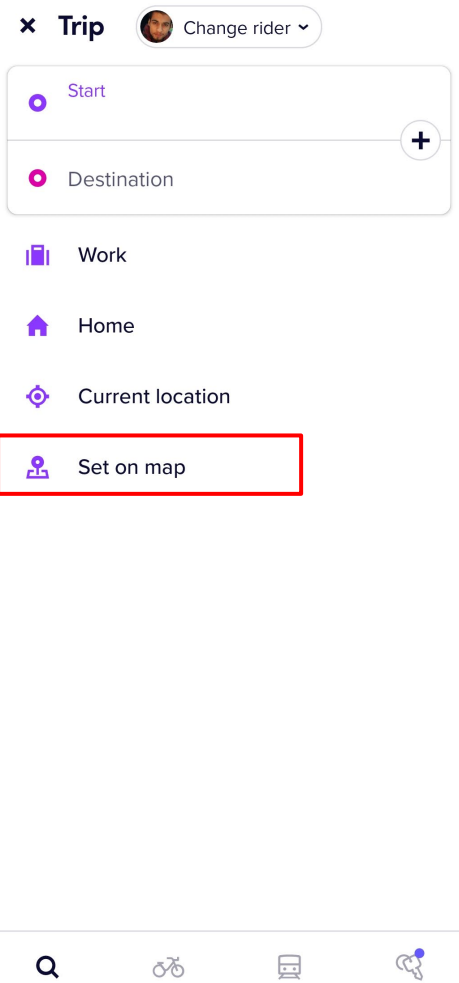
Exhibit C for US Patent No. 10,299,100 Against Lyft Accused Products

Claim 10,299,100	- Exemplary Supporting Evidence Regarding Lyft’s Accused Products
	<p>Further, to the extent this element is performed at least in part by Lyft's software source code, AGIS reserves the right to supplement these contentions pursuant to production of such source code by Lyft and to the extent Defendant requires additional information in accordance with P.R. 3-1 and for any other reasons.</p>
<p>1[I]. responsive to user input, transmitting first information to a first vehicle of the one or more vehicles; and</p>	<p>The Lyft Accused Products infringe directly and/or indirectly by performing, inducing others to perform, and/or contributing to the performance of: responsive to user input, transmitting first information to a first vehicle of the one or more vehicles.</p> <p>This element is infringed literally, or in the alternative, under the doctrine of equivalents.</p> <p>The Lyft app sends information regarding the pickup/stops/destination and/or information about the passenger and this information is communicated to a driver. For example, when a passenger requests a ride by providing a pickup location (current location of passenger or any specific location) and a destination address, the request ride message comprising the pickup location and the passenger’s name and photo (“first information”) is communicated to nearby drivers to find the ride.</p>

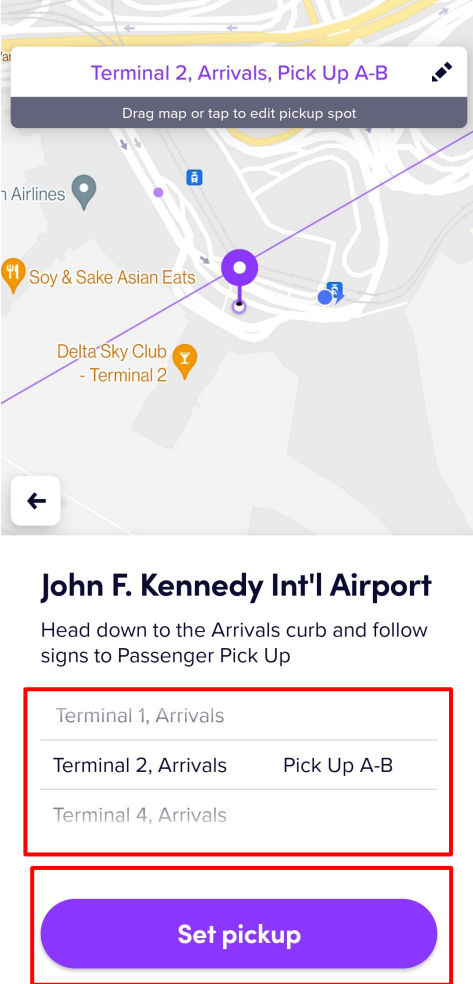
Exhibit C for US Patent No. 10,299,100 Against Lyft Accused Products

Claim 10,299,100	- Exemplary Supporting Evidence Regarding Lyft's Accused Products
	 <p>https://www.youtube.com/watch?v=j0RDMLcmOgU at 3:49</p>

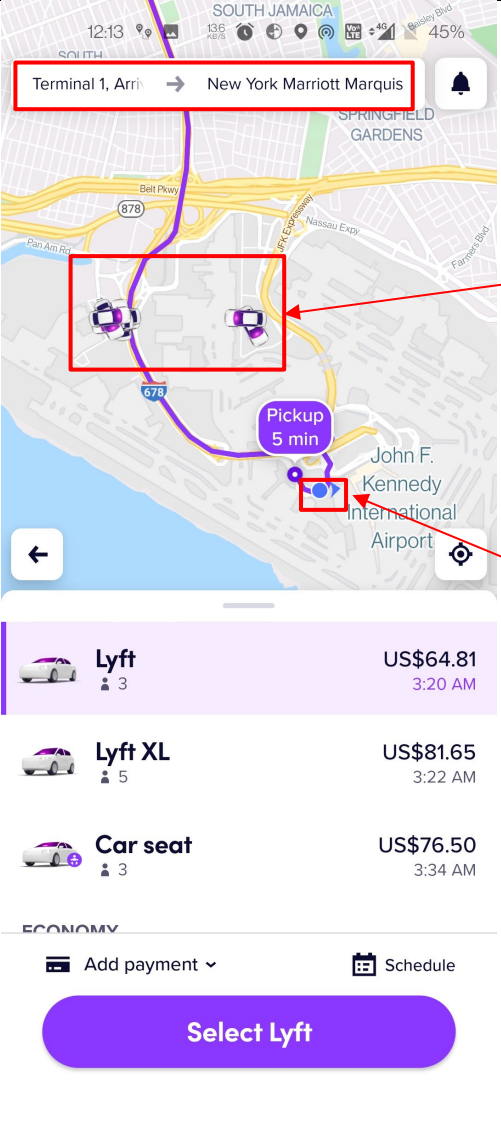
Exhibit C for US Patent No. 10,299,100 Against Lyft Accused Products

Claim 10,299,100	- Exemplary Supporting Evidence Regarding Lyft’s Accused Products
	 <p>https://www.youtube.com/watch?v=jVUy9poJDng at 10:24, Annotated</p> <p>Further, to the extent this element is performed at least in part by Lyft's software source code, AGIS reserves the right to supplement these contentions pursuant to production of such source code by Lyft and to the extent Defendant requires additional information in accordance with P.R. 3-1 and for any other reasons.</p>
<p>1[J]. receiving second information corresponding to the first vehicle and displaying the received second information on</p>	<p>The Lyft Accused Products infringe directly and/or indirectly by performing, inducing others to perform, and/or contributing to the performance of: receiving second information corresponding to the first vehicle and displaying the received second information on the display of the mobile device.</p> <p>This element is infringed literally, or in the alternative, under the doctrine of equivalents.</p> <p>The Lyft app for the rider can receive and display information about the driver/vehicle. For example, when a driver accepts a ride request from a passenger, the passenger via the Lyft app perceives the driver’s information (such as name, location, vehicle model and vehicle number).</p>

Exhibit C for US Patent No. 10,299,100 Against Lyft Accused Products

<p>Claim 10,299,100</p>	<p>- Exemplary Supporting Evidence Regarding Lyft’s Accused Products</p>
<p>the display of the mobile device</p>	 <p>https://www.youtube.com/watch?v=j0RDMLcmOgU at 5:07</p> <p>Further, to the extent this element is performed at least in part by Lyft's software source code, AGIS reserves the right to supplement these contentions pursuant to production of such source code by Lyft and to the extent Defendant requires additional information in accordance with P.R. 3-1 and for any other reasons.</p>
<p>1[K]. wherein the mobile device does not have access to a phone number</p>	<p>The Lyft Accused Products infringe directly and/or indirectly by performing, inducing others to perform, and/or contributing to the performance of: wherein the mobile device does not have access to a phone number associated with a computing device corresponding to the first vehicle, an Internet Protocol (IP) address associated with the computing device corresponding to the first vehicle, and an e-mail address associated with the computing device corresponding to the first vehicle.</p>

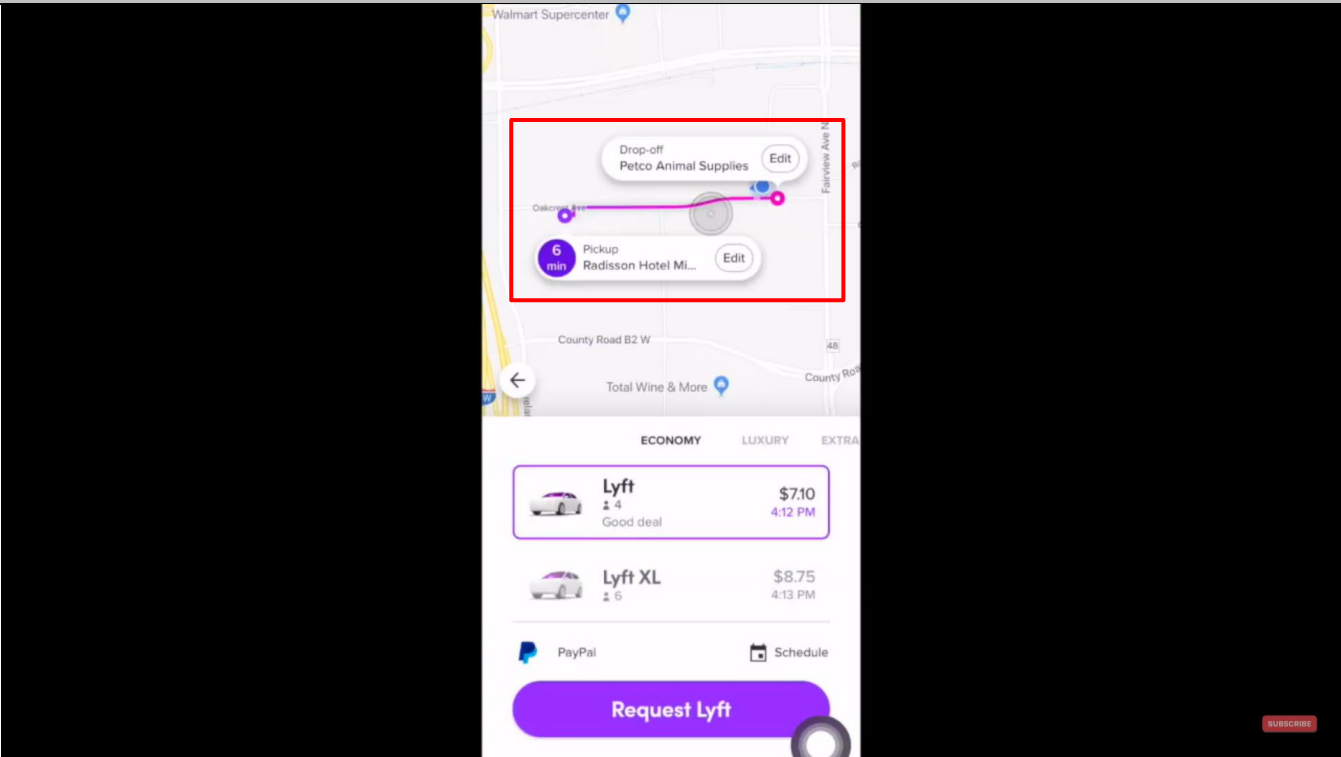
Exhibit C for US Patent No. 10,299,100 Against Lyft Accused Products

Claim 10,299,100	- Exemplary Supporting Evidence Regarding Lyft’s Accused Products
<p>associated with a computing device corresponding to the first vehicle, an Internet Protocol (IP) address associated with the computing device corresponding to the first vehicle, and an e-mail address associated with the computing device corresponding to the first vehicle.</p>	<p>This element is infringed literally, or in the alternative, under the doctrine of equivalents.</p> <p>The Lyft app for the rider does not have access to the driver’s phone number associated with the driver’s account. The Lyft app for the rider also does not have access to the driver’s email address or driver’s IP address associated with the driver’s device through the Lyft app. For example, the passenger does not have any information of the driver (such as email address, IP address, and contact number) and this information is not available through the Lyft app for the rider.</p>

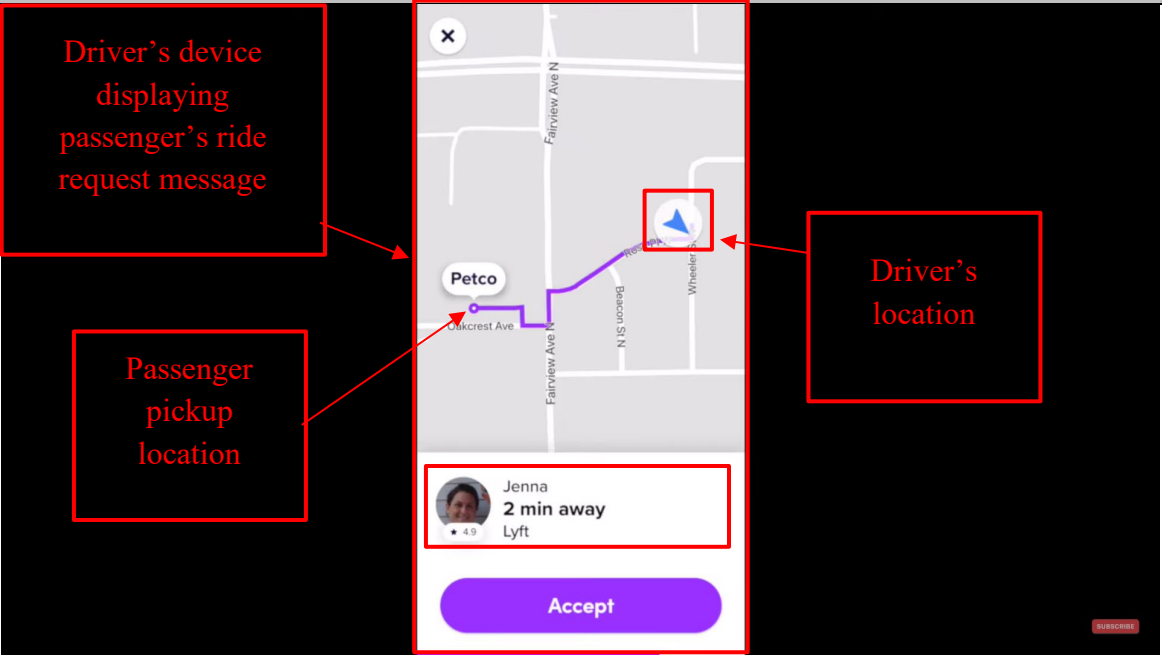
Exhibit C for US Patent No. 10,299,100 Against Lyft Accused Products

Claim 10,299,100	- Exemplary Supporting Evidence Regarding Lyft's Accused Products
	 <p>The screenshot displays the Lyft app interface. At the top, the map shows the route from Terminal 1, Arrivals to New York Marriott Marquis. Two car icons representing nearby drivers are highlighted with a red box and labeled "Nearby Drivers' location". A blue dot representing the passenger's location is highlighted with another red box and labeled "Passenger's location". Below the map, three ride options are listed: "Lyft" (US\$64.81, 3:20 AM), "Lyft XL" (US\$81.65, 3:22 AM), and "Car seat" (US\$76.50, 3:34 AM). At the bottom, there is a "Select Lyft" button.</p>

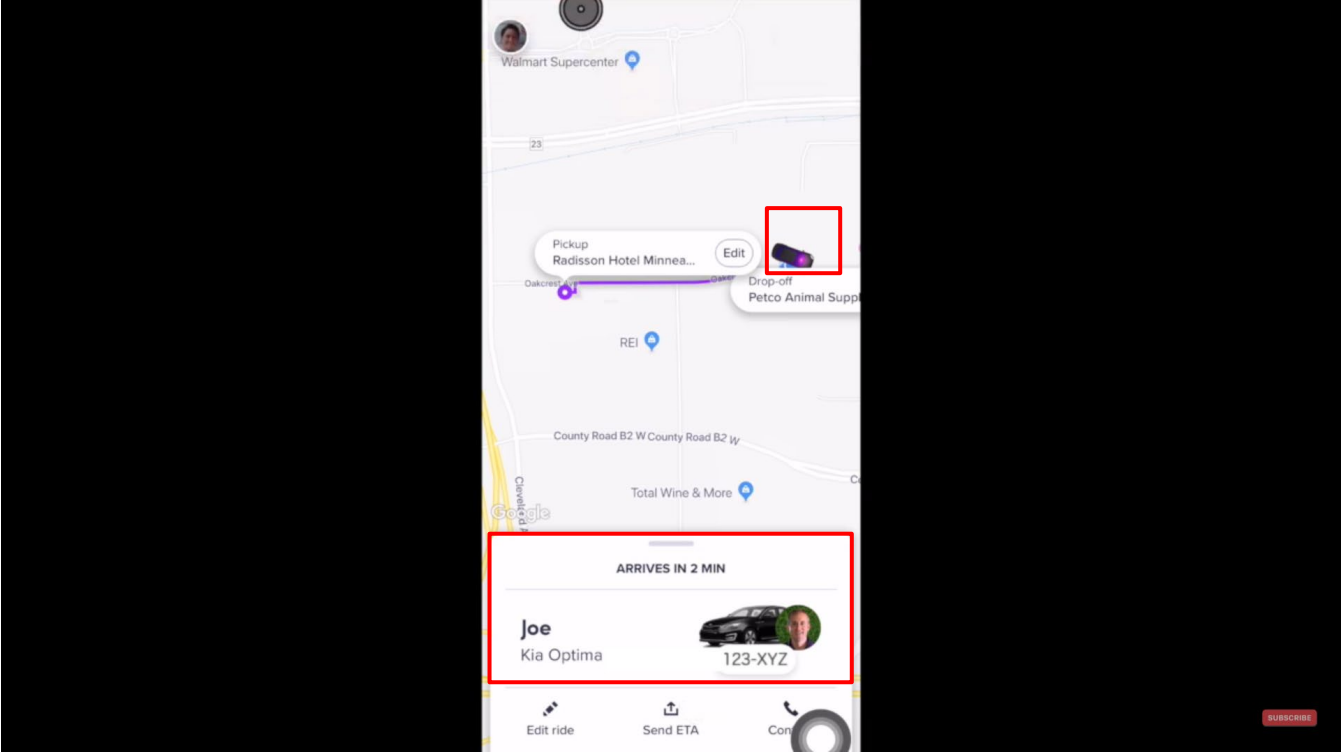
Exhibit C for US Patent No. 10,299,100 Against Lyft Accused Products

Claim 10,299,100	- Exemplary Supporting Evidence Regarding Lyft’s Accused Products
	 <p>https://www.youtube.com/watch?v=j0RDMLcmOgU at 3:49</p> <p>Further, to the extent this element is performed at least in part by Lyft's software source code, AGIS reserves the right to supplement these contentions pursuant to production of such source code by Lyft and to the extent Defendant requires additional information in accordance with P.R. 3-1 and for any other reasons.</p>
<p>2. The method of claim 1, wherein: determining the device location comprises</p>	<p>The Lyft Accused Products infringe directly and/or indirectly by performing, inducing others to perform, and/or contributing to the performance of: The method of claim 1, wherein: determining the device location comprises obtaining geographical coordinates representing the geographical location of the mobile device from a global positioning system (GPS) receiver located within the mobile device; and marking the map further comprises</p>

Exhibit C for US Patent No. 10,299,100 Against Lyft Accused Products

Claim 10,299,100	- Exemplary Supporting Evidence Regarding Lyft’s Accused Products
<p>obtaining geographical coordinates representing the geographical location of the mobile device from a global positioning system (GPS) receiver located within the mobile device; and marking the map further comprises placing the participant symbol at a position on the map corresponding to the geographical coordinates representing the geographical location of the mobile device.</p>	<p>placing the participant symbol at a position on the map corresponding to the geographical coordinates representing the geographical location of the mobile device.</p> <p>This element is infringed literally, or in the alternative, under the doctrine of equivalents.</p> <p>See claim 1. Further, the Lyft app meets this limitation because it can receive GPS data to determine a location and use that location to place a symbol at the location on the map. On information and belief, the location is provided in coordinates.</p>

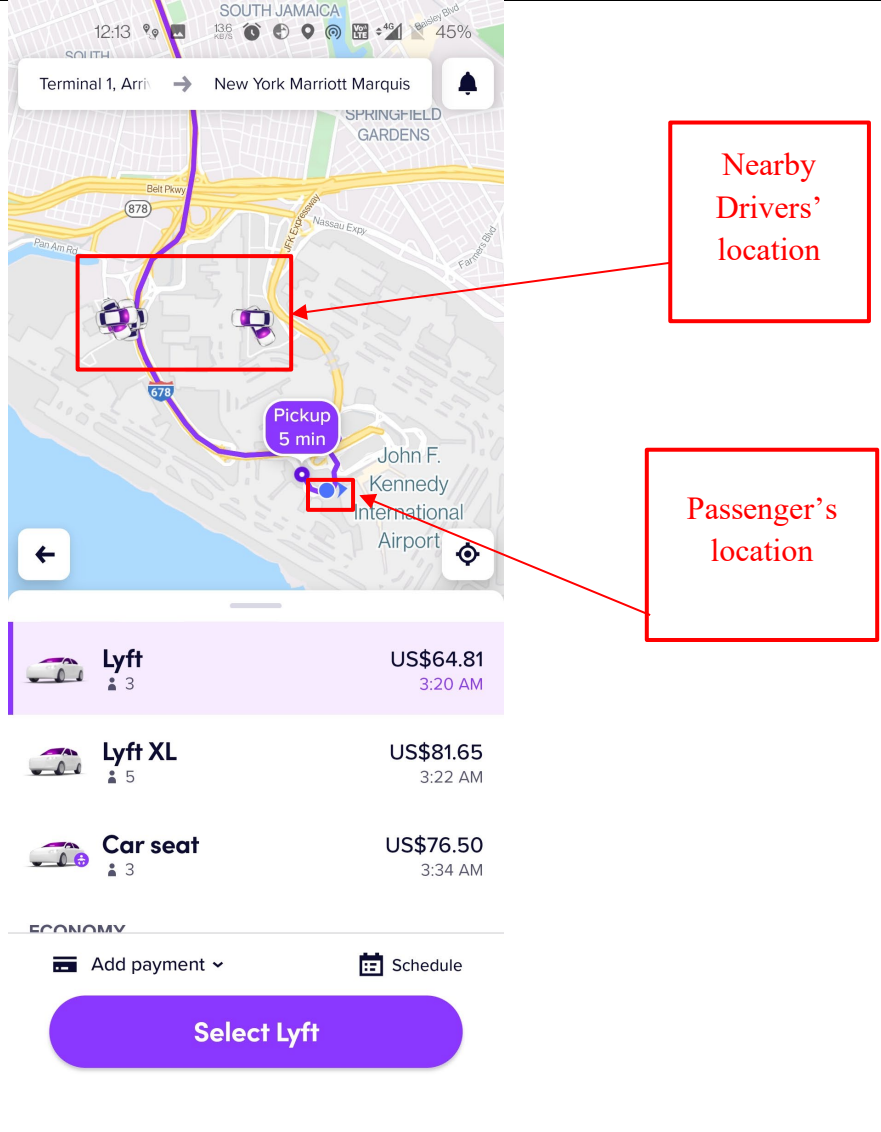
Exhibit C for US Patent No. 10,299,100 Against Lyft Accused Products

Claim 10,299,100	- Exemplary Supporting Evidence Regarding Lyft's Accused Products
	 <p>The screenshot shows a Lyft app interface. At the top, the route is from Terminal 1, Arrivals to New York Marriott Marquis. The map displays the area around John F. Kennedy International Airport. Two car icons representing nearby drivers are enclosed in a red box, with an arrow pointing to a text box labeled "Nearby Drivers' location". A blue dot representing the passenger's location is also enclosed in a red box, with an arrow pointing to a text box labeled "Passenger's location". Below the map, three ride options are listed: Lyft (US\$64.81, 3:20 AM), Lyft XL (US\$81.65, 3:22 AM), and Car seat (US\$76.50, 3:34 AM). At the bottom, there are options for "Add payment" and "Schedule", and a large purple "Select Lyft" button.</p>

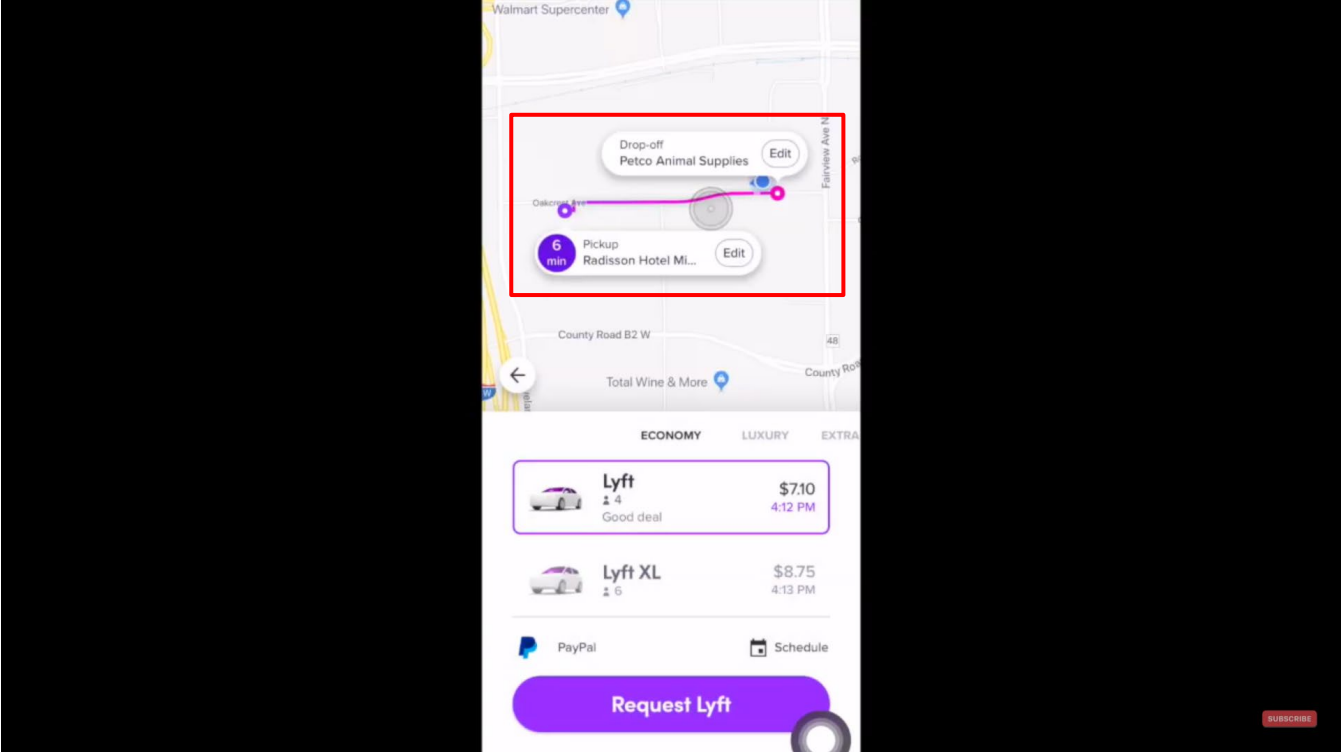
Exhibit C for US Patent No. 10,299,100 Against Lyft Accused Products

Claim 10,299,100	- Exemplary Supporting Evidence Regarding Lyft's Accused Products
	<p data-bbox="472 305 1633 391">You must have seen that every Android and iOS device in today's age comes with GPS right inside it. This is one feature that will be there in every smartphone no matter what the price of that device might be. And that is because of the fact that GPS is the most basic yet most useful feature on every smartphone.</p> <p data-bbox="472 532 1661 805">Just for information, the GPS stands for Global Positioning System and it provides accurate geolocation and time information for every equipment that is equipped with a GPS receiver. Now, the best example of using GPS is with services such as Google Maps, Apple Maps, and others where you can see where exactly you are right now on the Map. This is thanks to the GPS receiver which sends a signal to the GPS satellite.</p> <p data-bbox="472 816 1413 849">https://www.cashify.in/how-to-turn-off-gps-on-any-android-or-ios-device</p> <p data-bbox="464 889 1892 992">Further, to the extent this element is performed at least in part by Lyft's software source code, AGIS reserves the right to supplement these contentions pursuant to production of such source code by Lyft and to the extent Defendant requires additional information in accordance with P.R. 3-1 and for any other reasons.</p>
3. The method of claim 1, wherein transmitting the first information to the first vehicle comprises sending data comprising at least one of the identifier and the	<p data-bbox="464 1003 1892 1105">The Lyft Accused Products infringe directly and/or indirectly by performing, inducing others to perform, and/or contributing to the performance of: transmitting the first information to the first vehicle comprises sending data comprising at least one of the identifier and the device location to a server.</p> <p data-bbox="464 1146 1598 1179">This element is infringed literally, or in the alternative, under the doctrine of equivalents.</p> <p data-bbox="464 1219 1892 1292">See claim 1. In addition, the Lyft app meets this limitation because it communicates the account/identity information and location to the Lyft server. This can occur during the request or during the ride.</p>

Exhibit C for US Patent No. 10,299,100 Against Lyft Accused Products

Claim 10,299,100	- Exemplary Supporting Evidence Regarding Lyft's Accused Products
device location to a server.	 <p>The screenshot shows the Lyft mobile application interface during a 'Drop-off' process. At the top, there are 'Cancel' and 'Drop-off' buttons. Below them, the 'Start' field is highlighted with a red rectangular box and contains the text 'Current location'. The 'End' field is labeled 'Search destination' and has a plus sign to its right. A list of suggested drop-off locations is displayed below, each with a location pin icon and text: 'Radisson Hotel Minneapolis/St. Paul N...', 'Target Field Station', 'Historic John P Furber Farm', 'Sheraton St. Paul Woodbury Hotel', 'Rosedale Center', 'Home', and 'Work'. A 'SUBSCRIBE' button is visible in the bottom right corner of the app interface.</p> <p>https://www.youtube.com/watch?v=j0RDMLcmOgU at 3:27</p>

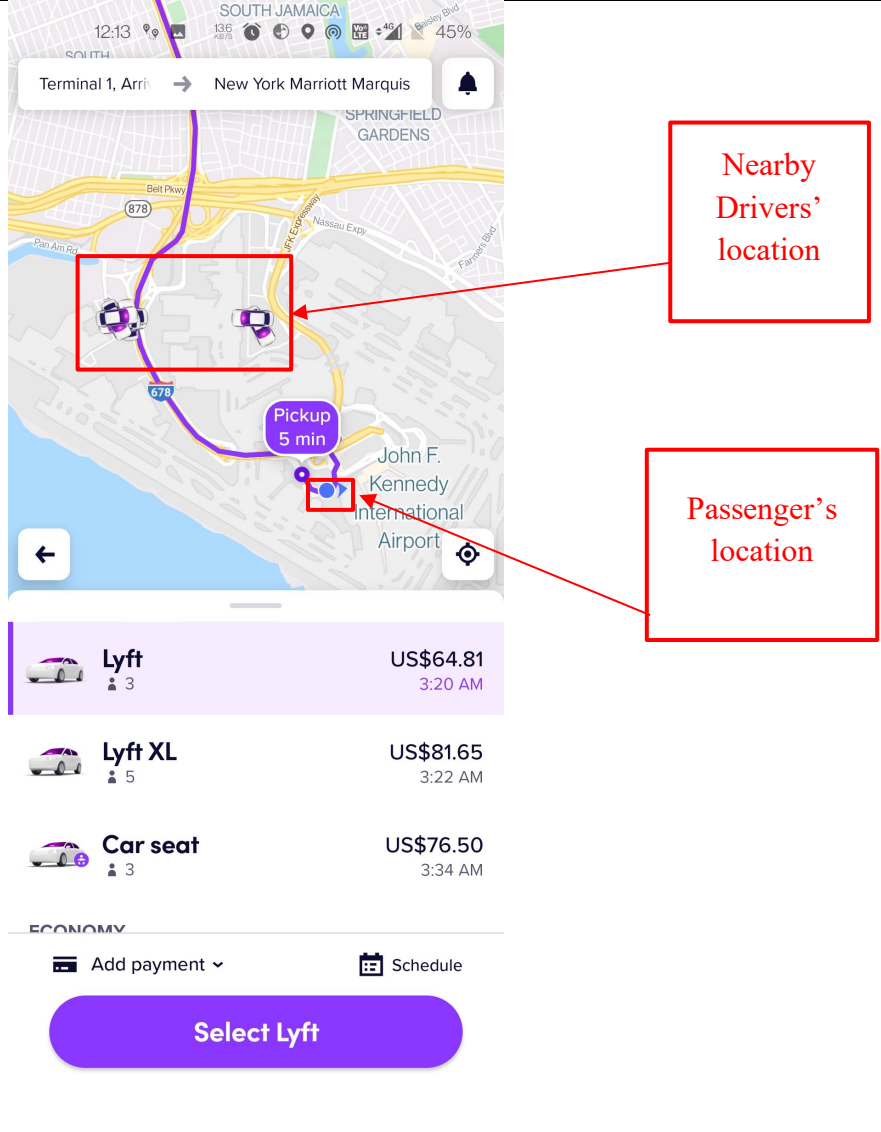
Exhibit C for US Patent No. 10,299,100 Against Lyft Accused Products

Claim 10,299,100	- Exemplary Supporting Evidence Regarding Lyft's Accused Products
	 <p>https://www.youtube.com/watch?v=j0RDMLcmOgU at 3:49</p>

Exhibit C for US Patent No. 10,299,100 Against Lyft Accused Products

Claim 10,299,100	- Exemplary Supporting Evidence Regarding Lyft’s Accused Products
	 <p>Driver’s device displaying passenger’s ride request message</p> <p>Passenger’s current location (when pickup location is set to current location)</p> <p>Driver’s current location</p> <p>https://www.youtube.com/watch?v=jVUy9poJDng at 10:24, Annotated</p> <p>Further, to the extent this element is performed at least in part by Lyft's software source code, AGIS reserves the right to supplement these contentions pursuant to production of such source code by Lyft and to the extent Defendant requires additional information in accordance with P.R. 3-1 and for any other reasons.</p>
<p>4. The method of claim 1, further comprising updating the map by updating at least one item selected from the group consisting of: a position of</p>	<p>The Lyft Accused Products infringe directly and/or indirectly by performing, inducing others to perform, and/or contributing to the performance of: updating the map by updating at least one item selected from the group consisting of: a position of the participant symbol, positions of the one or more vehicle symbols, and a portion of the map displayed on the display of the mobile device.</p> <p>This element is infringed literally, or in the alternative, under the doctrine of equivalents.</p> <p>See claim 1. In addition, the Lyft app meets this limitation because it can update the location of the rider or participant and the app can update the map. The map is updated with updated locations or new areas. For example,</p>

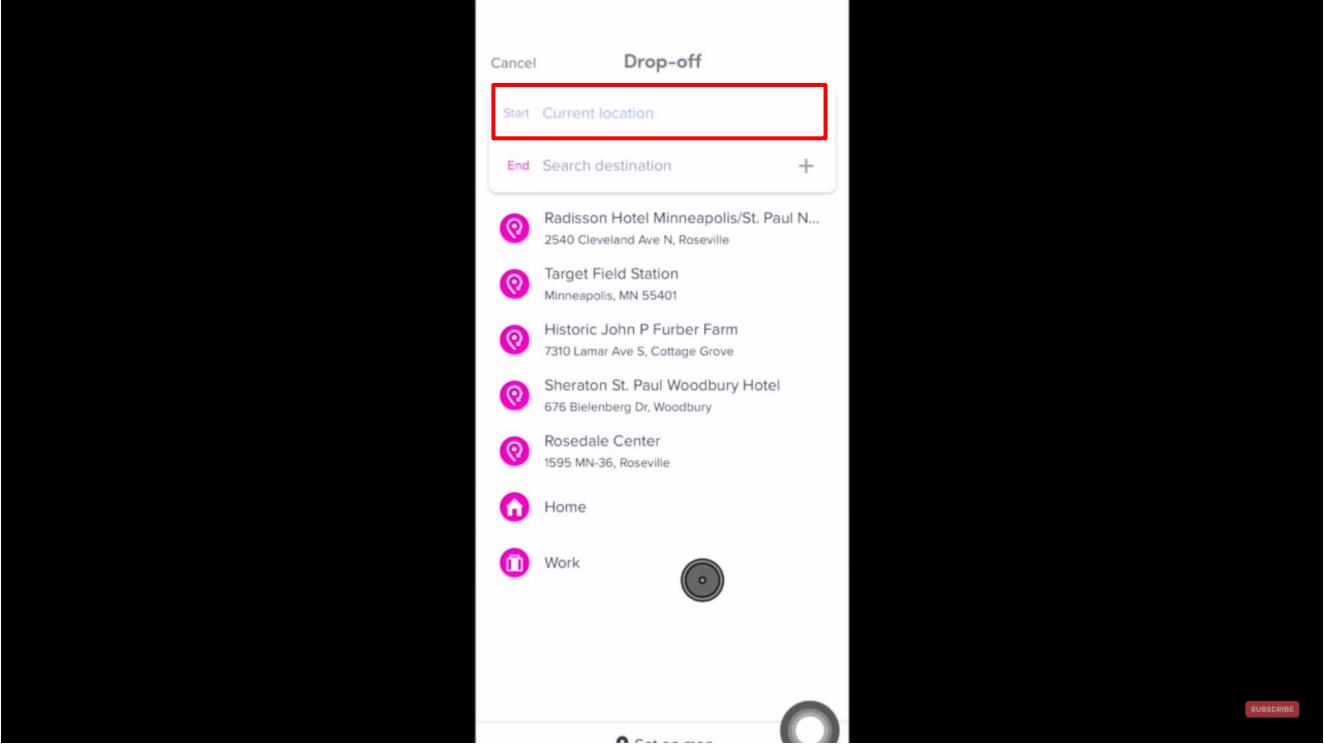
Exhibit C for US Patent No. 10,299,100 Against Lyft Accused Products

Claim 10,299,100	- Exemplary Supporting Evidence Regarding Lyft's Accused Products
the participant symbol, positions of the one or more vehicle symbols, and a portion of the map displayed on the display of the mobile device.	the Lyft app updates the map with the passenger's current location coordinates and the nearby drivers' location corresponding to their respective location coordinates. On information and belief, the map can be updated in response to interactions with the map, change of time/orientation, and/or user input or automatic input to the Lyft app from the user or Lyft server.

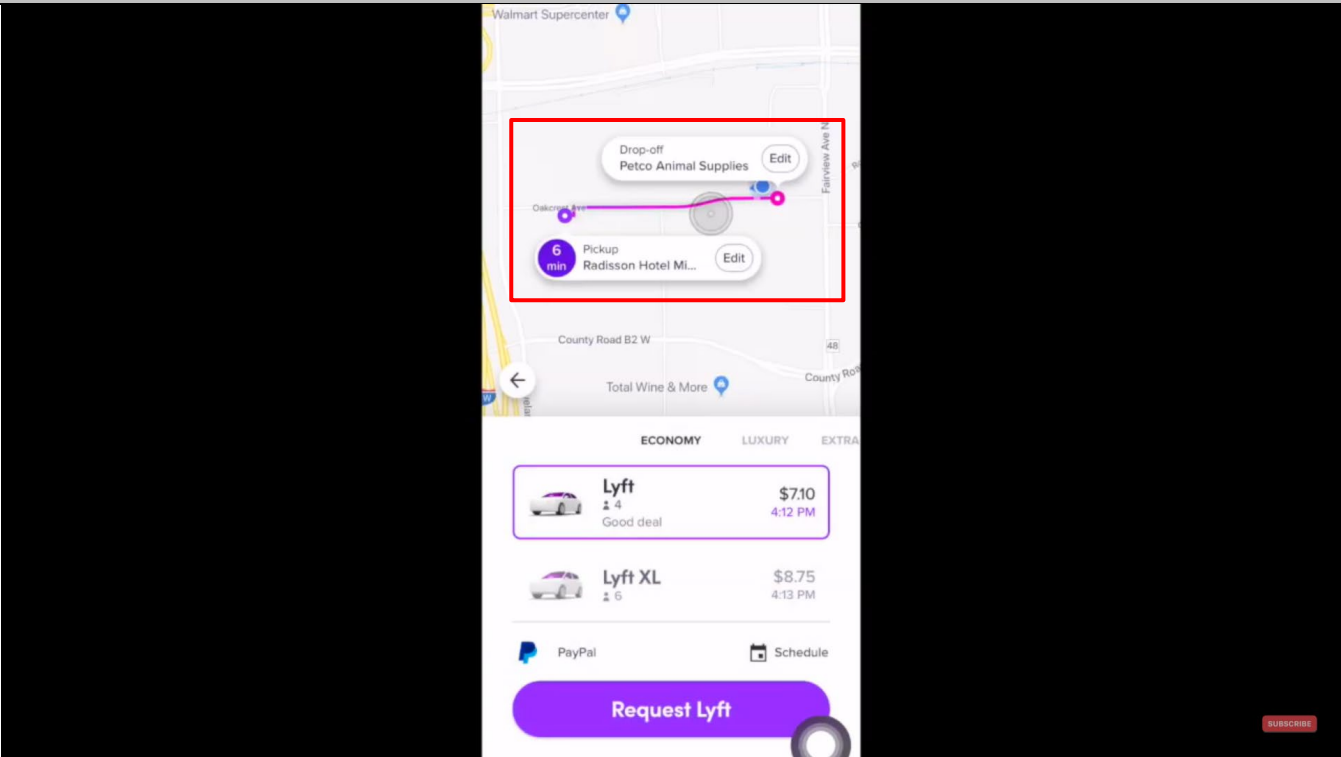
Exhibit C for US Patent No. 10,299,100 Against Lyft Accused Products



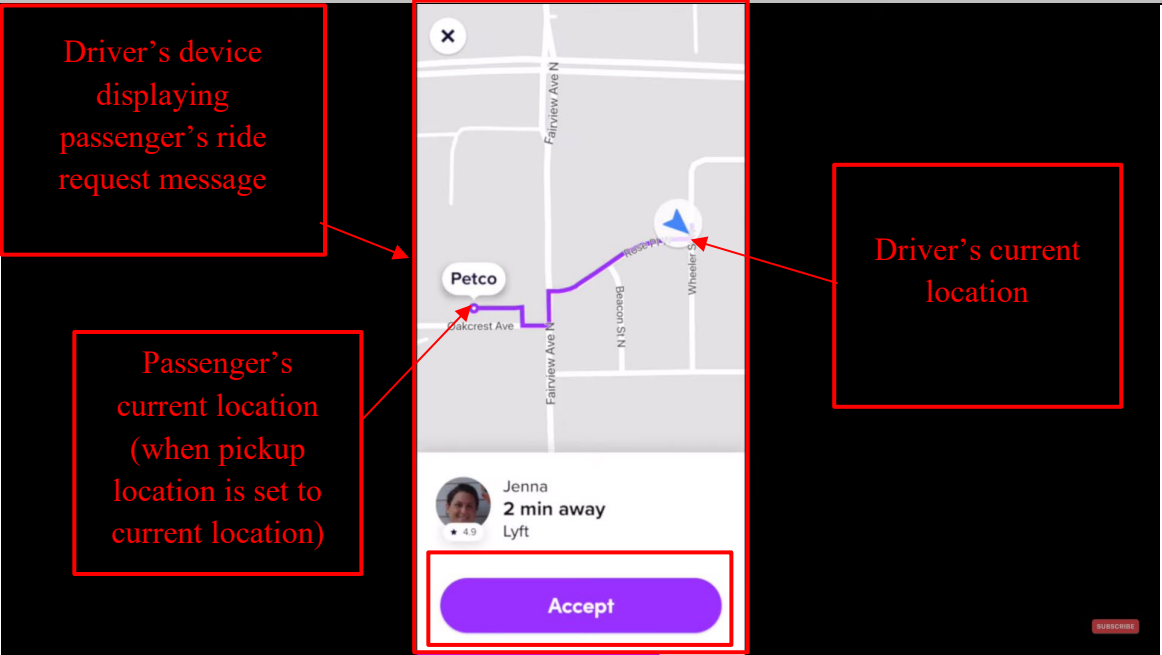





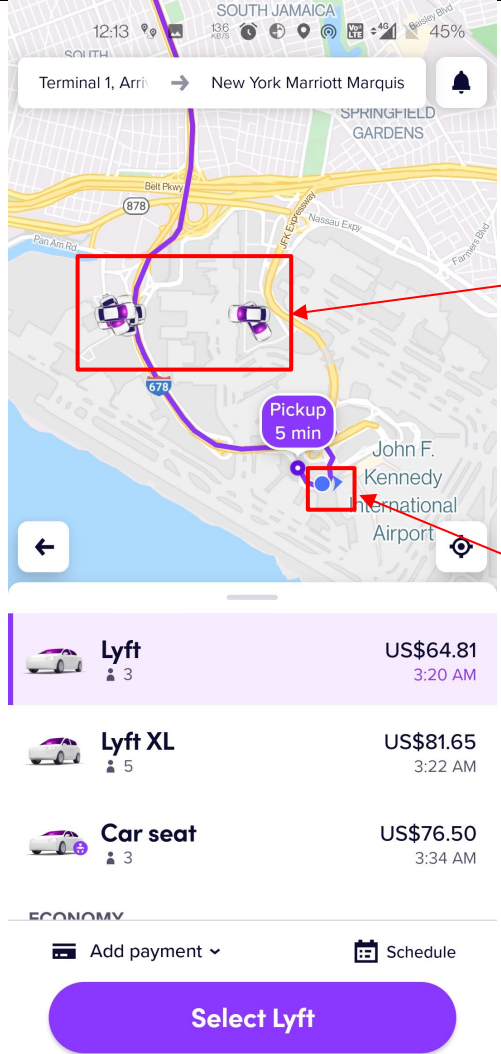

Claim 10,299,100	- Exemplary Supporting Evidence Regarding Lyft's Accused Products						
	 <p data-bbox="1123 386 1323 587">Nearby Drivers' location</p> <p data-bbox="1096 711 1329 906">Passenger's location</p> <table border="1" data-bbox="462 876 955 1136"><tbody><tr><td> Lyft</td><td>US\$64.81</td></tr><tr><td> Lyft XL</td><td>US\$81.65</td></tr><tr><td> Car seat</td><td>US\$76.50</td></tr></tbody></table> <p data-bbox="504 1169 913 1226">ECONOMY Add payment Schedule</p> <p data-bbox="504 1242 913 1315">Select Lyft</p>	 Lyft	US\$64.81	 Lyft XL	US\$81.65	 Car seat	US\$76.50
 Lyft	US\$64.81						
 Lyft XL	US\$81.65						
 Car seat	US\$76.50						

Exhibit C for US Patent No. 10,299,100 Against Lyft Accused Products

Claim 10,299,100	- Exemplary Supporting Evidence Regarding Lyft's Accused Products
	Further, to the extent this element is performed at least in part by Lyft's software source code, AGIS reserves the right to supplement these contentions pursuant to production of such source code by Lyft and to the extent Defendant requires additional information in accordance with P.R. 3-1 and for any other reasons.
5. The method of claim 1, further comprising: receiving, from a server, updated respective vehicle locations of the one or more vehicles; and updating, based on the received updated vehicle locations and the coordinate translation data, positions of the one or more vehicle symbols on the map.	<p>Every Lyft Accused Product infringes directly and/or indirectly by performing, inducing others to perform, and/or contributing to the performance of: receiving, from a server, updated respective vehicle locations of the one or more vehicles; and updating, based on the received updated vehicle locations and the coordinate translation data, positions of the one or more vehicle symbols on the map.</p> <p>This element is infringed literally, or in the alternative, under the doctrine of equivalents.</p> <p>See claim 1. Further, the Lyft app meets this limitation because the locations can be updated based on data received from the Lyft server and the locations presented on the map can be updated based on that data from the server. For example, the Lyft server updates the map in the Lyft app with the nearby drivers' location (vehicle icons) corresponding to their respective location coordinates.</p>

Exhibit C for US Patent No. 10,299,100 Against Lyft Accused Products









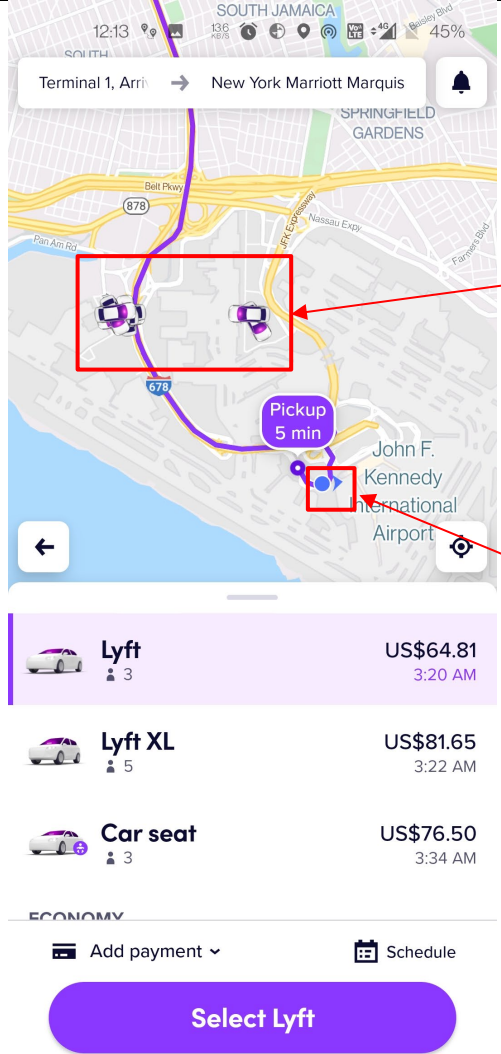

Claim 10,299,100	- Exemplary Supporting Evidence Regarding Lyft's Accused Products						
	 <p data-bbox="1123 386 1323 587">Nearby Drivers' location</p> <p data-bbox="1098 711 1329 906">Passenger's location</p> <table border="1" data-bbox="462 876 955 1136"><tbody><tr><td> Lyft</td><td>US\$64.81</td></tr><tr><td> Lyft XL</td><td>US\$81.65</td></tr><tr><td> Car seat</td><td>US\$76.50</td></tr></tbody></table> <p data-bbox="504 1169 913 1226">ECONOMY Add payment Schedule</p> <p data-bbox="504 1242 913 1315">Select Lyft</p>	 Lyft	US\$64.81	 Lyft XL	US\$81.65	 Car seat	US\$76.50
 Lyft	US\$64.81						
 Lyft XL	US\$81.65						
 Car seat	US\$76.50						

Exhibit C for US Patent No. 10,299,100 Against Lyft Accused Products

Claim 10,299,100	- Exemplary Supporting Evidence Regarding Lyft's Accused Products
	<p>Further, to the extent this element is performed at least in part by Lyft's software source code, AGIS reserves the right to supplement these contentions pursuant to production of such source code by Lyft and to the extent Defendant requires additional information in accordance with P.R. 3-1 and for any other reasons.</p>
<p>6. The method of claim 1, further comprising: receiving, from a GPS receiver, updated device locations; and updating, based on the received device locations and the coordinate translation data, a position of the participant symbol on the map.</p>	<p>The Lyft Accused Products infringe directly and/or indirectly by performing, inducing others to perform, and/or contributing to the performance of receiving, from a GPS receiver, updated device locations and updated, based on the received device locations and the coordinate translation data, a position of the participant symbol on the map.</p> <p>This element is infringed literally, or in the alternative, under the doctrine of equivalents.</p> <p><i>See Claims 1 and 2 above.</i></p>
<p>7. The method of claim 1, wherein the received second information is sent by the computing device corresponding to the first vehicle based on at least one criterion</p>	<p>The Lyft Accused Products infringe directly and/or indirectly by performing, inducing others to perform, and/or contributing to the performance of the received second information is sent by the computing device corresponding to the first vehicle based on at least one criterion selected from the group consisting of: (1) passage of time, and (2) movement of the first vehicle.</p> <p>This element is infringed literally, or in the alternative, under the doctrine of equivalents.</p> <p><i>See claim 1. In addition, the Lyft app meets this limitation because it can update the location of the rider or participant and the app can update the map. The map is updated with update locations or new areas. On information and belief, the map can be updated in response to interactions with the map, change of time/orientation, and/or user input or automatic input to the Lyft app from the user or Lyft server. For example,</i></p>

Exhibit C for US Patent No. 10,299,100 Against Lyft Accused Products

Claim 10,299,100	- Exemplary Supporting Evidence Regarding Lyft’s Accused Products
<p>selected from the group consisting of: (1) passage of time, and (2) movement of the first vehicle.</p>	<p>when a driver accepts a ride request from a passenger in the Lyft Driver app, the passenger’s app receives the driver’s information (such as name, location, vehicle name and vehicle number) along with the estimated time of arrival = and the movement of the driver’s car from the server.</p>  <p>https://www.youtube.com/watch?v=j0RDMLcmOgU at 5:07</p> <p>Further, to the extent this element is performed at least in part by Lyft's software source code, AGIS reserves the right to supplement these contentions pursuant to production of such source code by Lyft and to the extent Defendant requires additional information in accordance with P.R. 3-1 and for any other reasons.</p>
<p>8. The method of claim 1, wherein</p>	<p>The Lyft Accused Products infringe directly and/or indirectly by performing, inducing others to perform, and/or contributing to the performance of receiving second information which comprises one or more messages.</p>

Exhibit C for US Patent No. 10,299,100 Against Lyft Accused Products

Claim 10,299,100	- Exemplary Supporting Evidence Regarding Lyft's Accused Products
the received second information comprises one or more messages.	<p>This element is infringed literally, or in the alternative, under the doctrine of equivalents.</p> <p><i>See claim 1[J] above.</i></p>
9. The method of claim 8, wherein the one or more messages comprise data to facilitate the mobile device transmitting the first information to the first vehicle without the mobile device using the phone number, IP address, and e-mail address associated with the first vehicle.	<p>The Lyft Accused Products infringe directly and/or indirectly by performing, inducing others to perform, and/or contributing to the performance of the one or more messages which comprises data to facilitate the mobile device transmitting the first information to the first vehicle without the mobile device using the phone number, IP address, and e-mail address associated with the first vehicle.</p> <p>This element is infringed literally, or in the alternative, under the doctrine of equivalents.</p> <p><i>See claim 1. The Lyft app meets this limitation because a rider is able to communicate a text message or voice message to the driver without knowing the driver's phone number, IP address and email address. On information and belief, this communication is transmitted via a Lyft server.</i></p>
10. The method of claim 1, further comprising: communicating the identifier to a server; and joining a communication	<p>The Lyft Accused Products infringe directly and/or indirectly by performing, inducing others to perform, and/or contributing to the performance of communicating the identifier to a server and joining a communication network after the communication of the identifier to the server.</p> <p>This element is infringed literally, or in the alternative, under the doctrine of equivalents.</p> <p><i>See claim 1[B] above</i></p>

Exhibit C for US Patent No. 10,299,100 Against Lyft Accused Products

Claim 10,299,100	- Exemplary Supporting Evidence Regarding Lyft's Accused Products
network after the communication of the identifier to the server.	
11. The method of claim 10, wherein the communication network comprises one or more communication devices corresponding, respectively, to the one or more vehicles, and wherein each of the one or more communication devices is associated with a respective identifier.	<p>The Lyft Accused Products infringe directly and/or indirectly by performing, inducing others to perform, and/or contributing to the performance of the communication network comprises one or more communication devices corresponding, respectively, to the one or more vehicles, and wherein each of the one or more communication devices is associated with a respective identifier.</p> <p>This element is infringed literally, or in the alternative, under the doctrine of equivalents.</p> <p>See Claims 1 and 10. The Lyft app meets this limitation because the installed Lyft apps and their respective accounts are part of the Lyft platform/network. For example, Lyft is a communication network of drivers and passengers. The Lyft Driver app allows a driver to set up their account by providing information, including but not limited to, name, email address, phone number, driver's license and vehicle information and associates the information with the respective device of the driver.</p> <p>For example, the Lyft app also allows a passenger to set up their account by providing information including but not limited to name, email address and phone number and associates the information with the respective device of the passenger.</p> <p>What is Lyft?</p> <p>Lyft is a platform that connects drivers with individuals and organizations that need rides.</p> <p>https://www.lyft.com/drive-with-lyft</p>

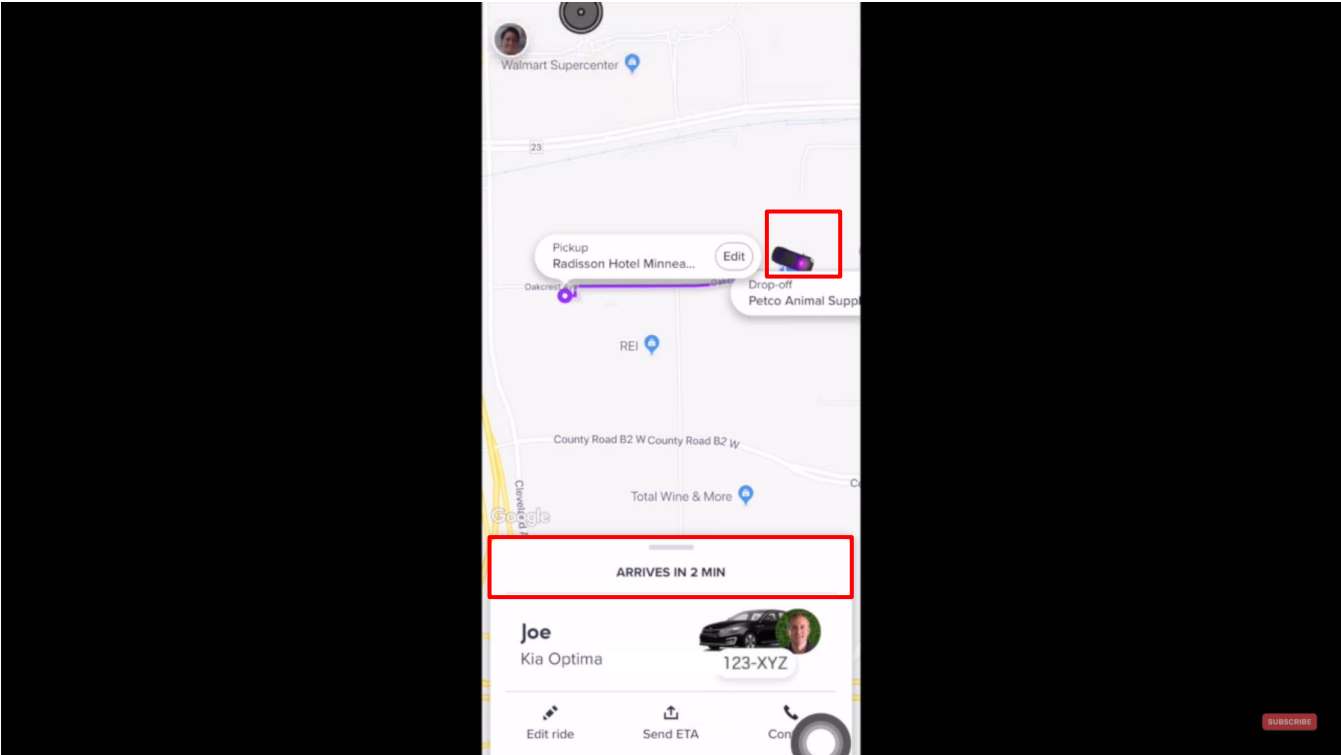
Exhibit C for US Patent No. 10,299,100 Against Lyft Accused Products

Claim 10,299,100	- Exemplary Supporting Evidence Regarding Lyft's Accused Products
	<h1 data-bbox="478 277 1171 354">Driver requirements</h1> <p data-bbox="478 402 1774 467">All Lyft drivers must meet certain requirements to drive on the platform. Applicant and vehicle requirements can vary depending on your City or State.</p> <p data-bbox="478 505 1360 529">To start an application, see How to apply to become a driver for instructions.</p> <p data-bbox="478 566 569 591">Skip to:</p> <ul data-bbox="541 630 1115 1019" style="list-style-type: none"><li data-bbox="541 630 909 654">• State and local requirement<ul data-bbox="646 678 982 808" style="list-style-type: none"><li data-bbox="646 678 892 703">◦ Age requirement<li data-bbox="646 727 982 751">◦ Vehicle requirements<li data-bbox="646 776 863 800">◦ Driving history<li data-bbox="541 846 804 870">• Background check<li data-bbox="541 894 720 919">• DMV check<li data-bbox="541 943 1115 967">• Driver license, license plates, and insurance<li data-bbox="541 992 1024 1016">• Community Safety Education program <p data-bbox="478 1052 1360 1076">https://help.lyft.com/hc/e/articles/115012925687-Driver-requirements</p>

Exhibit C for US Patent No. 10,299,100 Against Lyft Accused Products

Claim 10,299,100	- Exemplary Supporting Evidence Regarding Lyft's Accused Products
	<h3 data-bbox="478 277 991 318">How to start an application</h3> <p data-bbox="478 350 1314 378">Create a Lyft account through the app or on the web at lyft.com/drivers.</p> <p data-bbox="478 415 1730 477">Enter your name, phone number, and email address, then submit all the info we need to ensure you meet the requirements. If you sign out of your account, any application info you've submitted will be saved.</p> <p data-bbox="478 514 1751 576">If you have a promo code, enter it when creating an account. If you apply through a link on a website, the code will be added automatically.</p> <p data-bbox="478 613 611 641">Back to top</p> <p data-bbox="478 659 1094 686">https://help.lyft.com/hc/e/articles/115013081188</p> <h3 data-bbox="478 732 816 773">Applicant Waitlist</h3> <p data-bbox="478 810 1740 872">New applicants will be automatically added to our waitlist. This makes sure there's a better balance of drivers and passengers in your region.</p> <p data-bbox="478 909 1770 1040">The waitlist is a hold on your application request that will be removed when additional spots for new drivers open up in your city. It's hard to say exactly how long you'll be on the waitlist due to a variety of factors that affect demand in certain areas. The waitlist doesn't impact existing drivers. We'll send you a notification as soon as a spot opens up!</p> <p data-bbox="478 1078 1734 1140">As soon as you're removed from the waitlist you'll be able to complete all necessary application steps. Once your application and documents are approved, you can start driving.</p> <p data-bbox="478 1170 1094 1198">https://help.lyft.com/hc/e/articles/115013081188</p>

Exhibit C for US Patent No. 10,299,100 Against Lyft Accused Products

Claim 10,299,100	- Exemplary Supporting Evidence Regarding Lyft’s Accused Products
	<p>Before you begin, be sure you have the following:</p> <ul style="list-style-type: none"> • Your phone number • Your email address • A photo of yourself <p>Get started</p> <ol style="list-style-type: none"> 1. Type in your device's phone number 2. To verify your identity, we'll send a verification code via text to your phone number. We want to make sure you're human! 3. The text message should arrive immediately. If you don't see it after a bit, tap 'Resend code.' 4. Type in your name, email address, and take a selfie so your driver knows who to pick up 5. That's it! Once you've set up your account, you'll be able to request a ride (Learn How to request a ride). <p>https://help.lyft.com/hc/e/articles/115012926947-How-to-create-a-Lyft-account</p> <p>Further, to the extent this element is performed at least in part by Lyft's software source code, AGIS reserves the right to supplement these contentions pursuant to production of such source code by Lyft and to the extent Defendant requires additional information in accordance with P.R. 3-1 and for any other reasons.</p>
<p>12. The method of claim 1, further comprising determining a location-reporting status of the mobile device, wherein the location-reporting</p>	<p>The Lyft Accused Products infringe directly and/or indirectly by performing, inducing others to perform, and/or contributing to the performance of: determining a location-reporting status of the mobile device, wherein the location-reporting status is one of a reporting state and a non-reporting state, and wherein transmitting the first information to the first vehicle comprises sending the device location to a server only when the location-reporting status is in the reporting state.</p> <p>This element is infringed literally, or in the alternative, under the doctrine of equivalents.</p>

Exhibit C for US Patent No. 10,299,100 Against Lyft Accused Products

Claim - 10,299,100	Exemplary Supporting Evidence Regarding Lyft's Accused Products
<p>status is one of a reporting state and a non-reporting state, and wherein transmitting the first information to the first vehicle comprises sending the device location to a server only when the location-reporting status is in the reporting state.</p>	<p>See claim 1. The Lyft apps perform this limitation because they determine whether locations services/mode are enabled/disabled and if the location services/mode is enabled the Lyft app communicates location to the Lyft server. When location services are disabled, the Lyft app requests that the user enable location services to use the app and thus does not send location to the Lyft server. On information and belief, locations retrieved from location services are sent when location services are enabled.</p> <p>Further, to the extent this element is performed at least in part by Lyft's software source code, AGIS reserves the right to supplement these contentions pursuant to production of such source code by Lyft and to the extent Defendant requires additional information in accordance with P.R. 3-1 and for any other reasons.</p>
<p>13. The method of claim 1, wherein transmitting the first information to the first vehicle comprises transmitting data including the first information to a server using an Internet Protocol, wherein the second information corresponding to</p>	<p>The Lyft Accused Products infringe directly and/or indirectly by performing, inducing others to perform, and/or contributing to the performance of: transmitting the first information to the first vehicle comprises transmitting data including the first information to a server using an Internet Protocol, wherein the second information corresponding to the first vehicle is transmitted by the server to the mobile device using the Internet Protocol, and wherein an IP address of the server is accessible to the mobile device.</p> <p>This element is infringed literally, or in the alternative, under the doctrine of equivalents.</p> <p>See claim 1. The Lyft app meets this limitation because it communicates information to the Lyft server(s) via IP-based communications. For example, a passenger's Lyft app transmits the ride request message to the nearby drivers via the Lyft server using IP based communication which includes the IP address of the server. After the driver accepts the ride request, the driver's information (including but not limited to driver's name, photo, vehicle name and vehicle model) is transmitted to the passenger's Lyft app via the server using IP based communication which includes the IP address of the server.</p>

Exhibit C for US Patent No. 10,299,100 Against Lyft Accused Products

Claim 10,299,100	- Exemplary Supporting Evidence Regarding Lyft's Accused Products
<p>the first vehicle is transmitted by the server to the mobile device using the Internet Protocol, and wherein an IP address of the server is accessible to the mobile device.</p>	 <p>https://www.youtube.com/watch?v=j0RDMLcmOgU at 5:07</p>

Exhibit C for US Patent No. 10,299,100 Against Lyft Accused Products

Claim 10,299,100	- Exemplary Supporting Evidence Regarding Lyft's Accused Products
	<div data-bbox="464 269 1619 914"> </div> <p data-bbox="464 919 1381 954">https://www.youtube.com/watch?v=jVUy9poJDng at 10:24, Annotated</p> <h3 data-bbox="464 997 850 1040">Network addressing</h3> <p data-bbox="478 1068 1824 1175">When a 'message' such as a file, image or video is transmitted across a network, it is first broken down into small blocks called <i>segments</i>. These are placed into containers called <i>packets</i>, typically by the Internet Protocol (IP). There are two versions of IP: version 4 and version 6.</p> <div data-bbox="478 1195 1814 1271" style="border: 1px solid red; padding: 5px;"> <p data-bbox="478 1195 1814 1271">IP is responsible for delivering the packets from source to destination, and regardless of the version being used, packets must use some form of addressing to uniquely identify the message source and message destination.</p> </div> <p data-bbox="464 1287 1619 1323">https://www.open.edu/openlearncreate/mod/oucontent/view.php?id=129584&printable=1</p>

Exhibit C for US Patent No. 10,299,100 Against Lyft Accused Products

Claim 10,299,100	- Exemplary Supporting Evidence Regarding Lyft's Accused Products
	Further, to the extent this element is performed at least in part by Lyft's software source code, AGIS reserves the right to supplement these contentions pursuant to production of such source code by Lyft and to the extent Defendant requires additional information in accordance with P.R. 3-1 and for any other reasons.
14. The method of claim 13, wherein the data transmitted to the server further includes a second identifier corresponding to a second network participant associated with the computing device corresponding to the first vehicle.	<p>The Lyft Accused Products infringe directly and/or indirectly by performing, inducing others to perform, and/or contributing to the performance of: the data transmitted to the server further includes a second identifier corresponding to a second network participant associated with the computing device corresponding to the first vehicle.</p> <p>This element is infringed literally, or in the alternative, under the doctrine of equivalents.</p> <p>See claim 1 and 13. The Lyft app meets this limitation because the communications include account/identity information. On information and belief, this information is included in the data communicated to the server(s). For example, when a driver accepts the ride request of the passenger, the rider's Lyft app receives the driver's information (such as name, location, vehicle model and vehicle number) ("second identifier corresponding to a second network participant") from the server and vice versa.</p>

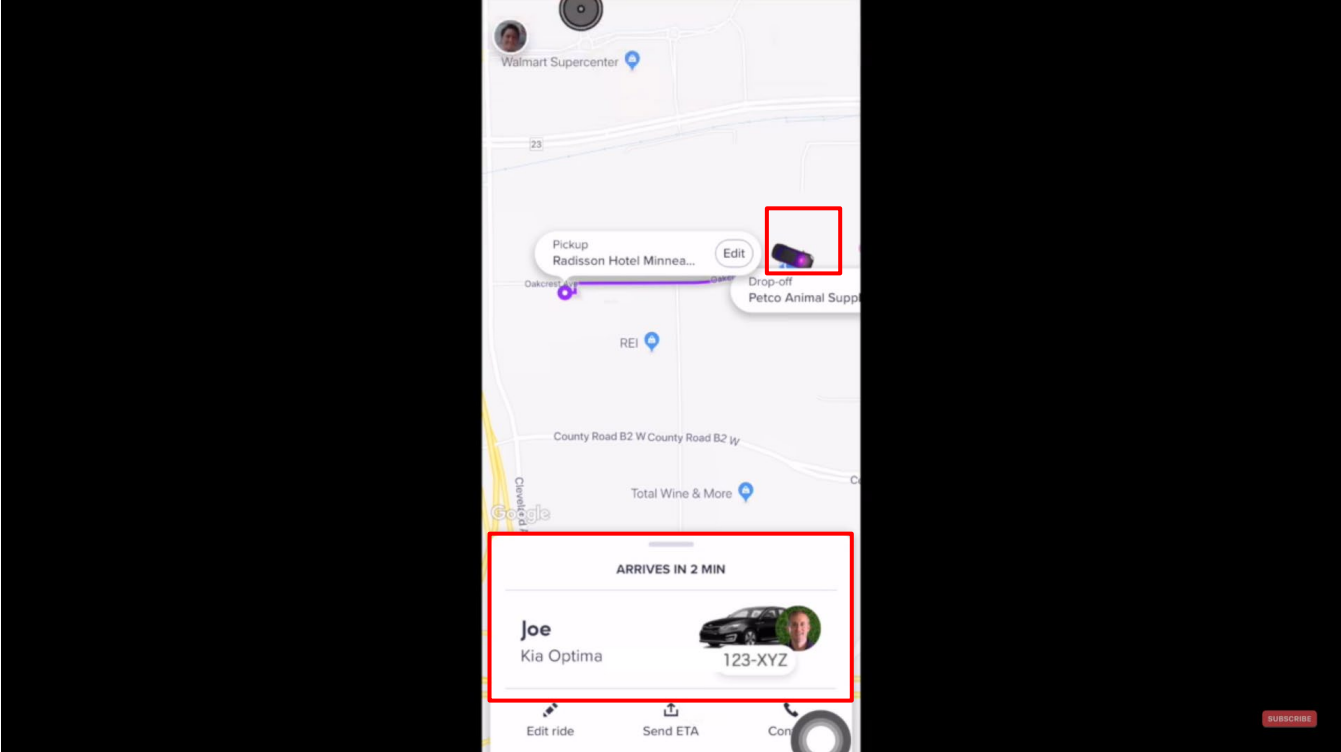
Exhibit C for US Patent No. 10,299,100 Against Lyft Accused Products

Claim 10,299,100	- Exemplary Supporting Evidence Regarding Lyft’s Accused Products
	 <p>https://www.youtube.com/watch?v=j0RDMLcmOgU at 5:07</p> <p>Further, to the extent this element is performed at least in part by Lyft's software source code, AGIS reserves the right to supplement these contentions pursuant to production of such source code by Lyft and to the extent Defendant requires additional information in accordance with P.R. 3-1 and for any other reasons.</p>
<p>15. The method of claim 14, wherein: the server stores an IP address of</p>	<p>The Lyft Accused Products infringe directly and/or indirectly by performing, inducing others to perform, and/or contributing to the performance of: the server stores an IP address of the computing device associated with the second network participant identified by the second identifier; and the server transmits the first information to</p>

Exhibit C for US Patent No. 10,299,100 Against Lyft Accused Products

Claim 10,299,100	- Exemplary Supporting Evidence Regarding Lyft’s Accused Products
<p>the computing device associated with the second network participant identified by the second identifier; and the server transmits the first information to the computing device corresponding to the first vehicle in a message addressed to the stored IP address of the computing device corresponding to the first vehicle.</p>	<p>the computing device corresponding to the first vehicle in a message addressed to the stored IP address of the computing device corresponding to the first vehicle.</p> <p>This element is infringed literally, or in the alternative, under the doctrine of equivalents.</p> <p>See claims 1, 13, 14. The Lyft app stores the IP address of the Lyft app and communicates with the Lyft app (and accounts or identities) via IP based communication. On information Lyft server(s) store the IP addresses of Lyft app/accounts for use in IP based communication. For example, Lyft’s server store IP addresses of each driver’s device and associates it to the respective driver’s information including but not limited to as name, location, vehicle model and vehicle number. When the passenger requests a ride, the request ride message (“first information”) comprising pickup location and passenger’s name and photo (“identifier”) is communicated to the nearby drivers using their respective IP addresses which are stored in the server.</p>

Exhibit C for US Patent No. 10,299,100 Against Lyft Accused Products

Claim 10,299,100	- Exemplary Supporting Evidence Regarding Lyft's Accused Products
	<h1 data-bbox="478 277 1171 354">Driver requirements</h1> <p data-bbox="478 402 1774 467">All Lyft drivers must meet certain requirements to drive on the platform. Applicant and vehicle requirements can vary depending on your City or State.</p> <p data-bbox="478 505 1360 529">To start an application, see How to apply to become a driver for instructions.</p> <p data-bbox="478 566 569 591">Skip to:</p> <ul data-bbox="543 630 1115 1019" style="list-style-type: none"><li data-bbox="543 630 909 654">• State and local requirement<ul data-bbox="653 678 982 808" style="list-style-type: none"><li data-bbox="653 678 890 703">◦ Age requirement<li data-bbox="653 727 982 751">◦ Vehicle requirements<li data-bbox="653 776 856 800">◦ Driving history<li data-bbox="543 846 804 870">• Background check<li data-bbox="543 894 720 919">• DMV check<li data-bbox="543 943 1115 967">• Driver license, license plates, and insurance<li data-bbox="543 992 1024 1016">• Community Safety Education program <p data-bbox="470 1052 1360 1076">https://help.lyft.com/hc/e/articles/115012925687-Driver-requirements</p>

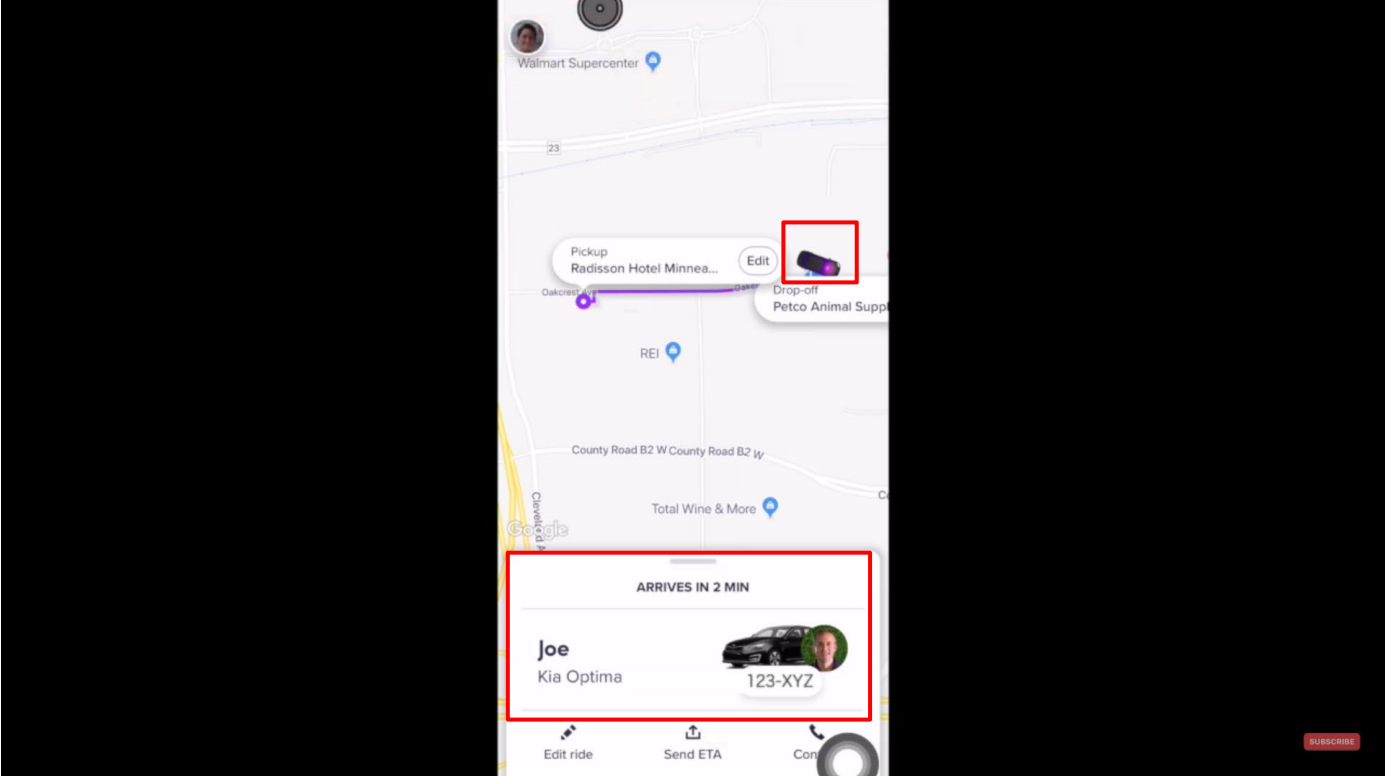
Exhibit C for US Patent No. 10,299,100 Against Lyft Accused Products

Claim 10,299,100	- Exemplary Supporting Evidence Regarding Lyft's Accused Products
	<h3 data-bbox="478 272 991 316">How to start an application</h3> <p data-bbox="478 349 1312 381">Create a Lyft account through the app or on the web at lyft.com/drivers.</p> <p data-bbox="478 414 1732 479">Enter your name, phone number, and email address, then submit all the info we need to ensure you meet the requirements. If you sign out of your account, any application info you've submitted will be saved.</p> <p data-bbox="478 511 1753 576">If you have a promo code, enter it when creating an account. If you apply through a link on a website, the code will be added automatically.</p> <p data-bbox="478 609 609 641">Back to top</p> <p data-bbox="478 657 1092 690">https://help.lyft.com/hc/e/articles/115013081188</p> <h3 data-bbox="478 722 819 771">Applicant Waitlist</h3> <p data-bbox="478 803 1743 868">New applicants will be automatically added to our waitlist. This makes sure there's a better balance of drivers and passengers in your region.</p> <p data-bbox="478 901 1774 1039">The waitlist is a hold on your application request that will be removed when additional spots for new drivers open up in your city. It's hard to say exactly how long you'll be on the waitlist due to a variety of factors that affect demand in certain areas. The waitlist doesn't impact existing drivers. We'll send you a notification as soon as a spot opens up!</p> <p data-bbox="478 1071 1732 1144">As soon as you're removed from the waitlist you'll be able to complete all necessary application steps. Once your application and documents are approved, you can start driving.</p> <p data-bbox="478 1169 1092 1201">https://help.lyft.com/hc/e/articles/115013081188</p>

Exhibit C for US Patent No. 10,299,100 Against Lyft Accused Products

Claim 10,299,100	- Exemplary Supporting Evidence Regarding Lyft's Accused Products
	<div data-bbox="464 269 1619 914"> </div> <p data-bbox="464 919 1381 954">https://www.youtube.com/watch?v=jVUy9poJDng at 10:24, Annotated</p> <p data-bbox="464 997 850 1040">Network addressing</p> <p data-bbox="478 1068 1824 1175">When a 'message' such as a file, image or video is transmitted across a network, it is first broken down into small blocks called <i>segments</i>. These are placed into containers called <i>packets</i>, typically by the Internet Protocol (IP). There are two versions of IP: version 4 and version 6.</p> <div data-bbox="478 1195 1814 1271" style="border: 1px solid red; padding: 5px;"> <p data-bbox="478 1195 1814 1271">IP is responsible for delivering the packets from source to destination, and regardless of the version being used, packets must use some form of addressing to uniquely identify the message source and message destination.</p> </div> <p data-bbox="464 1287 1619 1323">https://www.open.edu/openlearncreate/mod/oucontent/view.php?id=129584&printable=1</p>

Exhibit C for US Patent No. 10,299,100 Against Lyft Accused Products

Claim 10,299,100	- Exemplary Supporting Evidence Regarding Lyft's Accused Products
	Further, to the extent this element is performed at least in part by Lyft's software source code, AGIS reserves the right to supplement these contentions pursuant to production of such source code by Lyft and to the extent Defendant requires additional information in accordance with P.R. 3-1 and for any other reasons.
16. The method of claim 1, further comprising determining coordinates of the selected position on the map, wherein data associated with the set of symbols include coordinates of positions on the map of the symbols in the set, wherein the search of the set of symbols includes a search of the coordinates of the positions of the symbols in the set for coordinates located nearest to the coordinates of the selected position, and	<p>The Lyft Accused Products infringe directly and/or indirectly by performing, inducing others to perform, and/or contributing to the performance of determining coordinates of the selected position on the map, wherein data associated with the set of symbols include coordinates of positions on the map of the symbols in the set, wherein the search of the set of symbols includes a search of the coordinates of the positions of the symbols in the set for coordinates located nearest to the coordinates of the selected position, and wherein the selected facility symbol is identified as the symbol located nearest to the selected position based on a result of the search of the coordinates of the positions on the map of the symbols.</p> <p>This element is infringed literally, or in the alternative, under the doctrine of equivalents.</p> <p><i>See claim 1[H] above.</i></p>

Exhibit C for US Patent No. 10,299,100 Against Lyft Accused Products

Claim 10,299,100	- Exemplary Supporting Evidence Regarding Lyft's Accused Products
<p>wherein the selected facility symbol is identified as the symbol located nearest to the selected position based on a result of the search of the coordinates of the positions on the map of the symbols.</p>	
<p>17. The method of claim 1, further comprising determining coordinates of the selected portion of the display, wherein data associated with the set of symbols include coordinates of portions of the display corresponding to the symbols in the set, wherein the search of the set</p>	<p>The Lyft Accused Products infringe directly and/or indirectly by performing, inducing others to perform, and/or contributing to the performance of determining coordinates of the selected portion of the display, wherein data associated with the set of symbols include coordinates of portions of the display corresponding to the symbols in the set, wherein the search of the set of symbols includes a search of the coordinates of the portions of the display corresponding to the symbols in the set for coordinates located nearest to the coordinates of the selected portion of the display, and wherein the selected facility symbol is identified as the symbol located nearest to the selected position based on a result of the search of the coordinates of the portions of the display corresponding to the symbols.</p> <p>This element is infringed literally, or in the alternative, under the doctrine of equivalents.</p> <p><i>See claim 1[H] above.</i></p>

Exhibit C for US Patent No. 10,299,100 Against Lyft Accused Products

Claim 10,299,100	- Exemplary Supporting Evidence Regarding Lyft’s Accused Products
<p>of symbols includes a search of the coordinates of the portions of the display corresponding to the symbols in the set for coordinates located nearest to the coordinates of the selected portion of the display, and wherein the selected facility symbol is identified as the symbol located nearest to the selected position based on a result of the search of the coordinates of the portions of the display corresponding to the symbols.</p>	
<p>18. The method of claim 1, further comprising determining</p>	<p>The Lyft Accused Products infringe directly and/or indirectly by performing, inducing others to perform, and/or contributing to the performance of determining coordinates of a location represented by the selected position on the map, wherein data associated with the set of symbols include coordinates of locations of entities represented by the symbols in the set, wherein the search of the set of symbols includes a search of the coordinates of the</p>

Exhibit C for US Patent No. 10,299,100 Against Lyft Accused Products

Claim 10,299,100	- Exemplary Supporting Evidence Regarding Lyft's Accused Products
<p>coordinates of a location represented by the selected position on the map, wherein data associated with the set of symbols include coordinates of locations of entities represented by the symbols in the set, wherein the search of the set of symbols includes a search of the coordinates of the locations of the entities represented by the symbols in the set for coordinates located nearest to the coordinates of the location represented by the selected position on the map, and</p>	<p>locations of the entities represented by the symbols in the set for coordinates located nearest to the coordinates of the location represented by the selected position on the map, and wherein the selected facility symbol is identified as the symbol located nearest to the selected position based on a result of the search of the coordinates of the locations of the entities represented by the symbols.</p> <p>This element is infringed literally, or in the alternative, under the doctrine of equivalents.</p> <p>See claim 1[H] above.</p>

Exhibit C for US Patent No. 10,299,100 Against Lyft Accused Products

Claim 10,299,100	- Exemplary Supporting Evidence Regarding Lyft’s Accused Products
<p>wherein the selected facility symbol is identified as the symbol located nearest to the selected position based on a result of the search of the coordinates of the locations of the entities represented by the symbols.</p>	
<p>19. The method of claim 1, further comprising: after identifying the selected facility symbol, displaying an address of the facility represented by the facility symbol.</p>	<p>The Lyft Accused Products infringe directly and/or indirectly by performing, inducing others to perform, and/or contributing to the performance of: after identifying the selected facility symbol, displaying an address of the facility represented by the facility symbol.</p> <p>This element is infringed literally, or in the alternative, under the doctrine of equivalents.</p> <p>See claim 1. The Lyft apps meet this limitation because the Lyft app displays the address for selected entities on the display. For example, after Lyft identifies the selected facility symbol (e.g. airport), it displays the address of the selected facility represented by the facility symbol.</p>

Exhibit C for US Patent No. 10,299,100 Against Lyft Accused Products

Claim 10,299,100	- Exemplary Supporting Evidence Regarding Lyft's Accused Products
	 <p>The screenshot shows the Lyft app's trip setup interface. At the top, there is a 'Trip' header with a close button and a 'Change rider' dropdown menu. Below this is a 'Start' field with a location pin icon and a plus sign to its right. Underneath is a 'Destination' field with a location pin icon. A list of suggested locations follows: 'Work' (with a briefcase icon), 'Home' (with a house icon), and 'Current location' (with a location pin icon). The 'Set on map' option, which includes a person icon, is highlighted with a red rectangular box. At the bottom of the screen, there is a navigation bar with four icons: a magnifying glass (search), a bicycle (ride), a car icon (ride), and a person icon (profile).</p>

Exhibit C for US Patent No. 10,299,100 Against Lyft Accused Products

Claim 10,299,100	- Exemplary Supporting Evidence Regarding Lyft's Accused Products
	 <p>The screenshot displays a Google Maps interface. The map shows the area around John F. Kennedy International Airport, which is highlighted with a red rectangular box. The map includes labels for various neighborhoods such as Laurelton, Rosedale, North Woodmere, and Meadowmere, as well as parks like Idlewild Park and North Woodmere Park. Below the map, the text "TGIF, sumit" is visible. A search bar contains the text "Where are you going?". Below the search bar, there are three suggestions: "New York Marriott Marquis 1535 Broadway, New York", "Work", and "Where are you going?". At the bottom of the screen, there are four icons: a magnifying glass, a bicycle, a bus, and a carpooling icon.</p>

Exhibit C for US Patent No. 10,299,100 Against Lyft Accused Products

Claim 10,299,100	- Exemplary Supporting Evidence Regarding Lyft's Accused Products			
	 <p>Terminal 2, Arrivals, Pick Up A-B Drag map or tap to edit pickup spot</p> <p>John F. Kennedy Int'l Airport Head down to the Arrivals curb and follow signs to Passenger Pick Up</p> <table border="1" data-bbox="485 951 911 1118"><tr><td>Terminal 1, Arrivals</td></tr><tr><td>Terminal 2, Arrivals Pick Up A-B</td></tr><tr><td>Terminal 4, Arrivals</td></tr></table> <p>Set pickup</p> <p>Further, to the extent this element is performed at least in part by Lyft's software source code, AGIS reserves the right to supplement these contentions pursuant to production of such source code by Lyft and to the extent Defendant requires additional information in accordance with P.R. 3-1 and for any other reasons.</p>	Terminal 1, Arrivals	Terminal 2, Arrivals Pick Up A-B	Terminal 4, Arrivals
Terminal 1, Arrivals				
Terminal 2, Arrivals Pick Up A-B				
Terminal 4, Arrivals				

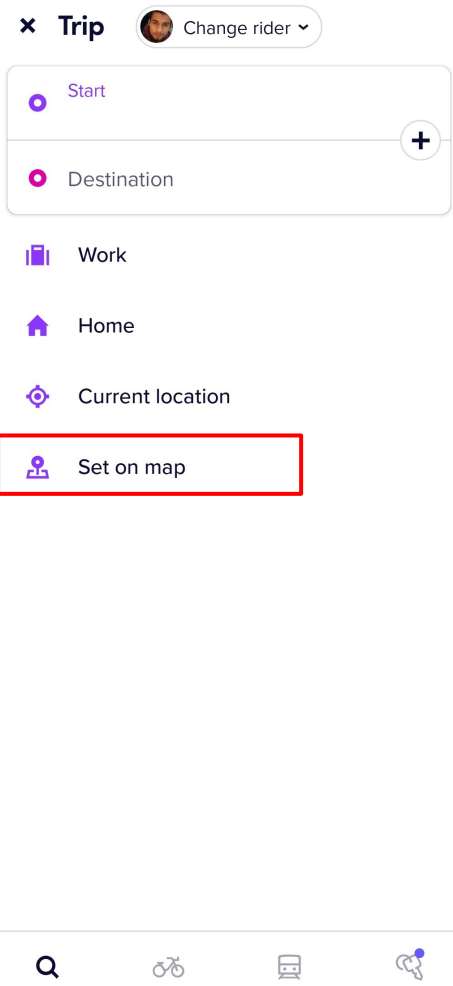
Exhibit C for US Patent No. 10,299,100 Against Lyft Accused Products

Claim 10,299,100	- Exemplary Supporting Evidence Regarding Lyft's Accused Products
<p>20. The method of claim 1, wherein the mobile device is a first mobile device, wherein the map is a first map, and wherein the method further comprises: receiving second user input via user interaction with a second portion of the display of the first mobile device, the second user input specifying a position on the first map of an event symbol representing an event; and based on the second user input: determining coordinates of a location of the event based on coordinates of the specified position</p>	<p>The Lyft Accused Products infringe directly and/or indirectly by performing, inducing others to perform, and/or contributing to the performance of: the mobile device is a first mobile device, wherein the map is a first map, and wherein the method further comprises: receiving second user input via user interaction with a second portion of the display of the first mobile device, the second user input specifying a position on the first map of an event symbol representing an event; and based on the second user input: determining coordinates of a location of the event based on coordinates of the specified position on the first map and the coordinate translation data; associating the location of the event with the event symbol; displaying the event symbol at the specified position on the first map; and transmitting the location of the event to a second mobile device corresponding to the first vehicle, wherein the second mobile device is operable to display a second map and to place the event symbol on the second map.</p> <p>This element is infringed literally, or in the alternative, under the doctrine of equivalents.</p> <p>See claim 1. The Lyft app meets this limitation because the user can provided user input in the Lyft app to specify multiple pickup/stop/destinations and the corresponding symbol/location will be placed on the map. This symbol/location is communicated to the driver's Lyft app. For example, through the Lyft app, a passenger inputs a destination address by clicking on the map interface. This input specifies a position on the map and is displayed as a symbol after the user inputs it. Further, this location is transmitted to the driver and is displayed as a symbol on the driver's app.</p>

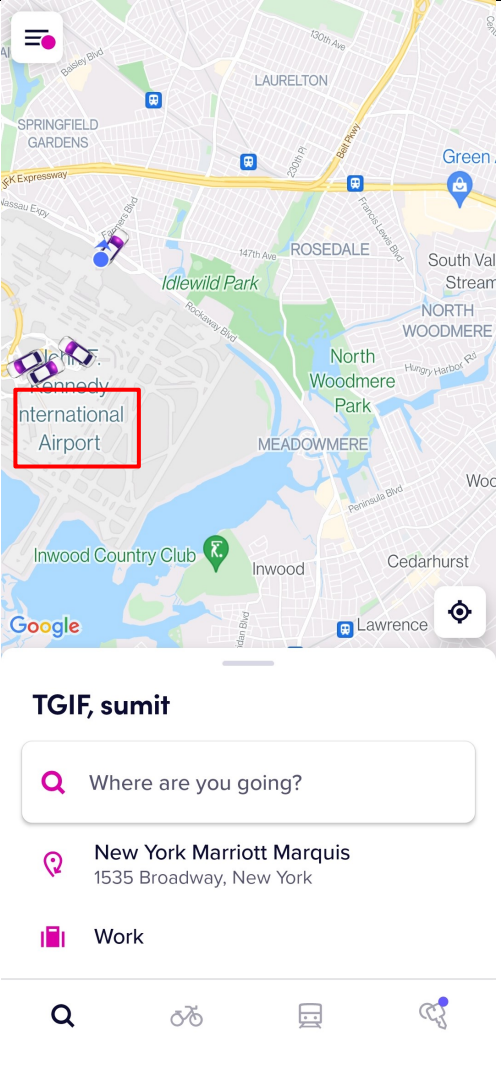
Exhibit C for US Patent No. 10,299,100 Against Lyft Accused Products

<p>Claim 10,299,100</p>	<p>- Exemplary Supporting Evidence Regarding Lyft’s Accused Products</p>
<p>on the first map and the coordinate translation data; associating the location of the event with the event symbol; displaying the event symbol at the specified position on the first map; and transmitting the location of the event to a second mobile device corresponding to the first vehicle, wherein the second mobile device is operable to display a second map and to place the event symbol on the second map.</p>	 <p>The screenshot shows a Google Maps interface. At the top, there is a search bar with the text "TGIF, sumit" and a red rectangular box around it. Below the search bar, there are three suggestions: "New York Marriott Marquis" with the address "1535 Broadway, New York", and "Work". The map background shows a neighborhood in Queens, New York, including areas like Laurelton, Rosedale, North Woodmere, and Meadowmere. Landmarks like Idlewild Park and Kennedy International Airport are visible. The bottom of the screen shows navigation icons for search, bicycle, bus, and carpooling.</p>

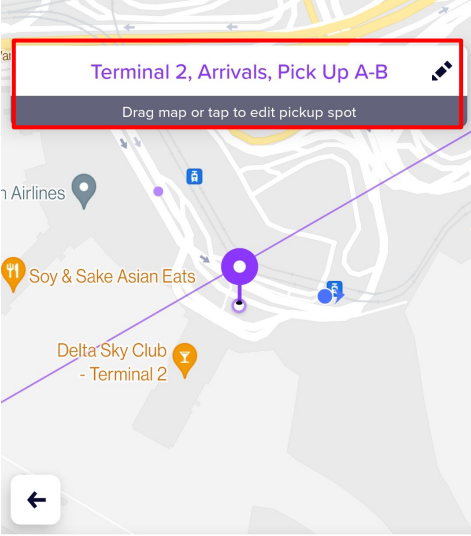
Exhibit C for US Patent No. 10,299,100 Against Lyft Accused Products

Claim 10,299,100	- Exemplary Supporting Evidence Regarding Lyft's Accused Products
	Further, to the extent this element is performed at least in part by Lyft's software source code, AGIS reserves the right to supplement these contentions pursuant to production of such source code by Lyft and to the extent Defendant requires additional information in accordance with P.R. 3-1 and for any other reasons.
21. The method of claim 20, wherein the coordinates of the location of the event are determined based on coordinates of the position of the event symbol on the map and the coordinate translation data.	<p>The Lyft Accused Products infringe directly and/or indirectly by performing, inducing others to perform, and/or contributing to the performance of: the coordinates of the location of the event are determined based on coordinates of the position of the event symbol on the map and the coordinate translation data.</p> <p>This element is infringed literally, or in the alternative, under the doctrine of equivalents.</p> <p>See claim 20. For example, upon information and belief, the coordinates of the destination address (“event”) are determined by the symbol placed by the passenger on the map in the Lyft app.</p>

Exhibit C for US Patent No. 10,299,100 Against Lyft Accused Products

Claim 10,299,100	- Exemplary Supporting Evidence Regarding Lyft's Accused Products
	 <p>The screenshot displays the Lyft mobile application interface. At the top, a map shows the New York City area, including neighborhoods like Springfield Gardens, Rosedale, North Woodmere, and Inwood. A red location pin is placed on the map. Below the map, the text "TGIF, sumit" is visible. A search bar with a red border contains the text "Where are you going?". Below the search bar, there are three suggested locations: "New York Marriott Marquis" at "1535 Broadway, New York", and "Work". At the bottom of the screen, there are icons for search, bicycle, bus, and carpooling.</p>

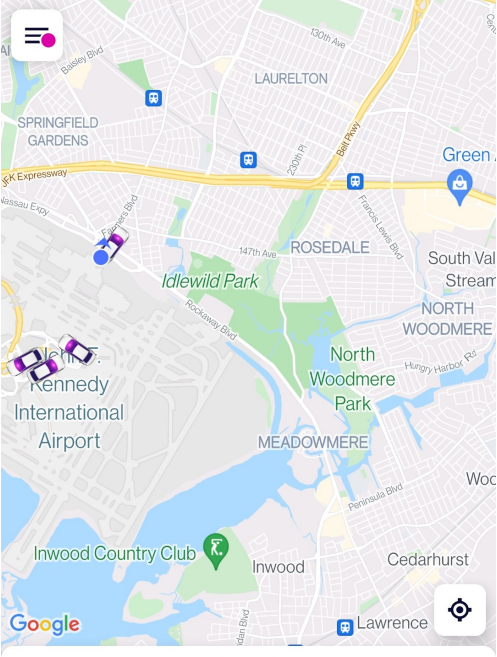
Exhibit C for US Patent No. 10,299,100 Against Lyft Accused Products

Claim 10,299,100	- Exemplary Supporting Evidence Regarding Lyft's Accused Products
	Further, to the extent this element is performed at least in part by Lyft's software source code, AGIS reserves the right to supplement these contentions pursuant to production of such source code by Lyft and to the extent Defendant requires additional information in accordance with P.R. 3-1 and for any other reasons.
22. The method of claim 20, wherein the coordinates of the location of the event are determined based on coordinates of the second portion of the display and the coordinate translation data.	<p>The Lyft Accused Products infringe directly and/or indirectly by performing, inducing others to perform, and/or contributing to the performance of: the coordinates of the location of the event are determined based on coordinates of the second portion of the display and the coordinate translation data.</p> <p>This element is infringed literally, or in the alternative, under the doctrine of equivalents.</p> <p>See claim 20-21. For example, upon information and belief, the coordinates of the destination address (“event”) are determined by the symbol placed in the second portion of the map by the passenger in the Lyft app.</p> <p>Further, to the extent this element is performed at least in part by Lyft's software source code, AGIS reserves the right to supplement these contentions pursuant to production of such source code by Lyft and to the extent Defendant requires additional information in accordance with P.R. 3-1 and for any other reasons.</p>
23. The method of claim 1, wherein the map is first map, wherein the coordinate translation data are first coordinate translation data, wherein an area depicted in the first map represents a first portion of an area depicted in a	<p>The Lyft Accused Products infringe directly and/or indirectly by performing, inducing others to perform, and/or contributing to the performance of: wherein the map is first map, wherein the coordinate translation data are first coordinate translation data, wherein an area depicted in the first map represents a first portion of an area depicted in a second map, and wherein the method further comprises: receiving, from a server, a third map representing a second portion of the area depicted in the second map and second coordinate translation data correlating coordinates of positions on the second map with corresponding coordinates of geographical locations.</p> <p>See claim 1. On information and belief, the Lyft app presents a map display to a user which can include multiple maps. The multiple maps can include multiple portions of the maps and can be modified via user interaction with the map or automatically based on information received from the Lyft app or Lyft server(s) or based on changes in location/orientation/view. The data used to present the maps can include multiple sets of coordinates.</p>

Exhibit C for US Patent No. 10,299,100 Against Lyft Accused Products

Claim 10,299,100	- Exemplary Supporting Evidence Regarding Lyft’s Accused Products
<p>second map, and wherein the method further comprises: receiving, from a server, a third map representing a second portion of the area depicted in the second map and second coordinate translation data correlating coordinates of positions on the second map with corresponding coordinates of geographical locations.</p>	
<p>24[P]. A system comprising a mobile device contained in a portable housing, the mobile device comprising:</p>	<p>The Lyft Accused Products comprise a system comprising a mobile device contained in a portable housing, the mobile device comprising</p> <p>This element is infringed literally, or in the alternative, under the doctrine of equivalents.</p> <p>For example, Lyft provides the Lyft app for passengers and the Lyft Driver app for drivers. The Lyft apps for riders and drivers, in conjunction with Lyft’s servers and services, provide users with interactive methods to request, view, and track locations of passengers/riders using real-time maps and communications via mobile phones to establish a wireless communication network.</p>

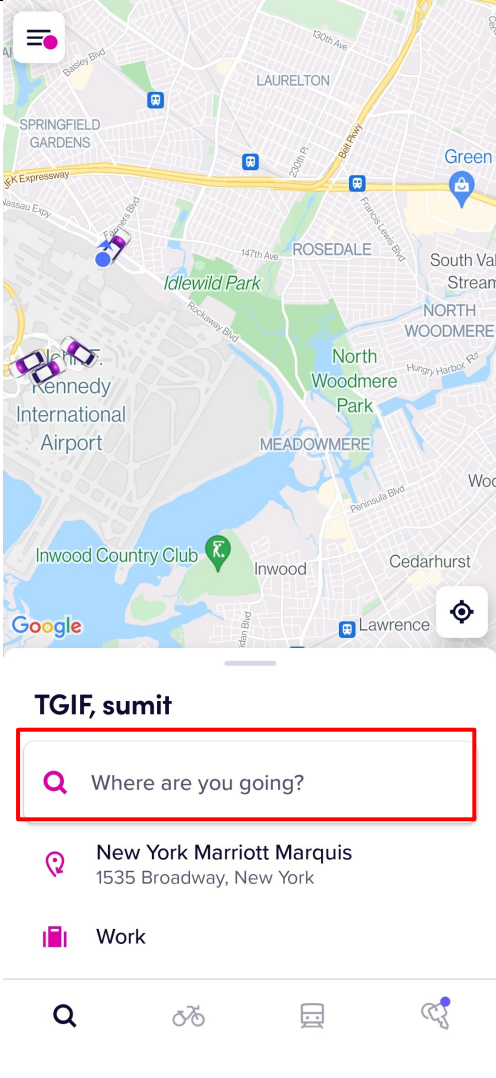
Exhibit C for US Patent No. 10,299,100 Against Lyft Accused Products

Claim 10,299,100	- Exemplary Supporting Evidence Regarding Lyft’s Accused Products
	<p>The Lyft apps for riders and drivers, in conjunction with Lyft’s servers and services, provide users with interactive methods to request, view, and track locations of passengers/riders using real-time maps and communications. The Lyft server(s) and their services communicate with the Lyft apps for riders and drivers. The Lyft server(s) and their services host information related to and instructions for processing user/device/vehicle accounts, location data, and map data. The claimed methods are distributed by Lyft in the Lyft apps. The claimed methods are used/tested by Lyft using the Lyft apps. The claimed methods are downloaded and installed by Lyft’s customers (riders) and personnel (drivers, personnel) at the direction/encouragement of Lyft and used by Lyft’s customers and Lyft’s personnel.</p> <p>This process is facilitated through drivers’ and passengers’ smart devices including but not limited to smartphones and tablets having Lyft and Lyft Driver app installed. The smart devices of passengers and drivers are contained in a portable housing.</p> <h2 data-bbox="478 716 968 792">Lyft Driver app</h2> <div data-bbox="472 829 1707 914" style="border: 1px solid red; padding: 5px;"> <p>We’ve separated the passenger and driver experiences into two separate mobile apps — one exclusively for passengers (named the Lyft app) and the other exclusively for drivers (named the Lyft Driver app).</p> </div> <p>The Lyft Driver app will eventually be standard for all drivers and required for driving. At this time, drivers can keep using the Lyft app to give rides. Don’t worry! While we have some planned improvements to the Lyft Driver app, we’ve kept its features the same.</p> <p>https://help.lyft.com/hc/en-ca/articles/115013079208-Lyft-Driver-app</p> <h2 data-bbox="478 1149 779 1198">What is Lyft?</h2> <p>Lyft is a platform that connects drivers with individuals and organizations that need rides.</p> <p>https://www.lyft.com/drive-with-lyft</p>

Exhibit C for US Patent No. 10,299,100 Against Lyft Accused Products

Claim 10,299,100	- Exemplary Supporting Evidence Regarding Lyft's Accused Products
	 <p data-bbox="470 662 596 688">Go online</p> <p data-bbox="470 727 1667 834">Open your Lyft Driver app and tap the steering wheel icon. Lyft will now find the closest passenger to your location requesting a ride. Turn on some music and get comfortable: that first ride request may come quickly or may take a while, depending on the number of current passenger requests.</p> <p data-bbox="470 841 1129 873">https://www.lyft.com/hub/posts/how-to-give-a-ride</p>

Exhibit C for US Patent No. 10,299,100 Against Lyft Accused Products

Claim 10,299,100	- Exemplary Supporting Evidence Regarding Lyft's Accused Products
	<p data-bbox="520 298 730 456">Driver's device displaying passenger's ride request message</p>  <p data-bbox="470 919 1381 951">https://www.youtube.com/watch?v=jVUy9poJDng at 10:24, Annotated</p>

Exhibit C for US Patent No. 10,299,100 Against Lyft Accused Products

Claim 10,299,100	- Exemplary Supporting Evidence Regarding Lyft's Accused Products
	 <p>https://www.youtube.com/watch?v=j0RDMLcmOgU at 4:01</p>

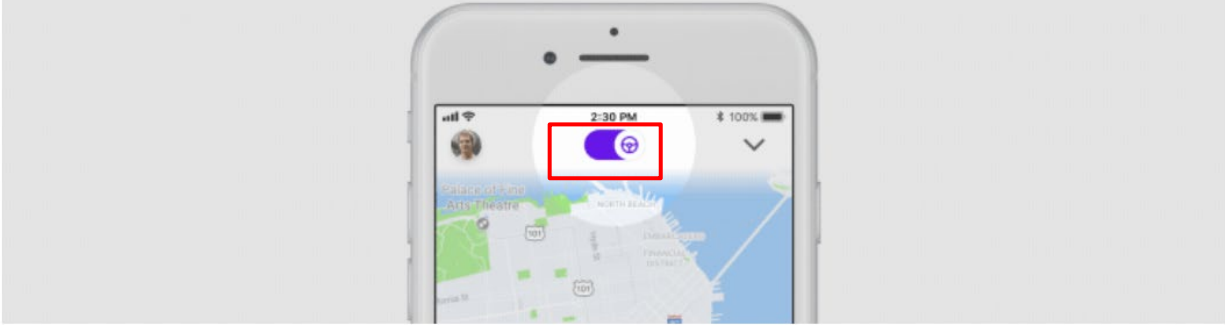
Exhibit C for US Patent No. 10,299,100 Against Lyft Accused Products

<p>Claim 10,299,100</p>	<p>- Exemplary Supporting Evidence Regarding Lyft’s Accused Products</p>
	 <p>Photo: iFixit</p> <p>https://spectrum.ieee.org/telecom/wireless/building-smartphone-antennas-that-play-nice-together</p> <p>Further, to the extent this element is performed at least in part by Lyft's software source code, AGIS reserves the right to supplement these contentions pursuant to production of such source code by Lyft and to the extent Defendant requires additional information in accordance with P.R. 3-1 and for any other reasons.</p>
<p>24[A]. a touch screen display, non-transitory</p>	<p>The Lyft Accused Products comprise a touch screen display, non-transitory computer-readable media, and a central processing unit (CPU).</p>

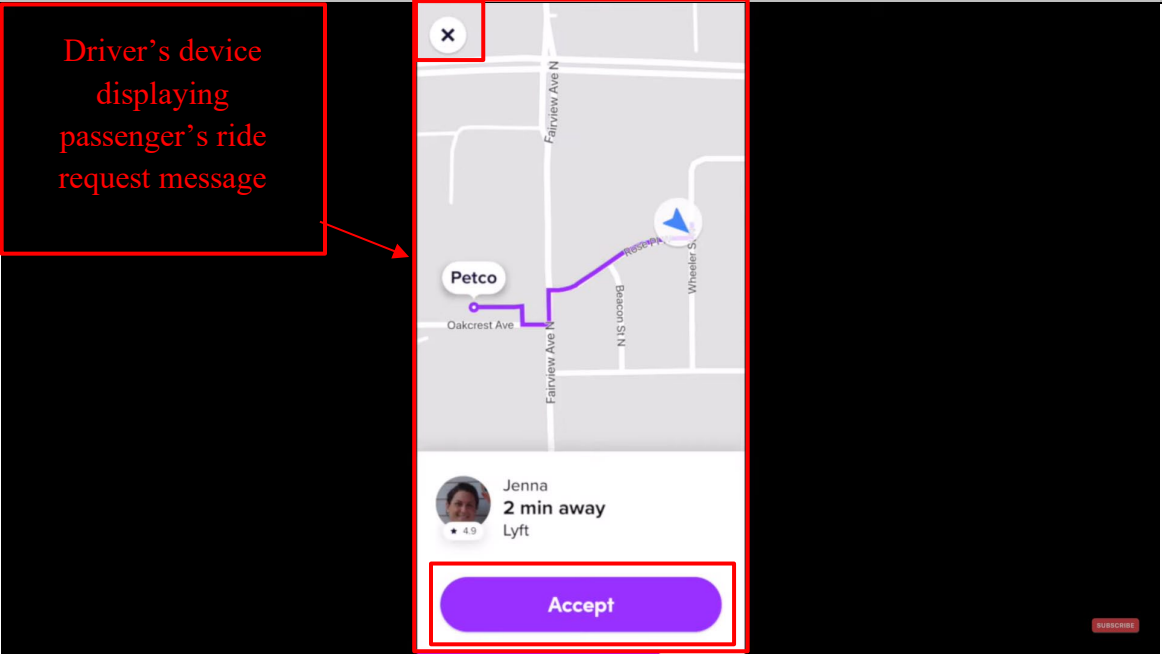
Exhibit C for US Patent No. 10,299,100 Against Lyft Accused Products

Claim 10,299,100	- Exemplary Supporting Evidence Regarding Lyft's Accused Products
<p>computer-readable media, and a central processing unit (CPU);</p>	<p>This element is infringed literally, or in the alternative, under the doctrine of equivalents.</p> <p>For example, Lyft drivers' and passengers' smart devices including but not limited to smartphones and tablets (with the Lyft or Lyft Driver app installed) comprises a display, processor and storage media.</p> <p>Combining multiple components into a single chip saves on space, cost, and power consumption. Essentially, an SoC is the brain of your smartphone that handles everything from the Android operating system to detecting when you press the power off button. SoCs connect to other components too, such as cameras, a display, RAM, flash storage, and much more.</p> <p>The list below contains the most common components that you will find inside a smartphone System-on-a-Chip. We're going to cover a few of the most important ones later on in this article.</p> <p>Central Processing Unit (CPU) — The “brains” of the SoC. Runs most of the code for the Android OS and most of your apps.</p> <ul style="list-style-type: none"> • Graphics Processing Unit (GPU) — Handles graphics-related tasks, such as visualizing an app's user interface and 2D/3D gaming. • Image Processing Unit (ISP) — Converts data from the phone's camera into image and video files. • Digital Signal Processor (DSP) — Handles more mathematically intensive functions than a CPU. Includes decompressing music files and analyzing gyroscope sensor data. • Neural Processing Unit (NPU) — Used in high-end smartphones to accelerate machine learning (AI) tasks. These include voice recognition and camera processing. • Video encoder/decoder — Handles the power-efficient conversion of video files and formats. • Modems — Converts wireless signals into data your phone understands. Components include 4G LTE, 5G, WiFi, and Bluetooth modems.

Exhibit C for US Patent No. 10,299,100 Against Lyft Accused Products

Claim 10,299,100	- Exemplary Supporting Evidence Regarding Lyft’s Accused Products
	<p>https://www.androidauthority.com/what-is-an-soc-smartphone-chipsets-explained-1051600/</p> <p>Further, to the extent this element is performed at least in part by Lyft's software source code, AGIS reserves the right to supplement these contentions pursuant to production of such source code by Lyft and to the extent Defendant requires additional information in accordance with P.R. 3-1 and for any other reasons.</p>
<p>24[B]. a mobile device transmitter communicatively coupled to the CPU;</p>	<p>The Lyft Accused Products comprise a mobile device transmitter communicatively coupled to the CPU.</p> <p>This element is infringed literally, or in the alternative, under the doctrine of equivalents.</p> <p>For example, Lyft drivers’ and passengers’ smart devices including but not limited to smartphones and tablets (with the Lyft or Lyft Driver app installed) comprise a transmitter module (antenna) coupled to a processor to send data.</p> <p>1. Antenna</p> <p>Antenna is used to receive and transmit radio frequency. It is inbuilt in the cabinet of the mobile phone. These are called inbuilt antenna.</p> <p>http://www.mobilecellphonerepairing.com/mobile-phone-parts.html</p>

Exhibit C for US Patent No. 10,299,100 Against Lyft Accused Products

Claim 10,299,100	- Exemplary Supporting Evidence Regarding Lyft's Accused Products
	<p>Mobile phone contents</p> <p>Mobile phones contain a large amount of circuitry, each of which is carefully designed to optimise its performance. The cell phone comprises analogue electronics as well as digital circuits ranging from processors to display and keypad electronics. A mobile phone typically consists of a single board, but within this there are a number of distinct functional areas, but designed to integrate to become a complete mobile phone:</p> <ul style="list-style-type: none"> • Radio frequency - receiver and transmitter • Digital signal processing • Analogue / digital conversion • Control processor • SIM or USIM card • Power control and battery <p>Source: https://www.electronics-notes.com/articles/connectivity/cellular-mobile-phone/how-cellphone-works-inside-components.php</p> <p>Further, to the extent this element is performed at least in part by Lyft's software source code, AGIS reserves the right to supplement these contentions pursuant to production of such source code by Lyft and to the extent Defendant requires additional information in accordance with P.R. 3-1 and for any other reasons.</p>
24[C]. a mobile device receiver communicatively coupled to the CPU;	<p>The Lyft Accused Products comprise a mobile device receiver communicatively coupled to the CPU.</p> <p>This element is infringed literally, or in the alternative, under the doctrine of equivalents.</p> <p>For example, Lyft drivers' and passengers' smart devices including but not limited to smartphones and tablets (with the Lyft or Lyft Driver app installed) comprise a receiver module (antenna) coupled to a processor to receive data.</p>

Exhibit C for US Patent No. 10,299,100 Against Lyft Accused Products

Claim 10,299,100	- Exemplary Supporting Evidence Regarding Lyft's Accused Products
	<p data-bbox="464 289 688 329">1. Antenna</p> <p data-bbox="464 375 1646 451">Antenna is used to receive and transmit radio frequency. It is inbuilt in the cabinet of the mobile phone. These are called inbuilt antenna.</p> <p data-bbox="464 475 1339 508">http://www.mobilecellphonerepairing.com/mobile-phone-parts.html</p> <p data-bbox="464 565 947 605">Mobile phone contents</p> <p data-bbox="464 651 1709 784">Mobile phones contain a large amount of circuitry, each of which is carefully designed to optimise its performance. The cell phone comprises analogue electronics as well as digital circuits ranging from processors to display and keypad electronics. A mobile phone typically consists of a single board, but within this there are a number of distinct functional areas, but designed to integrate to become a complete mobile phone:</p> <ul data-bbox="464 813 999 1125" style="list-style-type: none"> <li data-bbox="464 813 999 865">• Radio frequency - receiver and transmitter <li data-bbox="464 878 800 906">• Digital signal processing <li data-bbox="464 930 848 958">• Analogue / digital conversion <li data-bbox="464 987 726 1015">• Control processor <li data-bbox="464 1044 716 1071">• SIM or USIM card <li data-bbox="464 1101 810 1128">• Power control and battery <p data-bbox="464 1154 1860 1222">Source: https://www.electronics-notes.com/articles/connectivity/cellular-mobile-phone/how-cellphone-works-inside-components.php</p> <p data-bbox="464 1263 1892 1365">Further, to the extent this element is performed at least in part by Lyft's software source code, AGIS reserves the right to supplement these contentions pursuant to production of such source code by Lyft and to the extent Defendant requires additional information in accordance with P.R. 3-1 and for any other reasons.</p>

Exhibit C for US Patent No. 10,299,100 Against Lyft Accused Products

Claim 10,299,100	- Exemplary Supporting Evidence Regarding Lyft's Accused Products
<p>24[D]. a global positioning system (GPS) receiver, communicatively coupled to the CPU, configured to obtain geographical coordinates corresponding to a geographical location of the mobile device;</p>	<p>The Lyft Accused Products comprise a global positioning system (GPS) receiver, communicatively coupled to the CPU, configured to obtain geographical coordinates corresponding to a geographical location of the mobile device.</p> <p>This element is infringed literally, or in the alternative, under the doctrine of equivalents.</p> <p>For example, Lyft drivers' and passengers' smart devices including but not limited to smartphones and tablets (with the Lyft or Lyft Driver app installed) comprise a GPS module coupled to a processor to determine the location of the smart device.</p> <p>You must have seen that every Android and iOS device in today's age comes with GPS right inside it. This is one feature that will be there in every smartphone no matter what the price of that device might be. And that is because of the fact that GPS is the most basic yet most useful feature on every smartphone.</p> <p>Just for information, the GPS stands for Global Positioning System and it provides accurate geolocation and time information for every equipment that is equipped with a GPS receiver. Now, the best example of using GPS is with services such as Google Maps, Apple Maps, and others where you can see where exactly you are right now on the Map. This is thanks to the GPS receiver which sends a signal to the GPS satellite.</p> <p>https://www.cashify.in/how-to-turn-off-gps-on-any-android-or-ios-device</p> <p>Further, to the extent this element is performed at least in part by Lyft's software source code, AGIS reserves the right to supplement these contentions pursuant to production of such source code by Lyft and to the extent Defendant requires additional information in accordance with P.R. 3-1 and for any other reasons.</p>

Exhibit C for US Patent No. 10,299,100 Against Lyft Accused Products

Claim 10,299,100	- Exemplary Supporting Evidence Regarding Lyft's Accused Products
24[E]. the CPU configured to execute instructions to perform operations comprising:	<i>See Claim 1[A] above.</i>
24[F]. associating the mobile device with an identifier, wherein the identifier corresponds to a network participant	<i>See Claim 1[B] above.</i>
24[G]. determining, by the CPU, a device location corresponding to the geographical location of the mobile device based on the geographical coordinates obtained by the GPS receiver located within the mobile device;	<i>See Claim 1[C] above.</i>

Exhibit C for US Patent No. 10,299,100 Against Lyft Accused Products

Claim 10,299,100	- Exemplary Supporting Evidence Regarding Lyft's Accused Products
24[H]. receiving, from a server, mapping data including a map and coordinate translation data correlating coordinates of positions on the map with corresponding coordinates of geographical locations	<i>See Claim 1[D] above.</i>
24[I]. receiving, from a server, location data indicating vehicle locations of one or more vehicles	<i>See Claim 1[E] above.</i>
24[J]. marking the map with a plurality of symbols comprising: a participant symbol corresponding to the device location, one or more facility	<i>See Claim 1[F] above.</i>

Exhibit C for US Patent No. 10,299,100 Against Lyft Accused Products

<p>Claim 10,299,100</p>	<p>- Exemplary Supporting Evidence Regarding Lyft’s Accused Products</p>
<p>symbols corresponding to respective facility locations of one or more facilities, and one or more vehicle symbols corresponding to respective vehicle locations of the one or more vehicles, wherein marking the map comprises:</p>	
<p>24[K]. determining, based at least in part on the vehicle locations and the coordinate translation data, positions on the map corresponding to the vehicle locations, displaying the map on the display of the mobile device, and</p>	<p><i>See Claim 1[G] above.</i></p>

Exhibit C for US Patent No. 10,299,100 Against Lyft Accused Products

Claim 10,299,100	- Exemplary Supporting Evidence Regarding Lyft's Accused Products
<p>placing the vehicle symbols on the map at the determined positions corresponding to the vehicle locations;</p>	
<p>24[L]. responsive to user selection of a portion of the display corresponding to a position on the map, identifying a selected facility symbol based on the selected position, comprising: initiating a search of a set of symbols including the facility symbols for a symbol located nearest to the selected position and, based on a result of the search,</p>	<p><i>See Claim 1[H] above.</i></p>

Exhibit C for US Patent No. 10,299,100 Against Lyft Accused Products

Claim 10,299,100	- Exemplary Supporting Evidence Regarding Lyft's Accused Products
identifying the selected facility symbol as the symbol located nearest to the selected position;	
24[M]. after receiving user input on the touch screen display, transmitting, by the mobile device transmitter, first information to a first vehicle of the one or more vehicles; and	<i>See Claim 1[I] above.</i>
24[N]. after transmitting the first information to the first vehicle, receiving, at the mobile device receiver, second information corresponding to the first vehicle and displaying the received second information on	<i>See Claim 1[J] above.</i>

Exhibit C for US Patent No. 10,299,100 Against Lyft Accused Products

Claim 10,299,100	- Exemplary Supporting Evidence Regarding Lyft's Accused Products
the touch screen display of the mobile device,	
24[O]. wherein the mobile device does not have access to a phone number associated with a computing device corresponding to the first vehicle, an Internet Protocol (IP) address associated with the computing device corresponding to the first vehicle, and an e-mail address associated with the computing device corresponding to the first vehicle.	<i>See Claim 1[K] above.</i>
25. The system of claim 24, wherein the operations further comprise:	<i>See Claim 5 above.</i>

Exhibit C for US Patent No. 10,299,100 Against Lyft Accused Products

Claim 10,299,100	- Exemplary Supporting Evidence Regarding Lyft’s Accused Products
<p>receiving, from a server, at the mobile device receiver, updated respective vehicle locations of the one or more vehicles; and updating, based on the received updated vehicle locations and the coordinate translation data, positions of the one or more vehicle symbols on the map displayed on the touch screen display.</p>	
<p>26. The system of claim 24, wherein the operations further comprise: communicating, by the mobile device transmitter, the identifier to a server; and</p>	<p><i>See Claim 10 above.</i></p>

Exhibit C for US Patent No. 10,299,100 Against Lyft Accused Products

Claim 10,299,100	- Exemplary Supporting Evidence Regarding Lyft's Accused Products
joining a communication network after the communication of the first identifier to the server.	
27. The system of claim 26, wherein the identifier is a first identifier, and wherein the communication network comprises one or more communication devices corresponding, respectively, to one or more second vehicles, and wherein each of the one or more communication devices is associated with a respective second identifier.	<i>See Claim 11 above.</i>
28. The system of claim 27, wherein	The Lyft Accused Products infringe directly and/or indirectly by performing, inducing others to perform, and/or contributing to the performance of: the operations further comprise: receiving, by the mobile device receiver, the second identifiers corresponding to one or more communication devices; and displaying, on the map displayed

Exhibit C for US Patent No. 10,299,100 Against Lyft Accused Products

Claim 10,299,100	- Exemplary Supporting Evidence Regarding Lyft’s Accused Products
<p>the operations further comprise: receiving, by the mobile device receiver, the second identifiers corresponding to one or more communication devices; and displaying, on the map displayed on the touch screen display, one or more second vehicle symbols corresponding to the second identifiers corresponding to the second vehicles.</p>	<p>on the touch screen display, one or more second vehicle symbols corresponding to the second identifiers corresponding to the second vehicles.</p> <p>This element is infringed literally, or in the alternative, under the doctrine of equivalents.</p> <p>For example, before a passenger requests for a ride, the Lyft app displays symbols corresponding to multiple vehicles based on their location near the passenger’s location. Therefore, Lyft’s servers fetch identifiers and locations of the drivers and their vehicles and display the drivers as symbols on the passenger’s mobile device.</p>

Exhibit C for US Patent No. 10,299,100 Against Lyft Accused Products

Claim 10,299,100	- Exemplary Supporting Evidence Regarding Lyft's Accused Products
	 <p>The screenshot displays the Lyft mobile application interface. At the top, a map shows the area around JFK International Airport and surrounding neighborhoods like Rosedale and North Woodmere. A red rectangular box highlights a car icon with a driver's profile picture, indicating a nearby vehicle. Below the map, the text "TGIF, sumit" is visible. A search bar contains the text "Where are you going?". Below the search bar, there are three suggestions: "New York Marriott Marquis" with the address "1535 Broadway, New York", and "Work". At the bottom of the screen, there are icons for search, bicycle, bus, and carpooling.</p>

Exhibit C for US Patent No. 10,299,100 Against Lyft Accused Products

Claim 10,299,100	- Exemplary Supporting Evidence Regarding Lyft's Accused Products
	Further, to the extent this element is performed at least in part by Lyft's software source code, AGIS reserves the right to supplement these contentions pursuant to production of such source code by Lyft and to the extent Defendant requires additional information in accordance with P.R. 3-1 and for any other reasons.
29. The system of claim 27, wherein the operations further comprise: receiving, by the mobile device receiver, the second identifiers corresponding to one or more communication devices; and displaying, on the map displayed on the touch screen display, one or more second vehicle symbols corresponding to the second identifiers corresponding to the second vehicles.	<i>See Claim 12 above.</i>
30. The system of claim 24, wherein:	The Lyft Accused Products infringe directly and/or indirectly by performing, inducing others to perform, and/or contributing to the performance of: The system of claim 24, wherein: transmitting the first information to the first vehicle comprises transmitting data to a server using an Internet Protocol; the data transmitted to the server includes the first information and a second identifier corresponding to a second network participant associated

Exhibit C for US Patent No. 10,299,100 Against Lyft Accused Products

Claim 10,299,100	- Exemplary Supporting Evidence Regarding Lyft’s Accused Products
<p>transmitting the first information to the first vehicle comprises transmitting data to a server using an Internet Protocol; the data transmitted to the server includes the first information and a second identifier corresponding to a second network participant associated with the computing device corresponding to the first vehicle; the second information corresponding to the first vehicle is transmitted by the server to the mobile device using the Internet Protocol; and</p>	<p>with the computing device corresponding to the first vehicle; the second information corresponding to the first vehicle is transmitted by the server to the mobile device using the Internet Protocol; and an IP address of the server is accessible to the mobile device.</p> <p>This element is infringed literally, or in the alternative, under the doctrine of equivalents.</p> <p>For example, Lyft’s servers access passengers’ and drivers’ data through the Lyft app installed on the passengers’ and drivers’ mobile devices using an Internet Protocol. All information including but not limited to the location information and the identifier are transmitted to the Lyft servers via Internet Protocol.</p> <h2 data-bbox="478 646 968 719">Lyft Driver app</h2> <div data-bbox="472 756 1707 842" style="border: 1px solid red; padding: 5px;"> <p>We’ve separated the passenger and driver experiences into two separate mobile apps — one exclusively for passengers (named the Lyft app) and the other exclusively for drivers (named the Lyft Driver app).</p> </div> <p>The Lyft Driver app will eventually be standard for all drivers and required for driving. At this time, drivers can keep using the Lyft app to give rides. Don’t worry! While we have some planned improvements to the Lyft Driver app, we’ve kept its features the same.</p> <p>https://help.lyft.com/hc/en-ca/articles/115013079208-Lyft-Driver-app</p> <h2 data-bbox="478 1078 779 1125">What is Lyft?</h2> <p>Lyft is a platform that connects drivers with individuals and organizations that need rides.</p> <p>https://www.lyft.com/drive-with-lyft</p>

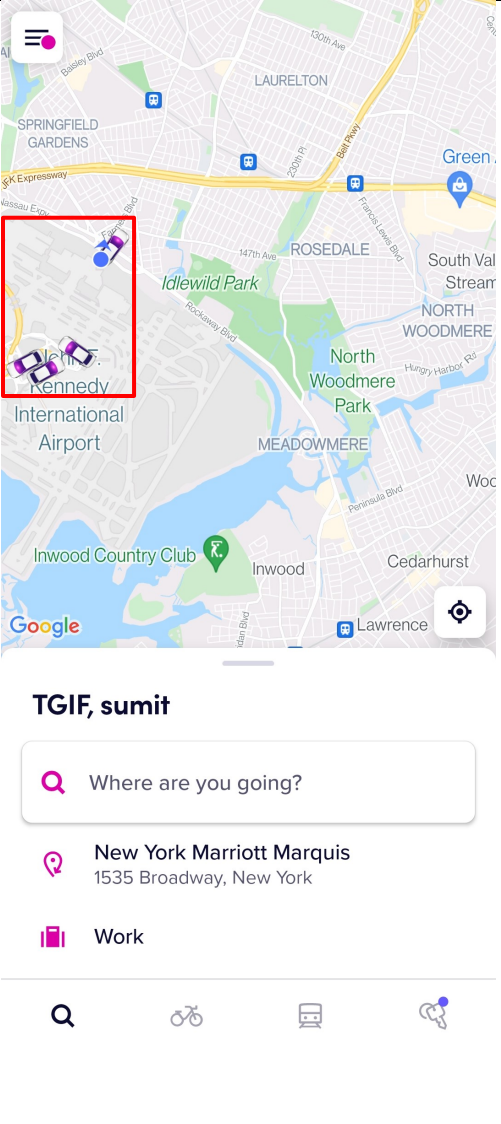
Exhibit C for US Patent No. 10,299,100 Against Lyft Accused Products

Claim 10,299,100	- Exemplary Supporting Evidence Regarding Lyft's Accused Products
an IP address of the server is accessible to the mobile device.	Further, to the extent this element is performed at least in part by Lyft's software source code, AGIS reserves the right to supplement these contentions pursuant to production of such source code by Lyft and to the extent Defendant requires additional information in accordance with P.R. 3-1 and for any other reasons.
31. The system of claim 30, wherein: the server stores an IP address of the computing device associated with the second network participant identified by the second identifier; and the server transmits the first information to the computing device corresponding to the first vehicle in a message addressed to the stored IP address of the computing device corresponding to the first vehicle.	<i>See claim 30 above.</i>

Exhibit D for US Patent No. 8,213,970 Against Lyft Accused Products

Based on information presently available, AGIS Software Development LLC (“AGIS”) contends that Defendant Lyft Technologies Inc. (collectively “Lyft” or “Defendant”) infringes claims 2, 10-13 (the “Asserted Claims”) of U.S. Patent No. 8,213,970 (the “’970 Patent”) through the Accused Products which are manufactured, sold, offered for sale, and/or used by Lyft.

The Accused Products comprise all versions of the Lyft Application made, used, sold, offered for sale, or otherwise provided, after September 21, 2004. For example, the Accused Products comprise the Lyft application installed on all Android, iOS, Blackberry, and Windows Mobile based mobile devices (e.g. smartphones, tablets, laptops, and smart watches), and any variants thereof. AGIS reserves the right to amend this list of Accused Products as discovery progresses.

Lyft directly infringes each of the Asserted Claims by using, importing, testing, selling, and/or offering for sale the Accused Products in violation of 35 U.S.C. § 271(a).

Lyft indirectly infringes the Asserted Claims in violation of 35 U.S.C. § 271(b) by inducing third parties, including its users and/or customers, to directly infringe through their operation and use of the Accused Products. Lyft has knowingly and intentionally induced this direct infringement by, *inter alia*, (i) selling, importing, or otherwise providing the Accused Products to third parties with the intent that the Accused Products will be operated and used in a manner that practices the Asserted Claims; and (ii) marketing and advertising the Accused Products. Lyft’s marketing and promotional materials for the Accused Products are found, for example, on Lyft’s website, and in App stores of operating systems for which the Accused Products are made available. For example, Lyft’s website offers customers instructions and/or manuals for the Accused Products that instruct customers to, among other things, use the accused services in the Accused Products. Lyft’s website also offers support to customers, including instruction to, among other things, use the Accused Products share location information with a group of users. On information and belief, Lyft knows that its actions will result in infringement of the Asserted Claims, or subjectively believes that there is a high probability that its actions will result in infringement of the Asserted Claims but has taken deliberate actions to avoid learning these facts.

Lyft also contributorily infringes each of the Asserted Claims in violation of 35 U.S.C. § 271(c) by selling, importing, offering for sale, and otherwise providing the Accused Products, which when used directly infringe the Asserted Claims. The Accused Products constitute a material part of the Asserted Claims.

On information and belief, the charted version of the Lyft application is representative of all versions of the Accused Products, including all variants of the Accused Products made, sold, offered for sale, or used on any version of the Android, iOS, Blackberry, and Windows Mobile operating systems.

Exhibit D for US Patent No. 8,213,970 Against Lyft Accused Products

AGIS does not concede that any claims of the '970 Patent that are not listed below are not infringed by the identified Accused Products. Moreover, the citations to certain documents and other information below are intended to be exemplary only and in no way foreclose AGIS from citing or relying on additional documents, information, source code, and/or testimony at a later time. These contentions are preliminary in nature, and an analysis of Lyft's products, internal documentation, source code, and/or testimony from relevant witnesses may more fully and accurately describe the infringing features of its Accused Products. Accordingly, AGIS reserves the right to supplement, correct, modify, and/or amend these contentions once such additional information is made available to AGIS. Furthermore, AGIS reserves the right to supplement, correct, modify, and/or amend these contentions as discovery in this case progresses; in view of the Court's claim construction order(s); in view of any positions taken by Lyft, including, but not limited to, positions on claim construction,¹ invalidity, and/or non-infringement; and in connection with the preparation and exchange of expert reports.

The contents of each claim cell below on which another claim cell depends are expressly incorporated by reference in that dependent cell, as if set forth in their entirety therein.

¹ The construction of claim terms herein is consistent with the constructions in *AGIS Software Dev. LLC v. Huawei Device USA, Inc.*, No. 2:17-cv-00513-JRG, Dkt. No. 205 (Lead Case) (E.D. Tex. Oct. 10, 2018) and *AGIS Software Dev. LLC v. Google LLC*, No. 2:19-cv-00361-JRG, Dkt. No. 147 (Lead Case) (E.D. Tex. Dec. 20, 2020). AGIS reserves the right to update its constructions and contentions in view of this Court's claim construction order.

Exhibit D for US Patent No. 8,213,970 Against Lyft Accused Products

Claim - 8,213,970	Exemplary Supporting Evidence Regarding Accused Products
<p>(Unasserted) 1[P]. A communication system for transmitting, receiving, confirming receipt, and responding to an electronic message, comprising:</p>	<p>The Lyft Accused Products comprise a communication system for transmitting, receiving, confirming receipt, and responding to an electronic message. Lyft infringe directly and/or indirectly by providing a communication system for transmitting, receiving, confirming receipt, and responding to an electronic message.</p> <p>This element is infringed literally, or in the alternative, under the doctrine of equivalents.</p> <p>For example, Lyft provides Lyft app for passengers and Lyft Driver app for drivers. The Lyft apps for riders and drivers, in conjunction with Lyft’s servers and services, provide users with interactive methods to request, view, and track locations of passengers/riders using real-time maps and communications. The Lyft server(s) and their services communicate with the Lyft apps for riders and drivers. The Lyft server(s) and their services host information related to and instructions for processing user/device/vehicle accounts, location data, and map data. The claimed methods are distributed by Lyft in the Lyft apps. The claimed methods are used/tested by Lyft using the Lyft apps. The claimed methods are downloaded and installed by Lyft’s customers (riders) and personnel (drivers, personnel) at the direction/encouragement of Lyft and used by Lyft’s customers and Lyft’s personnel.</p> <p>The Lyft Driver application receives an electronically transmitted request for a ride message and acknowledges the receipt of the message which triggers a forced message alert that locks the device for a period of time until the driver sends a response message (decline or accept) to clear the locked display (“transmitting, receiving, confirming receipt, and responding to an electronic message”).</p> <h3 style="margin-top: 20px;">Lyft Driver app</h3> <div style="border: 2px solid red; padding: 5px; margin: 10px 0;"> <p>We’ve separated the passenger and driver experiences into two separate mobile apps — one exclusively for passengers (named the Lyft app) and the other exclusively for drivers (named the Lyft Driver app).</p> </div> <p>The Lyft Driver app will eventually be standard for all drivers and required for driving. At this time, drivers can keep using the Lyft app to give rides. Don’t worry! While we have some planned improvements to the Lyft Driver app, we’ve kept its features the same.</p> <p>https://help.lyft.com/hc/en-ca/articles/115013079208-Lyft-Driver-app</p>

Exhibit D for US Patent No. 8,213,970 Against Lyft Accused Products

Claim - 8,213,970	Exemplary Supporting Evidence Regarding Accused Products
	<p data-bbox="491 245 793 293">What is Lyft?</p> <p data-bbox="491 347 1560 415">Lyft is a platform that connects drivers with individuals and organizations that need rides.</p> <p data-bbox="483 444 957 477">https://www.lyft.com/drive-with-lyft</p>  <p data-bbox="483 911 606 935">Go online</p> <p data-bbox="478 976 1682 1081">Open your Lyft Driver app and tap the steering wheel icon. Lyft will now find the closest passenger to your location requesting a ride. Turn on some music and get comfortable: that first ride request may come quickly or may take a while, depending on the number of current passenger requests.</p> <p data-bbox="483 1089 1140 1122">https://www.lyft.com/hub/posts/how-to-give-a-ride</p>

Exhibit D for US Patent No. 8,213,970 Against Lyft Accused Products

Claim - 8,213,970	Exemplary Supporting Evidence Regarding Accused Products
	<p data-bbox="533 261 743 423">Driver's device displaying passenger's ride request message</p>  <p data-bbox="478 883 1398 915">https://www.youtube.com/watch?v=jVUy9poJDng at 10:24, Annotated</p>

Exhibit D for US Patent No. 8,213,970 Against Lyft Accused Products

Claim - 8,213,970	Exemplary Supporting Evidence Regarding Accused Products
	 <p>https://www.youtube.com/watch?v=j0RDMLcmOgU at 4:01</p> <p>Further, to the extent this element is performed at least in part by Lyft's software source code, AGIS reserves the right to supplement these contentions pursuant to production of such source code by Lyft and to the extent Defendant requires additional information in accordance with P.R. 3-1 and for any other reasons.</p>
1[A]. a predetermined network of participants, wherein each participant has a similarly equipped	<p>The Lyft Accused Products comprise: a predetermined network of participants, wherein each participant has a similarly equipped PDA/cell phone that includes a CPU and a touch screen display a CPU and memory.</p> <p>This element is infringed literally, or in the alternative, under the doctrine of equivalents.</p> <p>For example, Lyft is a network of drivers and passengers where drivers connect with individuals requesting a ride. Drivers access the platform using the Lyft Driver app and passengers access the platform using the Lyft</p>

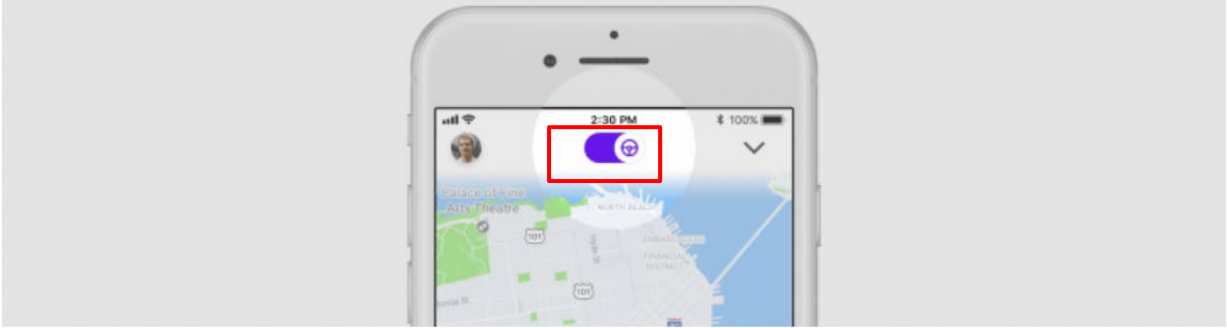
Exhibit D for US Patent No. 8,213,970 Against Lyft Accused Products

Claim - 8,213,970	Exemplary Supporting Evidence Regarding Accused Products
<p>PDA/cell phone that includes a CPU and a touch screen display a CPU and memory</p>	<p>app on their respective smart devices including but not limited to smartphones and tablets comprising a display, a processor and a storage media.</p> <h1 data-bbox="489 354 978 427">Lyft Driver app</h1> <div data-bbox="485 464 1719 548" style="border: 1px solid red; padding: 5px;"><p>We've separated the passenger and driver experiences into two separate mobile apps — one exclusively for passengers (named the Lyft app) and the other exclusively for drivers (named the Lyft Driver app).</p></div> <p>The Lyft Driver app will eventually be standard for all drivers and required for driving. At this time, drivers can keep using the Lyft app to give rides. Don't worry! While we have some planned improvements to the Lyft Driver app, we've kept its features the same.</p> <p>https://help.lyft.com/hc/en-ca/articles/115013079208-Lyft-Driver-app</p> <h2 data-bbox="489 784 789 833">What is Lyft?</h2> <p>Lyft is a platform that connects drivers with individuals and organizations that need rides.</p> <p>https://www.lyft.com/drive-with-lyft</p>

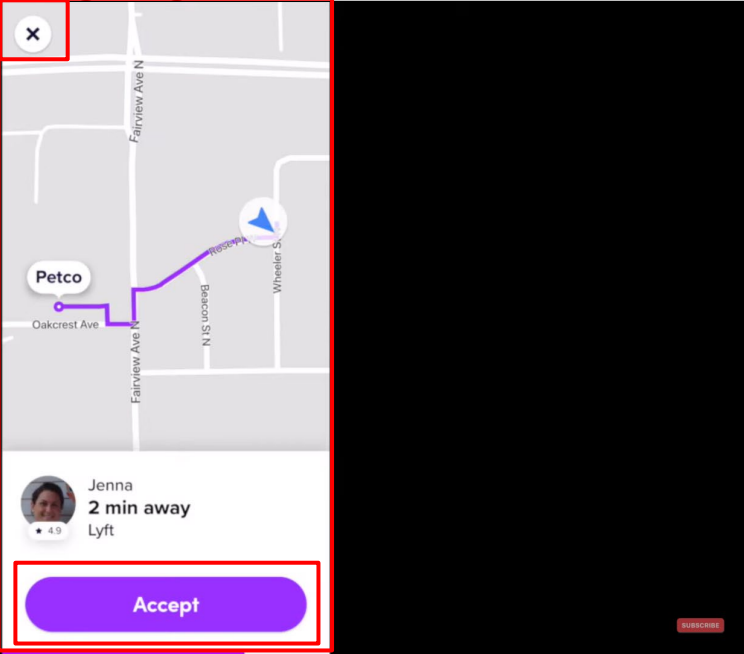
Exhibit D for US Patent No. 8,213,970 Against Lyft Accused Products

Claim - 8,213,970	Exemplary Supporting Evidence Regarding Accused Products
	 <p data-bbox="485 626 604 651">Go online</p> <p data-bbox="485 688 1682 834">Open your Lyft Driver app and tap the steering wheel icon. Lyft will now find the closest passenger to your location requesting a ride. Turn on some music and get comfortable: that first ride request may come quickly or may take a while, depending on the number of current passenger requests. <a data-bbox="485 802 1136 834" href="https://www.lyft.com/hub/posts/how-to-give-a-ride">https://www.lyft.com/hub/posts/how-to-give-a-ride</p>

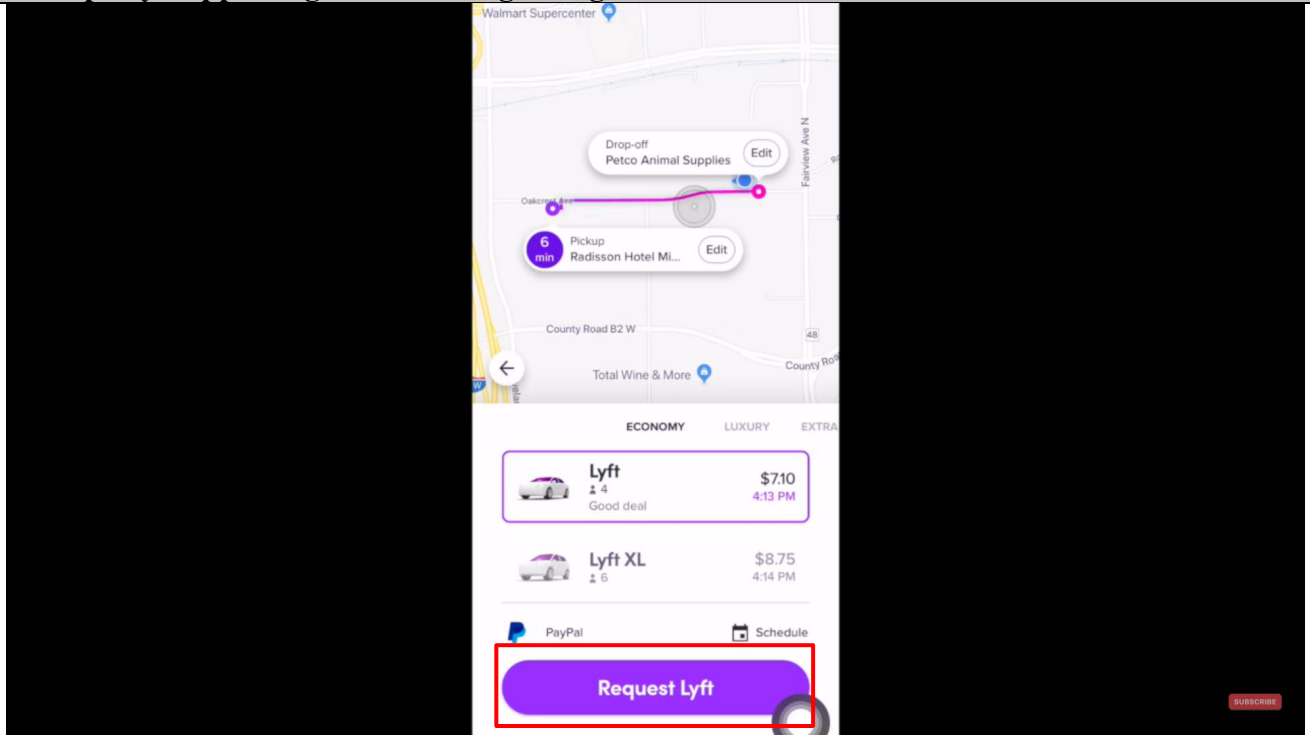
Exhibit D for US Patent No. 8,213,970 Against Lyft Accused Products

Claim - 8,213,970	Exemplary Supporting Evidence Regarding Accused Products
	<p data-bbox="533 261 743 423">Driver's device displaying passenger's ride request message</p>  <p data-bbox="478 883 1398 915">https://www.youtube.com/watch?v=jVUy9poJDng at 10:24, Annotated</p>

Exhibit D for US Patent No. 8,213,970 Against Lyft Accused Products

Claim - 8,213,970	Exemplary Supporting Evidence Regarding Accused Products
	 <p>https://www.youtube.com/watch?v=j0RDMLcmOgU at 4:01</p>

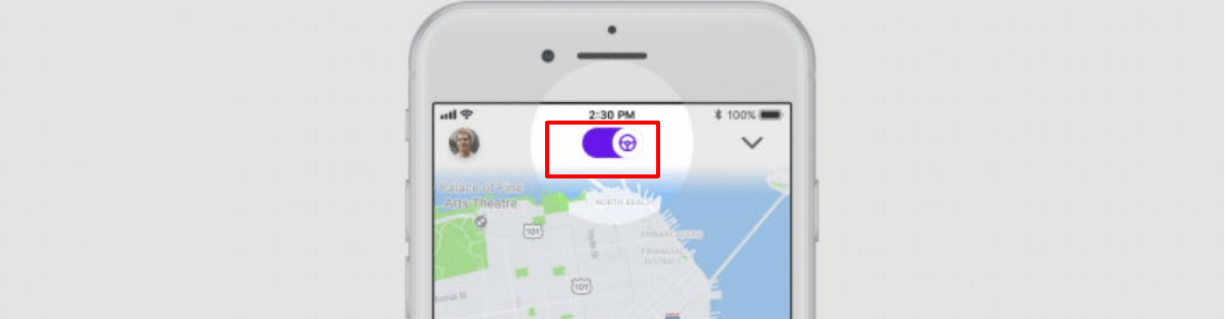
Exhibit D for US Patent No. 8,213,970 Against Lyft Accused Products

Claim - 8,213,970	Exemplary Supporting Evidence Regarding Accused Products
	 <p>https://apps.apple.com/in/app/lyft/id529379082</p> <h3>5. Central Processing Unit (CPU)</h3> <p>The CPU is the Main Control Section of a mobile phone, Android Smartphone and Apple iPhone. It controls all the function and does all the processing work.</p> <p>http://www.mobilecellphonerepairing.com/mobile-phone-parts.html</p>

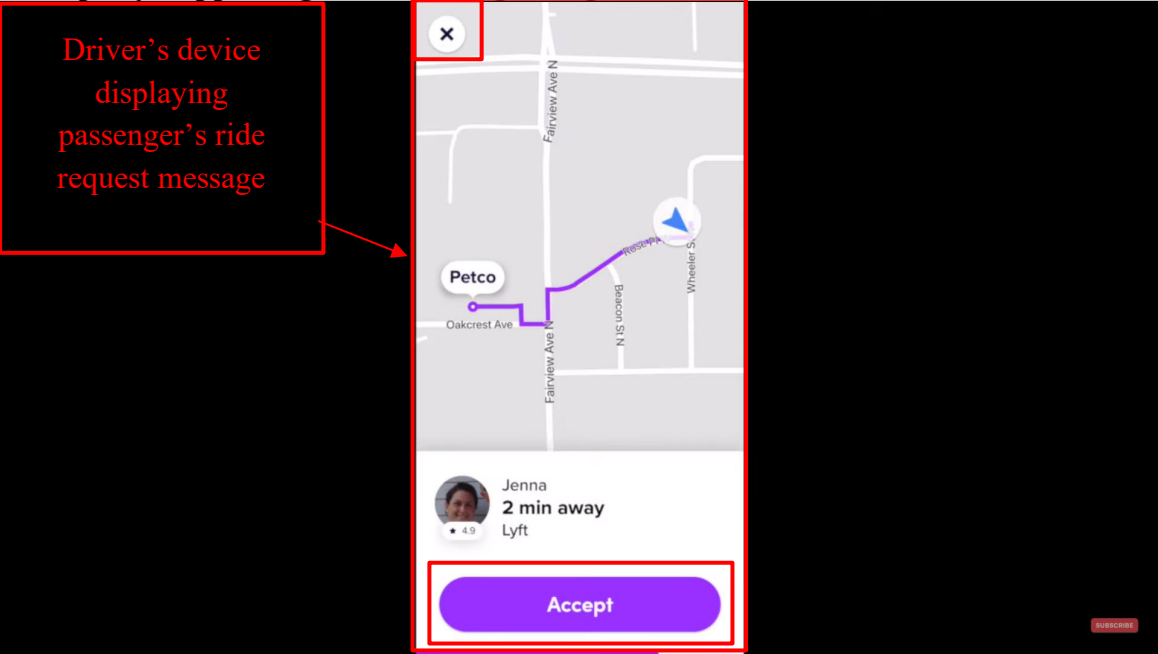
Exhibit D for US Patent No. 8,213,970 Against Lyft Accused Products

Claim - 8,213,970	Exemplary Supporting Evidence Regarding Accused Products
	<p data-bbox="499 240 1203 289">6. RAM (<i>Random Access Memory</i>)</p> <p data-bbox="499 329 1728 407">RAM is an erasable memory where older data and information can be erased and new data and information can be stored.</p> <p data-bbox="485 456 1352 488">http://www.mobilecellphonerepairing.com/mobile-phone-parts.html</p> <p data-bbox="478 529 1881 630">Further, to the extent this element is performed at least in part by Lyft's software source code, AGIS reserves the right to supplement these contentions pursuant to production of such source code by Lyft and to the extent Defendant requires additional information in accordance with P.R. 3-1 and for any other reasons.</p>
1[B]. a data transmission means that facilitates the transmission of electronic files between said PDA/cell phones in different locations	<p data-bbox="478 643 1814 743">The Lyft Accused Products infringe directly and/or indirectly by performing, inducing others to perform, and/or contributing to the performance of: a data transmission means that facilitates the transmission of electronic files between said PDA/cell phones in different locations</p> <p data-bbox="478 784 1608 816">This element is infringed literally, or in the alternative, under the doctrine of equivalents.</p> <p data-bbox="478 857 1839 997">For example, Lyft's servers connect passengers to nearby drivers when a request for a ride is placed. The servers receive a passenger's request for a ride and communicate the request to nearby drivers. The nearby drivers receive the request for a ride from the passengers to which they either accept or decline the request. The locations of the passenger and the nearby drivers are different from each other.</p>

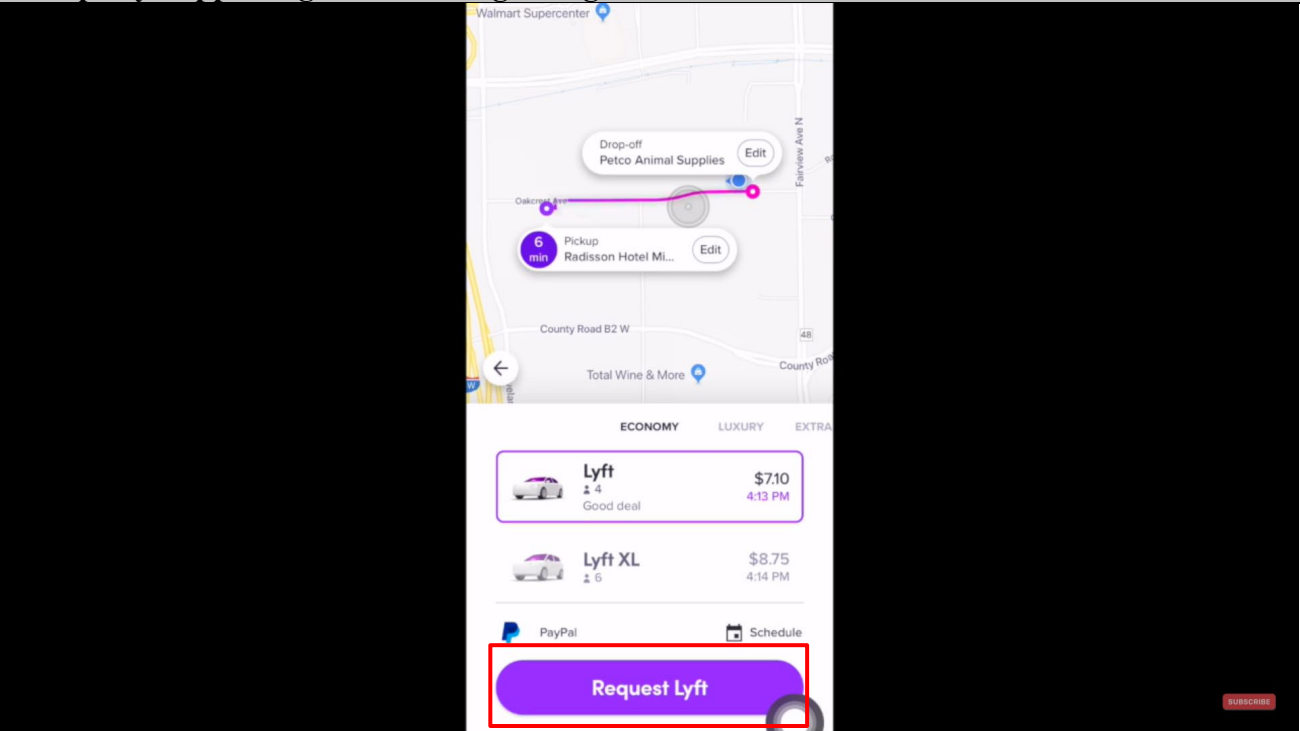
Exhibit D for US Patent No. 8,213,970 Against Lyft Accused Products

Claim - 8,213,970	Exemplary Supporting Evidence Regarding Accused Products
	 <p data-bbox="485 630 604 651">Go online</p> <p data-bbox="485 691 1682 834">Open your Lyft Driver app and tap the steering wheel icon. Lyft will now find the closest passenger to your location requesting a ride. Turn on some music and get comfortable: that first ride request may come quickly or may take a while, depending on the number of current passenger requests. <a data-bbox="485 805 1136 834" href="https://www.lyft.com/hub/posts/how-to-give-a-ride">https://www.lyft.com/hub/posts/how-to-give-a-ride</p>

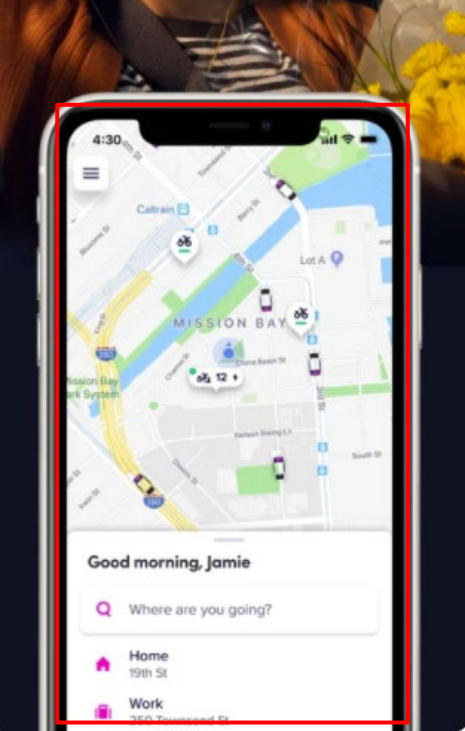
Exhibit D for US Patent No. 8,213,970 Against Lyft Accused Products

Claim - 8,213,970	Exemplary Supporting Evidence Regarding Accused Products
	<p data-bbox="533 261 743 423">Driver's device displaying passenger's ride request message</p>  <p data-bbox="478 883 1398 915">https://www.youtube.com/watch?v=jVUy9poJDng at 10:24, Annotated</p>

Exhibit D for US Patent No. 8,213,970 Against Lyft Accused Products

Claim - 8,213,970	Exemplary Supporting Evidence Regarding Accused Products
	 <p>https://www.youtube.com/watch?v=j0RDMLcmOgU at 4:01</p> <p>Further, to the extent this element is performed at least in part by Lyft's software source code, AGIS reserves the right to supplement these contentions pursuant to production of such source code by Lyft and to the extent Defendant requires additional information in accordance with P.R. 3-1 and for any other reasons.</p>
<p>1[C]. a sender PDA/cell phone and at least one recipient PDA/cell phone for each electronic message</p>	<p>The Lyft Accused Products infringe directly and/or indirectly by performing, inducing others to perform, and/or contributing to the performance of: a sender PDA/cell phone and at least one recipient PDA/cell phone for each electronic message</p> <p>This element is infringed literally, or in the alternative, under the doctrine of equivalents.</p>

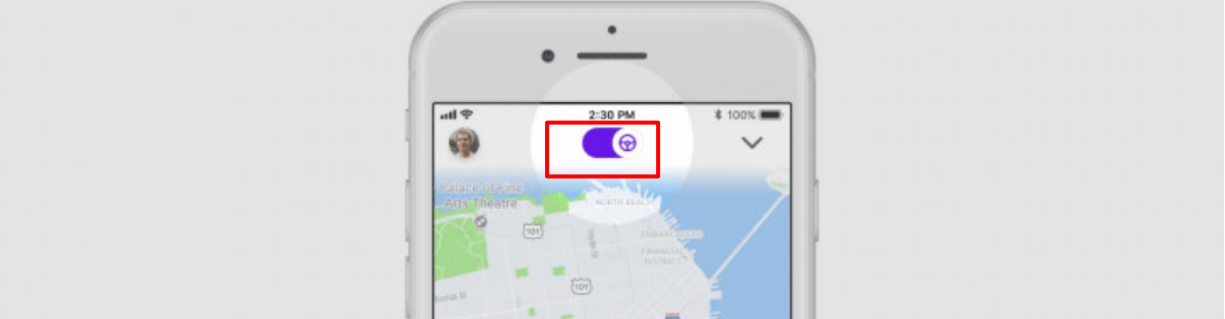
Exhibit D for US Patent No. 8,213,970 Against Lyft Accused Products

Claim - 8,213,970	Exemplary Supporting Evidence Regarding Accused Products
	<p>For example, Lyft's servers connects the passengers ("sender") to the nearby drivers ("recipient") when a request for a ride is placed. The servers receive a passenger's request for a ride and communicates the request to nearby drivers. The nearby drivers receive the request for a ride from the passengers to which they either accept or decline the request.</p>  <p>Go online</p> <p>Open your Lyft Driver app and tap the steering wheel icon. Lyft will now find the closest passenger to your location requesting a ride. Turn on some music and get comfortable: that first ride request may come quickly or may take a while, depending on the number of current passenger requests.</p> <p>https://www.lyft.com/hub/posts/how-to-give-a-ride</p>

Exhibit D for US Patent No. 8,213,970 Against Lyft Accused Products

Claim - 8,213,970	Exemplary Supporting Evidence Regarding Accused Products
	<p data-bbox="533 261 743 423">Driver's device displaying passenger's ride request message</p>  <p data-bbox="478 883 1398 915">https://www.youtube.com/watch?v=jVUy9poJDng at 10:24, Annotated</p>

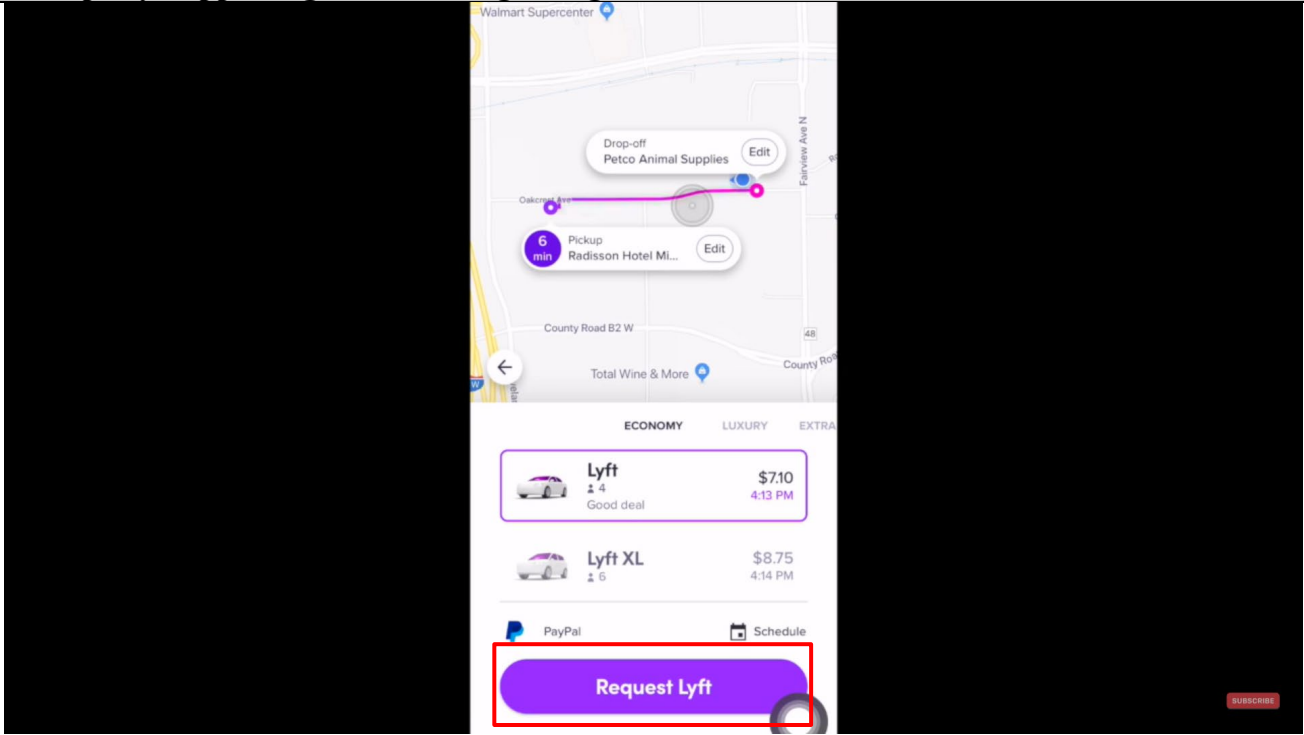
Exhibit D for US Patent No. 8,213,970 Against Lyft Accused Products

Claim - 8,213,970	Exemplary Supporting Evidence Regarding Accused Products
	 <p>https://www.youtube.com/watch?v=j0RDMLcmOgU at 4:01</p>

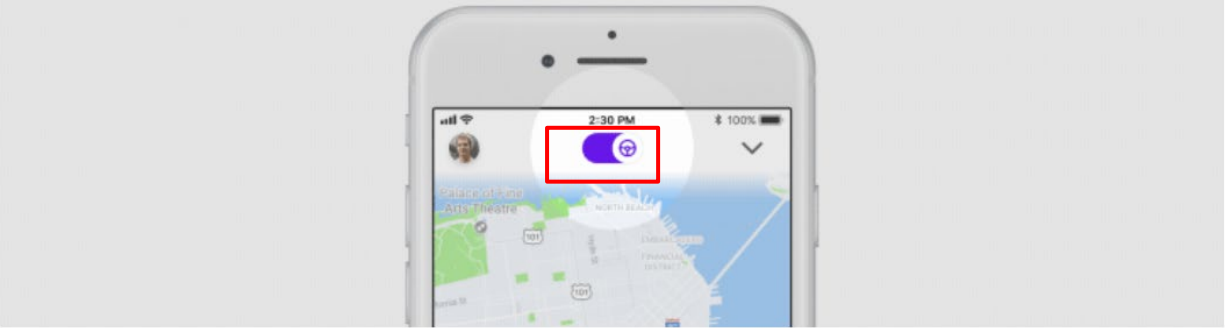
Exhibit D for US Patent No. 8,213,970 Against Lyft Accused Products

Claim - 8,213,970	Exemplary Supporting Evidence Regarding Accused Products
	 <p>The screenshot displays the Lyft app interface. At the top, the route is set from Terminal 1, Arrivals to New York Marriott Marquis. The map shows the area around JFK Airport, with a red box highlighting two nearby driver locations. A red box also highlights the passenger's location at the airport. Below the map, three ride options are listed: Lyft (US\$64.81, 3:20 AM), Lyft XL (US\$81.65, 3:22 AM), and Car seat (US\$76.50, 3:34 AM). A large purple button at the bottom says "Select Lyft".</p> <p>Nearby Drivers' location</p> <p>Passenger's location</p>

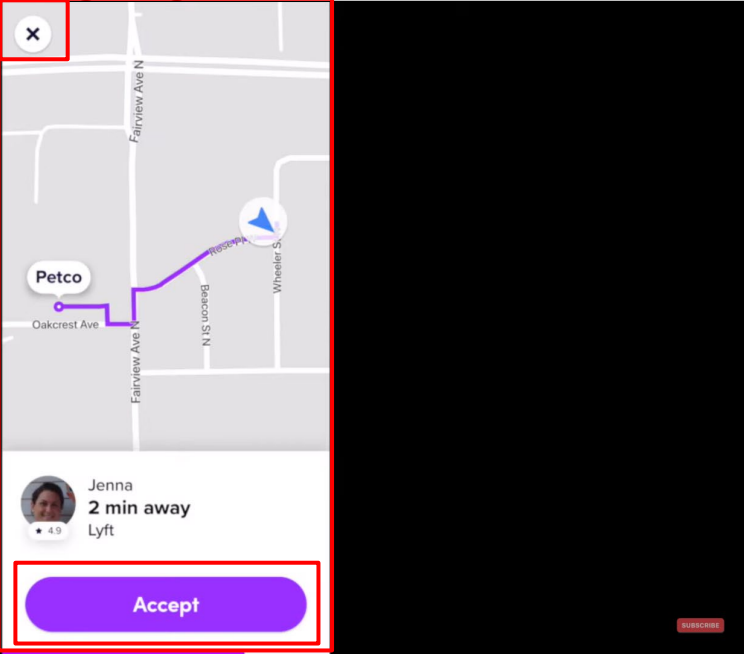
Exhibit D for US Patent No. 8,213,970 Against Lyft Accused Products

Claim - 8,213,970	Exemplary Supporting Evidence Regarding Accused Products
	Further, to the extent this element is performed at least in part by Lyft's software source code, AGIS reserves the right to supplement these contentions pursuant to production of such source code by Lyft and to the extent Defendant requires additional information in accordance with P.R. 3-1 and for any other reasons.
1[D]. a forced message alert software application program including a list of required possible responses to be selected by a participant recipient of a forced message response loaded on each participating PDA/cell phone	<p>The Lyft Accused Products infringe directly and/or indirectly by performing, inducing others to perform, and/or contributing to the performance of: a forced message alert software application program including a list of required possible responses to be selected by a participant recipient of a forced message response loaded on each participating PDA/cell phone</p> <p>This element is infringed literally, or in the alternative, under the doctrine of equivalents.</p> <p>For example, Lyft provides Lyft app for passengers and Lyft Driver app for drivers. The Lyft apps for riders and drivers, in conjunction with Lyft's servers and services, provide users with interactive methods to request, view, and track locations of passengers/riders using real-time maps and communications. The Lyft server(s) and their services communicate with the Lyft apps for riders and drivers. The Lyft server(s) and their services host information related to and instructions for processing user/device/vehicle accounts, location data, and map data. The claimed methods are distributed by Lyft in the Lyft apps. The claimed methods are used/tested by Lyft using the Lyft apps. The claimed methods are downloaded and installed by Lyft's customers (riders) and personnel (drivers, personnel) at the direction/encouragement of Lyft and used by Lyft's customers and Lyft's personnel.</p> <p>The Lyft Driver application receives an electronically transmitted request for a ride which triggers a forced message alert that locks the device for a period of time until the driver ("recipient") sends a response message (decline or accept) to clear the locked display.</p>

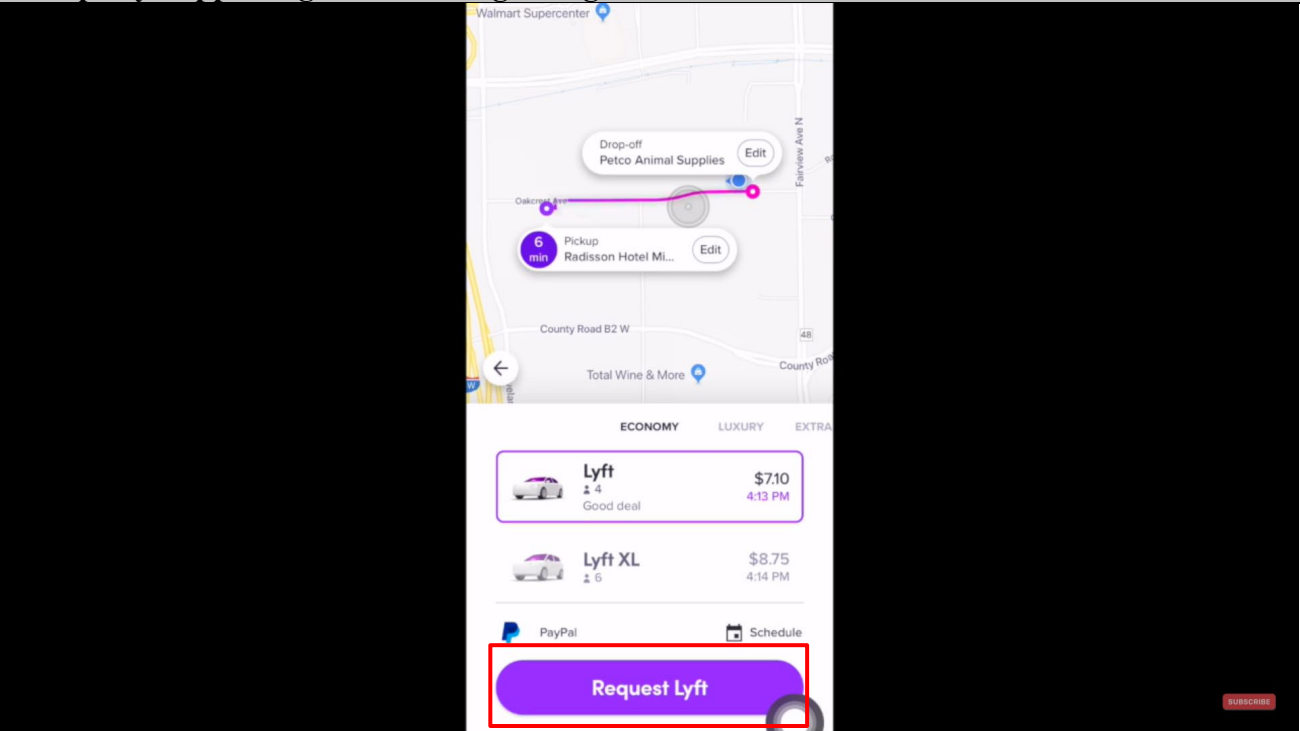
Exhibit D for US Patent No. 8,213,970 Against Lyft Accused Products

Claim - 8,213,970	Exemplary Supporting Evidence Regarding Accused Products
	<p data-bbox="533 248 743 448">Driver's device screen locked displaying passenger's ride request message</p>  <p data-bbox="478 899 1398 932">https://www.youtube.com/watch?v=jVUy9poJDng at 10:24, Annotated</p>

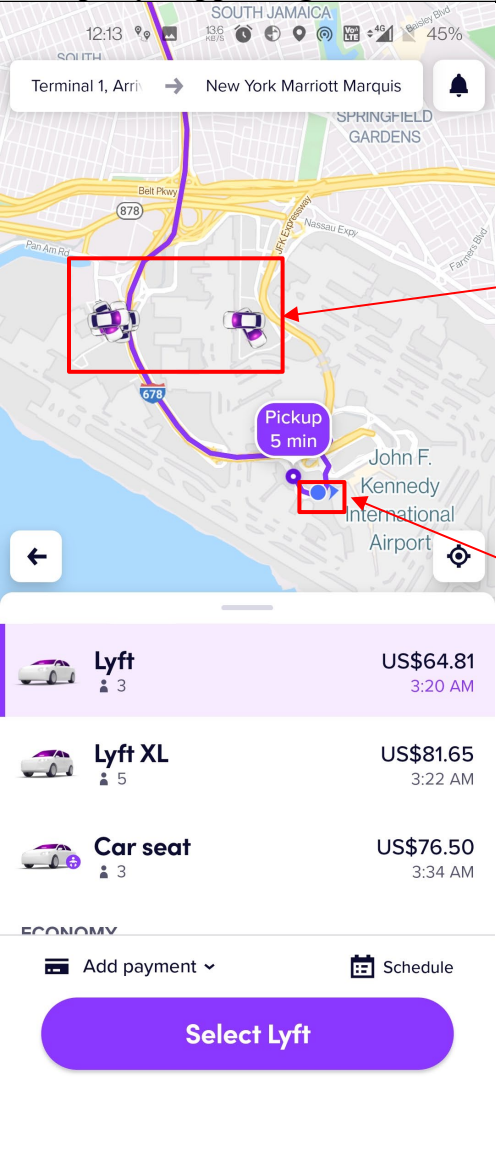
Exhibit D for US Patent No. 8,213,970 Against Lyft Accused Products

Claim - 8,213,970	Exemplary Supporting Evidence Regarding Accused Products
	 <p>https://www.youtube.com/watch?v=j0RDMLcmOgU at 4:01</p>

Exhibit D for US Patent No. 8,213,970 Against Lyft Accused Products

Claim - 8,213,970	Exemplary Supporting Evidence Regarding Accused Products												
	 <p>The screenshot displays the Lyft app interface. At the top, the route is set from "Terminal 1, Arrivals" to "New York Marriott Marquis". The map shows the passenger's location (blue dot) at John F. Kennedy International Airport and several nearby drivers (purple car icons) in the area. A red box highlights the passenger's location, and another red box highlights the nearby drivers' locations. The ride details for the selected "Lyft" option are as follows:</p> <table border="1"><thead><tr><th>Vehicle Type</th><th>Price</th><th>Pickup Time</th></tr></thead><tbody><tr><td>Lyft (3 seats)</td><td>US\$64.81</td><td>3:20 AM</td></tr><tr><td>Lyft XL (5 seats)</td><td>US\$81.65</td><td>3:22 AM</td></tr><tr><td>Car seat (3 seats)</td><td>US\$76.50</td><td>3:34 AM</td></tr></tbody></table> <p>At the bottom, there is a large purple button labeled "Select Lyft".</p>	Vehicle Type	Price	Pickup Time	Lyft (3 seats)	US\$64.81	3:20 AM	Lyft XL (5 seats)	US\$81.65	3:22 AM	Car seat (3 seats)	US\$76.50	3:34 AM
Vehicle Type	Price	Pickup Time											
Lyft (3 seats)	US\$64.81	3:20 AM											
Lyft XL (5 seats)	US\$81.65	3:22 AM											
Car seat (3 seats)	US\$76.50	3:34 AM											

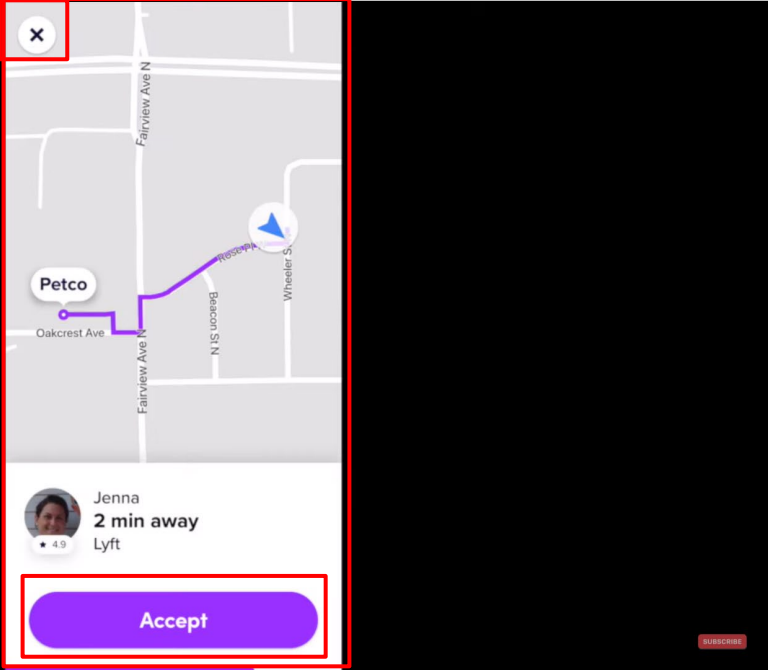
Exhibit D for US Patent No. 8,213,970 Against Lyft Accused Products

Claim - 8,213,970	Exemplary Supporting Evidence Regarding Accused Products
	<p>Further, to the extent this element is performed at least in part by Lyft's software source code, AGIS reserves the right to supplement these contentions pursuant to production of such source code by Lyft and to the extent Defendant requires additional information in accordance with P.R. 3-1 and for any other reasons.</p>
<p>1[E]. means for attaching a forced message alert software packet to a voice or text message creating a forced message alert that is transmitted by said sender PDA/cell phone to the recipient PDA/cell phone, said forced message alert software packet containing a list of possible required responses and requiring the forced message alert software on said recipient PDA/cell phone to transmit an automatic acknowledgment to the sender PDA/cell phone as soon as said forced</p>	<p>The Lyft Accused Products infringe directly and/or indirectly by performing, inducing others to perform, and/or contributing to the performance of: means for attaching a forced message alert software packet to a voice or text message creating a forced message alert that is transmitted by said sender PDA/cell phone to the recipient PDA/cell phone, said forced message alert software packet containing a list of possible required responses and requiring the forced message alert software on said recipient PDA/cell phone to transmit an automatic acknowledgment to the sender PDA/cell phone as soon as said forced message alert is received by the recipient PDA/cell phone.</p> <p>This element is infringed literally, or in the alternative, under the doctrine of equivalents.</p> <p>For example, the Lyft Driver app receives an electronically transmitted request for a ride from a passenger which triggers a forced message alert that locks the driver's device for a period of time until the driver ("recipient") sends a response message (decline or accept) to clear the locked display.</p> <p>For example, at the backend, each nearby driver's Lyft app that receives the ride request sends an acknowledgement of receipt to the Lyft server(s). On information and belief, the acknowledgement is communicated to the rider's Lyft app via the Lyft server(s).</p>

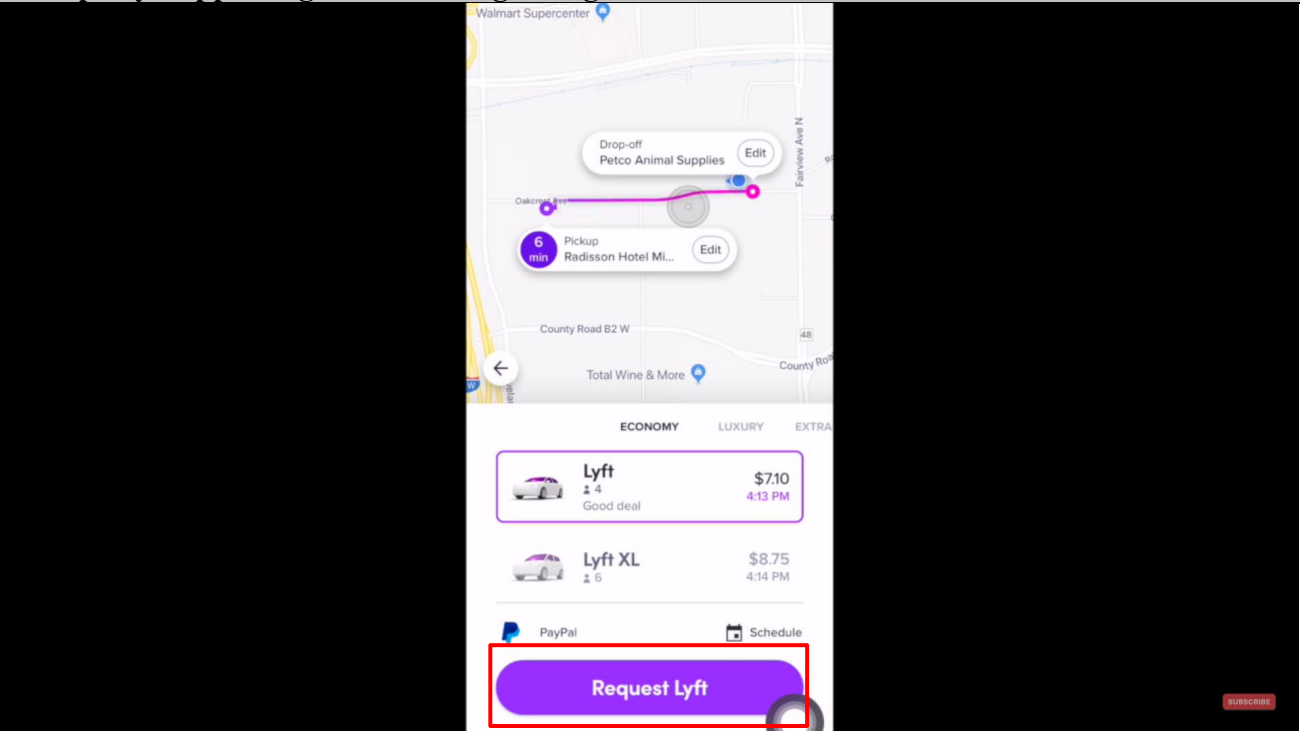
Exhibit D for US Patent No. 8,213,970 Against Lyft Accused Products

Claim - 8,213,970	Exemplary Supporting Evidence Regarding Accused Products
<p>message alert is received by the recipient PDA/cell phone;</p>	<p>Driver's device screen locked displaying passenger's ride request message</p>  <p>https://www.youtube.com/watch?v=jVUy9poJDng at 10:24, Annotated</p>

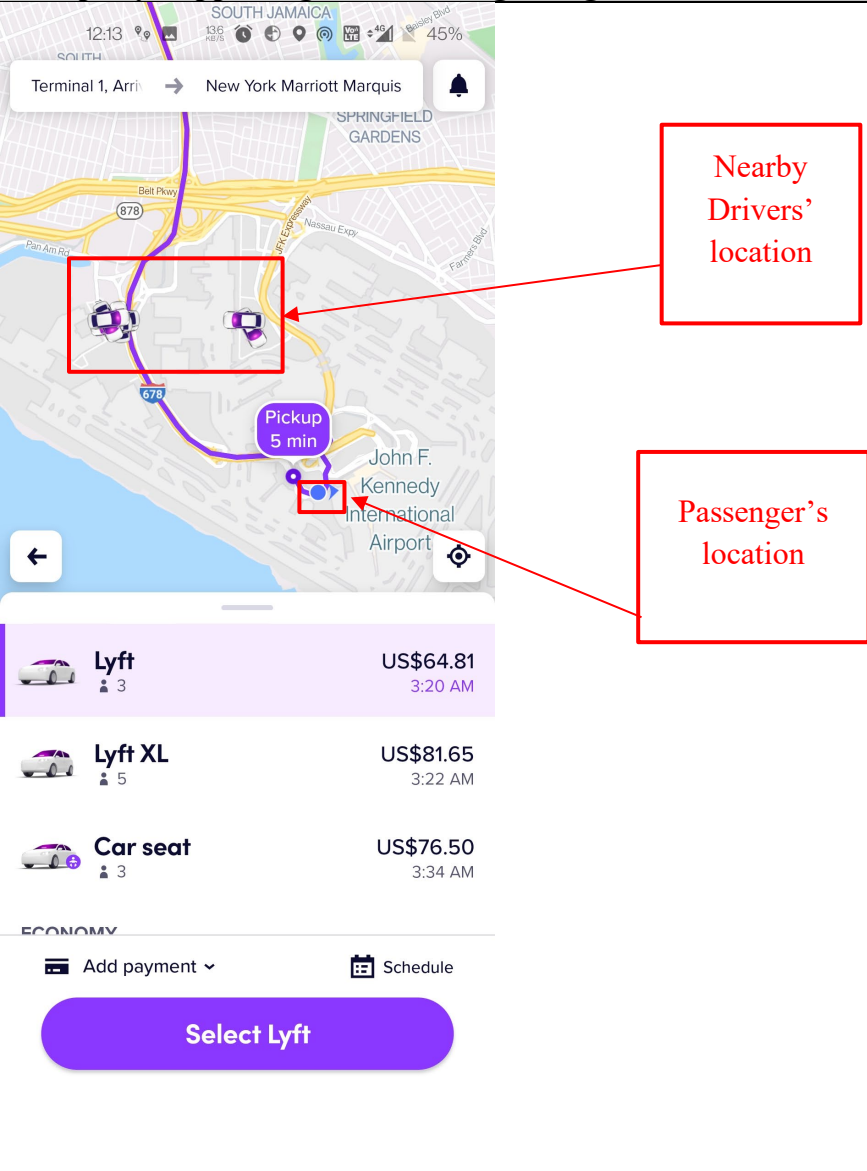
Exhibit D for US Patent No. 8,213,970 Against Lyft Accused Products

Claim - 8,213,970	Exemplary Supporting Evidence Regarding Accused Products
	 <p>The screenshot displays the Lyft app interface. At the top, it shows the pickup location as 'Radisson Hotel ML...' with a 6-minute estimated arrival time. The drop-off location is 'Petco Animal Supplies'. Below the map, there are two ride options: 'Lyft' (4 seats, \$7.10, 4:13 PM) and 'Lyft XL' (6 seats, \$8.75, 4:14 PM). The 'Request Lyft' button is highlighted with a red box. A 'PayPal' icon and a 'Schedule' icon are also visible. A 'Subscribe' button is in the bottom right corner.</p> <p>https://www.youtube.com/watch?v=j0RDMLcmOgU at 4:01</p>

Exhibit D for US Patent No. 8,213,970 Against Lyft Accused Products

Claim - 8,213,970	Exemplary Supporting Evidence Regarding Accused Products												
	 <p>The screenshot shows a Lyft app interface. At the top, the route is from Terminal 1, Arrivals to New York Marriott Marquis. The map displays the area around JFK Airport, with a purple line indicating the pickup route. A red box on the map highlights two driver icons, with an arrow pointing to a text box labeled "Nearby Drivers' location". Another red box highlights the passenger location icon, with an arrow pointing to a text box labeled "Passenger's location". Below the map, three ride options are listed:</p> <table border="1"><thead><tr><th>Vehicle Type</th><th>Price</th><th>Time</th></tr></thead><tbody><tr><td>Lyft (3 seats)</td><td>US\$64.81</td><td>3:20 AM</td></tr><tr><td>Lyft XL (5 seats)</td><td>US\$81.65</td><td>3:22 AM</td></tr><tr><td>Car seat (3 seats)</td><td>US\$76.50</td><td>3:34 AM</td></tr></tbody></table> <p>At the bottom, there are options to "Add payment" and "Schedule", and a large purple button labeled "Select Lyft".</p>	Vehicle Type	Price	Time	Lyft (3 seats)	US\$64.81	3:20 AM	Lyft XL (5 seats)	US\$81.65	3:22 AM	Car seat (3 seats)	US\$76.50	3:34 AM
Vehicle Type	Price	Time											
Lyft (3 seats)	US\$64.81	3:20 AM											
Lyft XL (5 seats)	US\$81.65	3:22 AM											
Car seat (3 seats)	US\$76.50	3:34 AM											

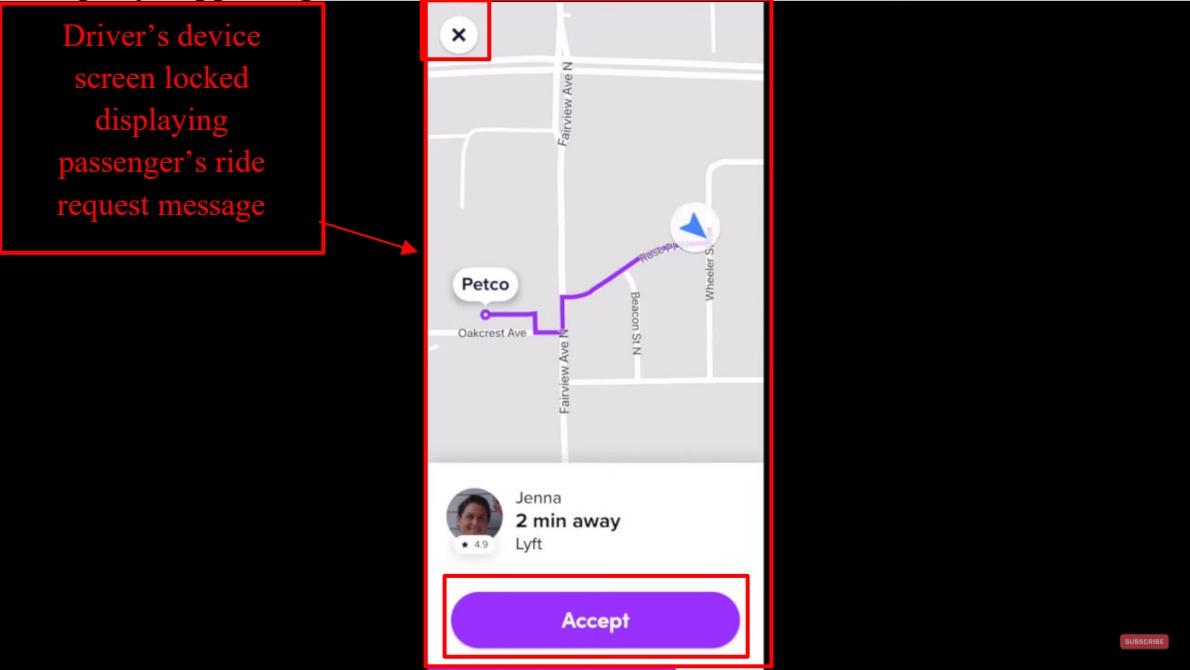
Exhibit D for US Patent No. 8,213,970 Against Lyft Accused Products

Claim - 8,213,970	Exemplary Supporting Evidence Regarding Accused Products
	Further, to the extent this element is performed at least in part by Lyft's software source code, AGIS reserves the right to supplement these contentions pursuant to production of such source code by Lyft and to the extent Defendant requires additional information in accordance with P.R. 3-1 and for any other reasons.
1[F]. means for requiring a required manual response from the response list by the recipient in order to clear recipient's response list from recipient's cell phone display;	<p>The Lyft Accused Products infringe directly and/or indirectly by performing, inducing others to perform, and/or contributing to the performance of: means for requiring a required manual response from the response list by the recipient in order to clear recipient's response list from recipient's cell phone display.</p> <p>This element is infringed literally, or in the alternative, under the doctrine of equivalents.</p> <p>For example, the Lyft Driver app receives an electronically transmitted request for a ride from a passenger which triggers a forced message alert that locks the driver's device for a period of time until the driver ("recipient") sends a response message (decline (cross button) or accept) to clear the locked display.</p>

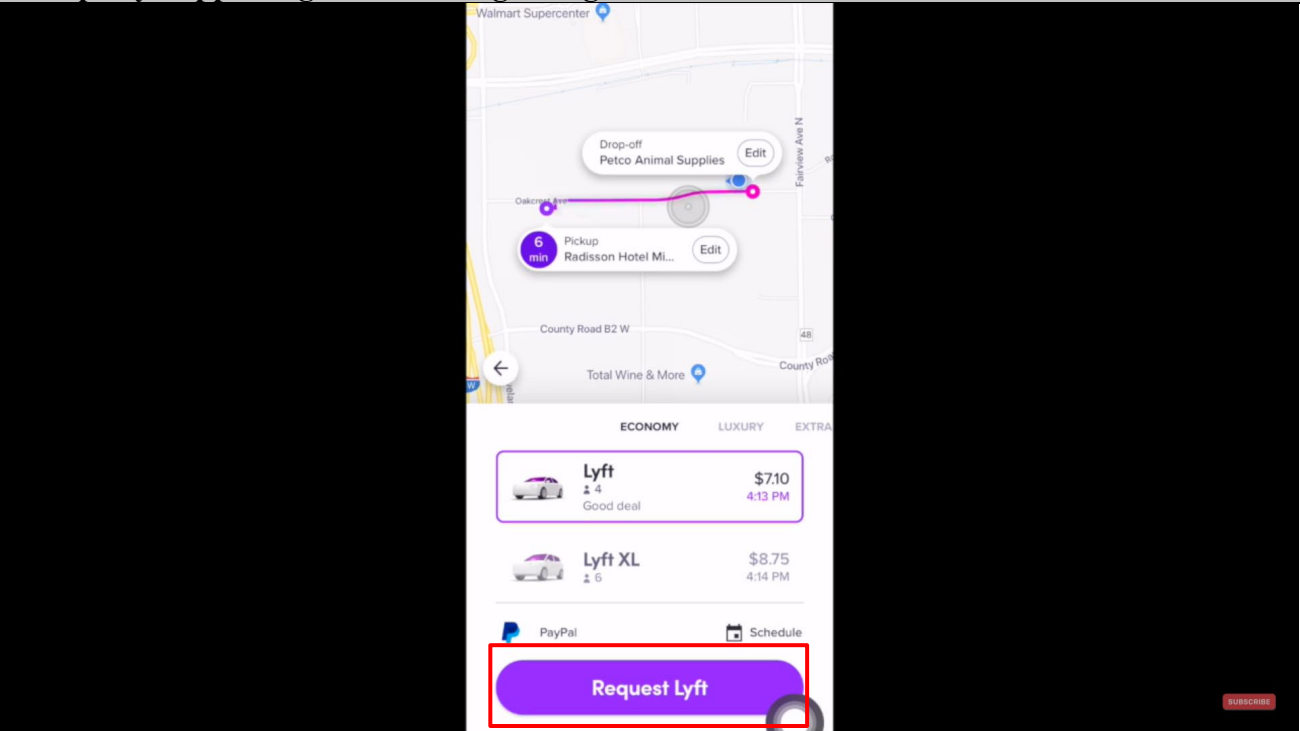
Exhibit D for US Patent No. 8,213,970 Against Lyft Accused Products

Claim - 8,213,970	Exemplary Supporting Evidence Regarding Accused Products
	 <p>https://www.youtube.com/watch?v=j0RDMLcmOgU at 4:01</p>

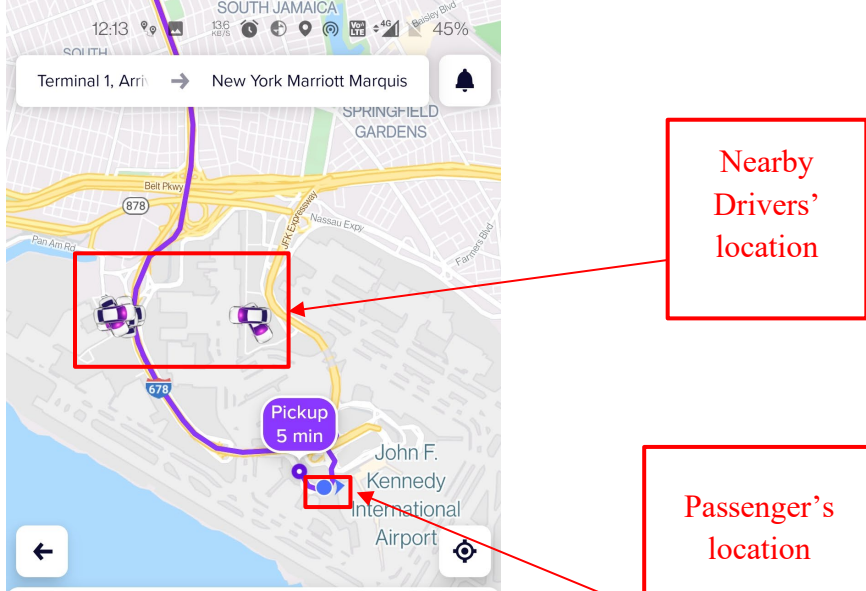
Exhibit D for US Patent No. 8,213,970 Against Lyft Accused Products

Claim - 8,213,970	Exemplary Supporting Evidence Regarding Accused Products
	 <p>The screenshot displays the Lyft app interface. At the top, the route is set from Terminal 1, Arrivals to New York Marriott Marquis. The map shows the area around JFK Airport, with a red box highlighting two nearby driver locations. A red box also highlights the passenger's location at JFK. Below the map, three ride options are listed: Lyft (US\$64.81, 3:20 AM), Lyft XL (US\$81.65, 3:22 AM), and Car seat (US\$76.50, 3:34 AM). A large purple button at the bottom says "Select Lyft".</p> <p>Nearby Drivers' location</p> <p>Passenger's location</p>

Exhibit D for US Patent No. 8,213,970 Against Lyft Accused Products

Claim - 8,213,970	Exemplary Supporting Evidence Regarding Accused Products
	<p data-bbox="533 248 743 448">Driver's device screen locked displaying passenger's ride request message</p>  <p data-bbox="478 899 1398 932">https://www.youtube.com/watch?v=jVUy9poJDng at 10:24, Annotated</p>

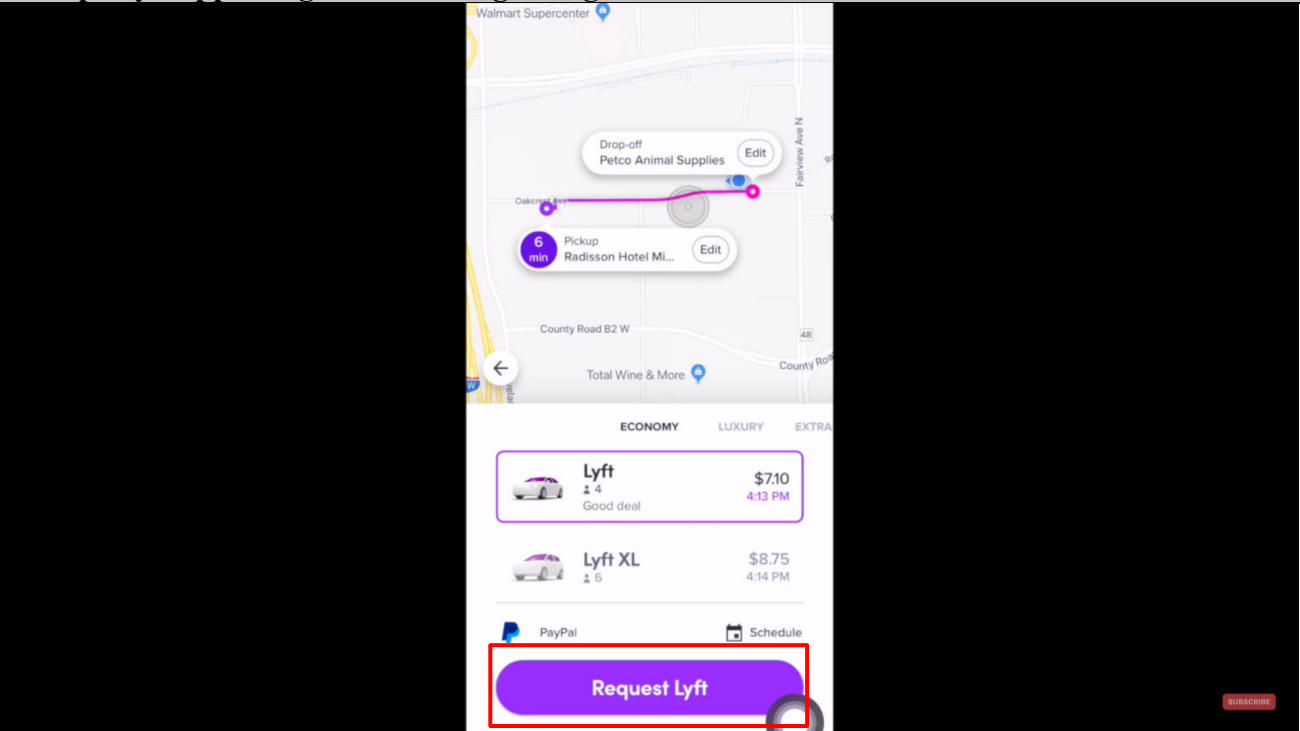
Exhibit D for US Patent No. 8,213,970 Against Lyft Accused Products

Claim - 8,213,970	Exemplary Supporting Evidence Regarding Accused Products
	 <p>https://www.youtube.com/watch?v=b31WorLlcqE at 9:40, Annotated</p>

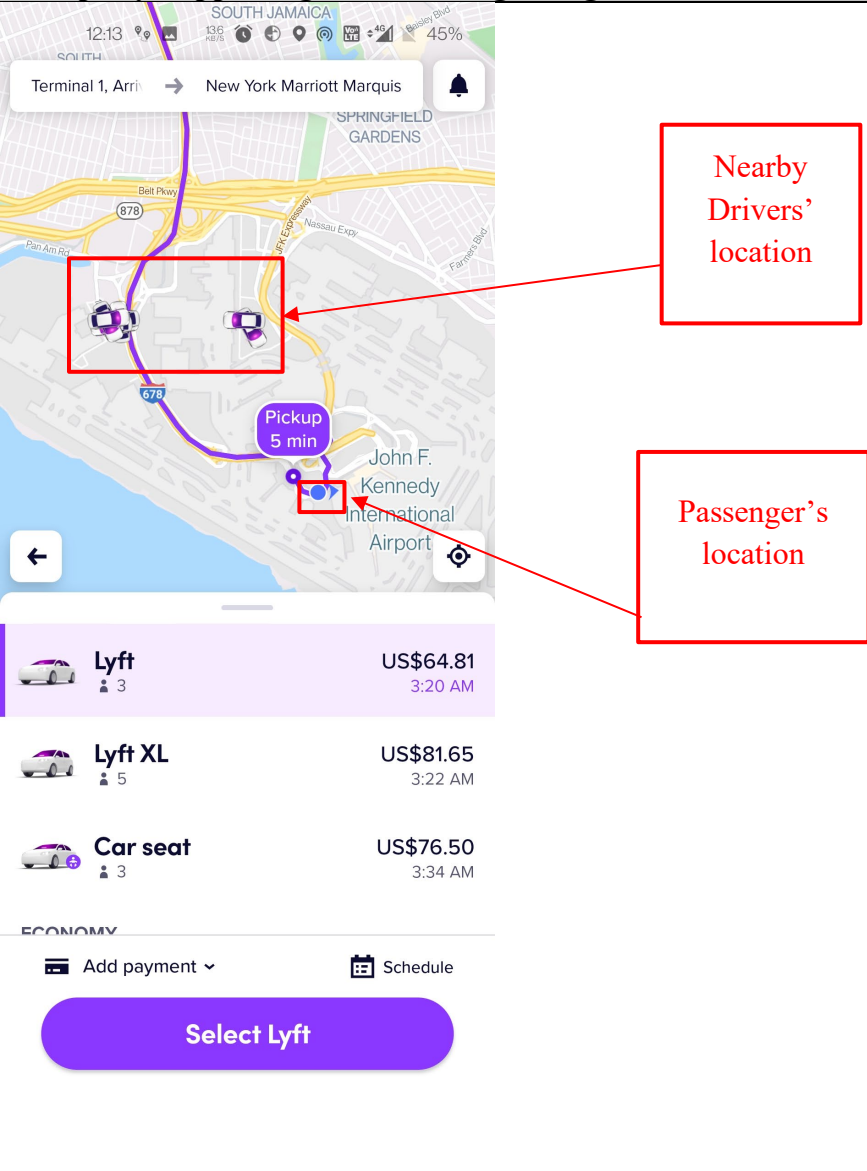
Exhibit D for US Patent No. 8,213,970 Against Lyft Accused Products

Claim - 8,213,970	Exemplary Supporting Evidence Regarding Accused Products
	Further, to the extent this element is performed at least in part by Lyft's software source code, AGIS reserves the right to supplement these contentions pursuant to production of such source code by Lyft and to the extent Defendant requires additional information in accordance with P.R. 3-1 and for any other reasons.
1[G]. means for receiving and displaying a listing of which recipient PDA/cell phones have automatically acknowledged the forced message alert and which recipient PDA/cell phones have not automatically acknowledged the forced message alert;	<p>The Lyft Accused Products infringe directly and/or indirectly by performing, inducing others to perform, and/or contributing to the performance of: means for receiving and displaying a listing of which recipient PDA/cell phones have automatically acknowledged the forced message alert and which recipient PDA/cell phones have not automatically acknowledged the forced message alert.</p> <p>This element is infringed literally, or in the alternative, under the doctrine of equivalents.</p> <p>For example, upon information and belief, at the backend, each nearby driver's Lyft App ("recipient PDA/cell phone") that received ride request sends an acknowledgement of receipt to Lyft server(s).</p>

Exhibit D for US Patent No. 8,213,970 Against Lyft Accused Products

Claim - 8,213,970	Exemplary Supporting Evidence Regarding Accused Products
	 <p>The screenshot displays the Lyft app interface. At the top, it shows the pickup location 'Radisson Hotel ML...' and the drop-off location 'Petco Animal Supplies'. The estimated time to the drop-off is 6 minutes. Below the map, there are two ride options: 'Lyft' (4 seats, \$7.10, 4:13 PM) and 'Lyft XL' (6 seats, \$8.75, 4:14 PM). The 'Request Lyft' button is highlighted with a red box. The app also shows 'PayPal' and 'Schedule' options.</p> <p>https://www.youtube.com/watch?v=j0RDMLcmOgU at 4:01</p>

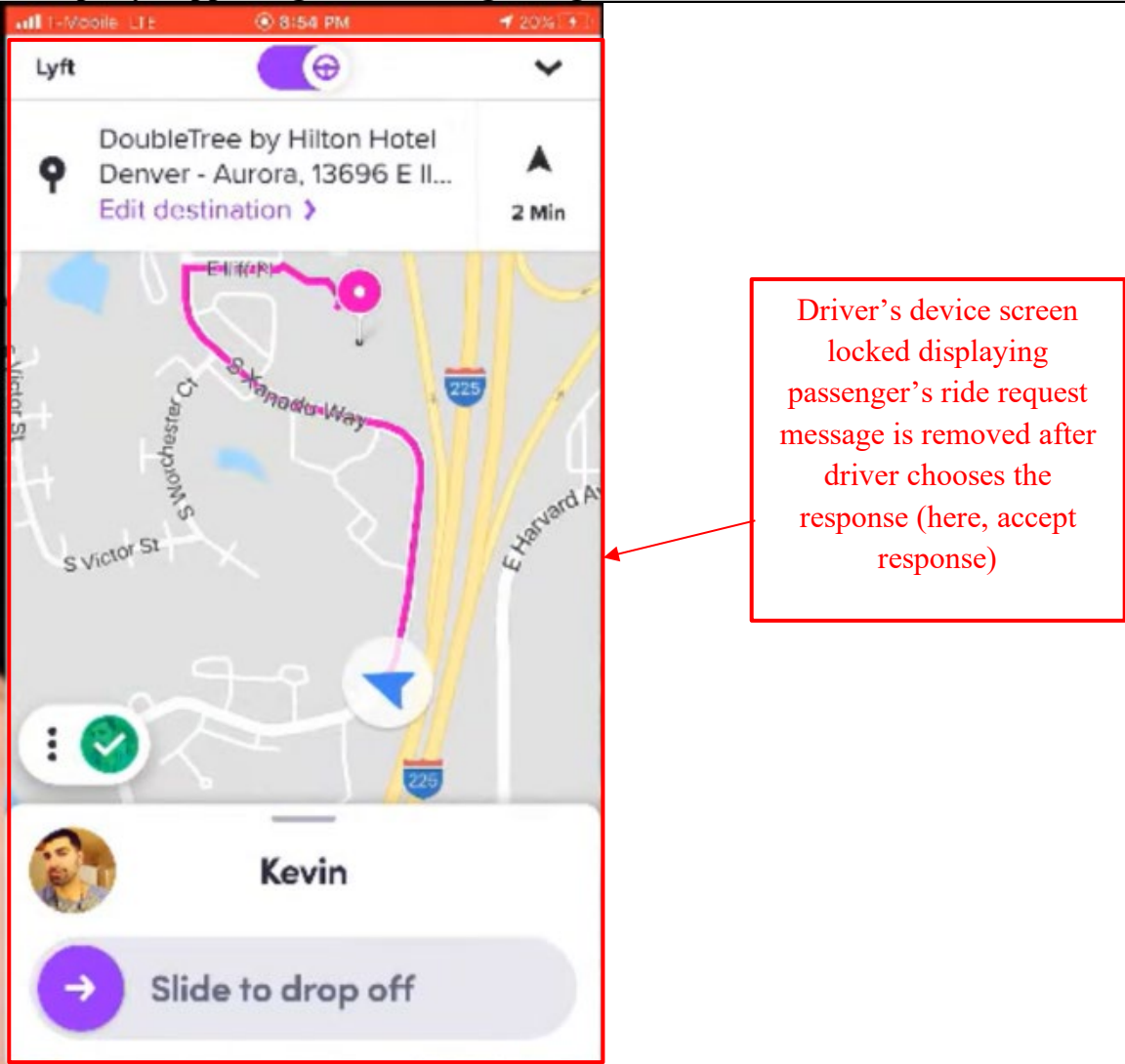
Exhibit D for US Patent No. 8,213,970 Against Lyft Accused Products

Claim - 8,213,970	Exemplary Supporting Evidence Regarding Accused Products
	 <p>The screenshot displays the Lyft app interface. At the top, the route is set from 'Terminal 1, Arrivals' to 'New York Marriott Marquis'. The map shows the area around JFK Airport, with a 'Pickup 5 min' timer. Two driver icons are highlighted in a red box, with an arrow pointing to a text box labeled 'Nearby Drivers' location'. A passenger icon is highlighted in another red box, with an arrow pointing to a text box labeled 'Passenger's location'. Below the map, three vehicle options are listed: 'Lyft' (US\$64.81, 3:20 AM), 'Lyft XL' (US\$81.65, 3:22 AM), and 'Car seat' (US\$76.50, 3:34 AM). At the bottom, there is a 'Select Lyft' button.</p>

Exhibit D for US Patent No. 8,213,970 Against Lyft Accused Products

Claim - 8,213,970	Exemplary Supporting Evidence Regarding Accused Products
	<div style="border: 2px solid red; padding: 5px; margin-bottom: 10px;"> <p style="color: red; text-align: center;">Driver's device screen locked displaying passenger's ride request message</p> </div>  <p style="color: blue; text-decoration: underline;"> https://www.youtube.com/watch?v=jVUy9poJDng at 10:24, Annotated </p> <p>Further, to the extent this element is performed at least in part by Lyft's software source code, AGIS reserves the right to supplement these contentions pursuant to production of such source code by Lyft and to the extent Defendant requires additional information in accordance with P.R. 3-1 and for any other reasons.</p>
<p>1[H]. means for periodically resending said forced message alert to said recipient PDA/cell phones that have not automatically acknowledged the</p>	<p>The Lyft Accused Products infringe directly and/or indirectly by performing, inducing others to perform, and/or contributing to the performance of: means for periodically resending said forced message alert to said recipient PDA/cell phones that have not automatically acknowledged the forced message alert.</p> <p>This element is infringed literally, or in the alternative, under the doctrine of equivalents.</p> <p>For example, upon information and belief, at the backend, each nearby driver's Lyft app that received ride request sends an acknowledgement of receipt to Lyft server(s). Therefore, the second communication of the</p>

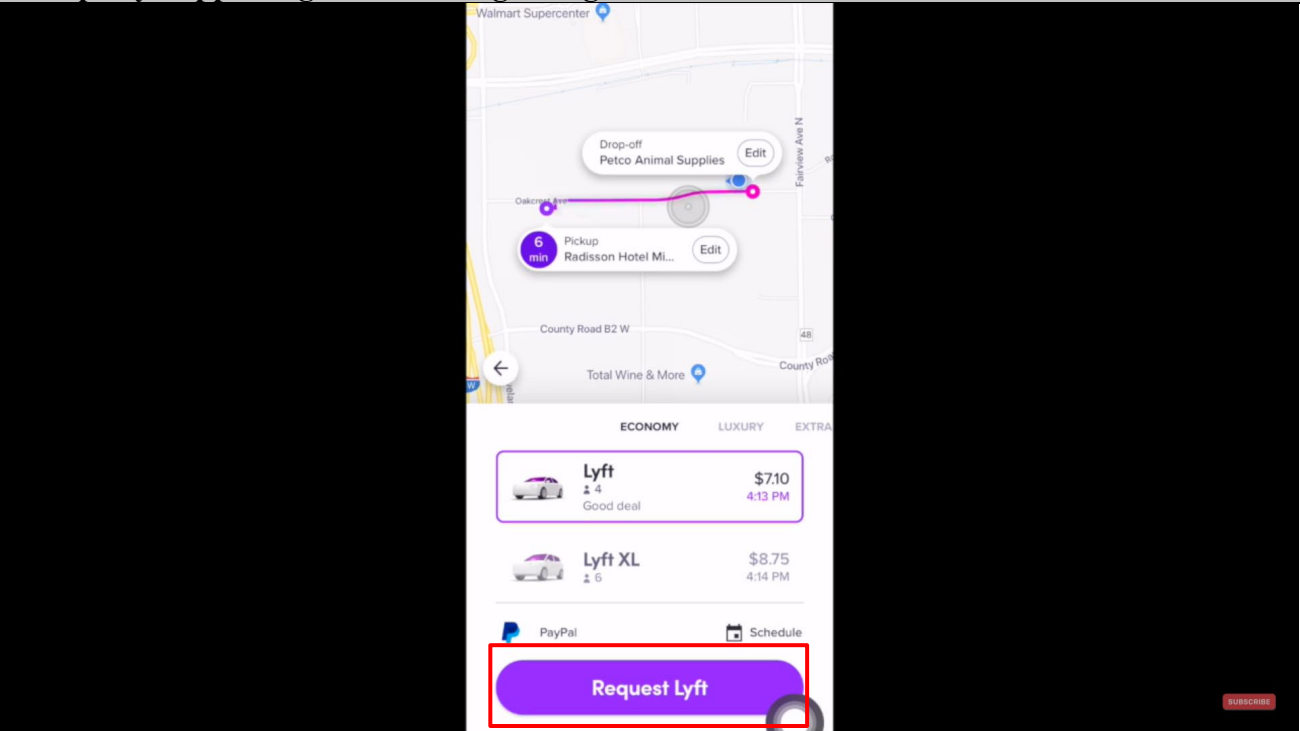
Exhibit D for US Patent No. 8,213,970 Against Lyft Accused Products

Claim - 8,213,970	Exemplary Supporting Evidence Regarding Accused Products
<p>forced message alert; and</p>	<p>ride request is sent to those drivers' Lyft app who did not acknowledge the ride request message. This communication of ride request is periodically sent until the ride is accepted by any driver.</p> <div data-bbox="478 337 1770 1068"></div> <p>https://www.youtube.com/watch?v=j0RDMLcmOgU at 4:01</p>

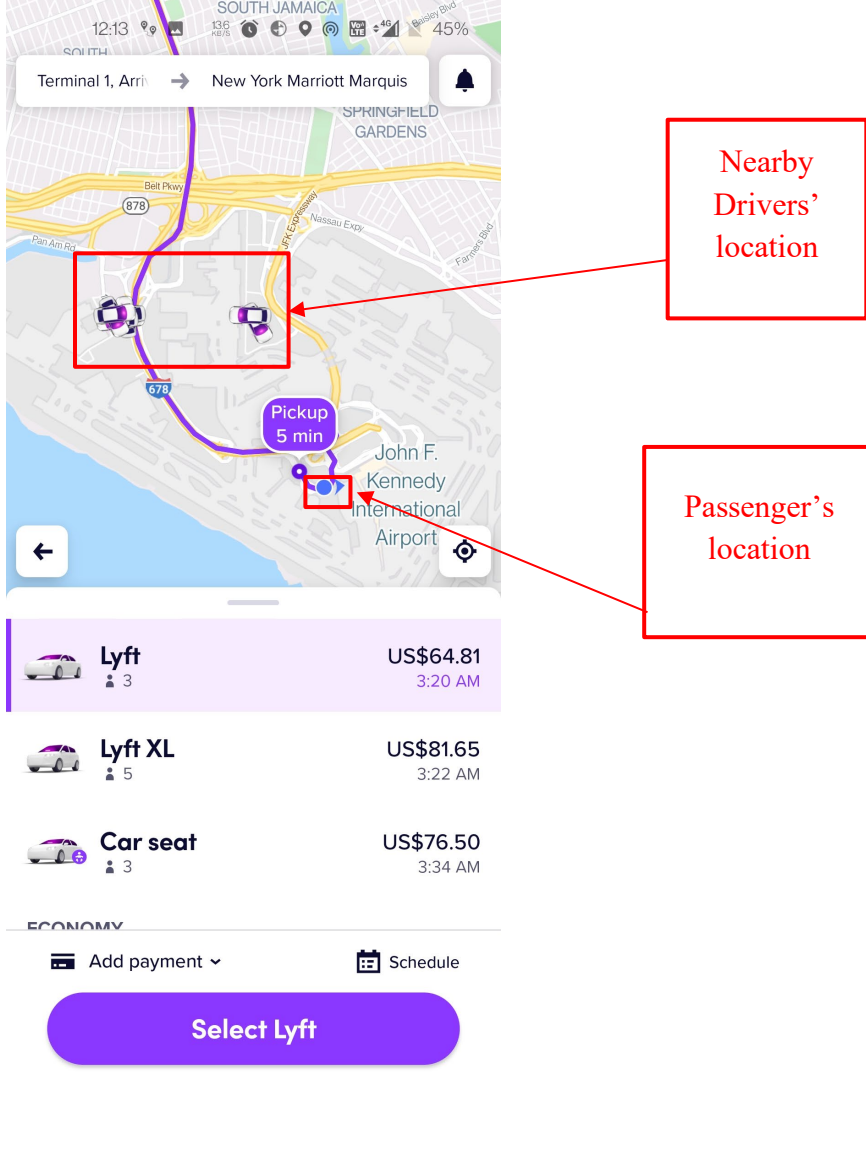
Exhibit D for US Patent No. 8,213,970 Against Lyft Accused Products

Claim - 8,213,970	Exemplary Supporting Evidence Regarding Accused Products
	 <p>The screenshot displays the Lyft app interface. At the top, the route is from Terminal 1, Arrivals to New York Marriott Marquis. The map shows the area around JFK Airport, with a pickup location marked 'Pickup 5 min' and a passenger location marked with a blue dot. Two nearby driver locations are shown as purple car icons, highlighted by a red box. A red arrow points from a text box labeled 'Nearby Drivers' location' to this red box. Another red arrow points from a text box labeled 'Passenger's location' to the blue dot on the map. Below the map, three ride options are listed: 'Lyft' (US\$64.81, 3:20 AM), 'Lyft XL' (US\$81.65, 3:22 AM), and 'Car seat' (US\$76.50, 3:34 AM). At the bottom, there is a 'Select Lyft' button.</p>

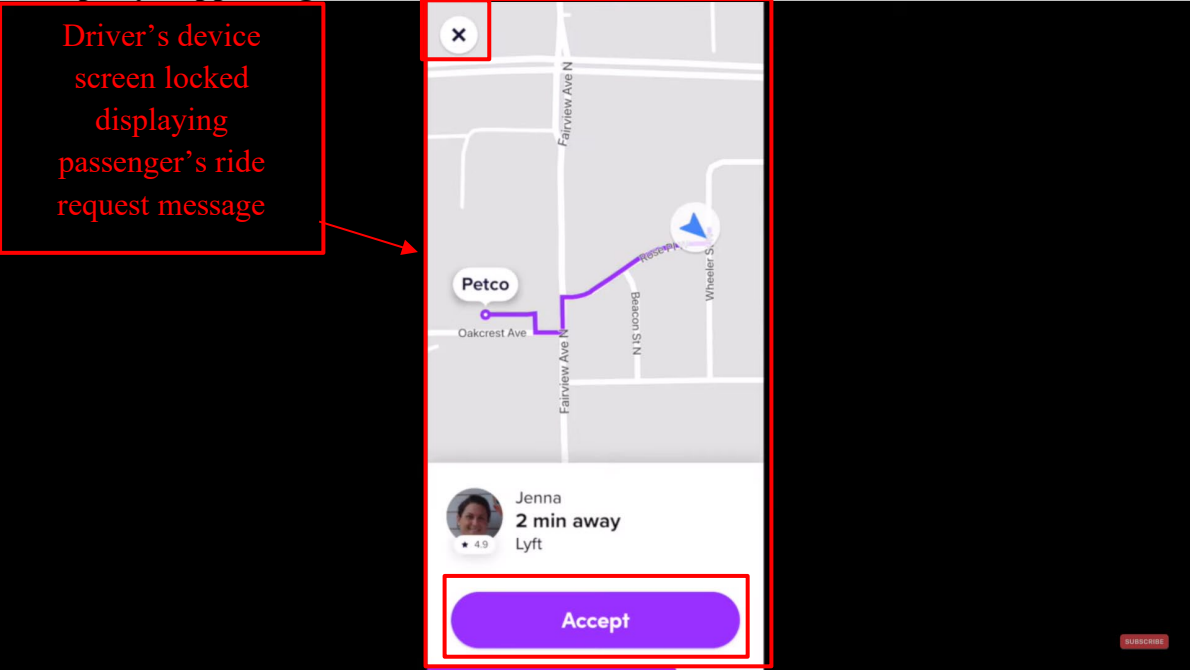
Exhibit D for US Patent No. 8,213,970 Against Lyft Accused Products

Claim - 8,213,970	Exemplary Supporting Evidence Regarding Accused Products
	<div data-bbox="478 228 1661 894"> <p>Driver's device screen locked displaying passenger's ride request message</p> <p>https://www.youtube.com/watch?v=jVUy9poJDng at 10:24, Annotated</p> </div> <p>Further, to the extent this element is performed at least in part by Lyft's software source code, AGIS reserves the right to supplement these contentions pursuant to production of such source code by Lyft and to the extent Defendant requires additional information in accordance with P.R. 3-1 and for any other reasons.</p>
<p>1[I]. means for receiving and displaying a listing of which recipient PDA/cell phones have transmitted a manual response to said forced message alert and</p>	<p>The Lyft Accused Products infringe directly and/or indirectly by performing, inducing others to perform, and/or contributing to the performance of: means for receiving and displaying a listing of which recipient PDA/cell phones have transmitted a manual response to said forced message alert and details the response from each recipient PDA/cell phone that responded.</p> <p>This element is infringed literally, or in the alternative, under the doctrine of equivalents.</p> <p>For example, upon information and belief, at the backend, a list of all the drivers' Lyft app that transmitted the response to a ride request message of a passenger are maintained at Lyft's server(s). This ensures that drivers</p>

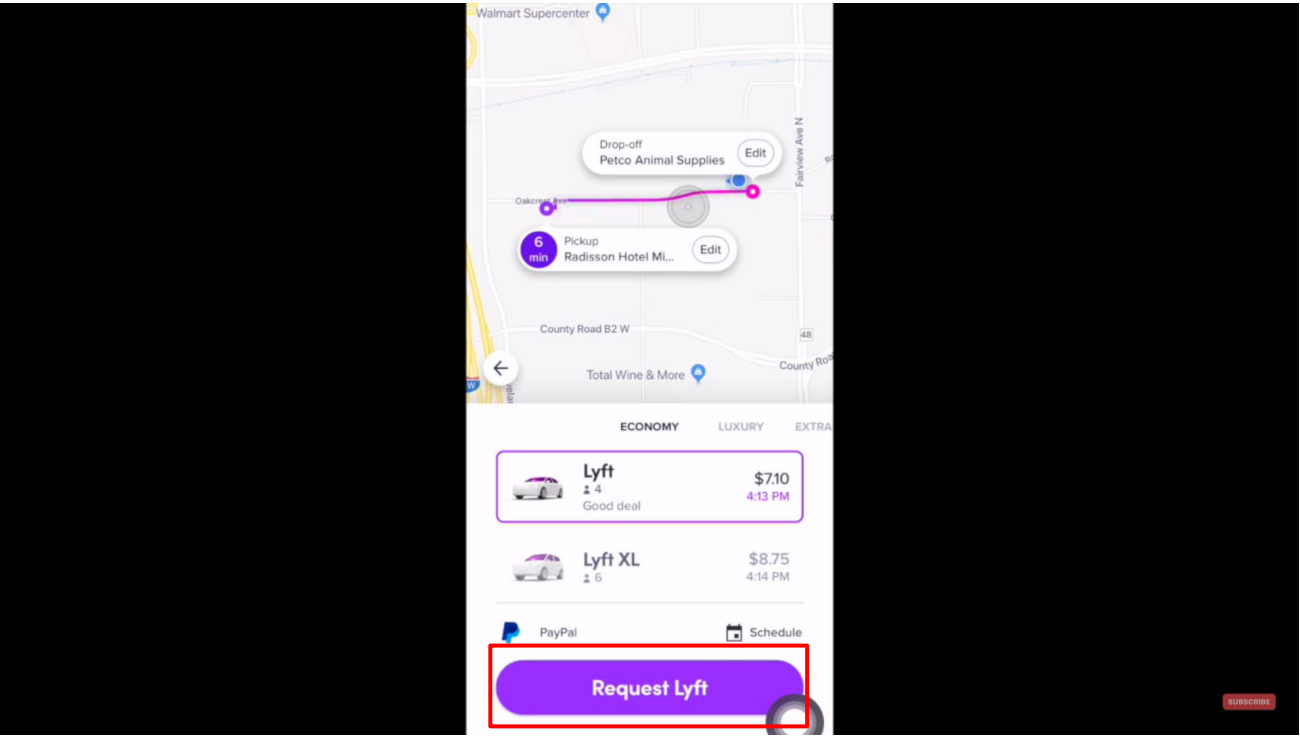
Exhibit D for US Patent No. 8,213,970 Against Lyft Accused Products

Claim - 8,213,970	Exemplary Supporting Evidence Regarding Accused Products
<p>details the response from each recipient PDA/cell phone that responded.</p>	<p>who declined the ride do not further receive the ride request of the same passenger in case the ride request has not been responded to and matches the driver to the passenger if the driver accepts the request. Therefore, Lyft's server(s) maintain a record of the responses from each of the drivers.</p> <div data-bbox="474 375 1768 1101"></div> <p>https://www.youtube.com/watch?v=j0RDMLcmOgU at 4:01</p>

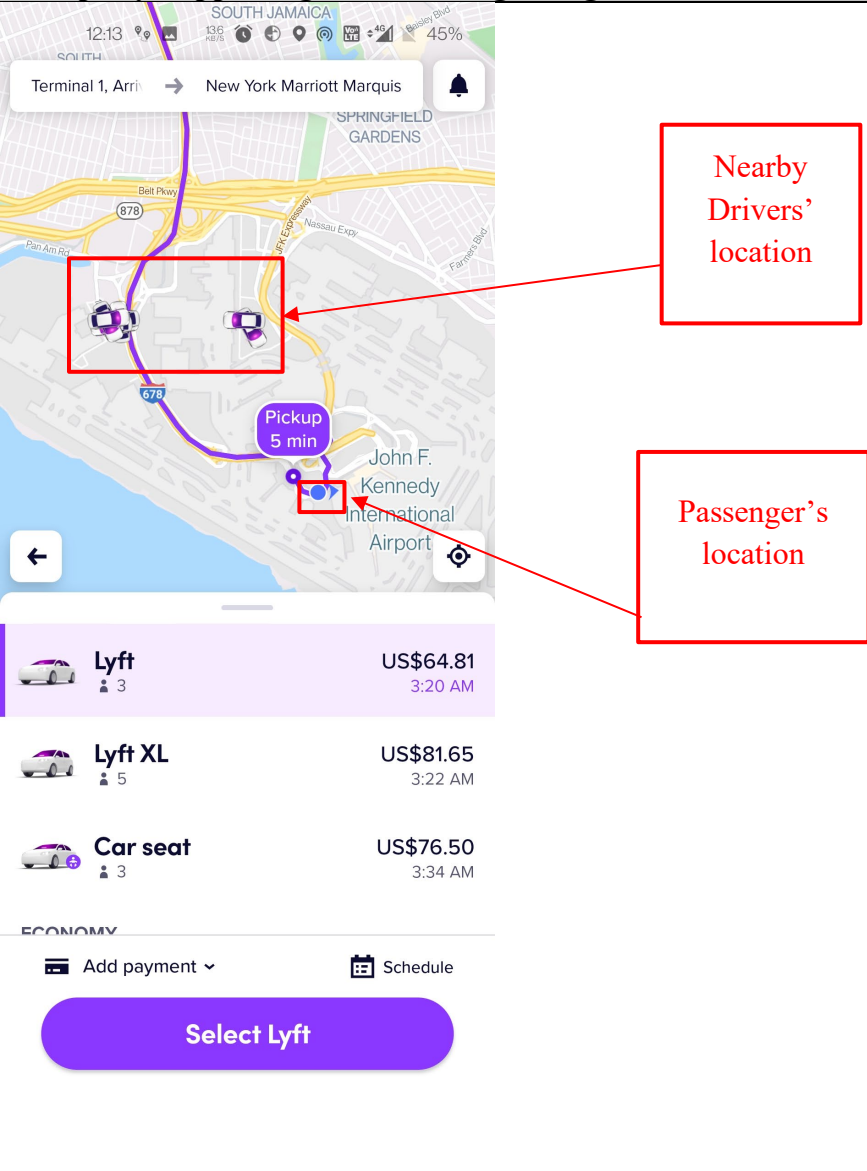
Exhibit D for US Patent No. 8,213,970 Against Lyft Accused Products

Claim - 8,213,970	Exemplary Supporting Evidence Regarding Accused Products
	 <p>The screenshot displays the Lyft app interface. At the top, the route is set from Terminal 1, Arrivals to New York Marriott Marquis. The map shows the area around JFK Airport, with a red box highlighting two nearby driver locations. A red box also highlights the passenger's location at the airport. Below the map, three ride options are listed: Lyft (US\$64.81, 3:20 AM), Lyft XL (US\$81.65, 3:22 AM), and Car seat (US\$76.50, 3:34 AM). A large purple button at the bottom says "Select Lyft".</p> <p>Nearby Drivers' location</p> <p>Passenger's location</p>

Exhibit D for US Patent No. 8,213,970 Against Lyft Accused Products

Claim - 8,213,970	Exemplary Supporting Evidence Regarding Accused Products
	<p data-bbox="533 245 743 448">Driver's device screen locked displaying passenger's ride request message</p>  <p data-bbox="478 899 1398 932">https://www.youtube.com/watch?v=jVUy9poJDng at 10:24, Annotated</p>

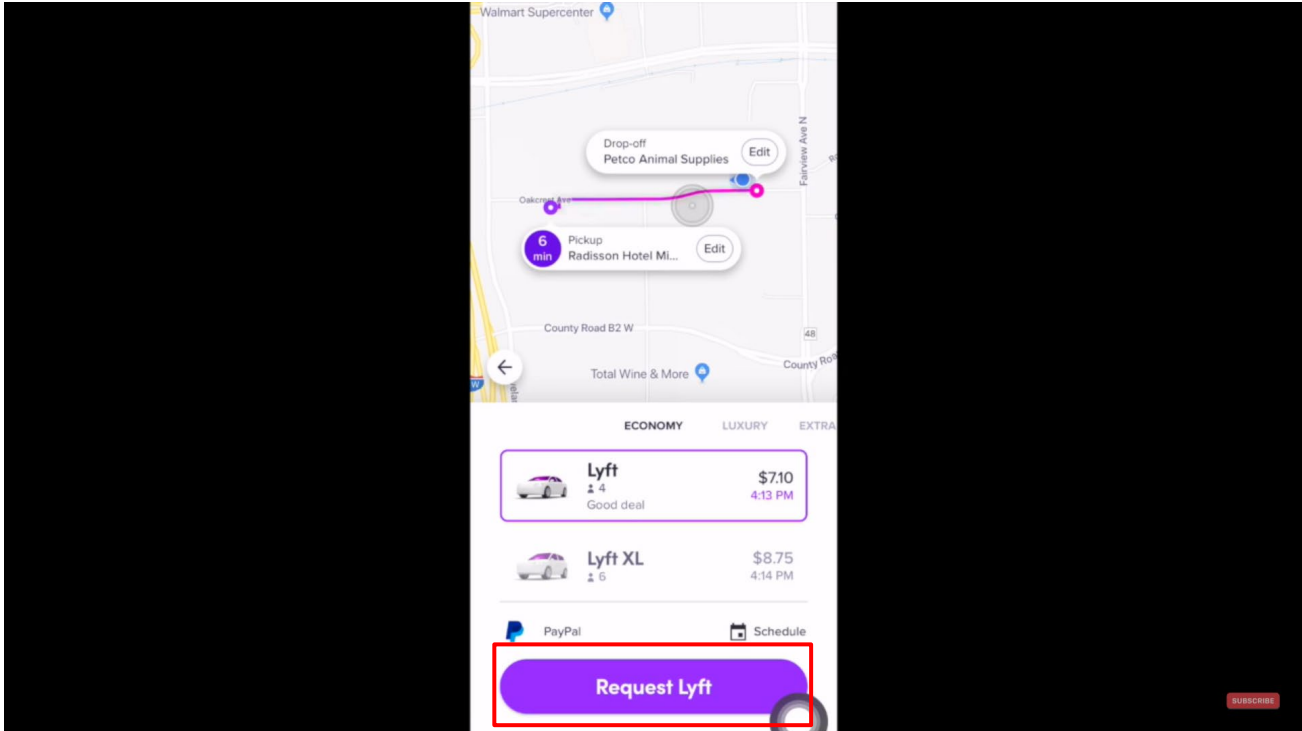
Exhibit D for US Patent No. 8,213,970 Against Lyft Accused Products

Claim - 8,213,970	Exemplary Supporting Evidence Regarding Accused Products
	 <p>Driver's device after accepting the ride request</p> <p>https://www.youtube.com/watch?v=b31WorLlcqE at 9:40, Annotated</p>

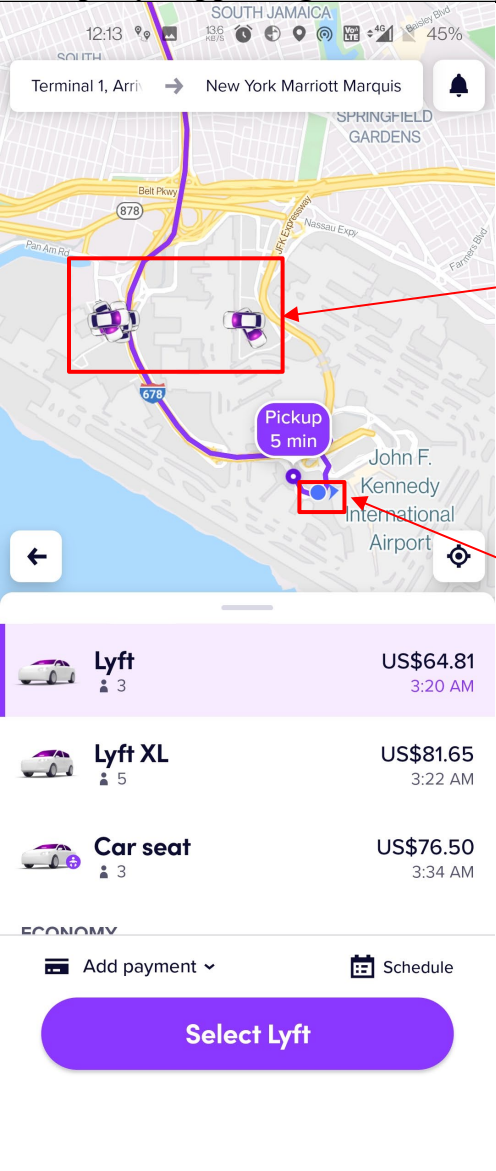
Exhibit D for US Patent No. 8,213,970 Against Lyft Accused Products

Claim - 8,213,970	Exemplary Supporting Evidence Regarding Accused Products
	Further, to the extent this element is performed at least in part by Lyft's software source code, AGIS reserves the right to supplement these contentions pursuant to production of such source code by Lyft and to the extent Defendant requires additional information in accordance with P.R. 3-1 and for any other reasons.
2[A]. The system of claim 1, wherein the forced message alert software application program on the recipient PDA/cell phone includes: means for transmitting the acknowledgment of receipt to said sender PDA/cell phone immediately upon receiving a forced message alert from the sender PDA/cell phone;	<p>The Lyft Accused Products comprise the system of claim 1: wherein the forced message alert software application program on the recipient PDA/cell phone includes: means for transmitting the acknowledgment of receipt to said sender PDA/cell phone immediately upon receiving a forced message alert from the sender PDA/cell phone.</p> <p>This element is infringed literally, or in the alternative, under the doctrine of equivalents.</p> <p>For example, at the backend, the Lyft driver app in each nearby driver's Lyft app that received a ride request sends an acknowledgement of receipt to Lyft's server and upon information and belief, further to the passenger's Lyft app.</p>

Exhibit D for US Patent No. 8,213,970 Against Lyft Accused Products

Claim - 8,213,970	Exemplary Supporting Evidence Regarding Accused Products
	 <p>https://www.youtube.com/watch?v=j0RDMLcmOgU at 4:01</p>

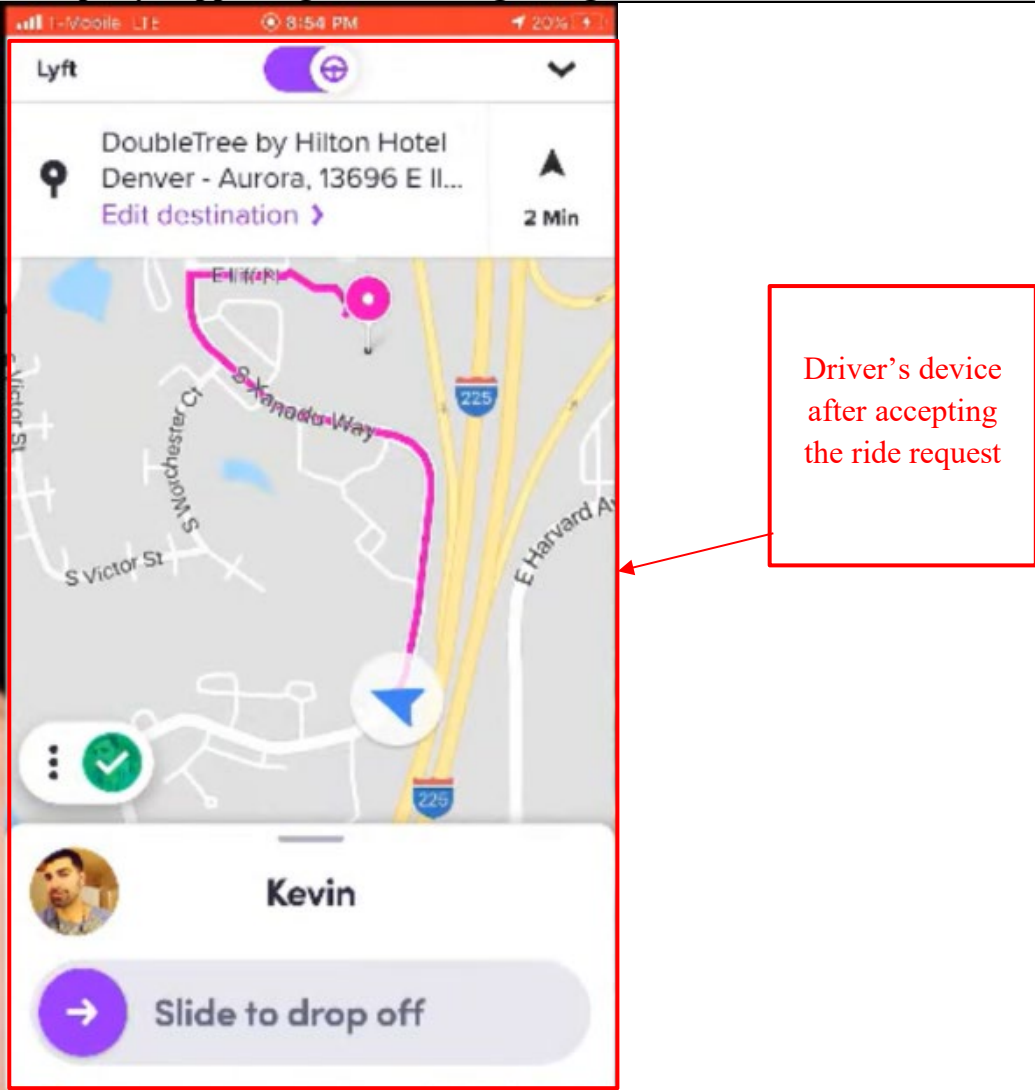
Exhibit D for US Patent No. 8,213,970 Against Lyft Accused Products







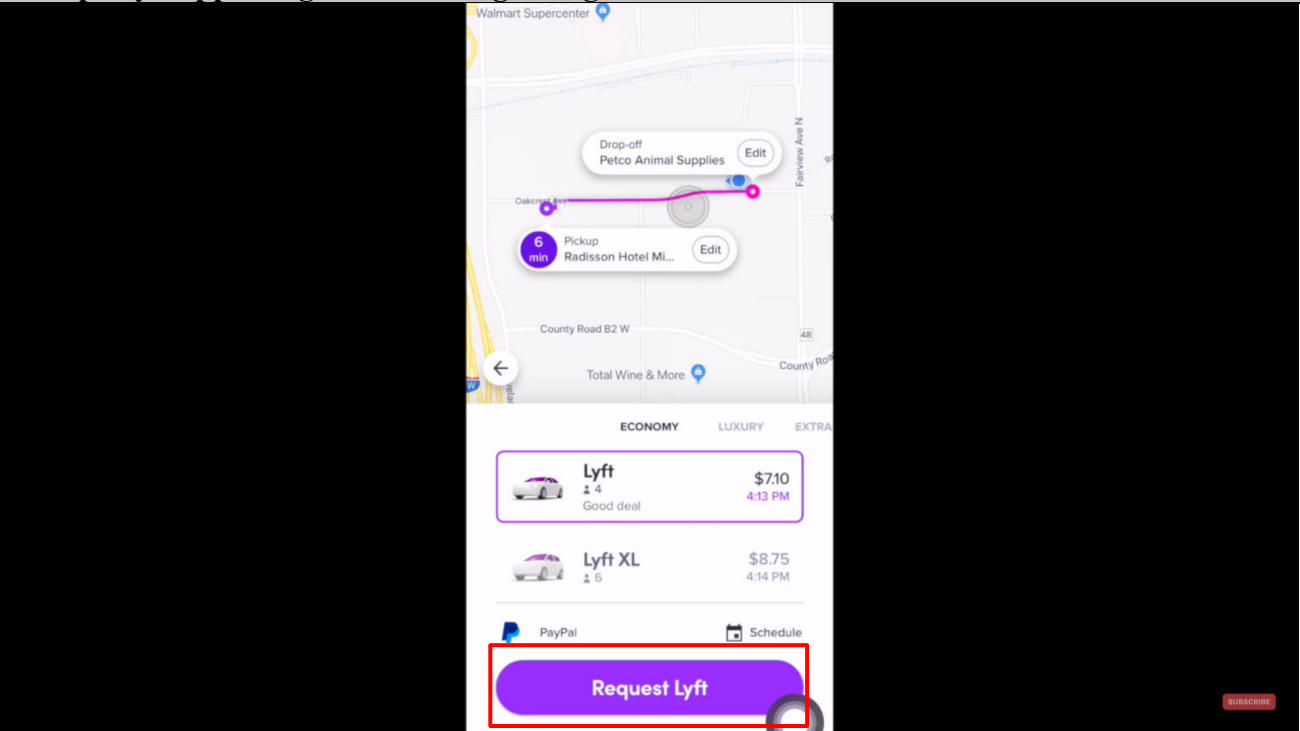

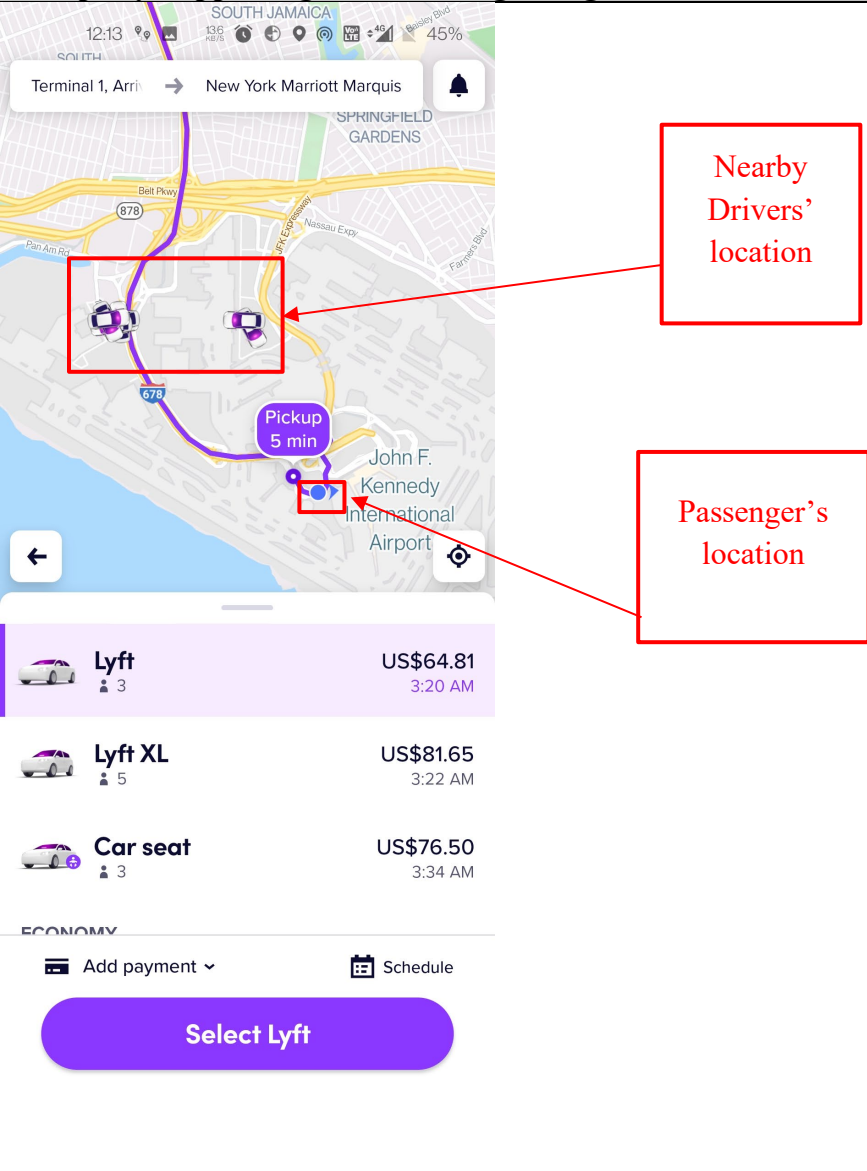

Claim - 8,213,970	Exemplary Supporting Evidence Regarding Accused Products						
	 <p data-bbox="1136 350 1335 550">Nearby Drivers' location</p> <p data-bbox="1110 675 1346 867">Passenger's location</p> <table border="1" data-bbox="478 850 970 1110"><tbody><tr><td> Lyft</td><td>US\$64.81</td></tr><tr><td> Lyft XL</td><td>US\$81.65</td></tr><tr><td> Car seat</td><td>US\$76.50</td></tr></tbody></table> <p data-bbox="520 1146 932 1203">ECONOMY Add payment Schedule</p> <p data-bbox="520 1219 932 1295">Select Lyft</p>	 Lyft	US\$64.81	 Lyft XL	US\$81.65	 Car seat	US\$76.50
 Lyft	US\$64.81						
 Lyft XL	US\$81.65						
 Car seat	US\$76.50						

Exhibit D for US Patent No. 8,213,970 Against Lyft Accused Products

Claim - 8,213,970	Exemplary Supporting Evidence Regarding Accused Products
	<p data-bbox="533 245 743 448">Driver's device screen locked displaying passenger's ride request message</p>  <p data-bbox="478 899 1398 932">https://www.youtube.com/watch?v=jVUy9poJDng at 10:24, Annotated</p>

Exhibit D for US Patent No. 8,213,970 Against Lyft Accused Products

Claim - 8,213,970	Exemplary Supporting Evidence Regarding Accused Products
	 <p data-bbox="1260 568 1491 698">Driver's device after accepting the ride request</p> <p data-bbox="478 1315 1365 1347">https://www.youtube.com/watch?v=b31WorLlcqE at 9:40, Annotated</p>

Exhibit D for US Patent No. 8,213,970 Against Lyft Accused Products

Claim - 8,213,970	Exemplary Supporting Evidence Regarding Accused Products
	<p>Further, to the extent this element is performed at least in part by Lyft's software source code, AGIS reserves the right to supplement these contentions pursuant to production of such source code by Lyft and to the extent Defendant requires additional information in accordance with P.R. 3-1 and for any other reasons.</p>
<p>2[B]. means for controlling of the recipient PDA/cell phone upon transmitting said automatic acknowledgment and causing, in cases where the force message alert is a text message, the text message and a response list to be shown on the display of the recipient PDA/cell phone or causes, in cases where the forced message alert is a voice message, the voice message being periodically repeated by the speakers of the recipient PDA/cell phone while said response list is</p>	<p>The Lyft Accused Products infringe directly and/or indirectly by performing, inducing others to perform, and/or contributing to the performance of: means for controlling of the recipient PDA/cell phone upon transmitting said automatic acknowledgment and causing, in cases where the force message alert is a text message, the text message and a response list to be shown on the display of the recipient PDA/cell phone or causes, in cases where the forced message alert is a voice message, the voice message being periodically repeated by the speakers of the recipient PDA/cell phone while said response list is shown on the display</p> <p>This element is infringed literally, or in the alternative, under the doctrine of equivalents.</p> <p>For example, the Lyft Driver app receives an electronically transmitted request for a ride from a passenger which triggers a forced message alert that locks the driver's Lyft app for a period of time until the driver sends a response message (decline (cross button) or accept) to clear the locked display.</p>

Exhibit D for US Patent No. 8,213,970 Against Lyft Accused Products

Claim - 8,213,970	Exemplary Supporting Evidence Regarding Accused Products
shown on the display	 <p>https://www.youtube.com/watch?v=j0RDMLcmOgU at 4:01</p>

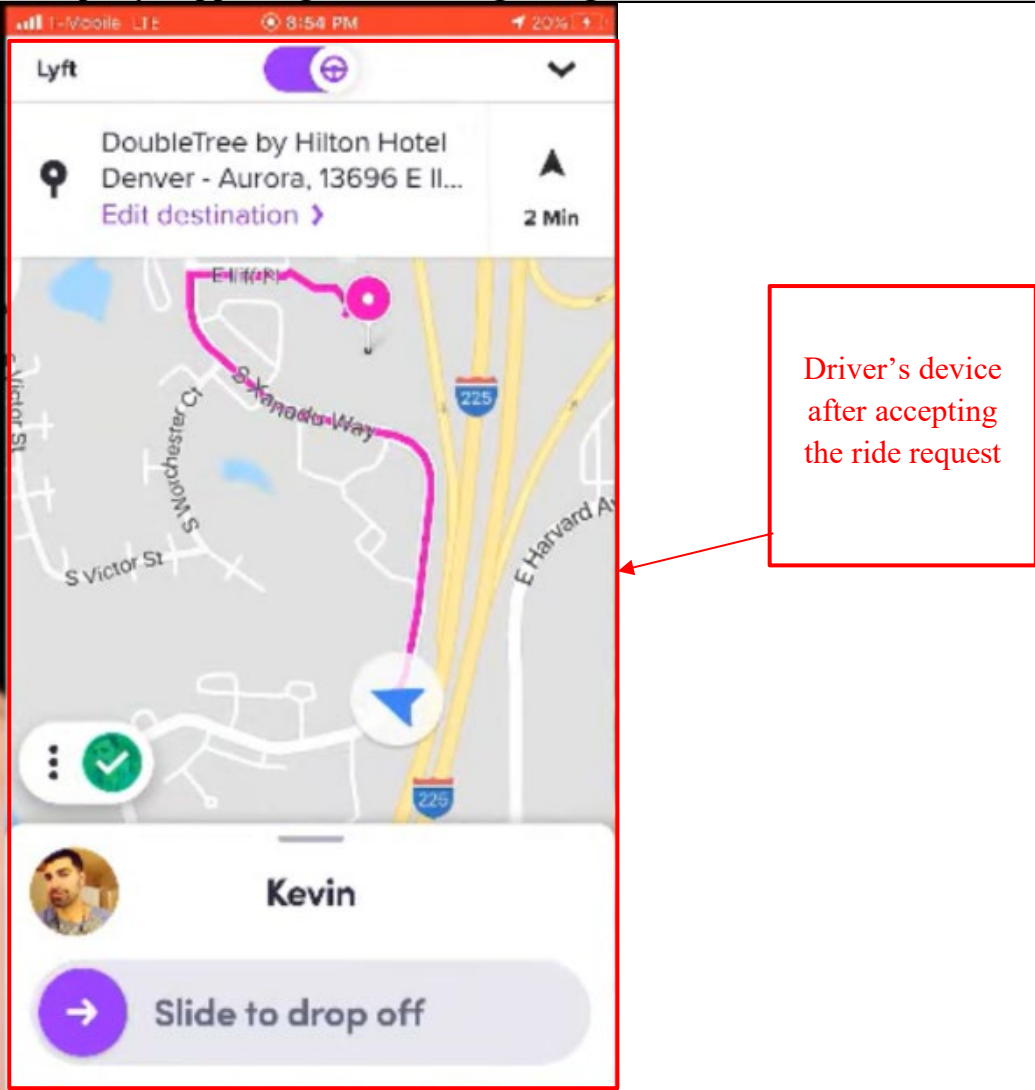
Exhibit D for US Patent No. 8,213,970 Against Lyft Accused Products

Claim - 8,213,970	Exemplary Supporting Evidence Regarding Accused Products
	 <p>The screenshot shows a Lyft app interface. At the top, the route is from Terminal 1, Arrivals to New York Marriott Marquis. The map displays the area around JFK Airport, with a purple line indicating the pickup route. A red box on the map highlights two driver icons, with an arrow pointing to a text box labeled "Nearby Drivers' location". Another red box highlights a blue location pin at JFK, with an arrow pointing to a text box labeled "Passenger's location". Below the map, three ride options are listed: Lyft (US\$64.81, 3:20 AM), Lyft XL (US\$81.65, 3:22 AM), and Car seat (US\$76.50, 3:34 AM). A large purple button at the bottom says "Select Lyft".</p>

Exhibit D for US Patent No. 8,213,970 Against Lyft Accused Products

Claim - 8,213,970	Exemplary Supporting Evidence Regarding Accused Products
	<p data-bbox="533 248 743 448">Driver's device screen locked displaying passenger's ride request message</p>  <p data-bbox="478 899 1398 932">https://www.youtube.com/watch?v=jVUy9poJDng at 10:24, Annotated</p>

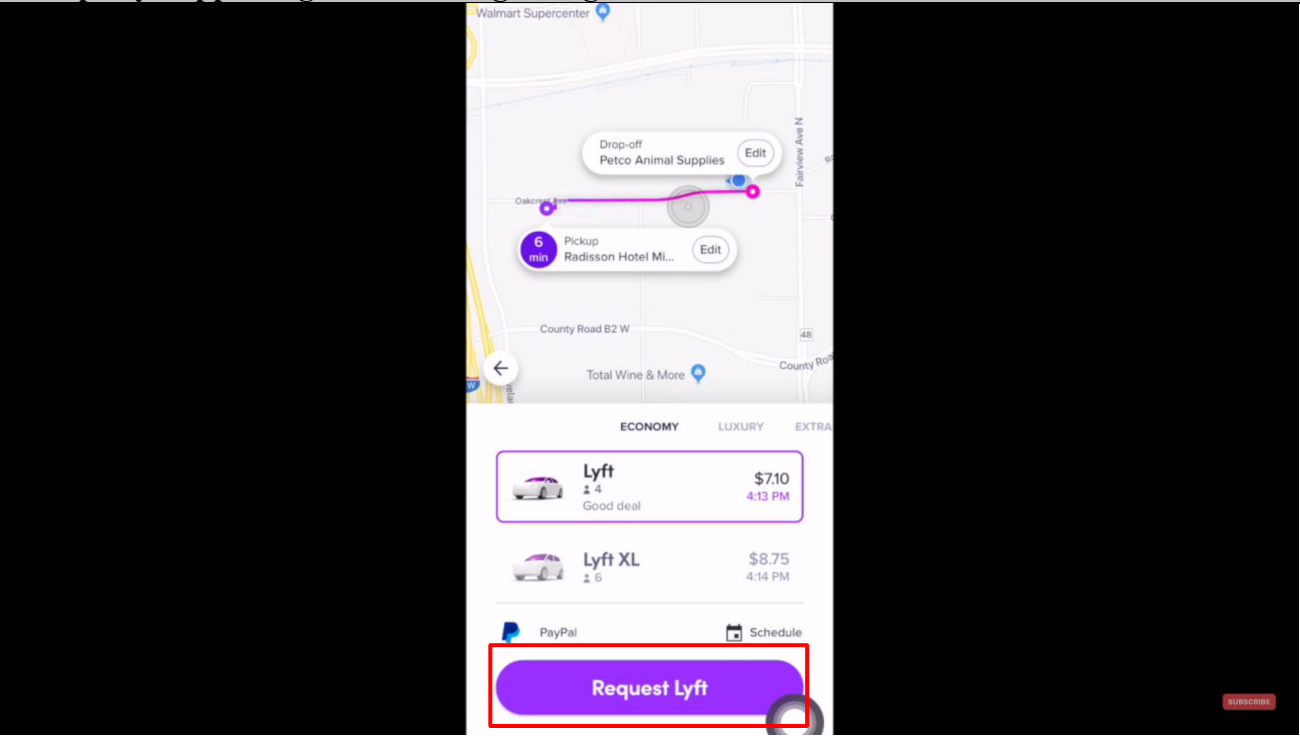
Exhibit D for US Patent No. 8,213,970 Against Lyft Accused Products

Claim - 8,213,970	Exemplary Supporting Evidence Regarding Accused Products
	 <p data-bbox="1260 568 1491 698">Driver's device after accepting the ride request</p> <p data-bbox="478 1315 1365 1347">https://www.youtube.com/watch?v=b31WorLlcqE at 9:40, Annotated</p>

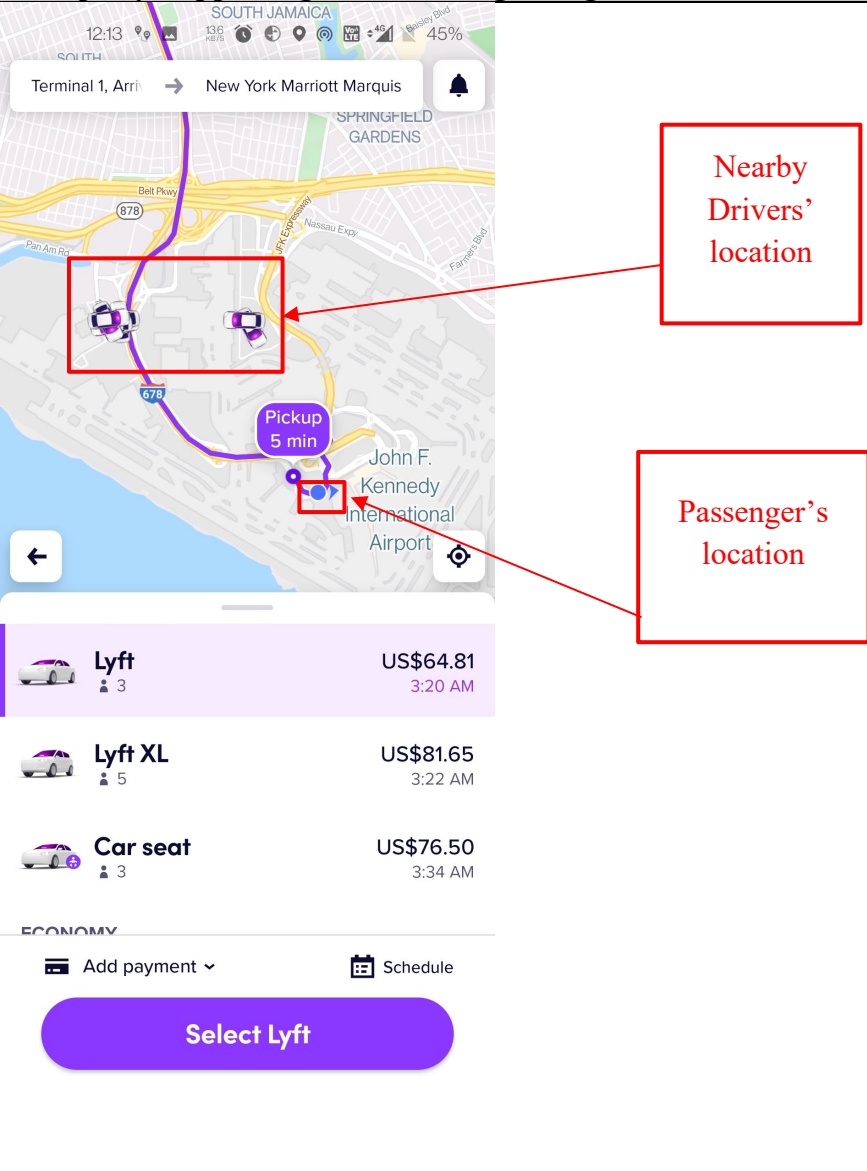
Exhibit D for US Patent No. 8,213,970 Against Lyft Accused Products

Claim - 8,213,970	Exemplary Supporting Evidence Regarding Accused Products
	Further, to the extent this element is performed at least in part by Lyft's software source code, AGIS reserves the right to supplement these contentions pursuant to production of such source code by Lyft and to the extent Defendant requires additional information in accordance with P.R. 3-1 and for any other reasons.
2[C]. means for allowing a manual response to be manually selected from the response list or manually recorded and transmitting said manual response to the sender PDA/cell phone; and	<p>The Lyft Accused Products infringe directly and/or indirectly by performing, inducing others to perform, and/or contributing to the performance of: means for allowing a manual response to be manually selected from the response list or manually recorded and transmitting said manual response to the sender PDA/cell phone</p> <p>This element is infringed literally, or in the alternative, under the doctrine of equivalents.</p> <p>For example, the response list, including but not limited to accept and decline (cross button) in the forced message alert is displayed on the driver's device which is manually selected by the driver. The response from the driver who accepts the ride request is transmitted to the passenger along with the driver's information including but not limited to vehicle model, driver name, location and vehicle number.</p>

Exhibit D for US Patent No. 8,213,970 Against Lyft Accused Products

Claim - 8,213,970	Exemplary Supporting Evidence Regarding Accused Products
	 <p>https://www.youtube.com/watch?v=j0RDMLcmOgU at 4:01</p>

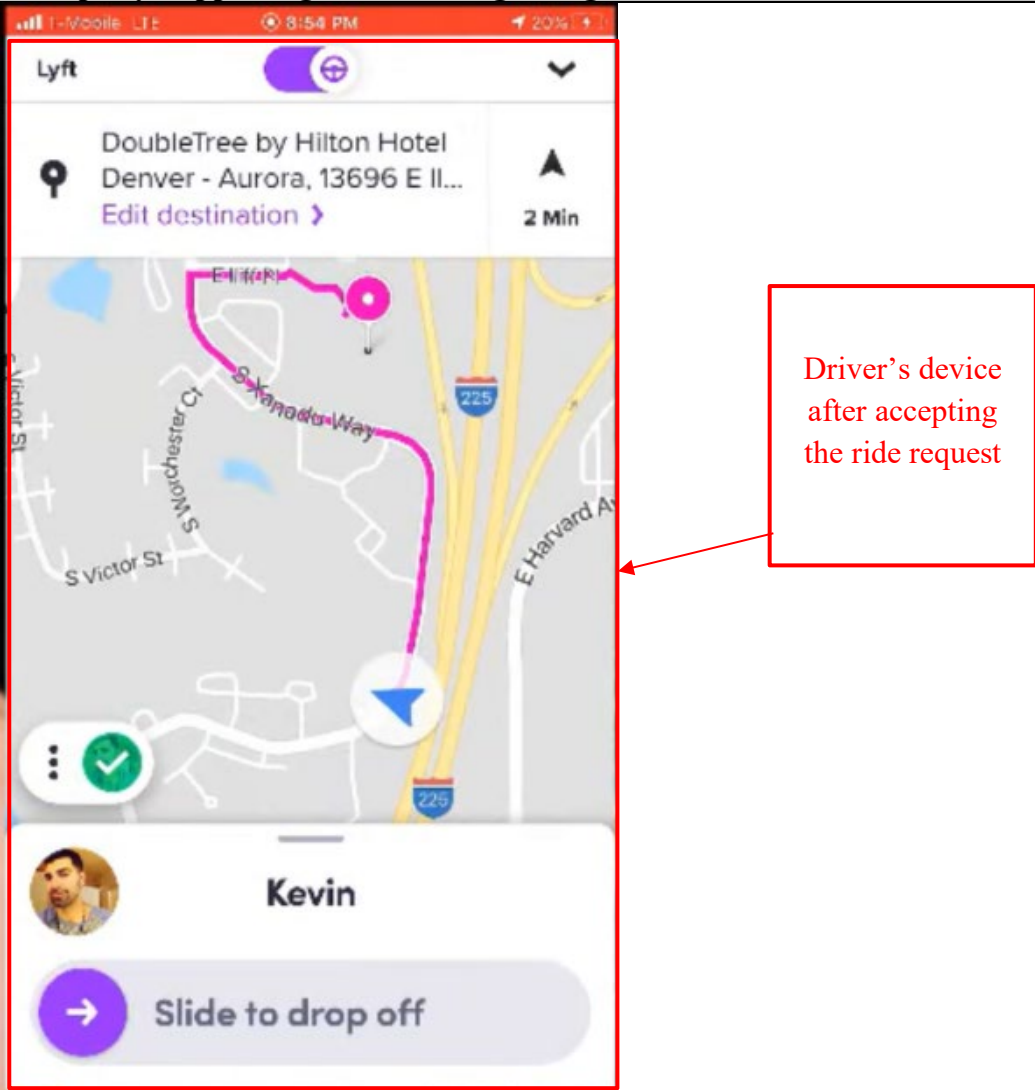
Exhibit D for US Patent No. 8,213,970 Against Lyft Accused Products

Claim - 8,213,970	Exemplary Supporting Evidence Regarding Accused Products
	 <p>The screenshot displays the Lyft app interface. At the top, the route is set from 'Terminal 1, Arrivals' to 'New York Marriott Marquis'. The map shows the area around JFK Airport, with a 'Pickup 5 min' timer. Two driver icons are highlighted in a red box, with an arrow pointing to a text box labeled 'Nearby Drivers' location'. A passenger icon is highlighted in another red box, with an arrow pointing to a text box labeled 'Passenger's location'. Below the map, three ride options are listed: 'Lyft' (US\$64.81, 3:20 AM), 'Lyft XL' (US\$81.65, 3:22 AM), and 'Car seat' (US\$76.50, 3:34 AM). At the bottom, there is a 'Select Lyft' button.</p>

Exhibit D for US Patent No. 8,213,970 Against Lyft Accused Products

Claim - 8,213,970	Exemplary Supporting Evidence Regarding Accused Products
	<p data-bbox="533 248 743 448">Driver's device screen locked displaying passenger's ride request message</p>  <p data-bbox="478 899 1398 932">https://www.youtube.com/watch?v=jVUy9poJDng at 10:24, Annotated</p>

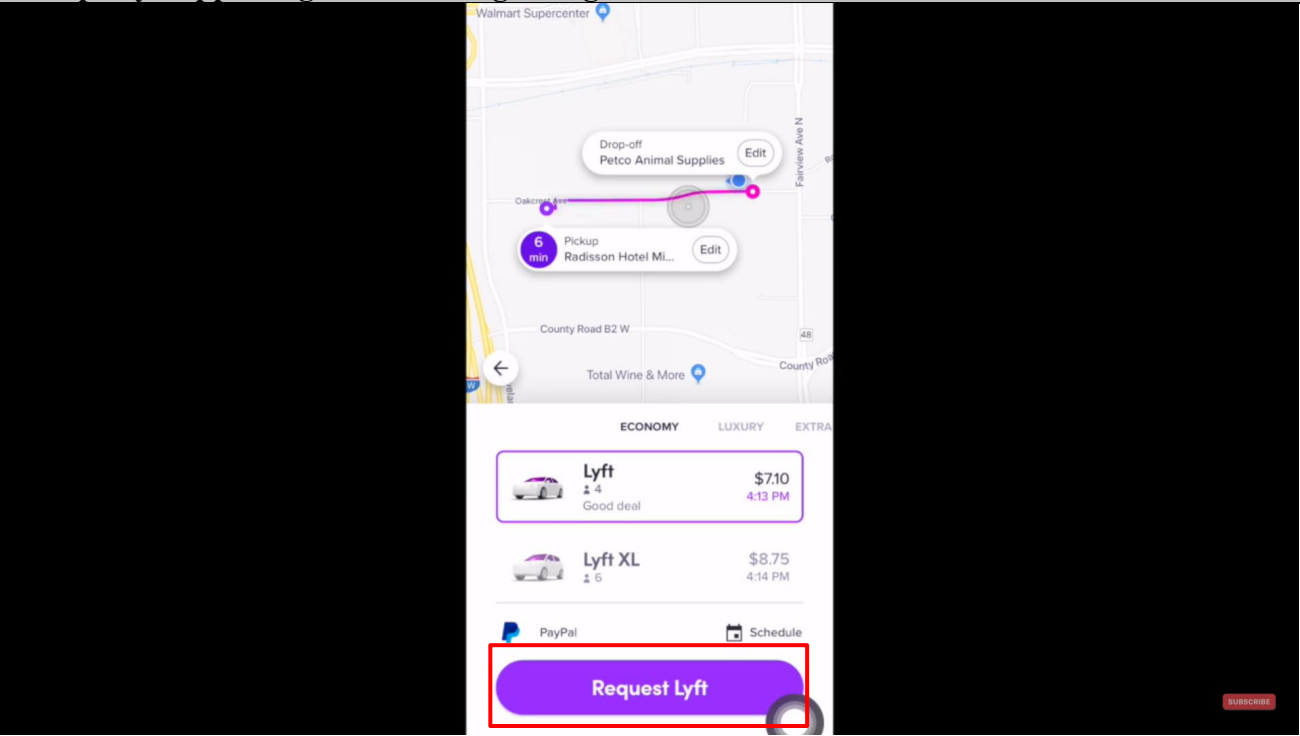
Exhibit D for US Patent No. 8,213,970 Against Lyft Accused Products

Claim - 8,213,970	Exemplary Supporting Evidence Regarding Accused Products
	 <p data-bbox="1260 568 1491 698">Driver's device after accepting the ride request</p> <p data-bbox="478 1312 1365 1347">https://www.youtube.com/watch?v=b31WorLlcqE at 9:40, Annotated</p>

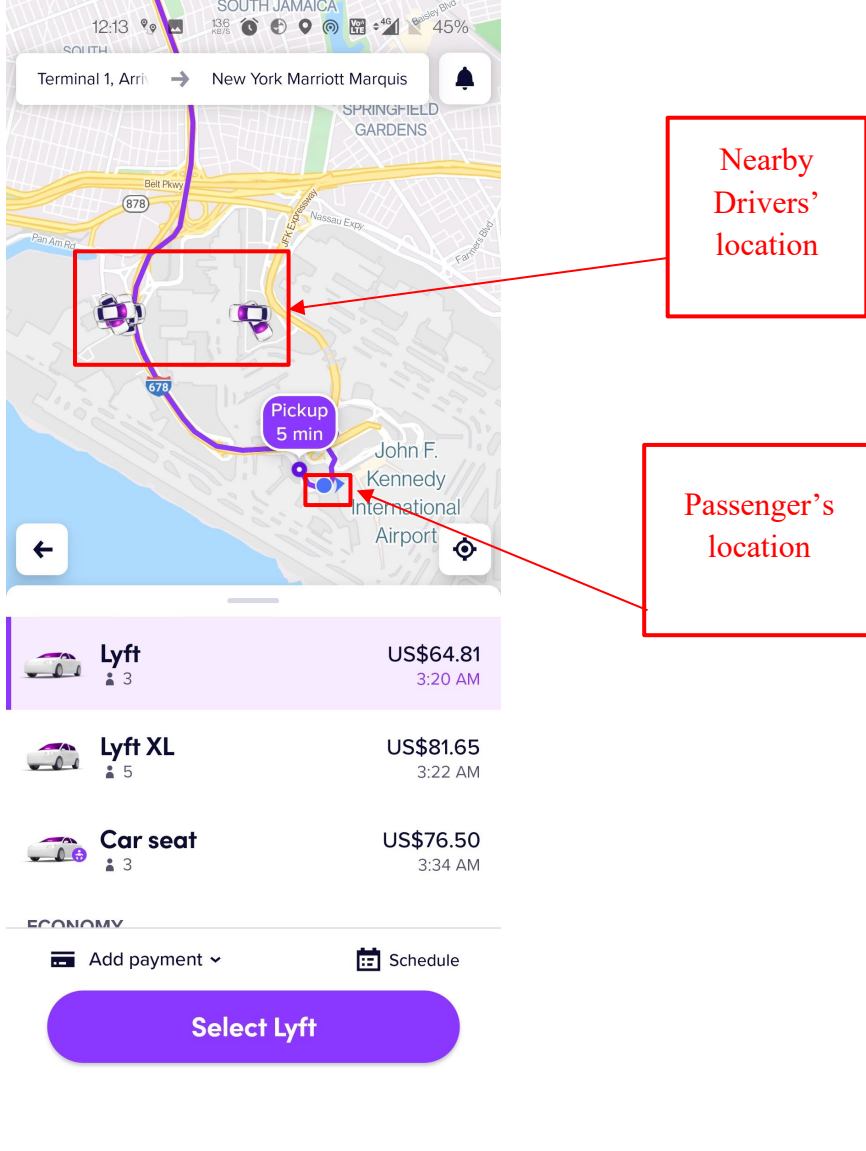
Exhibit D for US Patent No. 8,213,970 Against Lyft Accused Products

Claim - 8,213,970	Exemplary Supporting Evidence Regarding Accused Products
	 <p>https://www.youtube.com/watch?v=j0RDMLcmOgU at 5:07</p> <p>Further, to the extent this element is performed at least in part by Lyft's software source code, AGIS reserves the right to supplement these contentions pursuant to production of such source code by Lyft and to the extent Defendant requires additional information in accordance with P.R. 3-1 and for any other reasons.</p>
<p>2[D]. means for clearing the text message and a response list from the display of the recipient PDA/cell phone or stopping</p>	<p>The Lyft Accused Products infringe directly and/or indirectly by performing, inducing others to perform, and/or contributing to the performance of: means for clearing the text message and a response list from the display of the recipient PDA/cell phone or stopping the repeating voice message and clearing the response list from the display of the recipient PDA/cell phone once the manual response is transmitted.</p> <p>This element is infringed literally, or in the alternative, under the doctrine of equivalents.</p>

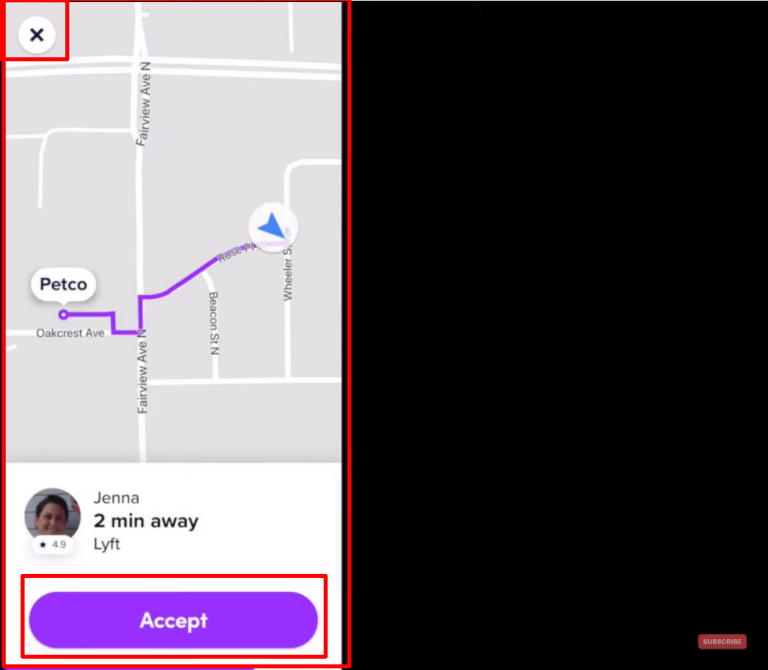
Exhibit D for US Patent No. 8,213,970 Against Lyft Accused Products

Claim - 8,213,970	Exemplary Supporting Evidence Regarding Accused Products
the repeating voice message and clearing the response list from the display of the recipient PDA/cell phone once the manual response is transmitted.	For example, the Lyft Driver app receives an electronically transmitted request for a ride from a passenger which triggers a forced message alert that locks the driver's device ("controlling of the recipient PDA/cell phone") for a period of time until the driver ("recipient") sends a response message (decline (cross button) or accept) to clear the locked display.

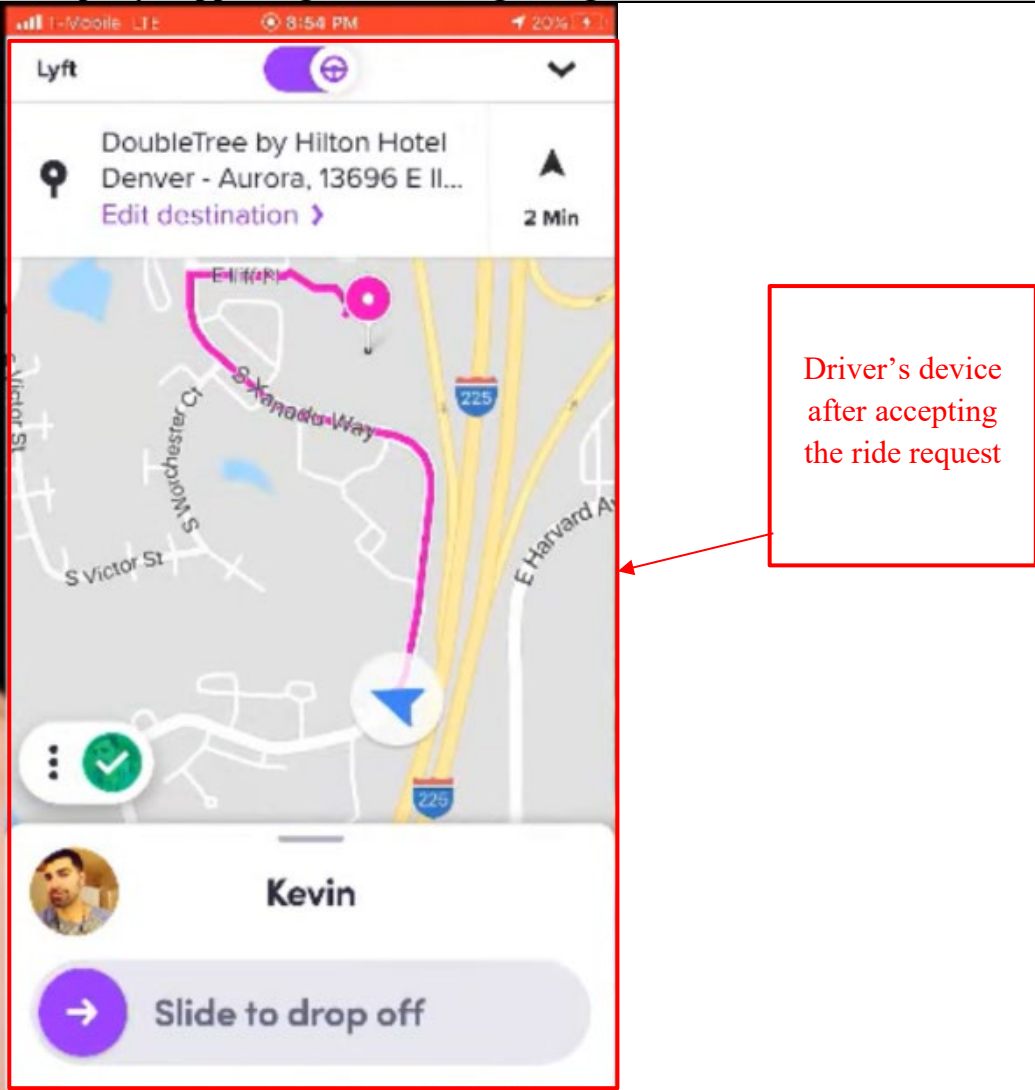
Exhibit D for US Patent No. 8,213,970 Against Lyft Accused Products

Claim - 8,213,970	Exemplary Supporting Evidence Regarding Accused Products
	 <p>The screenshot displays the Lyft app interface. At the top, the route is set from Terminal 1, Arrivals to New York Marriott Marquis. The map shows the area around JFK Airport, with a red box highlighting two nearby driver locations. A red box also highlights the passenger's location at the airport. Below the map, three ride options are listed: Lyft (US\$64.81, 3:20 AM), Lyft XL (US\$81.65, 3:22 AM), and Car seat (US\$76.50, 3:34 AM). A large purple button at the bottom says "Select Lyft".</p> <p>Nearby Drivers' location</p> <p>Passenger's location</p>

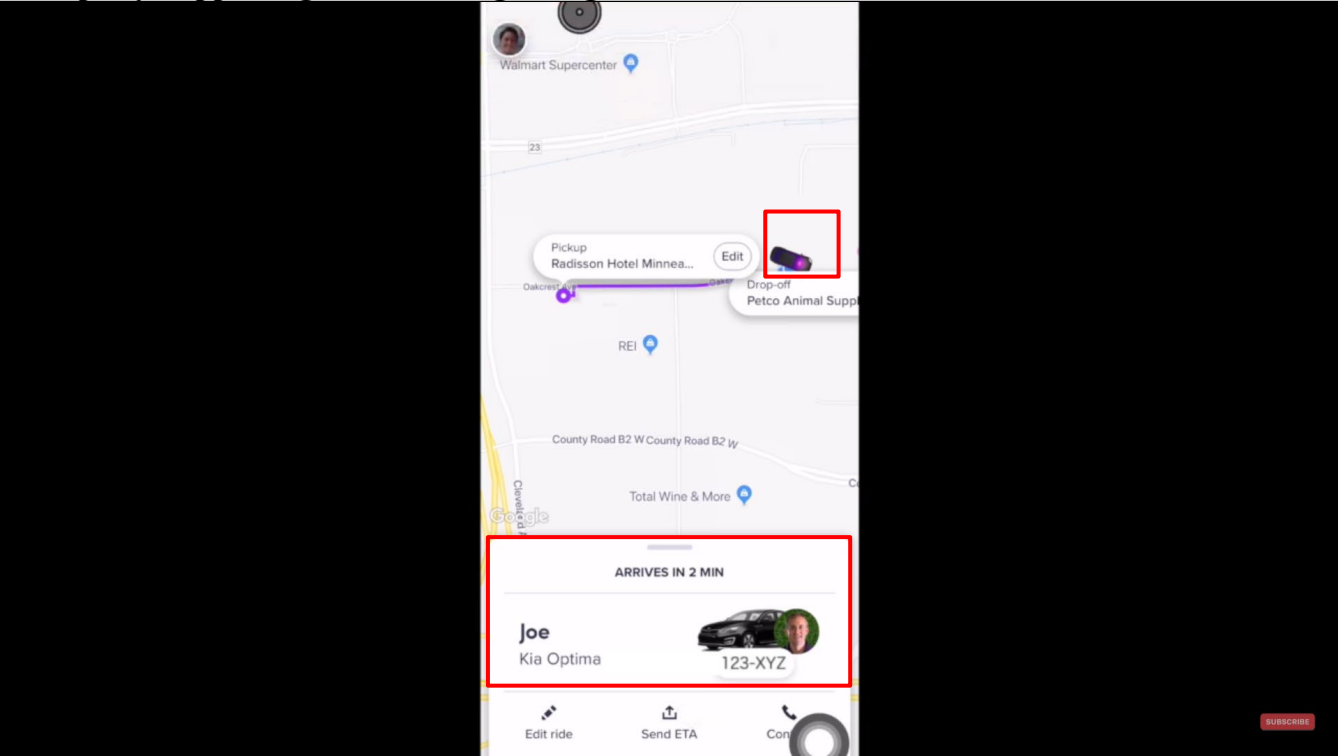
Exhibit D for US Patent No. 8,213,970 Against Lyft Accused Products

Claim - 8,213,970	Exemplary Supporting Evidence Regarding Accused Products
	<p data-bbox="533 248 743 448">Driver's device screen locked displaying passenger's ride request message</p>  <p data-bbox="478 899 1398 932">https://www.youtube.com/watch?v=jVUy9poJDng at 10:24, Annotated</p>

Exhibit D for US Patent No. 8,213,970 Against Lyft Accused Products

Claim - 8,213,970	Exemplary Supporting Evidence Regarding Accused Products
	 <p>Driver's device screen locked displaying passenger's ride request message is removed after driver chooses the response (here accept response)</p> <p>https://www.youtube.com/watch?v=b31WorLlcqE at 9:40, Annotated</p>

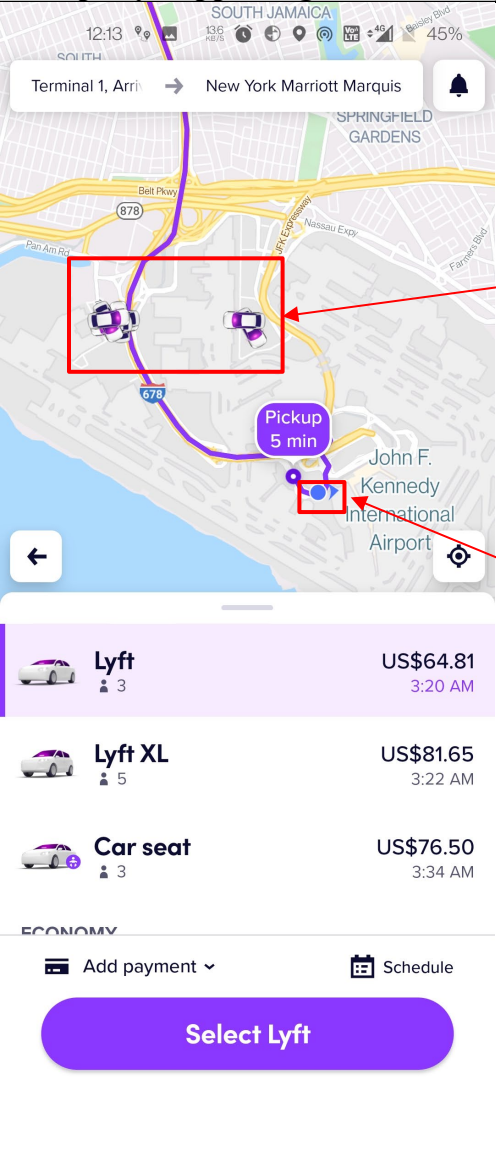
Exhibit D for US Patent No. 8,213,970 Against Lyft Accused Products

Claim - 8,213,970	Exemplary Supporting Evidence Regarding Accused Products
	Further, to the extent this element is performed at least in part by Lyft's software source code, AGIS reserves the right to supplement these contentions pursuant to production of such source code by Lyft and to the extent Defendant requires additional information in accordance with P.R. 3-1 and for any other reasons.
10[P]. A method of receiving, acknowledging and responding to a forced message alert from a sender PDA/cell phone to a recipient PDA/cell phone, wherein the receipt, acknowledgment, and response to said forced message alert is forced by a forced message alert software application program, said method comprising the steps of:	<p>The Lyft Accused Products performs a computer implemented method as set forth below. Lyft further infringe directly and/or indirectly by performing, inducing others to perform, and/or contributing to the performance of: a method of receiving, acknowledging and responding to a forced message alert from a sender PDA/cell phone to a recipient PDA/cell phone, wherein the receipt, acknowledgment, and response to said forced message alert is forced by a forced message alert software application program.</p> <p>This element is infringed literally, or in the alternative, under the doctrine of equivalents.</p> <p>For example, Lyft provides Lyft app for passengers and Lyft Driver app for drivers. The Lyft apps for riders and drivers, in conjunction with Lyft's servers and services, provide users with interactive methods to request, view, and track locations of passengers/riders using real-time maps and communications. The Lyft server(s) and their services communicate with the Lyft apps for riders and drivers. The Lyft server(s) and their services host information related to and instructions for processing user/device/vehicle accounts, location data, and map data. The claimed methods are distributed by Lyft in the Lyft apps. The claimed methods are used/tested by Lyft using the Lyft apps. The claimed methods are downloaded and installed by Lyft's customers (riders) and personnel (drivers, personnel) at the direction/encouragement of Lyft and used by Lyft's customers and Lyft's personnel.</p> <p>A passenger ("sender") requests a ride which is transmitted to the nearby drivers. The Lyft Driver application receives an electronically transmitted request for a ride which triggers a forced message alert that locks the device for a period of time until the driver ("recipient") sends a response message (decline or accept) to clear the locked display ("receiving, acknowledging and responding to a forced message alert").</p>

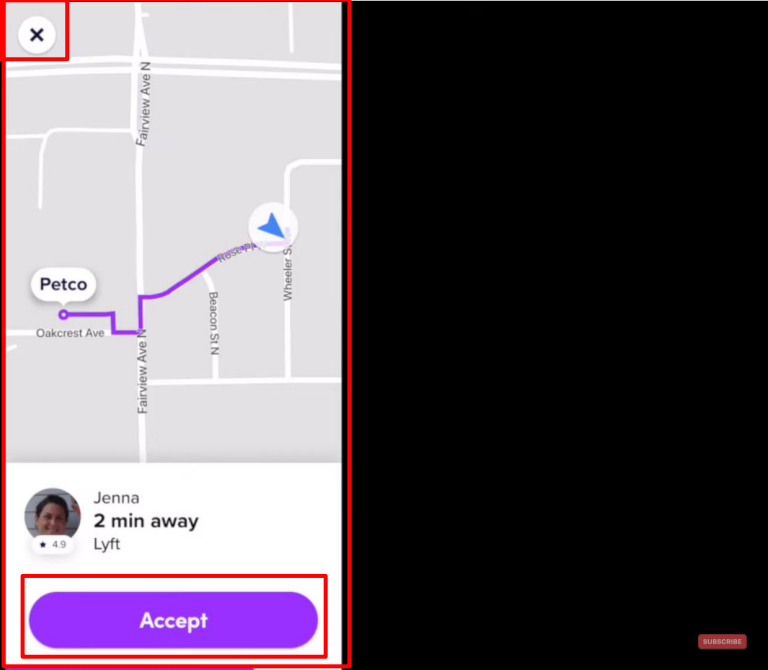
Exhibit D for US Patent No. 8,213,970 Against Lyft Accused Products

Claim - 8,213,970	Exemplary Supporting Evidence Regarding Accused Products
	<h1 data-bbox="489 240 982 318">Lyft Driver app</h1> <div data-bbox="489 354 1719 440" style="border: 1px solid red; padding: 5px;"><p data-bbox="489 362 1719 427">We've separated the passenger and driver experiences into two separate mobile apps — one exclusively for passengers (named the Lyft app) and the other exclusively for drivers (named the Lyft Driver app).</p></div> <p data-bbox="489 459 1751 557">The Lyft Driver app will eventually be standard for all drivers and required for driving. At this time, drivers can keep using the Lyft app to give rides. Don't worry! While we have some planned improvements to the Lyft Driver app, we've kept its features the same.</p> <p data-bbox="489 589 1377 621">https://help.lyft.com/hc/en-ca/articles/115013079208-Lyft-Driver-app</p> <h2 data-bbox="489 675 793 724">What is Lyft?</h2> <p data-bbox="489 776 1560 846">Lyft is a platform that connects drivers with individuals and organizations that need rides.</p> <p data-bbox="489 873 957 906">https://www.lyft.com/drive-with-lyft</p>

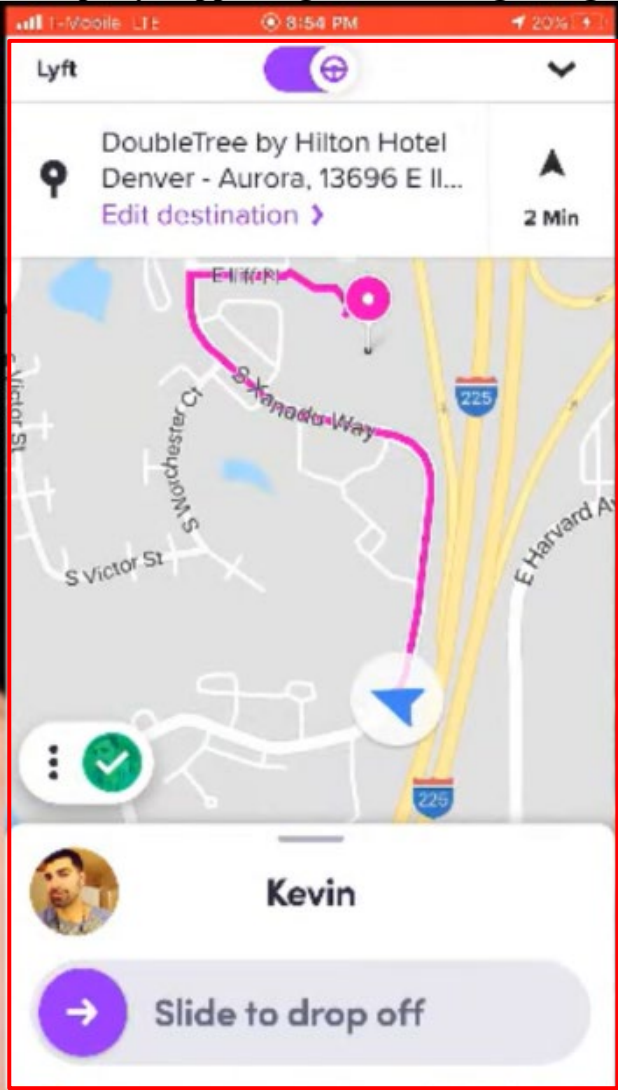
Exhibit D for US Patent No. 8,213,970 Against Lyft Accused Products

Claim - 8,213,970	Exemplary Supporting Evidence Regarding Accused Products
	 <p data-bbox="485 626 604 651">Go online</p> <p data-bbox="485 691 1675 797">Open your Lyft Driver app and tap the steering wheel icon. Lyft will now find the closest passenger to your location requesting a ride. Turn on some music and get comfortable: that first ride request may come quickly or may take a while, depending on the number of current passenger requests.</p> <p data-bbox="485 805 1136 829">https://www.lyft.com/hub/posts/how-to-give-a-ride</p>

Exhibit D for US Patent No. 8,213,970 Against Lyft Accused Products

Claim - 8,213,970	Exemplary Supporting Evidence Regarding Accused Products
	<p data-bbox="525 243 756 454">Driver's device screen locked displaying passenger's ride request messages</p>  <p data-bbox="483 885 1396 917">https://www.youtube.com/watch?v=jVUy9poJDng at 10:24, Annotated</p>

Exhibit D for US Patent No. 8,213,970 Against Lyft Accused Products

Claim - 8,213,970	Exemplary Supporting Evidence Regarding Accused Products	
		
	<p>https://www.youtube.com/watch?v=j0RDMLcmOgU at 4:01</p> <p>Further, to the extent this element is performed at least in part by Lyft's software source code, AGIS reserves the right to supplement these contentions pursuant to production of such source code by Lyft and to the extent Defendant requires additional information in accordance with P.R. 3-1 and for any other reasons.</p>	
10[A] receiving an electronically transmitted electronic message; identifying said electronic message	<p>The Lyft Accused Products infringe directly and/or indirectly by performing, inducing others to perform, and/or contributing to the performance of: receiving an electronically transmitted electronic message; identifying said electronic message as a forced message alert, wherein said forced message alert comprises of a voice or text message and a forced message alert application software packet, which triggers the activation of the forced message alert software application program within the recipient PDA/cell phone.</p> <p>This element is infringed literally, or in the alternative, under the doctrine of equivalents.</p>	

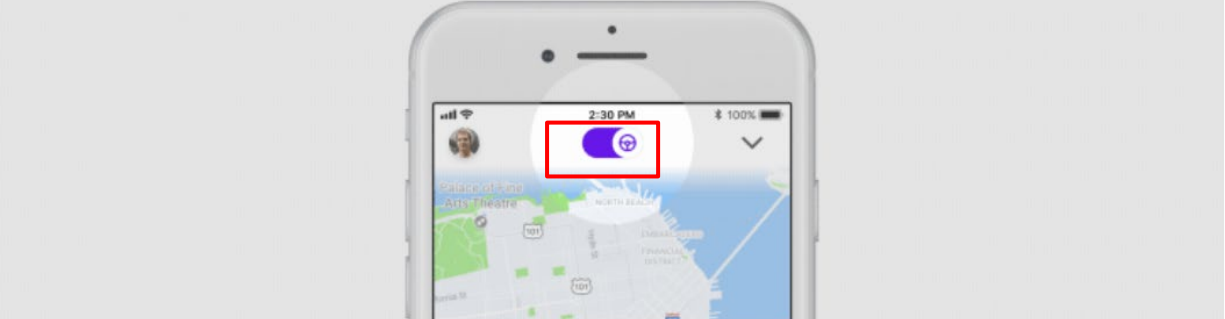
Exhibit D for US Patent No. 8,213,970 Against Lyft Accused Products

Claim - 8,213,970	Exemplary Supporting Evidence Regarding Accused Products
<p>as a forced message alert, wherein said forced message alert comprises of a voice or text message and a forced message alert application software packet, which triggers the activation of the forced message alert software application program within the recipient PDA/cell phone;</p>	<p>For example, the Lyft Driver application receives an electronically transmitted request for a ride from a passenger which triggers a forced message alert that locks the driver's device for a period of time until the driver ("recipient") sends a response message (decline or accept) to clear the locked display.</p>  <p>https://www.youtube.com/watch?v=j0RDMLcmOgU at 4:01</p>

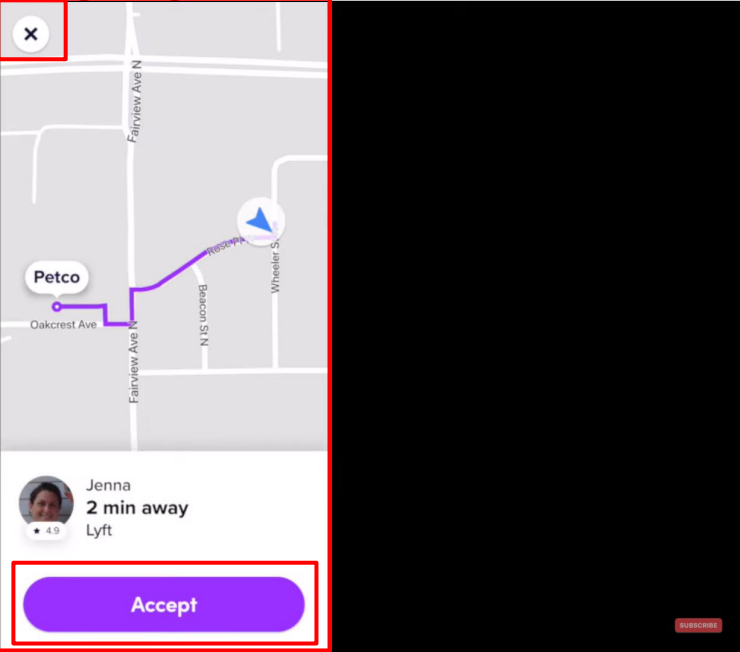
Exhibit D for US Patent No. 8,213,970 Against Lyft Accused Products

Claim - 8,213,970	Exemplary Supporting Evidence Regarding Accused Products
	<div style="border: 1px solid black; padding: 10px;"> <div style="border: 2px solid red; padding: 5px; margin-bottom: 10px;"> <p style="color: red; text-align: center;">Driver's device screen locked displaying passenger's ride request messages</p> </div>  <p style="color: blue; text-decoration: underline;"> https://www.youtube.com/watch?v=jVUy9poJDng at 10:24, Annotated </p> </div> <p>Further, to the extent this element is performed at least in part by Lyft's software source code, AGIS reserves the right to supplement these contentions pursuant to production of such source code by Lyft and to the extent Defendant requires additional information in accordance with P.R. 3-1 and for any other reasons.</p>
10[B] transmitting an automatic acknowledgment of receipt to the sender PDA/cell phone, which triggers the forced message alert software application	<p>The Lyft Accused Products infringe directly and/or indirectly by performing, inducing others to perform, and/or contributing to the performance of: transmitting an automatic acknowledgment of receipt to the sender PDA/cell phone, which triggers the forced message alert software application program to take control of the recipient PDA/cell phone and show the content of the text message and a required response list on the display recipient PDA/cell phone or to repeat audibly the content of the voice message on the speakers of the recipient PDA/cell phone and show the required response list on the display recipient PDA/cell phone.</p> <p>This element is infringed literally, or in the alternative, under the doctrine of equivalents.</p>

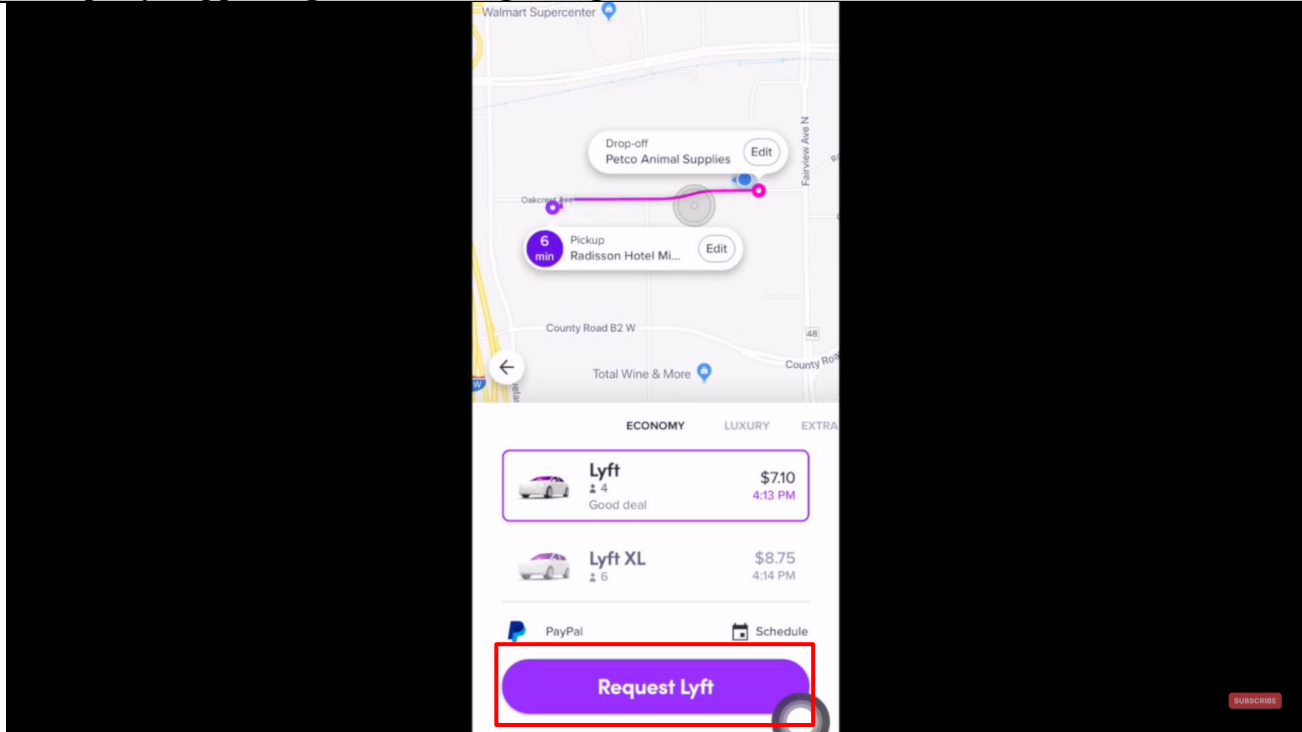
Exhibit D for US Patent No. 8,213,970 Against Lyft Accused Products

Claim - 8,213,970	Exemplary Supporting Evidence Regarding Accused Products
<p>program to take control of the recipient PDA/cell phone and show the content of the text message and a required response list on the display recipient PDA/cell phone or to repeat audibly the content of the voice message on the speakers of the recipient PDA/cell phone and show the required response list on the display recipient PDA/cell phone; and</p>	<p>For example, at the backend, each nearby driver's Lyft app that received a ride request sends an acknowledgement of receipt to Lyft's servers and upon information and belief, further to the passenger's Lyft app.</p> <p>For example, the ride request takes control of the Lyft driver's device, displays a message with at least a pickup location and list of responses including but not limited to accept or decline (cross button). Further, the Lyft driver app plays an alert until a response is selected.</p> <div style="text-align: center;">  </div> <p>https://www.youtube.com/watch?v=j0RDMLcmOgU at 4:01</p>

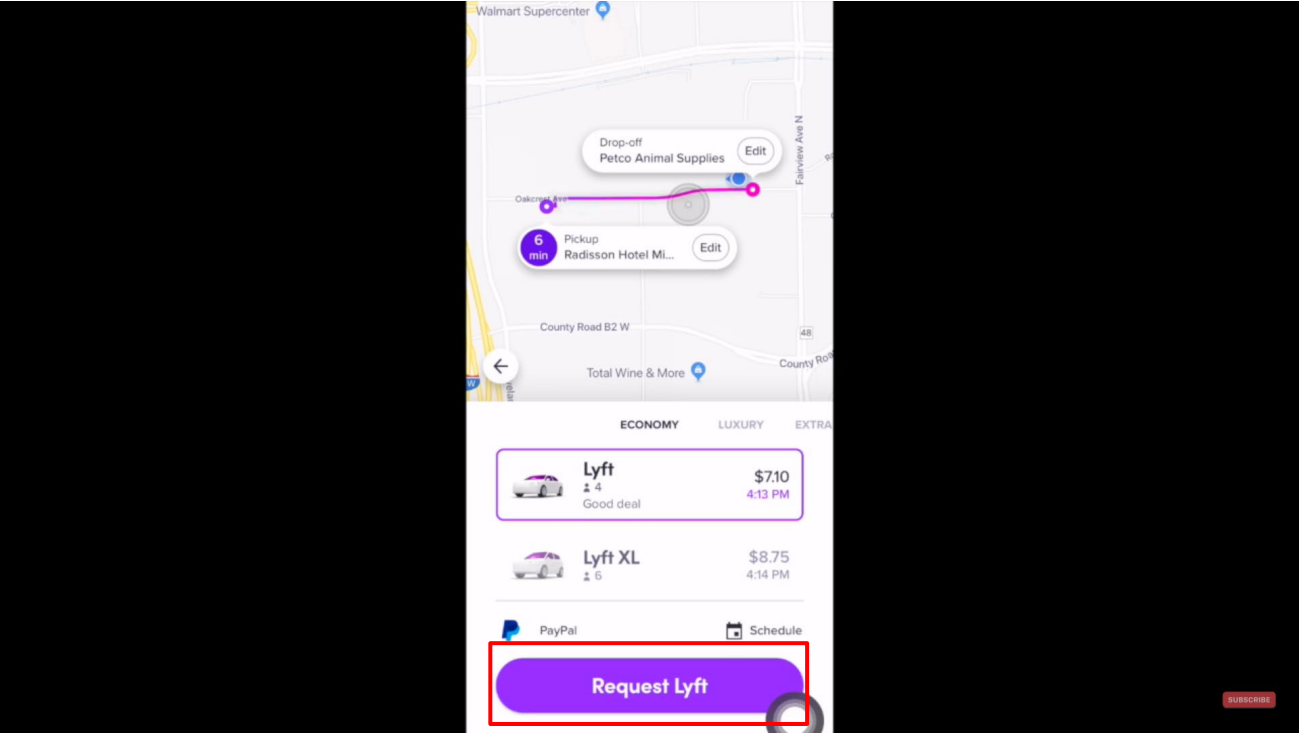
Exhibit D for US Patent No. 8,213,970 Against Lyft Accused Products

Claim - 8,213,970	Exemplary Supporting Evidence Regarding Accused Products
	<div style="border: 1px solid black; padding: 10px;"> <div style="border: 2px solid red; padding: 5px; margin-bottom: 10px;"> <p style="color: red; text-align: center;">Driver's device screen locked displaying passenger's ride request messages</p> </div>  <p style="color: blue; text-decoration: underline;"> https://www.youtube.com/watch?v=jVUy9poJDng at 10:24, Annotated </p> </div> <p>Further, to the extent this element is performed at least in part by Lyft's software source code, AGIS reserves the right to supplement these contentions pursuant to production of such source code by Lyft and to the extent Defendant requires additional information in accordance with P.R. 3-1 and for any other reasons.</p>
<p>10[C] transmitting a selected required response from the response list in order to allow the message required response list to be cleared from the recipient's cell phone display,</p>	<p>The Lyft Accused Products infringe directly and/or indirectly by performing, inducing others to perform, and/or contributing to the performance of: transmitting a selected required response from the response list in order to allow the message required response list to be cleared from the recipient's cell phone display, whether said selected response is a chosen option from the response list, causing the forced message alert software to release control of the recipient PDA/cell phone and stop showing the content of the text message and a response list on the display recipient PDA/cell phone and or stop repeating the content of the voice message on the speakers of the recipient PDA/cell phone.</p> <p>This element is infringed literally, or in the alternative, under the doctrine of equivalents.</p>

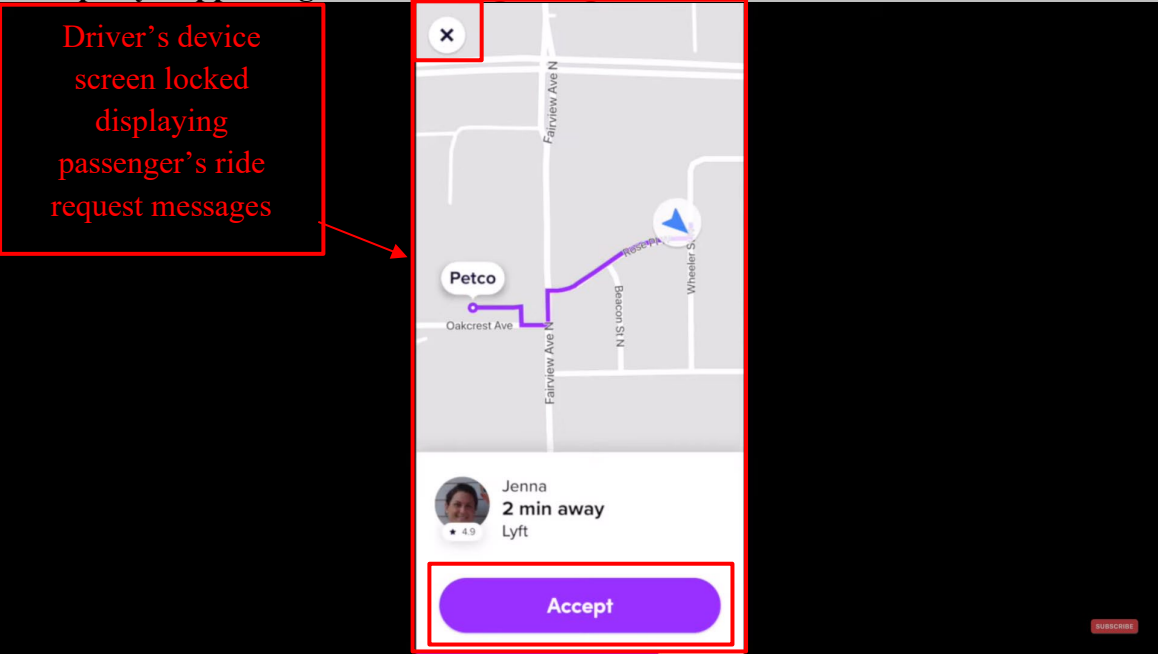
Exhibit D for US Patent No. 8,213,970 Against Lyft Accused Products

Claim - 8,213,970	Exemplary Supporting Evidence Regarding Accused Products
<p>whether said selected response is a chosen option from the response list, causing the forced message alert software to release control of the recipient PDA/cell phone and stop showing the content of the text message and a response list on the display recipient PDA/cell phone and or stop repeating the content of the voice message on the speakers of the recipient PDA/cell phone;</p>	<p>For example, the Lyft driver app requires selecting to accept or dismiss a ride request to release control of the driver's device (clear the locked display showing ride request message). Selecting a response also stops the alerts in driver's device.</p>  <p>https://www.youtube.com/watch?v=j0RDMLcmOgU at 4:01</p>

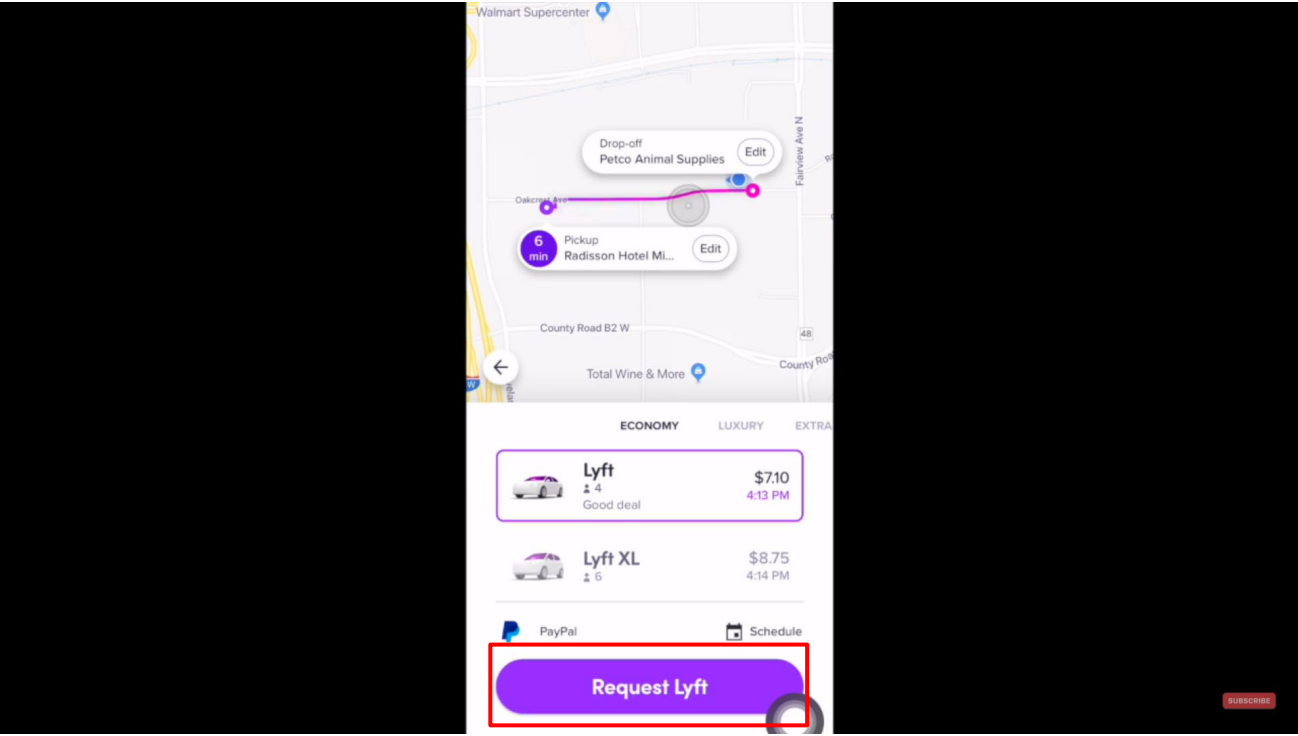
Exhibit D for US Patent No. 8,213,970 Against Lyft Accused Products

Claim - 8,213,970	Exemplary Supporting Evidence Regarding Accused Products
	 <p>https://www.youtube.com/watch?v=jVUy9poJDng at 10:24, Annotated</p> <p>Further, to the extent this element is performed at least in part by Lyft's software source code, AGIS reserves the right to supplement these contentions pursuant to production of such source code by Lyft and to the extent Defendant requires additional information in accordance with P.R. 3-1 and for any other reasons.</p>
<p>10[D] displaying the response received from the PDA cell phone that transmitted the response on the sender of the forced alert PDA/cell phone; and</p>	<p>The Lyft Accused Products infringe directly and/or indirectly by performing, inducing others to perform, and/or contributing to the performance of: displaying the response received from the PDA cell phone that transmitted the response on the sender of the forced alert PDA/cell phone.</p> <p>This element is infringed literally, or in the alternative, under the doctrine of equivalents.</p> <p>For example, the Lyft app displays a driver's response of accepting the request for a ride on the passenger's device. For example, the screenshot below shows Joe (driver) who accepted a passenger's request for a ride.</p>

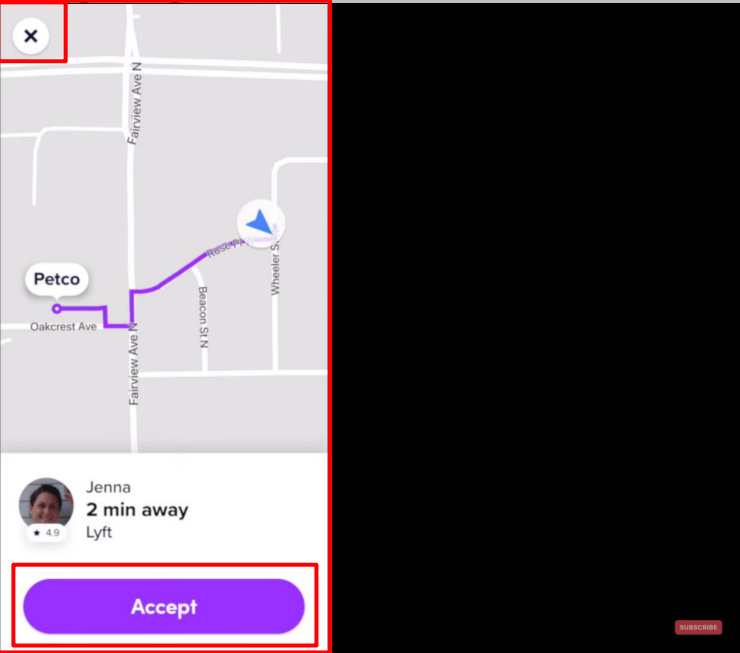
Exhibit D for US Patent No. 8,213,970 Against Lyft Accused Products

Claim - 8,213,970	Exemplary Supporting Evidence Regarding Accused Products
	 <p>https://www.youtube.com/watch?v=j0RDMLcmOgU, at 5:05</p> <p>Further, to the extent this element is performed at least in part by Lyft's software source code, AGIS reserves the right to supplement these contentions pursuant to production of such source code by Lyft and to the extent Defendant requires additional information in accordance with P.R. 3-1 and for any other reasons.</p>
10[E] providing a list of the recipient PDA/cell phones have automatically acknowledged receipt of a forced alert message and	<p>The Lyft Accused Products infringe directly and/or indirectly by performing, inducing others to perform, and/or contributing to the performance of: providing a list of the recipient PDA/cell phones have automatically acknowledged receipt of a forced alert message and their response to the forced alert message.</p> <p>This element is infringed literally, or in the alternative, under the doctrine of equivalents.</p>

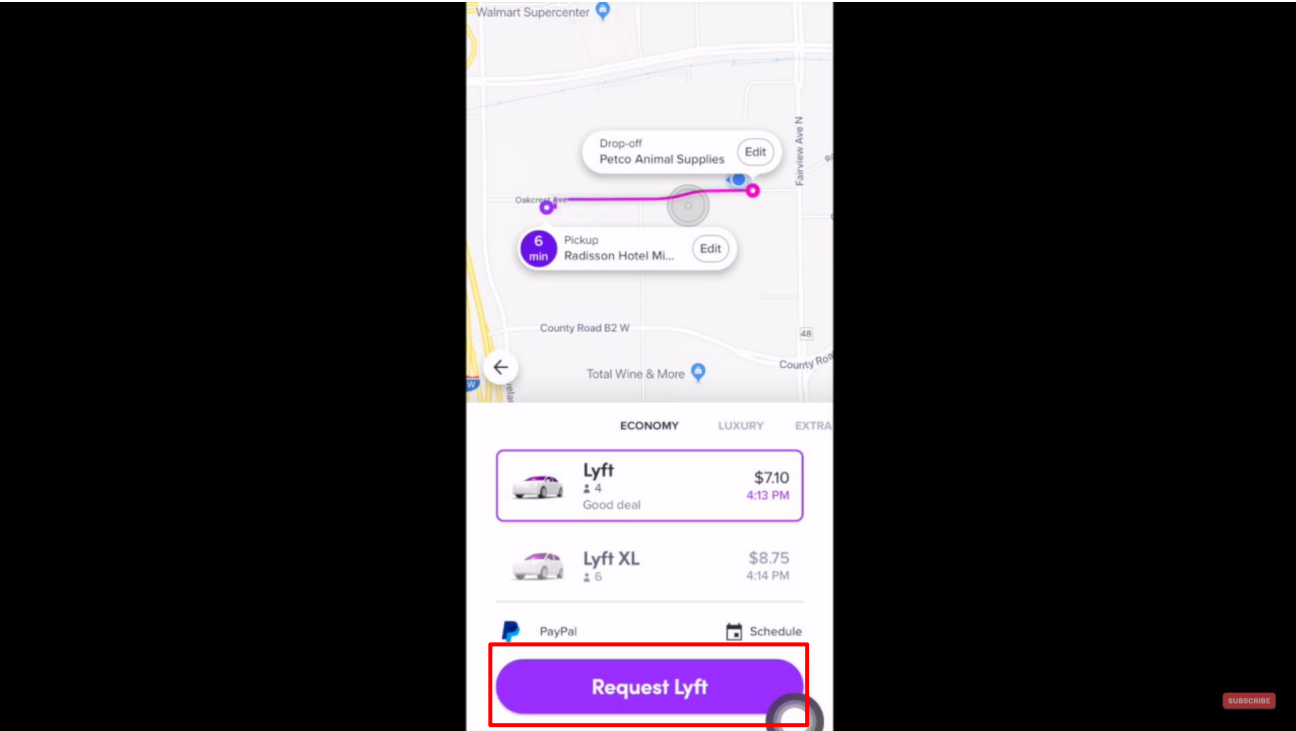
Exhibit D for US Patent No. 8,213,970 Against Lyft Accused Products

Claim - 8,213,970	Exemplary Supporting Evidence Regarding Accused Products
<p>their response to the forced alert message.</p>	<p>For example, upon information and belief, at the backend, a list of all drivers' devices that automatically acknowledged the ride request of the passenger along with their response to the ride request message are maintained at Lyft's server. This ensures that the same drivers do not receive any further ride requests from the same passenger in case the ride request has not been matched yet thus lowering the traffic on network.</p> <div data-bbox="474 412 1770 1141"></div> <p>https://www.youtube.com/watch?v=j0RDMLcmOgU at 4:01</p>

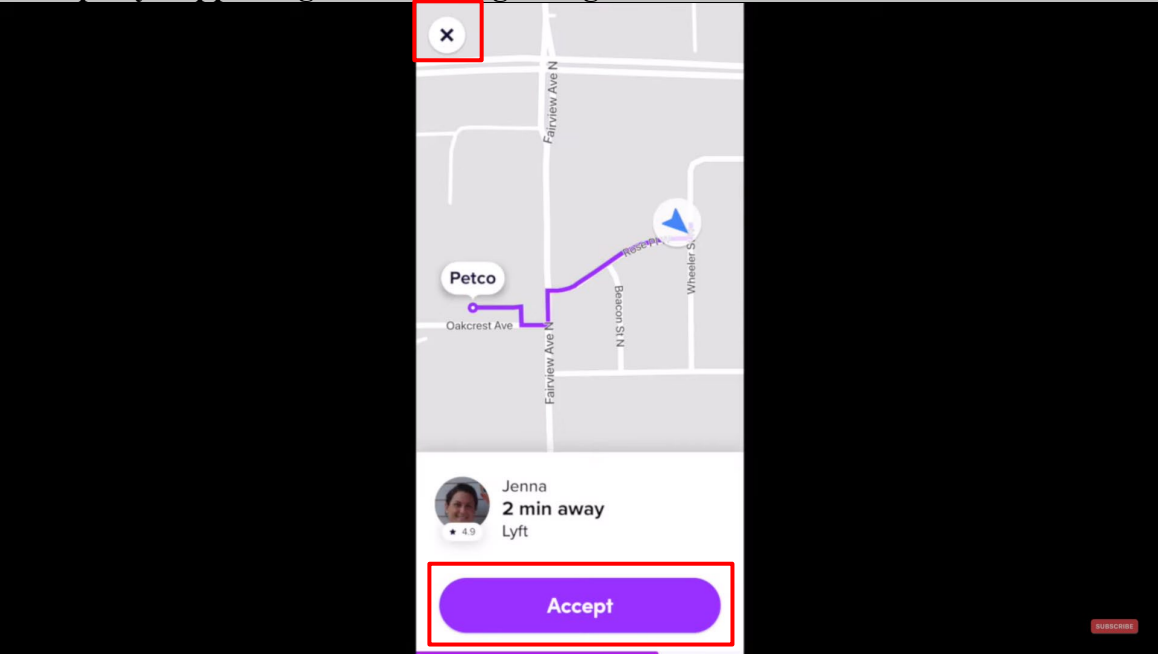
Exhibit D for US Patent No. 8,213,970 Against Lyft Accused Products

Claim - 8,213,970	Exemplary Supporting Evidence Regarding Accused Products
	 <p>https://www.youtube.com/watch?v=jVUy9poJDng at 10:24, Annotated</p> <p>Further, to the extent this element is performed at least in part by Lyft's software source code, AGIS reserves the right to supplement these contentions pursuant to production of such source code by Lyft and to the extent Defendant requires additional information in accordance with P.R. 3-1 and for any other reasons.</p>
<p>11. The method as in claim 10, wherein each PDA/cell phone within a predetermined communication network is similarly equipped and has the forced</p>	<p>See Claims 1[P] and 1[A] above.</p>

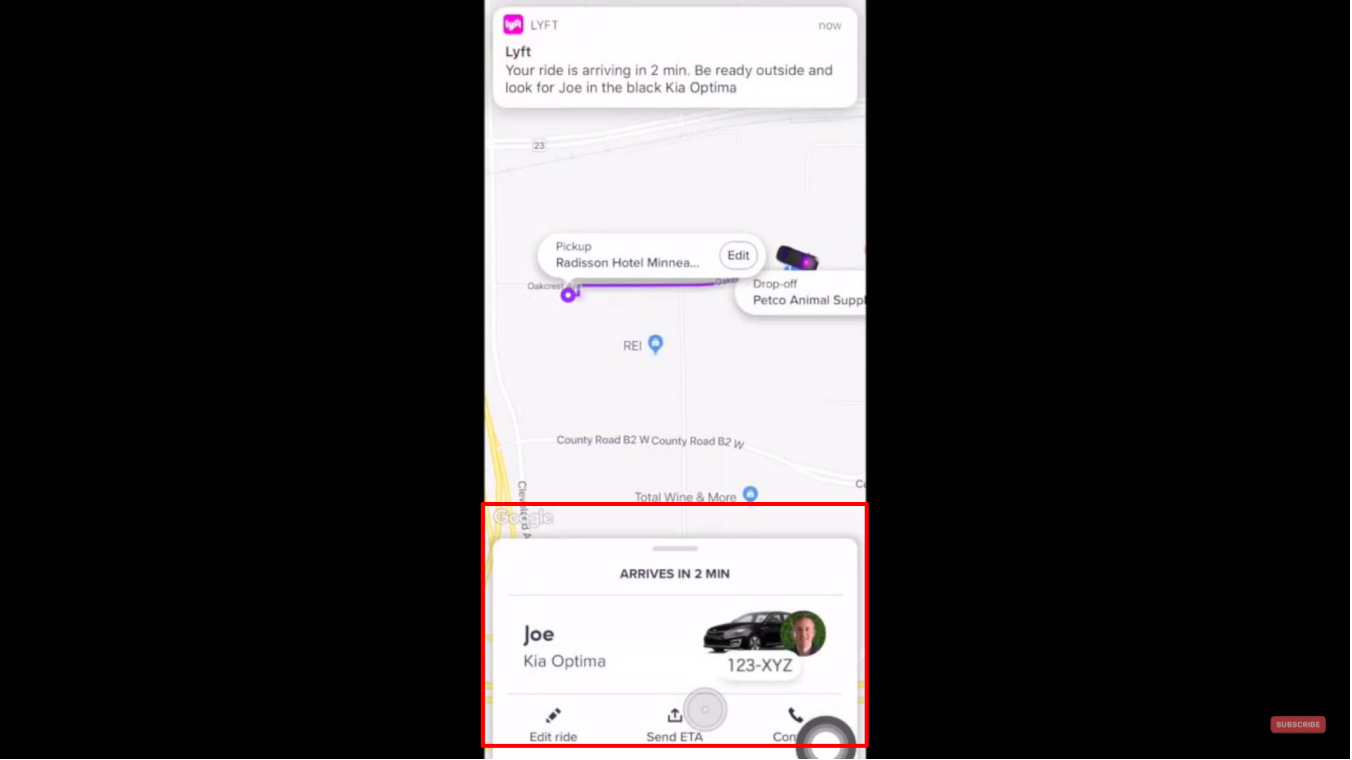
Exhibit D for US Patent No. 8,213,970 Against Lyft Accused Products

Claim - 8,213,970	Exemplary Supporting Evidence Regarding Accused Products
<p>message alert software application program loaded on it.</p>	
<p>12. The method as in claim 10, wherein said forced message alert application software packet contains a response list, wherein said response list is a default list embedded in the forced message alert software application program.</p>	<p>The Lyft Accused Products infringe directly and/or indirectly by performing, inducing others to perform, and/or contributing to the performance of: the method as in claim 10, wherein said forced message alert application software packet contains a response list, wherein said response list is a default list embedded in the forced message alert software application program.</p> <p>This element is infringed literally, or in the alternative, under the doctrine of equivalents.</p> <p>For example, a ride request message transmitted to the driver’s Lyft Driver app comprises an accept or decline option to respond to the passenger’s request (default list embedded in the forced message alert software application program).</p>  <p>The image is a screenshot of a mobile application interface, likely the Lyft Driver app. It shows a map with a purple route starting from 'Petco' and heading towards a destination. Below the map, there is a driver profile for 'Jenna' with a 4.9 rating and the text '2 min away Lyft'. At the bottom of the screen, a large purple button with the word 'Accept' in white text is highlighted with a red rectangular border. A 'SUBSCRIBE' button is visible in the bottom right corner of the app interface.</p>

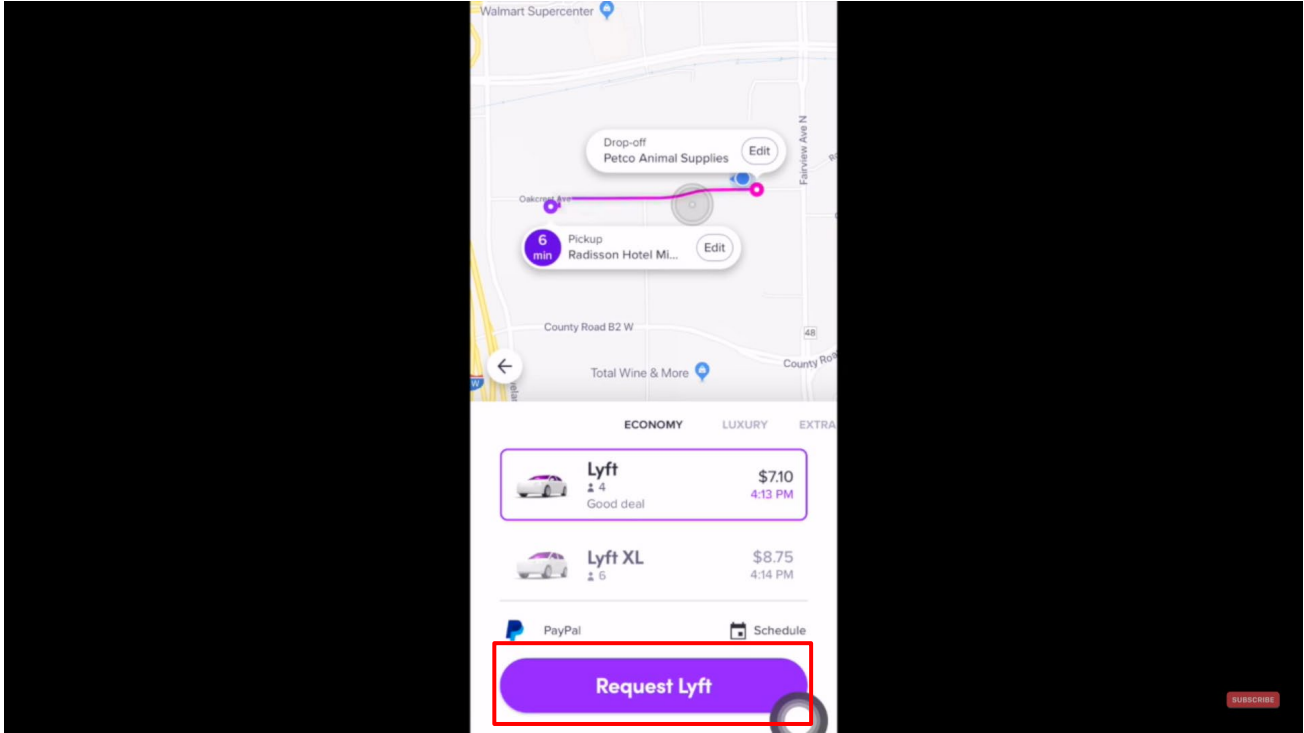
Exhibit D for US Patent No. 8,213,970 Against Lyft Accused Products

Claim - 8,213,970	Exemplary Supporting Evidence Regarding Accused Products
	<p data-bbox="478 235 1396 267">https://www.youtube.com/watch?v=jVUy9poJDng at 10:24, Annotated</p> <p data-bbox="478 310 1881 412">Further, to the extent this element is performed at least in part by Lyft's software source code, AGIS reserves the right to supplement these contentions pursuant to production of such source code by Lyft and to the extent Defendant requires additional information in accordance with P.R. 3-1 and for any other reasons.</p>
<p data-bbox="201 418 449 1070">13. The method as in claim 10, wherein said forced message alert application software packet contains a response list, wherein said response list is a custom response list that is created at the time the specific forced message alert is created on the sender PDA/cell phone.</p>	<p data-bbox="478 418 716 451"><i>See claim 5 above.</i></p>

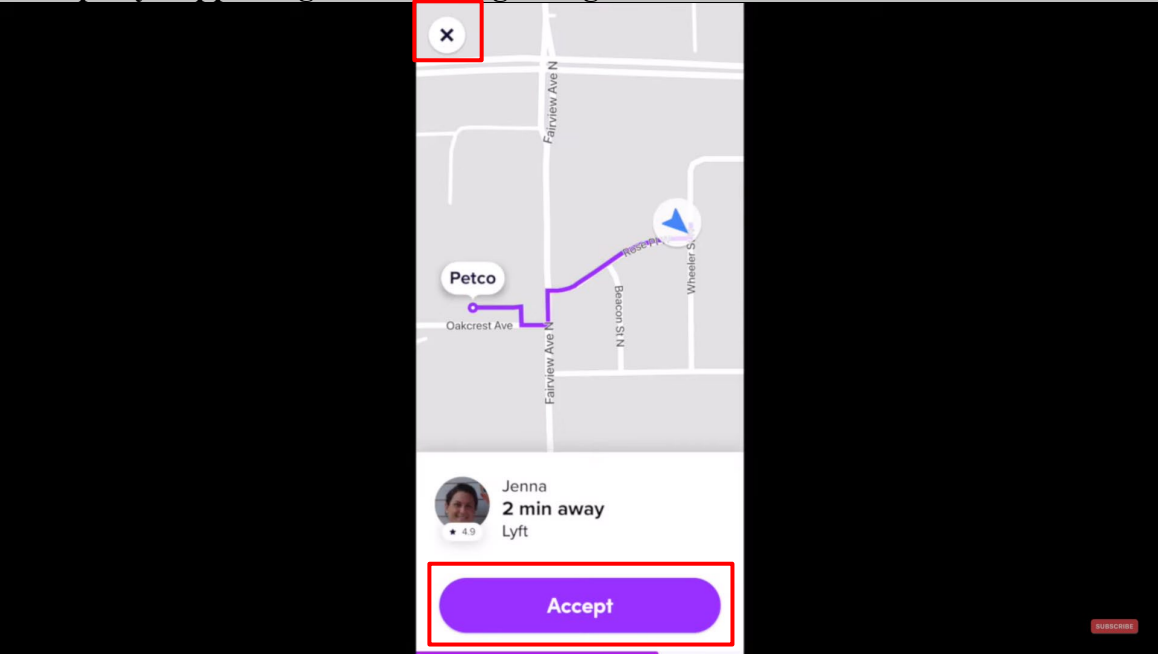
Exhibit E for US Patent No. 7,031,728 Against Lyft Accused Products

Based on information presently available, AGIS Software Development LLC (“AGIS”) contends that Defendant Lyft Inc. (collectively “Lyft” or “Defendant”) infringes claim 7 (the “Asserted Claim”) of U.S. Patent No. 7,031,728 (the “’728 Patent”) through the Accused Products, Services which are manufactured, sold, offered for sale, and/or used by Lyft.

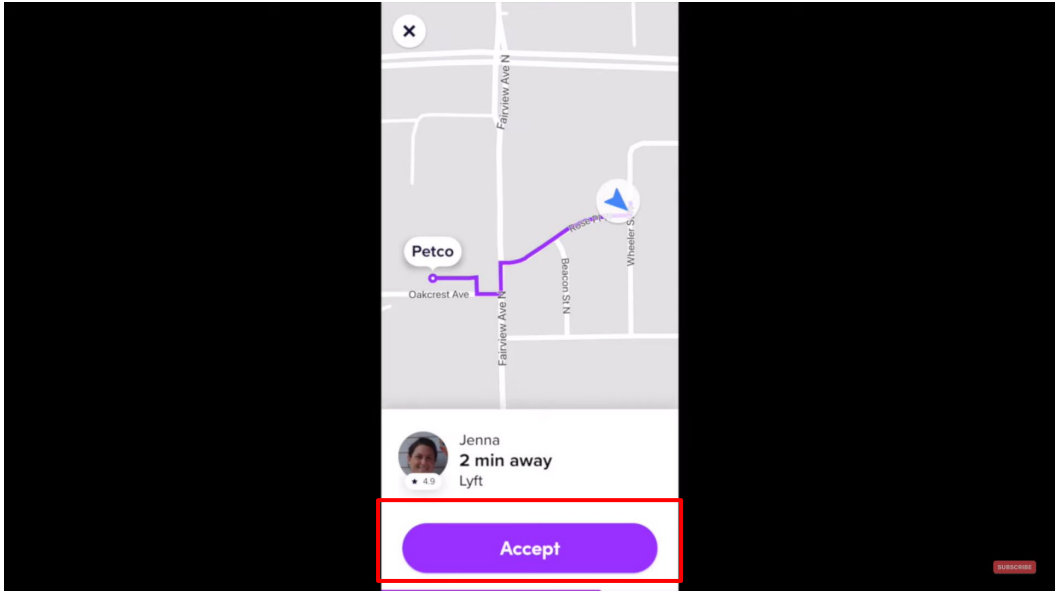
The Accused Products comprise all versions of the Lyft Application made, used, sold, offered for sale, or otherwise provided, after September 21, 2004. For example, the Accused Products comprise the Lyft application installed on all Android, iOS, Blackberry, and Windows Mobile based mobile devices (e.g. smartphones, tablets, laptops, and smart watches), and any variants thereof. AGIS reserves the right to amend this list of Accused Products as discovery progresses.

Lyft directly infringes each of the Asserted Claims by using, importing, testing, selling, and/or offering for sale the Accused Products in violation of 35 U.S.C. § 271(a).

Lyft indirectly infringes the Asserted Claims in violation of 35 U.S.C. § 271(b) by inducing third parties, including its users and/or customers, to directly infringe through their operation and use of the Accused Products. Lyft has knowingly and intentionally induced this direct infringement by, *inter alia*, (i) selling, importing, or otherwise providing the Accused Products to third parties with the intent that the Accused Products will be operated and used in a manner that practices the Asserted Claims; and (ii) marketing and advertising the Accused Products. Lyft’s marketing and promotional materials for the Accused Products are found, for example, on Lyft’s website, and in App stores of operating systems for which the Accused Products are made available. For example, Lyft’s website offers customers instructions and/or manuals for the Accused Products that instruct customers to, among other things, use the accused services in the Accused Products. Lyft’s website also offers support to customers, including instruction to, among other things, use the Accused Products share location information with a group of users. On information and belief, Lyft knows that its actions will result in infringement of the Asserted Claims, or subjectively believes that there is a high probability that its actions will result in infringement of the Asserted Claims but has taken deliberate actions to avoid learning these facts.

Lyft also contributorily infringes each of the Asserted Claims in violation of 35 U.S.C. § 271(c) by selling, importing, offering for sale, and otherwise providing the Accused Products, which when used directly infringe the Asserted Claims. The Accused Products constitute a material part of the Asserted Claims.

On information and belief, the charted version of the Lyft application is representative of all versions of the Accused Products, including all variants of the Accused Products made, sold, offered for sale, or used on any version of the Android, iOS, Blackberry, and Windows Mobile operating systems.

Exhibit E for US Patent No. 7,031,728 Against Lyft Accused Products

AGIS does not concede that any claims of the '728 Patent that are not listed below are not infringed by the identified Accused Products. Moreover, the citations to certain documents and other information below are intended to be exemplary only and in no way foreclose AGIS from citing or relying on additional documents, information, source code, and/or testimony at a later time. These contentions are preliminary in nature, and an analysis of Lyft's products, internal documentation, source code, and/or testimony from relevant witnesses may more fully and accurately describe the infringing features of its Accused Products. Accordingly, AGIS reserves the right to supplement, correct, modify, and/or amend these contentions once such additional information is made available to AGIS. Furthermore, AGIS reserves the right to supplement, correct, modify, and/or amend these contentions as discovery in this case progresses; in view of the Court's claim construction order(s); in view of any positions taken by Lyft, including, but not limited to, positions on claim construction,¹ invalidity, and/or non-infringement; and in connection with the preparation and exchange of expert reports.

The contents of each claim cell below on which another claim cell depends are expressly incorporated by reference in that dependent cell, as if set forth in their entirety therein.

¹ The construction of claim terms herein is consistent with the constructions in *AGIS Software Dev. LLC v. Huawei Device USA, Inc.*, No. 2:17-cv-00513-JRG, Dkt. No. 205 (Lead Case) (E.D. Tex. Oct. 10, 2018) and *AGIS Software Dev. LLC v. Google LLC*, No. 2:19-cv-00361-JRG, Dkt. No. 147 (Lead Case) (E.D. Tex. Dec. 20, 2020). AGIS reserves the right to update its constructions and contentions in view of this Court's claim construction order.

Exhibit E for US Patent No. 7,031,728 Against Lyft Accused Products

Claim – 7,031,728	Exemplary Supporting Evidence Regarding Accused Products
<p>7[P]. A method of establishing a cellular phone communication network for designated participants, each having a similarly equipped cellular phone that includes voice communication, free and operator selected text messages, photograph and video, a CPU, a GPS navigation system and a touch screen display comprising the steps of:</p>	<p>The Lyft Accused Products practice the method of establishing a cellular phone communication network for designated participants, each having a similarly equipped cellular phone that includes voice communication, free and operator selected text messages, photograph and video, a CPU, a GPS navigation system and a touch screen display.</p> <p>This element is infringed literally, or in the alternative, under the doctrine of equivalents.</p> <p>For example, Lyft provides Lyft app for passengers and Lyft Driver app for drivers. The Lyft apps for riders and drivers, in conjunction with Lyft’s servers and services, provide users with interactive methods to request, view, and track locations of passengers/riders using real-time maps and communications. The Lyft server(s) and their services communicate with the Lyft apps for riders and drivers. The Lyft server(s) and their services host information related to and instructions for processing user/device/vehicle accounts, location data, and map data. The claimed methods are distributed by Lyft in the Lyft apps. The claimed methods are used/tested by Lyft using the Lyft apps. The claimed methods are downloaded and installed by Lyft’s customers (riders) and personnel (drivers, personnel) at the direction/encouragement of Lyft and used by Lyft’s customers and Lyft’s personnel.</p> <p>For example, when the passenger requests a ride from the Lyft app installed on their mobile phone, the ride request message is broadcasted to the nearby drivers who are online on the Lyft driver app. The message comprises the passenger’s name and profile photo.</p> <p>For example, when the driver accepts the ride request of the passenger, the passenger’s mobile phone receives the driver’s information such as name, location, and driver’s photo. After the passenger and the driver match, both of them get the option to text each other.</p>

Exhibit E for US Patent No. 7,031,728 Against Lyft Accused Products

Claim – 7,031,728	Exemplary Supporting Evidence Regarding Accused Products
	<h1 data-bbox="583 240 1073 318">Lyft Driver app</h1> <div data-bbox="583 354 1814 440" style="border: 1px solid red; padding: 5px;"><p data-bbox="583 362 1814 431">We've separated the passenger and driver experiences into two separate mobile apps — one exclusively for passengers (named the Lyft app) and the other exclusively for drivers (named the Lyft Driver app).</p></div> <p data-bbox="583 459 1843 558">The Lyft Driver app will eventually be standard for all drivers and required for driving. At this time, drivers can keep using the Lyft app to give rides. Don't worry! While we have some planned improvements to the Lyft Driver app, we've kept its features the same.</p> <p data-bbox="583 589 1472 623">https://help.lyft.com/hc/en-ca/articles/115013079208-Lyft-Driver-app</p> <h2 data-bbox="583 675 884 724">What is Lyft?</h2> <p data-bbox="583 776 1654 846">Lyft is a platform that connects drivers with individuals and organizations that need rides.</p> <p data-bbox="583 873 1052 907">https://www.lyft.com/drive-with-lyft</p>

Exhibit E for US Patent No. 7,031,728 Against Lyft Accused Products

Claim – 7,031,728	Exemplary Supporting Evidence Regarding Accused Products
	 <p data-bbox="577 625 703 657">Go online</p> <p data-bbox="577 690 1774 836">Open your Lyft Driver app and tap the steering wheel icon. Lyft will now find the closest passenger to your location requesting a ride. Turn on some music and get comfortable: that first ride request may come quickly or may take a while, depending on the number of current passenger requests. <a data-bbox="577 803 1228 836" href="https://www.lyft.com/hub/posts/how-to-give-a-ride">https://www.lyft.com/hub/posts/how-to-give-a-ride</p>

Exhibit E for US Patent No. 7,031,728 Against Lyft Accused Products

Claim – 7,031,728	Exemplary Supporting Evidence Regarding Accused Products
	<p data-bbox="625 261 840 423">Driver's device displaying passenger's ride request message</p>  <p data-bbox="575 883 1491 915">https://www.youtube.com/watch?v=jVUy9poJDng at 10:24, Annotated</p>

Exhibit E for US Patent No. 7,031,728 Against Lyft Accused Products

Claim – 7,031,728	Exemplary Supporting Evidence Regarding Accused Products
	 <p>https://www.youtube.com/watch?v=j0RDMLcmOgU at 4:01</p>

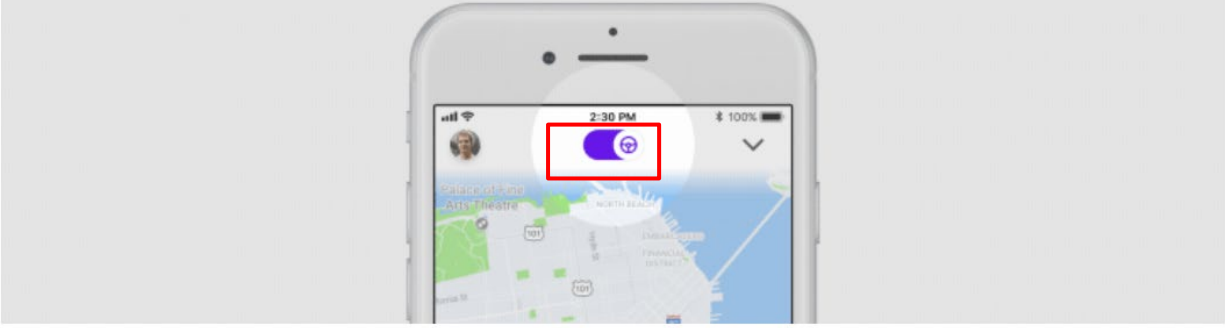
Exhibit E for US Patent No. 7,031,728 Against Lyft Accused Products

Claim – 7,031,728	Exemplary Supporting Evidence Regarding Accused Products
	 <p>https://apps.apple.com/in/app/lyft/id529379082</p>

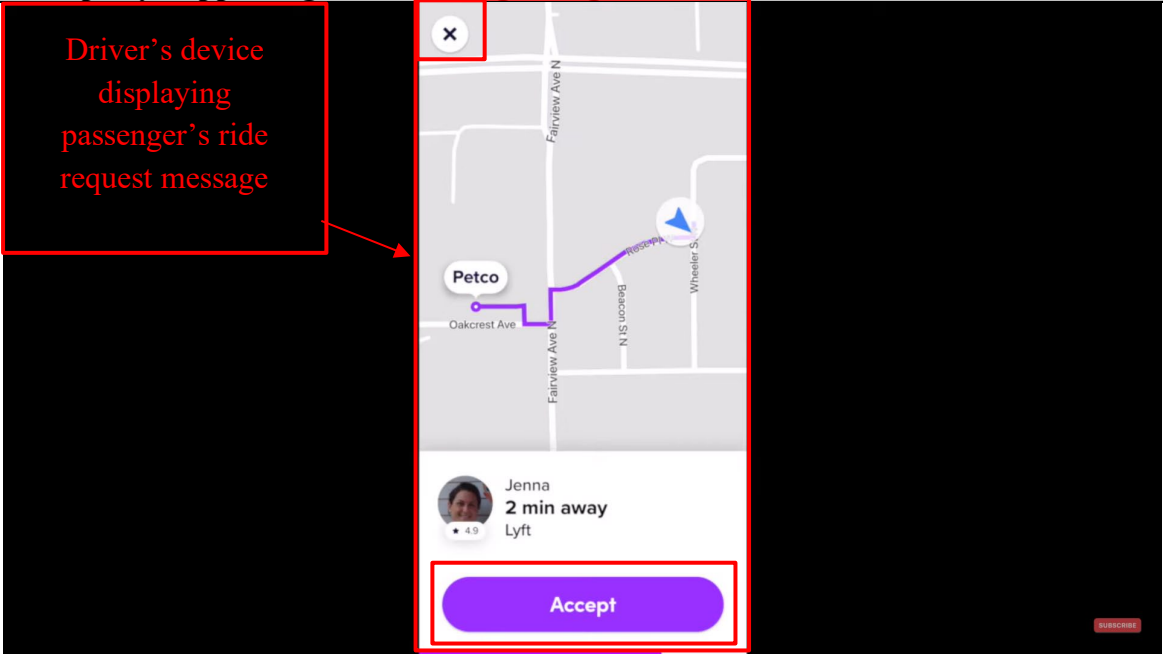
Exhibit E for US Patent No. 7,031,728 Against Lyft Accused Products

Claim – 7,031,728	Exemplary Supporting Evidence Regarding Accused Products
	<p data-bbox="583 240 1808 397">Combining multiple components into a single chip saves on space, cost, and power consumption. Essentially, an SoC is the brain of your smartphone that handles everything from the Android operating system to detecting when you press the power off button. SoCs connect to other components too, such as cameras, a display, RAM, flash storage, and much more.</p> <p data-bbox="583 443 1787 516">The list below contains the most common components that you will find inside a smartphone System-on-a-Chip. We're going to cover a few of the most important ones later on in this article.</p> <ul data-bbox="642 540 1782 1141" style="list-style-type: none">· Central Processing Unit (CPU) — The “brains” of the SoC. Runs most of the code for the Android OS and most of your apps.· Graphics Processing Unit (GPU) — Handles graphics-related tasks, such as visualizing an app’s user interface and 2D/3D gaming.· Image Processing Unit (ISP) — Converts data from the phone’s camera into image and video files.· Digital Signal Processor (DSP) — Handles more mathematically intensive functions than a CPU. Includes decompressing music files and analyzing gyroscope sensor data.· Neural Processing Unit (NPU) — Used in high-end smartphones to accelerate machine learning (AI) tasks. These include voice recognition and camera processing.· Video encoder/decoder — Handles the power-efficient conversion of video files and formats.· Modems — Converts wireless signals into data your phone understands. Components include 4G LTE, 5G, WiFi, and Bluetooth modems. <p data-bbox="569 1149 1745 1182">https://www.androidauthority.com/what-is-an-soc-smartphone-chipsets-explained-1051600/</p>

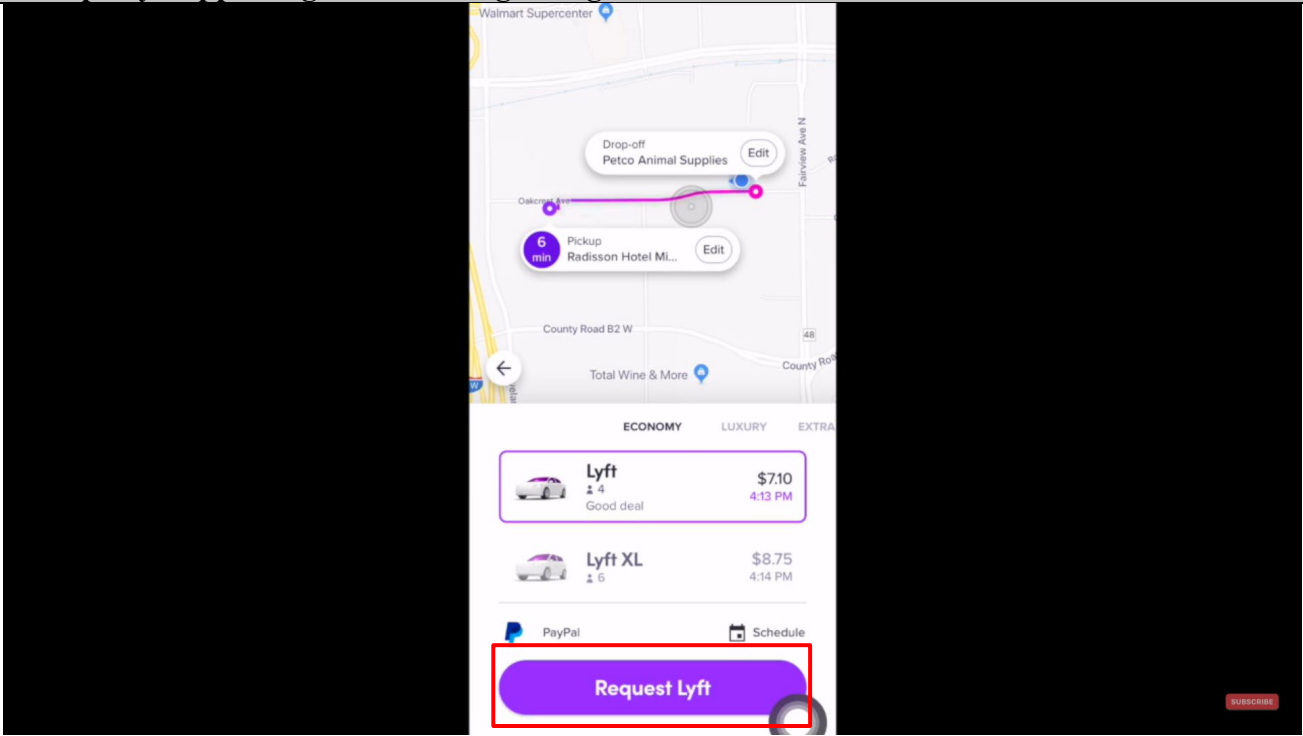
Exhibit E for US Patent No. 7,031,728 Against Lyft Accused Products

Claim – 7,031,728	Exemplary Supporting Evidence Regarding Accused Products
	<p data-bbox="577 235 1738 414">You must have seen that every Android and iOS device in today's age comes with GPS right inside it. This is one feature that will be there in every smartphone no matter what the price of that device might be. And that is because of the fact that GPS is the most basic yet most useful feature on every smartphone.</p> <p data-bbox="577 462 1766 730">Just for information, the GPS stands for Global Positioning System and it provides accurate geolocation and time information for every equipment that is equipped with a GPS receiver. Now, the best example of using GPS is with services such as Google Maps, Apple Maps, and others where you can see where exactly you are right now on the Map. This is thanks to the GPS receiver which sends a signal to the GPS satellite.</p> <p data-bbox="577 738 1520 776">https://www.cashify.in/how-to-turn-off-gps-on-any-android-or-ios-device</p>

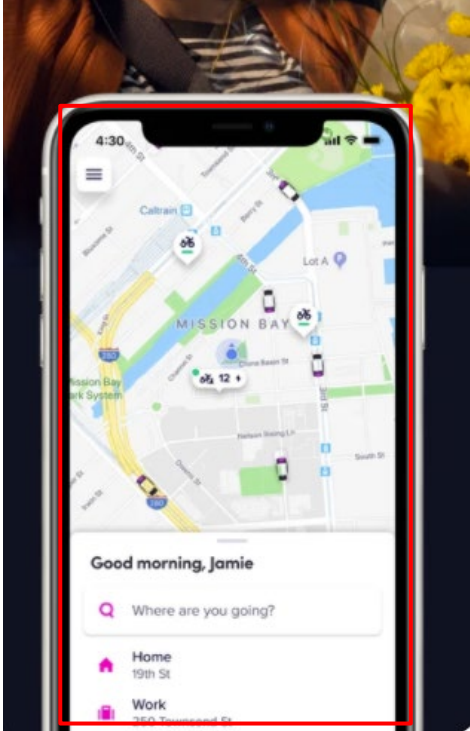
Exhibit E for US Patent No. 7,031,728 Against Lyft Accused Products









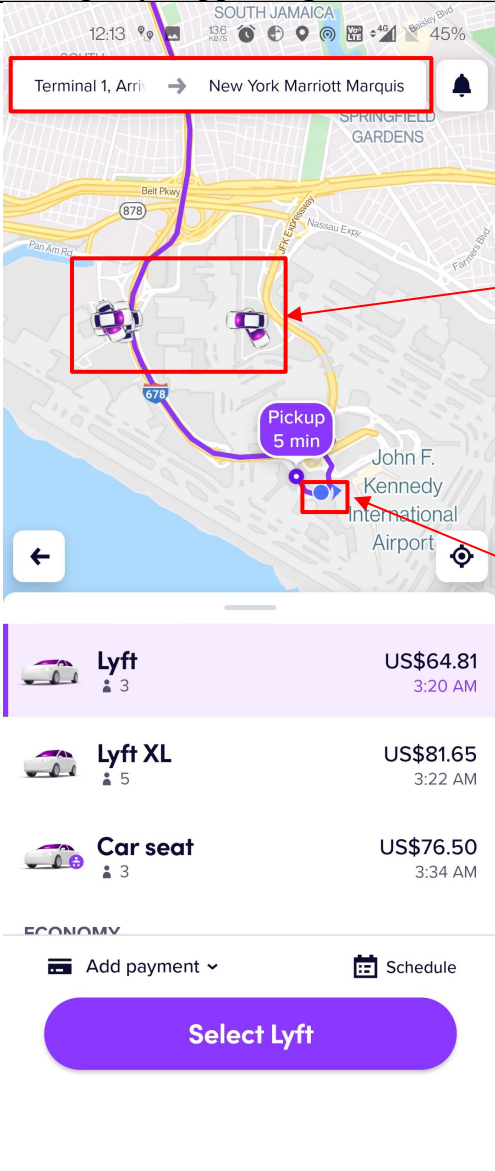

Claim – 7,031,728	Exemplary Supporting Evidence Regarding Accused Products						
	 <p data-bbox="569 228 1060 341">Terminal 1, Arrivals → New York Marriott Marquis</p> <p data-bbox="1228 349 1428 552">Nearby Drivers' location</p> <p data-bbox="1207 673 1438 868">Passenger's location</p> <table border="1" data-bbox="569 852 1060 1136"><tr><td> Lyft</td><td>US\$64.81</td></tr><tr><td> Lyft XL</td><td>US\$81.65</td></tr><tr><td> Car seat</td><td>US\$76.50</td></tr></table> <p data-bbox="569 1144 1060 1201">ECONOMY Add payment Schedule</p> <p data-bbox="609 1218 1018 1291">Select Lyft</p>	 Lyft	US\$64.81	 Lyft XL	US\$81.65	 Car seat	US\$76.50
 Lyft	US\$64.81						
 Lyft XL	US\$81.65						
 Car seat	US\$76.50						

Exhibit E for US Patent No. 7,031,728 Against Lyft Accused Products

Claim – 7,031,728	Exemplary Supporting Evidence Regarding Accused Products
	 <p>Driver's device displaying passenger's ride request message</p> <p>Passenger's location when pickup location is set to current location</p> <p>Driver's location</p> <p>https://www.youtube.com/watch?v=jVUy9poJDng at 10:24, Annotated</p>

Exhibit E for US Patent No. 7,031,728 Against Lyft Accused Products

Claim – 7,031,728	Exemplary Supporting Evidence Regarding Accused Products
	 <p>The screenshot shows the Lyft app interface. At the top, the destination is set to "Petco". A map displays a blue route starting from a pickup location and ending at Petco. The pickup location is labeled "1 min • 0.3 mi Pick up Jenna". A red box highlights this pickup information and a circular icon with a telephone handset, which is used for calling the driver. The map shows streets including Oakcrest Ave, Fairview Ave N, Beacon St N, and Reservoir W. A "Navigate" button is visible at the bottom right of the map area.</p> <p>https://www.youtube.com/watch?v=jVUy9poJDng at 10:46</p>

Exhibit E for US Patent No. 7,031,728 Against Lyft Accused Products

Claim – 7,031,728	Exemplary Supporting Evidence Regarding Accused Products
	 <p>The screenshot shows a mobile interface for contacting a driver named Jenna. A red rectangular box highlights a list of text messages that can be sent to the driver. The messages are: "I'm your driver, Joe", "Hi, where are you?", "Be there in 1 min", "Stuck in traffic", "Can't take a call now, sorry", "I'm in a black Kia Optima Hybrid", and "Gate code, please?". Below the list is a purple circular button with a white telephone handset icon, also highlighted with a red box. A "SUBSCRIBE" button is visible in the bottom right corner of the screenshot.</p> <p>https://www.youtube.com/watch?v=jVUy9poJDng at 11:21</p>

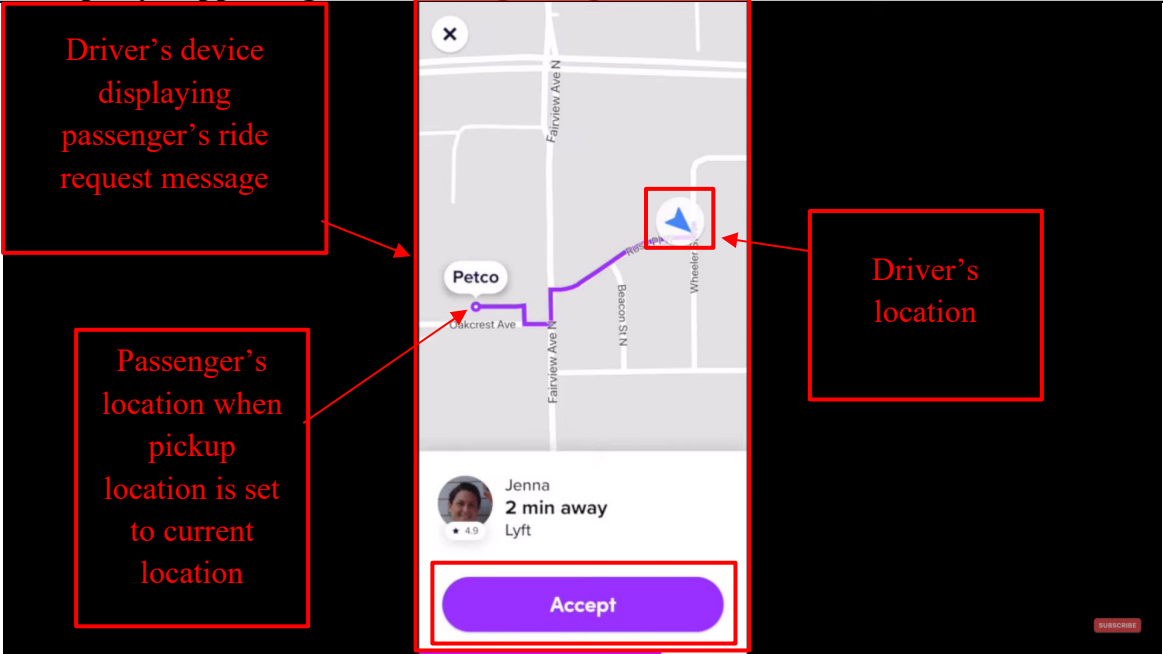
Exhibit E for US Patent No. 7,031,728 Against Lyft Accused Products

Claim – 7,031,728	Exemplary Supporting Evidence Regarding Accused Products
	 <p>https://www.youtube.com/watch?v=j0RDMLcmOgU at 5:07</p>

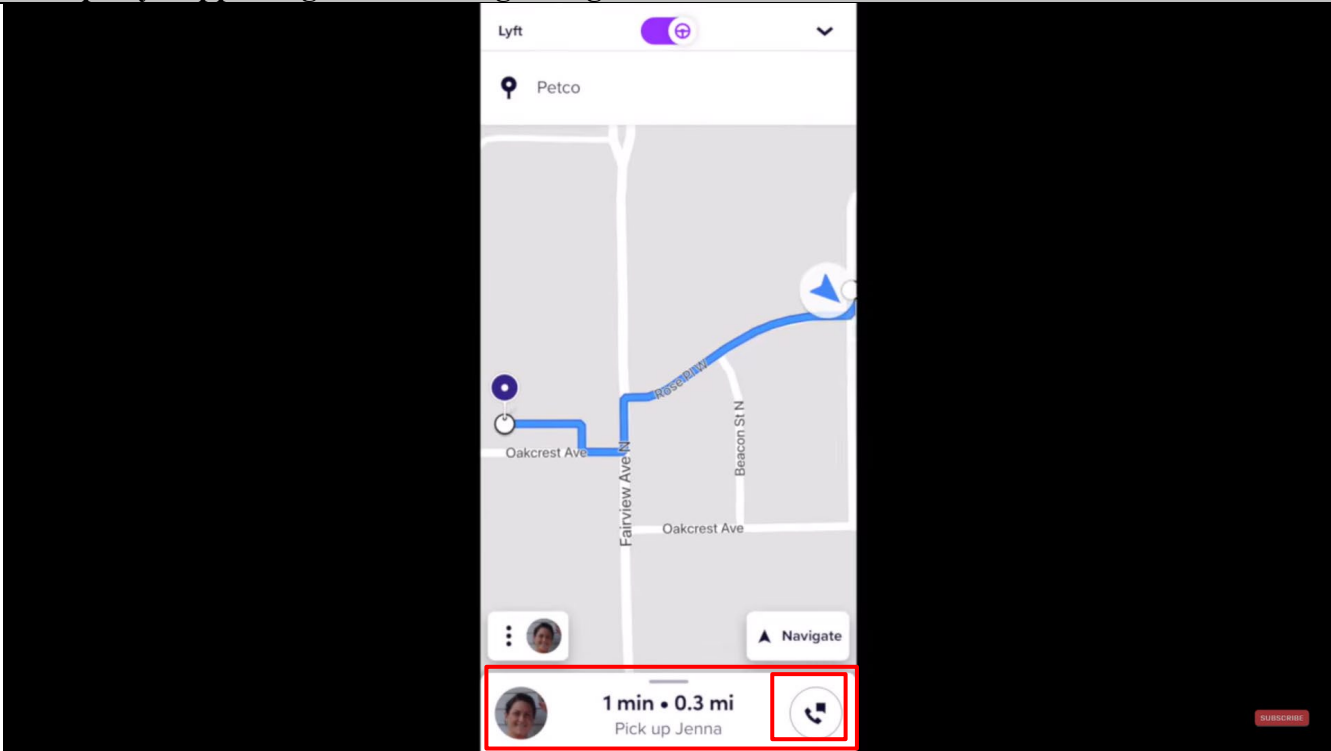
Exhibit E for US Patent No. 7,031,728 Against Lyft Accused Products

Claim – 7,031,728	Exemplary Supporting Evidence Regarding Accused Products
	 <p>https://www.youtube.com/watch?v=j0RDMLcmOgU at 5:32</p> <p>Further, to the extent this element is performed at least in part by Lyft's software source code, AGIS reserves the right to supplement these contentions pursuant to production of such source code by Lyft and to the extent Defendant requires additional information in accordance with P.R. 3-1 and for any other reasons.</p>
7[A] a) generating one or more symbols on the touch display screen, each representing a different participant that has a cellular phone that	<p>See Claim 7P above. The Lyft Accused Products practice generating one or more symbols on the touch display screen, each representing a different participant that has a cellular phone that includes said voice communication, free and operator selected text messages, photograph and video, a CPU, said GPS system and a touch screen display.</p> <p>This element is infringed literally, or in the alternative, under the doctrine of equivalents.</p>

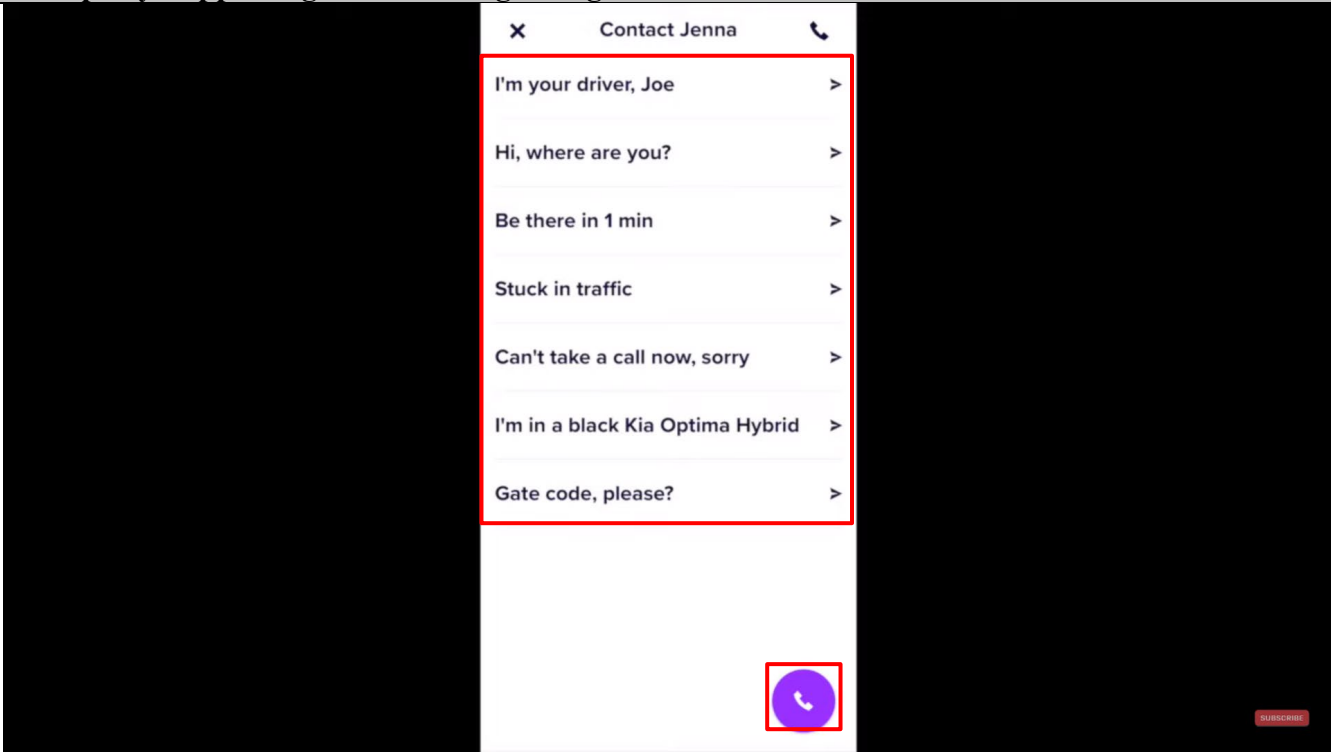
Exhibit E for US Patent No. 7,031,728 Against Lyft Accused Products

Claim – 7,031,728	Exemplary Supporting Evidence Regarding Accused Products
<p>includes said voice communication, free and operator selected text messages, photograph and video, a CPU, said GPS system and a touch screen display;</p>	<p>For example, drivers' and passengers' mobile phones with the Lyft Driver and the Lyft app installed generates symbols including but not limited to blue dot denoting passenger's location, blue navigate icon denoting driver's location, and vehicle icons denoting nearby driver's location on the display of the mobile phones.</p> <h3 data-bbox="583 461 1073 537">Lyft Driver app</h3> <div data-bbox="577 573 1814 657" style="border: 1px solid red; padding: 5px;"><p>We've separated the passenger and driver experiences into two separate mobile apps — one exclusively for passengers (named the Lyft app) and the other exclusively for drivers (named the Lyft Driver app).</p></div> <p>The Lyft Driver app will eventually be standard for all drivers and required for driving. At this time, drivers can keep using the Lyft app to give rides. Don't worry! While we have some planned improvements to the Lyft Driver app, we've kept its features the same.</p> <p>https://help.lyft.com/hc/en-ca/articles/115013079208-Lyft-Driver-app</p> <h3 data-bbox="583 894 884 938">What is Lyft?</h3> <p>Lyft is a platform that connects drivers with individuals and organizations that need rides.</p> <p>https://www.lyft.com/drive-with-lyft</p>

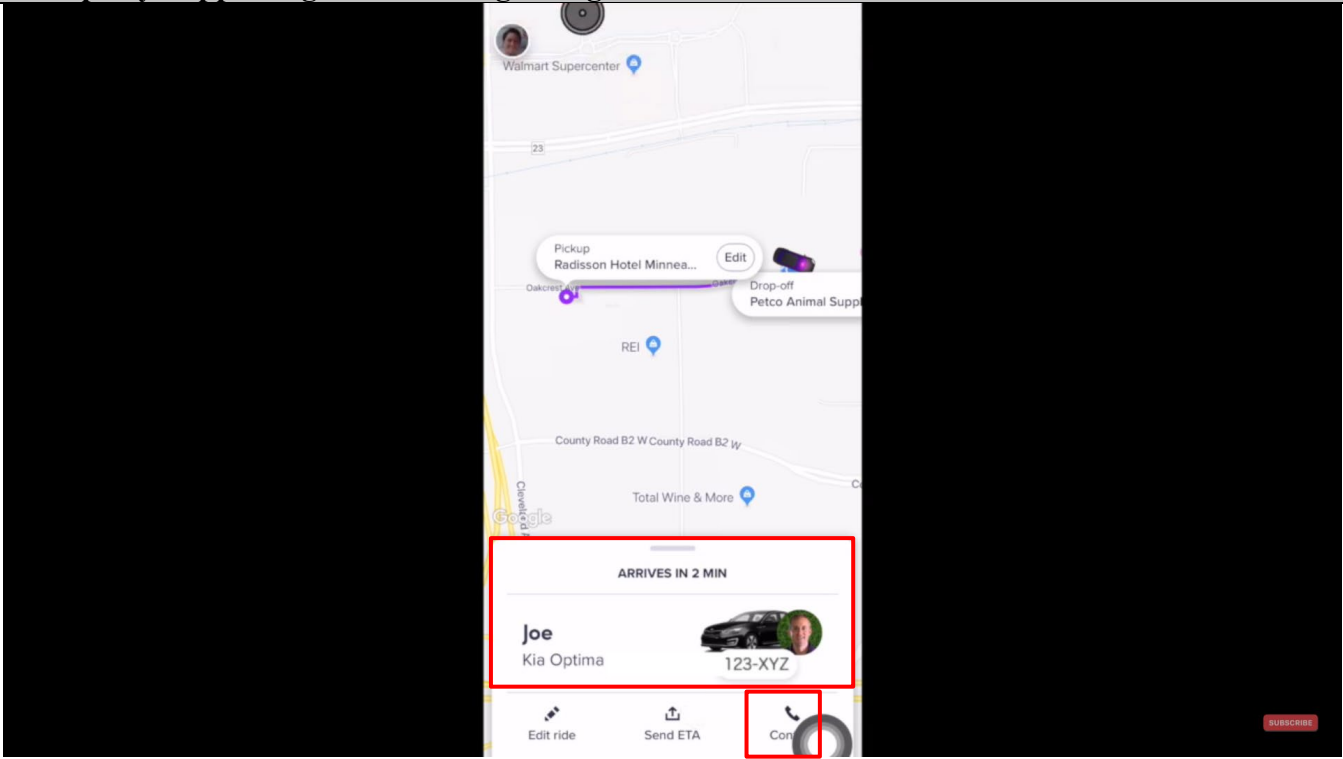
Exhibit E for US Patent No. 7,031,728 Against Lyft Accused Products

Claim – 7,031,728	Exemplary Supporting Evidence Regarding Accused Products
	 <p data-bbox="577 625 703 657">Go online</p> <p data-bbox="577 690 1774 836">Open your Lyft Driver app and tap the steering wheel icon. Lyft will now find the closest passenger to your location requesting a ride. Turn on some music and get comfortable: that first ride request may come quickly or may take a while, depending on the number of current passenger requests. <a data-bbox="577 803 1228 836" href="https://www.lyft.com/hub/posts/how-to-give-a-ride">https://www.lyft.com/hub/posts/how-to-give-a-ride</p>

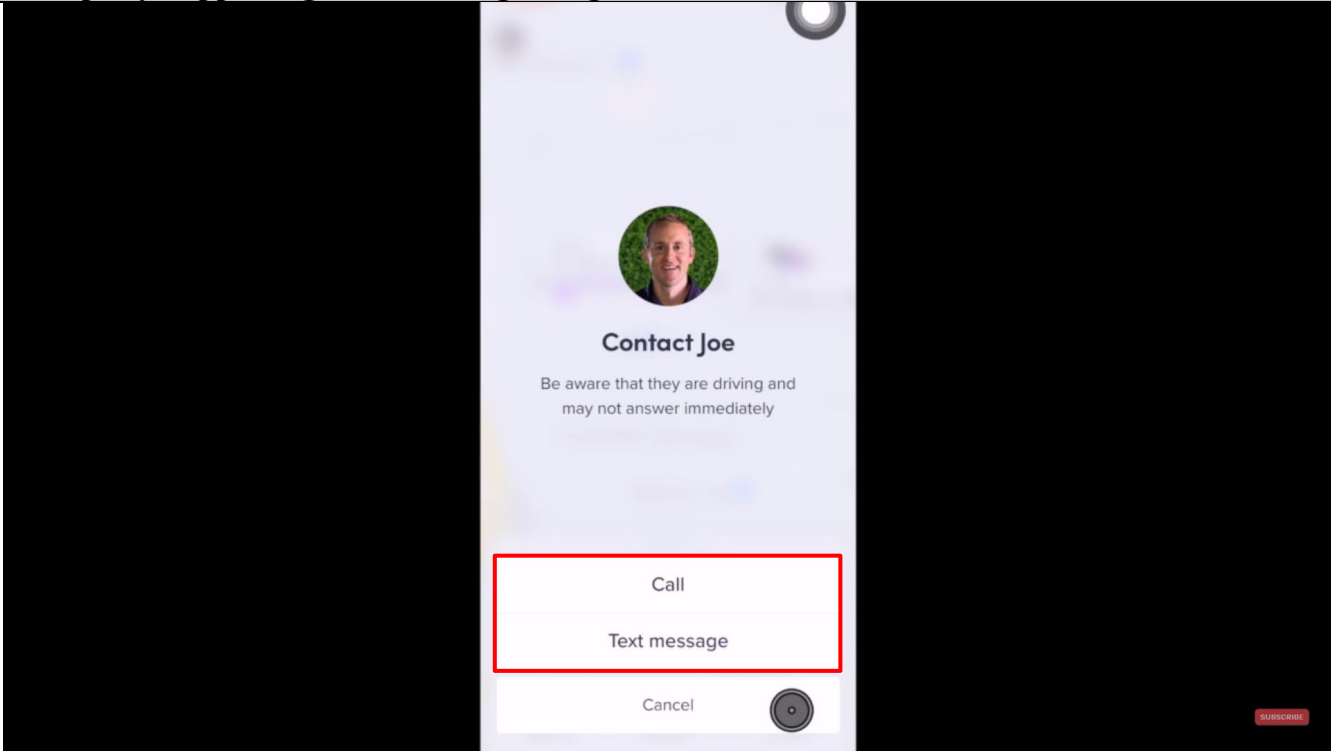
Exhibit E for US Patent No. 7,031,728 Against Lyft Accused Products

Claim – 7,031,728	Exemplary Supporting Evidence Regarding Accused Products
	 <p>https://apps.apple.com/in/app/lyft/id529379082</p>

Exhibit E for US Patent No. 7,031,728 Against Lyft Accused Products

Claim – 7,031,728	Exemplary Supporting Evidence Regarding Accused Products
	 <p>The screenshot displays the Lyft app interface during a ride request. At the top, the route is set from 'Terminal 1, Arrivals' to 'New York Marriott Marquis'. The map shows the passenger's location at John F. Kennedy International Airport, with a 'Pickup 5 min' indicator. Two nearby drivers are shown on the map, with red boxes highlighting their locations and arrows pointing to a text box labeled 'Nearby Drivers' location'. Another red box highlights the passenger's location at the airport, with an arrow pointing to a text box labeled 'Passenger's location'. Below the map, three ride options are listed: 'Lyft' (US\$64.81, 3:20 AM), 'Lyft XL' (US\$81.65, 3:22 AM), and 'Car seat' (US\$76.50, 3:34 AM). At the bottom, there is a 'Select Lyft' button.</p>

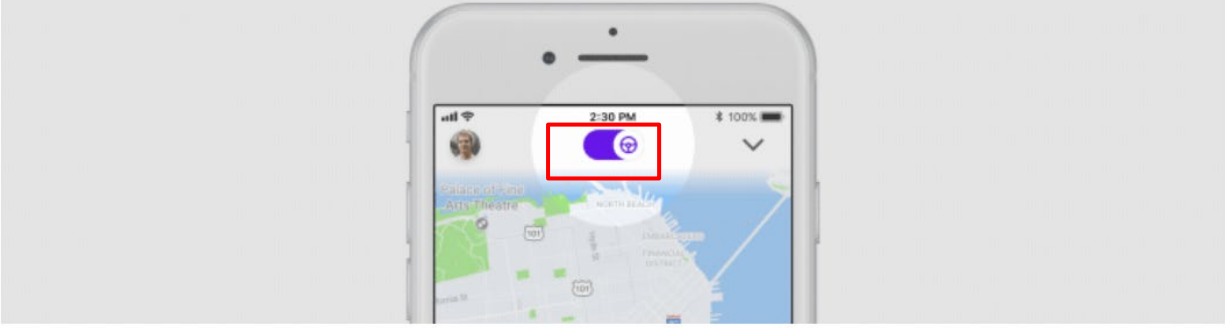
Exhibit E for US Patent No. 7,031,728 Against Lyft Accused Products

Claim – 7,031,728	Exemplary Supporting Evidence Regarding Accused Products
	<div style="text-align: center;"> </div> <p>https://www.youtube.com/watch?v=jVUy9poJDng at 10:24, Annotated</p> <p>Further, to the extent this element is performed at least in part by Lyft's software source code, AGIS reserves the right to supplement these contentions pursuant to production of such source code by Lyft and to the extent Defendant requires additional information in accordance with P.R. 3-1 and for any other reasons.</p>
7[B]. b) providing and storing in each of the participant cellular phones one or more cellular phone telephone numbers, each cellular phone number of which relates to a different symbol of each of the participants in the communication network.	<p>The Lyft Accused Products practice providing and storing in each of the participant cellular phones one or more cellular phone telephone numbers, each cellular phone number of which relates to a different symbol of each of the participants in the communication network.</p> <p>This element is infringed literally, or in the alternative, under the doctrine of equivalents.</p> <p>For example, Lyft collects the phone number of each driver and passenger when they join the Lyft network. Lyft stores and provides the phones numbers in the Lyft apps and/or the Lyft server(s).</p>

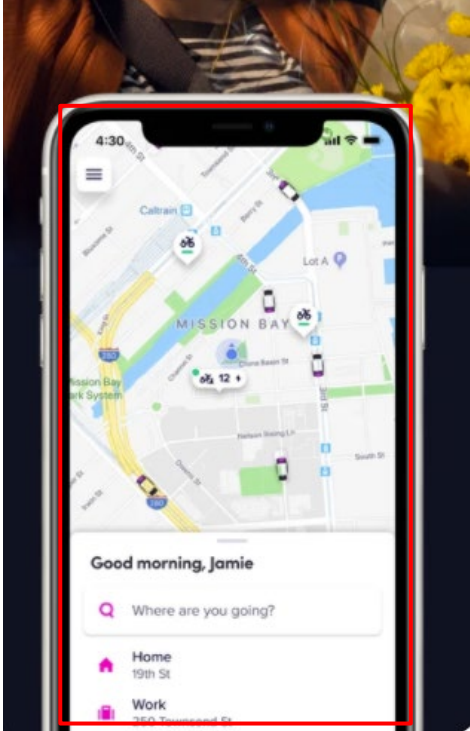
Exhibit E for US Patent No. 7,031,728 Against Lyft Accused Products

Claim – 7,031,728	Exemplary Supporting Evidence Regarding Accused Products
participants in the communication network;	<p>Respective phone numbers for each driver/rider is associated with the corresponding rider/driver and their symbols.</p> <h3>How to start an application</h3> <p>Create a Lyft account through the app or on the web at lyft.com/drivers.</p> <p>Enter your name, phone number, and email address, then submit all the info we need to ensure you meet the requirements. If you sign out of your account, any application info you've submitted will be saved.</p> <p>If you have a promo code, enter it when creating an account. If you apply through a link on a website, the code will be added automatically.</p> <p>Back to top</p> <p>https://help.lyft.com/hc/e/articles/115013081188</p>

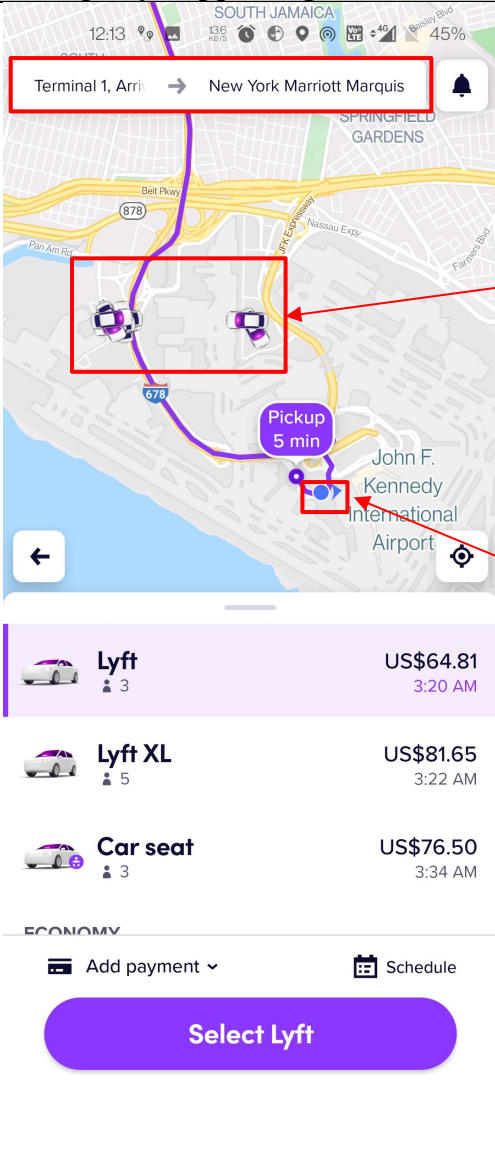
Exhibit E for US Patent No. 7,031,728 Against Lyft Accused Products

Claim – 7,031,728	Exemplary Supporting Evidence Regarding Accused Products
	<p data-bbox="583 237 1192 261">Before you begin, be sure you have the following:</p> <ul data-bbox="653 302 961 431" style="list-style-type: none"><li data-bbox="653 302 961 334">• Your phone number<li data-bbox="653 354 926 378">• Your email address<li data-bbox="653 402 926 431">• A photo of yourself <p data-bbox="583 488 722 513">Get started</p> <ol data-bbox="653 553 1906 862" style="list-style-type: none"><li data-bbox="653 553 1136 578">1. Type in your device's phone number<li data-bbox="653 602 1906 667">2. To verify your identity, we'll send a verification code via text to your phone number. We want to make sure you're human!<li data-bbox="653 691 1801 716">3. The text message should arrive immediately. If you don't see it after a bit, tap 'Resend code.'<li data-bbox="653 740 1755 764">4. Type in your name, email address, and take a selfie so your driver knows who to pick up<li data-bbox="653 789 1906 862">5. That's it! Once you've set up your account, you'll be able to request a ride (Learn How to request a ride). <p data-bbox="583 886 1591 911">https://help.lyft.com/hc/e/articles/115012926947-How-to-create-a-Lyft-account</p>

Exhibit E for US Patent No. 7,031,728 Against Lyft Accused Products

Claim – 7,031,728	Exemplary Supporting Evidence Regarding Accused Products												
	 <p>The screenshot displays the Lyft app interface. At the top, the destination is set to 'New York Marriott Marquis'. The map shows the area around JFK Airport, with a red box highlighting two nearby driver icons. A red arrow points from a text box labeled 'Nearby Drivers' location' to these icons. Another red box highlights the passenger's location at JFK, with a red arrow pointing from a text box labeled 'Passenger's location' to it. Below the map, three ride options are listed: 'Lyft' (US\$64.81, 3:20 AM), 'Lyft XL' (US\$81.65, 3:22 AM), and 'Car seat' (US\$76.50, 3:34 AM). A large purple button at the bottom says 'Select Lyft'.</p> <table border="1" data-bbox="569 844 1060 1104"><thead><tr><th>Service</th><th>Price</th><th>ETA</th></tr></thead><tbody><tr><td>Lyft</td><td>US\$64.81</td><td>3:20 AM</td></tr><tr><td>Lyft XL</td><td>US\$81.65</td><td>3:22 AM</td></tr><tr><td>Car seat</td><td>US\$76.50</td><td>3:34 AM</td></tr></tbody></table>	Service	Price	ETA	Lyft	US\$64.81	3:20 AM	Lyft XL	US\$81.65	3:22 AM	Car seat	US\$76.50	3:34 AM
Service	Price	ETA											
Lyft	US\$64.81	3:20 AM											
Lyft XL	US\$81.65	3:22 AM											
Car seat	US\$76.50	3:34 AM											

Exhibit E for US Patent No. 7,031,728 Against Lyft Accused Products

Claim – 7,031,728	Exemplary Supporting Evidence Regarding Accused Products
	 <p>https://www.youtube.com/watch?v=jVUy9poJDng at 10:24, Annotated</p> <p>Further, to the extent this element is performed at least in part by Lyft's software source code, AGIS reserves the right to supplement these contentions pursuant to production of such source code by Lyft and to the extent Defendant requires additional information in accordance with P.R. 3-1 and for any other reasons.</p>
<p>7[C]. c) providing initiating cellular phone calling software in each cellular phone that is activated by touching a symbol on the touch display that automatically initiates a cellular phone call using the stored</p>	<p>The Lyft Accused Products practice providing initiating cellular phone calling software in each cellular phone that is activated by touching a symbol on the touch display that automatically initiates a cellular phone call using the stored cellular phone number to the participant represented by the symbol.</p> <p>This element is infringed literally, or in the alternative, under the doctrine of equivalents.</p> <p>For example, the Lyft app provides selectable interface elements within the Lyft app to call the rider/driver represented by a symbol. For example, when the driver is matched to the passenger, both</p>

Exhibit E for US Patent No. 7,031,728 Against Lyft Accused Products

Claim – 7,031,728	Exemplary Supporting Evidence Regarding Accused Products
<p>cellular phone number to the participant represented by the symbol; and</p>	<p>the driver and the passenger receive the call icon on their respective Lyft apps through which both the driver and the passenger are given the functionality to call each other from within the apps.</p>  <p>https://www.youtube.com/watch?v=j0RDMLcmOgU at 5:07</p>

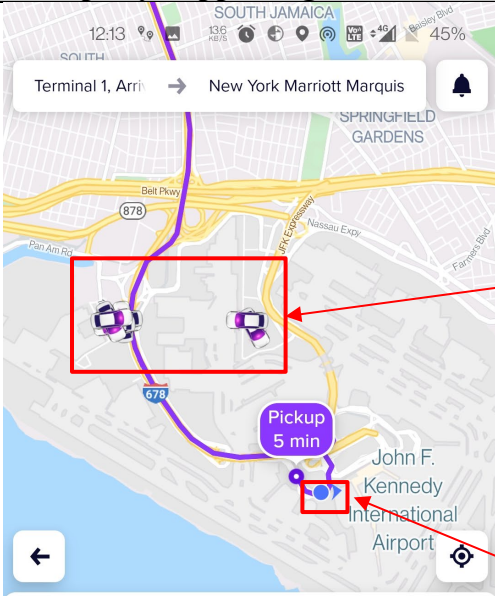
Exhibit E for US Patent No. 7,031,728 Against Lyft Accused Products

Claim – 7,031,728	Exemplary Supporting Evidence Regarding Accused Products
	 <p>The screenshot shows the Lyft app interface. At the top, it says 'Lyft' with a location pin icon and the text 'Petco'. Below this is a map showing a blue route starting from a location marked with a blue dot and ending at a location marked with a blue circle. The route passes through 'Oakcrest Ave', 'Fairview Ave N', and 'Beacon St N'. At the bottom of the screen, there is a card for a driver named 'Jenna' with a profile picture, a '1 min • 0.3 mi' estimate, and the text 'Pick up Jenna'. A red box highlights the call button icon on the right side of this card.</p> <p>https://www.youtube.com/watch?v=jVUy9poJDng at 10:46</p> <p>Further, to the extent this element is performed at least in part by Lyft's software source code, AGIS reserves the right to supplement these contentions pursuant to production of such source code by Lyft and to the extent Defendant requires additional information in accordance with P.R. 3-1 and for any other reasons.</p>
<p>7[D]. d) generating a geographical location chart on said display screen to show the geographical location of each of the symbols</p>	<p>The Lyft Accused Products practice generating a geographical location chart on said display screen to show the geographical location of each of the symbols representing the participants in the communication network by latitude and longitude.</p> <p>This element is infringed literally, or in the alternative, under the doctrine of equivalents.</p>

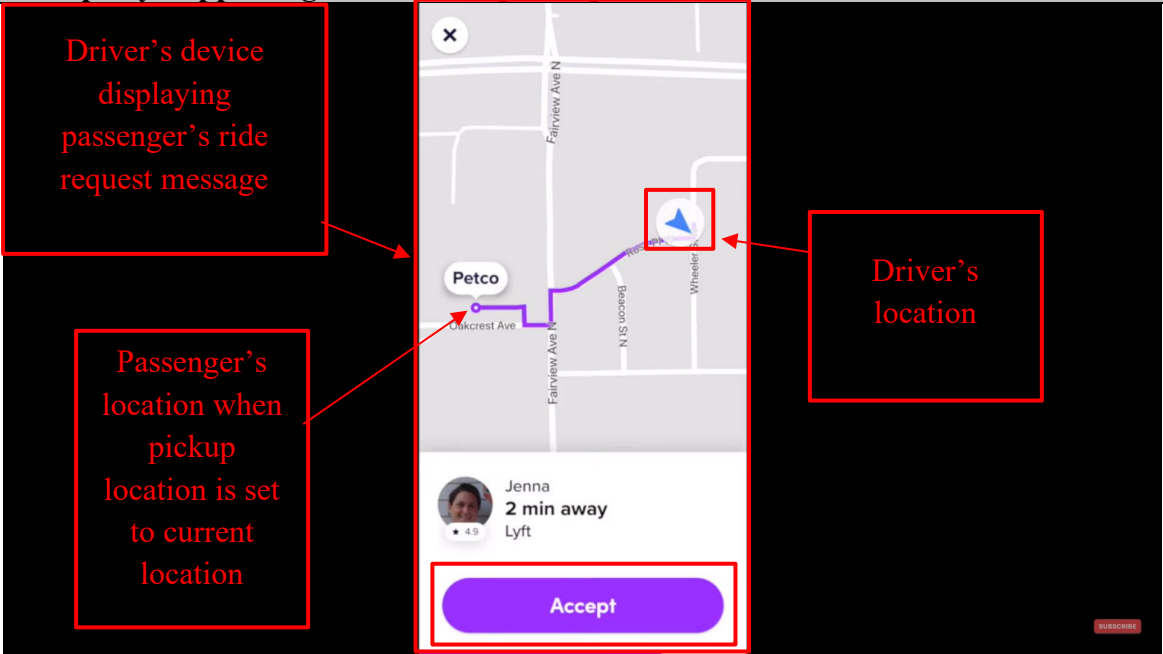
Exhibit E for US Patent No. 7,031,728 Against Lyft Accused Products

Claim – 7,031,728	Exemplary Supporting Evidence Regarding Accused Products
representing the participants in the communication network by latitude and longitude.	Lyft meets this limitation because it generates a display with a geographical map presenting symbols representing drivers/riders in the Lyft platform/network. On information and belief, the symbols are presented in the geographical map based on their respective latitude and longitude. For example, drivers' and passengers' mobile phones with the Lyft Driver and the Lyft app installed generates symbols for riders/drivers. The maps in Lyft and Lyft Driver app also highlight the facility symbols such as a park, airport, and shops. The map in the Lyft app shows the location of the pickup address and the destination address when the passenger requests the ride.

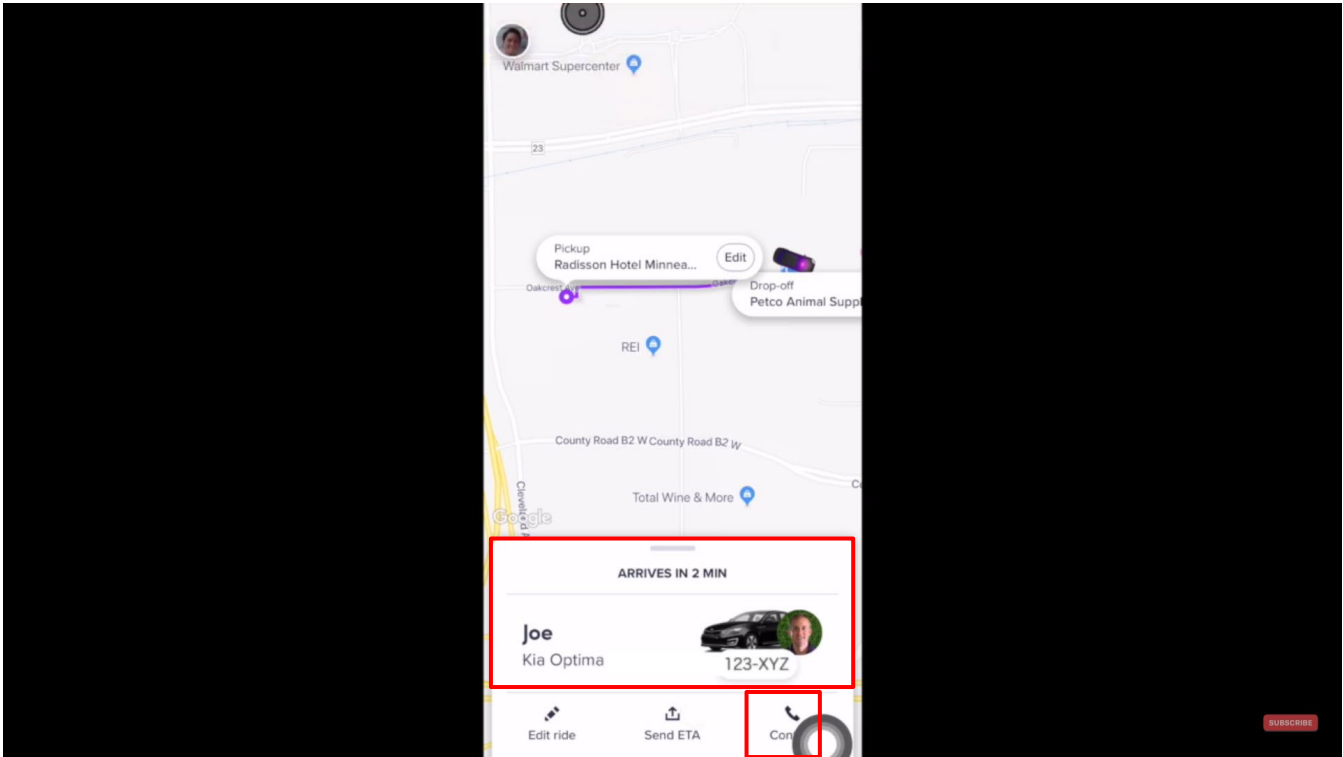
Exhibit E for US Patent No. 7,031,728 Against Lyft Accused Products

Claim – 7,031,728	Exemplary Supporting Evidence Regarding Accused Products												
	 <p>The screenshot shows the Lyft app interface. At the top, the route is from 'Terminal 1, Arrivals' to 'New York Marriott Marquis'. The map displays the JFK Airport area with a pickup location marked 'Pickup 5 min' near John F. Kennedy International Airport. Two red boxes with arrows point to specific locations on the map: one box labeled 'Nearby Drivers' location' points to two car icons, and another box labeled 'Passenger's location' points to a blue location pin. Below the map, three ride options are listed:</p> <table border="1"><thead><tr><th>Vehicle Type</th><th>Price</th><th>Time</th></tr></thead><tbody><tr><td>Lyft (3 seats)</td><td>US\$64.81</td><td>3:20 AM</td></tr><tr><td>Lyft XL (5 seats)</td><td>US\$81.65</td><td>3:22 AM</td></tr><tr><td>Car seat (3 seats)</td><td>US\$76.50</td><td>3:34 AM</td></tr></tbody></table> <p>At the bottom, there are options to 'Add payment' and 'Schedule', and a large purple button labeled 'Select Lyft'.</p>	Vehicle Type	Price	Time	Lyft (3 seats)	US\$64.81	3:20 AM	Lyft XL (5 seats)	US\$81.65	3:22 AM	Car seat (3 seats)	US\$76.50	3:34 AM
Vehicle Type	Price	Time											
Lyft (3 seats)	US\$64.81	3:20 AM											
Lyft XL (5 seats)	US\$81.65	3:22 AM											
Car seat (3 seats)	US\$76.50	3:34 AM											

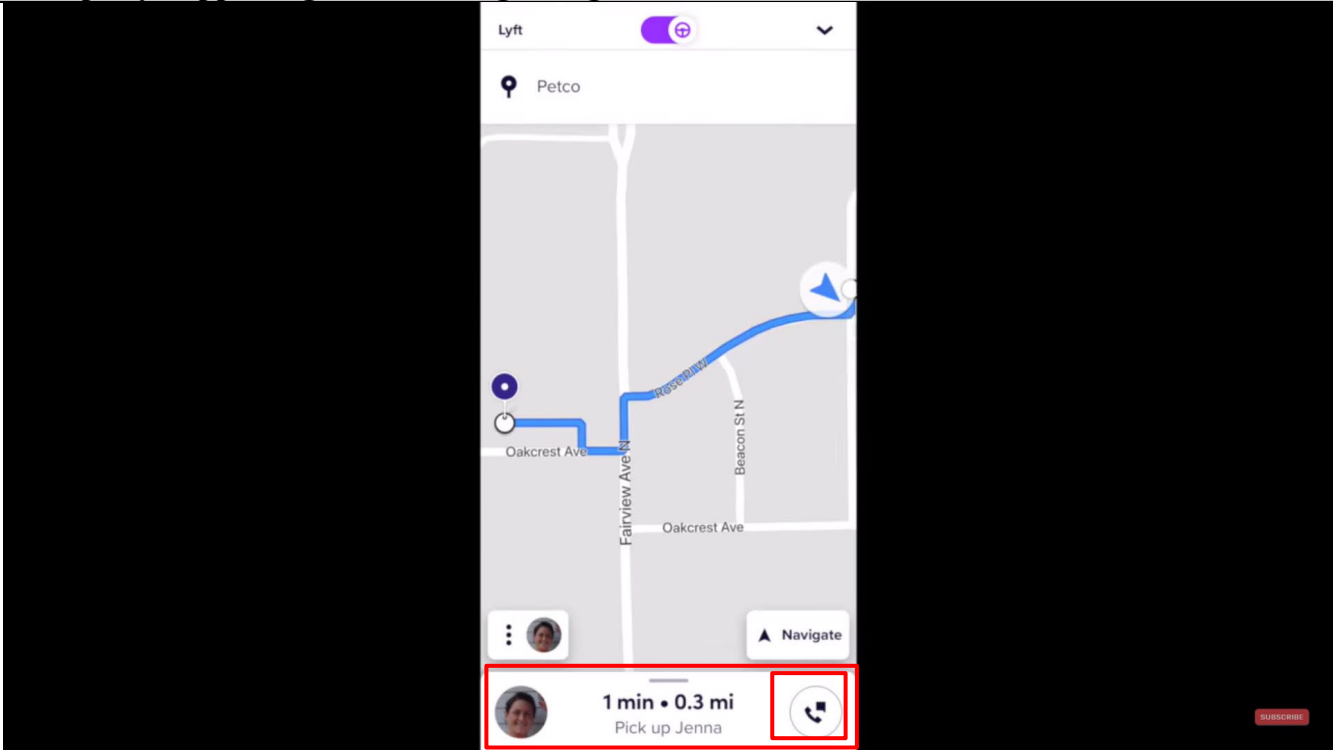
Exhibit E for US Patent No. 7,031,728 Against Lyft Accused Products

Claim – 7,031,728	Exemplary Supporting Evidence Regarding Accused Products
	 <p>Driver's device displaying passenger's ride request message</p> <p>Passenger's location when pickup location is set to current location</p> <p>Driver's location</p> <p>https://www.youtube.com/watch?v=jVUy9poJDng at 10:24, Annotated</p>

Exhibit E for US Patent No. 7,031,728 Against Lyft Accused Products

Claim – 7,031,728	Exemplary Supporting Evidence Regarding Accused Products
	 <p>The screenshot displays the Lyft app interface. At the top, a map of the New York City area is shown, with several locations highlighted in red boxes: Idlewild Park, North Woodmere Park, Inwood Country Club, and Kennedy International Airport. Below the map, the text "TGIF, sumit" is displayed. A search bar contains the text "Where are you going?". Below the search bar, a list of suggested destinations is shown, including "New York Marriott Marquis" (1535 Broadway, New York) and "Work". At the bottom of the screen, there are icons for search, bicycle, bus, and carpooling.</p>

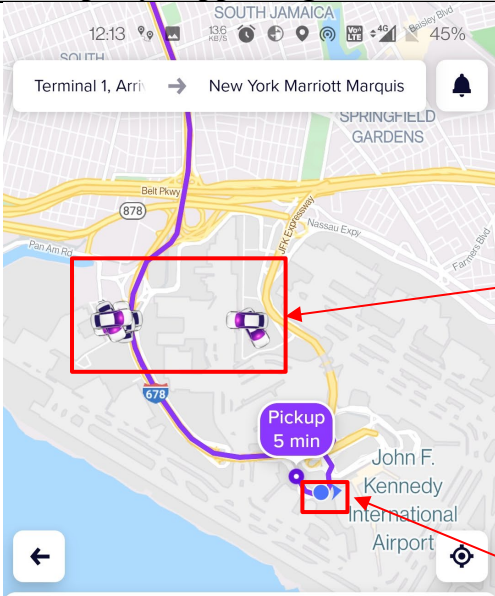
Exhibit E for US Patent No. 7,031,728 Against Lyft Accused Products

Claim – 7,031,728	Exemplary Supporting Evidence Regarding Accused Products
	 <p>https://www.youtube.com/watch?v=j0RDMLcmOgU at 4:01</p> <p>Further, to the extent this element is performed at least in part by Lyft's software source code, AGIS reserves the right to supplement these contentions pursuant to production of such source code by Lyft and to the extent Defendant requires additional information in accordance with P.R. 3-1 and for any other reasons.</p>

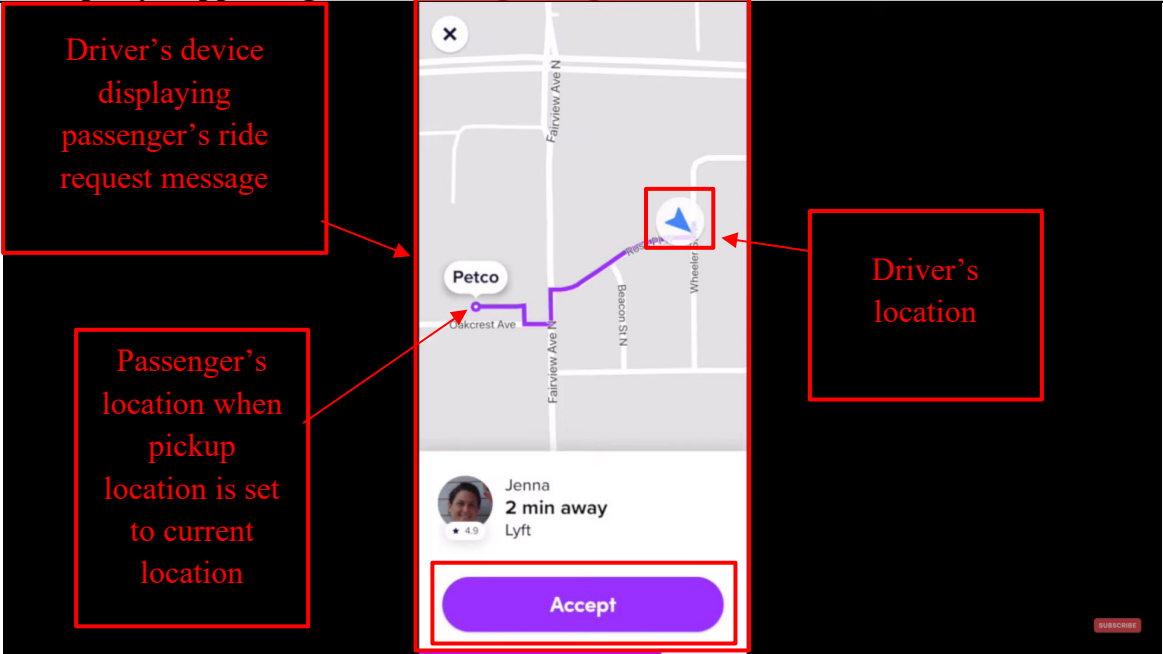
Exhibit G

RUSS AUGUST & KABAT

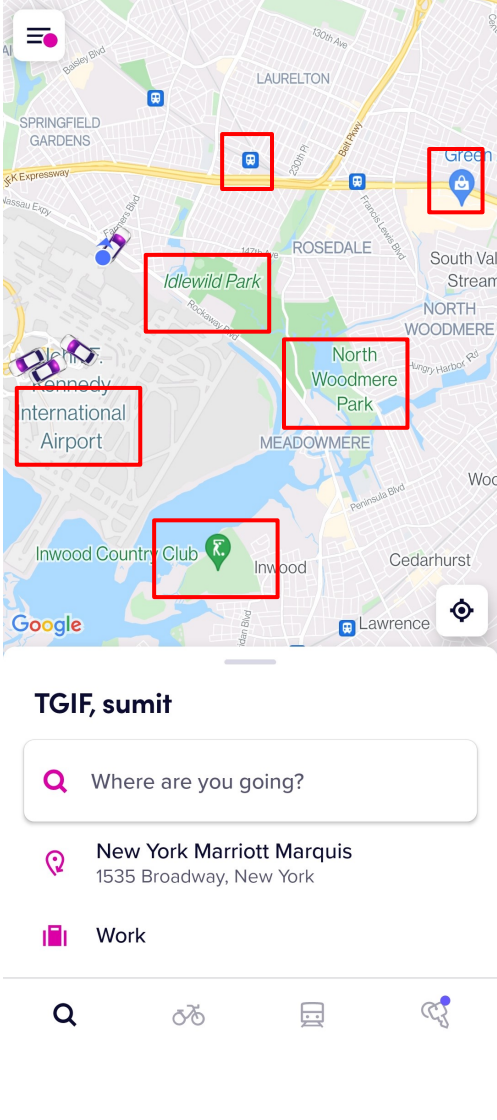
1 Alfred R. Fabricant
 2 afabricant@fabricantllp.com
 3 Peter Lambrianakos
 4 plambrianakos@fabricantllp.com
 5 Vincent J. Rubino, III
 6 vrubino@fabricantllp.com
 7 **FABRICANT LLP**
 8 411 Theodore Fremd Avenue, Suite 206 South
 9 Rye, New York 10580
 10 Telephone: (212) 257-5797
 11 Facsimile: (212) 257-5796

8 Benjamin T. Wang
 9 bwang@raklaw.com
 10 **RUSS AUGUST & KABAT**
 11 12424 Wilshire Boulevard, 12th Floor
 12 Los Angeles, California 90025
 13 Telephone: (310) 826-7474
 14 Facsimile: (310) 826-9226

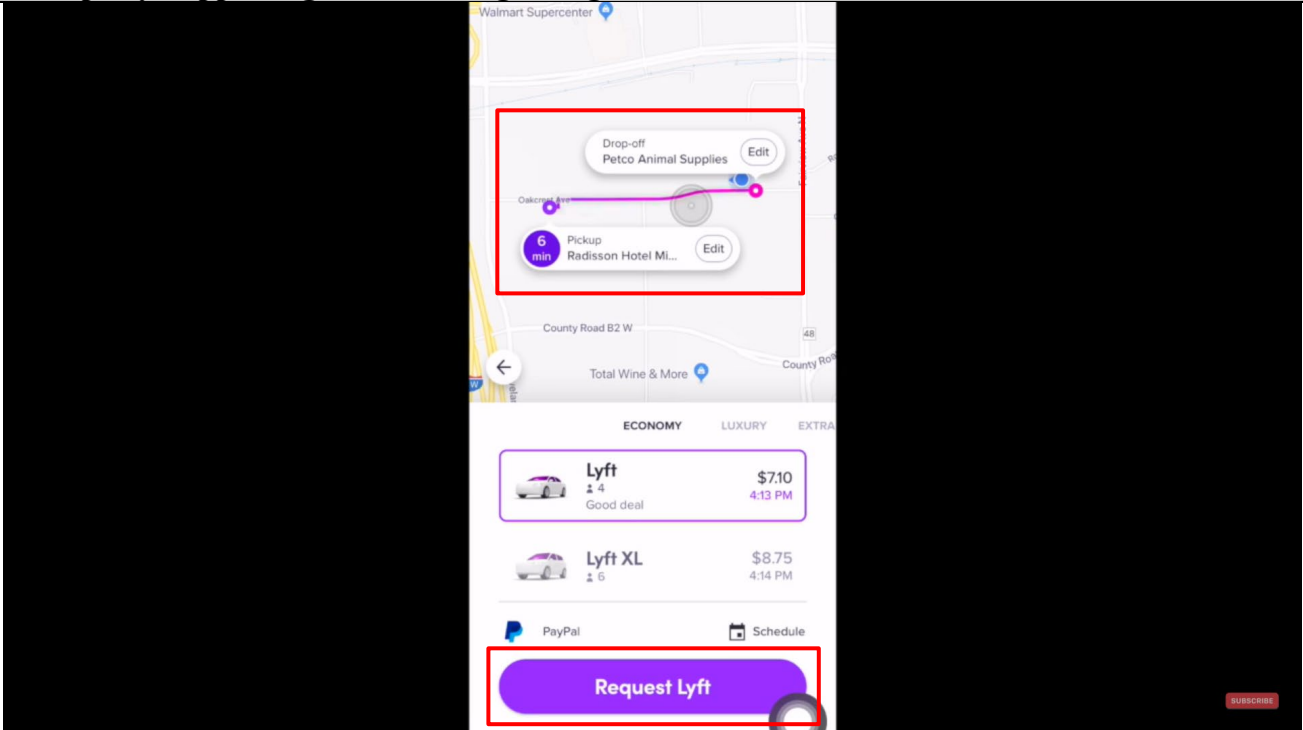
13 Attorneys for Defendant
 14 *AGIS Software Development LLC*

15 **UNITED STATES DISTRICT COURT**
 16 **NORTHERN DISTRICT OF CALIFORNIA**

18 LYFT, INC.,

19 *Plaintiffs,*

20 v.

21 AGIS SOFTWARE DEVELOPMENT LLC,

22 Defendant.

Case No. 5:21-cv-04653-BLF

**DEFENDANT AGIS SOFTWARE
 DEVELOPMENT LLC'S DISCLOSURE
 OF ASSERTED CLAIMS AND
 INFRINGEMENT CONTENTIONS**

Hon. Judge Beth Labson Freeman

1 Defendant AGIS Software Development LLC (“AGIS Software”) hereby makes the
 2 following infringement disclosure under the Patent Local Rules with respect to United States Patent
 3 Nos. 7,031,728; 7,630,724; 8,213,970; 10,299,100; and 10,341,838 (collectively, the “Patents-in-
 4 Suit”). AGIS Software’s investigation is ongoing, and discovery has not yet commenced.¹
 5 Accordingly, these disclosures are based on information available to AGIS Software at this time.
 6 AGIS Software reserves the right to supplement this disclosure after further discovery regarding the
 7 Lyft Accused Products set forth below. AGIS Software also reserves the right to assert additional
 8 claims of the Patents-in-Suit, accuse different products, or find literal and/or equivalent infringing
 9 elements in the Lyft Accused Products.

10 **I. DISCLOSURE OF ASSERTED CLAIMS AND INFRINGEMENT CONTENTIONS**
 11 **PURSUANT TO PATENT LOCAL RULE 3-1**

12 **A. ASSERTED CLAIMS**

13 Plaintiff Lyft Inc. (“Plaintiff” or “Lyft”) has infringed and continues to infringe at least the
 14 following claims of the Patents-in-Suit in connection with the Lyft Accused Products set forth
 15 below:

- 16 • Claim 7 of U.S. Patent No. 7,031,728 (the “’728 Patent”);
- 17 • Claims 9, 12-16 of U.S. Patent No. 7,630,724 (the “’724 Patent”);
- 18 • Claims 2, 10, 12-13 of U.S. Patent No. 8,213,970 (the “’970 Patent”);
- 19 • Claims 1-31 of U.S. Patent No. 10,299,100 (the “’100 Patent”); and
- 20 • Claims 1-26 of U.S. Patent No. 10,341,838 (the “’838 Patent”).

21 AGIS Software reserves the right to seek leave of court to add, delete, substitute, or
 22 otherwise amend this list of asserted claims should further discovery, the Court’s claim construction,
 23 or other circumstances so merit.

24 **B. ACCUSED INSTRUMENTALITIES**

25 AGIS Software is currently aware that the following Lyft Products infringe each of the
 26 Patents-in-Suit, either alone or in concert with one or more other Lyft Accused Products:

- 27 • Lyft applications, services, and servers;

28 ¹ There is no operative complaint in this action, and AGIS has not filed an answer.

RUSS AUGUST & KABAT

- Lyft Driver applications, services, and servers; and
- Lyft servers related to Lyft applications and Lyft Driver applications.

AGIS Software reserves the right to amend this list of accused instrumentalities, as well as other information contained in this document and the exhibits hereto, to incorporate new information learned during the course of discovery including, but not limited to, the inclusion of newly-released products or any other equivalent devices ascertained through discovery.

C. CLAIM CHARTS

Claim charts identifying a location of every element of every asserted claim of the Patents-in-Suit within Lyft Accused Products are attached hereto as Exhibits A-E. AGIS Software believes that the citations in the claim charts are representative of all Lyft Accused Products. For example, where AGIS Software cites reference material or images representing an application, service, or server that citation is representative for all other such applications, services, or servers including all prior and future versions unless otherwise noted. AGIS Software reserves the right to amend these claim charts as well as other information contained in this document and the exhibits hereto, to incorporate new information learned during the course of discovery including, but not limited to, information that is not publicly available or readily discernible without discovery. AGIS Software further reserves the right to amend these claim charts, as well as other information contained in this document and the exhibits attached hereto, pursuant to Patent Local Rules 3-1(g) and 3-6.

D. LITERAL INFRINGEMENT AND DOCTRINE OF EQUIVALENTS

AGIS Software asserts that, under the proper construction of the asserted claims and their claim terms, the limitations of the asserted claims of the Patents-in-Suit are literally present in the Lyft Accused Products as set forth in the claim charts attached hereto as Exhibits A-E. AGIS Software contends that any and all elements found not to be literally infringed are infringed under the doctrine of equivalents because the differences between the claimed inventions and the accused instrumentalities, if any, are insubstantial.

AGIS Software contends that Lyft directly infringes the asserted claims by making, using, offering for sale, selling, and importing into the United States the accused instrumentalities as well

1 as indirectly infringe by contributing to and/or inducing others (*e.g.*, Lyft customers or its Lyft
 2 customers' customers) to directly infringe those claims by making, using, offering for sale, or selling
 3 the Lyft Accused Products. AGIS Software contends that Lyft directly infringes the asserted claims
 4 by testing the Lyft Accused Products in the United States.

5 Pursuant to Patent Local Rule 3-6(a), AGIS Software reserves the right to amend its
 6 Infringement Contentions as to literal infringement or infringement under the doctrine of
 7 equivalents, *e.g.*, in light of the Court's claim construction.

8 **E. PRIORITY DATES**

9 Under Patent Local Rule 3-1(f), each of the asserted claims of the Patents-in-Suit are entitled
 10 to a priority date of at least as early as September 21, 2004.² For the purposes of this case only,
 11 AGIS Software intends to assert the following priority dates to earlier applications:

- 12 • April 17, 2006 for Claims 1-31 of U.S. Patent No. 10,299,100 (the "100 Patent");
- 13 and
- 14 • April 17, 2006 for Claims 1-26 of U.S. Patent No. 10,341,838 (the "838 Patent")

15 With the identification of these priority dates, AGIS does not waive the right to assert earlier
 16 priority dates to earlier applications. AGIS Software reserves the right to establish an earlier date
 17 of invention based upon actions related to conception and reduction to practice of the claimed
 18 inventions.

19 **F. PRACTICING PRODUCTS**

20 Pursuant to Patent Local Rule 3-1(g), AGIS Software contends that licensee AGIS, Inc.'s
 21 LifeRing products are covered by at least one of claim 7 of the '728 Patent; claims 9, 12-16 of the
 22 '724 Patent; claims 2, 10-13 of the '970 Patent; claims 1-31 of the '100 Patent; and claims 1-26 of
 23 the '838 Patent. AGIS is not aware of any other licensee that practice any claim of the Patents-in-
 24 Suit. AGIS Software's investigation is ongoing and AGIS Software reserves the right to
 25 supplement, amend, or amend these contentions in view of facts learned during discovery, the

26 _____
 27 ² AGIS continues to rely on interim priority dates identified in each of the Patents-in-Suit to establish
 28 priority prior to the actual filing date of the Patents-in-Suit.

1 release of new products, or the modification of current products, and/or the Court's claim
2 construction.

3 Pursuant to Patent Local Rule 3-1(h), while there is no operative complaint and AGIS has
4 not filed an answer, the first date of infringement appears to be at or around May 2012 and AGIS
5 reserves the right to seek past damages up to six years before the filing of any counterclaim in this
6 action. AGIS Software's investigation is ongoing and AGIS Software reserves the right to
7 supplement, amend, or amend these contentions in view of facts learned during discovery and after
8 the filing of the amended complaint.

9 Pursuant to Patent Local Rule 3-1(i), while there is no operative complaint and AGIS has
10 not filed an answer, Lyft's infringement of the Asserted Patents has been willful since January 29,
11 2021, when it received a complaint in AGIS Software Development LLC v. Lyft Inc. 2:21-cv-
12 00024 (E.D. Tex., Jan. 29, 2021), and continues to be willful. AGIS Software's investigation is
13 ongoing and AGIS Software reserves the right to supplement, amend, or amend these contentions
14 in view of facts learned during discovery and after the filing of the complaint.

15 **G. PRODUCTION OF DOCUMENTS PURSUANT TO PATENT LOCAL RULE**
16 **3-2**

17 AGIS Software is producing or making available for inspection documents that are in AGIS
18 Software's possession, custody, or control as set forth in Patent Local Rule 3-2. An AGIS Software
19 3-2 Production Index identifying these documents is attached hereto.

20 This preliminary identification of documents is for convenience and is not an admission that
21 each document falls within any exemplary categories in the Patent Local Rules, or that any
22 document qualifies as prior art. AGIS Software is continuing with its investigation, particularly
23 with respect to ESI. Thus, AGIS Software reserves its right to add to, delete from, or otherwise
24 modify its disclosures in this section as its investigation proceeds.

25 Production of these documents is governed by Patent Local Rule 2-2, and, with the exception
26 of documents produced pursuant to P.R. 3.2(c) and public documents listed in the infringement
27 charts, are considered "Highly Confidential –Attorneys Eyes Only" and disclosure of the

RUSS AUGUST & KABAT

1 confidential document or information shall be limited to each party’s outside attorney(s) of record
2 and the employees of such outside attorney(s).

3
4 DATED: February 25, 2022

Respectfully submitted,

5 **RUSS AUGUST & KABAT**

6 By: /s/ Benjamin T. Wang
Benjamin T. Wang

7 **FABRICANT LLP**

8 Alfred R. Fabricant
9 ffabricant@fabricantllp.com
Peter Lambrianakos
10 plambrianakos@fabricantllp.com
Vincent J. Rubino, III
11 vrubino@fabricantllp.com
411 Theodore Fremd Avenue, Suite 206 South
12 Rye, New York 10580
Telephone: (212) 257-5797
13 Facsimile: (212) 257-5796

14 *Attorneys for Defendant*
AGIS Software Development LLC

15
16 **CERTIFICATE OF SERVICE**

17 The undersigned hereby certified that a true and correct copy of the above and foregoing
18 document has been served via electronic mail on February 25, 2022, to all counsel of record.

19 I declare under the penalty of perjury that the foregoing is true and correct.

20 DATED: February 25, 2022

/s/ Benjamin T. Wang
Benjamin T. Wang

21
22
23
24
25
26
27
28

Attachment A for US Patent No. 10,341,838 Against Lyft Accused Products

Based on information presently available,¹ Defendant AGIS Software Development LLC (“AGIS Software”) contends that Plaintiff Lyft Inc. (“Lyft” or “Plaintiff”) infringes claims 1-26 (the “Asserted Claims”) of U.S. Patent No. 10,341,838 (the “’838 Patent”) through the Accused Products which are manufactured, sold, offered for sale, and/or used by Lyft.

The Accused Products comprise the Lyft and Lyft Driver applications, servers, and services manufactured, used, or sold by Lyft, Inc. during and after 2016. AGIS Software reserves the right to seek leave of court to amend this list of Accused Products after the filing of an amended complaint or as discovery progresses.

Lyft directly infringes each of the Asserted Claims by making, using, importing, testing, distributing, selling, and/or offering for sale the Accused Products in violation of 35 U.S.C. § 271(a).

Lyft indirectly infringes the Asserted Claims in violation of 35 U.S.C. § 271(b) by inducing third parties, including its users and/or customers, to directly infringe through their operation and use of the Accused Products. Lyft has knowingly and intentionally induced this direct infringement by, *inter alia*, (i) selling, importing, or otherwise providing the Accused Products to third parties with the intent that the Accused Products will be operated and used in a manner that practices the Asserted Claims; and (ii) marketing and advertising the Accused Products. Lyft’s marketing and promotional materials for the Accused Products are found, for example, on Lyft’s website, and in App stores of operating systems for which the Accused Products are made available. For example, Lyft’s website offers customers instructions and/or manuals for the Accused Products that instruct customers to, among other things, use the accused services in the Accused Products. Lyft’s website also offers support to customers, including instruction to, among other things, use the Accused Products share location information with a group of users. Lyft knows, or should have known, that its actions will result in infringement of the Asserted Claims, or subjectively believes that there is a high probability that its actions will result in infringement of the Asserted Claims but has taken deliberate actions to avoid learning these facts.

Lyft also contributorily infringes each of the Asserted Claims in violation of 35 U.S.C. § 271(c) by selling, importing, offering for sale, and otherwise providing the Accused Products, which when used directly infringe the Asserted Claims. The Accused Products constitute a material part of the Asserted Claims.

¹ There is no operative complaint asserting non-infringement of any patent claim in this action at this time. AGIS Software reserves the right to update its contentions upon receipt of any future amended complaint.

Attachment A for US Patent No. 10,341,838 Against Lyft Accused Products

The following chart identifies specifically where each limitation of each Asserted Claim is found within the Accused Products, and in particular, the corresponding elements that meet the limitations in the Lyft and Lyft Driver applications, services, and services. On information and belief, each charted version of the Lyft servers related to the Lyft and Lyft Driver Apps is representative of all versions of the Accused Products, including all variants of the Accused Products made, sold, offered for sale, or used on any version of the Android and iOS operating systems. AGIS Software relies on circumstantial evidence of the servers' features by relying on the end features or services provided by the Lyft and Lyft Driver Apps.

AGIS Software does not concede that any claims of the '838 Patent that are not listed below are not infringed by the identified Accused Products. Moreover, the citations to certain documents and other information below are intended to be exemplary only and in no way foreclose AGIS from citing or relying on additional documents, information, source code, and/or testimony at a later time. These contentions are preliminary in nature and an analysis of Lyft's products, internal documentation, source code, and/or testimony from relevant witnesses may more fully and accurately describe the infringing features of its accused products. Accordingly, AGIS Software reserves the right to seek leave of court to supplement, correct, modify, and/or amend these contentions once such additional information is made available to AGIS Software. Furthermore, AGIS Software reserves the right to seek leave of court to supplement, correct, modify, and/or amend these contentions as discovery in this case progresses; in view of the Court's claim construction order(s);² in view of any positions taken by Lyft, including but not limited to positions on claim construction, invalidity, and/or non-infringement; and in connection with the preparation and exchange of expert reports.

The contents of each claim cell below on which another claim cell depends are expressly incorporated by reference in that dependent cell, as if set forth in their entirety therein.

² The construction of claim terms herein is consistent with the constructions in *AGIS Software Dev. LLC v. Huawei Device USA, Inc.*, No. 2:17-cv-00513-JRG, Dkt. 205 (E.D. Tex. Oct. 10, 2018); *AGIS Software Dev. LLC v. Google LLC*, No. 2:19-cv-00361-JRG, Dkt. 147 (E.D. Tex. Dec. 8, 2020); *AGIS Software Dev. LLC v. T-Mobile USA, Inc., et al.*, No. 2:21-cv-00072-JRG, Dkt. 213 (E.D. Tex. Nov. 10, 2021). AGIS Software reserves the right to update its constructions and contentions in view of this Court's claim construction order.

Attachment A for US Patent No. 10,341,838 Against Lyft Accused Products

Claim 10,341,838	- Accused Products
<p>1[P]. A method performed by one or more servers each having one or more processors, the method comprising:</p>	<p>The Lyft Servers perform the computer implemented method as set forth below. Lyft further infringes directly and/or indirectly by performing, inducing others to perform, and/or contributing to the performance of: a method performed by one or more servers each having one or more processors</p> <p>For example, Lyft provides the Lyft app for passengers and the Lyft Driver app for drivers. The Lyft apps for riders and drivers, in conjunction with Lyft’s servers and services, provide users with interactive methods to request, view, and track locations of passengers/riders using real-time maps and communications. Lyft provides one or more servers with processors (either hardware or software). The Lyft server(s) and their services communicate with the Lyft apps for riders and drivers. The Lyft server(s) and their services host information related to and instructions for processing user/device/vehicle accounts, location data, and map data.</p> <h2 data-bbox="443 670 932 743">Lyft Driver app</h2> <div data-bbox="436 781 1673 867" style="border: 1px solid red; padding: 5px;"> <p>We’ve separated the passenger and driver experiences into two separate mobile apps — one exclusively for passengers (named the Lyft app) and the other exclusively for drivers (named the Lyft Driver app).</p> </div> <p>The Lyft Driver app will eventually be standard for all drivers and required for driving. At this time, drivers can keep using the Lyft app to give rides. Don’t worry! While we have some planned improvements to the Lyft Driver app, we’ve kept its features the same.</p> <p>https://help.lyft.com/hc/en-ca/articles/115013079208-Lyft-Driver-app</p> <h2 data-bbox="443 1102 743 1149">What is Lyft?</h2> <p>Lyft is a platform that connects drivers with individuals and organizations that need rides.</p> <p>https://www.lyft.com/drive-with-lyft</p>

Attachment A for US Patent No. 10,341,838 Against Lyft Accused Products

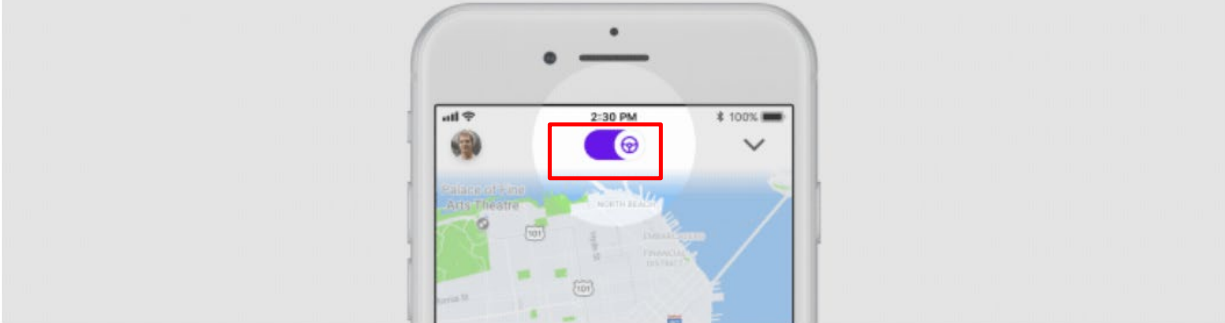
Claim 10,341,838	- Accused Products
	 <p data-bbox="436 662 562 690">Go online</p> <p data-bbox="436 727 1633 836">Open your Lyft Driver app and tap the steering wheel icon. Lyft will now find the closest passenger to your location requesting a ride. Turn on some music and get comfortable: that first ride request may come quickly or may take a while, depending on the number of current passenger requests.</p> <p data-bbox="436 841 1096 868">https://www.lyft.com/hub/posts/how-to-give-a-ride</p>

Attachment A for US Patent No. 10,341,838 Against Lyft Accused Products

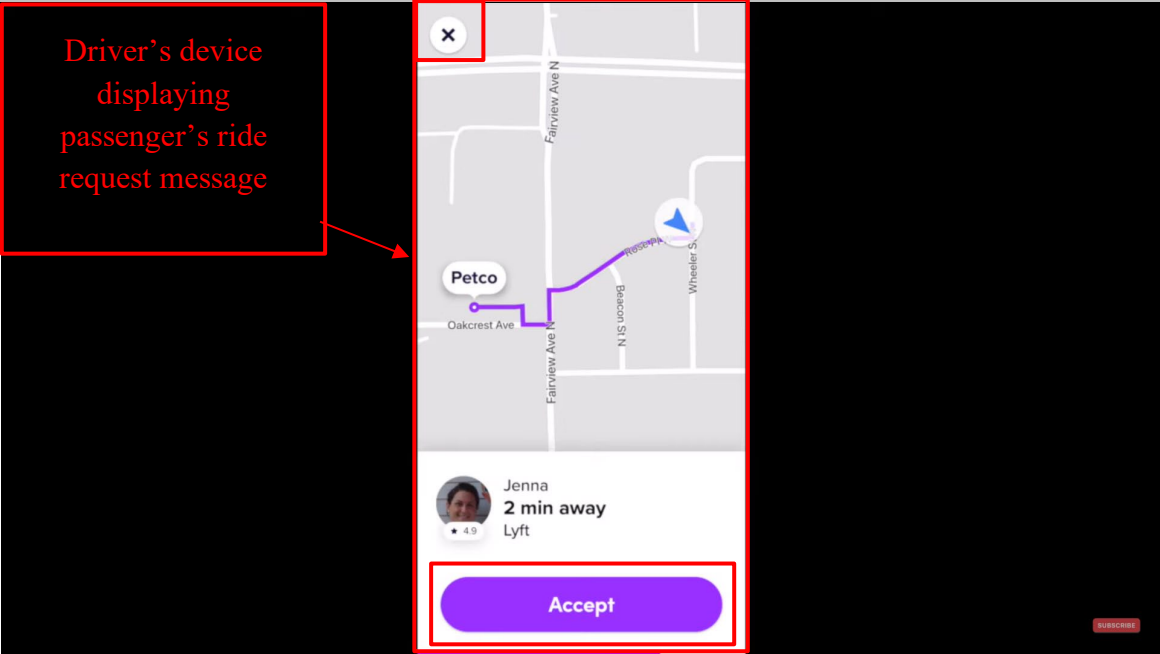
Claim 10,341,838	- Accused Products
	<p data-bbox="478 297 701 459">Driver's device displaying passenger's ride request message</p>  <p data-bbox="436 919 1350 951">https://www.youtube.com/watch?v=jVUy9poJDng at 10:24, Annotated</p>

Attachment A for US Patent No. 10,341,838 Against Lyft Accused Products

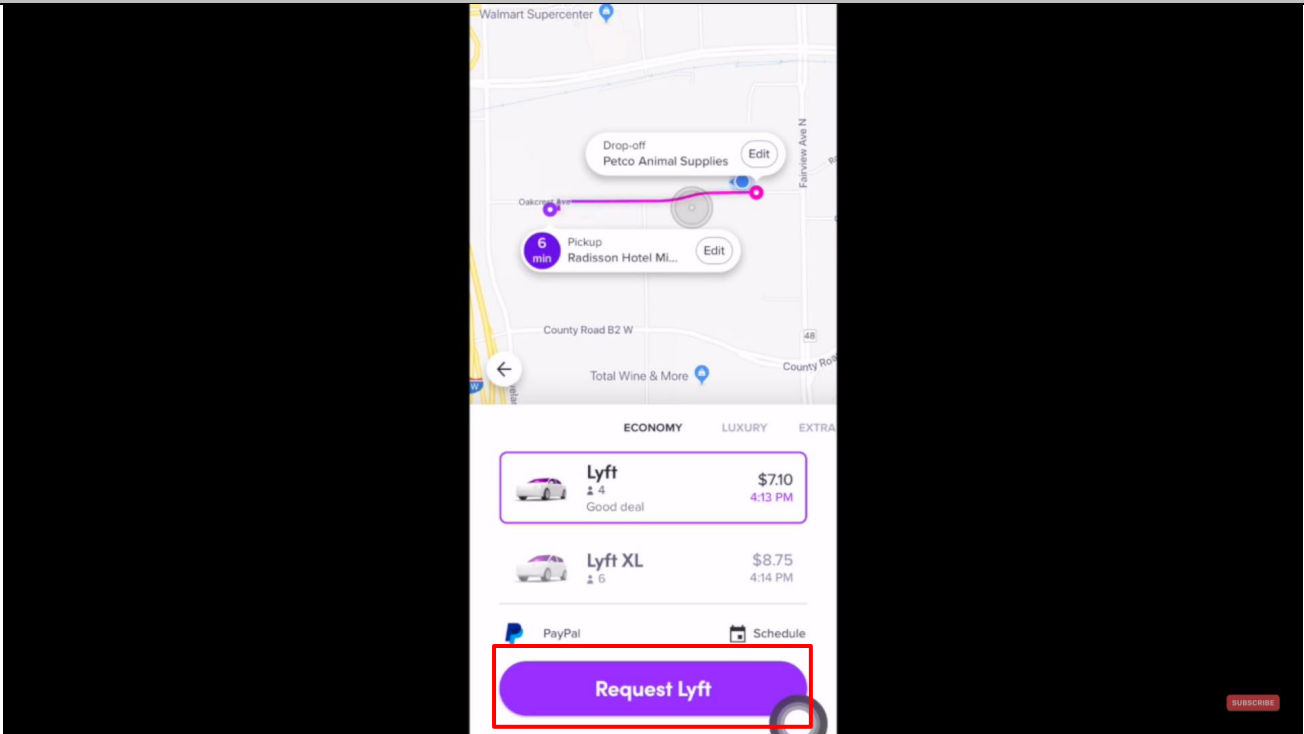
Claim 10,341,838	- Accused Products
	 <p>https://www.youtube.com/watch?v=j0RDMLcmOgU at 4:01</p>

Attachment A for US Patent No. 10,341,838 Against Lyft Accused Products

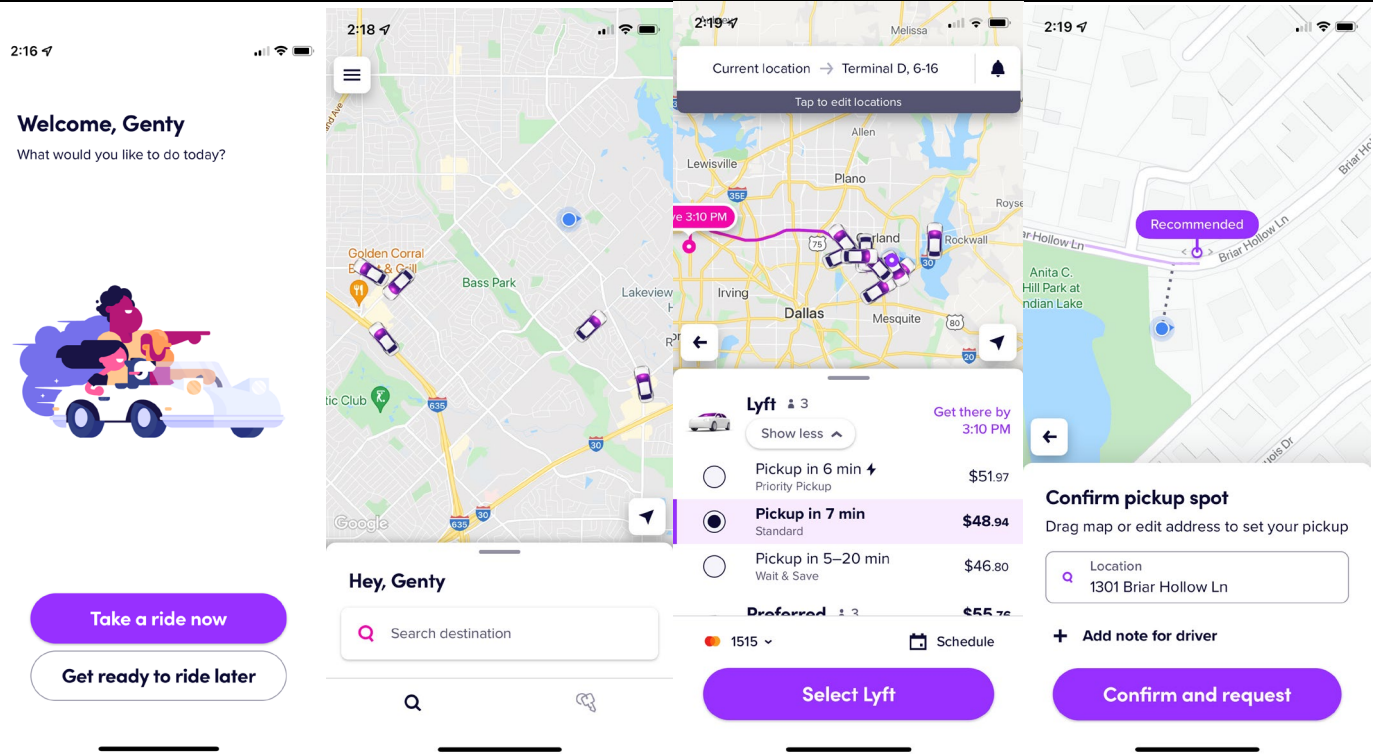
Claim 10,341,838	- Accused Products
	 <p>The image displays three sequential screenshots of the Lyft mobile application interface. The first screenshot (left) shows a welcome screen for a user named 'Genty' with a 'Welcome, Genty' message and a 'What would you like to do today?' prompt. Below this is an illustration of a Lyft car and two buttons: 'Take a ride now' and 'Get ready to ride later'. The second screenshot (middle) shows the main ride request screen. It features a map of Dallas, Texas, with a search bar for the destination and a 'Search destination' button. A list of ride options is displayed, including 'Lyft' (3 cars), 'Priority Pickup' (\$51.97), 'Standard' (\$48.94), and 'Wait & Save' (\$46.80). A 'Select Lyft' button is at the bottom. The third screenshot (right) shows the 'Confirm pickup spot' screen. It prompts the user to 'Drag map or edit address to set your pickup' and shows a recommended location: '1301 Briar Hollow Ln'. A 'Confirm and request' button is at the bottom.</p>

Attachment A for US Patent No. 10,341,838 Against Lyft Accused Products

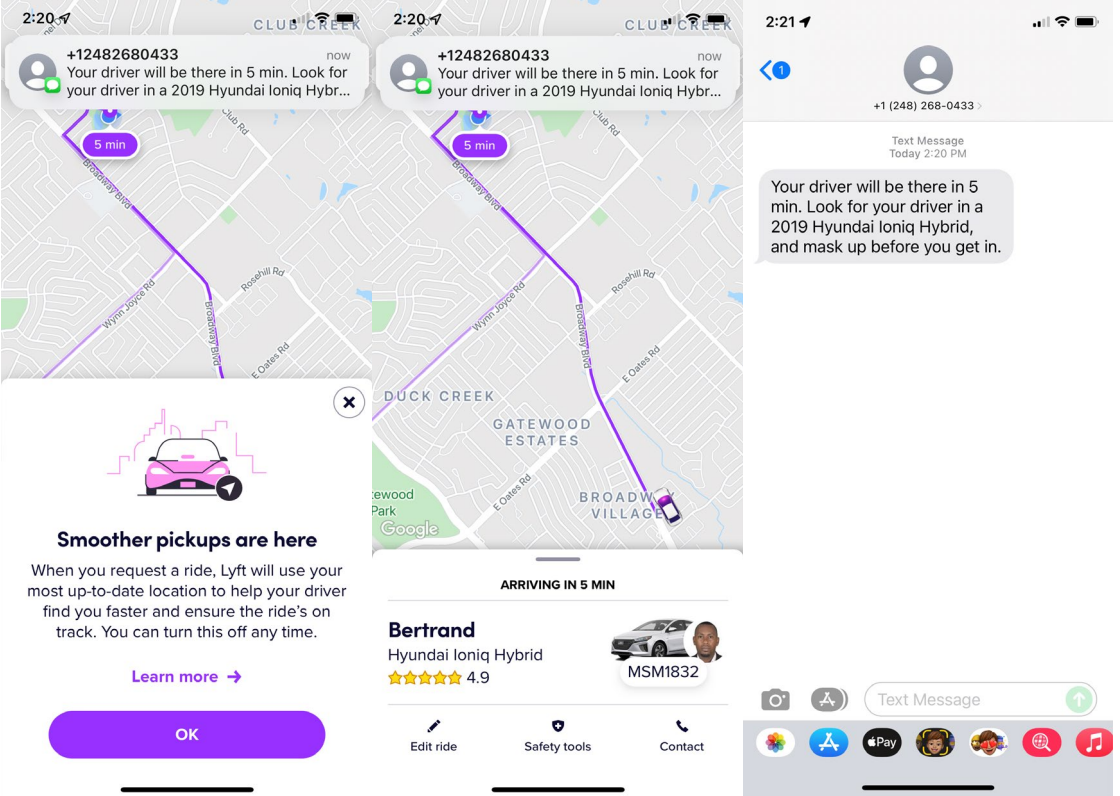
Claim 10,341,838	- Accused Products
	 <p>The image displays three screenshots from the Lyft mobile application. The leftmost screenshot shows a ride confirmation screen with a map, a 5-minute arrival timer, and a 'Smoother pickups are here' notification. The middle screenshot shows the driver's profile for Bertrand, a 2019 Hyundai Ioniq Hybrid with a 4.9-star rating. The rightmost screenshot shows a text message from the driver: 'Your driver will be there in 5 min. Look for your driver in a 2019 Hyundai Ioniq Hybrid, and mask up before you get in.'</p> <p>Further, to the extent this element is performed at least in part by Lyft's software source code, AGIS reserves the right to supplement these contentions pursuant to production of such source code by Lyft and to the extent Lyft requires additional information in accordance with P.R. 3-1 and for any other reasons.</p>
<p>1[A]. executing operations on the one or more processors, the operations comprising:</p>	<p>The Lyft Accused Products infringe directly and/or indirectly by performing, inducing others to perform, and/or contributing to the performance of: executing operations on the one or more processors, the operations.</p> <p>For example, Lyft servers comprise processors which receive passenger's request for a ride and communicate the request to the nearby drivers. The nearby drivers receive the request for a ride from the passengers which they accept</p>

Attachment A for US Patent No. 10,341,838 Against Lyft Accused Products

Claim 10,341,838	- Accused Products
	<p>or decline. The servers further facilitate the communication between the passenger and the allocated driver during a ride.</p> <div data-bbox="430 375 1583 1024"><p>Driver's device displaying passenger's ride request message</p><p>Map showing route from Petco to Wheeler St.</p><p>Jenna 4.9 2 min away Lyft</p><p>Accept</p></div> <p>https://www.youtube.com/watch?v=jVUy9poJDng at 10:24, Annotated</p>

Attachment A for US Patent No. 10,341,838 Against Lyft Accused Products

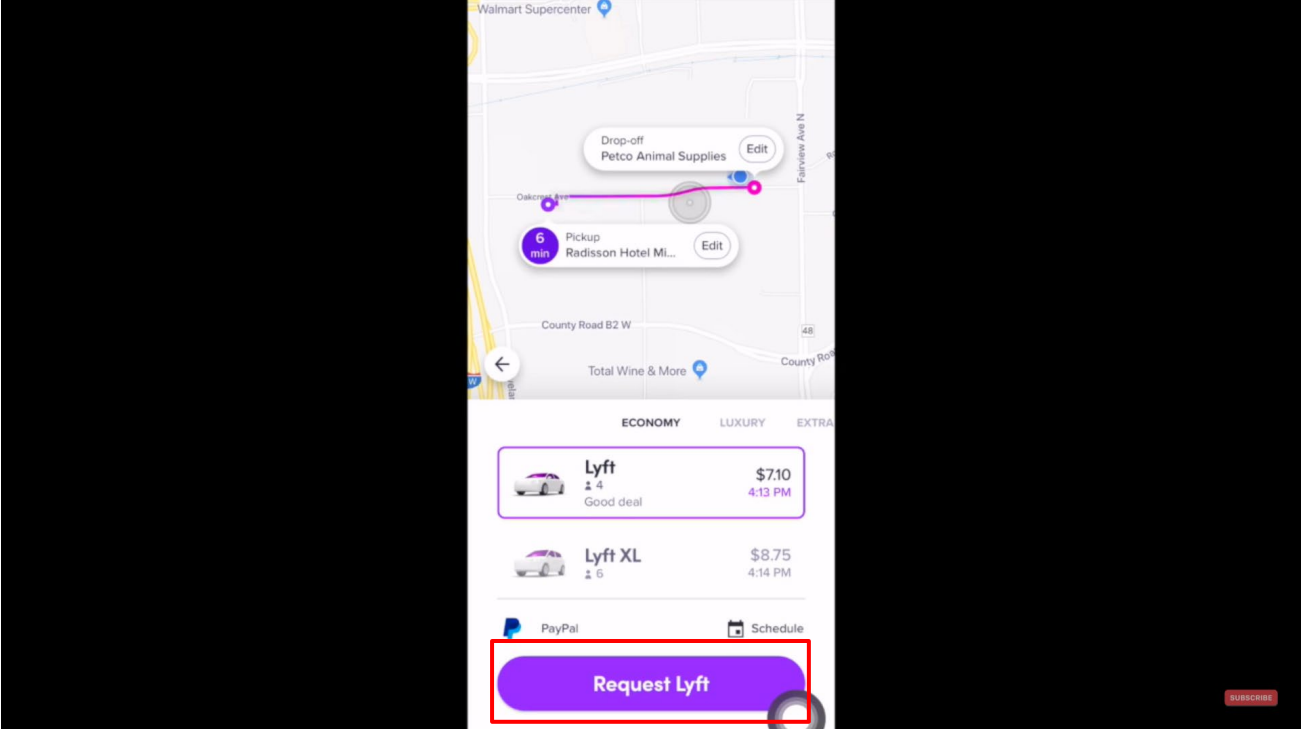
Claim 10,341,838	- Accused Products
	 <p>https://www.youtube.com/watch?v=j0RDMLcmOgU at 4:01</p>

Attachment A for US Patent No. 10,341,838 Against Lyft Accused Products

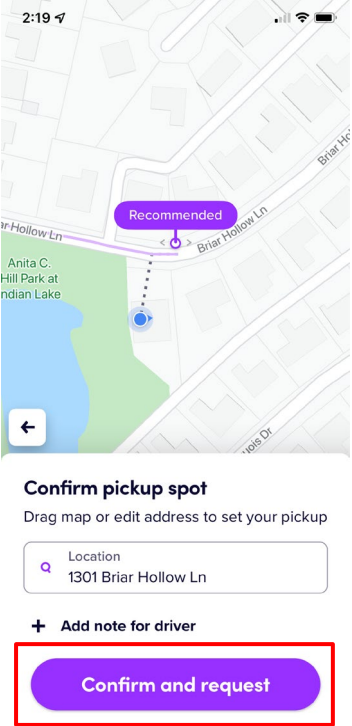
Claim 10,341,838	- Accused Products
	 <p>Confirm pickup spot Drag map or edit address to set your pickup</p> <p>Location 1301 Briar Hollow Ln</p> <p>+ Add note for driver</p> <p>Confirm and request</p> <p>Further, to the extent this element is performed at least in part by Lyft's software source code, AGIS reserves the right to supplement these contentions pursuant to production of such source code by Lyft and to the extent Lyft requires additional information in accordance with P.R. 3-1 and for any other reasons.</p>
<p>1[B]. obtaining first data provided by a first mobile device corresponding</p>	<p>The Lyft Accused Products infringe directly and/or indirectly by performing, inducing others to perform, and/or contributing to the performance of: obtaining first data provided by a first mobile device corresponding to a vehicle, the first data including a first identifier.</p>

Attachment A for US Patent No. 10,341,838 Against Lyft Accused Products

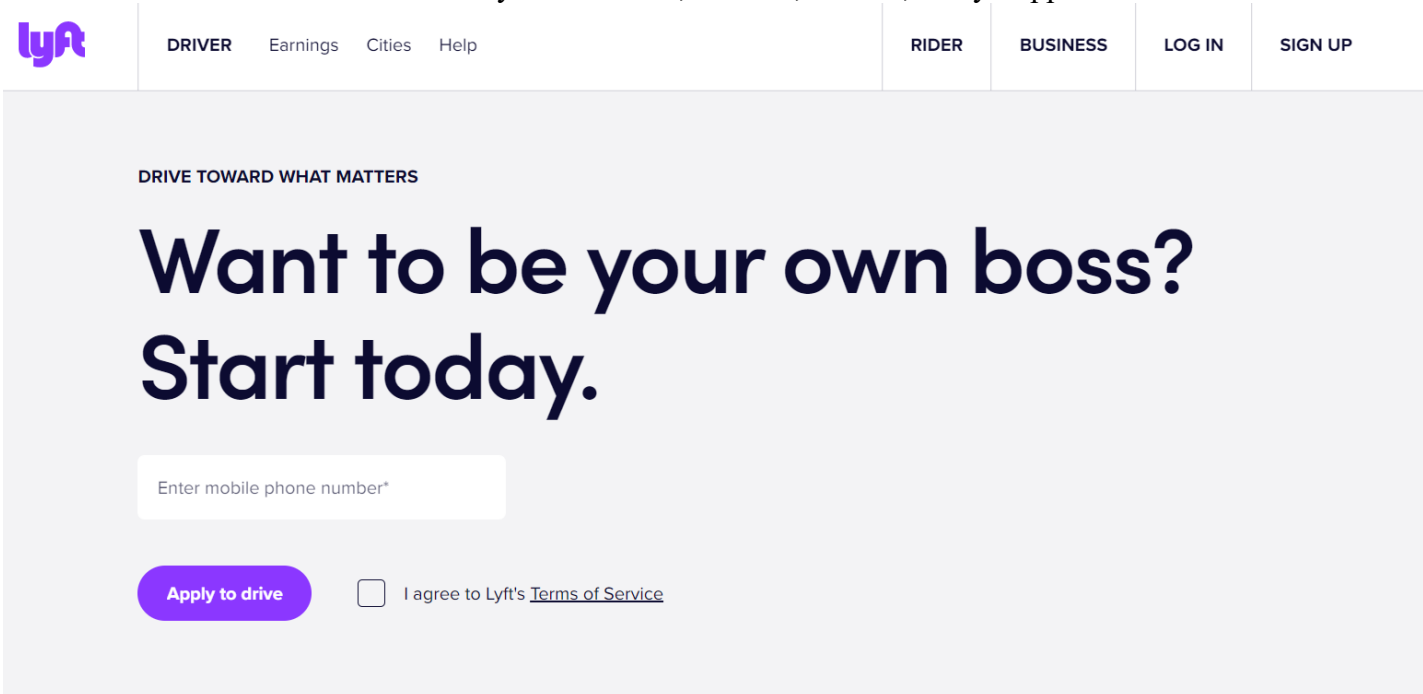
Claim 10,341,838	- Accused Products
<p>to a vehicle, the first data including a first identifier</p>	<p>For example, the Lyft driver sets up his/her account by providing information including but not limited to name, email address, phone number, driver’s license and vehicle information. Lyft assigns one or more indentifications associated with the account.</p> <p>For example, the Lyft Driver app installed in a driver’s mobile device allows a driver to set up his/her account by providing information including but not limited to name, email address, phone number, driver’s license and vehicle information. The Lyft server(s) perform this limitation when they obtain the account creation data from the Lyft app for drivers. The Lyft server(s) also perform this limitation, after account creation, when they obtain the data during the sign-in or log-in process from the Lyft app for drivers. The Lyft server(s) also perform this limitation when they obtain the data by requesting status or other data via the Lyft app for drivers. In all cases, the first identifier is information associated with the identity of the driver, account, vehicle, or Lyft app for drivers.</p>  <p>Source: https://www.lyft.com/driver.</p>

Attachment A for US Patent No. 10,341,838 Against Lyft Accused Products

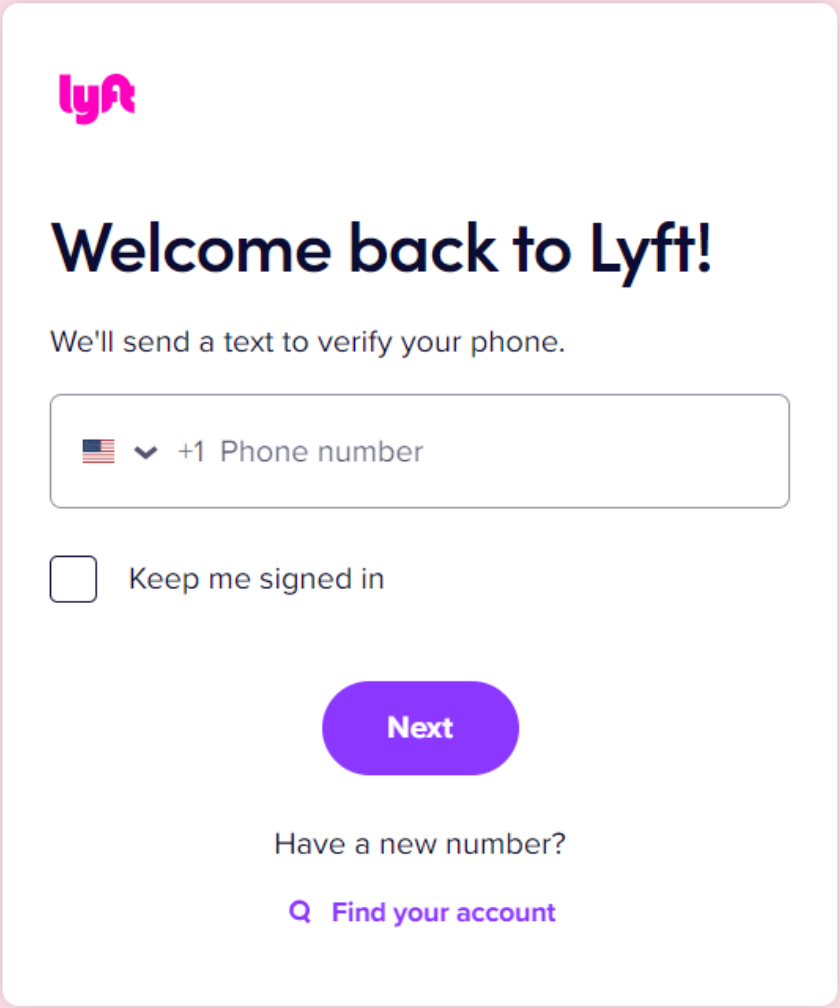
Claim 10,341,838	- Accused Products
	 <p>The screenshot shows the Lyft mobile app's login screen. At the top left is the Lyft logo. Below it is the heading "Welcome back to Lyft!". Underneath is the text "We'll send a text to verify your phone." followed by a phone number input field with a dropdown menu showing a US flag and "+1 Phone number". Below the input field is a checkbox labeled "Keep me signed in". At the bottom center is a purple "Next" button. Below the button is the text "Have a new number?" and a purple link "Find your account" with a magnifying glass icon.</p>

Attachment A for US Patent No. 10,341,838 Against Lyft Accused Products

Claim 10,341,838	- Accused Products
	<p>Source: https://account.lyft.com/auth?next=https%3A%2F%2Fwww.lyft.com%2Flogin%2Fjump.</p> <h2 data-bbox="443 350 1136 427">Driver requirements</h2> <p data-bbox="443 475 1738 540">All Lyft drivers must meet certain requirements to drive on the platform. Applicant and vehicle requirements can vary depending on your City or State.</p> <p data-bbox="443 573 1329 605">To start an application, see How to apply to become a driver for instructions.</p> <p data-bbox="443 638 537 670">Skip to:</p> <ul data-bbox="510 703 1083 1092" style="list-style-type: none"><li data-bbox="510 703 873 735">• State and local requirement<ul data-bbox="615 751 947 881" style="list-style-type: none"><li data-bbox="615 751 856 784">◦ Age requirement<li data-bbox="615 800 947 833">◦ Vehicle requirements<li data-bbox="615 849 825 881">◦ Driving history<li data-bbox="510 914 768 946">• Background check<li data-bbox="510 963 684 995">• DMV check<li data-bbox="510 1011 1083 1044">• Driver license, license plates, and insurance<li data-bbox="510 1060 993 1092">• Community Safety Education program <p data-bbox="443 1125 1329 1157">https://help.lyft.com/hc/e/articles/115012925687-Driver-requirements</p>

Attachment A for US Patent No. 10,341,838 Against Lyft Accused Products

Claim 10,341,838	- Accused Products
	<p data-bbox="443 272 957 315">How to start an application</p> <p data-bbox="443 347 1272 375">Create a Lyft account through the app or on the web at lyft.com/drivers.</p> <p data-bbox="443 410 1696 475">Enter your name, phone number, and email address, then submit all the info we need to ensure you meet the requirements. If you sign out of your account, any application info you've submitted will be saved.</p> <p data-bbox="443 511 1717 576">If you have a promo code, enter it when creating an account. If you apply through a link on a website, the code will be added automatically.</p> <p data-bbox="443 612 575 639">Back to top</p> <p data-bbox="443 656 1062 683">https://help.lyft.com/hc/e/articles/115013081188</p> <p data-bbox="443 727 785 769">Applicant Waitlist</p> <p data-bbox="443 805 1707 870">New applicants will be automatically added to our waitlist. This makes sure there's a better balance of drivers and passengers in your region.</p> <p data-bbox="443 906 1738 1036">The waitlist is a hold on your application request that will be removed when additional spots for new drivers open up in your city. It's hard to say exactly how long you'll be on the waitlist due to a variety of factors that affect demand in certain areas. The waitlist doesn't impact existing drivers. We'll send you a notification as soon as a spot opens up!</p> <p data-bbox="443 1071 1696 1136">As soon as you're removed from the waitlist you'll be able to complete all necessary application steps. Once your application and documents are approved, you can start driving.</p> <p data-bbox="443 1172 1062 1200">https://help.lyft.com/hc/e/articles/115013081188</p> <p data-bbox="443 1235 1896 1344">Further, to the extent this element is performed at least in part by Lyft's software source code, AGIS reserves the right to supplement these contentions pursuant to production of such source code by Lyft and to the extent Lyft requires additional information in accordance with P.R. 3-1 and for any other reasons.</p>

Attachment A for US Patent No. 10,341,838 Against Lyft Accused Products

Claim 10,341,838	- Accused Products
<p>1[C]. permitting the first mobile device corresponding to the vehicle to join a communication network, the permitting based on a determination regarding the first data</p>	<p>The Lyft Accused Products infringe directly and/or indirectly by performing, inducing others to perform, and/or contributing to the performance of: permitting the first mobile device corresponding to the vehicle to join a communication network, the permitting based on a determination regarding the first data.</p> <p>The Lyft server(s) perform this limitation when the server uses the account or identity information described above to add the account/driver/vehicle to the Lyft platform or network of drivers and passengers. The Lyft server(s) also perform this limitation when the server uses the account or identity information to create or activate or update an account using the account or identity information described above. The Lyft server(s) also perform this limitation when a driver completes the sign-in or log-in process. The Lyft server(s) also perform this step using a verification or validation process within sign-up, sign-in, or status request process. The account or identity information is associated with the Lyft platform or network of drivers and passengers or a subset of the platform or network.</p>

Attachment A for US Patent No. 10,341,838 Against Lyft Accused Products

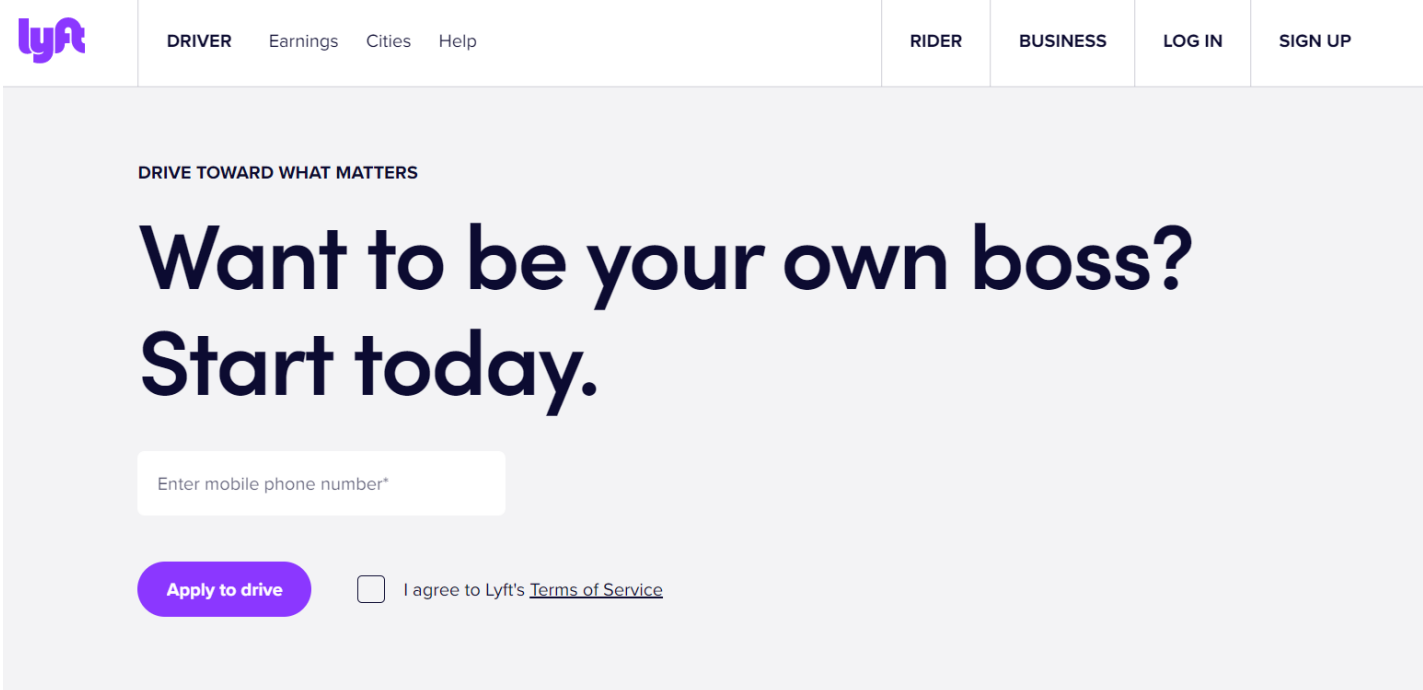
Claim 10,341,838	- Accused Products
	 <p>Source: https://www.lyft.com/driver.</p>

Attachment A for US Patent No. 10,341,838 Against Lyft Accused Products

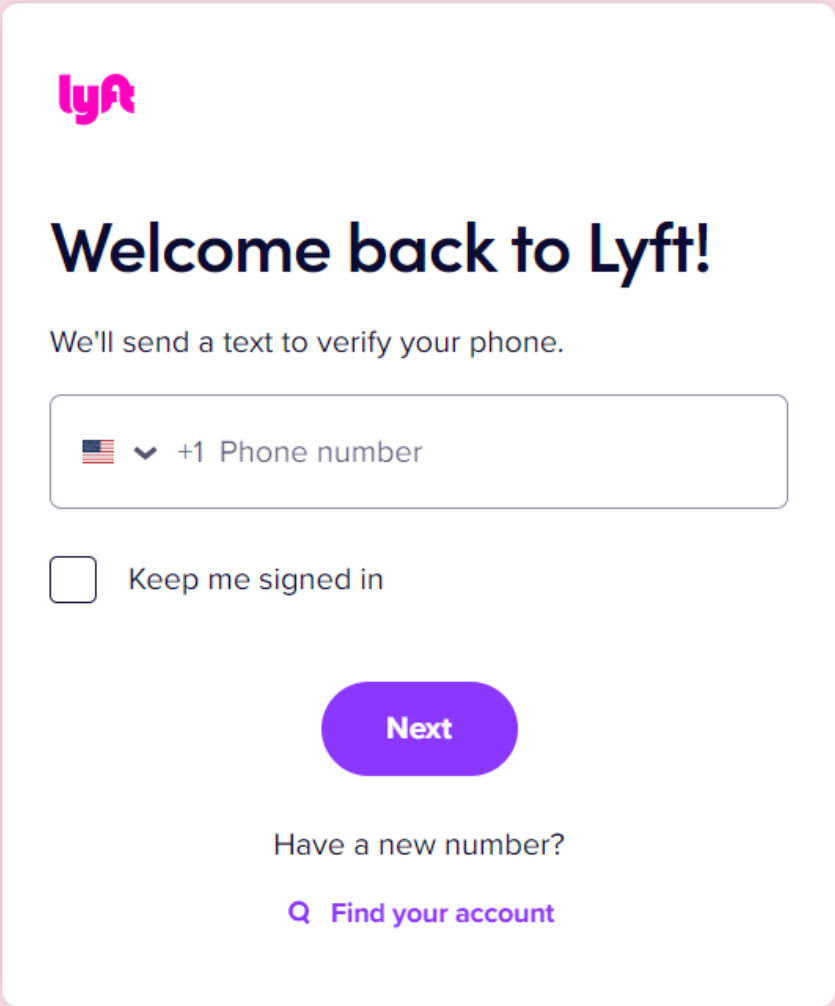
Claim 10,341,838	- Accused Products
	 <p>The screenshot shows the Lyft mobile application login screen. At the top left is the Lyft logo. Below it is the heading "Welcome back to Lyft!". Underneath is the text "We'll send a text to verify your phone." followed by a phone number input field with a dropdown menu showing the United States flag and "+1 Phone number". Below the input field is a checkbox labeled "Keep me signed in". At the bottom center is a purple rounded button labeled "Next". Below the button is the text "Have a new number?" and a purple link with a magnifying glass icon labeled "Find your account".</p>

Attachment A for US Patent No. 10,341,838 Against Lyft Accused Products

Claim 10,341,838	- Accused Products
	<p>Source: https://account.lyft.com/auth?next=https%3A%2F%2Fwww.lyft.com%2Flogin%2Fjump.</p> <h2 data-bbox="443 315 1136 386">Driver requirements</h2> <p data-bbox="443 440 1738 500">All Lyft drivers must meet certain requirements to drive on the platform. Applicant and vehicle requirements can vary depending on your City or State.</p> <p data-bbox="443 537 1329 565">To start an application, see How to apply to become a driver for instructions.</p> <p data-bbox="443 602 537 630">Skip to:</p> <ul data-bbox="512 662 1083 1057" style="list-style-type: none"><li data-bbox="512 662 873 690">• State and local requirement<ul data-bbox="617 716 947 841" style="list-style-type: none"><li data-bbox="617 716 856 743">◦ Age requirement<li data-bbox="617 764 947 792">◦ Vehicle requirements<li data-bbox="617 813 827 841">◦ Driving history<li data-bbox="512 878 768 906">• Background check<li data-bbox="512 927 684 954">• DMV check<li data-bbox="512 976 1083 1003">• Driver license, license plates, and insurance<li data-bbox="512 1024 993 1052">• Community Safety Education program <p data-bbox="443 1089 1329 1117">https://help.lyft.com/hc/e/articles/115012925687-Driver-requirements</p>

Attachment A for US Patent No. 10,341,838 Against Lyft Accused Products

Claim 10,341,838	- Accused Products
	<h3 data-bbox="443 272 957 318">How to start an application</h3> <p data-bbox="443 347 1276 376">Create a Lyft account through the app or on the web at lyft.com/drivers.</p> <p data-bbox="443 410 1696 475">Enter your name, phone number, and email address, then submit all the info we need to ensure you meet the requirements. If you sign out of your account, any application info you've submitted will be saved.</p> <p data-bbox="443 509 1717 574">If you have a promo code, enter it when creating an account. If you apply through a link on a website, the code will be added automatically.</p> <p data-bbox="443 609 575 638">Back to top</p> <p data-bbox="443 656 1062 685">https://help.lyft.com/hc/e/articles/115013081188</p> <h3 data-bbox="443 727 785 773">Applicant Waitlist</h3> <p data-bbox="443 807 1707 872">New applicants will be automatically added to our waitlist. This makes sure there's a better balance of drivers and passengers in your region.</p> <p data-bbox="443 906 1738 1036">The waitlist is a hold on your application request that will be removed when additional spots for new drivers open up in your city. It's hard to say exactly how long you'll be on the waitlist due to a variety of factors that affect demand in certain areas. The waitlist doesn't impact existing drivers. We'll send you a notification as soon as a spot opens up!</p> <p data-bbox="443 1076 1696 1141">As soon as you're removed from the waitlist you'll be able to complete all necessary application steps. Once your application and documents are approved, you can start driving.</p> <p data-bbox="443 1170 1062 1200">https://help.lyft.com/hc/e/articles/115013081188</p> <p data-bbox="428 1240 1896 1344">Further, to the extent this element is performed at least in part by Lyft's software source code, AGIS reserves the right to supplement these contentions pursuant to production of such source code by Lyft and to the extent Lyft requires additional information in accordance with P.R. 3-1 and for any other reasons.</p>





Attachment A for US Patent No. 10,341,838 Against Lyft Accused Products

Claim 10,341,838	- Accused Products
<p>1[D]. obtaining second data provided by a second mobile device corresponding to a participant, the second data including a second identifier associated with the participant</p>	<p>The Lyft Accused Products infringe directly and/or indirectly by performing, inducing others to perform, and/or contributing to the performance of: obtaining second data provided by a second mobile device corresponding to a participant, the second data including a second identifier associated with the participant.</p> <p>For example, the Lyft app installed on a passenger’s mobile device allows a passenger to set up his/her account by providing information including but not limited to name, email address and phone number. The Lyft server(s) perform this limitation when they obtain the account creation data from the Lyft app for riders. The Lyft server(s) also perform this limitation, after account creation, when they obtain the data during the sign-in or log-in process from the Lyft app for riders. The Lyft server(s) also perform this limitation when they obtain the data by requesting status or other data via the Lyft app for riders. In all cases, the second identifier is information associated with the identity of the rider, account, device, phone number, or Lyft app for riders.</p>

Attachment A for US Patent No. 10,341,838 Against Lyft Accused Products

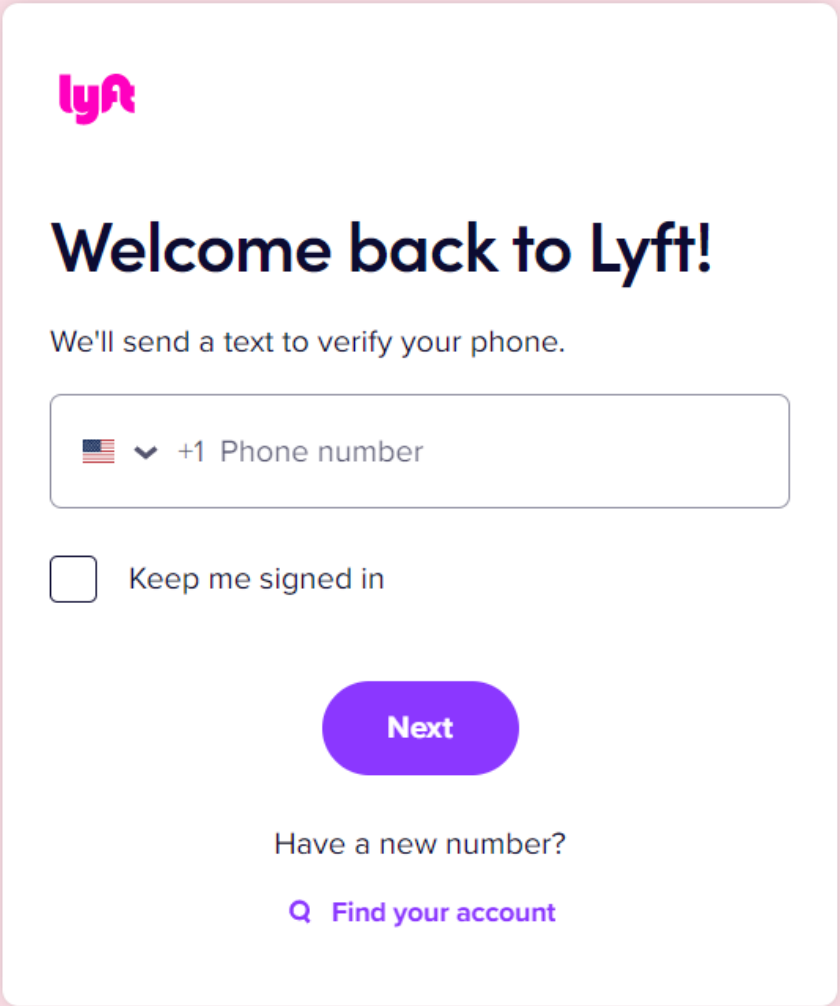
Claim 10,341,838	- Accused Products
	<p data-bbox="470 293 903 334">Sign up for a Lyft account</p> <p data-bbox="470 363 989 386">Before you begin, be sure you have the following:</p> <ul data-bbox="527 418 768 529" style="list-style-type: none"><li data-bbox="527 418 768 441">• Your phone number<li data-bbox="527 461 768 483">• Your email address<li data-bbox="527 503 768 526">• A photo of yourself <p data-bbox="470 573 590 596">Get started</p> <ol data-bbox="527 628 1797 826" style="list-style-type: none"><li data-bbox="527 628 938 651">1. Type in your device's phone number<li data-bbox="527 670 1797 693">2. To verify your identity, we'll send a verification code via text to your phone number. We want to make sure you're human!<li data-bbox="527 712 1503 735">3. The text message should arrive immediately. If you don't see it after a bit, tap 'Resend code.'<li data-bbox="527 755 1465 777">4. Type in your name, email address, and take a selfie so your driver knows who to pick up<li data-bbox="527 797 1625 820">5. That's it! Once you've set up your account, you'll be able to request a ride (Learn How to request a ride). <p data-bbox="470 868 1041 891">Log-in troubles? Read How to fix log-in issues for more.</p> <p data-bbox="470 924 1745 946">Age requirement: You must be at least 18 years old to create a Lyft account, request a ride, or have a ride requested for you.</p> <p data-bbox="470 979 590 1002">Back to top</p> <p data-bbox="432 1034 1556 1057">Source: https://help.lyft.com/hc/e/articles/115012926947-How-to-create-a-Lyft-account.</p>

Attachment A for US Patent No. 10,341,838 Against Lyft Accused Products

Claim 10,341,838	- Accused Products
	 <p>lyft</p> <h2>Welcome back to Lyft!</h2> <p>We'll send a text to verify your phone.</p> <p>  +1 Phone number</p> <p><input type="checkbox"/> Keep me signed in</p> <p>Next</p> <p>Have a new number?</p> <p> Find your account</p>

Attachment A for US Patent No. 10,341,838 Against Lyft Accused Products

Claim 10,341,838	- Accused Products
	<p>Source: https://account.lyft.com/auth?next=https%3A%2F%2Fwww.lyft.com%2Flogin%2Fjump.</p> <p>The Lyft rider app allows a user to register and join the network with their phone number.</p> <p>Further, to the extent this element is performed at least in part by Lyft's software source code, AGIS reserves the right to supplement these contentions pursuant to production of such source code by Lyft and to the extent Lyft requires additional information in accordance with P.R. 3-1 and for any other reasons.</p>
<p>1[E]. allowing the second mobile device corresponding to the participant to join the communication network, the allowing based on a determination regarding the second data</p>	<p>The Lyft Accused Products infringe directly and/or indirectly by performing, inducing others to perform, and/or contributing to the performance of: allowing the second mobile device corresponding to the participant to join the communication network, the allowing based on a determination regarding the second data.</p> <p>The Lyft server(s) perform this limitation when the server uses the account or identity information described above to add the account/rider/phone number/Lyft app for riders to the Lyft platform or network of drivers and passengers. The Lyft server(s) also perform this limitation when the server uses the account or identity information to create or activate or update an account using the account or identity information described above. The Lyft server(s) also perform this limitation when a rider completes the sign-in or log-in process. The Lyft server(s) also perform this step using a verification or validation process within sign-up, sign-in, or status request process. The account or identity information is associated with the Lyft platform or network of drivers and passengers or a subset of the platform or network.</p>

Attachment A for US Patent No. 10,341,838 Against Lyft Accused Products

Claim 10,341,838	- Accused Products
	<p data-bbox="470 297 915 337">Sign up for a Lyft account</p> <p data-bbox="470 367 1003 391">Before you begin, be sure you have the following:</p> <ul data-bbox="531 423 779 537" style="list-style-type: none"><li data-bbox="531 423 779 448">• Your phone number<li data-bbox="531 467 779 492">• Your email address<li data-bbox="531 511 779 537">• A photo of yourself <p data-bbox="470 581 594 605">Get started</p> <ol data-bbox="531 638 1839 846" style="list-style-type: none"><li data-bbox="531 638 953 662">1. Type in your device's phone number<li data-bbox="531 682 1839 706">2. To verify your identity, we'll send a verification code via text to your phone number. We want to make sure you're human!<li data-bbox="531 725 1535 750">3. The text message should arrive immediately. If you don't see it after a bit, tap 'Resend code.'<li data-bbox="531 769 1497 794">4. Type in your name, email address, and take a selfie so your driver knows who to pick up<li data-bbox="531 813 1661 837">5. That's it! Once you've set up your account, you'll be able to request a ride (Learn How to request a ride). <p data-bbox="470 886 1058 911">Log-in troubles? Read How to fix log-in issues for more.</p> <p data-bbox="470 943 1785 967">Age requirement: You must be at least 18 years old to create a Lyft account, request a ride, or have a ride requested for you.</p> <p data-bbox="470 1000 594 1024">Back to top</p> <p data-bbox="430 1052 1551 1084">Source: https://help.lyft.com/hc/e/articles/115012926947-How-to-create-a-Lyft-account</p>

Attachment A for US Patent No. 10,341,838 Against Lyft Accused Products

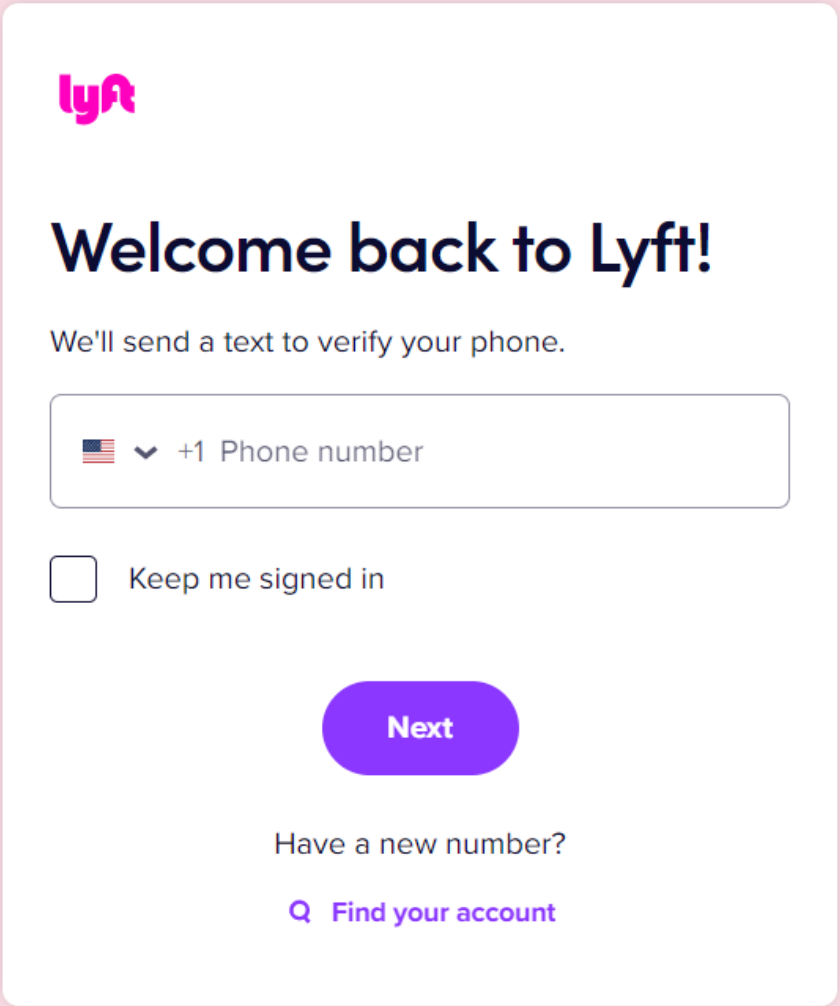
Claim 10,341,838	- Accused Products
	 <p>The screenshot shows the Lyft mobile app's login screen. At the top left is the Lyft logo. Below it is the heading "Welcome back to Lyft!". Underneath is the text "We'll send a text to verify your phone." followed by a phone number input field with a dropdown menu showing a US flag and "+1 Phone number". Below the input field is a checkbox labeled "Keep me signed in". At the bottom center is a purple rounded button labeled "Next". Below the button is the text "Have a new number?" and a purple link with a magnifying glass icon labeled "Find your account".</p>

Attachment A for US Patent No. 10,341,838 Against Lyft Accused Products

Claim 10,341,838	- Accused Products
	<p>Source: https://account.lyft.com/auth?next=https%3A%2F%2Fwww.lyft.com%2Flogin%2Fjump.</p> <p>Further, to the extent this element is performed at least in part by Lyft's software source code, AGIS reserves the right to supplement these contentions pursuant to production of such source code by Lyft and to the extent Lyft requires additional information in accordance with P.R. 3-1 and for any other reasons.</p>
<p>1[F]. receiving vehicle location data provided by the first mobile device corresponding to the vehicle, wherein the vehicle location data are associated with the first identifier and indicate coordinates of a geographical location of the first mobile device</p>	<p>The Lyft Accused Products infringe directly and/or indirectly by performing, inducing others to perform, and/or contributing to the performance of: receiving vehicle location data provided by the first mobile device corresponding to the vehicle, wherein the vehicle location data are associated with the first identifier and indicate coordinates of a geographical location of the first mobile device.</p> <p>The Lyft server(s) perform this limitation when they receive driver location data associated with the account or identity information described above. This information is received at the Lyft server(s) via the Lyft app for drivers. For example, when a driver is online and ready to take request for rides, the driver's app sends its location coordinates to the Lyft servers enabling the servers to match the driver with the nearby passengers. The location data of the driver is associated with his/her account or identity data described above, including but not limited to name, phone number and vehicle information. The driver's location data comprises geographical coordinates or geotagged/geocoded/georeferenced information related to a driver's geographical location.</p>

Attachment A for US Patent No. 10,341,838 Against Lyft Accused Products

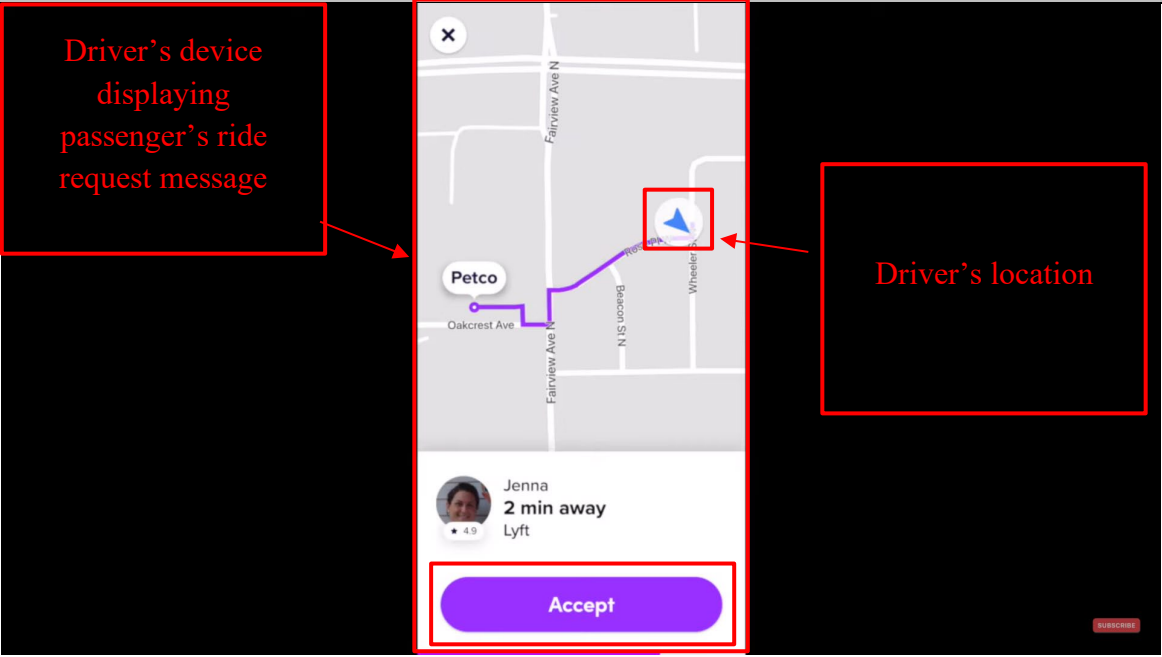
Claim 10,341,838	- Accused Products
	 <p>Driver's device displaying passenger's ride request message</p> <p>Driver's location</p> <p>https://www.youtube.com/watch?v=jVUy9poJDng at 10:24, Annotated</p>

Attachment A for US Patent No. 10,341,838 Against Lyft Accused Products

Claim 10,341,838	- Accused Products
	 <p data-bbox="1089 623 1415 737">Driver's location</p>

Attachment A for US Patent No. 10,341,838 Against Lyft Accused Products

Claim 10,341,838	- Accused Products
---------------------	--------------------

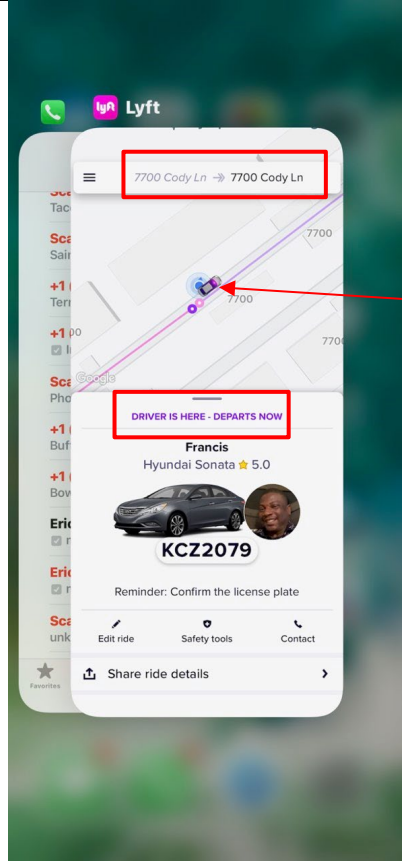

Driver's location

Provided certain conditions are met, users of the Rider and Driver Apps can share their location with other users of Driver and Rider Apps as well as additional contacts, friends, and family. Lyft encourages and instructs users of the Rider and Driver Apps to configure their phones to share their locations. The Driver and Rider Apps are pre-configured to show the location of riders and drivers and to update the locations continuously. For example, the Rider App provides rider locations to Lyft Servers in the forms of pickup locations and current locations and Lyft Servers transmit these locations to Driver Apps with ride requests and trip details. The Rider App can update the pickup locations and current locations and these location updates are similarly transmitted to Lyft Servers and

Attachment A for US Patent No. 10,341,838 Against Lyft Accused Products

Claim 10,341,838	- Accused Products
	<p>Driver Apps. In another example, the Driver App provides driver locations to Lyft Servers immediately during sign up or log in to the Driver App and continuously provides updates to the Lyft Servers before, during, and after rides. The Rider App can show the location of drivers before requesting a ride, after requesting a ride, after being matched with a particular driver, during the approach of the driver, and during the ride until the completion of the ride. In other circumstances, Rider and Driver Apps are configured by Lyft to permit users to share their locations with others by specifying contacts, friends, family members. In some instances, Lyft Servers create a link for distribution to others for access to maps containing shared locations from Lyft Servers. These shared locations permit others to track the locations of riders and drivers during rides provided by Lyft. Location sharing in Lyft's products also enables features to view and share trip progress and to track locations and computed routes. These features are built in to the Rider and Driver Apps and serviced by Lyft Servers.</p> <p>Further, to the extent this element is performed at least in part by Lyft's software source code, AGIS reserves the right to supplement these contentions pursuant to production of such source code by Lyft and to the extent Lyft requires additional information in accordance with P.R. 3-1 and for any other reasons.</p>
<p>1[G]. receiving participant location data provided by the second mobile device corresponding to the participant, wherein the participant location data are associated with the second identifier and</p>	<p>The Lyft Accused Products infringe directly and/or indirectly by performing, inducing others to perform, and/or contributing to the performance of: receiving participant location data provided by the second mobile device corresponding to the participant, wherein the participant location data are associated with the second identifier and indicate coordinates of a geographical location of the second mobile device.</p> <p>The Lyft server(s) perform this limitation when they receive rider location data associated with the account or identity information described above. This information is received at the Lyft server(s) via the Lyft app for riders. For example, when a passenger books a ride, the passenger's Lyft app for riders sends its current location coordinates to the Lyft servers enabling the servers to match the passenger with the nearby drivers. The location data of the passenger is associated with his/her account or identity data described above including but not limited to username, email address and phone number. The rider's location data comprises geographical coordinates or geotagged/geocoded/georeferenced information related to a rider's geographical location.</p>

Attachment A for US Patent No. 10,341,838 Against Lyft Accused Products

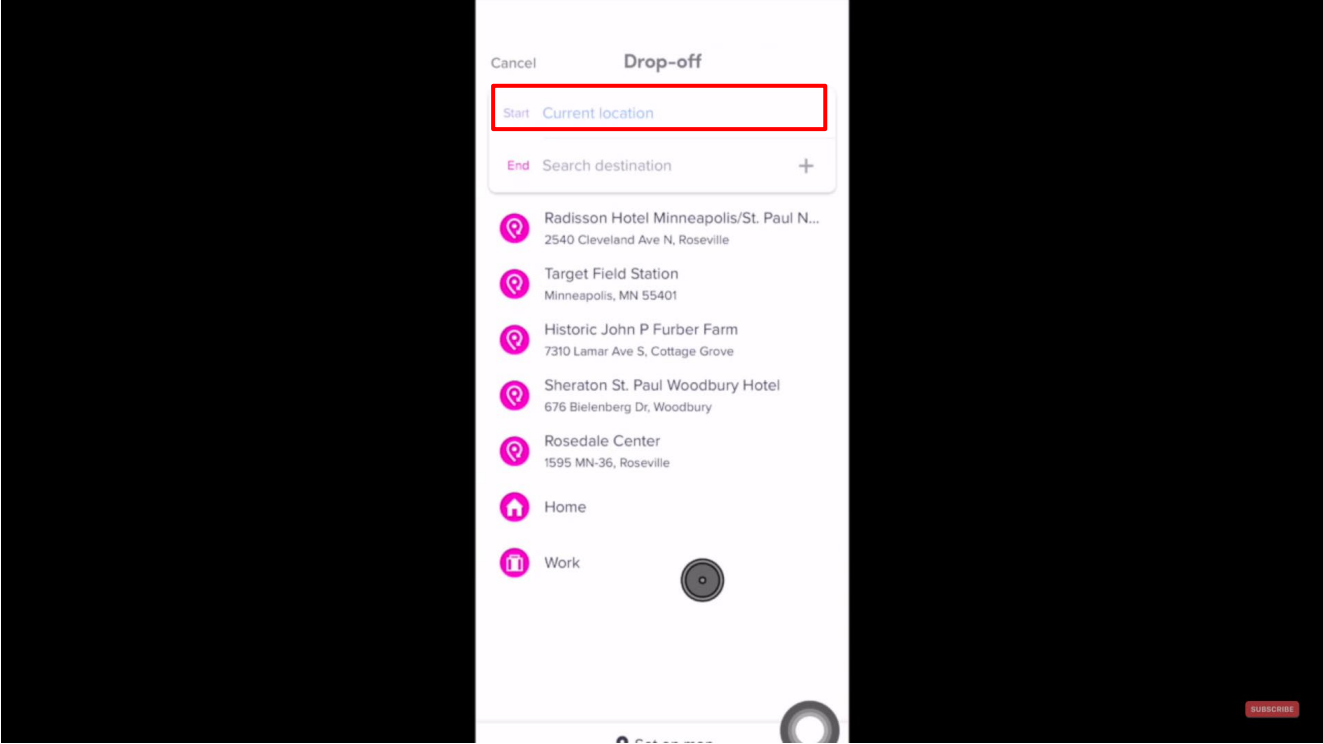
Claim 10,341,838	- Accused Products
indicate coordinates of a geographical location of the second mobile device	 <p>https://www.youtube.com/watch?v=j0RDMLcmOgU at 3:27</p>

Attachment A for US Patent No. 10,341,838 Against Lyft Accused Products

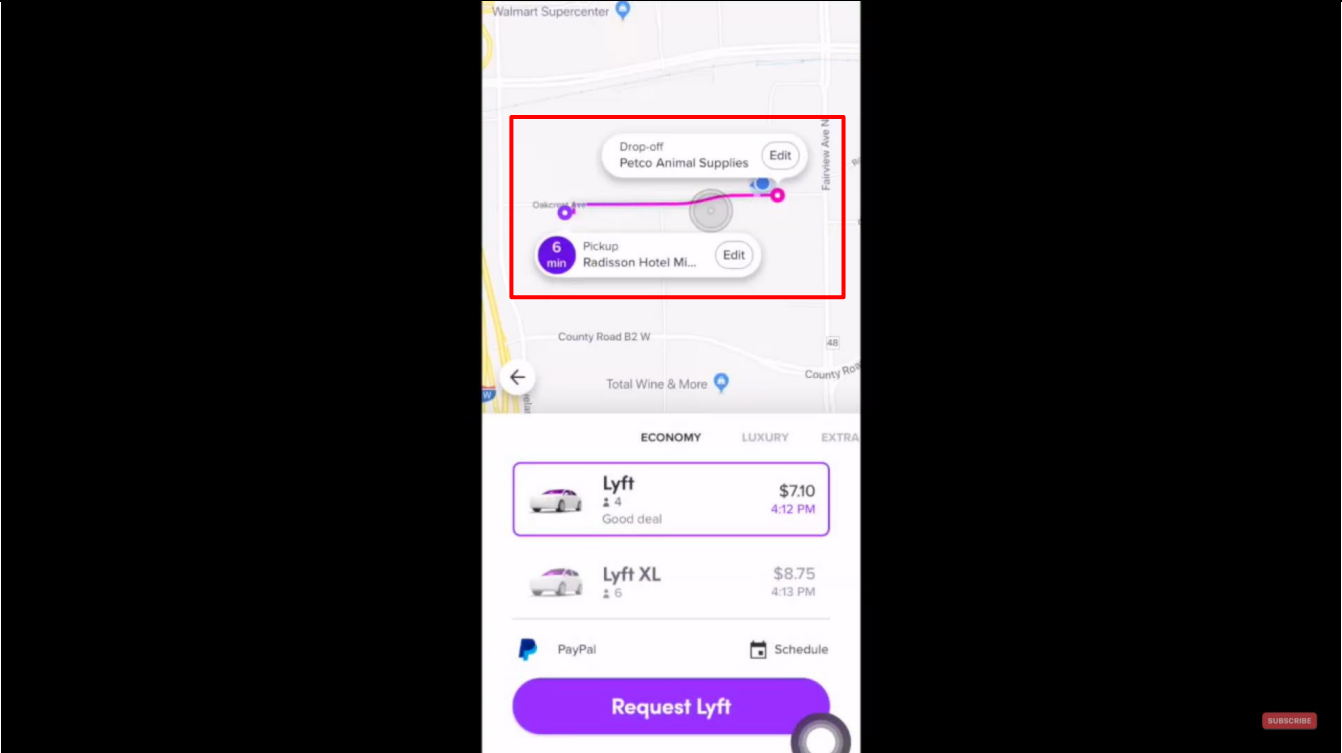
Claim 10,341,838	- Accused Products
	 <p>https://www.youtube.com/watch?v=j0RDMLcmOgU at 3:49</p>

Attachment A for US Patent No. 10,341,838 Against Lyft Accused Products

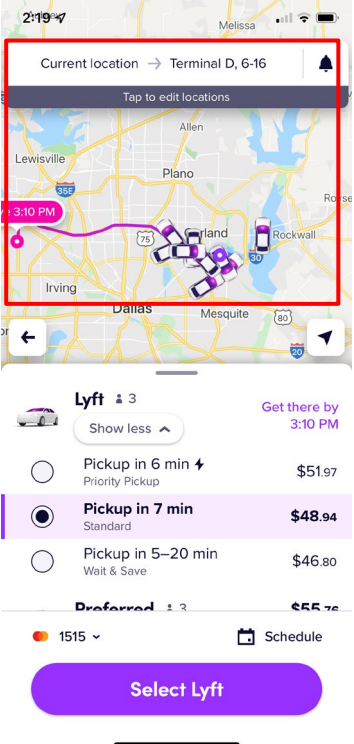
Claim 10,341,838	- Accused Products
	 <p>The screenshot displays the Lyft mobile application interface. At the top, the current location is set to 'Terminal D, 6-16'. Below this, a map shows the Dallas area with a highlighted route and a pickup time of 3:10 PM. The ride options list includes:</p> <ul style="list-style-type: none">Priority Pickup: Pickup in 6 min, \$51.97Standard: Pickup in 7 min, \$48.94 (Selected)Wait & Save: Pickup in 5-20 min, \$46.80Preferred: \$55.76 <p>Additional options include a carpooling choice for 1515 and a 'Schedule' button. A large purple 'Select Lyft' button is at the bottom.</p>

Attachment A for US Patent No. 10,341,838 Against Lyft Accused Products

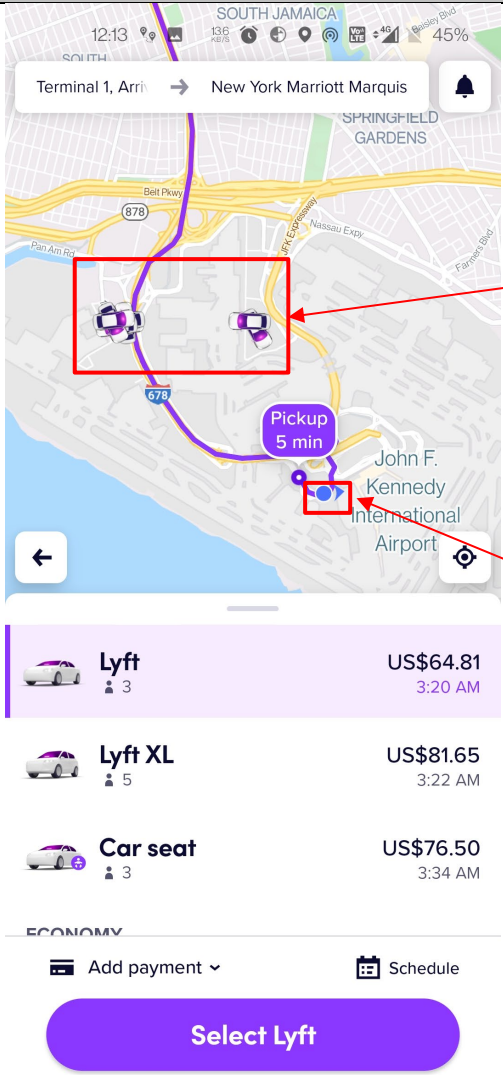
Claim 10,341,838	- Accused Products
	 <p>The screenshot shows the Lyft app interface. At the top, the map displays the route from Terminal 1, Arrivals to New York Marriott Marquis. A red box highlights two nearby driver icons on the map, with a red arrow pointing to a text box labeled "Nearby Drivers' location". Another red box highlights the passenger's location at John F. Kennedy International Airport, with a red arrow pointing to a text box labeled "Passenger's location". Below the map, three ride options are listed: Lyft (US\$64.81, 3:20 AM), Lyft XL (US\$81.65, 3:22 AM), and Car seat (US\$76.50, 3:34 AM). At the bottom, there are buttons for "Add payment", "Schedule", and a large purple "Select Lyft" button.</p>

Attachment A for US Patent No. 10,341,838 Against Lyft Accused Products

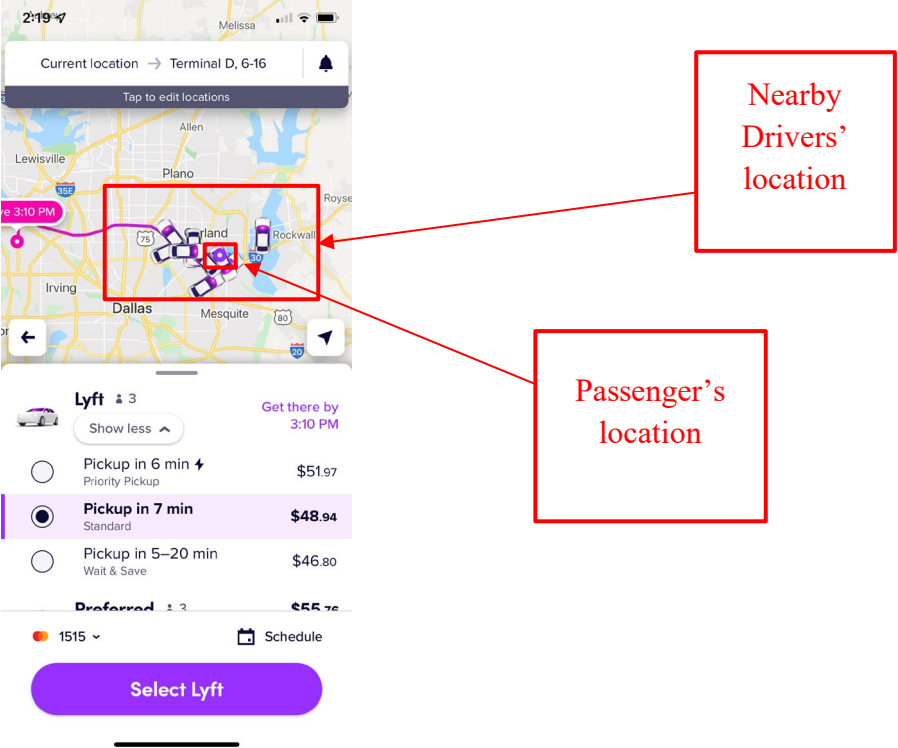
Claim 10,341,838	- Accused Products
	 <p data-bbox="430 1055 609 1096">See also 1[F].</p> <p data-bbox="430 1128 1904 1242">Further, to the extent this element is performed at least in part by Lyft's software source code, AGIS reserves the right to supplement these contentions pursuant to production of such source code by Lyft and to the extent Lyft requires additional information in accordance with P.R. 3-1 and for any other reasons.</p>
1[H]. sending participant data	The Lyft Accused Products infringe directly and/or indirectly by performing, inducing others to perform, and/or contributing to the performance of: sending participant data to the second mobile device corresponding to the

Attachment A for US Patent No. 10,341,838 Against Lyft Accused Products

Claim - 10,341,838	Accused Products
<p>to the second mobile device corresponding to the participant, wherein the participant data comprise the vehicle location data, wherein the second mobile device corresponding to the participant is configured to (1) determine coordinates of a position on the participant map corresponding to the coordinates of the geographical location of the second mobile device, (2) display the</p>	<p>participant, wherein the participant data comprise the vehicle location data, wherein the second mobile device corresponding to the participant is configured to (1) determine coordinates of a position on the participant map corresponding to the coordinates of the geographical location of the second mobile device, (2) display the participant map, and (3) place a first symbol on the participant map at the determined coordinates of the position on the participant map corresponding to the coordinates of the geographical location of the second mobile device.</p> <p>The Lyft server(s) communicates driver geographical location to the rider's Lyft app. The rider's Lyft app is programmed to receive the driver location data and process it to display a map with a symbol indicating the driver's location on the map. The rider's Lyft app includes instructions for placing the symbol at the map location corresponding to the geographical coordinates of the driver (i.e. its vehicle). For example, when the Lyft passenger uses the Lyft app, the passenger views the location of the vehicle/driver because the Lyft server(s) transmits the current location data of the drivers for display on a map showing nearby drivers' vehicles ("vehicle location data") as per their location coordinates. In another example, after the passenger requests a ride or begins a ride, the Lyft server(s) communicate the driver's location to the passenger's Lyft app for riders and this location is displayed as a symbol on the map to the passenger. Further, the Lyft app for riders determines the passenger location coordinates from the location data received from the server and adds a symbol corresponding to the coordinates on the map.</p>

Attachment A for US Patent No. 10,341,838 Against Lyft Accused Products

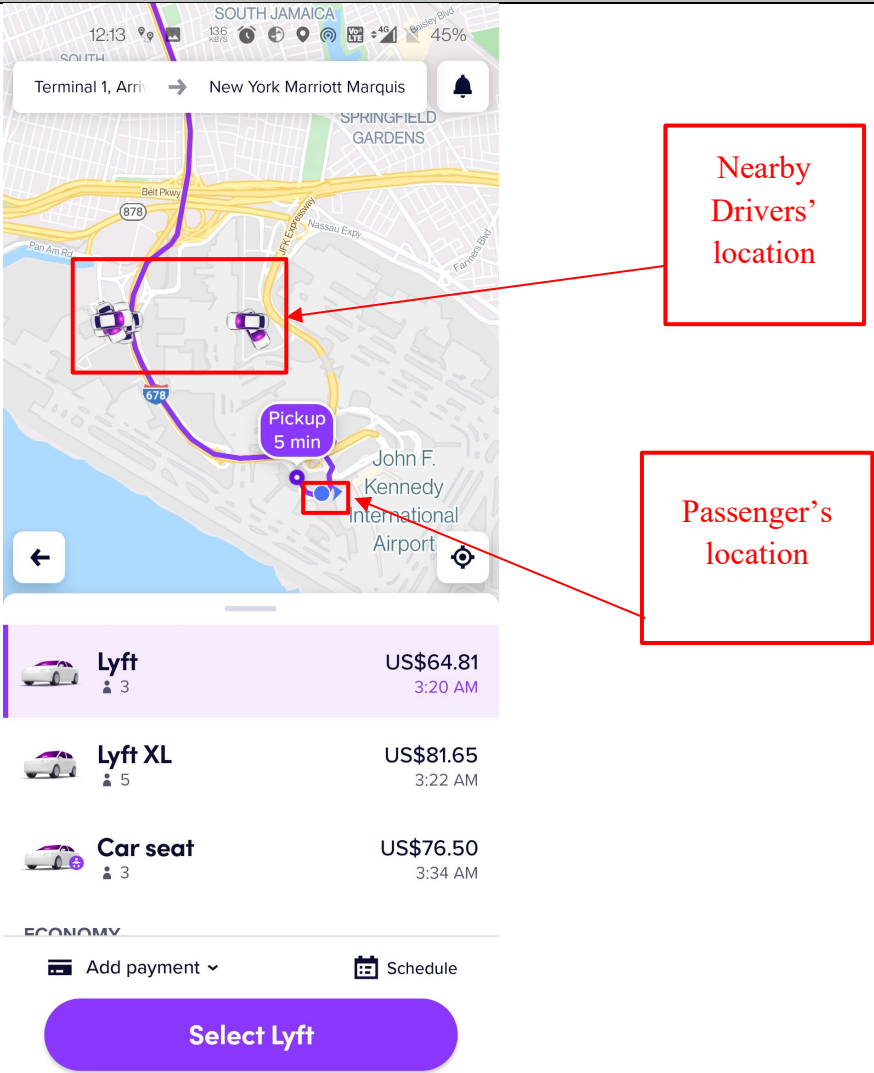
<p>Claim 10,341,838</p>	<p>- Accused Products</p>
<p>participant map, and (3) place a first symbol on the participant map at the determined coordinates of the position on the participant map corresponding to the coordinates of the geographical location of the second mobile device</p>	 <p>The screenshot shows a Lyft app interface. At the top, the destination is 'New York Marriott Marquis'. The map displays several driver icons (purple cars) and a passenger location icon (blue car) near John F. Kennedy International Airport. A 'Pickup 5 min' callout is visible. Below the map, three ride options are listed: 'Lyft' (US\$64.81, 3:20 AM), 'Lyft XL' (US\$81.65, 3:22 AM), and 'Car seat' (US\$76.50, 3:34 AM). At the bottom, there is a 'Select Lyft' button. Red boxes and arrows are overlaid on the image to identify specific elements: one box labeled 'Nearby Drivers' location' points to a cluster of driver icons, and another box labeled 'Passenger's location' points to the passenger icon.</p>

Attachment A for US Patent No. 10,341,838 Against Lyft Accused Products

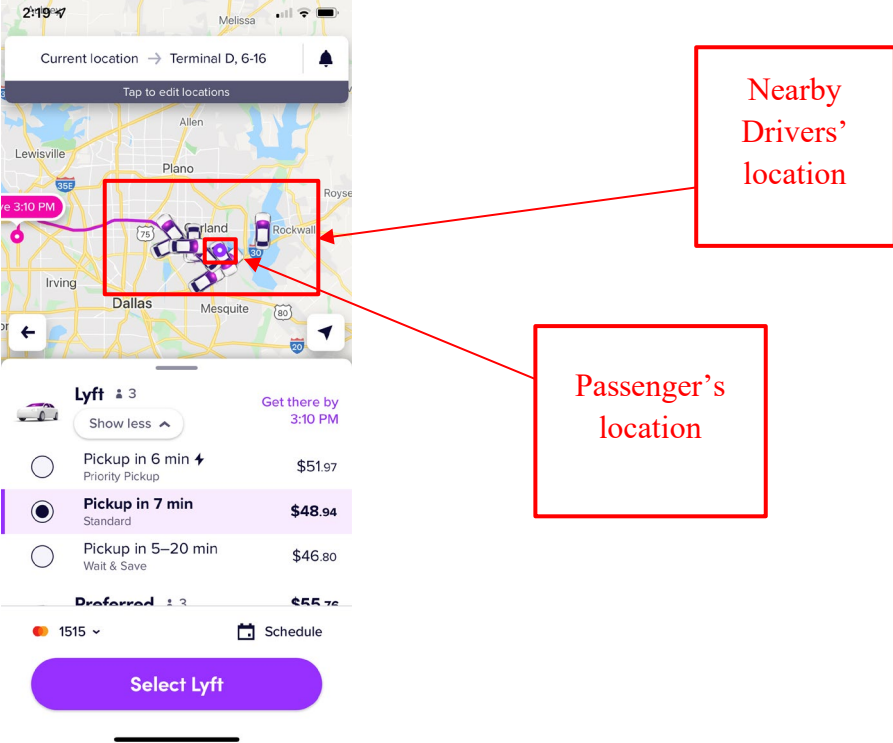
Claim 10,341,838	- Accused Products
	 <p>Further, to the extent this element is performed at least in part by Lyft's software source code, AGIS reserves the right to supplement these contentions pursuant to production of such source code by Lyft and to the extent Lyft requires additional information in accordance with P.R. 3-1 and for any other reasons.</p>
<p>1[I]. sending vehicle data to the first mobile device corresponding</p>	<p>The Lyft Accused Products infringe directly and/or indirectly by performing, inducing others to perform, and/or contributing to the performance of: sending vehicle data to the first mobile device corresponding to the vehicle, wherein the vehicle data comprise the participant location data, wherein the first mobile device corresponding to the vehicle is configured to (1) determine coordinates of a position on the vehicle map corresponding to the coordinates of the geographical location of the first mobile device, (2) display the vehicle map, and (3) place a</p>

Attachment A for US Patent No. 10,341,838 Against Lyft Accused Products

Claim - 10,341,838	Accused Products
<p>to the vehicle, wherein the vehicle data comprise the participant location data, wherein the first mobile device corresponding to the vehicle is configured to (1) determine coordinates of a position on the vehicle map corresponding to the coordinates of the geographical location of the first mobile device, (2) display the vehicle map, and (3) place a second symbol on the vehicle map at the determined</p>	<p>second symbol on the vehicle map at the determined coordinates of the position on the vehicle map corresponding to the coordinates of the geographical location of the first mobile device;</p> <p>The Lyft server(s) communicates rider/passenger geographical location to the driver's Lyft app. The driver's Lyft app is programmed to receive the driver location data and process it to display a map with a symbol indicating the rider's location on the map. The driver's Lyft app includes instructions for placing the symbol at the map location corresponding to the geographical coordinates of the rider.</p> <p>For example, when the Lyft driver uses the Lyft app, the driver can see the location of a passenger/rider because the server transmits the location data of the passenger/rider. The driver, when using the Lyft app for drivers, receives messages from the passengers requesting rides. The message comprises the passenger's location on the map. The Driver's Lyft app determines the location coordinates from the rider location data received from the Lyft server and places a symbol corresponding to the coordinates of the rider's location on the map in the driver's Lyft app.</p>

Attachment A for US Patent No. 10,341,838 Against Lyft Accused Products

Claim 10,341,838	- Accused Products
<p>coordinates of the position on the vehicle map corresponding to the coordinates of the geographical location of the first mobile device</p>	<div data-bbox="430 267 1585 917" style="text-align: center;"> </div> <p>https://www.youtube.com/watch?v=jVUy9poJDng at 10:24, Annotated</p> <p>See also 1[F].</p> <p>Further, to the extent this element is performed at least in part by Lyft's software source code, AGIS reserves the right to supplement these contentions pursuant to production of such source code by Lyft and to the extent Lyft requires additional information in accordance with P.R. 3-1 and for any other reasons.</p>
<p>1[J]. receiving participant selection data</p>	<p>The Lyft Accused Products infringe directly and/or indirectly by performing, inducing others to perform, and/or contributing to the performance of: receiving participant selection data provided by the second mobile device</p>

Attachment A for US Patent No. 10,341,838 Against Lyft Accused Products

Claim 10,341,838	- Accused Products
<p>provided by the second mobile device corresponding to the participant, the participant selection data corresponding to user input provided via a display of the second mobile device</p>	<p>corresponding to the participant, the participant selection data corresponding to user input provided via a display of the second mobile device.</p> <p>The Lyft server(s) receives data indicating input from the rider/passenger via the Lyft app for riders. For example, the Lyft passenger provides input specifying a pickup location (current location or any specific location) and destination when booking a ride or specifying a change/update to a ride such as adding a stop or changing a pickup or destination. This input is the only participant selection data. .</p> <div data-bbox="428 631 1745 1373" data-label="Image"> </div> <p>https://www.youtube.com/watch?v=j0RDMLcmOgU at 3:27</p>

Attachment A for US Patent No. 10,341,838 Against Lyft Accused Products

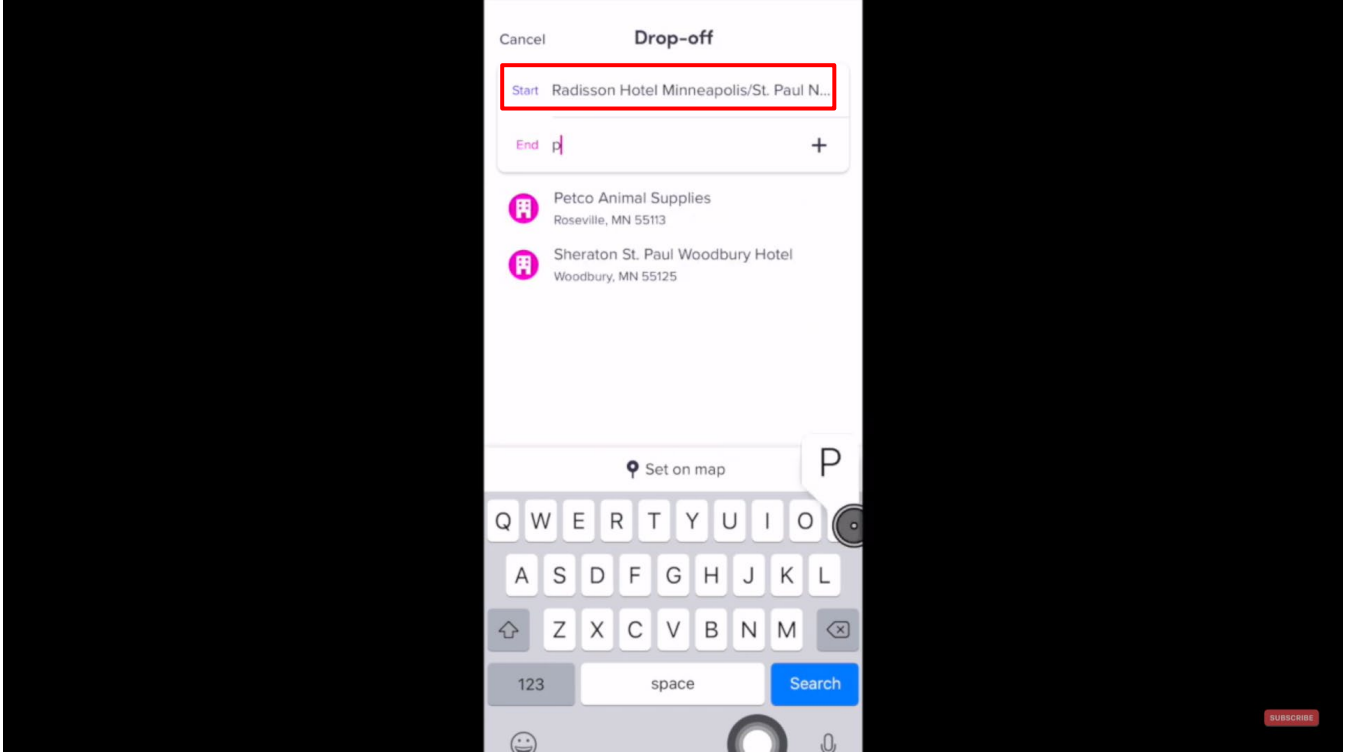
Claim 10,341,838	- Accused Products
	 <p>https://www.youtube.com/watch?v=j0RDMLcmOgU at 3:43</p>

Attachment A for US Patent No. 10,341,838 Against Lyft Accused Products

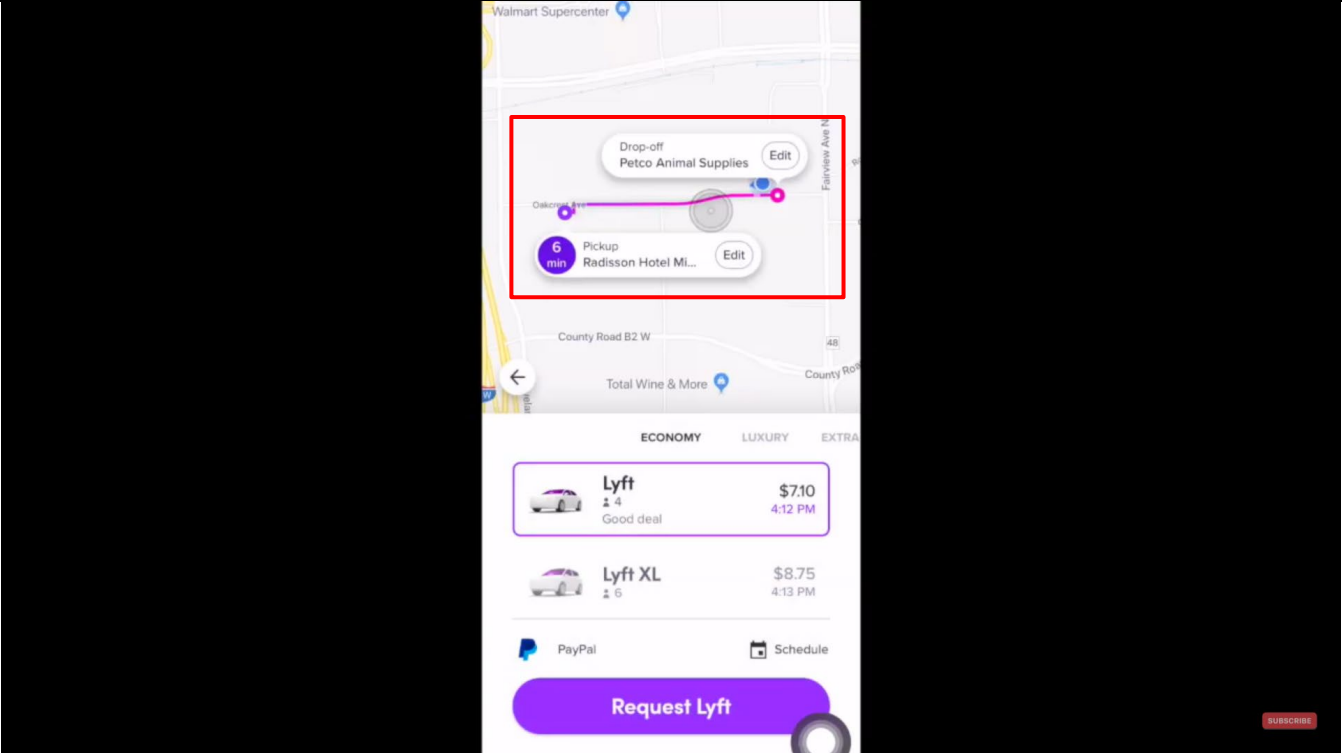
Claim 10,341,838	- Accused Products
	 <p>https://www.youtube.com/watch?v=j0RDMLcmOgU at 3:49</p> <p>Further, to the extent this element is performed at least in part by Lyft's software source code, AGIS reserves the right to supplement these contentions pursuant to production of such source code by Lyft and to the extent Lyft requires additional information in accordance with P.R. 3-1 and for any other reasons.</p>
1[K]. based on the participant	The Lyft Accused Products infringe directly and/or indirectly by performing, inducing others to perform, and/or contributing to the performance of: based on the participant selection data, performing one or more acts selected

Attachment A for US Patent No. 10,341,838 Against Lyft Accused Products

Claim - 10,341,838	Accused Products
<p>selection data, performing one or more acts selected from the group consisting of: sending updated vehicle data to the first mobile device corresponding to the vehicle, sending updated participant data to the second mobile device corresponding to the participant, and sending a message to the first mobile device corresponding to the vehicle</p>	<p>from the group consisting of: sending updated vehicle data to the first mobile device corresponding to the vehicle, sending updated participant data to the second mobile device corresponding to the participant, and sending a message to the first mobile device corresponding to the vehicle.</p> <p>The Lyft server(s) communicate data based on the rider's user input selections described above in 1[J]. The following are the only acts performed in response to receiving participant selection data identified in 1[J]. The Lyft server(s) communicates location/ride/status data and updates for the driver/vehicle to the passenger/rider; the Lyft server(s) also communicates location/ride/status and updates for the rider/passenger to the driver/vehicle. The Lyft server(s) also communicates messages from the rider to the driver as described above. The Lyft server(s) also communicates updated locations via messages to the rider/driver and updated directions/routes to the driver. The Lyft server(s) communications are sent to the Lyft apps for driver and/or rider. There are no other acts that can be performed based on the identified participant selection data in 1[J].</p> <p>Further, to the extent this element is performed at least in part by Lyft's software source code, AGIS reserves the right to supplement these contentions pursuant to production of such source code by Lyft and to the extent Lyft requires additional information in accordance with P.R. 3-1 and for any other reasons.</p>
<p>1[L]. receiving entity-of-interest data transmitted by</p>	<p>The Lyft Accused Products infringe directly and/or indirectly by performing, inducing others to perform, and/or contributing to the performance of: receiving entity-of-interest data transmitted by the second mobile device, the entity-of-interest data comprising coordinates of a geographical location of a new entity of interest, wherein the second mobile device is configured to (1) identify participant interaction with a display of the second mobile device,</p>

Attachment A for US Patent No. 10,341,838 Against Lyft Accused Products

Claim - 10,341,838	Accused Products
<p>the second mobile device, the entity-of-interest data comprising coordinates of a geographical location of a new entity of interest, wherein the second mobile device is configured to (1) identify participant interaction with a display of the second mobile device, the participant interaction indicating selection of a position on the participant map and entry of the new entity of interest at the selected position, (2)</p>	<p>the participant interaction indicating selection of a position on the participant map and entry of the new entity of interest at the selected position, (2) display an entity symbol representing the new entity of interest at the selected position on the participant map, (3) determine coordinates of a geographical location of the new entity of interest based on coordinates of the selected position on the participant map, and (4) transmit the entity-of-interest data.</p> <p>The Lyft server(s) performs this limitation because it receives user input data regarding pickups, stops or destinations entered by a user and those pickups, stops or destinations correspond to geographical locations on a map. For example, the Lyft passenger uses the Lyft app for riders to select a pickup location and a destination location. The Lyft passenger can add entities of interest and select one or more entities of interest as a pickup or destination. The Lyft passenger can choose the pickup/stop/destination location by entering an address/location/shortcut or by choosing it on a map which will add/enter a symbol on the map and the passenger can change the location of the added/enter symbol to specify the location of the added/entered symbol as a pickup/stop/destination. Each of these methods will cause a symbol corresponding to the pickup/stop/destination to be added/entered on the map at the corresponding location. When the passenger completes this process, data associated with the added/entered symbol as a pickup/stop/destination is communicated to the Lyft server(s). Adding/entering the symbol for a pickup/stop/destination can occur before or during a ride.</p> <p>The passenger provides the pickup location (current address or any specific location) and the destination when booking a ride using the Lyft app for riders indicating selection of a position on the map and entry of the entity at that position. The Lyft passenger can add a second stop or destination via user input in the Lyft app for riders. The Lyft app for riders receives user input regarding the selected location, displays a symbol on the map and determines the geographical location corresponding to the selected location and its coordinates. The rider is also able to edit or add additional stops/destinations and change the order of stops/destinations. The stops/destinations are displayed on the map using symbols.</p>

Attachment A for US Patent No. 10,341,838 Against Lyft Accused Products

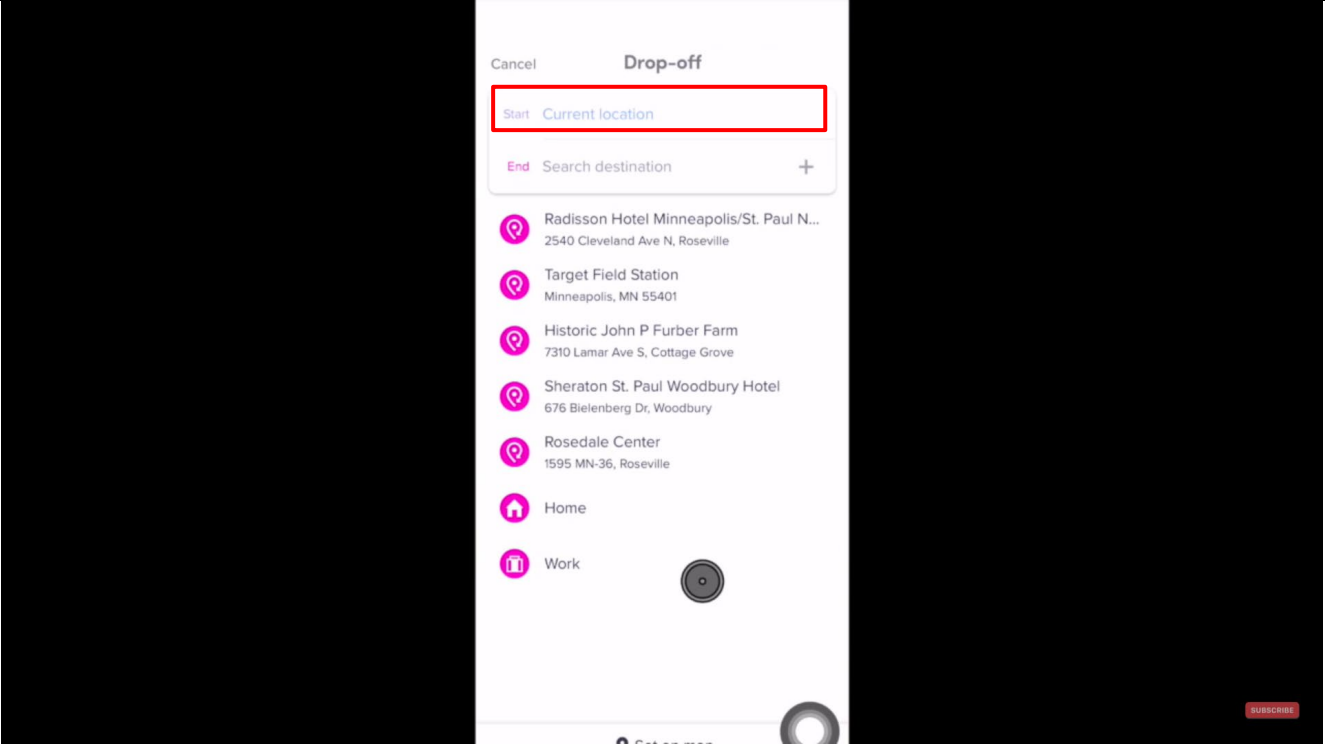
Claim 10,341,838	- Accused Products
<p>display an entity symbol representing the new entity of interest at the selected position on the participant map, (3) determine coordinates of a geographical location of the new entity of interest based on coordinates of the selected position on the participant map, and (4) transmit the entity-of-interest data; and</p>	 <p>https://www.youtube.com/watch?v=j0RDMLcmOgU at 3:27</p>

Attachment A for US Patent No. 10,341,838 Against Lyft Accused Products

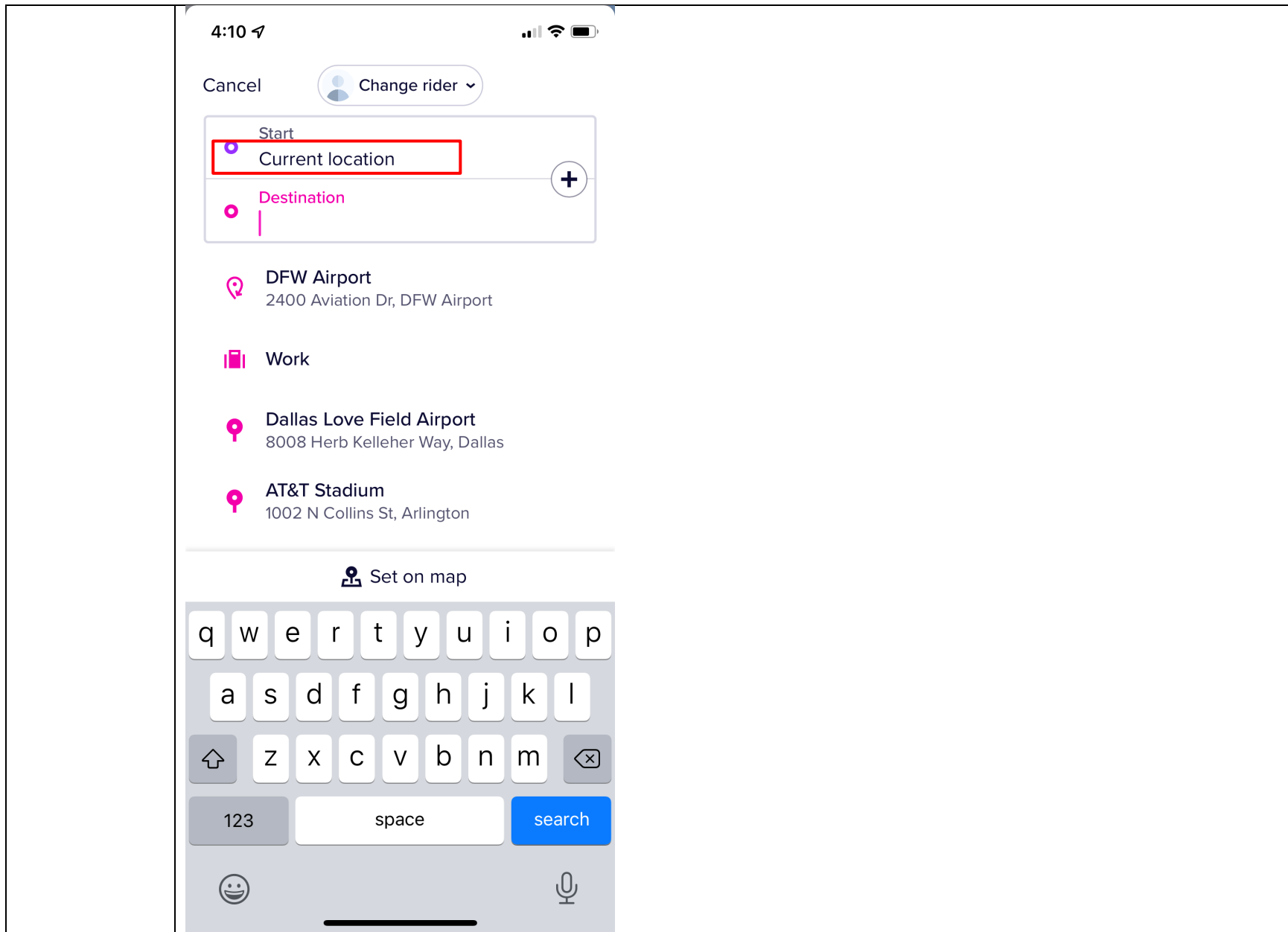

Attachment A for US Patent No. 10,341,838 Against Lyft Accused Products

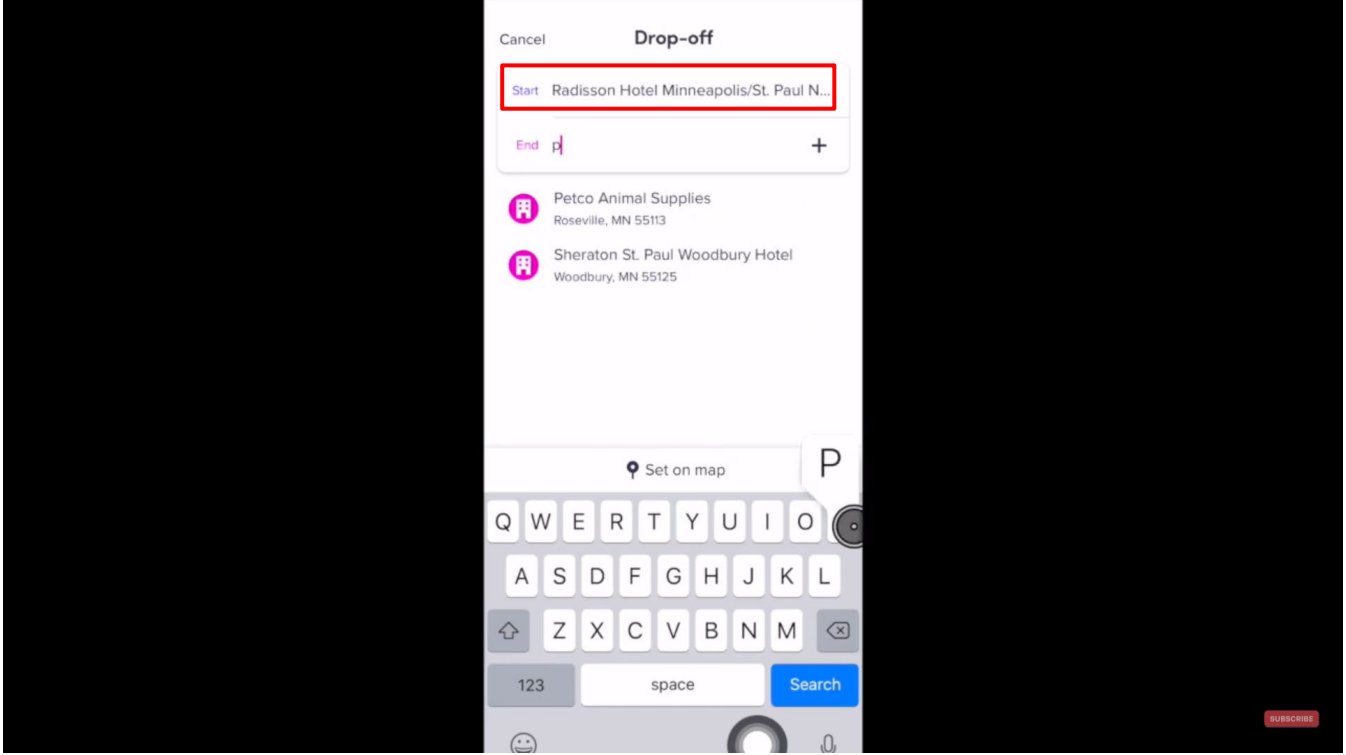
Claim 10,341,838	- Accused Products
	 <p>https://www.youtube.com/watch?v=j0RDMLcmOgU at 3:43</p>

Attachment A for US Patent No. 10,341,838 Against Lyft Accused Products

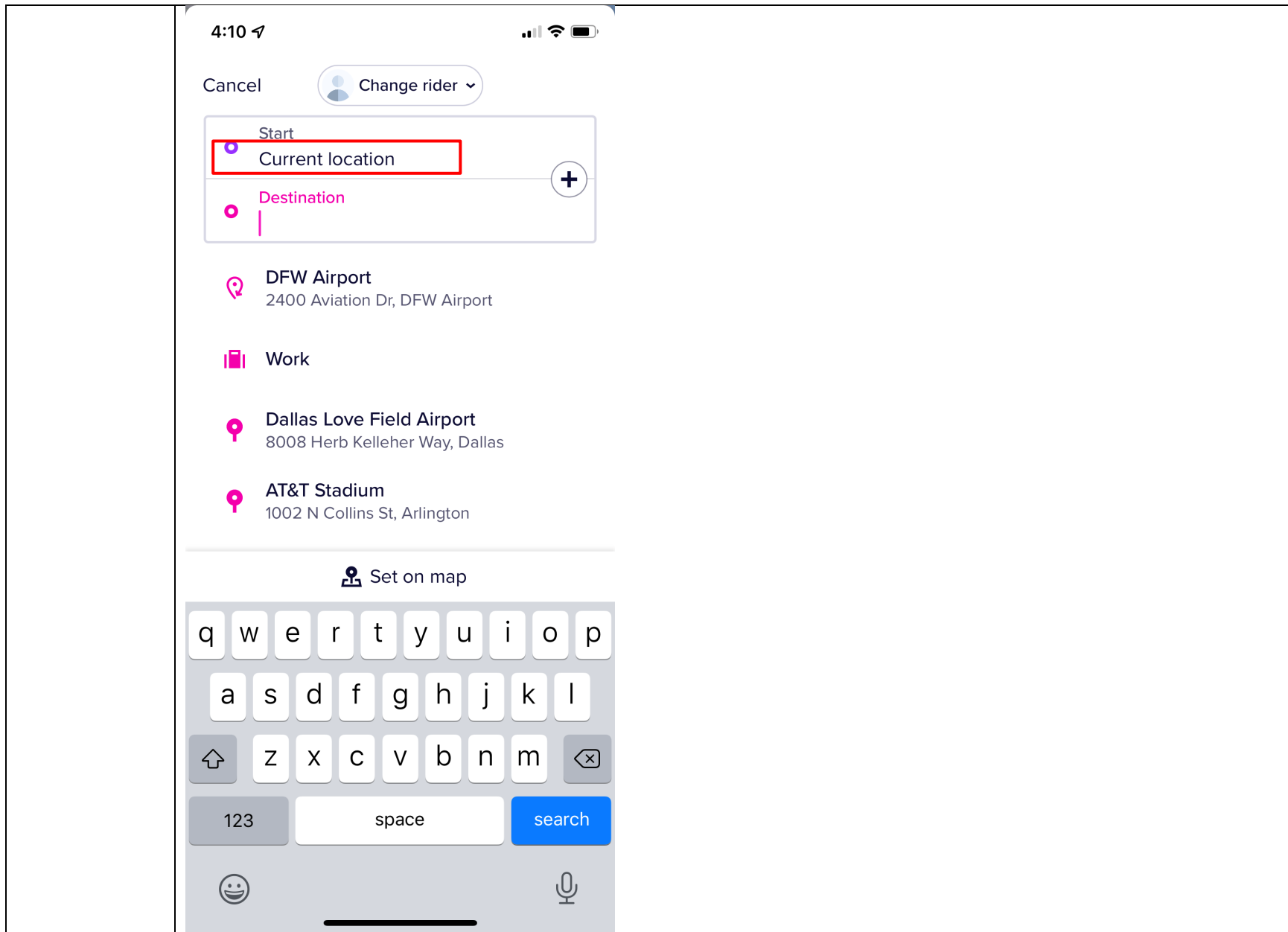

Attachment A for US Patent No. 10,341,838 Against Lyft Accused Products

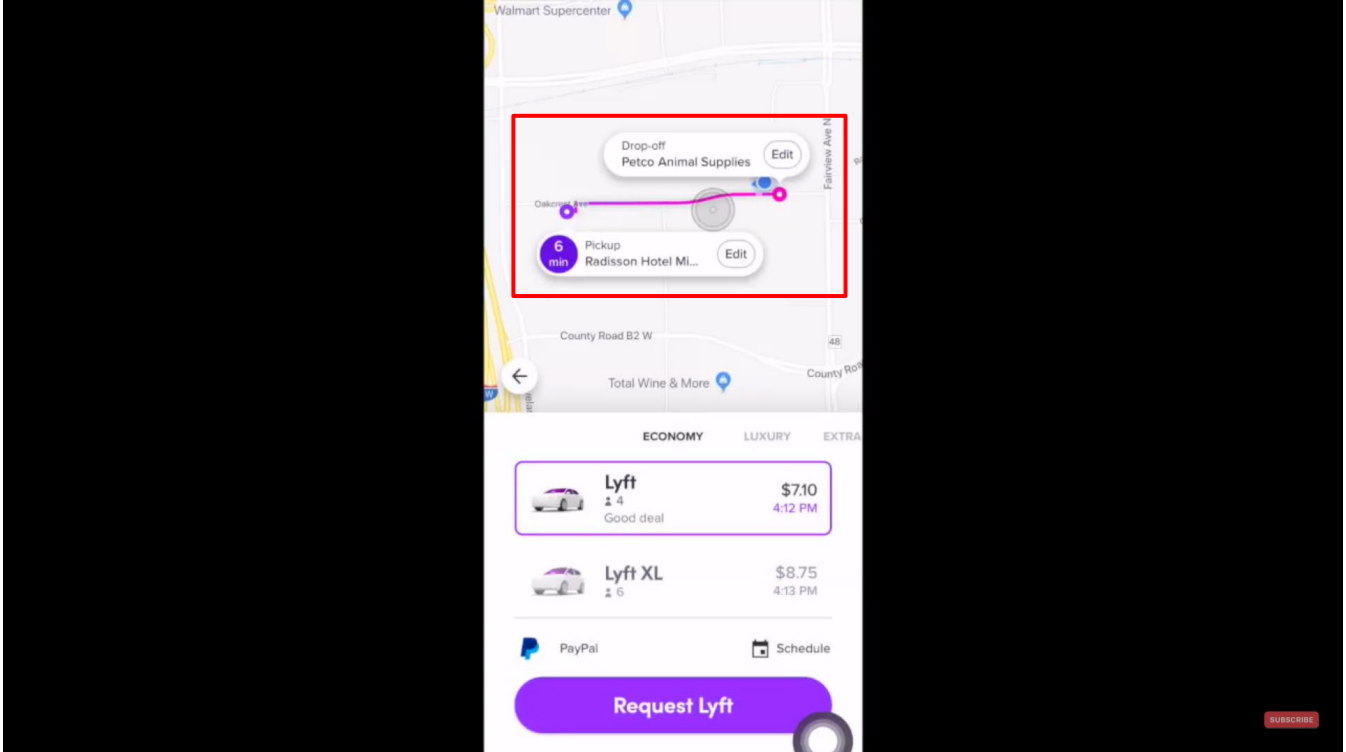
Claim 10,341,838	- Accused Products
	 <p>https://www.youtube.com/watch?v=j0RDMLcmOgU at 3:49</p>

Attachment A for US Patent No. 10,341,838 Against Lyft Accused Products

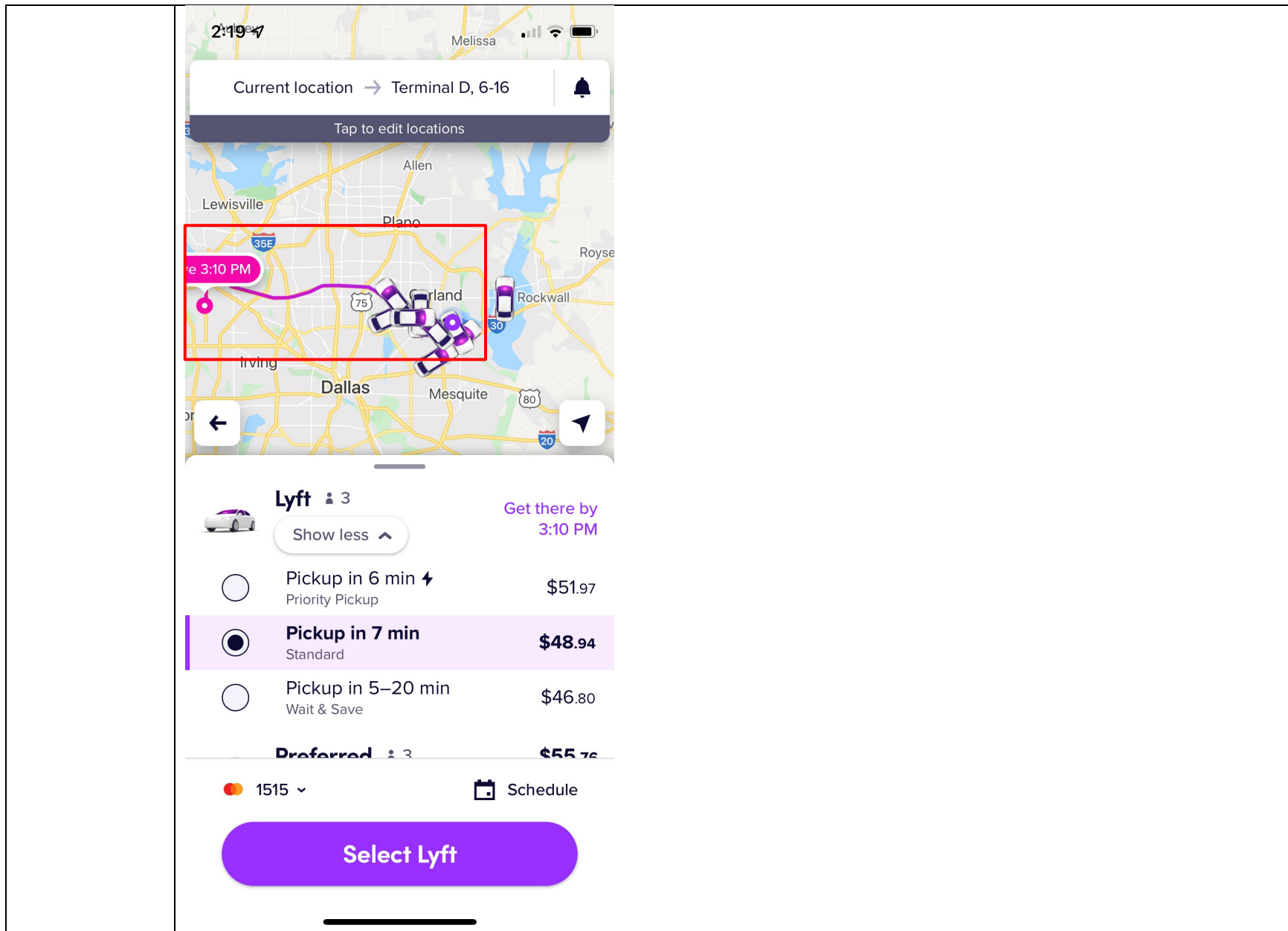

Attachment A for US Patent No. 10,341,838 Against Lyft Accused Products

Claim 10,341,838	- Accused Products
	Further, to the extent this element is performed at least in part by Lyft's software source code, AGIS reserves the right to supplement these contentions pursuant to production of such source code by Lyft and to the extent Lyft requires additional information in accordance with P.R. 3-1 and for any other reasons.
1[M]. sending the entity-of-interest data to the first mobile device corresponding to the vehicle, wherein the first mobile device is configured to place the entity symbol representing the new entity of interest on the vehicle map at a position on the vehicle map corresponding to the geographical location of the new entity of interest.	<p>The Lyft Accused Products infringe directly and/or indirectly by performing, inducing others to perform, and/or contributing to the performance of: sending the entity-of-interest data to the first mobile device corresponding to the vehicle, wherein the first mobile device is configured to place the entity symbol representing the new entity of interest on the vehicle map at a position on the vehicle map corresponding to the geographical location of the new entity of interest.</p> <p>The Lyft server(s) performs this limitation because the Lyft server(s) communicate data corresponding to the added/entered pickup/stops/destinations to the Lyft app of the driver and symbols are placed at the geographical locations corresponding to the added/entered pickup/destinations/stops. This can occur before or during the acceptance of the ride. The added/entered symbols are displayed on the map at the Lyft app for drivers.</p>

Attachment A for US Patent No. 10,341,838 Against Lyft Accused Products

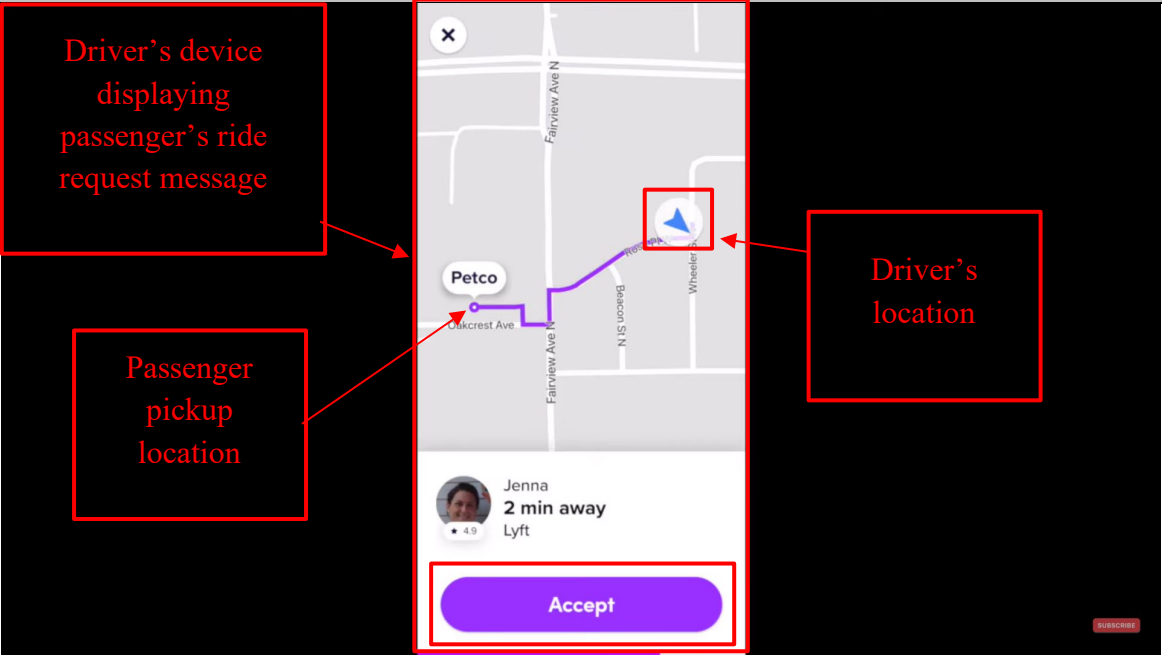
Claim 10,341,838	- Accused Products
	 <p>Driver's device displaying passenger's ride request message</p> <p>Passenger pickup location</p> <p>Driver's location</p> <p>Accept</p> <p>https://www.youtube.com/watch?v=jVUy9poJDng at 10:24, Annotated</p>

Attachment A for US Patent No. 10,341,838 Against Lyft Accused Products

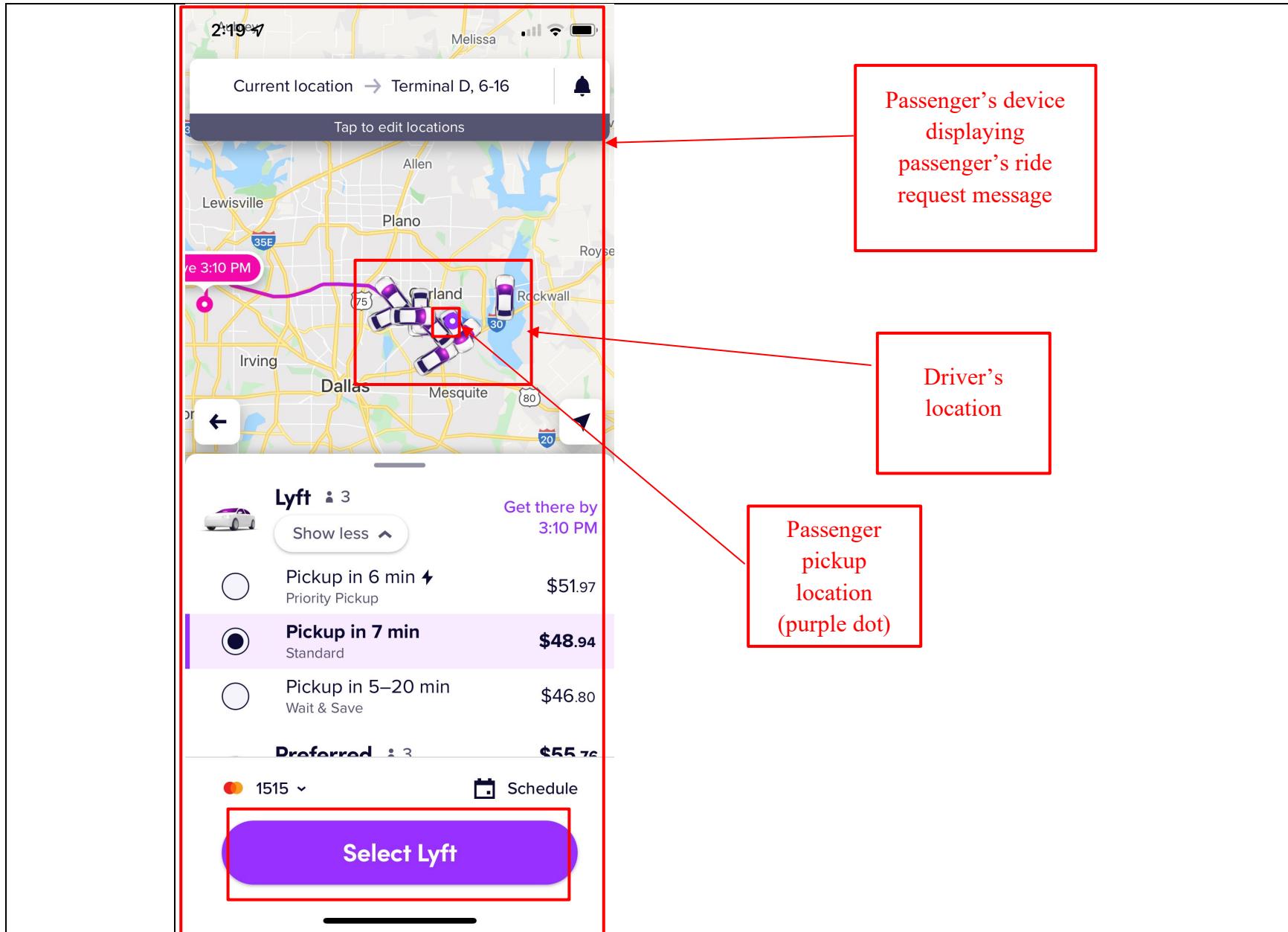

Attachment A for US Patent No. 10,341,838 Against Lyft Accused Products

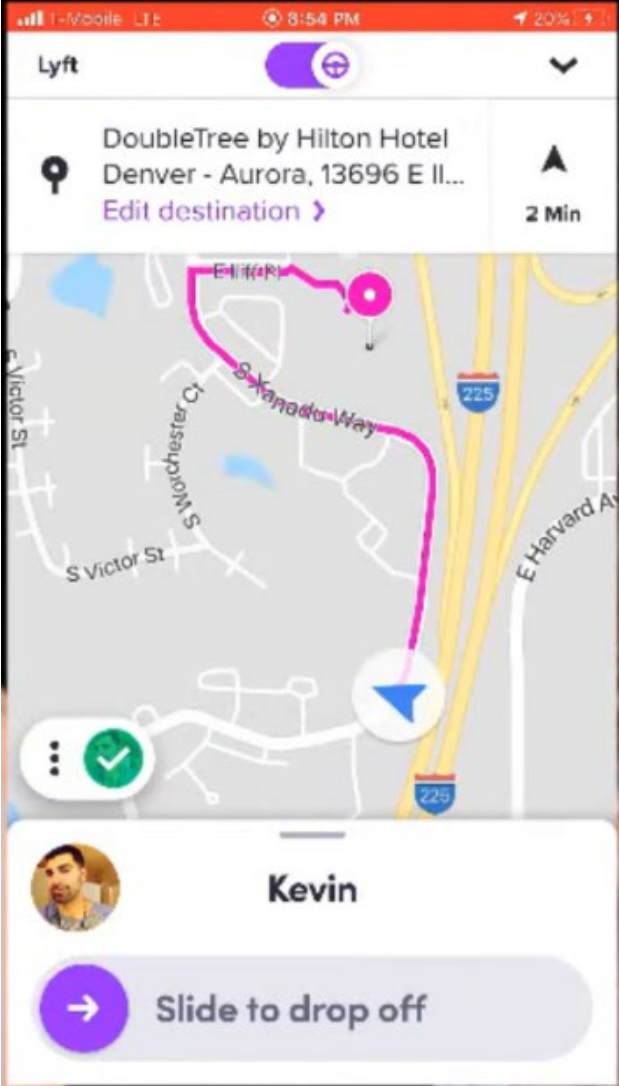
Claim 10,341,838	- Accused Products
	 <p>The screenshot shows the Lyft mobile application interface. At the top, the status bar displays 'T-Mobile LTE', '8:54 PM', and '20%' battery. The app header includes the Lyft logo, a toggle switch, and a dropdown arrow. The destination is set to 'DoubleTree by Hilton Hotel Denver - Aurora, 13696 E Il...' with an 'Edit destination' link and a '2 Min' estimated time. The map shows a route in pink starting from a location near S Victor St and S Manchester Ct, heading east on S Kananda Way, then turning south onto I-225, and finally east onto E Harvard Ave. A driver profile for 'Kevin' is shown at the bottom, with a 'Slide to drop off' button.</p> <p>https://www.youtube.com/watch?v=b31WorLlcqE at 9:40</p>



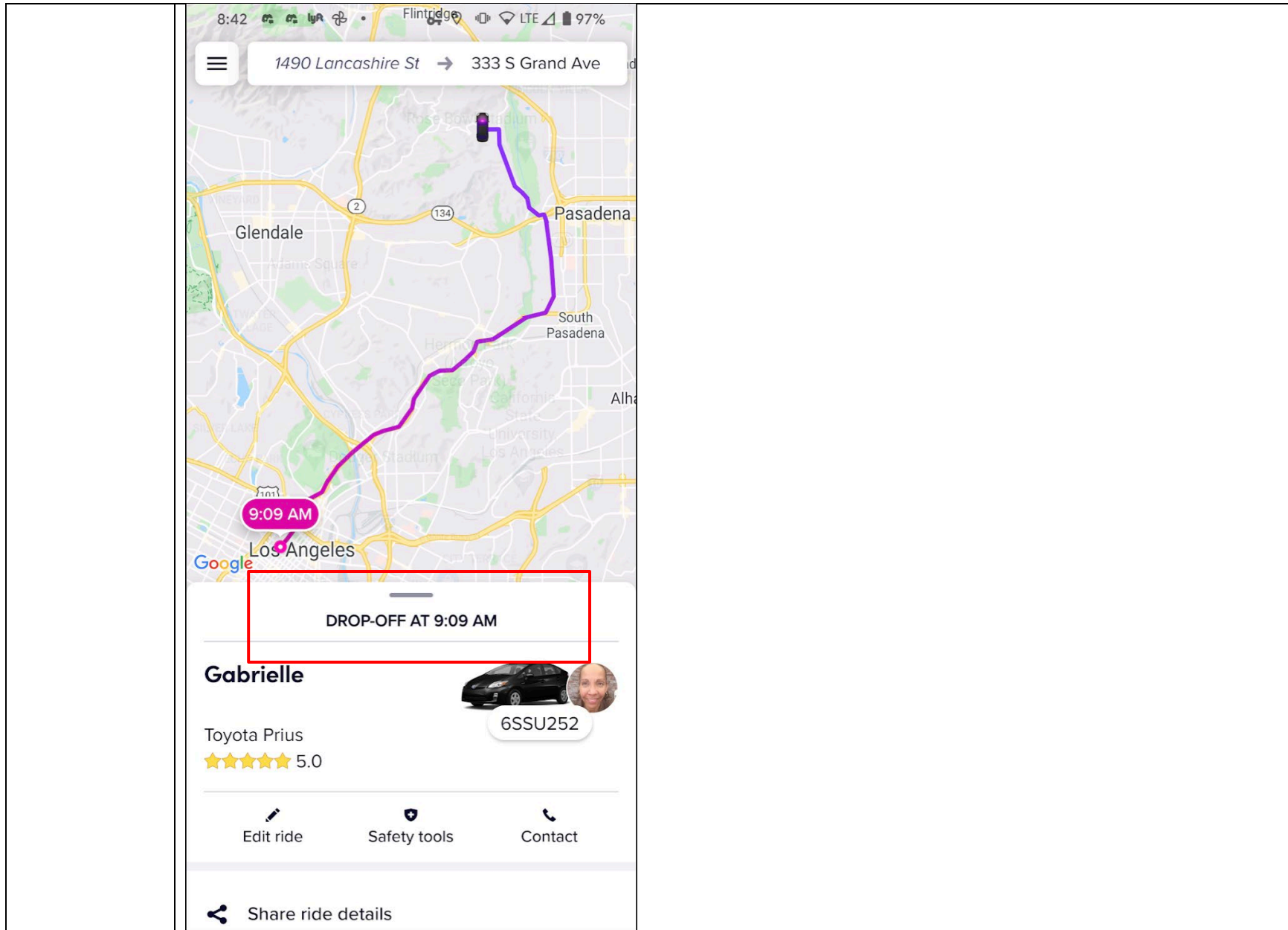





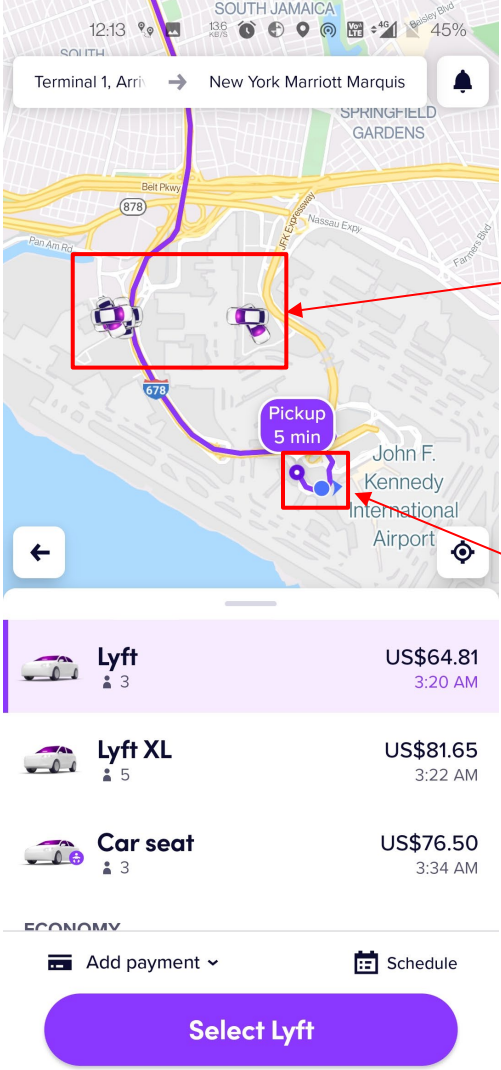

Attachment A for US Patent No. 10,341,838 Against Lyft Accused Products



Attachment A for US Patent No. 10,341,838 Against Lyft Accused Products

Claim 10,341,838	- Accused Products
	Further, to the extent this element is performed at least in part by Lyft's software source code, AGIS reserves the right to supplement these contentions pursuant to production of such source code by Lyft and to the extent Lyft requires additional information in accordance with P.R. 3-1 and for any other reasons.
2. The method of claim 1, wherein performing the one or more acts comprises sending, based on the participant selection data, the updated participant data to the second mobile device corresponding to the participant, wherein the second mobile device is configured to display the updated participant data within the	<p>The Lyft Accused Products infringe directly and/or indirectly by performing, inducing others to perform, and/or contributing to the performance of: wherein performing the one or more acts comprises sending, based on the participant selection data, the updated participant data to the second mobile device corresponding to the participant, wherein the second mobile device is configured to display the updated participant data within the participant map.</p> <p>See claims 1[F] and 1[H]. The Lyft server(s) meets this limitation because it sends updated driver/vehicle locations to the Lyft app for riders and that updated driver/vehicle location is provided for display to the rider via the Lyft app. For example, while the passenger is booking a ride, the server sends the updated current location of the vehicle to the passenger's Lyft app. The updated current location of the vehicle is loaded on the map in the Lyft app. The server also highlights the pickup location and destination address on the map in the Lyft app.</p>

Attachment A for US Patent No. 10,341,838 Against Lyft Accused Products

Claim 10,341,838	- Accused Products						
participant map.	 <p data-bbox="1087 386 1287 586">Nearby Drivers' location</p> <p data-bbox="1066 711 1350 902">Passenger's current location (blue dot) and pickup location</p> <table border="1" data-bbox="428 886 926 1187"><tbody><tr><td> Lyft</td><td>US\$64.81 3:20 AM</td></tr><tr><td> Lyft XL</td><td>US\$81.65 3:22 AM</td></tr><tr><td> Car seat</td><td>US\$76.50 3:34 AM</td></tr></tbody></table> <p data-bbox="449 1187 926 1203">ECONOMY</p> <p data-bbox="470 1211 884 1235">Add payment Schedule</p> <p data-bbox="470 1256 884 1333">Select Lyft</p>	 Lyft	US\$64.81 3:20 AM	 Lyft XL	US\$81.65 3:22 AM	 Car seat	US\$76.50 3:34 AM
 Lyft	US\$64.81 3:20 AM						
 Lyft XL	US\$81.65 3:22 AM						
 Car seat	US\$76.50 3:34 AM						

Attachment A for US Patent No. 10,341,838 Against Lyft Accused Products

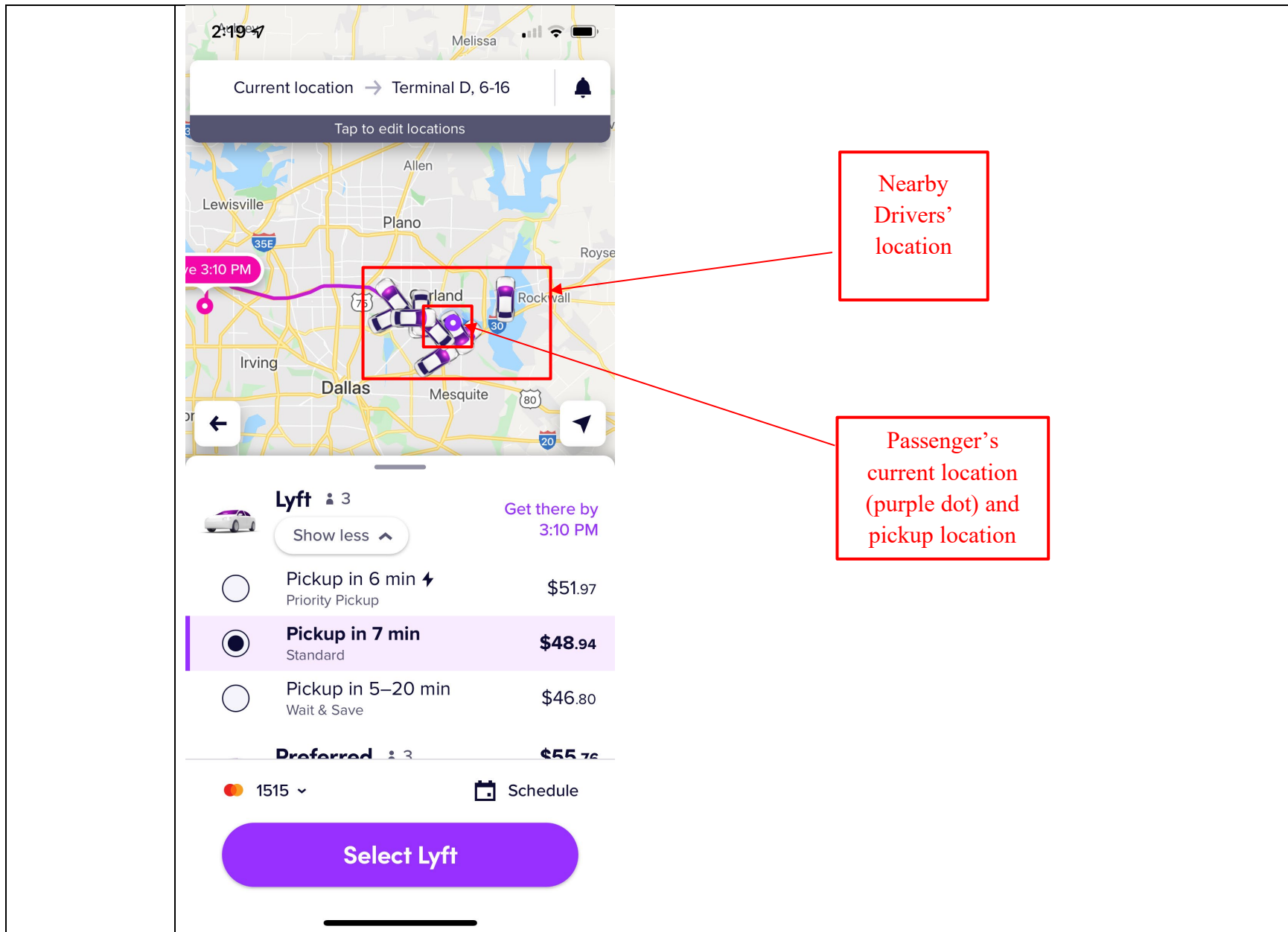

Attachment A for US Patent No. 10,341,838 Against Lyft Accused Products

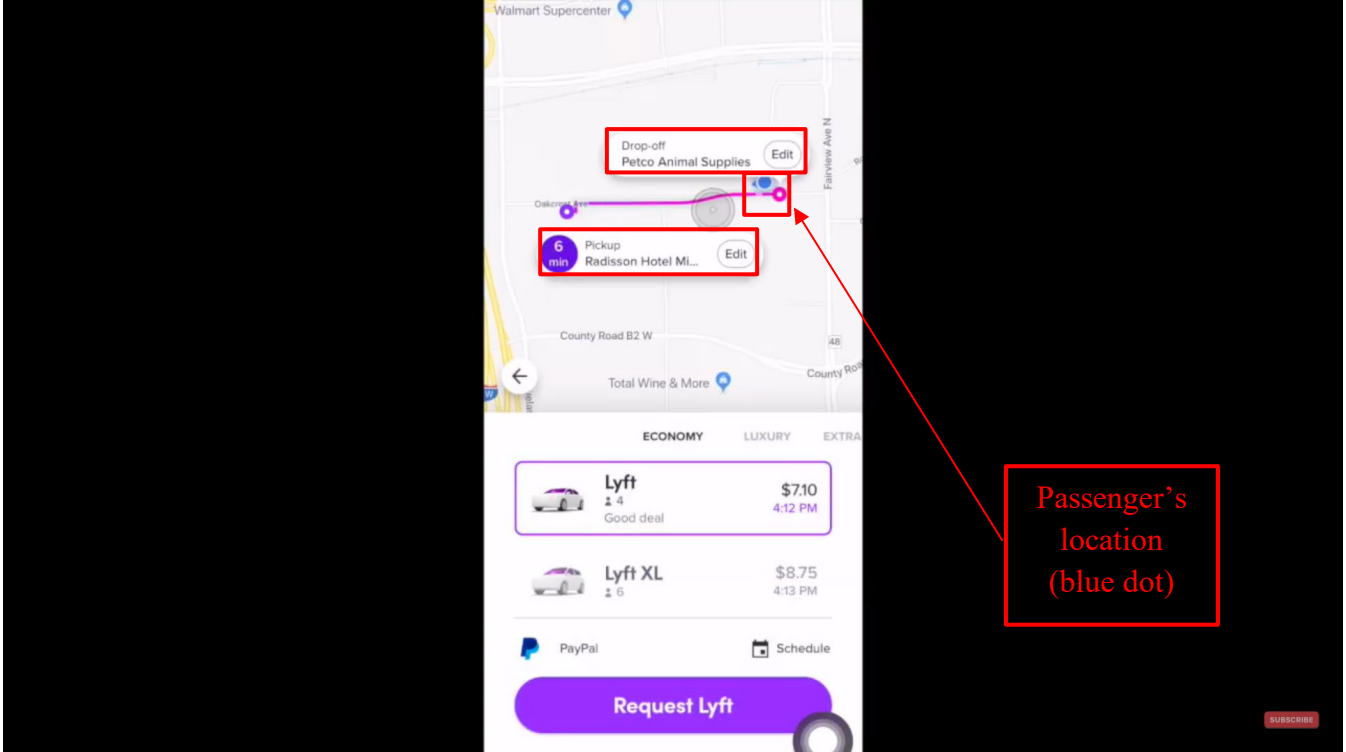
Claim 10,341,838	- Accused Products
	 <p>https://www.youtube.com/watch?v=j0RDMLcmOgU at 3:49</p>

Attachment A for US Patent No. 10,341,838 Against Lyft Accused Products

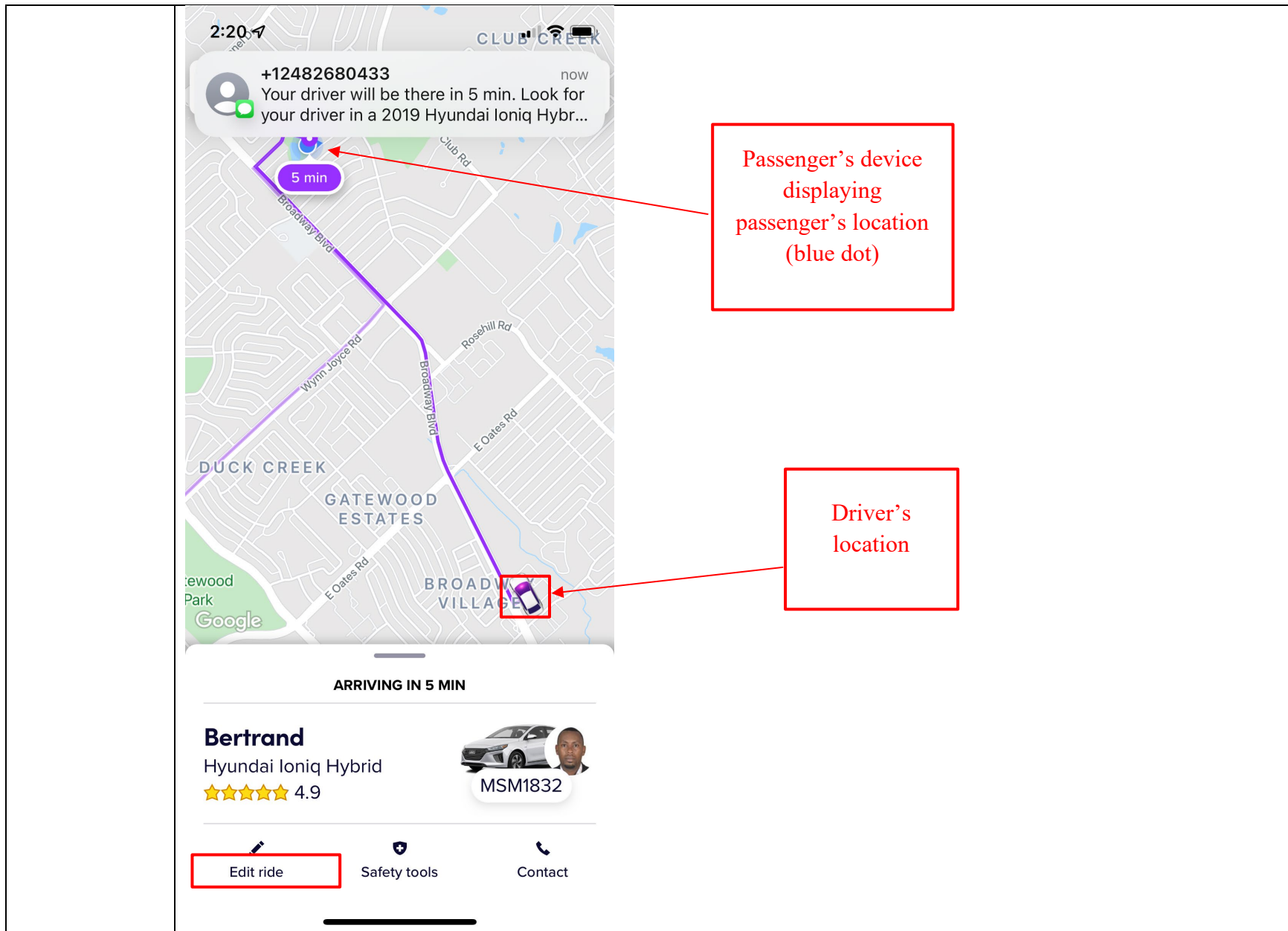

Attachment A for US Patent No. 10,341,838 Against Lyft Accused Products

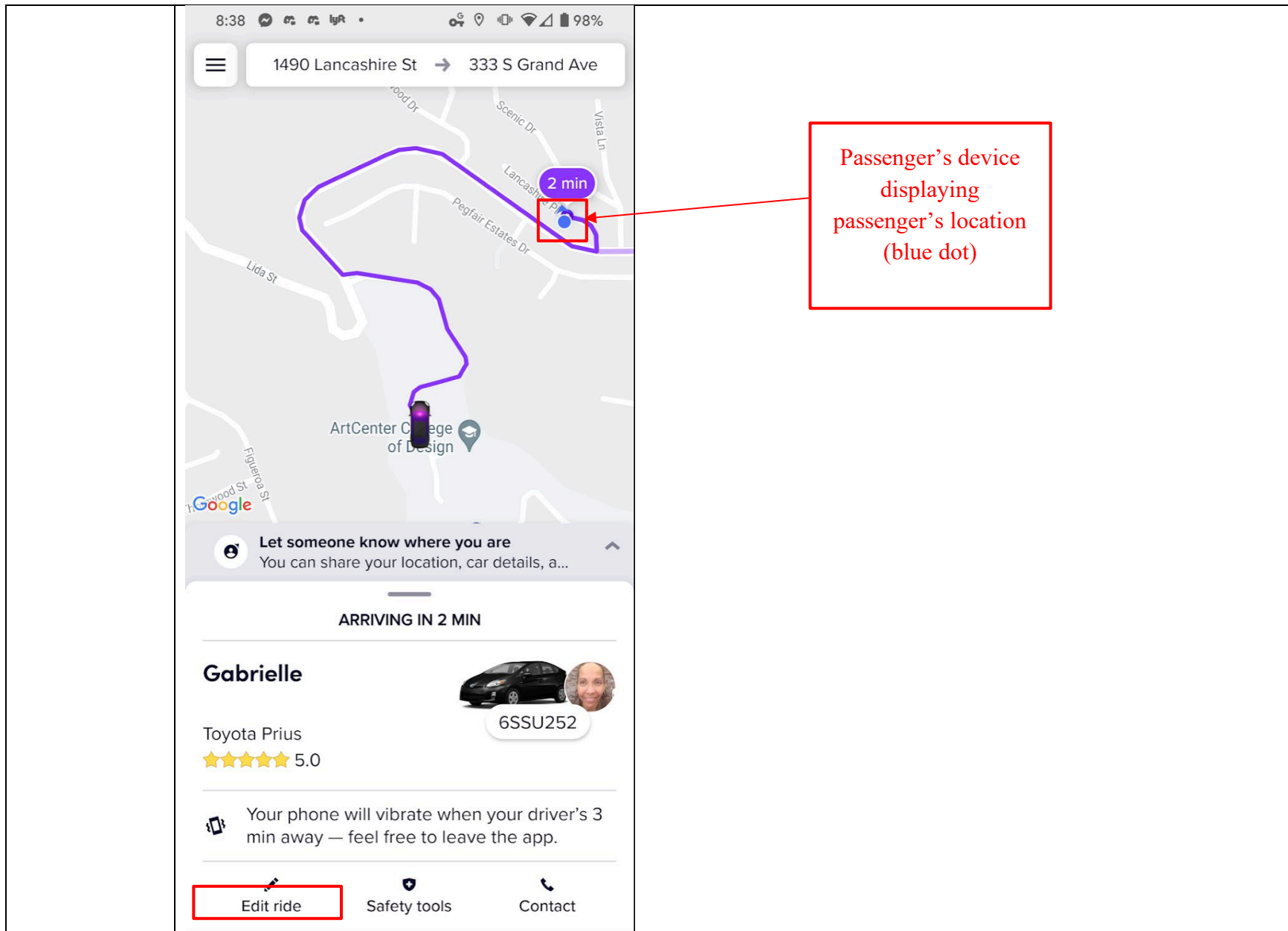

Attachment A for US Patent No. 10,341,838 Against Lyft Accused Products

Claim 10,341,838	- Accused Products
<p>3. The method of claim 2, wherein the updated participant data comprise updated vehicle location data indicating coordinates of an updated geographical location of the first mobile device corresponding to the vehicle.</p>	<p>The Lyft Accused Products infringe directly and/or indirectly by performing, inducing others to perform, and/or contributing to the performance of: wherein the updated participant data comprise updated vehicle location data indicating coordinates of an updated geographical location of the first mobile device corresponding to the vehicle.</p> <p>See claims 1[F] and 2. The Lyft server(s) meets this limitation because it sends updated driver/vehicle locations to the Lyft app for riders and that updated driver/vehicle location is provided for display to the rider via the Lyft app. The updated driver/vehicle location is presented on the geographical map at the geographical location. The geographical location on the map indicates coordinates for the vehicle.</p>

Attachment A for US Patent No. 10,341,838 Against Lyft Accused Products

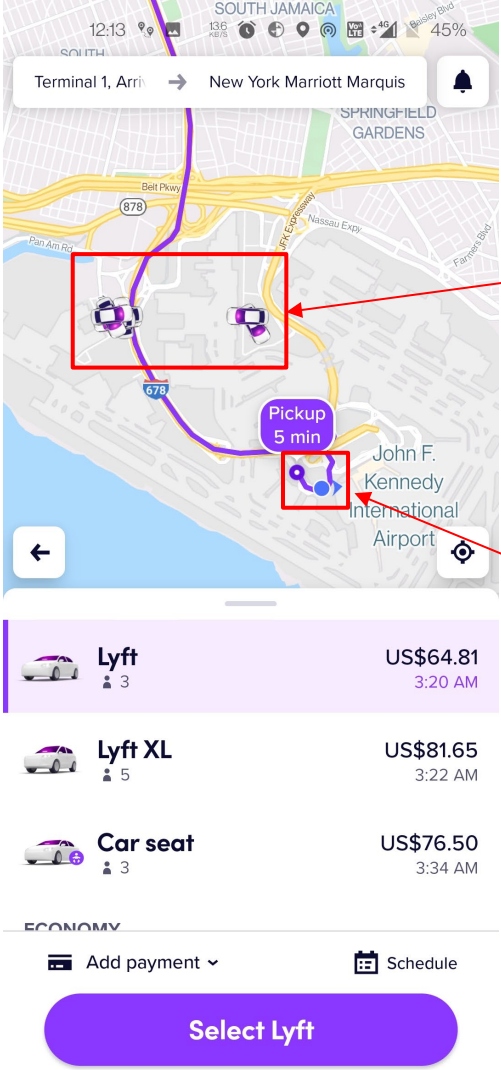
Claim 10,341,838	- Accused Products
	 <p>The screenshot displays the Lyft app interface. At the top, the route is from Terminal 1, Arrivals to New York Marriott Marquis. The map shows the area around John F. Kennedy International Airport. A blue dot indicates the passenger's current location, and a blue circle with a 'P' indicates the pickup location. A purple callout bubble above the pickup location says 'Pickup 5 min'. Two purple car icons represent nearby drivers, with a red box around them and an arrow pointing to a red box labeled 'Nearby Drivers' location'. Another red box labeled 'Passenger's current location (blue dot) and pickup location' has arrows pointing to the blue dot and the pickup location. Below the map, three ride options are listed: Lyft (US\$64.81, 3:20 AM), Lyft XL (US\$81.65, 3:22 AM), and Car seat (US\$76.50, 3:34 AM). At the bottom, there are buttons for 'Add payment', 'Schedule', and a large purple 'Select Lyft' button.</p>

Attachment A for US Patent No. 10,341,838 Against Lyft Accused Products

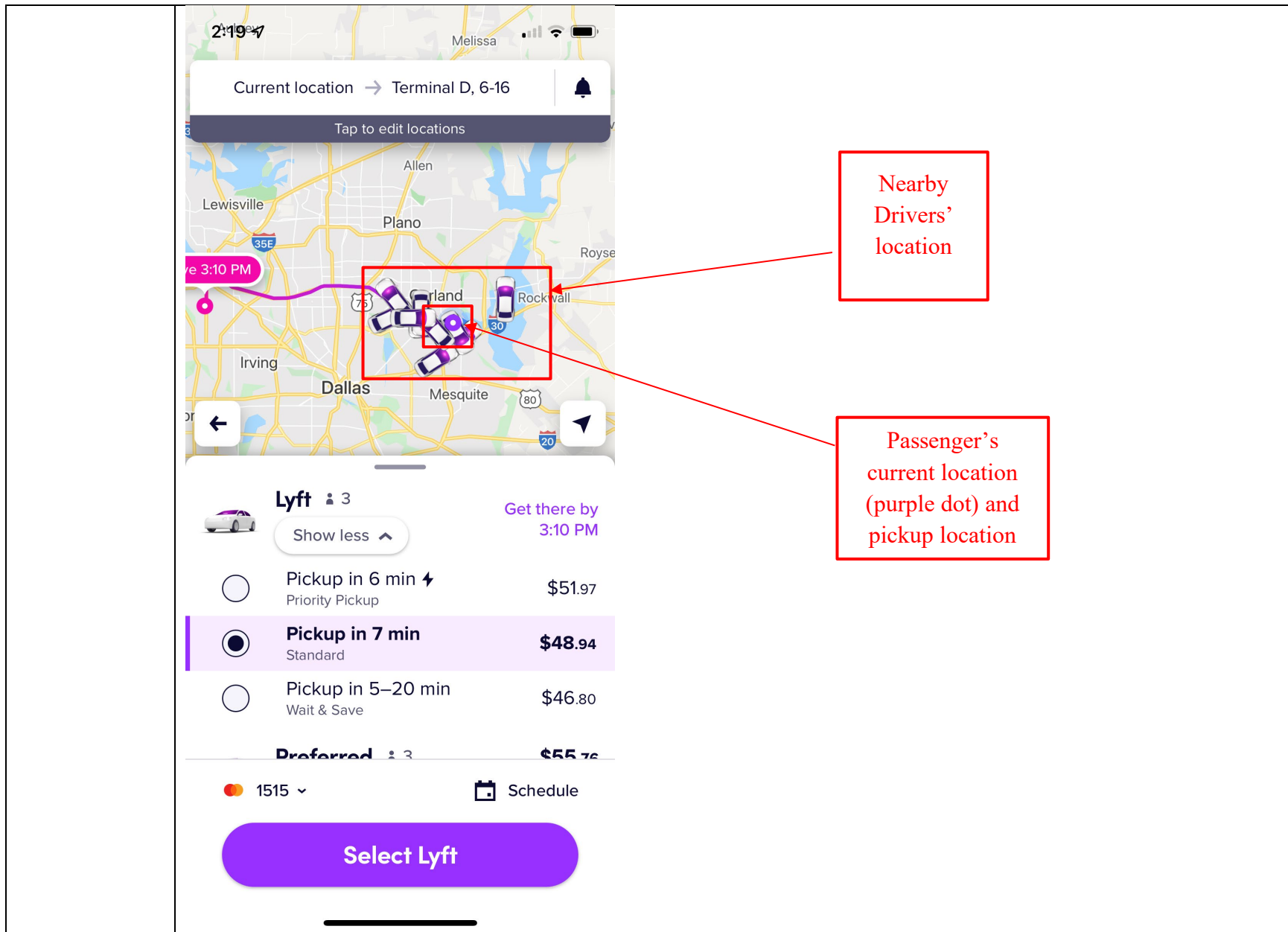

Nearby Drivers' location

Passenger's current location (purple dot) and pickup location

Attachment A for US Patent No. 10,341,838 Against Lyft Accused Products

Claim 10,341,838	- Accused Products
<p>4. The method of claim 1, wherein performing the one or more acts comprises sending, based on the participant selection data, the updated participant data to the second mobile device corresponding to the participant, wherein the second mobile device is configured to replace the participant map with an updated participant map on the display of the second mobile device based at least in</p>	<p>The Lyft Accused Products infringe directly and/or indirectly by performing, inducing others to perform, and/or contributing to the performance of: wherein performing the one or more acts comprises sending, based on the participant selection data, the updated participant data to the second mobile device corresponding to the participant, wherein the second mobile device is configured to replace the participant map with an updated participant map on the display of the second mobile device based at least in part on the updated participant data.</p> <p>See claims 1[F] and 1[H]. The Lyft server(s) meets this limitation because it sends the driver/vehicle locations to the Lyft app for riders and that updated driver/vehicle location is provided for display to the rider via the Lyft app. The Lyft server sends updated map data or maps to the Lyft app for riders when a new location requires the presentation of a new map, i.e. when the location is changed or when the user moves/pans/modifies the map or when the user navigates within or outside the Lyft app and returns to the app.</p>

Attachment A for US Patent No. 10,341,838 Against Lyft Accused Products

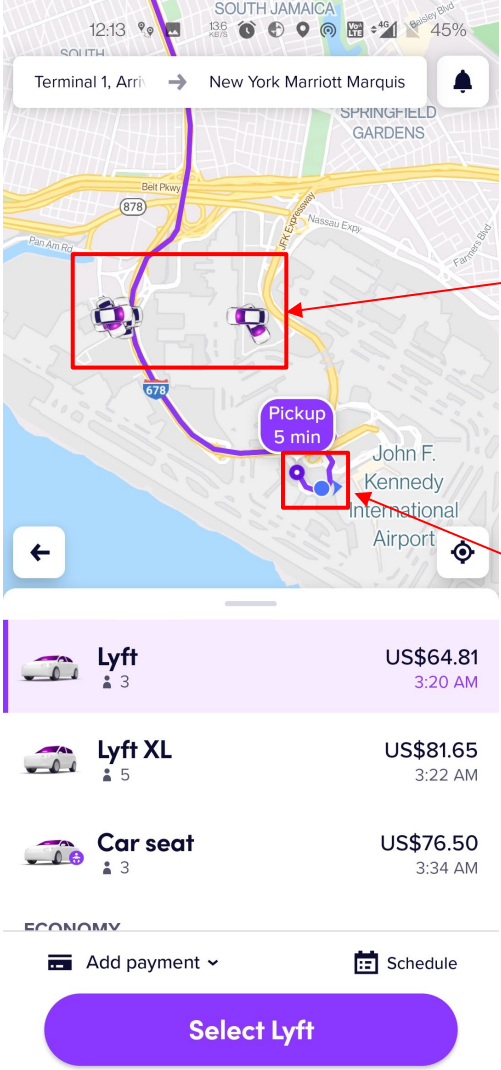
Claim 10,341,838	- Accused Products
part on the updated participant data.	 <p>The screenshot displays the Lyft app interface. At the top, the map shows the location of South Jamaica, NY, with a pickup location at John F. Kennedy International Airport. A red box highlights two nearby drivers' locations. A blue dot indicates the passenger's current location, and a blue circle indicates the pickup location. A callout box labeled 'Pickup 5 min' is shown. Below the map, three ride options are listed: Lyft (US\$64.81, 3:20 AM), Lyft XL (US\$81.65, 3:22 AM), and Car seat (US\$76.50, 3:34 AM). At the bottom, there is a 'Select Lyft' button.</p> <p>Nearby Drivers' location</p> <p>Passenger's current location (blue dot) and pickup location</p>

Attachment A for US Patent No. 10,341,838 Against Lyft Accused Products

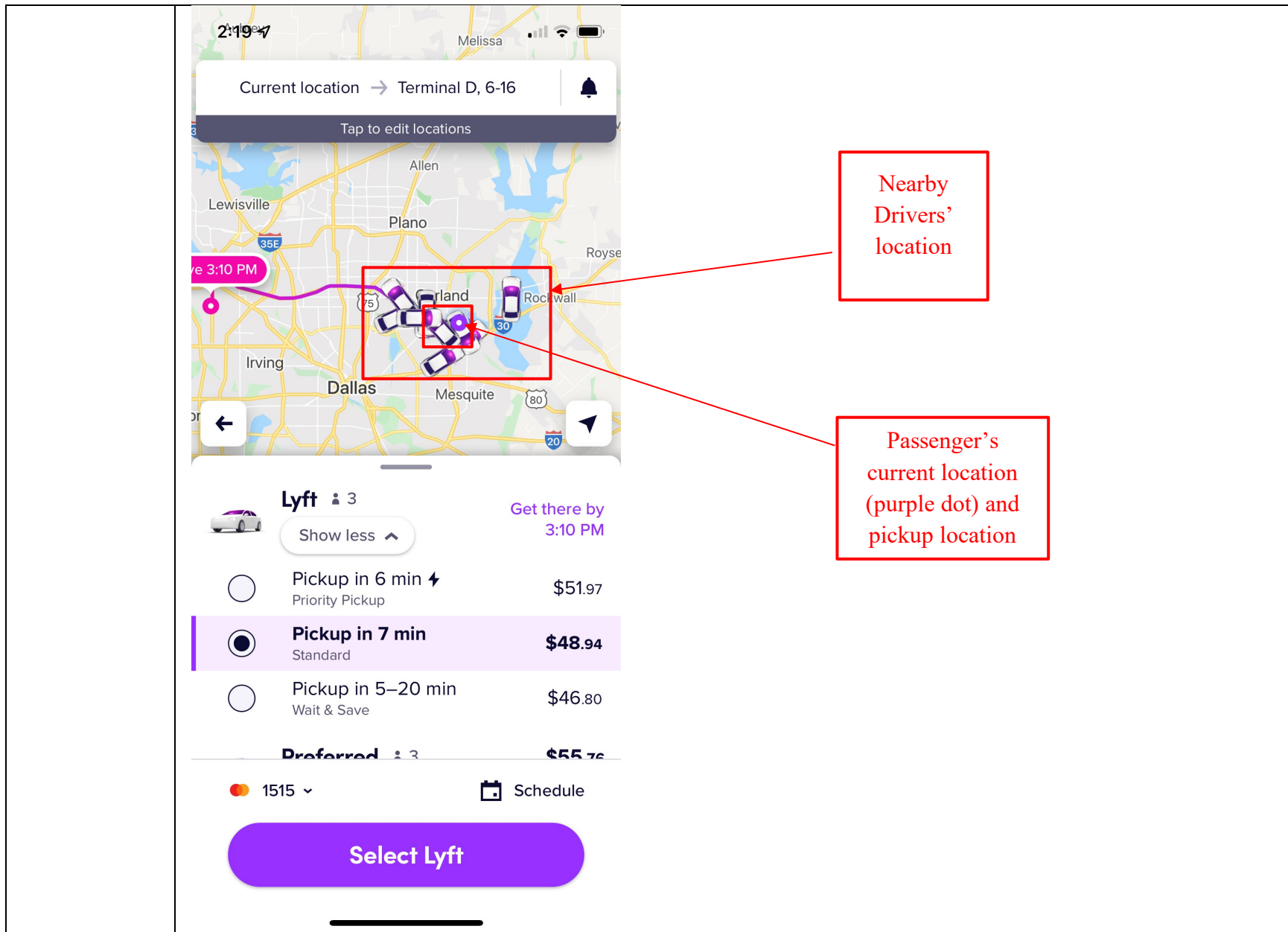

Attachment A for US Patent No. 10,341,838 Against Lyft Accused Products

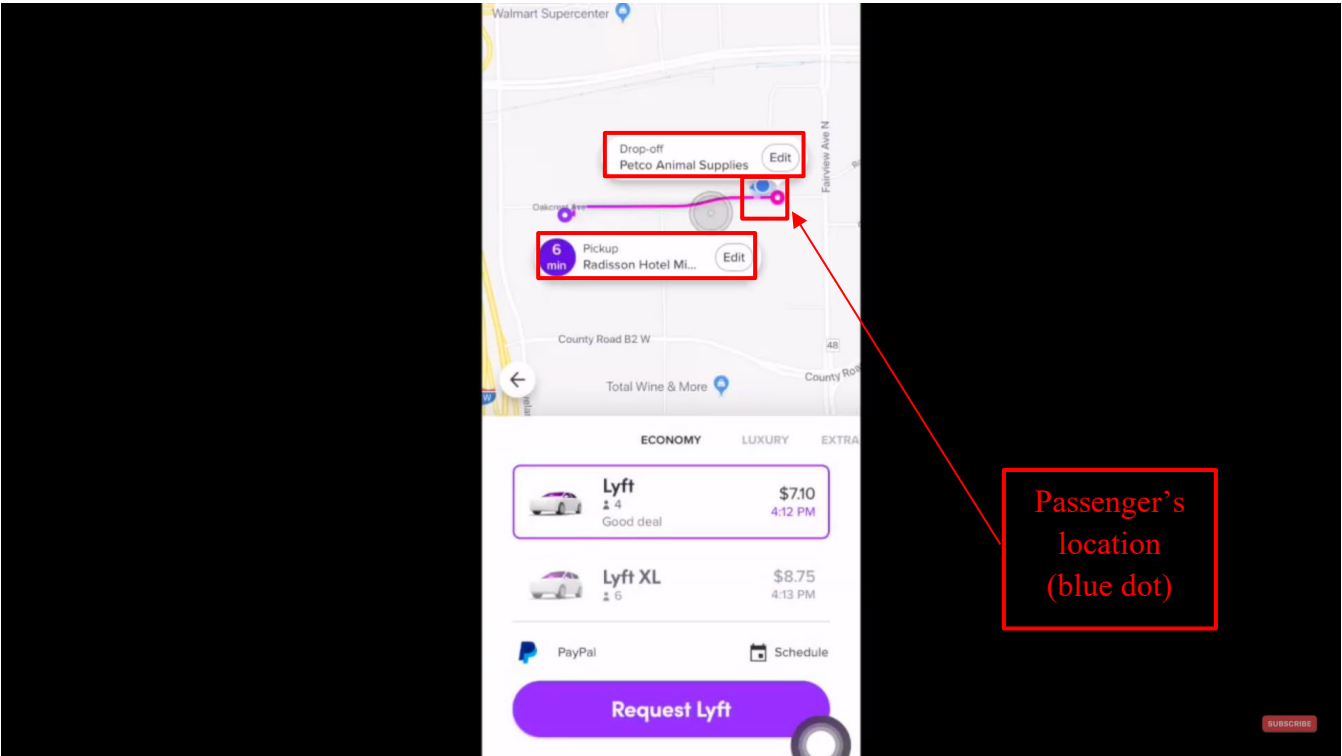
Claim 10,341,838	- Accused Products
	 <p>https://www.youtube.com/watch?v=j0RDMLcmOgU at 3:49</p>



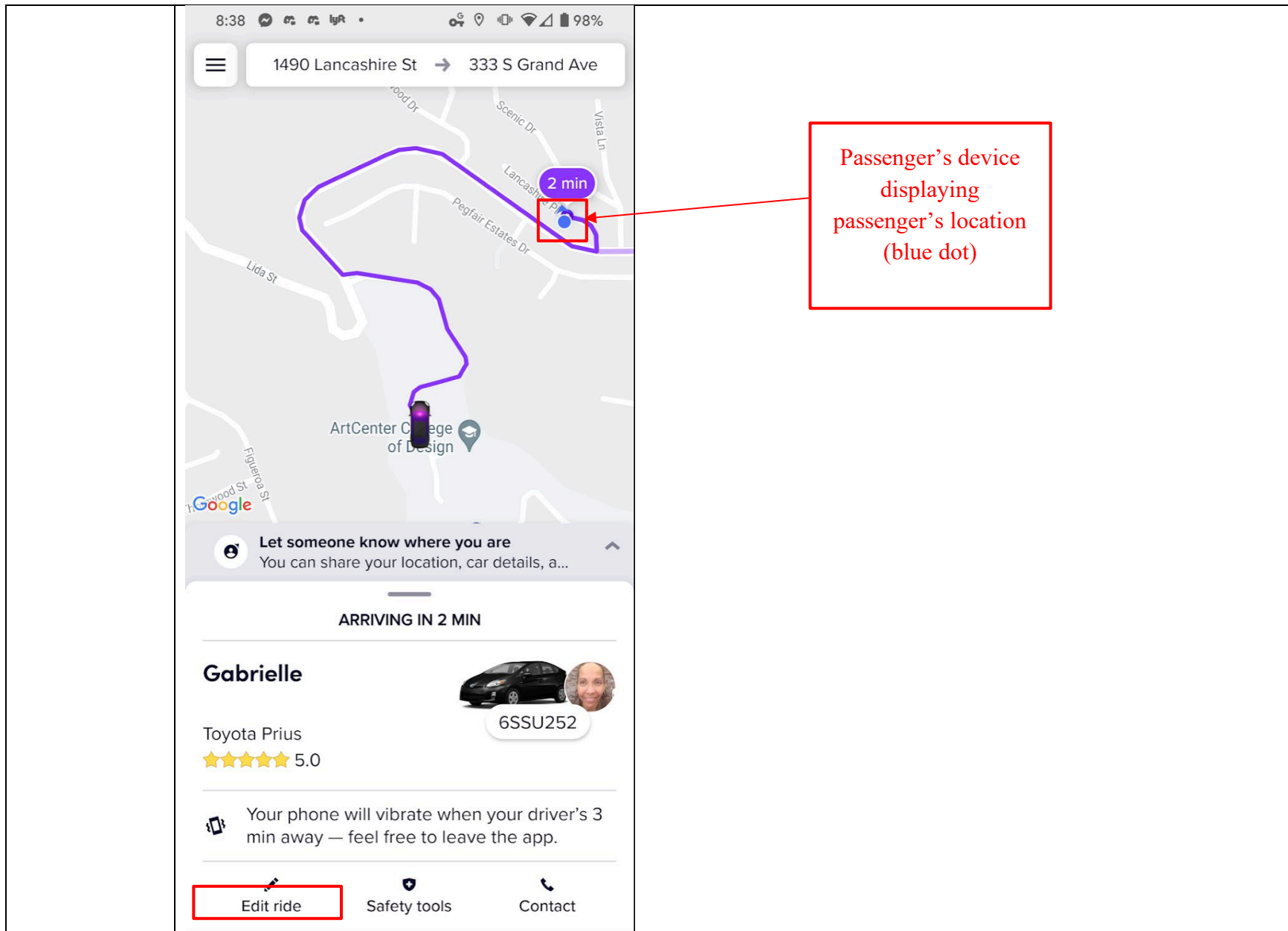





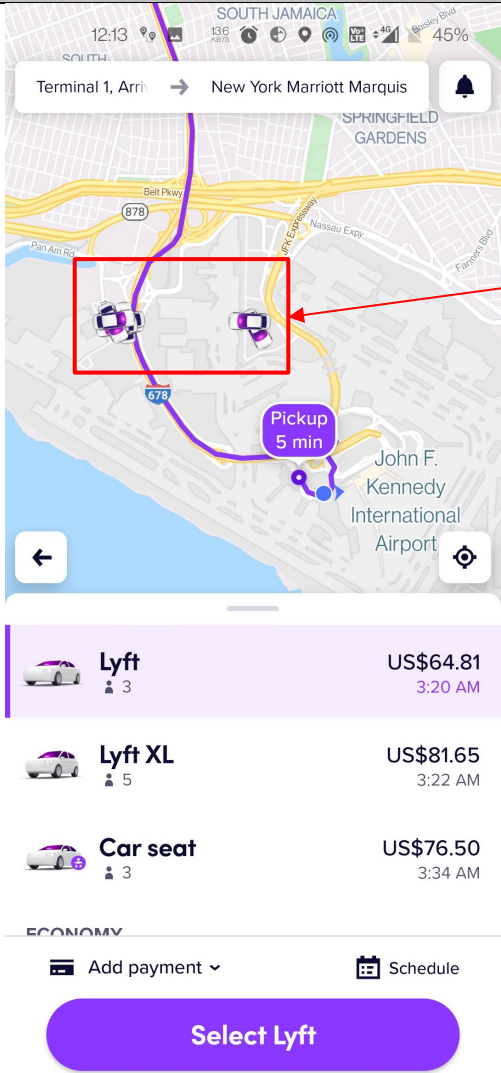

Attachment A for US Patent No. 10,341,838 Against Lyft Accused Products



Attachment A for US Patent No. 10,341,838 Against Lyft Accused Products

Claim 10,341,838	- Accused Products
<p>5. The method of claim 1, wherein performing the one or more acts comprises sending, based on the participant selection data, the message to the first mobile device corresponding to the vehicle</p>	<p>The Lyft Accused Products infringe directly and/or indirectly by performing, inducing others to perform, and/or contributing to the performance of: wherein performing the one or more acts comprises sending, based on the participant selection data, the message to the first mobile device corresponding to the vehicle.</p> <p>See claim 1[I]. The Lyft server(s) meets this limitation because it sends data corresponding to selections made in the Lyft app for riders to the Lyft app for drivers. For example, when the passenger books a ride by providing a pickup location and destination address (“participant selection data”), the server communicates the ride request message to the Lyft apps of the nearby drivers asking them to either accept or decline the ride. In other examples, the Lyft server receives selections from the riders’s Lyft app before or during a ride and communicates messages to the Lyft app for drivers.</p>

Attachment A for US Patent No. 10,341,838 Against Lyft Accused Products

Claim 10,341,838	- Accused Products						
	 <p data-bbox="1087 386 1287 589">Nearby Drivers</p> <table border="1" data-bbox="426 885 924 1144"><tbody><tr><td> Lyft</td><td>US\$64.81</td></tr><tr><td> Lyft XL</td><td>US\$81.65</td></tr><tr><td> Car seat</td><td>US\$76.50</td></tr></tbody></table> <p data-bbox="472 1182 884 1239">ECONOMY Add payment Schedule</p> <p data-bbox="472 1255 884 1331">Select Lyft</p>	 Lyft	US\$64.81	 Lyft XL	US\$81.65	 Car seat	US\$76.50
 Lyft	US\$64.81						
 Lyft XL	US\$81.65						
 Car seat	US\$76.50						

Attachment A for US Patent No. 10,341,838 Against Lyft Accused Products

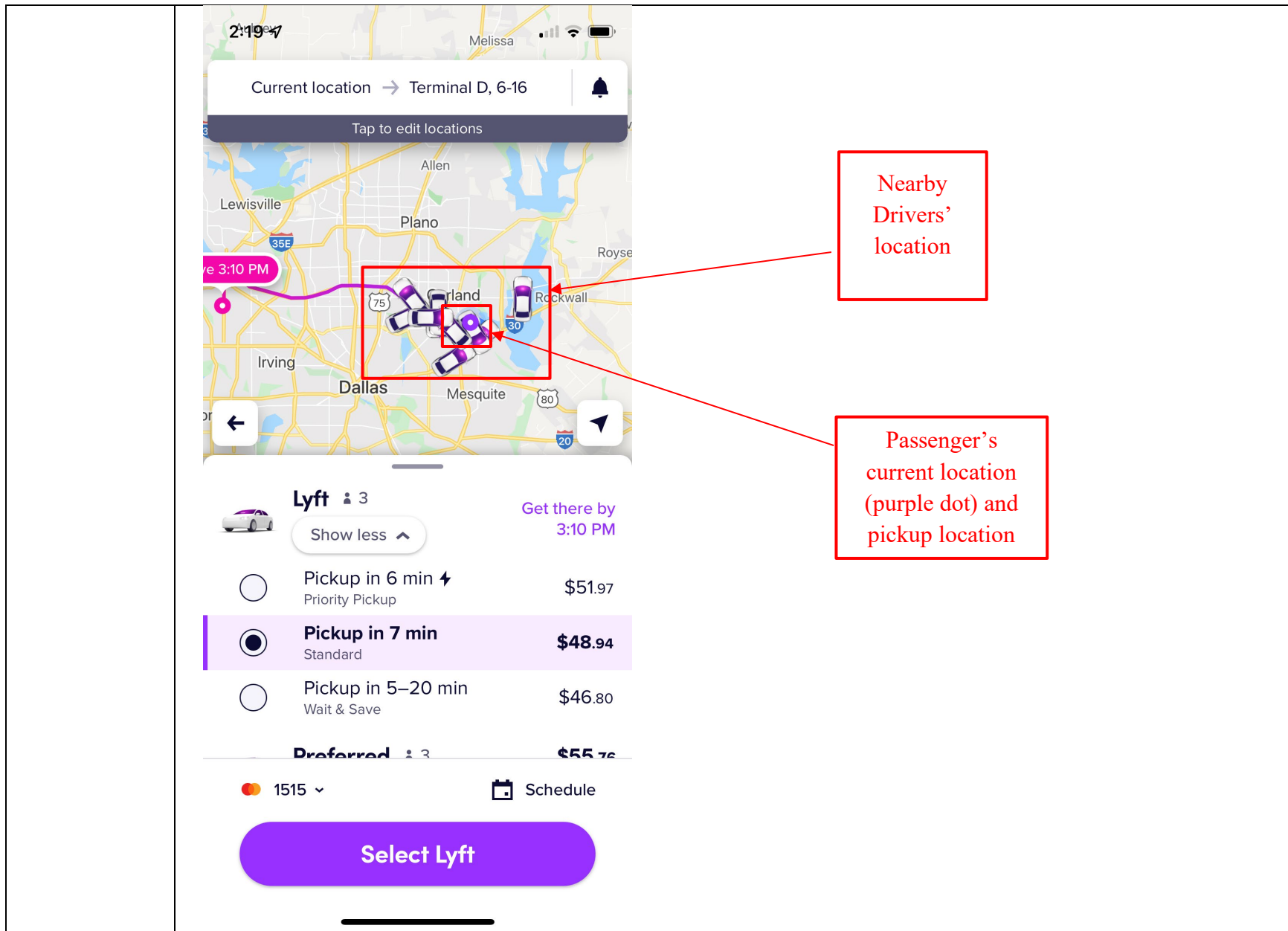

Attachment A for US Patent No. 10,341,838 Against Lyft Accused Products

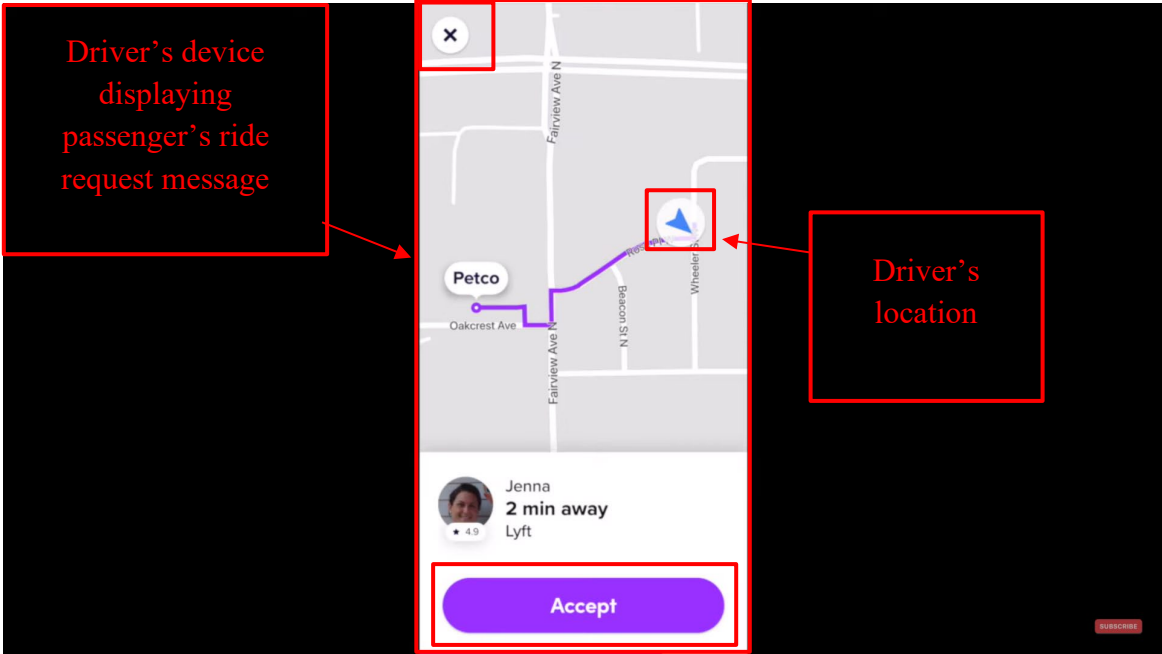
Claim 10,341,838	- Accused Products
	 <p>Driver's device displaying passenger's ride request message</p> <p>Driver's location</p> <p>https://www.youtube.com/watch?v=jVUy9poJDng at 10:24, Annotated</p>

Attachment A for US Patent No. 10,341,838 Against Lyft Accused Products

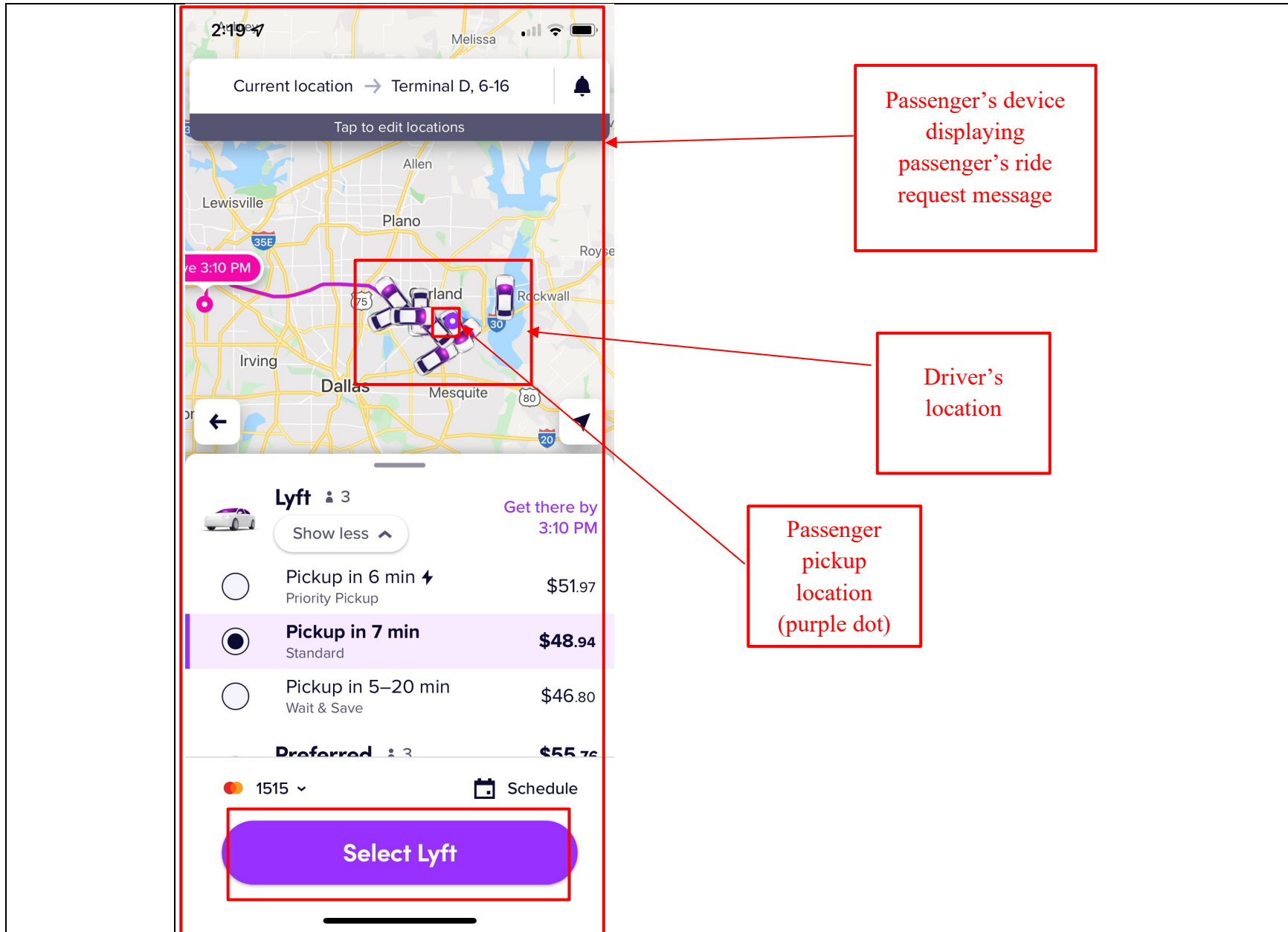

Attachment A for US Patent No. 10,341,838 Against Lyft Accused Products

Claim 10,341,838	- Accused Products
<p>6. The method of claim 5, wherein the message to the first mobile device corresponding to the vehicle includes the second identifier and updated participant location data.</p>	<p>The Lyft Accused Products infringe directly and/or indirectly by performing, inducing others to perform, and/or contributing to the performance of: wherein the message to the first mobile device corresponding to the vehicle includes the second identifier and updated participant location data.</p> <p>See claims 1[I] and 5. The Lyft server(s) meets this limitation because it sends data corresponding to selections made in the Lyft app for riders to the Lyft app for drivers. The Lyft server communicates information including the account/identity information for the rider and the updated location of the rider to the Lyft app for driver. This can occur during the ride request or during the ride.</p> <div data-bbox="430 738 1585 1388" style="text-align: center;"> <p style="color: red; font-weight: bold;">Driver's device displaying passenger's ride request message</p> <p style="color: red; font-weight: bold;">Passenger's pickup location</p> </div> <p>https://www.youtube.com/watch?v=jVUy9poJDng at 10:24, Annotated</p>

Attachment A for US Patent No. 10,341,838 Against Lyft Accused Products

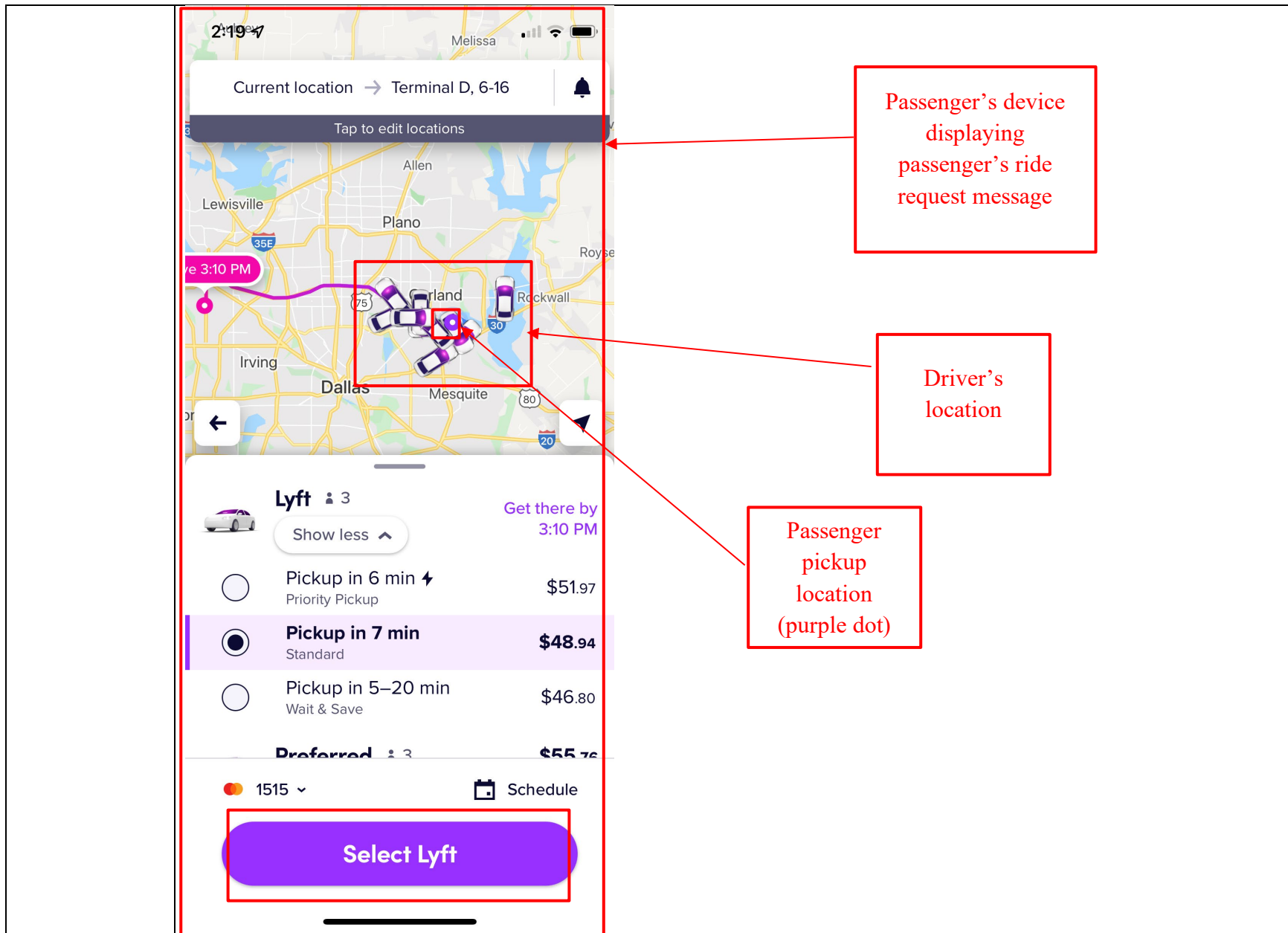

Attachment A for US Patent No. 10,341,838 Against Lyft Accused Products

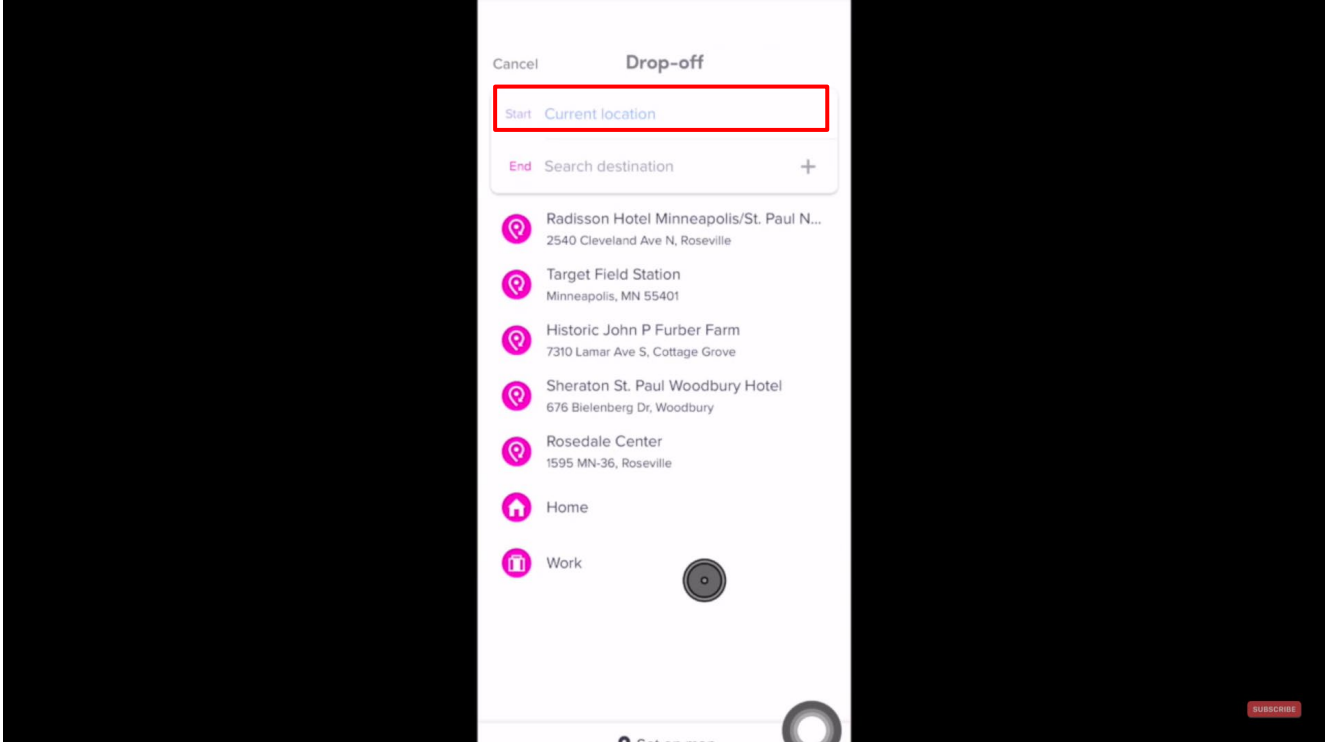
Claim 10,341,838	- Accused Products
	 <p>https://www.youtube.com/watch?v=j0RDMLcmOgU at 3:27</p>

Attachment A for US Patent No. 10,341,838 Against Lyft Accused Products

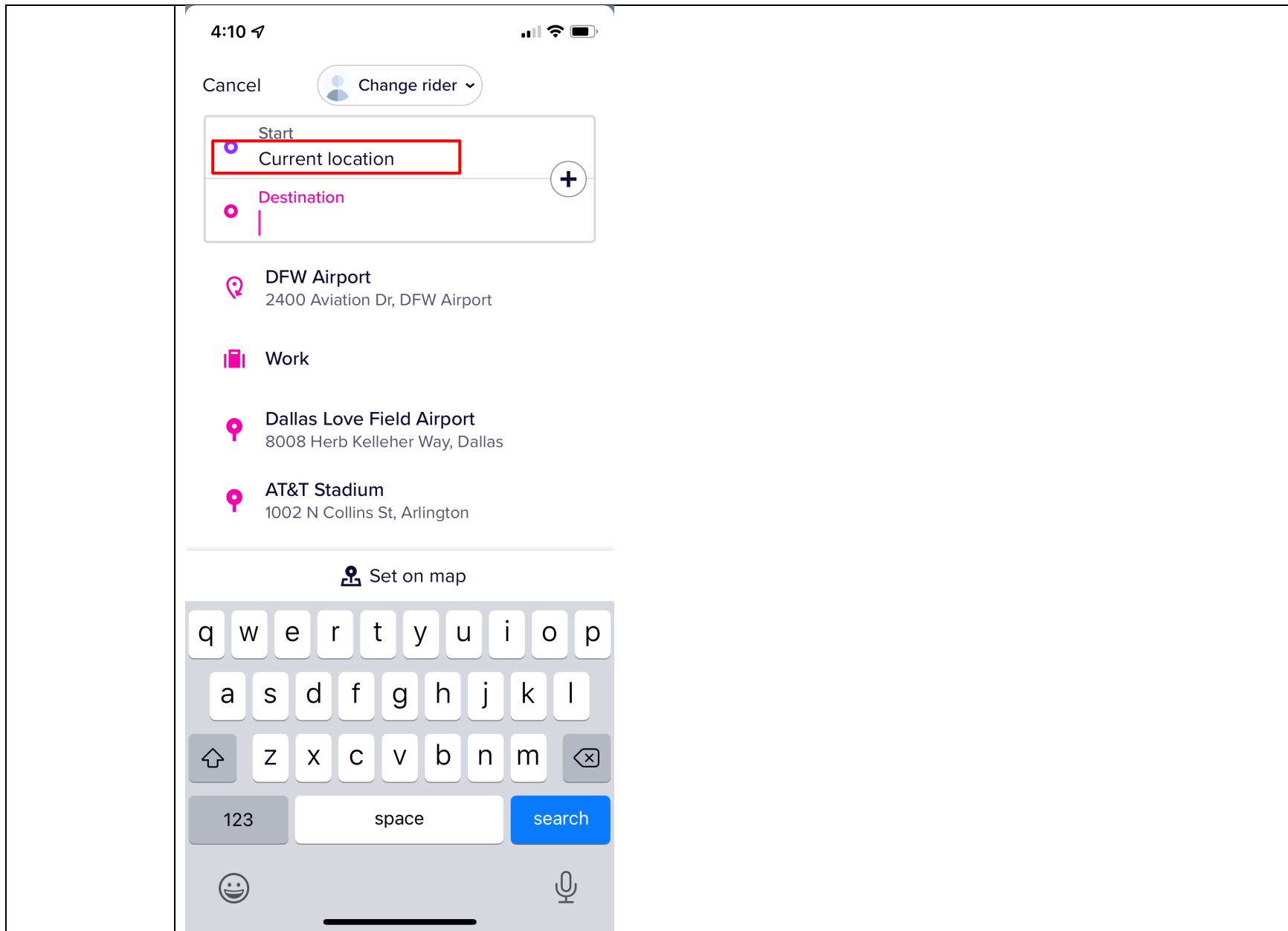

Attachment A for US Patent No. 10,341,838 Against Lyft Accused Products

Claim 10,341,838	- Accused Products
<p>7. The method of claim 1, wherein performing the one or more acts comprises sending, based on the participant selection data, the updated vehicle data to the first mobile device corresponding to the vehicle, wherein the first mobile device is configured to display the updated vehicle data within the vehicle map.</p>	<p>The Lyft Accused Products infringe directly and/or indirectly by performing, inducing others to perform, and/or contributing to the performance of: wherein performing the one or more acts comprises sending, based on the participant selection data, the updated vehicle data to the first mobile device corresponding to the vehicle, wherein the first mobile device is configured to display the updated vehicle data within the vehicle map.</p> <p>See claims 1[I] and 1[J]. The Lyft server(s) meets this limitation because it sends updated rider location to the Lyft app for drivers and the location is displayed in the Lyft app for drivers. This can occur before or during a ride. For example, after the passenger books the ride by providing the pickup address and destination address (“participant selection data”), the server sends the updated current location of the rider to the driver’s Lyft app. Also, the rider can update this selection data or can transmit a new location to the driver’s Lyft app for display.</p>

Attachment A for US Patent No. 10,341,838 Against Lyft Accused Products

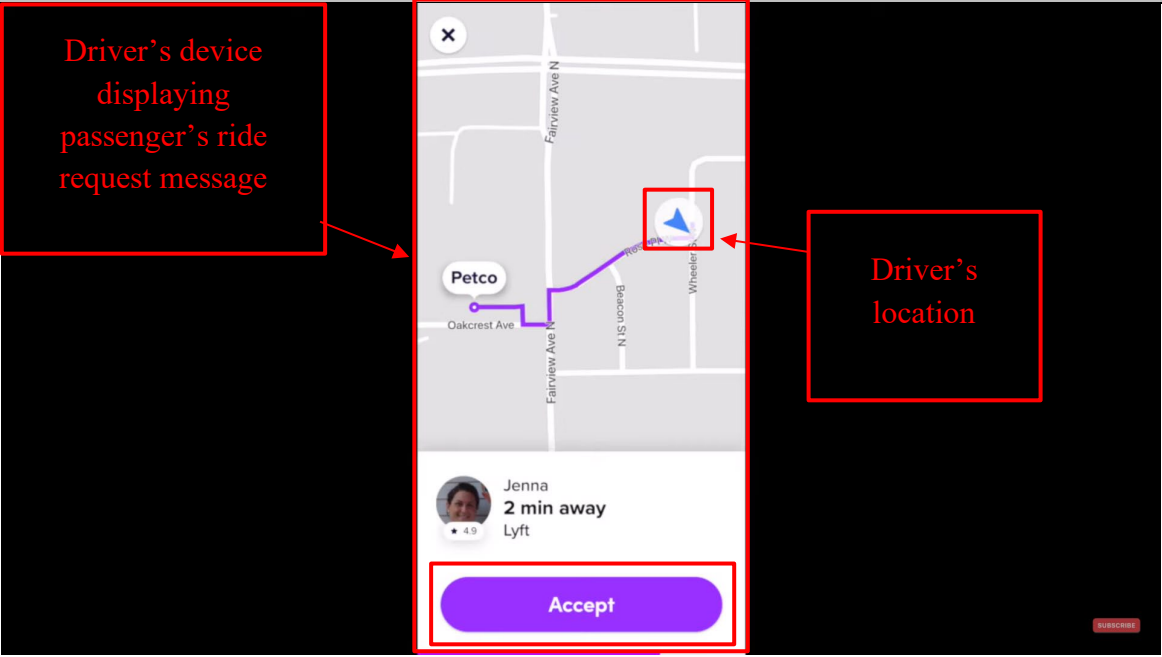
Claim 10,341,838	- Accused Products
	 <p>Driver's device displaying passenger's ride request message</p> <p>Driver's location</p> <p>https://www.youtube.com/watch?v=jVUy9poJDng at 10:24, Annotated</p>

Attachment A for US Patent No. 10,341,838 Against Lyft Accused Products

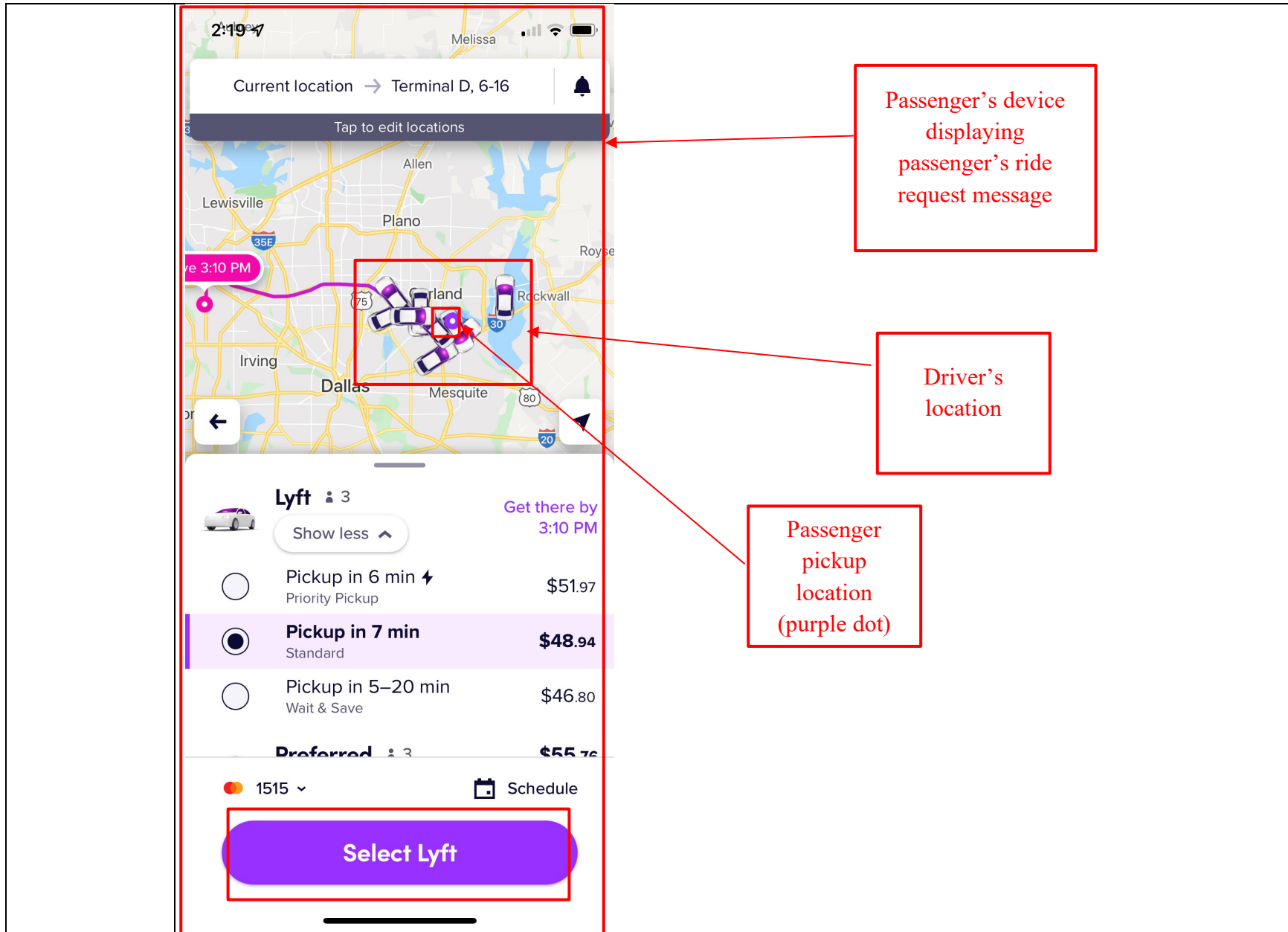

Attachment A for US Patent No. 10,341,838 Against Lyft Accused Products

Claim - 10,341,838	Accused Products
<p>8. The method of claim 1, wherein performing the one or more acts comprises sending, based on the participant selection data, the updated vehicle data to the first mobile device corresponding to the vehicle, wherein the first mobile device is configured to replace the vehicle map with an updated vehicle map on the display of the first mobile device based at least in part on</p>	<p>The Lyft Accused Products infringe directly and/or indirectly by performing, inducing others to perform, and/or contributing to the performance of: wherein performing the one or more acts comprises sending, based on the participant selection data, the updated vehicle data to the first mobile device corresponding to the vehicle, wherein the first mobile device is configured to replace the vehicle map with an updated vehicle map on the display of the first mobile device based at least in part on the updated vehicle data.</p> <p>See claims 1[I] and 1[J]. The Lyft server(s) meets this limitation because it sends the rider locations to the Lyft app for drivers and that updated rider location is provided for display to the driver via the Lyft app. The Lyft server sends updated map data or maps to the Lyft app for drivers when a new location requires the presentation of a new map, i.e. when the location/route/direction is changed or when the user moves/pans/modifies the map or when the user navigates within or outside the Lyft app and returns to the app.</p>

Attachment A for US Patent No. 10,341,838 Against Lyft Accused Products

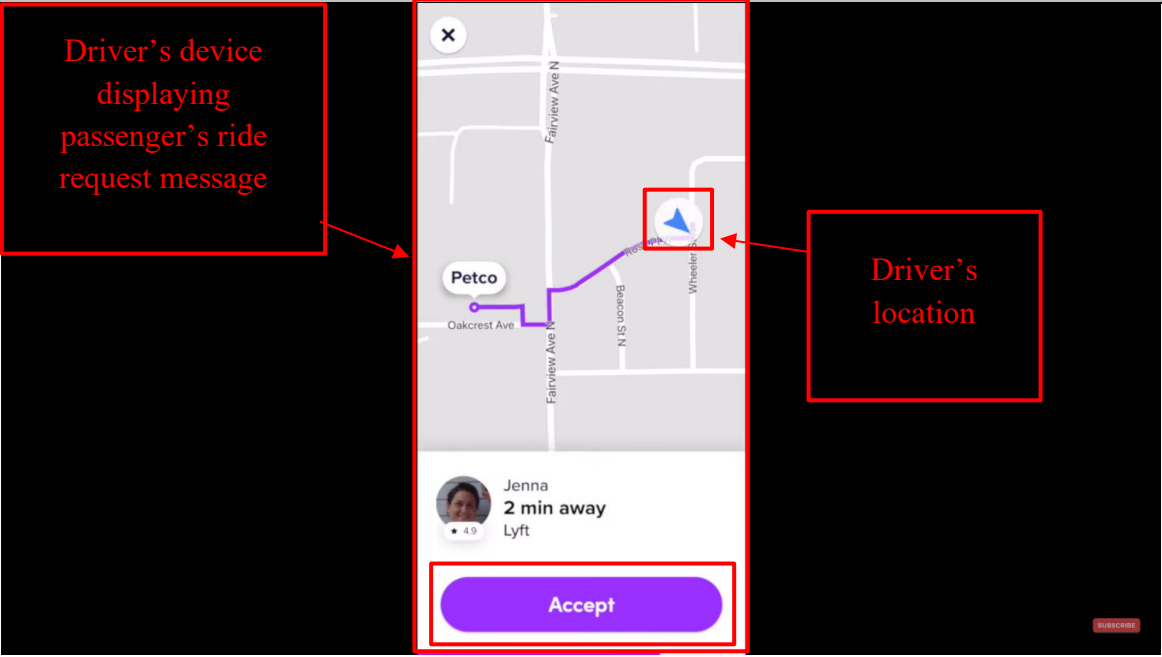
Claim 10,341,838	- Accused Products
the updated vehicle data.	 <p>Driver's device displaying passenger's ride request message</p> <p>Driver's location</p> <p>https://www.youtube.com/watch?v=jVUy9poJDng at 10:24, Annotated</p>

Attachment A for US Patent No. 10,341,838 Against Lyft Accused Products

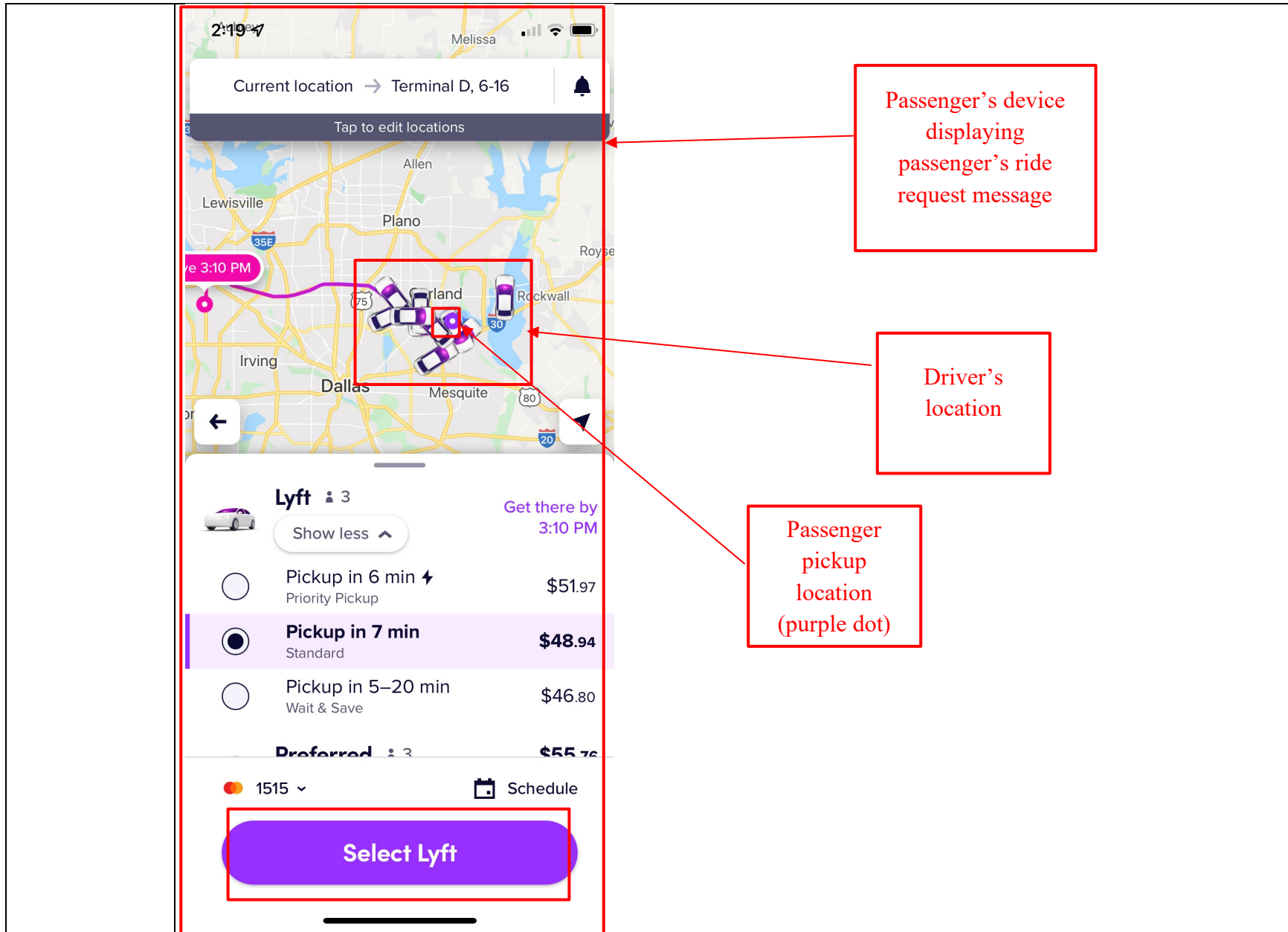

Attachment A for US Patent No. 10,341,838 Against Lyft Accused Products

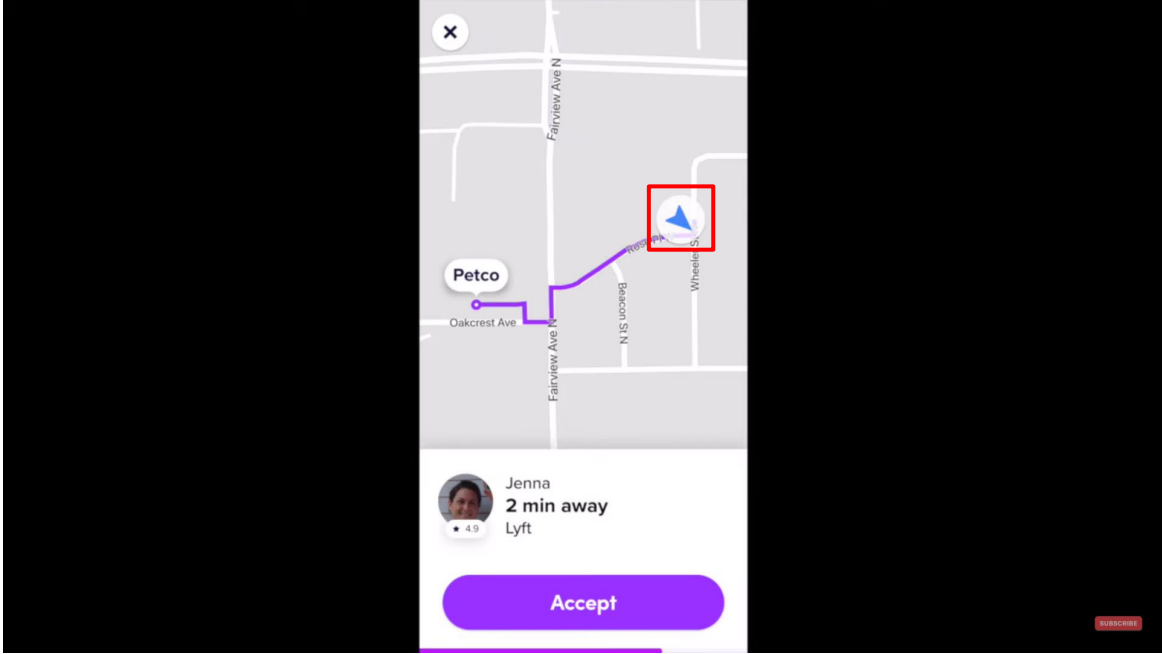
Claim 10,341,838	- Accused Products
<p>9. The method of claim 1, wherein the vehicle map is interactive.</p>	<p>The Lyft Accused Products infringe directly and/or indirectly by performing, inducing others to perform, and/or contributing to the performance of: wherein the vehicle map is interactive.</p> <p>See claim 1. The Lyft server(s) meets this limitation because the user of the Lyft app can interact with the maps provided by the server.</p>  <p>https://www.youtube.com/watch?v=jVUy9poJDng at 10:24</p>

Attachment A for US Patent No. 10,341,838 Against Lyft Accused Products

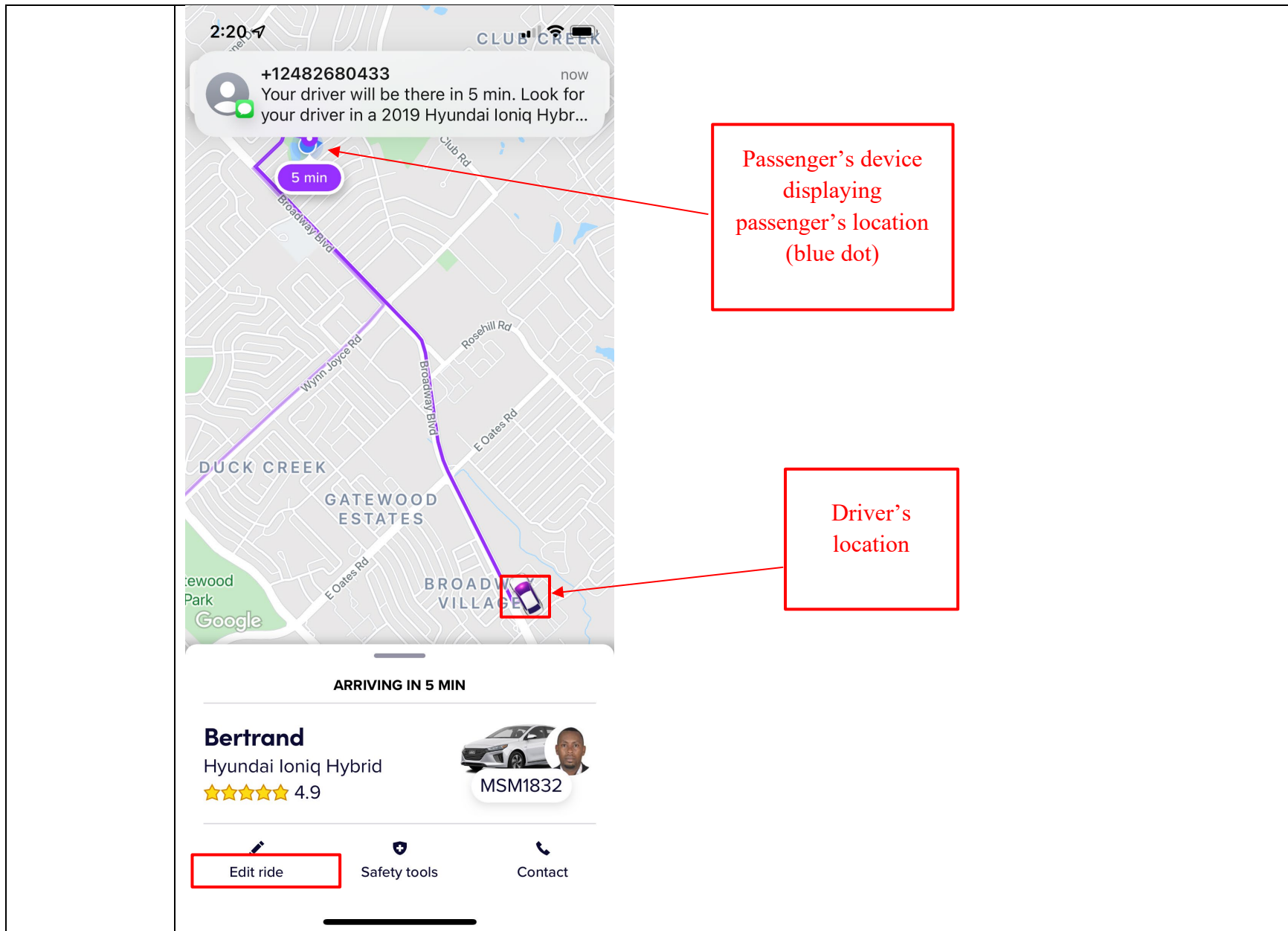

Attachment A for US Patent No. 10,341,838 Against Lyft Accused Products

Claim 10,341,838	- Accused Products
10. The method of claim 1, wherein the participant map is interactive.	The Lyft Accused Products infringe directly and/or indirectly by performing, inducing others to perform, and/or contributing to the performance of: wherein the participant map is interactive. See claim 1. The Lyft server(s) meets this limitation because the user of the Lyft app can interact with the maps provided by the server.

Attachment A for US Patent No. 10,341,838 Against Lyft Accused Products

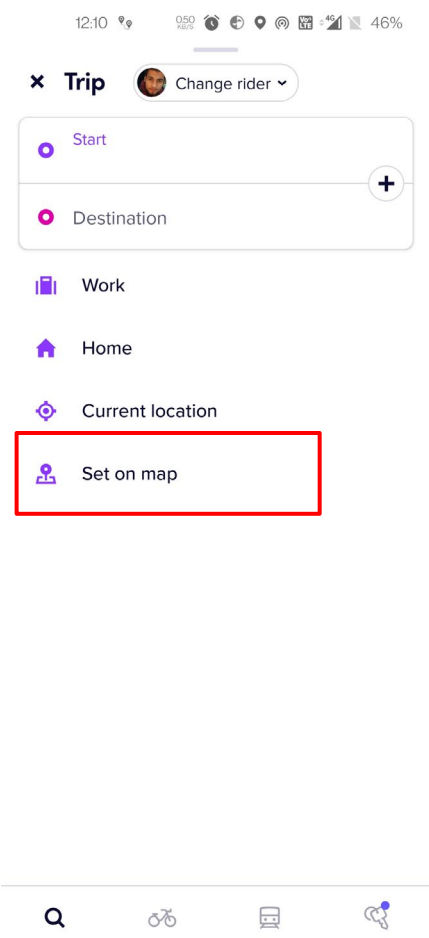
Claim 10,341,838	- Accused Products
	 <p>The screenshot shows the Lyft mobile app interface for setting up a trip. At the top, the status bar displays the time 12:10, signal strength, Wi-Fi, cellular service, and a 46% battery level. Below the status bar, there is a 'Trip' header with a close button (x) and a 'Change rider' dropdown menu. The main area contains a 'Start' field with a purple location pin icon and a plus sign button (+) to its right. Below the 'Start' field is a 'Destination' field with a purple location pin icon. Further down, there are four location suggestions: 'Work' (with a building icon), 'Home' (with a house icon), 'Current location' (with a location pin icon), and 'Set on map' (with a person icon). The 'Set on map' option is highlighted with a red rectangular box. At the bottom of the screen, there is a navigation bar with four icons: a magnifying glass (search), a bicycle (ride), a car (drive), and a person (profile).</p>

Attachment A for US Patent No. 10,341,838 Against Lyft Accused Products

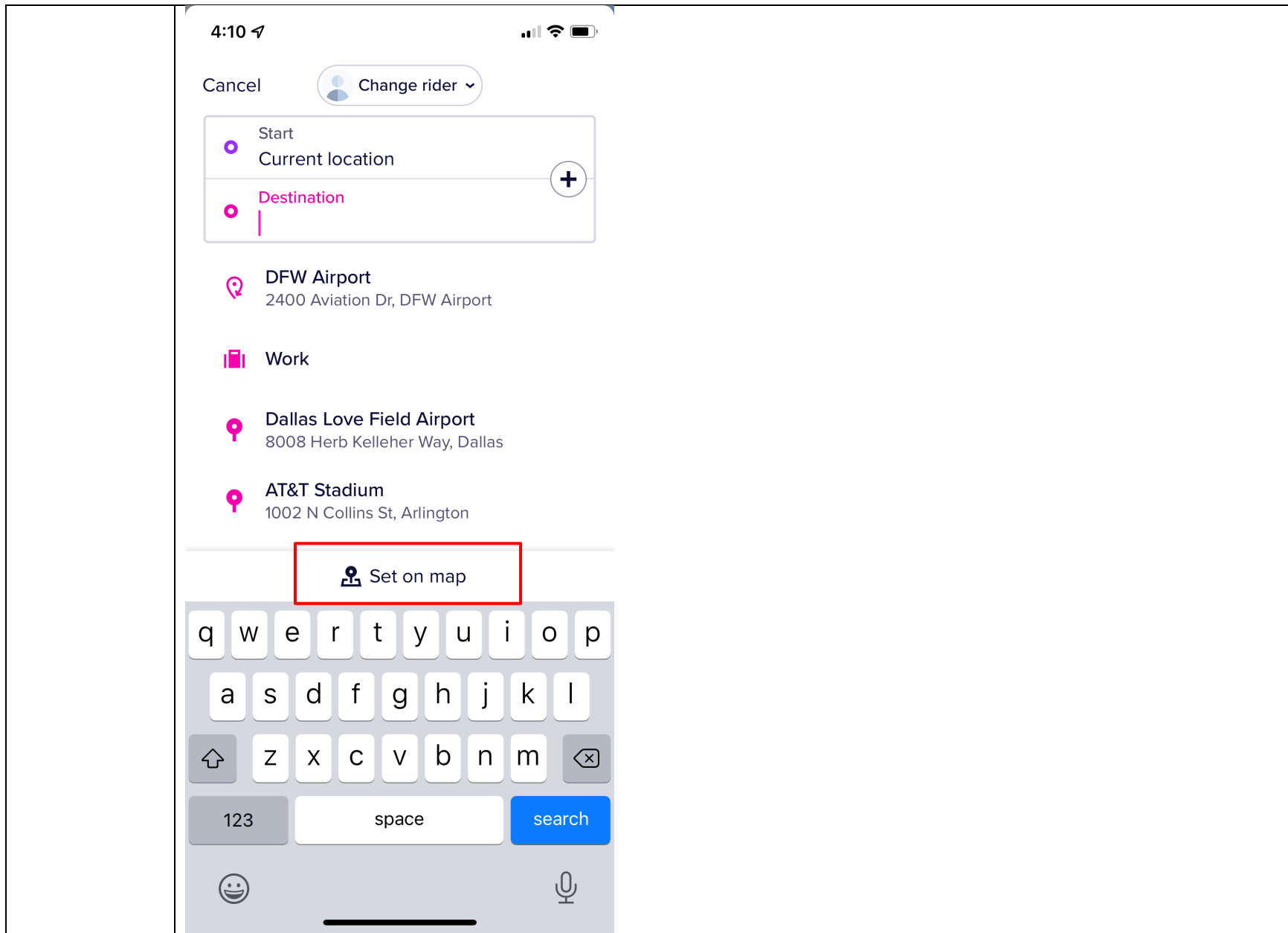

Attachment A for US Patent No. 10,341,838 Against Lyft Accused Products

Claim 10,341,838	- Accused Products
<p>11. The method of claim 1, wherein the new entity of interest is an event and the location of the new entity of interest is a location of the event.</p>	<p>The Lyft Accused Products infringe directly and/or indirectly by performing, inducing others to perform, and/or contributing to the performance of: wherein the new entity of interest is an event and the location of the new entity of interest is a location of the event.</p> <p>See claim 1[L]. The Lyft server(s) meets this limitation because the rider can schedule a pickup or ride with a location using the Lyft app for riders. The Lyft app can also be used to request a ride from a calendar/schedule which can include the location. For example, the destination address added by the passenger is a location added by the passenger before requesting a ride.</p>

Attachment A for US Patent No. 10,341,838 Against Lyft Accused Products

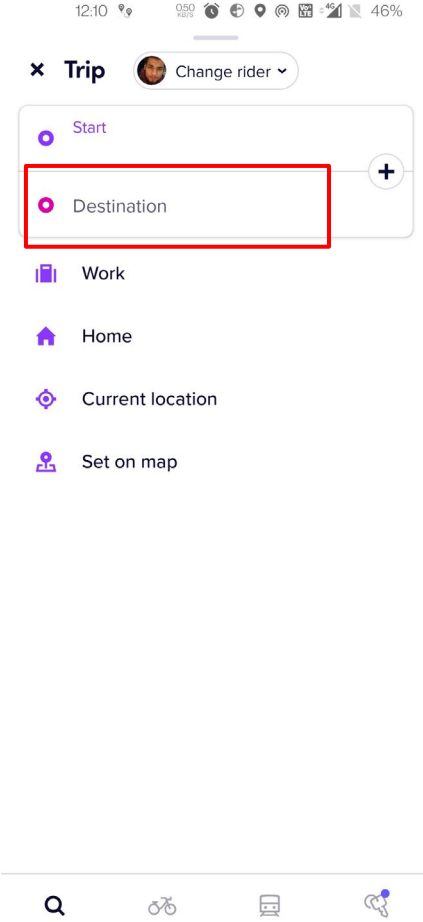
Claim 10,341,838	- Accused Products
	 <p>The screenshot shows the Lyft mobile application interface for setting up a trip. At the top, the status bar displays the time 12:10, signal strength, Wi-Fi, location, and battery levels at 46%. Below the status bar, the app header shows a close button (x), the word "Trip", and a "Change rider" button with a dropdown arrow. The main content area features a "Start" field with a purple location pin icon and a plus sign to its right. Below "Start" is the "Destination" field, which is highlighted with a red rectangular box and also has a plus sign to its right. Underneath the "Destination" field are four location suggestions: "Work" (with a building icon), "Home" (with a house icon), "Current location" (with a location pin icon), and "Set on map" (with a person icon). At the bottom of the screen is a navigation bar with four icons: a magnifying glass (search), a bicycle (ride), a car (drive), and a person (profile).</p>

Attachment A for US Patent No. 10,341,838 Against Lyft Accused Products

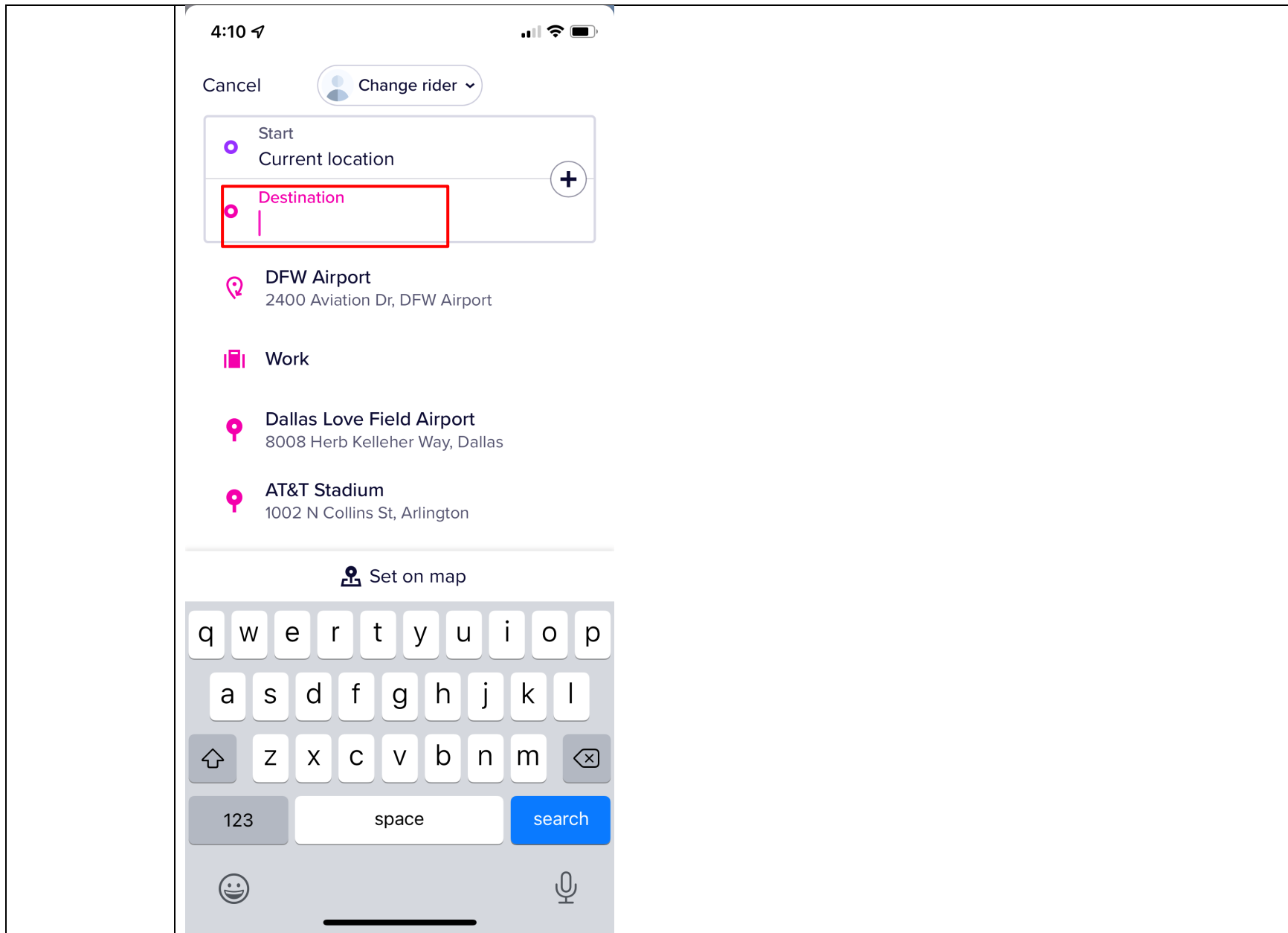

Attachment A for US Patent No. 10,341,838 Against Lyft Accused Products

Claim 10,341,838	- Accused Products
<p>12. The method of claim 1, wherein the new entity of interest location is different from the locations of the first and second mobile devices.</p>	<p>The Lyft Accused Products infringe directly and/or indirectly by performing, inducing others to perform, and/or contributing to the performance of: wherein the new entity of interest location is different from the locations of the first and second mobile devices.</p> <p>See claim 1[L]. The Lyft server(s) meets this limitation because a user can specify a new entity of interest that is not the same location of the rider location or driver location. For example, the user can specify another pickup/stop/destination which is different from the rider/driver locations.</p>

Attachment A for US Patent No. 10,341,838 Against Lyft Accused Products

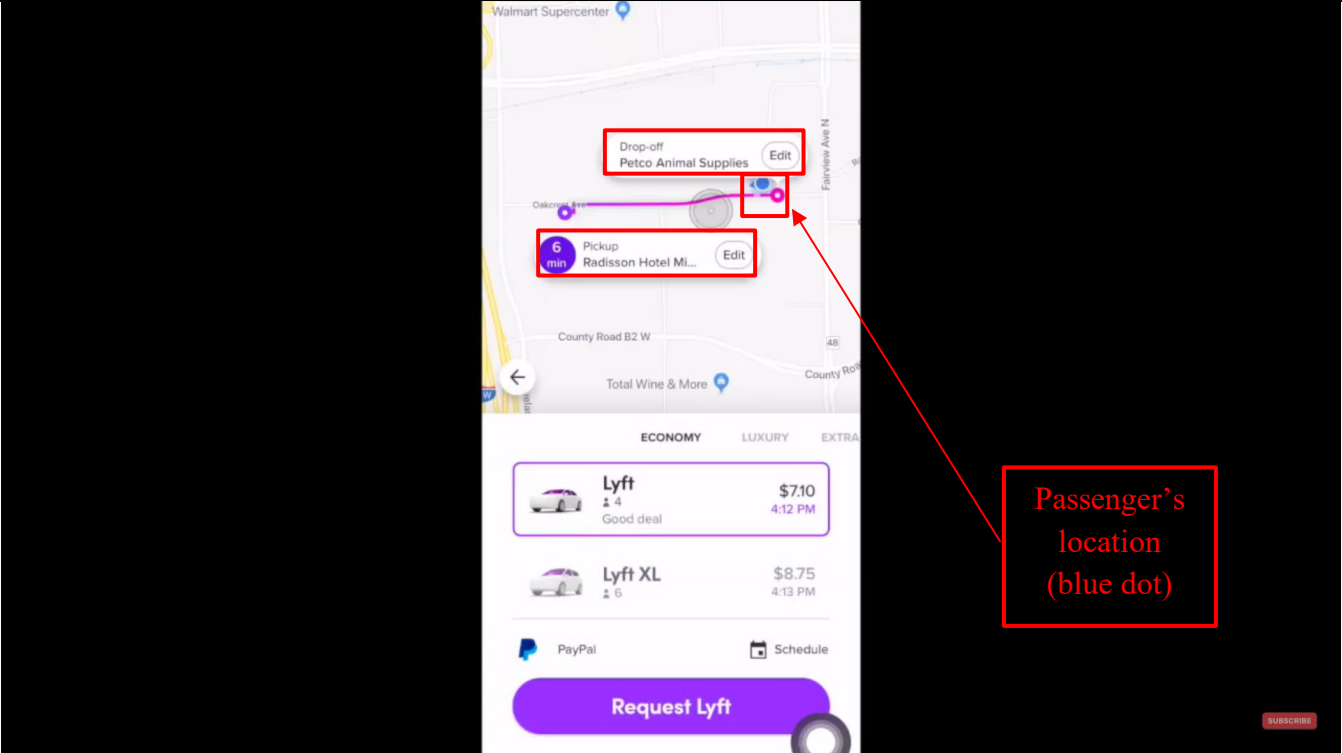
Claim 10,341,838	- Accused Products
	 <p data-bbox="1428 730 1638 885">Passenger's location (blue dot)</p> <p data-bbox="430 1015 1218 1047">https://www.youtube.com/watch?v=j0RDMLcmOgU at 3:49</p>

Attachment A for US Patent No. 10,341,838 Against Lyft Accused Products

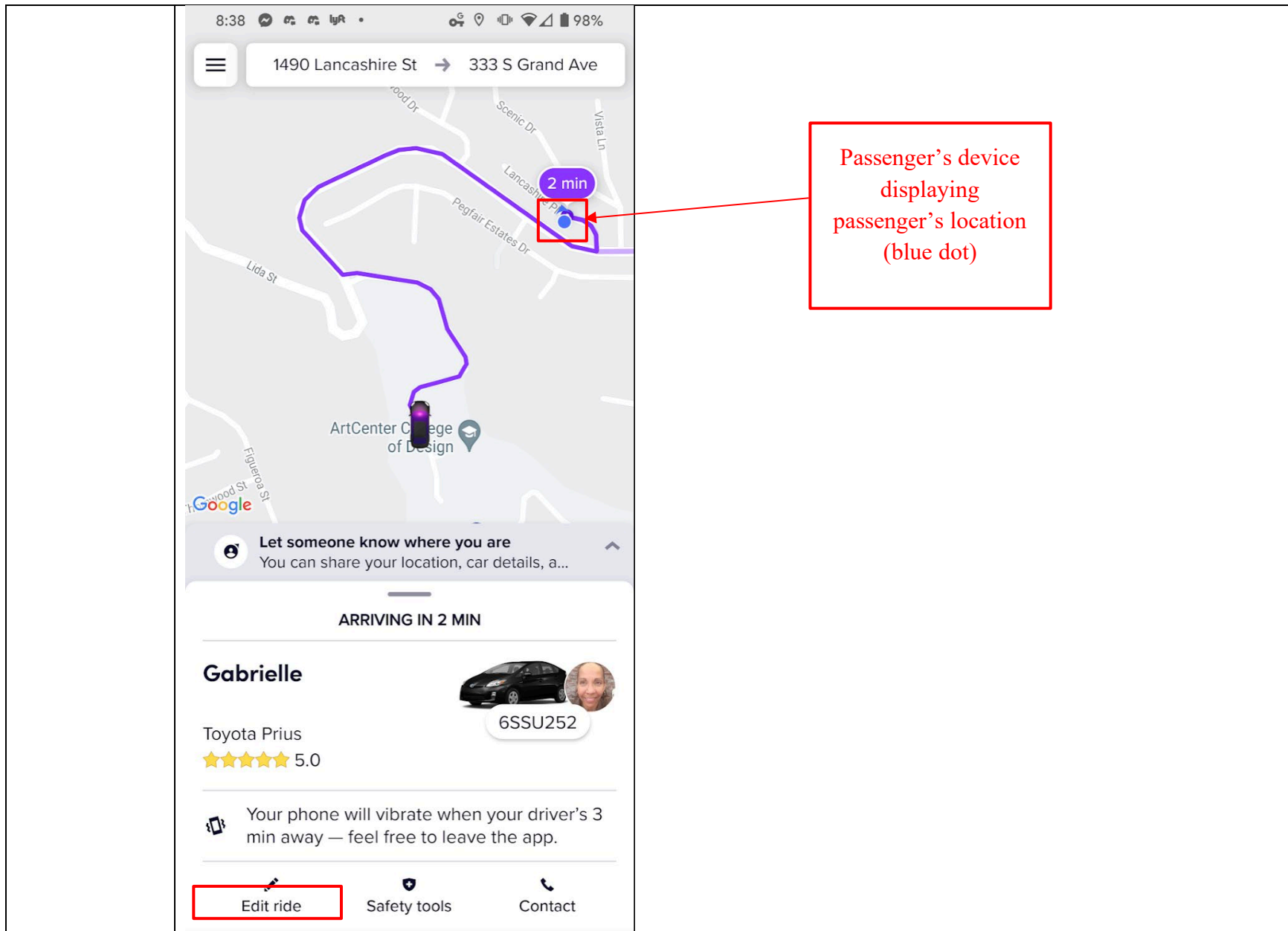

Attachment A for US Patent No. 10,341,838 Against Lyft Accused Products

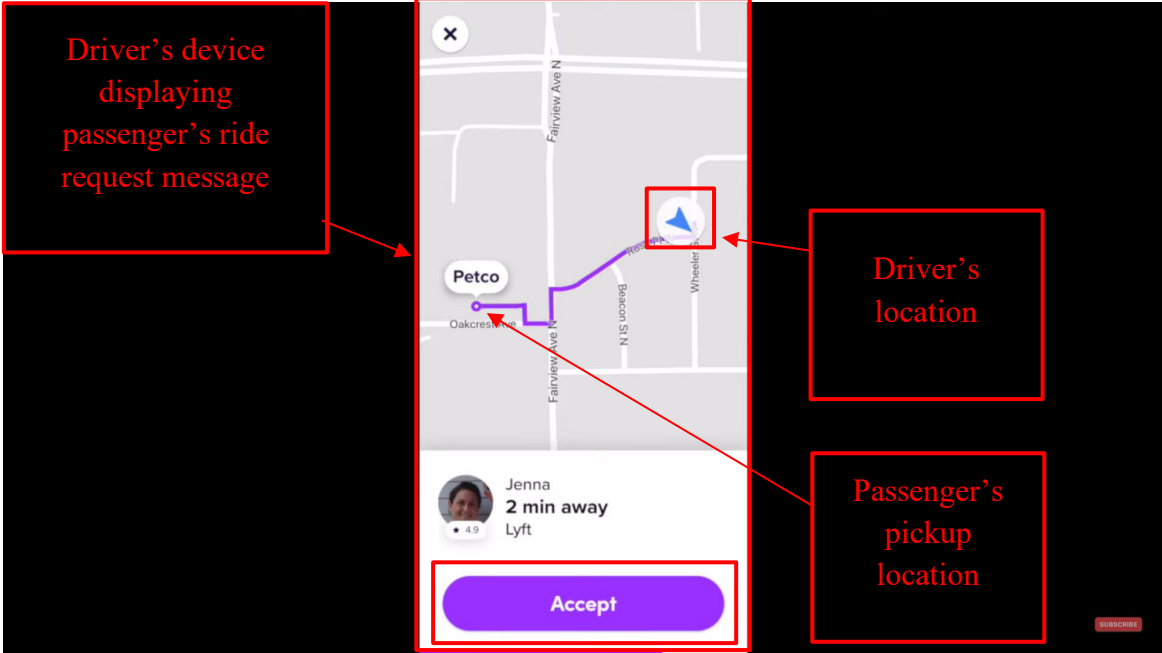
Claim 10,341,838	- Accused Products
	 <p>Driver's device displaying passenger's ride request message</p> <p>Driver's location</p> <p>Passenger's pickup location</p> <p>Accept</p> <p>Jenna 2 min away Lyft 4.9</p> <p>https://www.youtube.com/watch?v=jVUy9poJDng at 10:24, Annotated</p>

Attachment A for US Patent No. 10,341,838 Against Lyft Accused Products

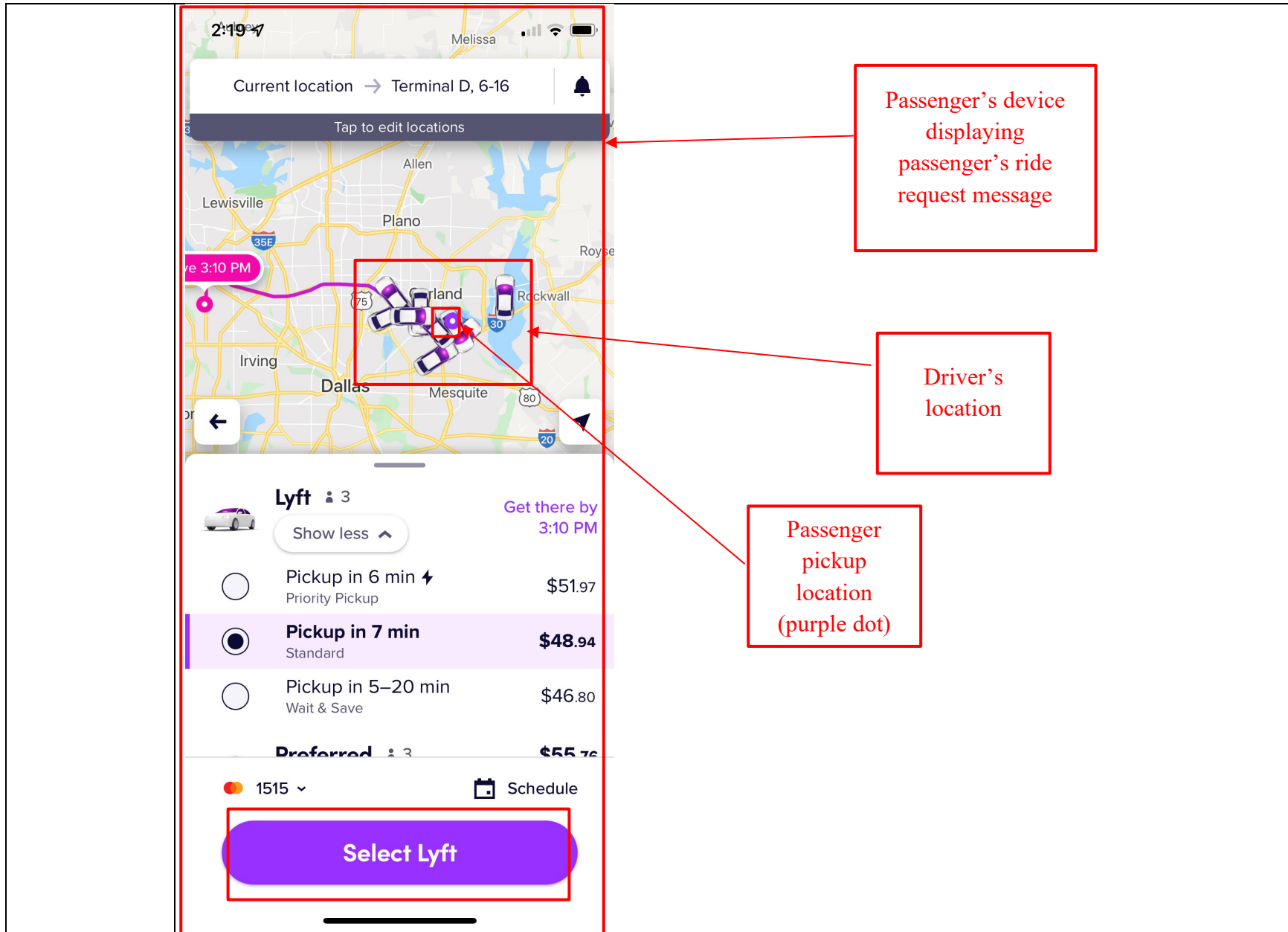

Attachment A for US Patent No. 10,341,838 Against Lyft Accused Products

Claim 10,341,838	- Accused Products
<p>13. The method of claim 5, wherein the message comprises at least one of a text message, a photograph, or a video.</p>	<p>The Lyft Accused Products infringe directly and/or indirectly by performing, inducing others to perform, and/or contributing to the performance of: wherein the message comprises at least one of a text message, a photograph, or a video.</p> <p>See claim 1[K].</p> <p>The Lyft server(s) meets this limitation because it can communicate at least text messages between riders/drivers via the Lyft apps. The Lyft server(s) also communicate profile photos to/from the apps.</p> <div data-bbox="428 740 1583 1390" style="border: 1px solid black; padding: 10px;"> </div> <p>https://www.youtube.com/watch?v=jVUy9poJDng at 10:24, Annotated</p>

Attachment A for US Patent No. 10,341,838 Against Lyft Accused Products

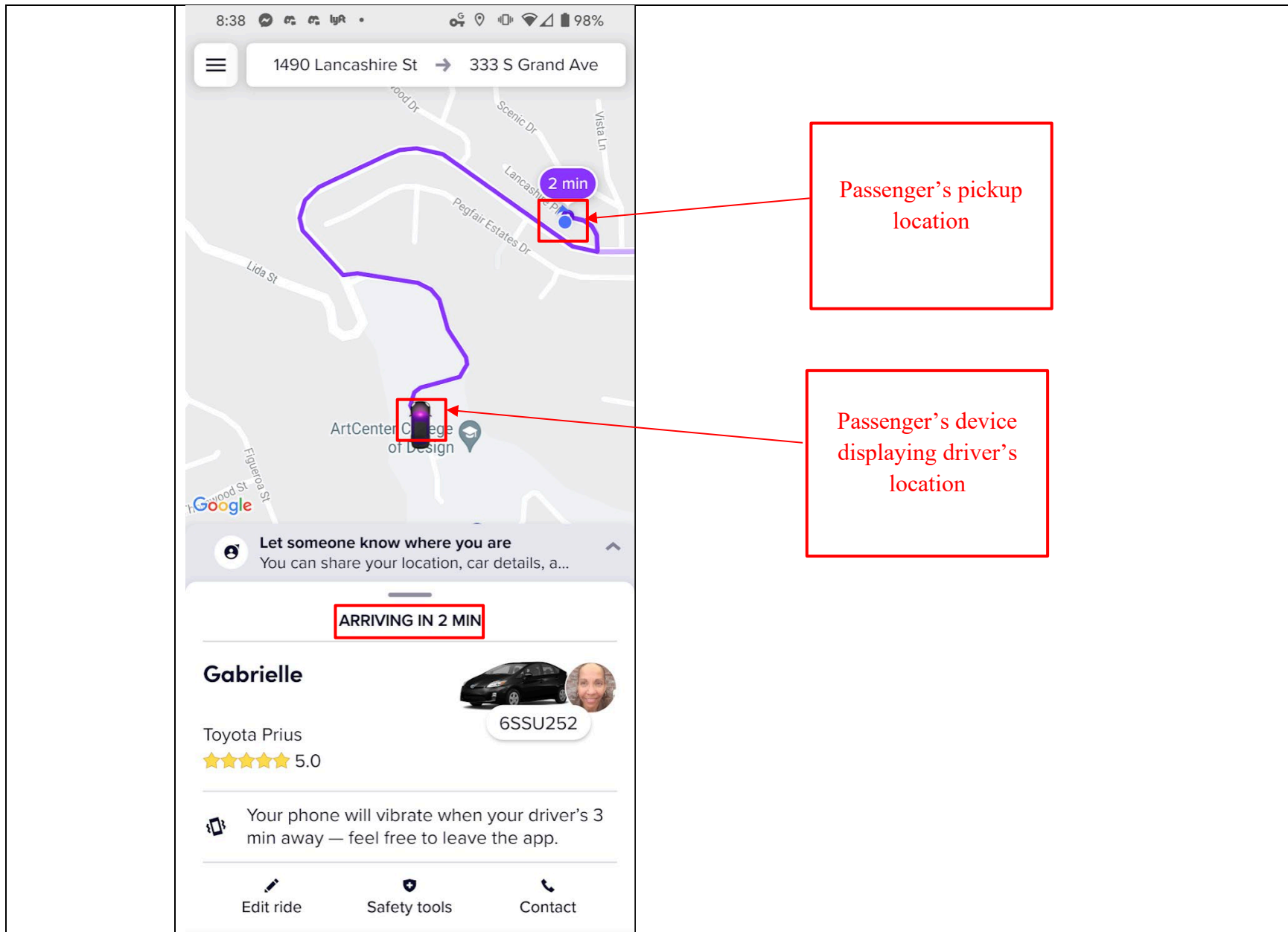

Attachment A for US Patent No. 10,341,838 Against Lyft Accused Products

Claim 10,341,838	- Accused Products
14[P]. A system comprising:	<i>See</i> Claims 1[P] and 1[A] above.
14[A]. one or more servers each having one or more processors, the processors configured to execute instructions to perform operations comprising:	<i>See</i> Claims 1[P] and 1[A] above.
14[B]. obtaining first data provided by a first mobile device corresponding to a vehicle, the first data including a first identifier	<i>See</i> Claim 1[B] above.
14 [C]. permitting the first mobile device corresponding	<i>See</i> Claim 1[C] above.

Attachment A for US Patent No. 10,341,838 Against Lyft Accused Products

Claim 10,341,838	- Accused Products
to the vehicle to join a communication network, the permitting based on a determination regarding the first data	
14[D]. obtaining second data provided by a second mobile device corresponding to a participant, the second data including a second identifier associated with the participant	<i>See Claim 1[D] above.</i>
14[E]. allowing the second mobile device corresponding to the participant to join the communication	<i>See Claim 1[E] above.</i>

Attachment A for US Patent No. 10,341,838 Against Lyft Accused Products

Claim 10,341,838	- Accused Products
network, the allowing based on a determination regarding the second data	
14[F]. receiving vehicle location data provided by the first mobile device corresponding to the vehicle, wherein the vehicle location data are associated with the first identifier and indicate coordinates of a geographical location of the first mobile device	<i>See Claim 1[F] above.</i>
14[G]. receiving participant location data	<i>See Claim 1[G] above.</i>

Attachment A for US Patent No. 10,341,838 Against Lyft Accused Products

Claim 10,341,838	- Accused Products
<p>provided by the second mobile device corresponding to the participant, wherein the participant location data are associated with the second identifier and indicate coordinates of a geographical location of the second mobile device</p>	
<p>14[H]. sending participant data to the second mobile device corresponding to the participant, wherein the participant data comprise the vehicle location data, wherein the</p>	<p><i>See Claim 1[H] above.</i></p>

Attachment A for US Patent No. 10,341,838 Against Lyft Accused Products

Claim 10,341,838	- Accused Products
<p>second mobile device corresponding to the participant is configured to (1) determine coordinates of a position on the participant map corresponding to the coordinates of the geographical location of the second mobile device, (2) display the participant map, and (3) place a first symbol on the participant map at the determined coordinates of the position on the participant map</p>	

Attachment A for US Patent No. 10,341,838 Against Lyft Accused Products

Claim 10,341,838	- Accused Products
<p>corresponding to the coordinates of the geographical location of the second mobile device</p>	
<p>14[I]. sending vehicle data to the first mobile device corresponding to the vehicle, wherein the vehicle data comprise the participant location data, wherein the first mobile device corresponding to the vehicle is configured to (1) determine coordinates of a position on the vehicle map corresponding to the</p>	<p><i>See Claim 1[I] above.</i></p>

Attachment A for US Patent No. 10,341,838 Against Lyft Accused Products

Claim 10,341,838	- Accused Products
<p>coordinates of the geographical location of the first mobile device, (2) display the vehicle map, and (3) place a second symbol on the vehicle map at the determined coordinates of the position on the vehicle map corresponding to the coordinates of the geographical location of the first mobile device</p>	
<p>14[J]. receiving participant selection data provided by the second mobile device corresponding</p>	<p>See Claim 1[J] above.</p>

Attachment A for US Patent No. 10,341,838 Against Lyft Accused Products

Claim 10,341,838	- Accused Products
to the participant, the participant selection data corresponding to user input provided via a display of the second mobile device	
14[K]. based on the participant selection data, performing one or more acts selected from the group consisting of: sending updated vehicle data to the first mobile device corresponding to the vehicle, sending updated participant data to the second mobile device	<i>See Claim 1[K] above.</i>

Attachment A for US Patent No. 10,341,838 Against Lyft Accused Products

Claim 10,341,838	- Accused Products
<p>corresponding to the participant, and sending a message to the first mobile device corresponding to the vehicle</p>	
<p>14[L]. receiving entity-of-interest data transmitted by the second mobile device, the entity-of-interest data comprising coordinates of a geographical location of a new entity of interest, wherein the second mobile device is configured to (1) identify participant interaction</p>	<p><i>See Claim 1[L] above.</i></p>

Attachment A for US Patent No. 10,341,838 Against Lyft Accused Products

Claim 10,341,838	- Accused Products
<p>with a display of the second mobile device, the participant interaction indicating selection of a position on the participant map and entry of the new entity of interest at the selected position, (2) display an entity symbol representing the new entity of interest at the selected position on the participant map, (3) determine coordinates of a geographical location of the new entity of interest based on coordinates of the selected</p>	

Attachment A for US Patent No. 10,341,838 Against Lyft Accused Products

Claim 10,341,838	- Accused Products
position on the participant map, and (4) transmit the entity-of-interest data; and	
14[M]. sending the entity-of-interest data to the first mobile device corresponding to the vehicle, wherein the first mobile device is configured to place the entity symbol representing the new entity of interest on the vehicle map at a position on the vehicle map corresponding to the geographical location of the	<i>See Claim 1[M] above.</i>

Attachment A for US Patent No. 10,341,838 Against Lyft Accused Products

Claim 10,341,838	- Accused Products
new entity of interest.	
15. The system of claim 14, wherein performing the one or more acts comprises sending, based on the participant selection data, the updated participant data to the second mobile device corresponding to the participant, wherein the second mobile device is configured to display the updated participant data within the participant map.	<i>See Claim 2 above.</i>
16. The system of claim 15,	<i>See Claim 3 above.</i>

Attachment A for US Patent No. 10,341,838 Against Lyft Accused Products

Claim 10,341,838	- Accused Products
<p>wherein the updated participant data comprise updated vehicle location data indicating coordinates of an updated geographical location of the first mobile device corresponding to the vehicle.</p>	
<p>17. The system of claim 14, wherein performing the one or more acts comprises sending, based on the participant selection data, the updated participant data to the second mobile device corresponding</p>	<p><i>See Claim 4 above.</i></p>

Attachment A for US Patent No. 10,341,838 Against Lyft Accused Products

Claim 10,341,838	- Accused Products
<p>to the participant, wherein the second mobile device is configured to replace the participant map with an updated participant map on the display of the second mobile device based at least in part on the updated participant data.</p>	
<p>18. The system of claim 14, wherein performing the one or more acts comprises sending, based on the participant selection data, the message to the first mobile</p>	<p><i>See Claim 5 above.</i></p>

Attachment A for US Patent No. 10,341,838 Against Lyft Accused Products

Claim 10,341,838	- Accused Products
device corresponding to the vehicle.	
19. The system of claim 18, wherein the message to the first mobile device corresponding to the vehicle includes the second identifier and updated participant location data.	<i>See Claim 6 above.</i>
20. The system of claim 14, wherein performing the one or more acts comprises sending, based on the participant selection data, the updated vehicle data to the first mobile device	<i>See Claim 7 above.</i>

Attachment A for US Patent No. 10,341,838 Against Lyft Accused Products

Claim 10,341,838	- Accused Products
<p>corresponding to the vehicle, wherein the first mobile device is configured to display the updated vehicle data within the vehicle map.</p>	
<p>21. The system of claim 14, wherein performing the one or more acts comprises sending, based on the participant selection data, the updated vehicle data to the first mobile device corresponding to the vehicle, wherein the first mobile device is configured to</p>	<p><i>See Claim 8 above.</i></p>

Attachment A for US Patent No. 10,341,838 Against Lyft Accused Products

Claim 10,341,838	- Accused Products
replace the vehicle map with an updated vehicle map on the display of the first mobile device based at least in part on the updated vehicle data.	
22. The system of claim 14, wherein the vehicle map is interactive.	<i>See Claim 9 above</i>
23. The system of claim 14, wherein the participant map is interactive.	<i>See Claim 10 above.</i>
24. The system of claim 14, wherein the new entity of interest is an event and the location of the new entity of interest is a	<i>See Claim 11 above.</i>

Attachment A for US Patent No. 10,341,838 Against Lyft Accused Products

Claim 10,341,838	- Accused Products
location of the event.	
25. The system of claim 14, wherein the new entity of interest location is different from the locations of the first and second mobile devices.	<i>See Claim 12 above.</i>
26. The system of claim 18, wherein the message comprises at least one of a text message, a photograph, or a video.	<i>See Claim 13 above.</i>

Attachment B for US Patent No. 7,031,724 Against Lyft Accused Products

Based on information presently available,¹ Defendant AGIS Software Development LLC (“AGIS Software”) contends that Plaintiff Lyft Technologies Inc. (“Lyft” or “Plaintiff”) infringes claims 9, 12-16 (the “Asserted Claims”) of U.S. Patent No. 7,630,724 (the “724 Patent”) through the Accused Products, Services which are manufactured, sold, offered for sale, and/or used by Lyft.

The Accused Products comprise the Lyft and Lyft Driver applications, servers, and services manufactured, used, or sold by Lyft, Inc. during and after 2016. AGIS Software reserves the right to seek leave of court to amend this list of Accused Products after the filing of an amended complaint or as discovery progresses.

Lyft directly infringes each of the Asserted Claims by making, using, importing, testing, distributing, selling, and/or offering for sale the Accused Products in violation of 35 U.S.C. § 271(a).

Lyft indirectly infringes the Asserted Claims in violation of 35 U.S.C. § 271(b) by inducing third parties, including its users and/or customers, to directly infringe through their operation and use of the Accused Products. Lyft has knowingly and intentionally induced this direct infringement by, *inter alia*, (i) selling, importing, or otherwise providing the Accused Products to third parties with the intent that the Accused Products will be operated and used in a manner that practices the Asserted Claims; and (ii) marketing and advertising the Accused Products. Lyft’s marketing and promotional materials for the Accused Products are found, for example, on Lyft’s website, and in App stores of operating systems for which the Accused Products are made available. For example, Lyft’s website offers customers instructions and/or manuals for the Accused Products that instruct customers to, among other things, use the accused services in the Accused Products. Lyft’s website also offers support to customers, including instruction to, among other things, use the Accused Products share location information with a group of users. Lyft knows, or should have known, that its actions will result in infringement of the Asserted Claims, or subjectively believes that there is a high probability that its actions will result in infringement of the Asserted Claims but has taken deliberate actions to avoid learning these facts.

Lyft also contributorily infringes each of the Asserted Claims in violation of 35 U.S.C. § 271(c) by selling, importing, offering for sale, and otherwise providing the Accused Products, which when used directly infringe the Asserted Claims. The Accused Products constitute a material part of the Asserted Claims.

¹ There is no operative complaint asserting non-infringement of any patent claim in this action at this time. AGIS Software reserves the right to update its contentions upon receipt of any future amended complaint.

Attachment B for US Patent No. 7,031,724 Against Lyft Accused Products

The following chart identifies specifically where each limitation of each Asserted Claim is found within the Accused Products, and in particular, the corresponding elements that meet the limitations in the Lyft and Lyft Driver applications, services, and services. On information and belief, each charted version of the Lyft Rider and Driver Apps are representative of all versions of the Accused Products, including all variants of the Accused Products made, sold, offered for sale, or used on any version of the Android and iOS operating systems.

AGIS Software does not concede that any claims of the '724 Patent that are not listed below are not infringed by the identified Accused Products. Moreover, the citations to certain documents and other information below are intended to be exemplary only and in no way foreclose AGIS from citing or relying on additional documents, information, source code, and/or testimony at a later time. These contentions are preliminary in nature and an analysis of Lyft's products, internal documentation, source code, and/or testimony from relevant witnesses may more fully and accurately describe the infringing features of its accused products. Accordingly, AGIS Software reserves the right to seek leave of court to supplement, correct, modify, and/or amend these contentions once such additional information is made available to AGIS Software. Furthermore, AGIS Software reserves the right to seek leave of court to supplement, correct, modify, and/or amend these contentions as discovery in this case progresses; in view of the Court's claim construction order(s);² in view of any positions taken by Lyft, including but not limited to positions on claim construction, invalidity, and/or non-infringement; and in connection with the preparation and exchange of expert reports.

The contents of each claim cell below on which another claim cell depends are expressly incorporated by reference in that dependent cell, as if set forth in their entirety therein.

² The construction of claim terms herein is consistent with the constructions in *AGIS Software Dev. LLC v. Huawei Device USA, Inc.*, No. 2:17-cv-00513-JRG, Dkt. 205 (E.D. Tex. Oct. 10, 2018); *AGIS Software Dev. LLC v. Google LLC*, No. 2:19-cv-00361-JRG, Dkt. 147 (E.D. Tex. Dec. 8, 2020); *AGIS Software Dev. LLC v. T-Mobile USA, Inc., et al.*, No. 2:21-cv-00072-JRG, Dkt. 213 (E.D. Tex. Nov. 10, 2021). AGIS Software reserves the right to update its constructions and contentions in view of this Court's claim construction order.

Attachment B for US Patent No. 7,630,724 Against Lyft Accused Products

Claim – 7,630,724	Accused Products
<p>9[P]. A method for providing a cellular phone communication network for designated participating users, each user having a similarly equipped cellular phone that includes a CPU, GPS navigational system, an interact message transmitter and receiver and a touch screen display comprising:</p>	<p>The Lyft Accused Products perform a computer implemented method as set forth below. Lyft further infringes directly and/or indirectly by performing, inducing others to perform, and/or contributing to the performance of: a method for providing a cellular phone communication network for designated participating users, each user having a similarly equipped cellular phone that includes a CPU, GPS navigational system, an interact message transmitter and receiver and a touch screen display.</p> <p>For example, Lyft provides Lyft app for passengers and Lyft Driver app for drivers. The Lyft apps for riders and drivers, in conjunction with Lyft’s servers and services, provide users with interactive methods to request, view, and track locations of passengers/riders using real-time maps and communications. The Lyft server(s) and their services communicate with the Lyft apps for riders and drivers. The Lyft server(s) and their services host information related to and instructions for processing user/device/vehicle accounts, location data, and map data. The claimed methods are distributed by Lyft in the Lyft apps. The claimed methods are used/tested by Lyft using the Lyft apps. The claimed methods are downloaded and installed by Lyft’s customers (riders) and personnel (drivers, personnel) at the direction/encouragement of Lyft and used by Lyft’s customers and Lyft’s personnel.</p> <p>. Each of the driver and the passenger’s mobile phones which are installed with the Lyft and Lyft driver apps comprises a CPU, GPS, a navigational system symbol generator (Lyft App and Lyft Driver App) and a touch screen display. The Lyft and Lyft Driver application is supported by smart devices including but not limited to smartphones and tablets, which have an antenna in them for both transmission and reception.</p> <h2 data-bbox="583 1084 1066 1156">Lyft Driver app</h2> <div data-bbox="577 1198 1814 1279" style="border: 1px solid red; padding: 5px;"> <p>We’ve separated the passenger and driver experiences into two separate mobile apps — one exclusively for passengers (named the Lyft app) and the other exclusively for drivers (named the Lyft Driver app).</p> </div> <p>The Lyft Driver app will eventually be standard for all drivers and required for driving. At this time, drivers can keep using the Lyft app to give rides. Don’t worry! While we have some planned improvements to the Lyft Driver app, we’ve kept its features the same.</p>

Attachment B for US Patent No. 7,630,724 Against Lyft Accused Products

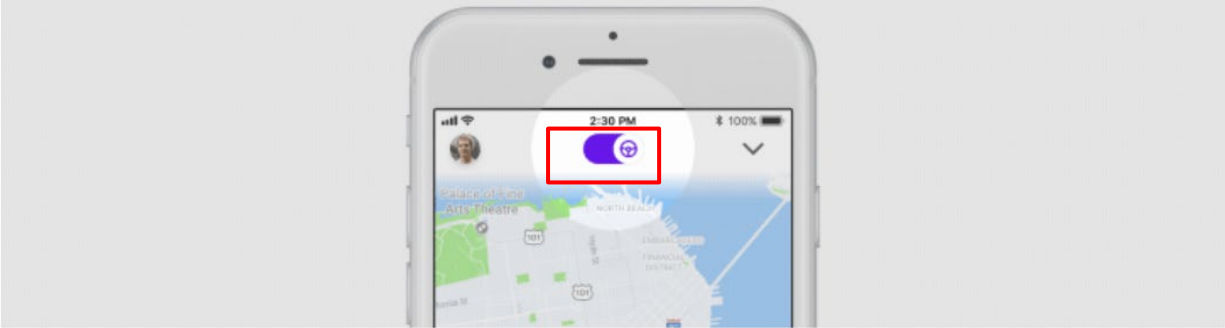
Claim – 7,630,724	Accused Products
	<p data-bbox="577 272 1470 305">https://help.lyft.com/hc/en-ca/articles/115013079208-Lyft-Driver-app</p> <h2 data-bbox="577 354 886 402">What is Lyft?</h2> <p data-bbox="577 456 1654 526">Lyft is a platform that connects drivers with individuals and organizations that need rides.</p> <p data-bbox="577 553 1050 586">https://www.lyft.com/drive-with-lyft</p>  <p data-bbox="577 1019 699 1047">Go online</p> <p data-bbox="577 1084 1774 1192">Open your Lyft Driver app and tap the steering wheel icon. Lyft will now find the closest passenger to your location requesting a ride. Turn on some music and get comfortable: that first ride request may come quickly or may take a while, depending on the number of current passenger requests.</p> <p data-bbox="577 1198 1234 1230">https://www.lyft.com/hub/posts/how-to-give-a-ride</p>

Attachment B for US Patent No. 7,630,724 Against Lyft Accused Products

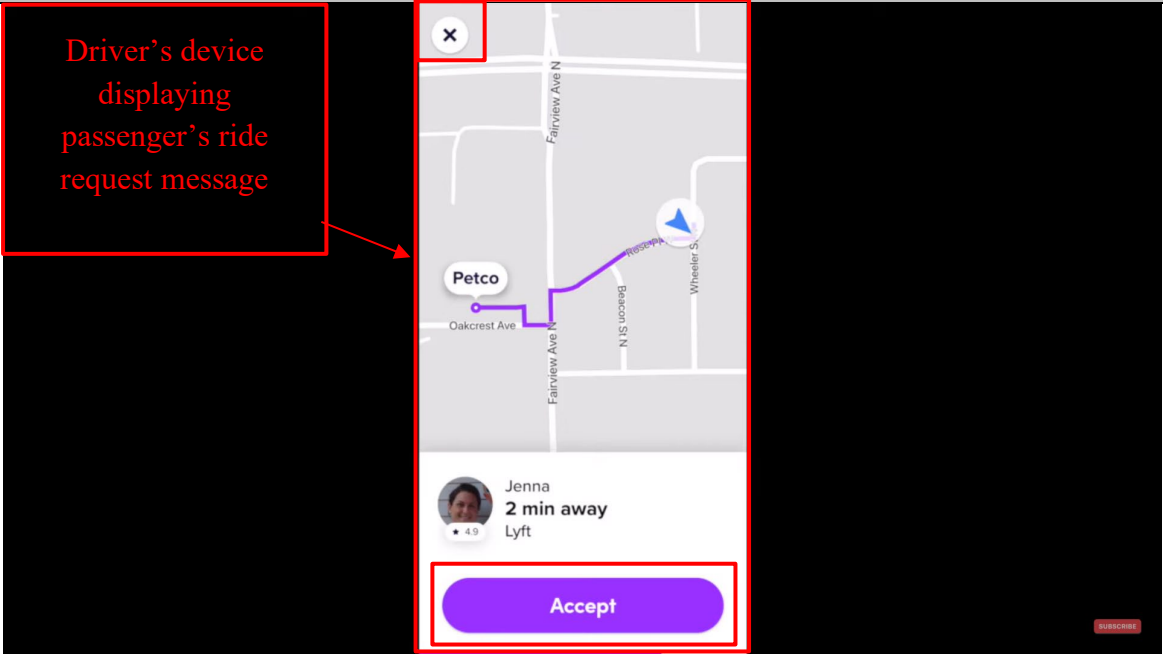
Claim – 7,630,724	Accused Products
	<p data-bbox="625 261 835 423">Driver's device displaying passenger's ride request message</p>  <p data-bbox="575 883 1486 914">https://www.youtube.com/watch?v=jVUy9poJDng at 10:24, Annotated</p>

Attachment B for US Patent No. 7,630,724 Against Lyft Accused Products

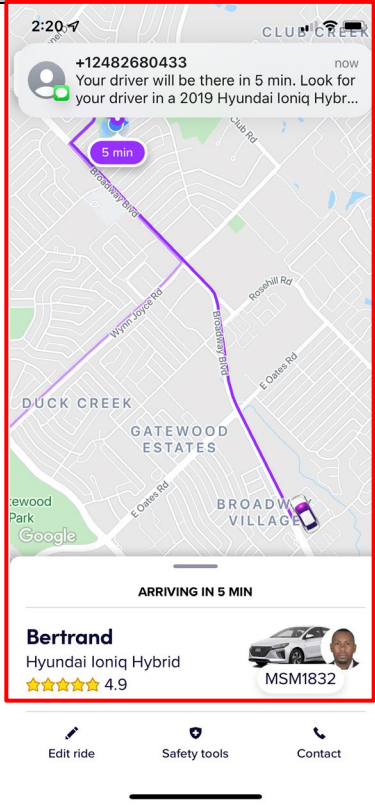
Claim – 7,630,724	Accused Products
	 <p data-bbox="1094 289 1417 537">Passenger's device displaying passenger's ride request message</p>

Attachment B for US Patent No. 7,630,724 Against Lyft Accused Products

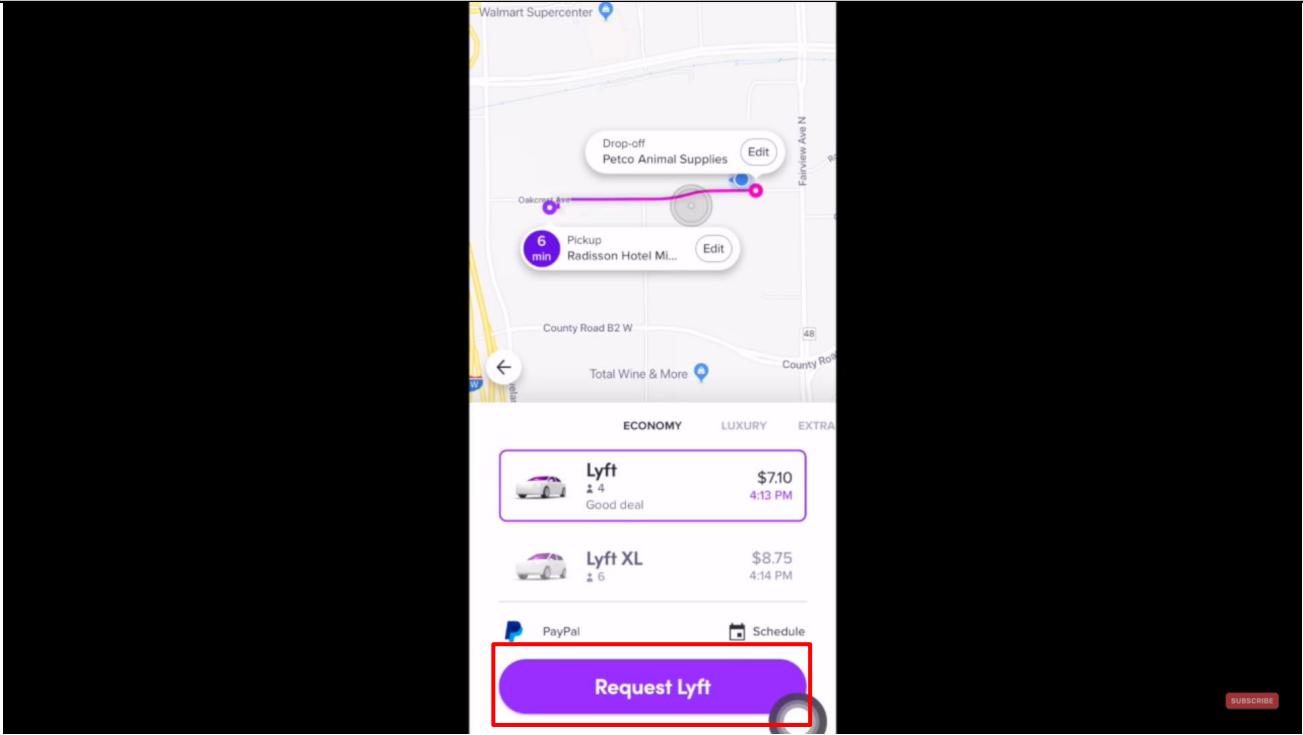
Claim – 7,630,724	Accused Products
	 <p>https://www.youtube.com/watch?v=j0RDMLcmOgU at 4:01</p>

Attachment B for US Patent No. 7,630,724 Against Lyft Accused Products

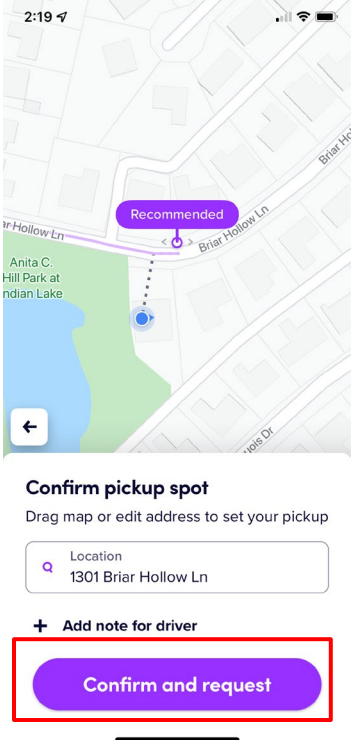
Claim – 7,630,724	Accused Products
	 <p>2:19</p> <p>Recommended</p> <p>Briar Hollow Ln</p> <p>Anita C. Hill Park at Indian Lake</p> <p>Confirm pickup spot</p> <p>Drag map or edit address to set your pickup</p> <p>Location 1301 Briar Hollow Ln</p> <p>+ Add note for driver</p> <p>Confirm and request</p>

Attachment B for US Patent No. 7,630,724 Against Lyft Accused Products

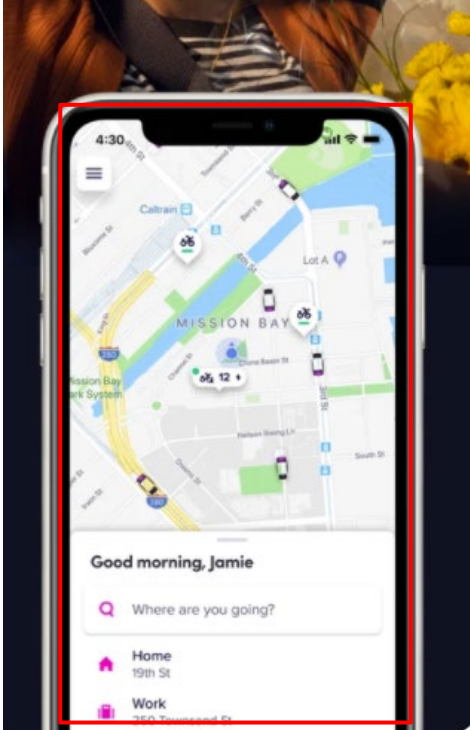
Claim – 7,630,724	Accused Products
	 <p>https://apps.apple.com/in/app/lyft/id529379082</p>

Attachment B for US Patent No. 7,630,724 Against Lyft Accused Products

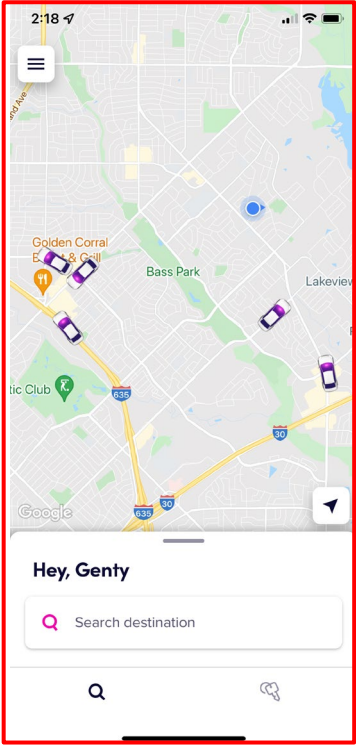
Claim – 7,630,724	Accused Products
	 <p>The screenshot shows a mobile application interface. At the top, the time is 2:18. Below the time is a hamburger menu icon. The main area is a map showing a residential neighborhood with several purple car icons scattered across it. Landmarks include 'Golden Corral E. & Grill', 'Bass Park', and 'Lakeview'. A search bar at the bottom contains the text 'Hey, Genty' and a magnifying glass icon. Below the search bar is a text input field with the placeholder 'Search destination'. At the very bottom are two icons: a magnifying glass and a hand cursor.</p>

Attachment B for US Patent No. 7,630,724 Against Lyft Accused Products

Claim – 7,630,724	Accused Products
	<p data-bbox="583 240 1808 396">Combining multiple components into a single chip saves on space, cost, and power consumption. Essentially, an SoC is the brain of your smartphone that handles everything from the Android operating system to detecting when you press the power off button. SoCs connect to other components too, such as cameras, a display, RAM, flash storage, and much more.</p> <p data-bbox="583 443 1787 513">The list below contains the most common components that you will find inside a smartphone System-on-a-Chip. We’re going to cover a few of the most important ones later on in this article.</p> <ul data-bbox="642 540 1782 1138" style="list-style-type: none"> <li data-bbox="642 540 1782 639">• Central Processing Unit (CPU) — The “brains” of the SoC. Runs most of the code for the Android OS and most of your apps. <li data-bbox="642 646 1782 716">• Graphics Processing Unit (GPU) — Handles graphics-related tasks, such as visualizing an app’s user interface and 2D/3D gaming. <li data-bbox="642 722 1782 792">• Image Processing Unit (ISP) — Converts data from the phone’s camera into image and video files. <li data-bbox="642 799 1782 868">• Digital Signal Processor (DSP) — Handles more mathematically intensive functions than a CPU. Includes decompressing music files and analyzing gyroscope sensor data. <li data-bbox="642 875 1782 945">• Neural Processing Unit (NPU) — Used in high-end smartphones to accelerate machine learning (AI) tasks. These include voice recognition and camera processing. <li data-bbox="642 951 1782 1021">• Video encoder/decoder — Handles the power-efficient conversion of video files and formats. <li data-bbox="642 1027 1782 1097">• Modems — Converts wireless signals into data your phone understands. Components include 4G LTE, 5G, WiFi, and Bluetooth modems. <p data-bbox="569 1149 1745 1182">https://www.androidauthority.com/what-is-an-soc-smartphone-chipsets-explained-1051600/</p>

Attachment B for US Patent No. 7,630,724 Against Lyft Accused Products

Claim – 7,630,724	Accused Products
	<p data-bbox="577 235 1738 414">You must have seen that every Android and iOS device in today's age comes with GPS right inside it. This is one feature that will be there in every smartphone no matter what the price of that device might be. And that is because of the fact that GPS is the most basic yet most useful feature on every smartphone.</p> <p data-bbox="577 462 1766 730">Just for information, the GPS stands for Global Positioning System and it provides accurate geolocation and time information for every equipment that is equipped with a GPS receiver. Now, the best example of using GPS is with services such as Google Maps, Apple Maps, and others where you can see where exactly you are right now on the Map. This is thanks to the GPS receiver which sends a signal to the GPS satellite.</p> <p data-bbox="577 738 1520 776">https://www.cashify.in/how-to-turn-off-gps-on-any-android-or-ios-device</p>

Attachment B for US Patent No. 7,630,724 Against Lyft Accused Products

Claim – 7,630,724	Accused Products
	<p data-bbox="583 245 1104 305">Mobile phone contents</p> <p data-bbox="583 337 1860 480">Mobile phones contain a large amount of circuitry, each of which is carefully designed to optimise its performance. The cell phone comprises analogue electronics as well as digital circuits ranging from processors to display and keypad electronics. A mobile phone typically consists of a single board, but within this there are a number of distinct functional areas, but designed to integrate to become a complete mobile phone:</p> <ul data-bbox="600 505 1129 829" style="list-style-type: none"> <li data-bbox="600 505 1129 553">• Radio frequency - receiver and transmitter <li data-bbox="600 570 915 602">• Digital signal processing <li data-bbox="600 626 968 659">• Analogue / digital conversion <li data-bbox="600 683 842 716">• Control processor <li data-bbox="600 740 831 773">• SIM or USIM card <li data-bbox="600 797 926 829">• Power control and battery <p data-bbox="569 854 1881 927">https://www.electronics-notes.com/articles/connectivity/cellular-mobile-phone/how-cellphone-works-inside-components.php</p> <p data-bbox="569 1040 1898 1179">Further, to the extent this element is performed at least in part by Lyft's software source code, AGIS reserves the right to supplement these contentions pursuant to production of such source code by Lyft and to the extent Lyft requires additional information in accordance with P.R. 3-1 and for any other reasons.</p>
<p data-bbox="201 1190 546 1403">9[A] accessing a database in each cell phone that includes a geographical map of a predetermined area for user viewing on the touch screen display;</p>	<p data-bbox="569 1190 1898 1333">The Lyft Accused Products perform a computer implemented method as set forth below. Lyft further infringes directly and/or indirectly by performing, inducing others to perform, and/or contributing to the performance of: accessing a database in each cell phone that includes a geographical map of a predetermined area for user viewing on the touch screen display.</p>

Attachment B for US Patent No. 7,630,724 Against Lyft Accused Products

Claim – 7,630,724	Accused Products
	<p>For example, in the Lyft app for passengers, the passenger will receive a geographical location on the map on the display of their mobile phone. The geographical map is accessed through the database of the Lyft app. Through this geographical map, the passenger is able to make a ride request to a particular location and see the location of different nearby drivers before making the request and viewing the location of the driver after a driver accepts the passenger's ride request.</p> <p>For example, in the Lyft driver app, the driver will receive a geographical map of their location, which is accessed through the database of the Lyft driver application. Through this app, the driver is able to see the location of the rider, when the ride request message of the passenger is broadcasted with the passenger's pickup location (provided pickup location is set to the current location by the passenger).</p>

Attachment B for US Patent No. 7,630,724 Against Lyft Accused Products

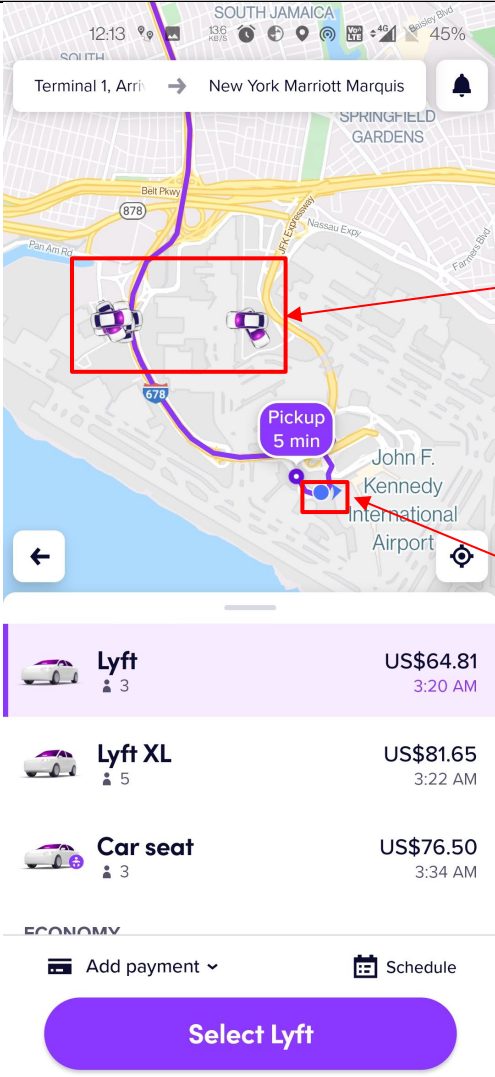
Claim – 7,630,724	Accused Products												
	 <p>The screenshot displays the Lyft app interface. At the top, the destination is set to 'New York Marriott Marquis'. The map shows the area around JFK Airport, with a red box highlighting two nearby driver icons and another red box highlighting the passenger's location. Below the map, three ride options are listed:</p> <table border="1"><thead><tr><th>Ride Type</th><th>Price</th><th>ETA</th></tr></thead><tbody><tr><td>Lyft (3 seats)</td><td>US\$64.81</td><td>3:20 AM</td></tr><tr><td>Lyft XL (5 seats)</td><td>US\$81.65</td><td>3:22 AM</td></tr><tr><td>Car seat (3 seats)</td><td>US\$76.50</td><td>3:34 AM</td></tr></tbody></table> <p>At the bottom, there is a 'Select Lyft' button.</p>	Ride Type	Price	ETA	Lyft (3 seats)	US\$64.81	3:20 AM	Lyft XL (5 seats)	US\$81.65	3:22 AM	Car seat (3 seats)	US\$76.50	3:34 AM
Ride Type	Price	ETA											
Lyft (3 seats)	US\$64.81	3:20 AM											
Lyft XL (5 seats)	US\$81.65	3:22 AM											
Car seat (3 seats)	US\$76.50	3:34 AM											

Attachment B for US Patent No. 7,630,724 Against Lyft Accused Products

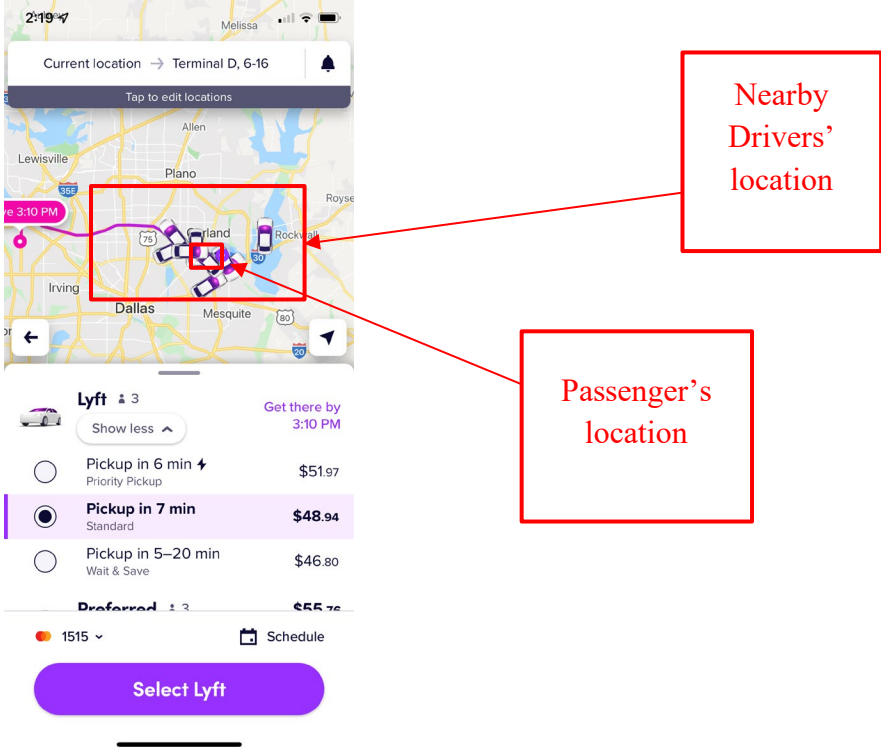
Claim – 7,630,724	Accused Products
	 <p>The screenshot displays the Lyft mobile application interface. At the top, the current location is set to 'Terminal D, 6-16'. Below the map, there are three ride options: 'Priority Pickup' (6 min, \$51.97), 'Standard' (7 min, \$48.94), and 'Wait & Save' (5-20 min, \$46.80). A 'Preferred' option is also visible at \$55.76. The interface includes a 'Select Lyft' button at the bottom. Two red boxes with arrows point to specific locations on the map: one labeled 'Nearby Drivers' location and another labeled 'Passenger's location'.</p>

Attachment B for US Patent No. 7,630,724 Against Lyft Accused Products

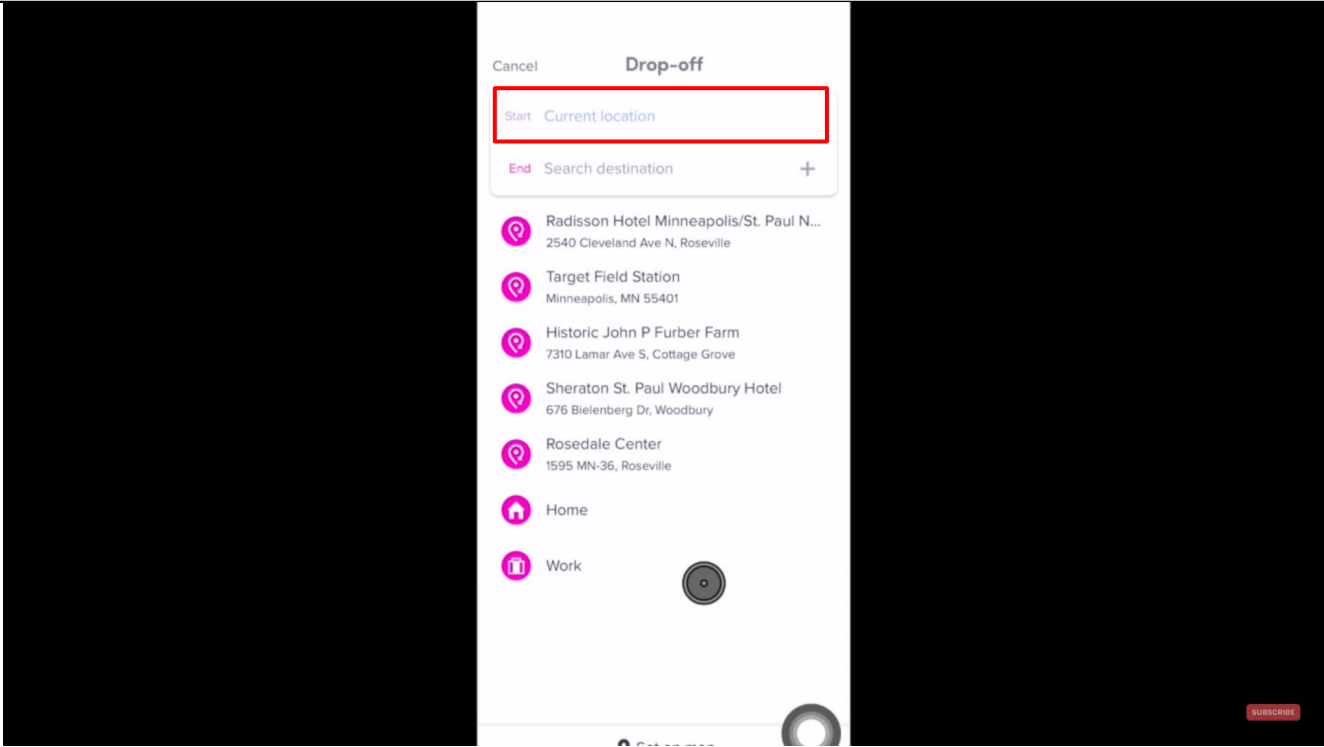
Claim – 7,630,724	Accused Products
	 <p>https://www.youtube.com/watch?v=j0RDMLcmOgU at 3:27</p>

Attachment B for US Patent No. 7,630,724 Against Lyft Accused Products

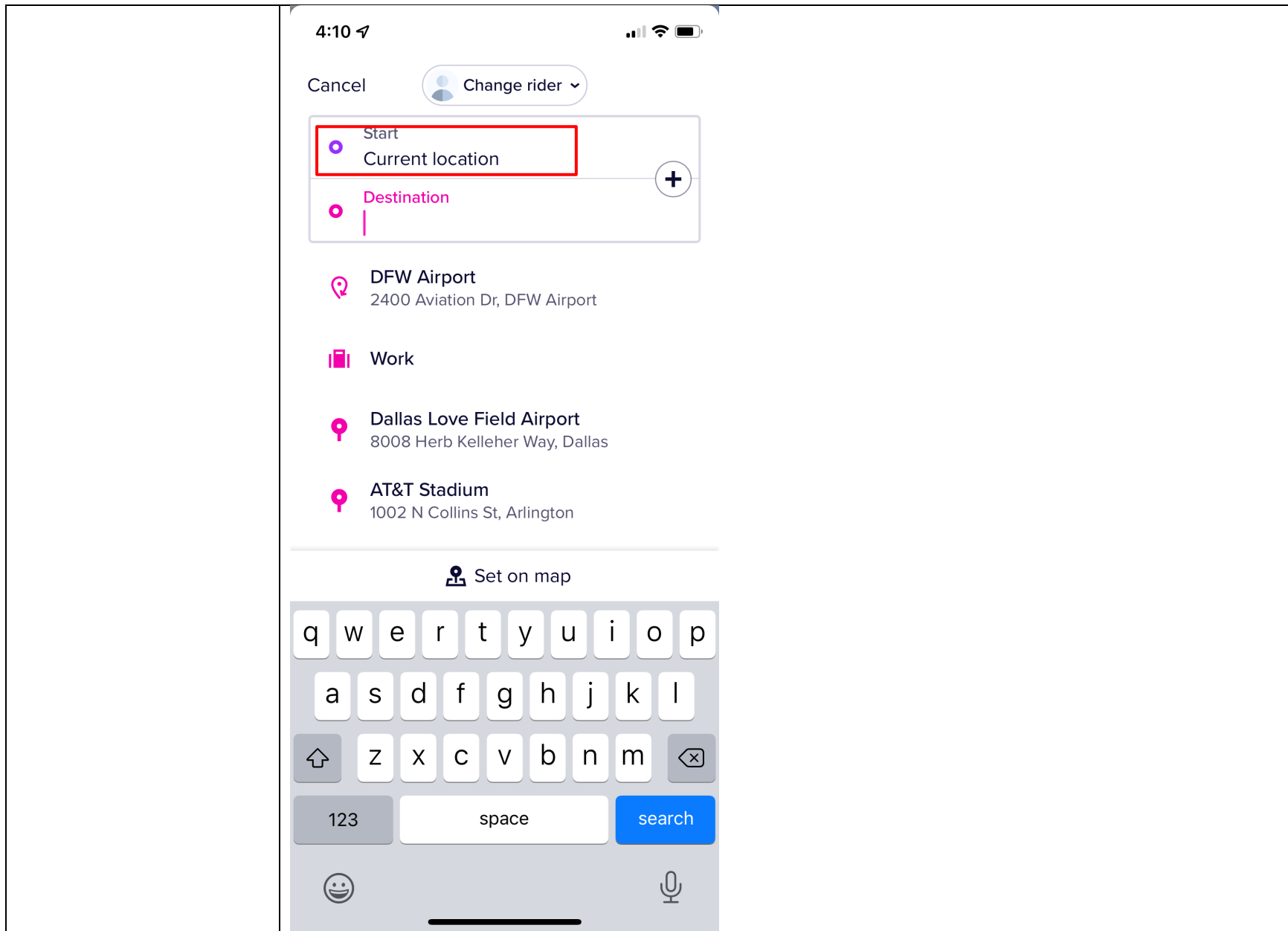

Attachment B for US Patent No. 7,630,724 Against Lyft Accused Products

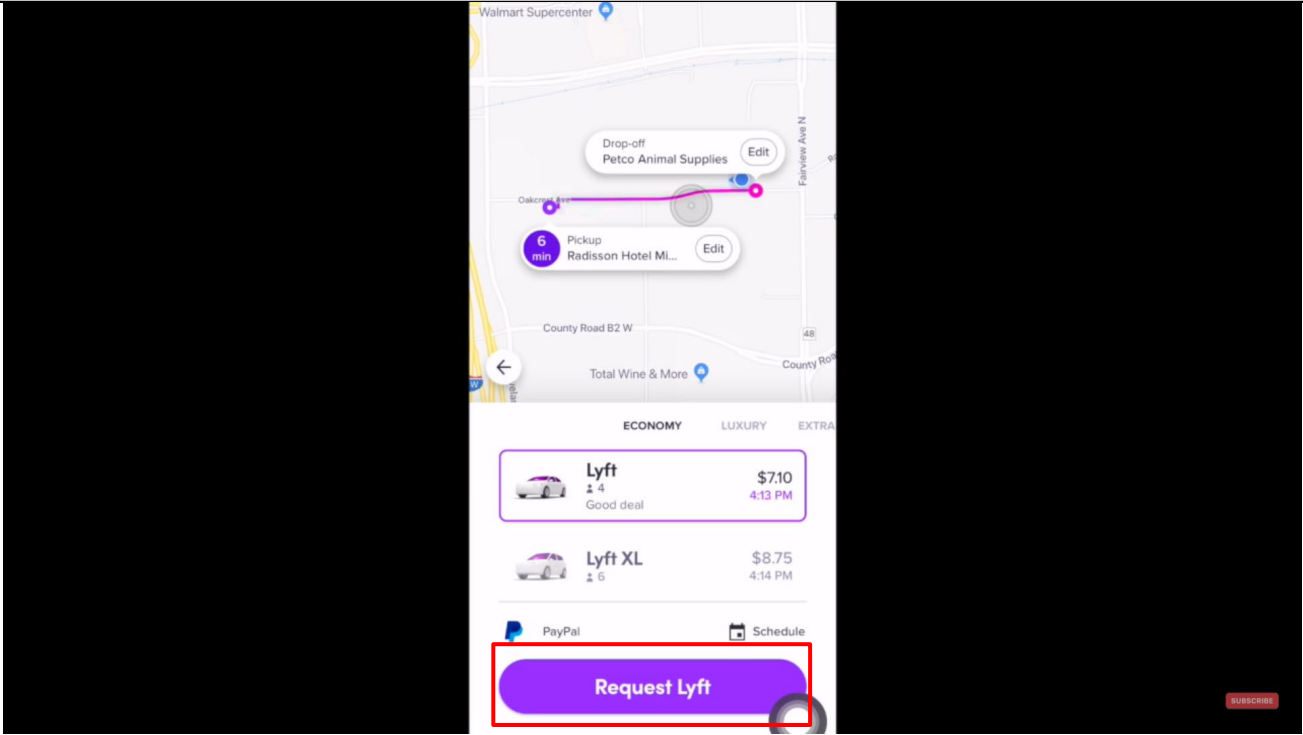
Claim – 7,630,724	Accused Products
	 <p>https://www.youtube.com/watch?v=j0RDMLcmOgU at 4:01</p>

Attachment B for US Patent No. 7,630,724 Against Lyft Accused Products

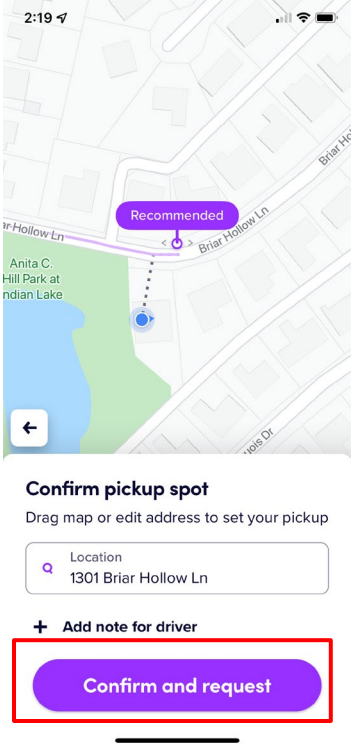
Claim – 7,630,724	Accused Products
	 <p>The screenshot displays a mobile application interface for a ride-sharing service. At the top, a map shows a recommended pickup location at 1301 Briar Hollow Ln, marked with a purple pin and a 'Recommended' label. Below the map, the text 'Confirm pickup spot' is followed by the instruction 'Drag map or edit address to set your pickup'. A search bar contains the text 'Location 1301 Briar Hollow Ln'. Below this, there is a plus sign icon and the text '+ Add note for driver'. At the bottom, a prominent purple button labeled 'Confirm and request' is highlighted with a red rectangular border. The interface also shows a back arrow on the left and a home indicator bar at the very bottom.</p>

Attachment B for US Patent No. 7,630,724 Against Lyft Accused Products

Claim – 7,630,724	Accused Products
	 <p>Driver's device displaying passenger's ride request message</p> <p>Passenger's current location (when pickup location is set to current location)</p> <p>Driver's current location</p> <p>https://www.youtube.com/watch?v=jVUy9poJDng at 10:24, Annotated</p>

Attachment B for US Patent No. 7,630,724 Against Lyft Accused Products

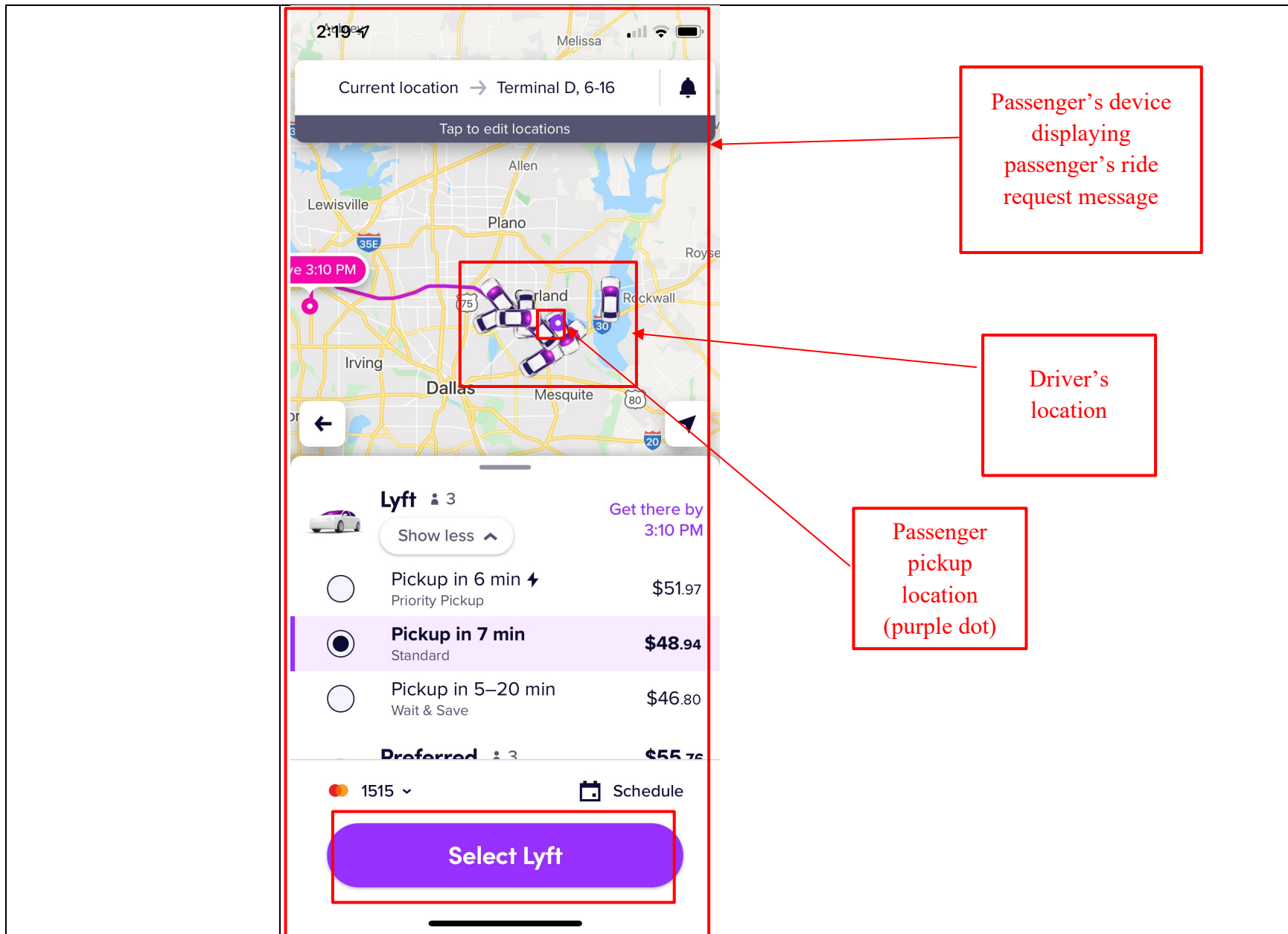

Attachment B for US Patent No. 7,630,724 Against Lyft Accused Products

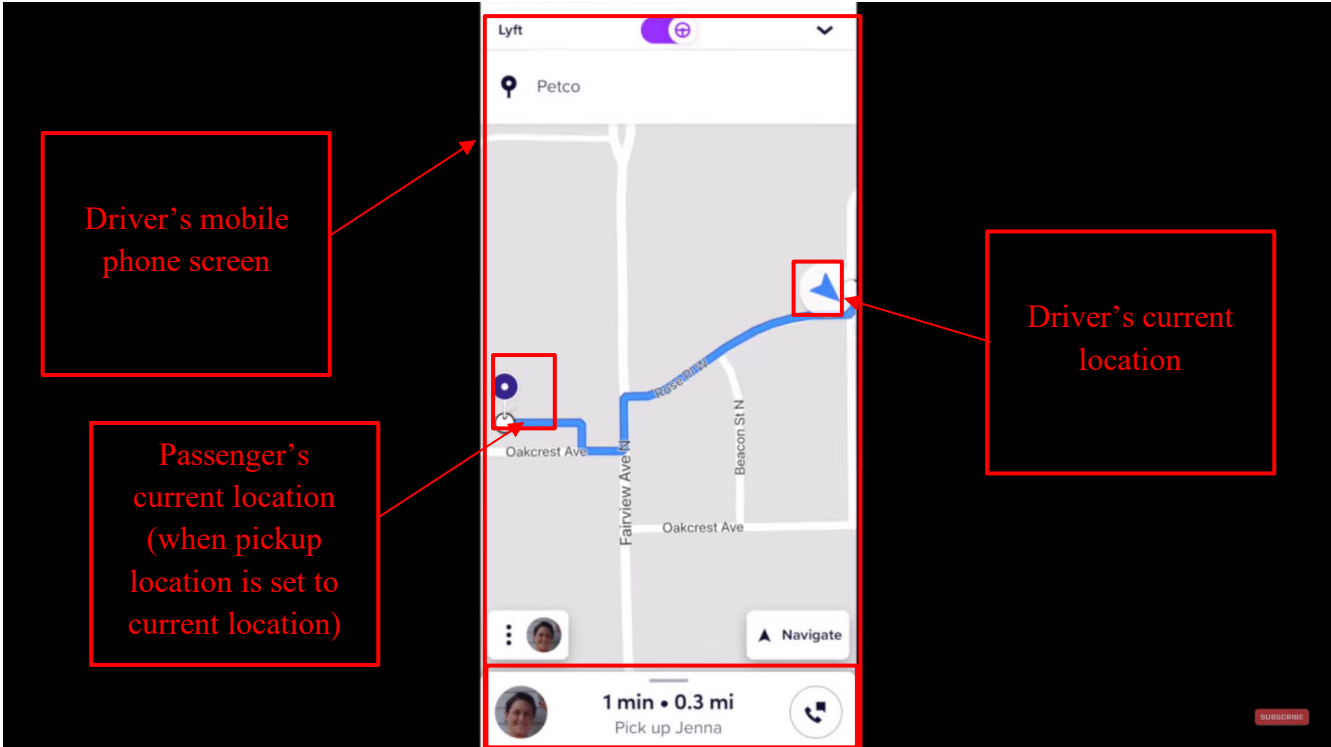
Claim – 7,630,724	Accused Products
	 <p>Driver's mobile phone screen</p> <p>Passenger's current location (when pickup location is set to current location)</p> <p>Driver's current location</p> <p>https://www.youtube.com/watch?v=jVUy9poJDng at 10:46, Annotated</p>

Attachment B for US Patent No. 7,630,724 Against Lyft Accused Products

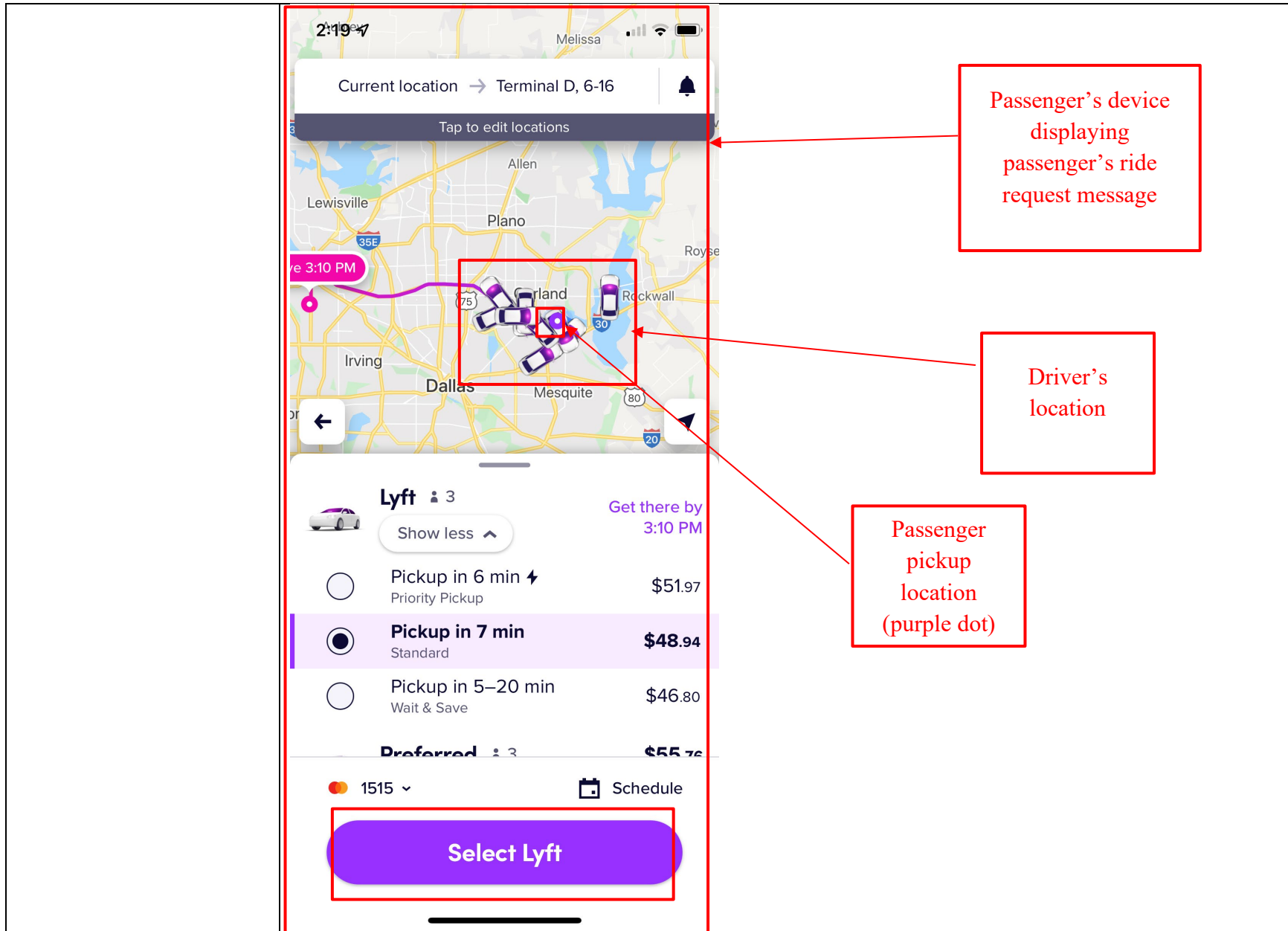

Attachment B for US Patent No. 7,630,724 Against Lyft Accused Products

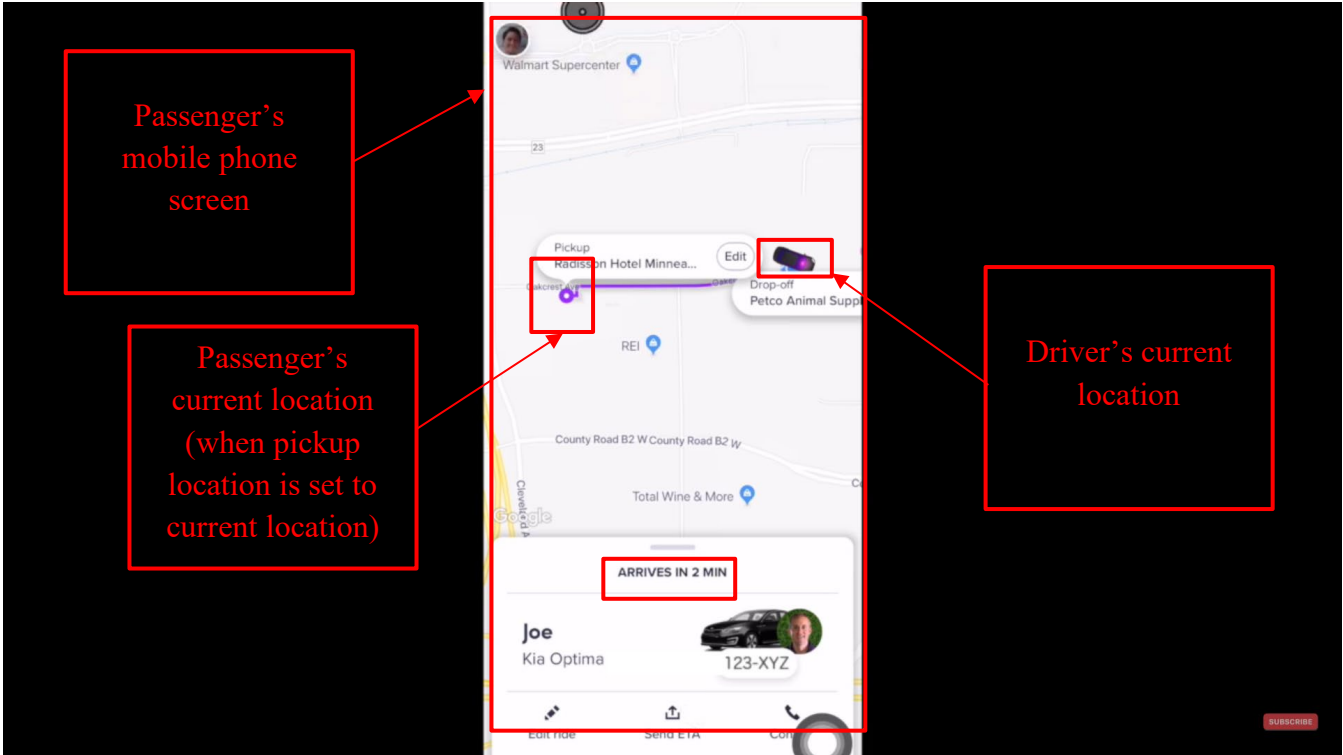
Claim – 7,630,724	Accused Products
	 <p>Passenger's mobile phone screen</p> <p>Passenger's current location (when pickup location is set to current location)</p> <p>Driver's current location</p> <p>ARRIVES IN 2 MIN</p> <p>Joe Kia Optima 123-XYZ</p> <p>https://www.youtube.com/watch?v=j0RDMLcmOgU at 5:07, Annotated</p>

Attachment B for US Patent No. 7,630,724 Against Lyft Accused Products

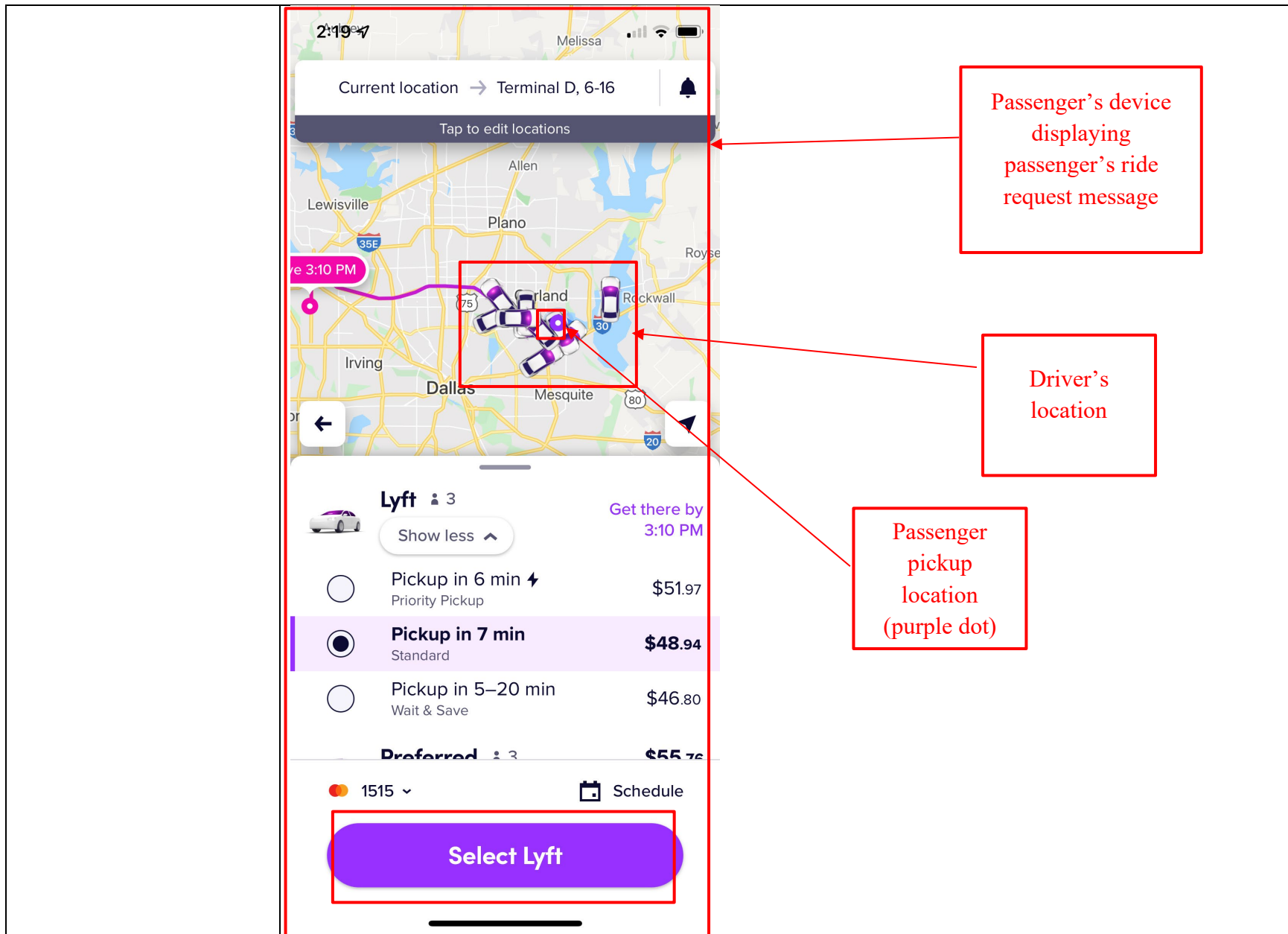

Attachment B for US Patent No. 7,630,724 Against Lyft Accused Products

Claim – 7,630,724	Accused Products
	<p>Further, to the extent this element is performed at least in part by Lyft's software source code, AGIS reserves the right to supplement these contentions pursuant to production of such source code by Lyft and to the extent Lyft requires additional information in accordance with P.R. 3-1 and for any other reasons.</p>
<p>9[B]. accessing an application program in each cell phone for generating one or more symbols representative of one or more participating users, each of whom have a similarly equipped cellular phone;</p>	<p>The Lyft Accused Product(s) performs a computer implemented method as set forth below. Lyft further infringes directly and/or indirectly by performing, inducing others to perform, and/or contributing to the performance of: accessing an application program in each cell phone for generating one or more symbols representative of one or more participating users, each of whom have a similarly equipped cellular phone.</p> <p>For example, Lyft app displays symbols on the screen representing the passenger as well as the driver's vehicle.</p>

Attachment B for US Patent No. 7,630,724 Against Lyft Accused Products

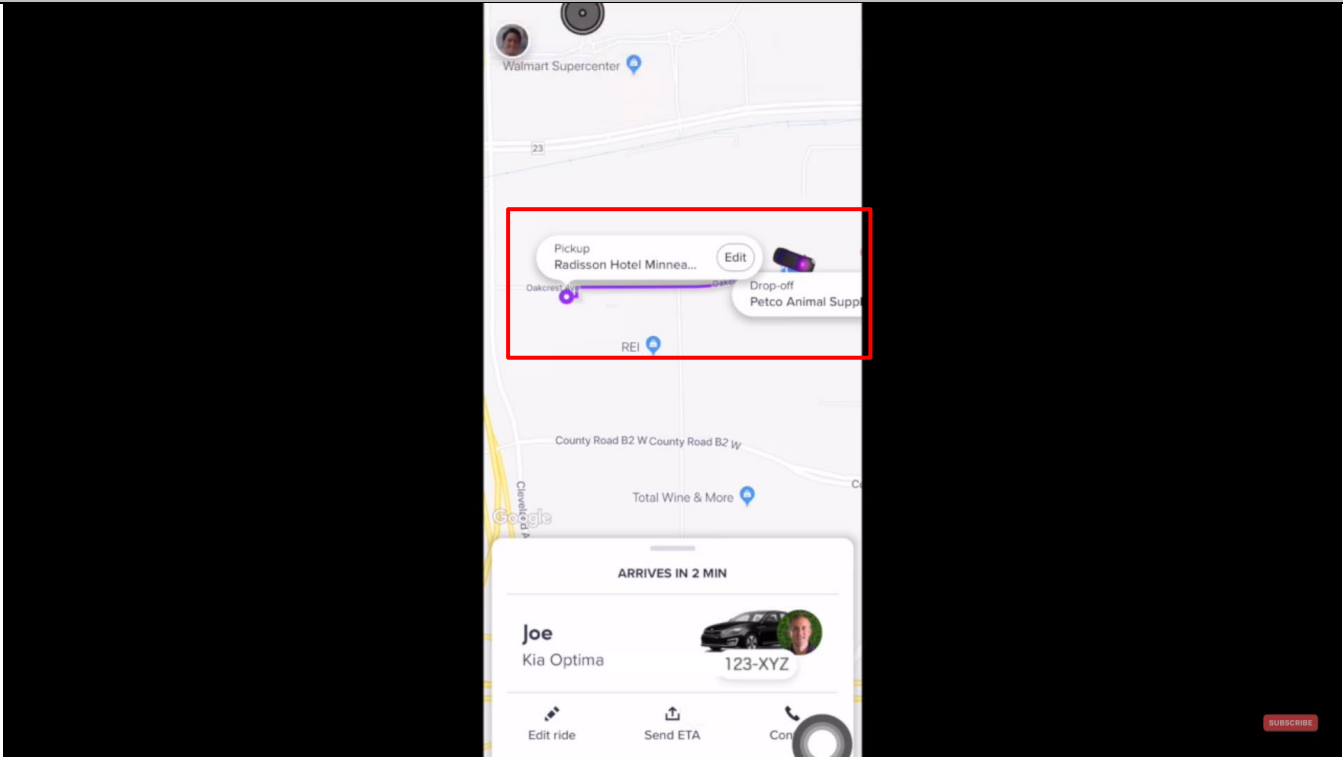
Claim – 7,630,724	Accused Products
	 <p>https://www.youtube.com/watch?v=j0RDMLcmOgU at 5:07</p>

Attachment B for US Patent No. 7,630,724 Against Lyft Accused Products

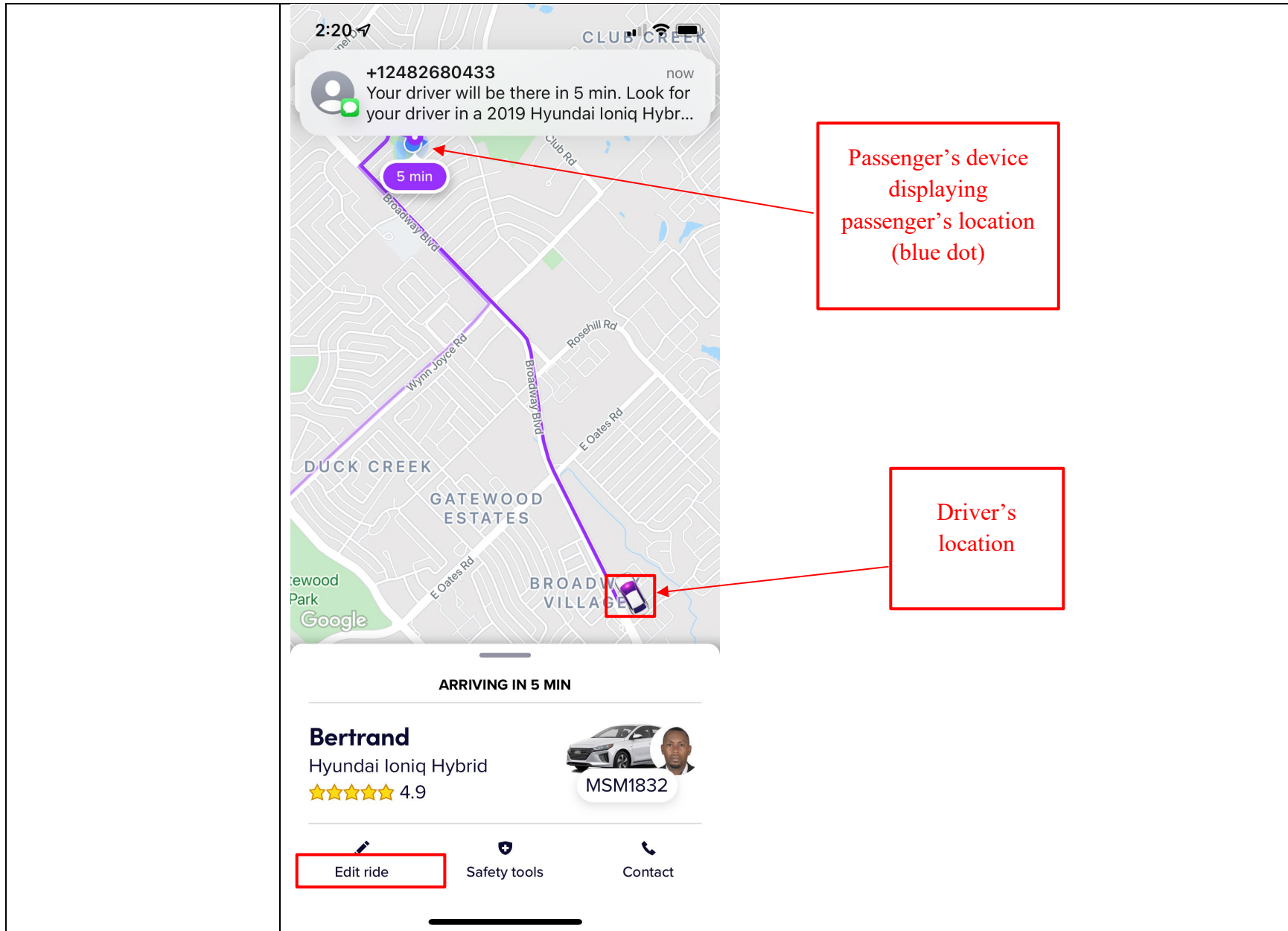

Attachment B for US Patent No. 7,630,724 Against Lyft Accused Products

Claim – 7,630,724	Accused Products
	<p>Further, to the extent this element is performed at least in part by Lyft's software source code, AGIS reserves the right to supplement these contentions pursuant to production of such source code by Lyft and to the extent Lyft requires additional information in accordance with P.R. 3-1 and for any other reasons.</p>
<p>9[C]. accessing a database in each cell phone that includes cellular telephone numbers of each of the participating users having similarly equipped cellular phones, said database including the generation of one or more symbols associated with a particular participating user;</p>	<p>The Lyft Accused Products perform a computer implemented method as set forth below. Lyft further infringes directly and/or indirectly by performing, inducing others to perform, and/or contributing to the performance of: accessing a database in each cell phone that includes cellular telephone numbers of each of the participating users having similarly equipped cellular phones, said database including the generation of one or more symbols associated with a particular participating user.</p> <p>The Lyft apps meet this limitation because they access the virtual telephone numbers or the unique identifiers which are equivalent to phone numbers of the riders/drivers of the Lyft platform/network. The virtual phone numbers are received and kept on one or more databases either locally or remotely on a Lyft server(s) for access by the Lyft apps. For example, when the driver is matched to the passenger, both the driver and the passenger get the call icon (“rapid voice initiation and communication”) on their respective mobile phones display in the Lyft driver and Lyft app respectively through which both of them call each other by tapping the call icon on their respective touch screen display.</p>

Attachment B for US Patent No. 7,630,724 Against Lyft Accused Products

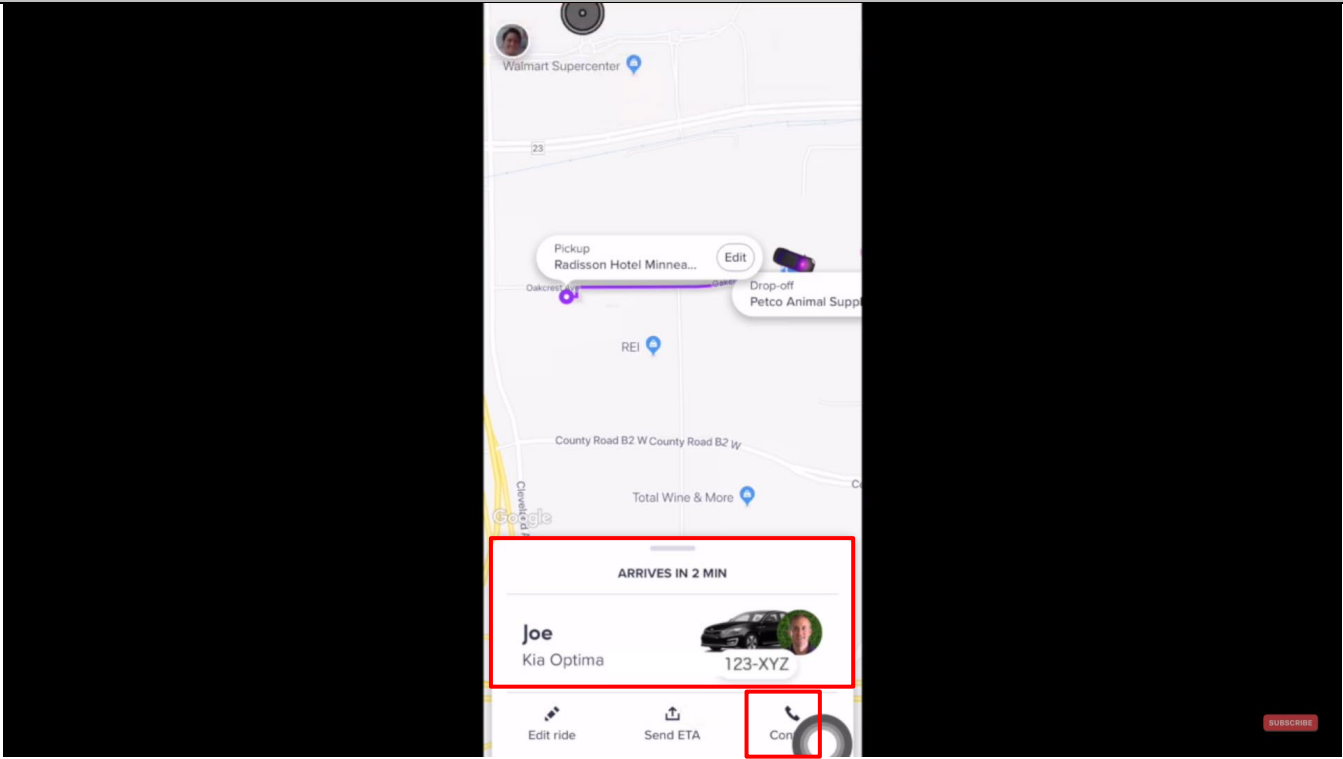
Claim – 7,630,724	Accused Products
	 <p>https://www.youtube.com/watch?v=j0RDMLcmOgU at 5:07</p>

Attachment B for US Patent No. 7,630,724 Against Lyft Accused Products

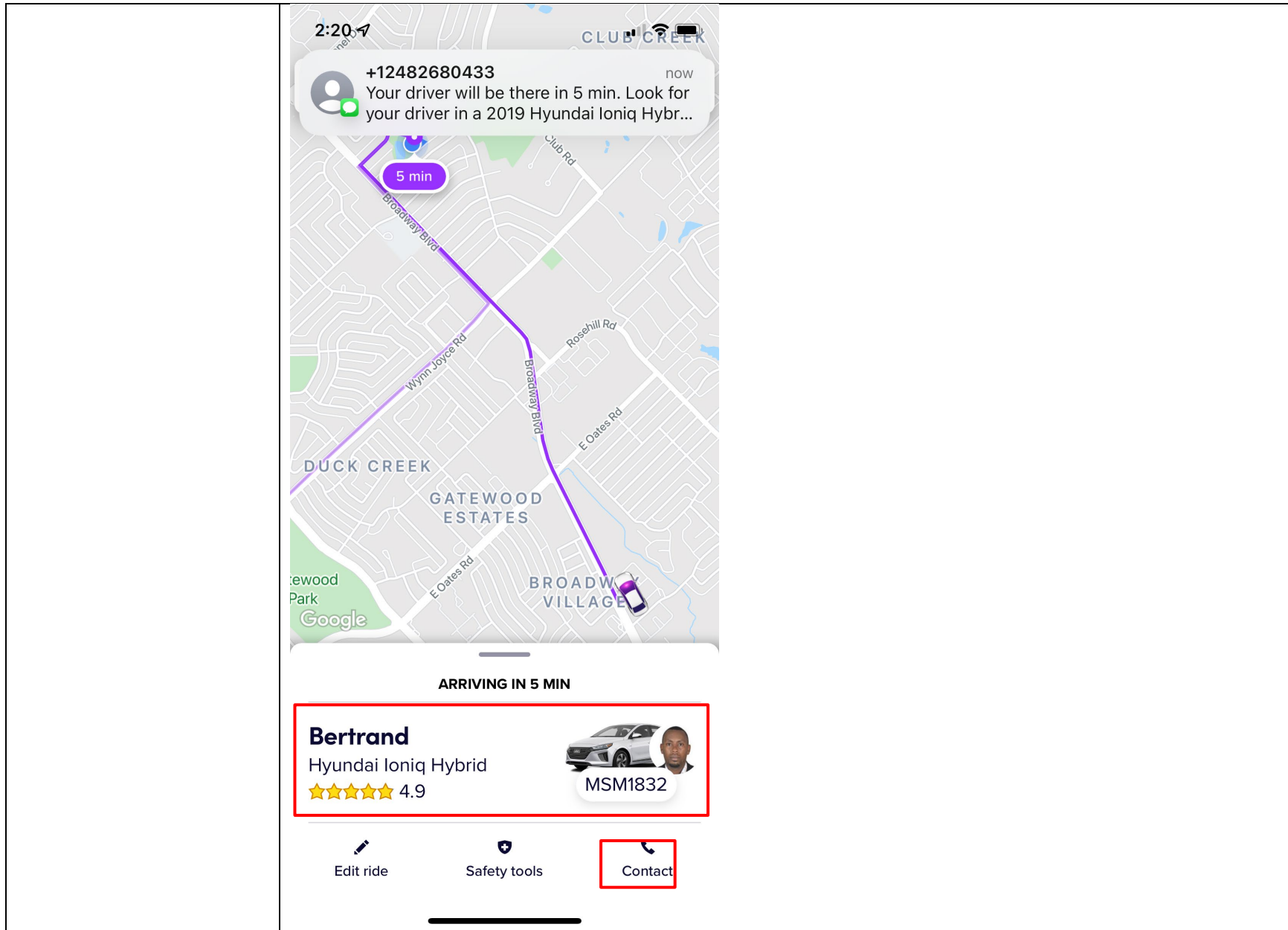

Attachment B for US Patent No. 7,630,724 Against Lyft Accused Products

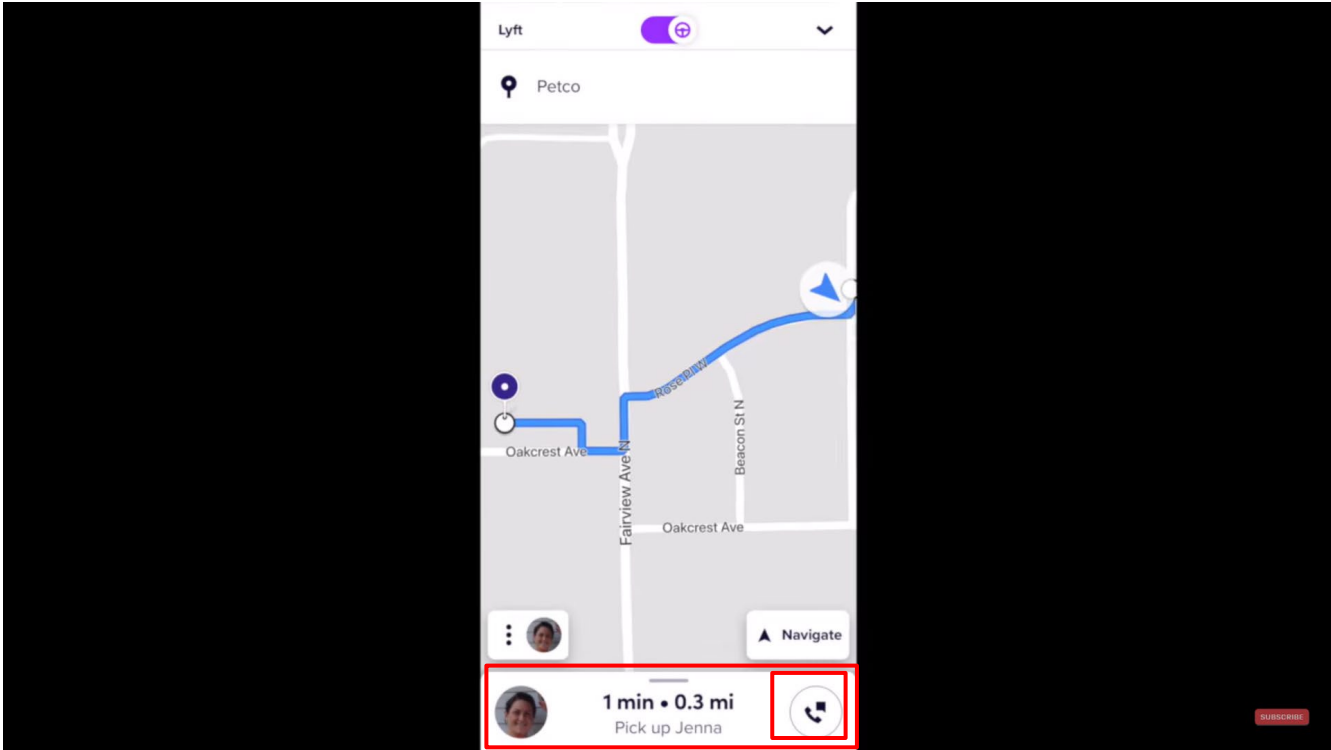
Claim – 7,630,724	Accused Products
	 <p>The screenshot shows the Lyft mobile application interface. At the top, the word "Lyft" is displayed next to a purple toggle switch and a dropdown arrow. Below this, a location pin icon is followed by the text "Petco". The main area is a map showing a blue route starting from a white circle on Oakcrest Ave, heading north on Fairview Ave N, then east on Beacon St N, and finally south on Oakcrest Ave. A blue arrow icon is at the top right of the map. At the bottom of the map, there is a "Navigate" button with an upward-pointing triangle. Below the map, there is a driver profile card for "Jenna" with a circular profile picture. To the right of the profile card, the text "1 min • 0.3 mi" and "Pick up Jenna" is displayed. A red rectangular box highlights a circular call button with a telephone handset icon. A "SUBSCRIBE" button is visible in the bottom right corner of the video frame.</p> <p>https://www.youtube.com/watch?v=jVUy9poJDng at 10:46</p>

Attachment B for US Patent No. 7,630,724 Against Lyft Accused Products

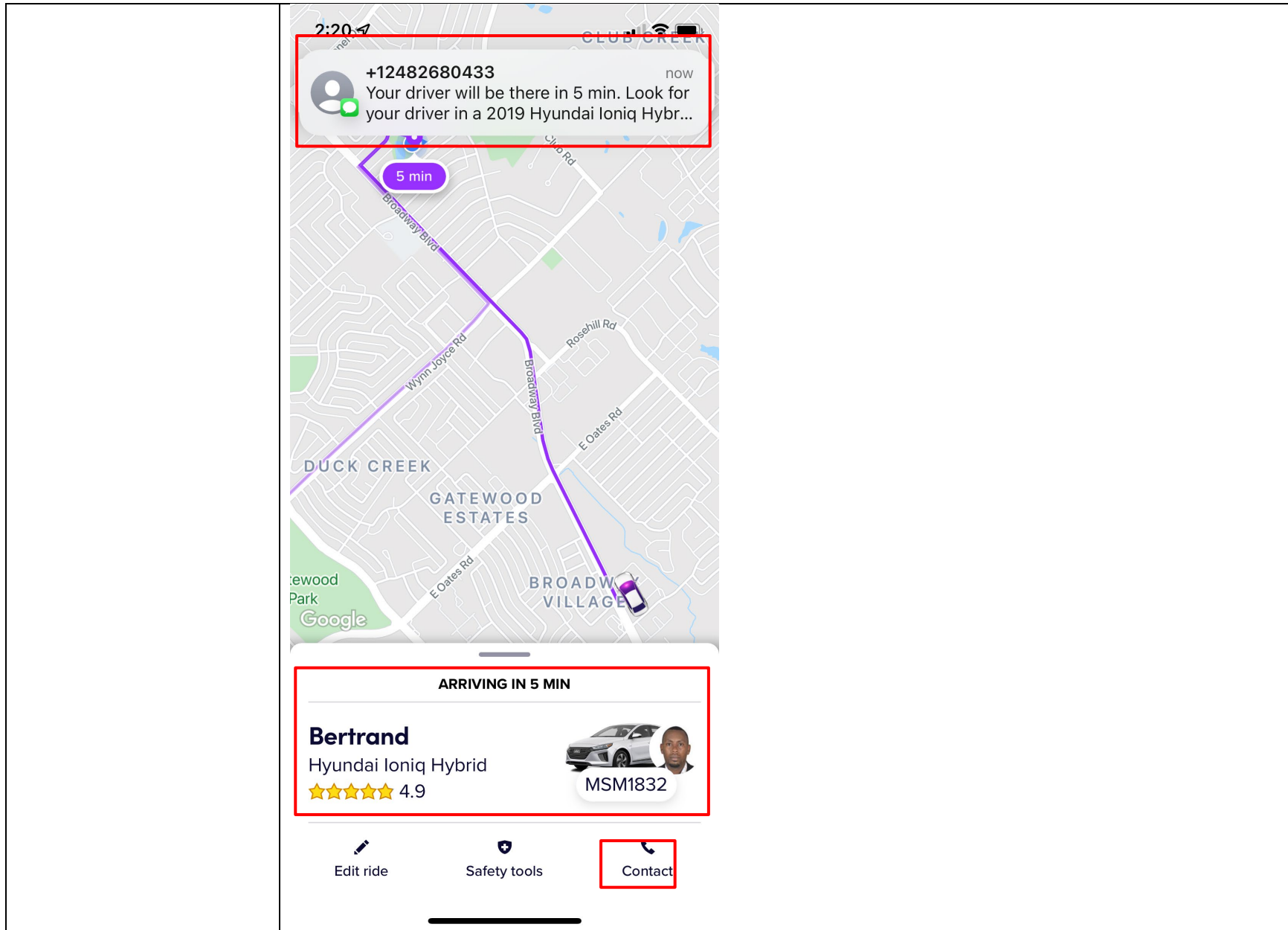

Attachment B for US Patent No. 7,630,724 Against Lyft Accused Products

Claim – 7,630,724	Accused Products
	<p>Further, to the extent this element is performed at least in part by Lyft's software source code, AGIS reserves the right to supplement these contentions pursuant to production of such source code by Lyft and to the extent Lyft requires additional information in accordance with P.R. 3-1 and for any other reasons.</p> <p>With respect to the limitations reciting the cellular phone number(s) or telephone number(s), the claim is met either literally or under the doctrine of equivalents.</p>
<p>9[D]. calling a participating user by touching the symbol on the map display and touching a call switch;</p>	<p><i>See</i> claim 9[C].</p> <p>The Lyft Accused Products perform a computer implemented method as set forth below. Lyft further infringes directly and/or indirectly by performing, inducing others to perform, and/or contributing to the performance of: calling a participating user by touching the symbol on the map display and touching a call switch.</p> <p>The Lyft apps meet this limitation because provide selectable interface elements on the Lyft application for calling drivers/riders. For example, when the driver is matched to the passenger, both the driver and the passenger get the call icon (“rapid voice initiation and communication”) on their respective mobile phones display in the Lyft driver and Lyft app respectively through which both of them call each other by tapping the call icon on their respective touch screen display.</p>

Attachment B for US Patent No. 7,630,724 Against Lyft Accused Products

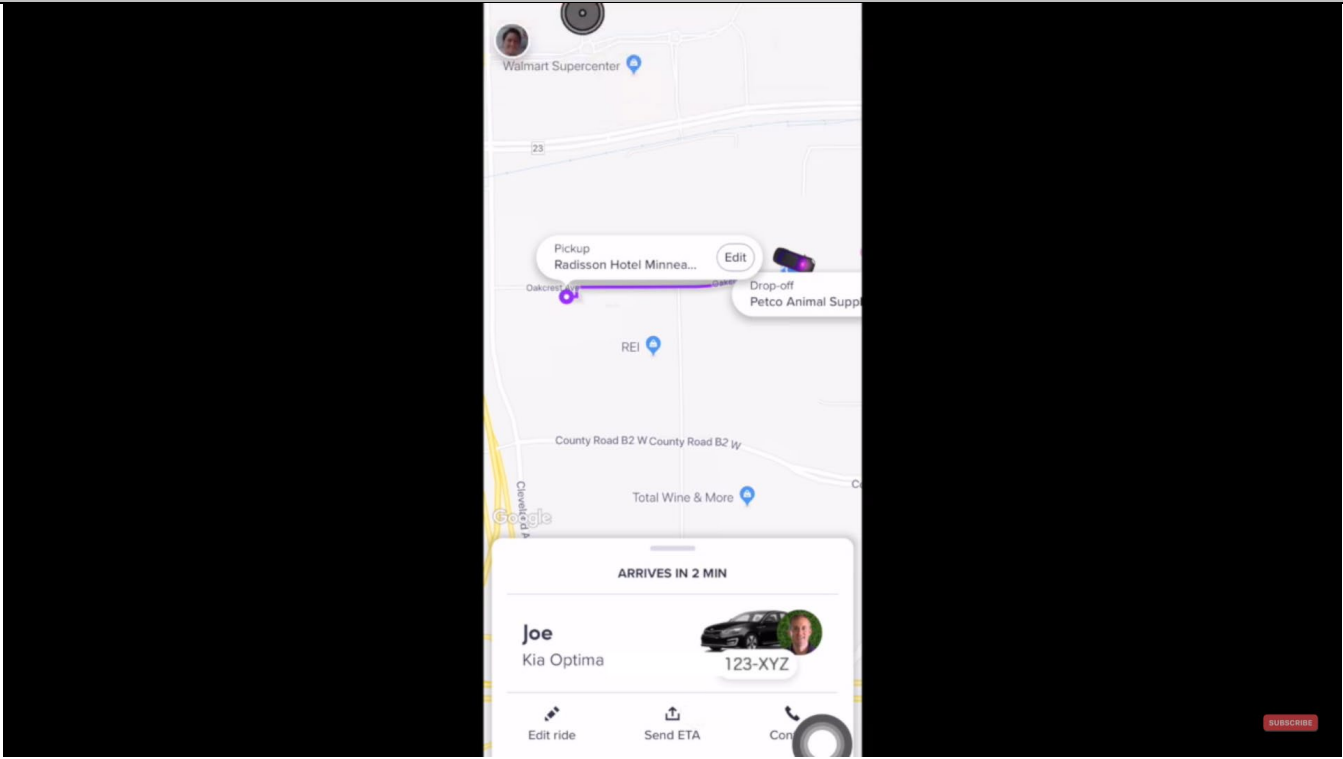
Claim – 7,630,724	Accused Products
	 <p>https://www.youtube.com/watch?v=j0RDMLcmOgU at 5:07</p>

Attachment B for US Patent No. 7,630,724 Against Lyft Accused Products

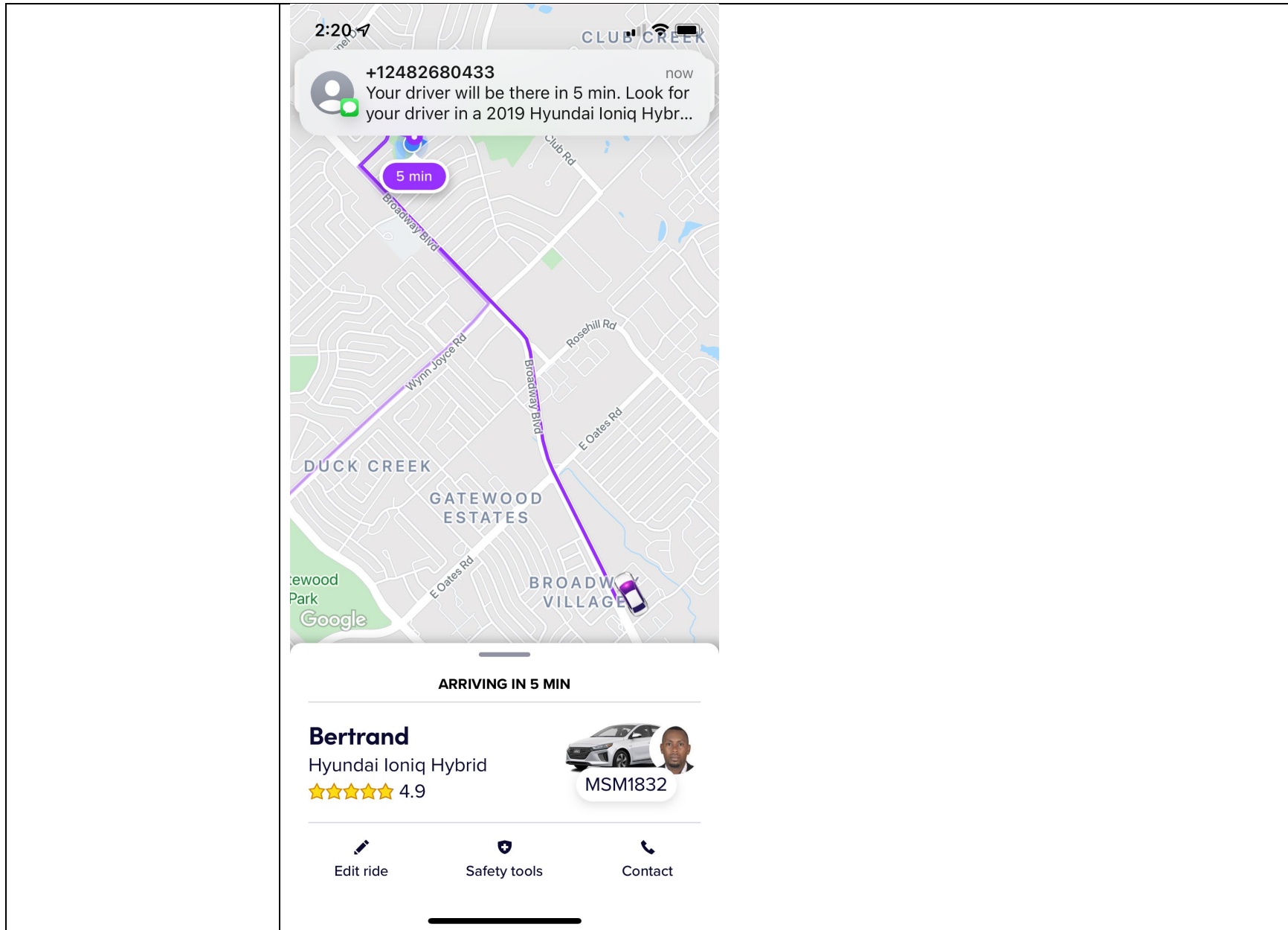

Attachment B for US Patent No. 7,630,724 Against Lyft Accused Products

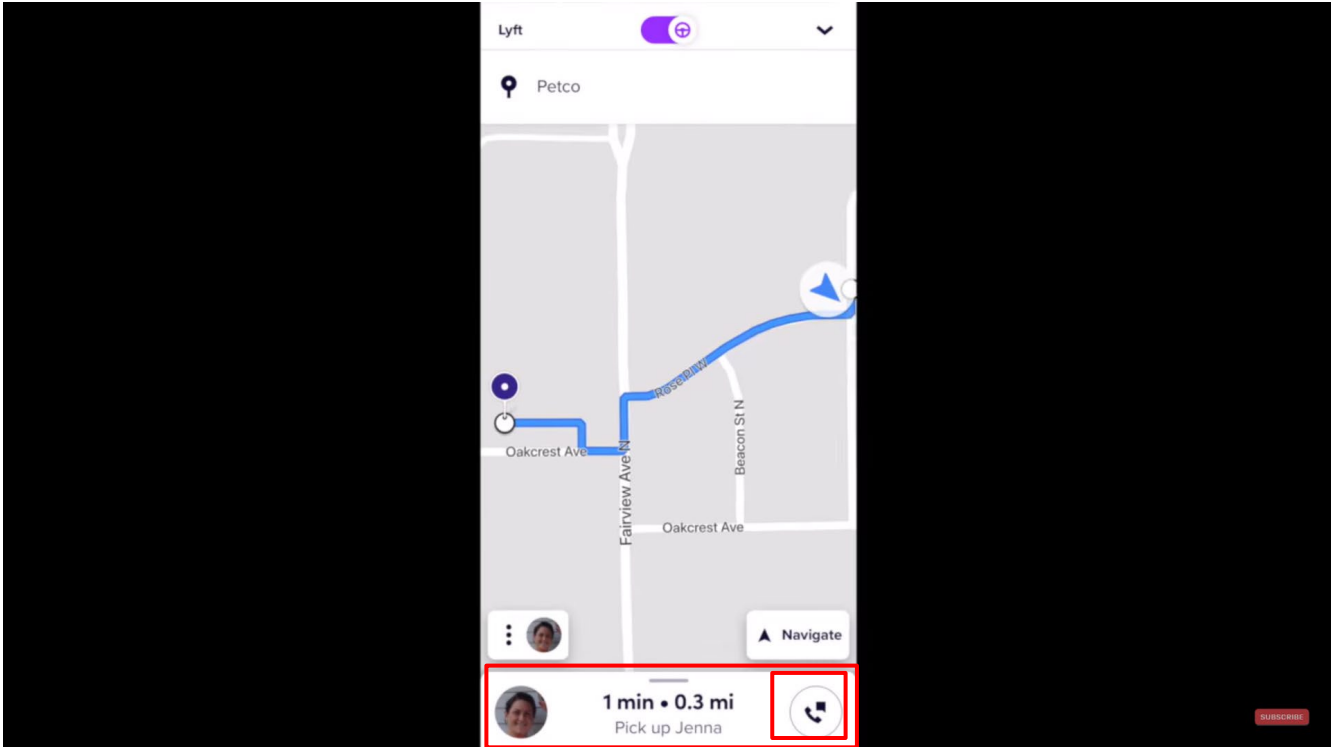
Claim – 7,630,724	Accused Products
	 <p>https://www.youtube.com/watch?v=jVUy9poJDng at 10:46</p>

Attachment B for US Patent No. 7,630,724 Against Lyft Accused Products

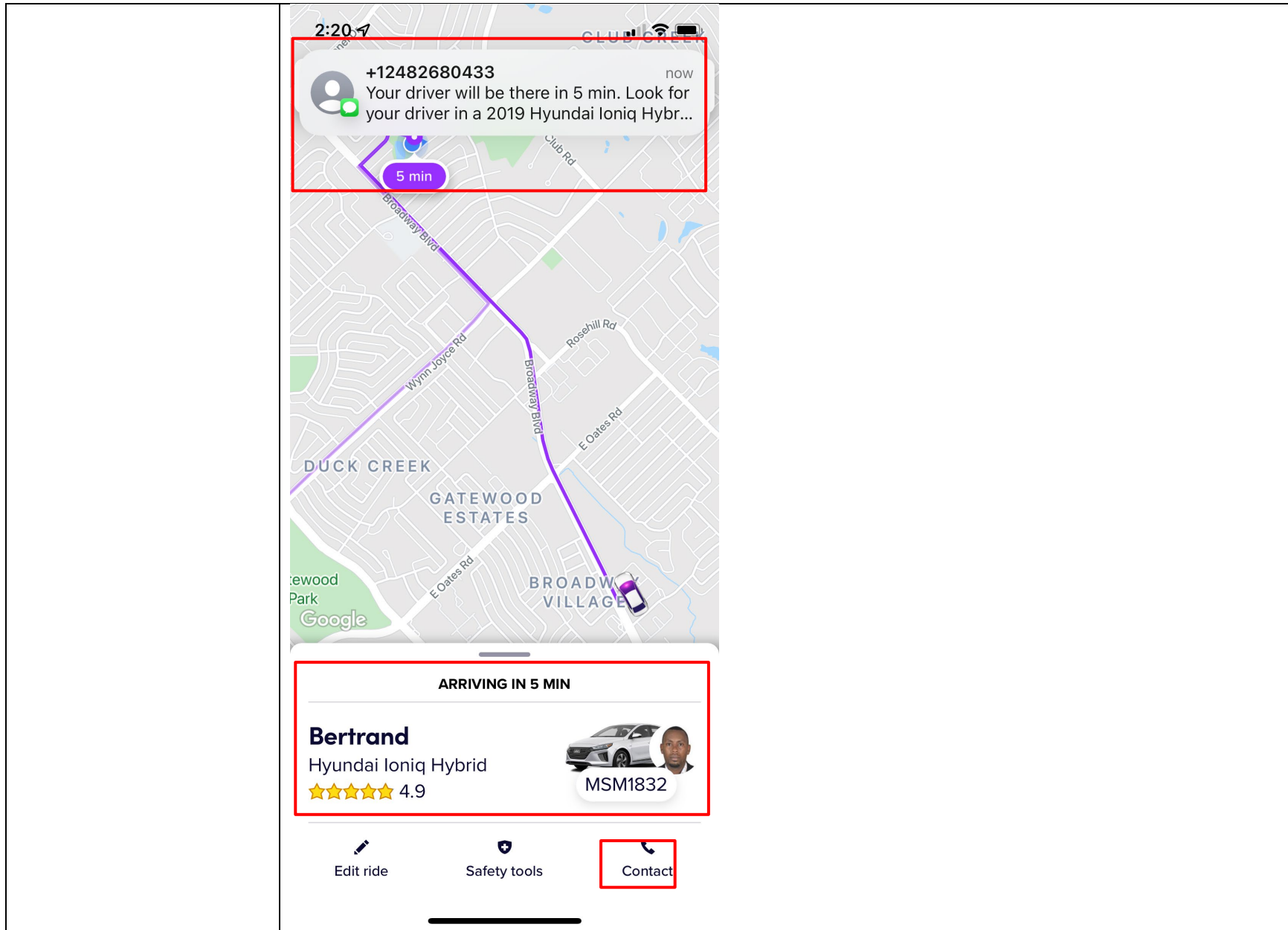

Attachment B for US Patent No. 7,630,724 Against Lyft Accused Products

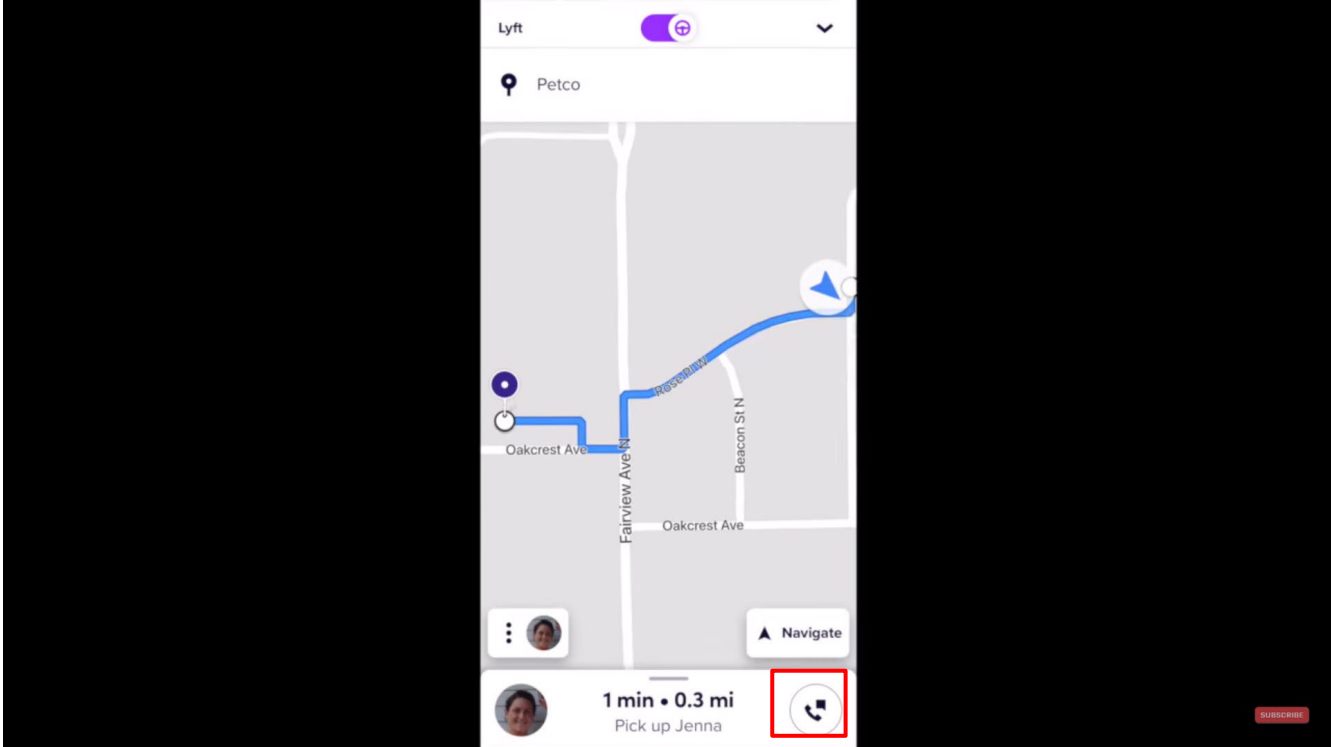
Claim – 7,630,724	Accused Products
	 <p>https://www.youtube.com/watch?v=jVUy9poJDng at 10:46</p>

Attachment B for US Patent No. 7,630,724 Against Lyft Accused Products

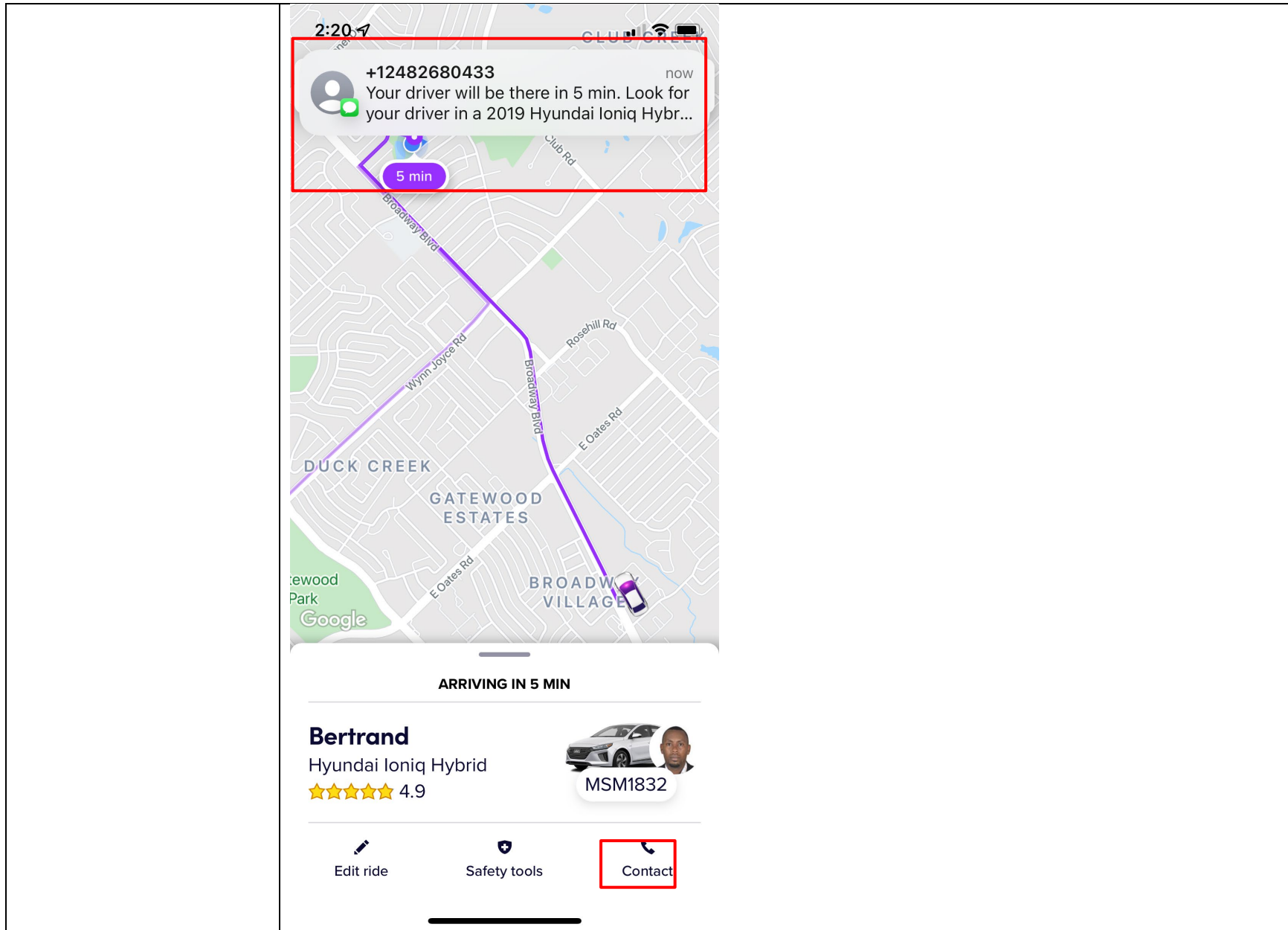

Attachment B for US Patent No. 7,630,724 Against Lyft Accused Products

Claim – 7,630,724	Accused Products
	 <p>The screenshot shows a mobile interface for contacting a driver named Jenna. The text messages are as follows:</p> <ul style="list-style-type: none">✕ Contact Jenna ☎I'm your driver, Joe >Hi, where are you? >Be there in 1 min >Stuck in traffic >Can't take a call now, sorry >I'm in a black Kia Optima Hybrid >Gate code, please? > <p>A red square highlights a purple circular call button with a white telephone handset icon. A 'SUBSCRIBE' button is visible in the bottom right corner of the video frame.</p> <p>https://www.youtube.com/watch?v=jVUy9poJDng at 11:21</p>

Attachment B for US Patent No. 7,630,724 Against Lyft Accused Products

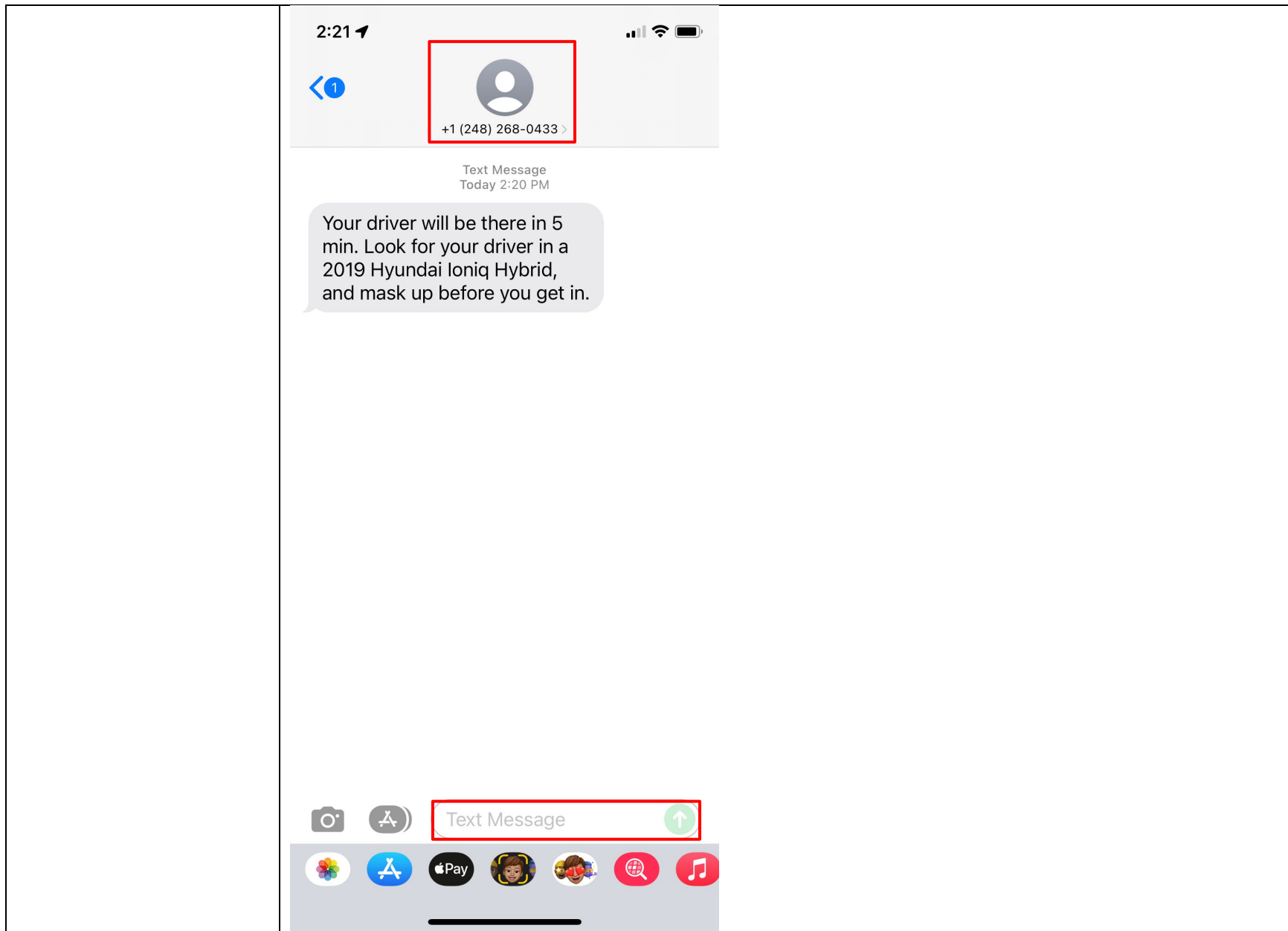

Attachment B for US Patent No. 7,630,724 Against Lyft Accused Products

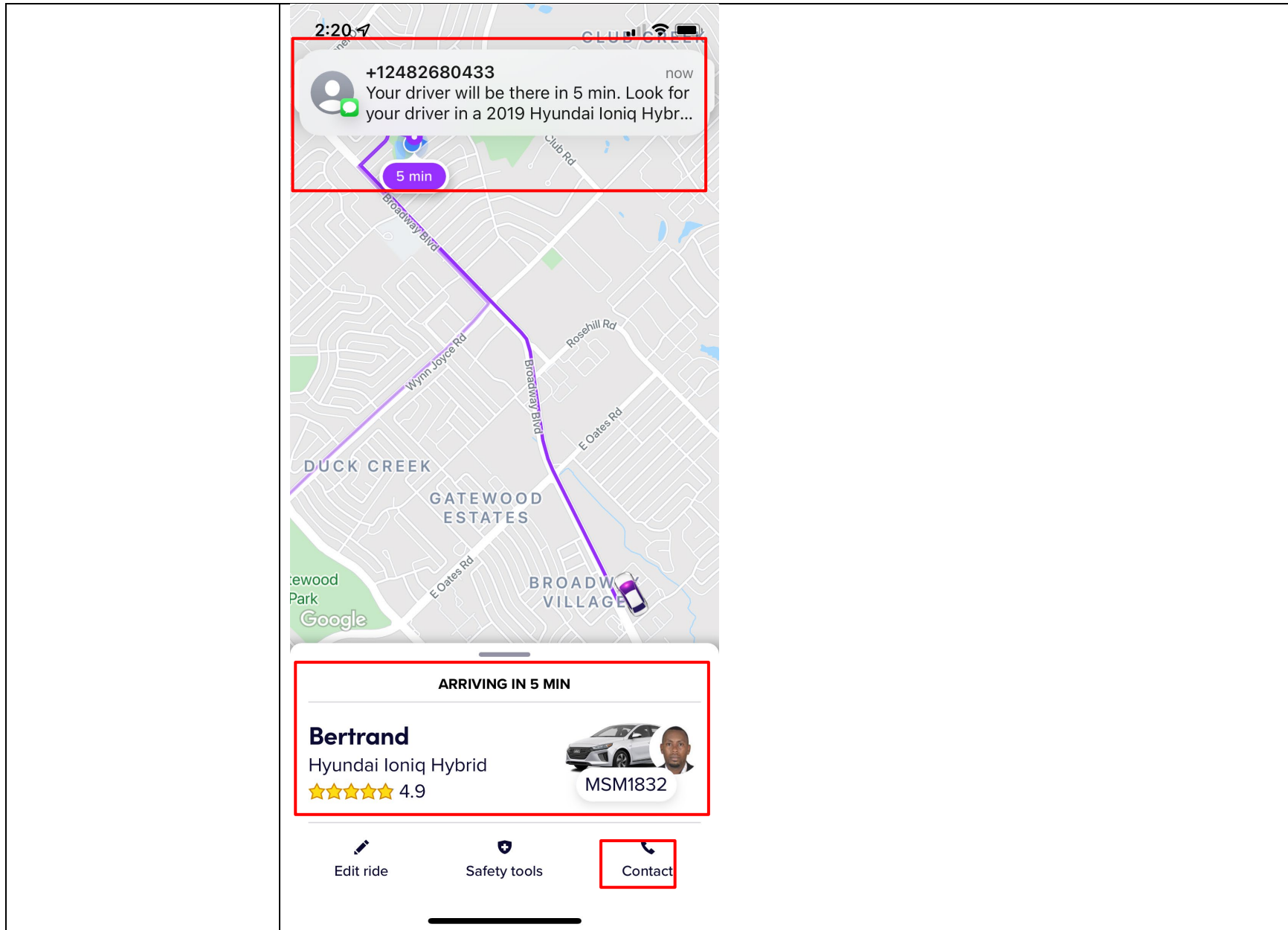

Attachment B for US Patent No. 7,630,724 Against Lyft Accused Products

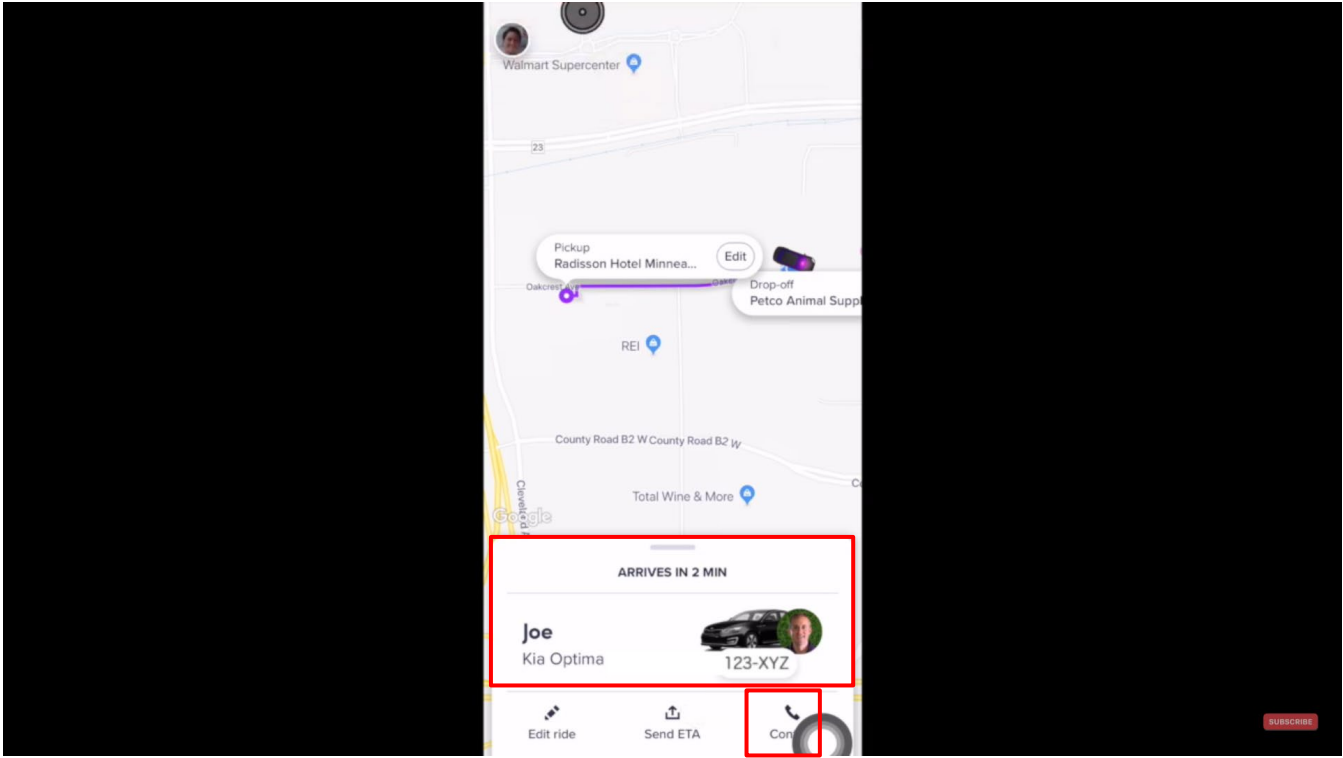
Claim – 7,630,724	Accused Products
	 <p>https://www.youtube.com/watch?v=j0RDMLcmOgU at 5:07</p>

Attachment B for US Patent No. 7,630,724 Against Lyft Accused Products

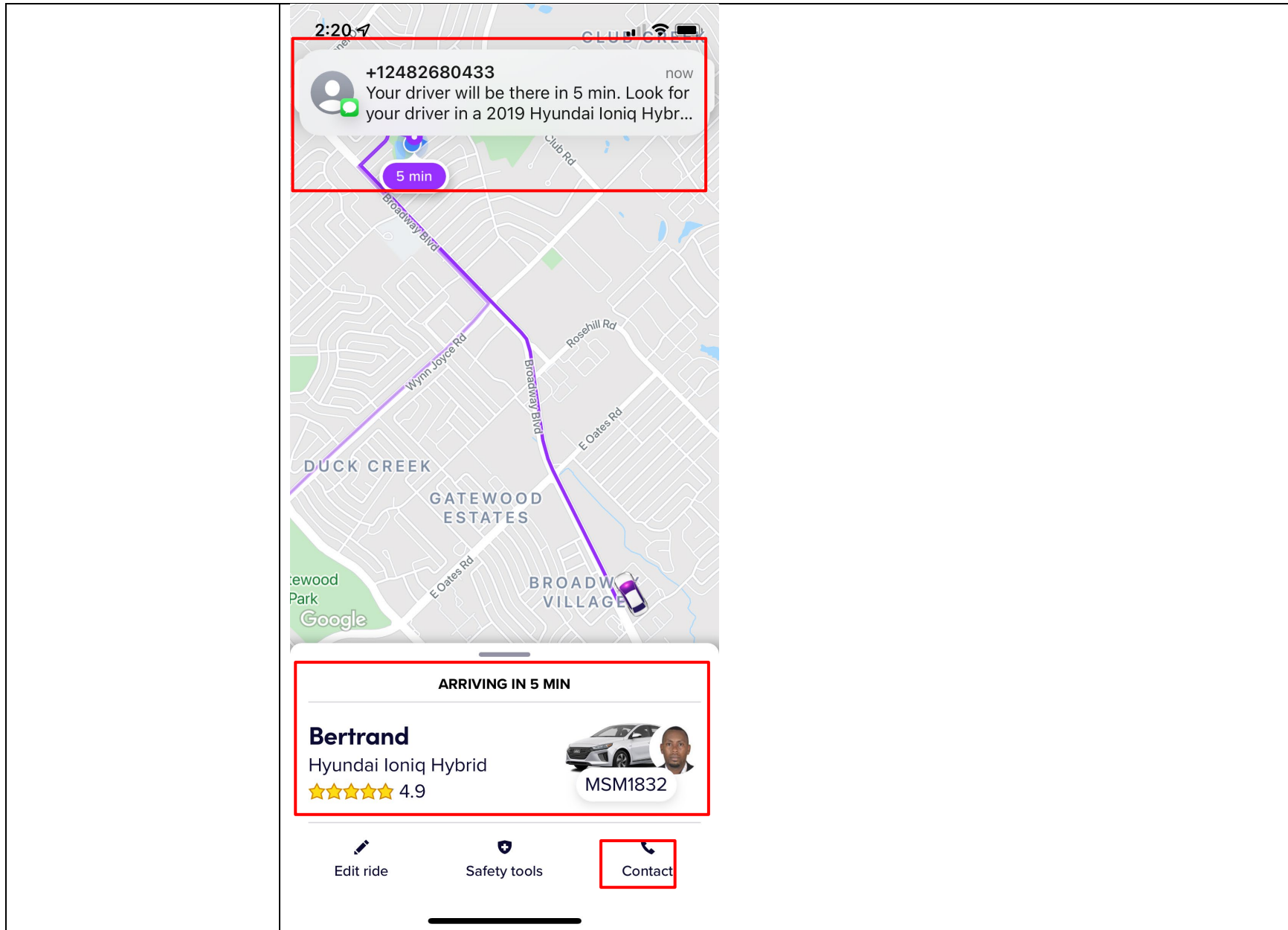

Attachment B for US Patent No. 7,630,724 Against Lyft Accused Products

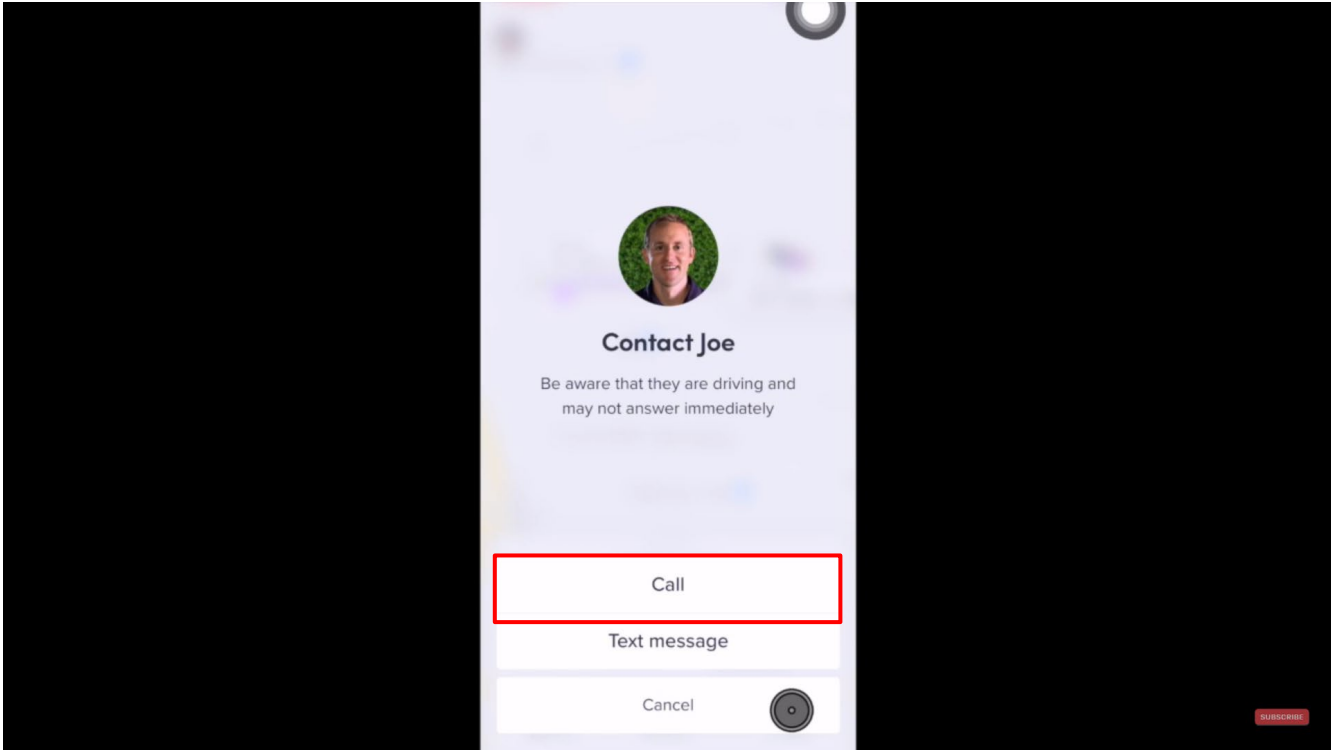
Claim – 7,630,724	Accused Products
	 <p>The screenshot shows a mobile application interface for contacting a driver named 'Contact Joe'. The interface includes a circular profile picture of a man, the name 'Contact Joe', and a warning: 'Be aware that they are driving and may not answer immediately'. Below this, there are three buttons: 'Call', 'Text message', and 'Cancel'. The 'Call' button is highlighted with a red rectangular box. A 'SUBSCRIBE' button is visible in the bottom right corner of the app interface.</p> <p>https://www.youtube.com/watch?v=j0RDMLcmOgU at 5:32</p>

Attachment B for US Patent No. 7,630,724 Against Lyft Accused Products

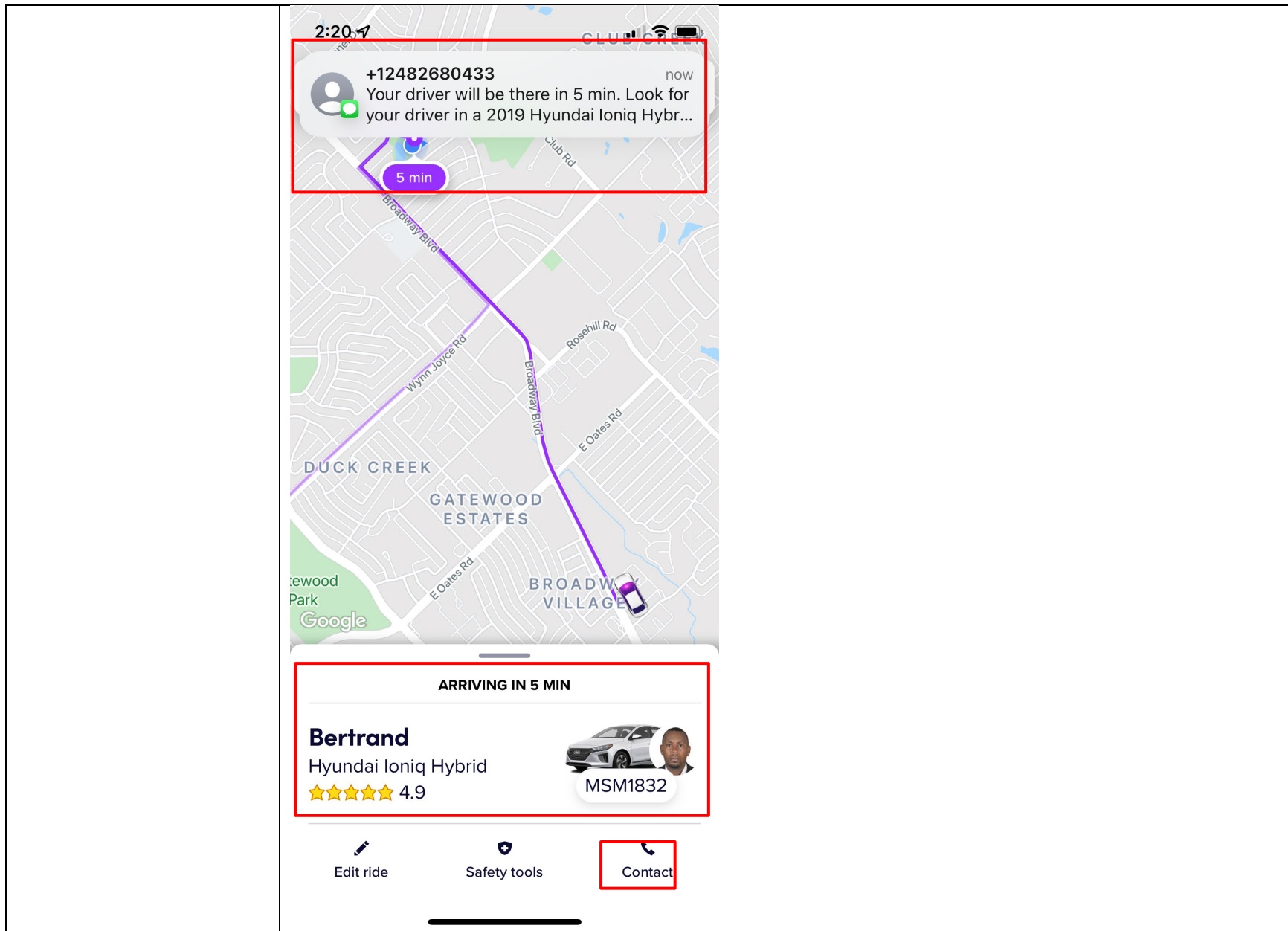

Attachment B for US Patent No. 7,630,724 Against Lyft Accused Products

Claim – 7,630,724	Accused Products
	<p>Further, to the extent this element is performed at least in part by Lyft's software source code, AGIS reserves the right to supplement these contentions pursuant to production of such source code by Lyft and to the extent Lyft requires additional information in accordance with P.R. 3-1 and for any other reasons.</p>
<p>9[E]. connecting each of the cell phones to an internet connection;</p>	<p>The Lyft Accused Products infringes directly and/or indirectly by performing, inducing others to perform, and/or contributing to the performance of: connecting each of the cell phones to an internet connection.</p> <p>For example, when passengers and drivers access the Lyft and Lyft driver apps respectively which are connected to an IP based connection for them to use the Lyft platform (Lyft and Lyft Driver app).</p>

Attachment B for US Patent No. 7,630,724 Against Lyft Accused Products

Claim – 7,630,724	Accused Products
	<p>Mobile data settings</p> <p>The app must receive data through your mobile network to work. The app will become unresponsive if this setting is turned off. Here are some resources:</p> <p>iOS:</p> <p>Head to Apple Support to learn how to check your cellular data usage.</p> <p>Android:</p> <p>To update the mobile data settings:</p> <ol style="list-style-type: none"> 1. Tap 'Settings' on your phone's menu 2. Tap 'Applications' 3. Select the app on the list 4. Select 'Mobile Data' 5. Tap 'Restrict Background Data' 6. Make sure it isn't toggled to 'Always' <p>https://help.lyft.com/hc/e/articles/115013080508-Phone-software-recommendations-and-settings</p> <p>Further, to the extent this element is performed at least in part by Lyft's software source code, AGIS reserves the right to supplement these contentions pursuant to production of such source code by Lyft and to the extent Lyft requires additional information in accordance with P.R. 3-1 and for any other reasons.</p>
<p>9[F]. exchanging IP addresses using SMS or other digital message format between and</p>	<p>The Lyft Accused Products infringe directly and/or indirectly by performing, inducing others to perform, and/or contributing to the performance of: exchanging IP addresses using SMS or other digital message format between and among each of the network participant users so that communications between</p>

Attachment B for US Patent No. 7,630,724 Against Lyft Accused Products

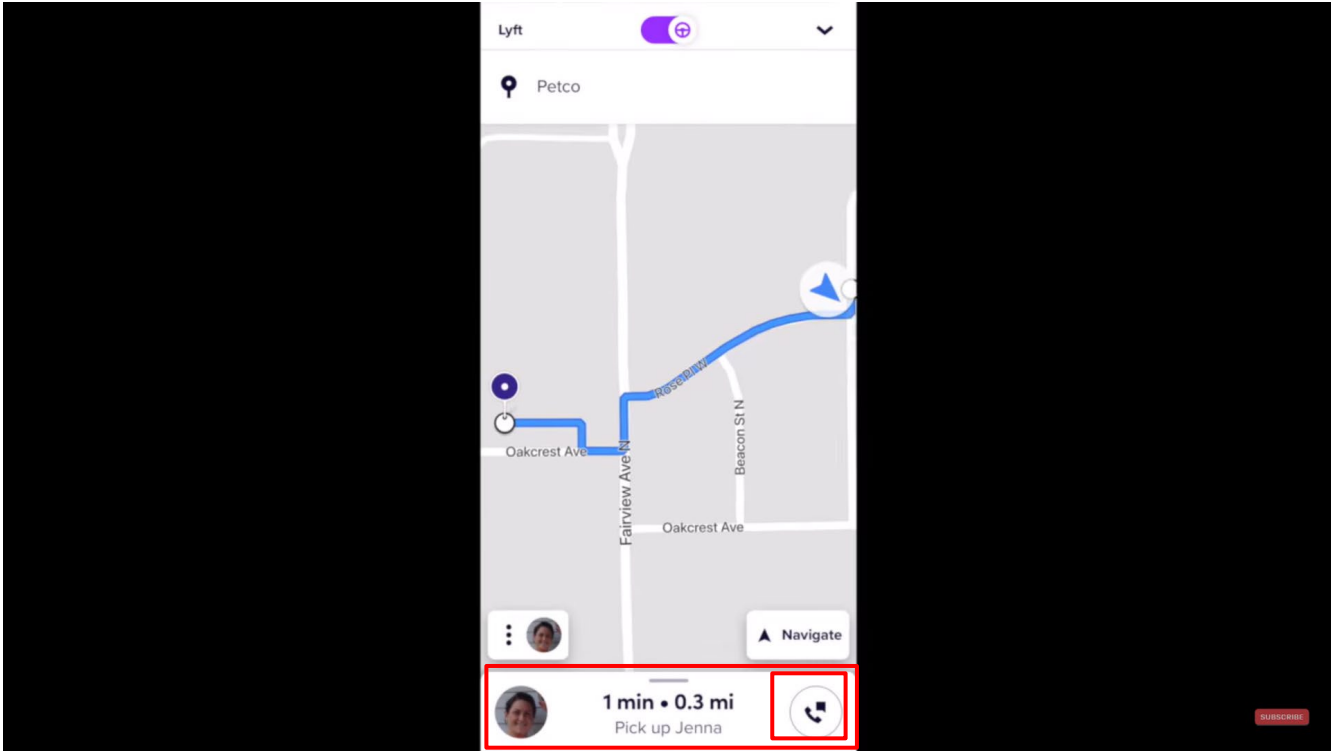
Claim – 7,630,724	Accused Products
<p>among each of the network participant users so that communications between participants is established via IP or transmission of a network participant's IP address to a server which then transmits data to other network participants using the IP address previously.</p>	<p>participants is established via IP or transmission of a network participant's IP address to a server which then transmits data to other network participants using the IP address previously.</p> <p>The Lyft apps meet this limitation because the Lyft apps transmit data (including their IP addresses) to the Lyft server(s) which then communicates data to the other rider/driver. Alternatively, the Lyft apps communicate IP addresses via the Lyft server(s) while communicating data between riders/drivers.</p> <div data-bbox="569 558 1892 1305" style="border: 1px solid black; padding: 5px;">  <p>The screenshot shows the Lyft app interface. At the top, the word 'Lyft' is visible next to a location pin icon and the name 'Petco'. Below this is a map showing a blue route starting from a location marked with a blue dot and ending at a destination marked with a white circle. The route passes through Oakcrest Ave, Fairview Ave N, Beacon St N, and Oakcrest Ave. At the bottom of the screen, there is a navigation bar. On the left, there is a profile picture of a driver. In the center, it says '1 min • 0.3 mi' and 'Pick up Jenna'. On the right, there is a circular button with a telephone handset icon, which is highlighted with a red rectangular box. Below the screenshot, the URL https://www.youtube.com/watch?v=jVUy9poJDng is provided, along with the text 'at 10:46'.</p> </div> <p>https://www.youtube.com/watch?v=jVUy9poJDng at 10:46</p>

Attachment B for US Patent No. 7,630,724 Against Lyft Accused Products

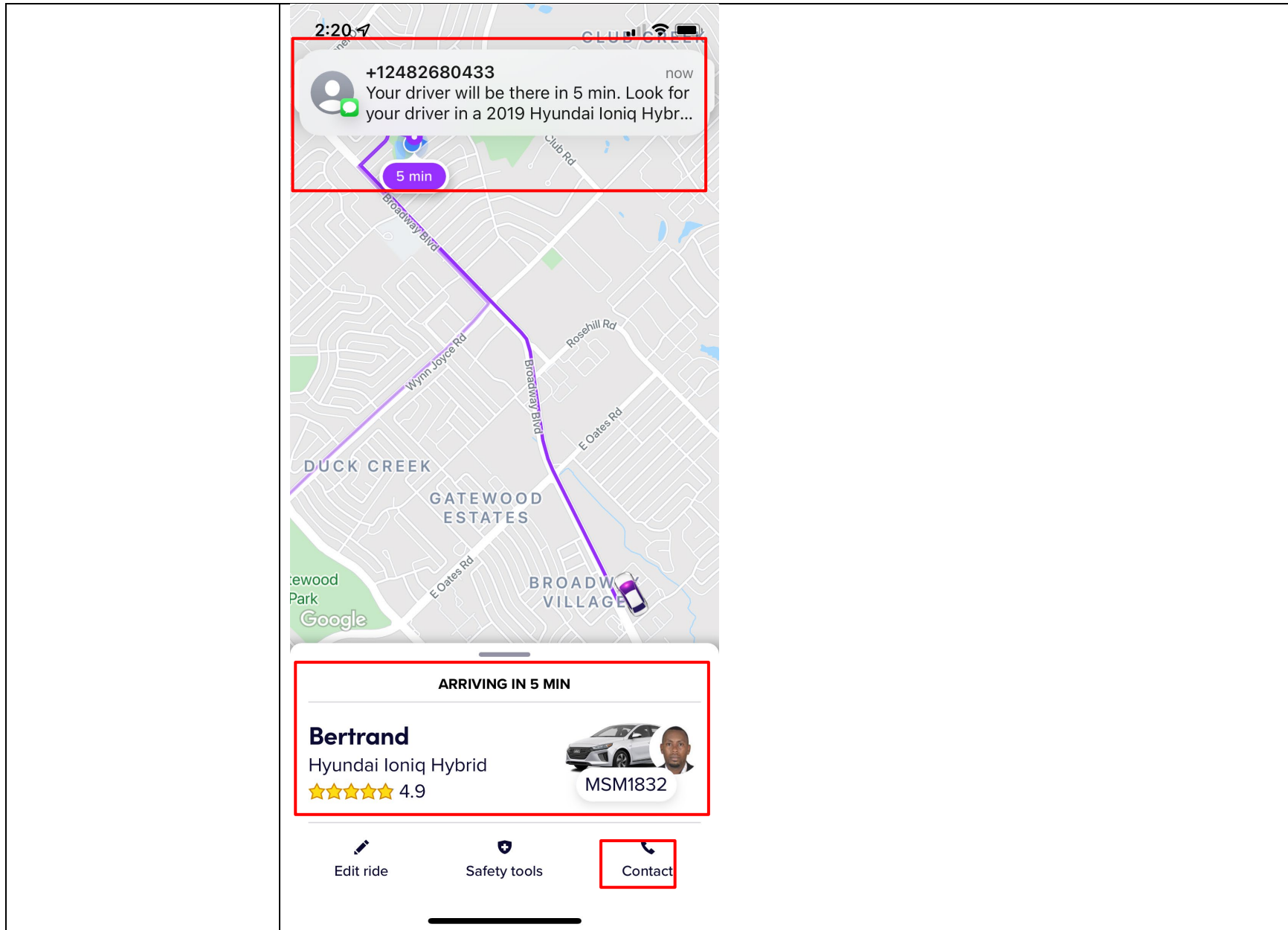

Attachment B for US Patent No. 7,630,724 Against Lyft Accused Products

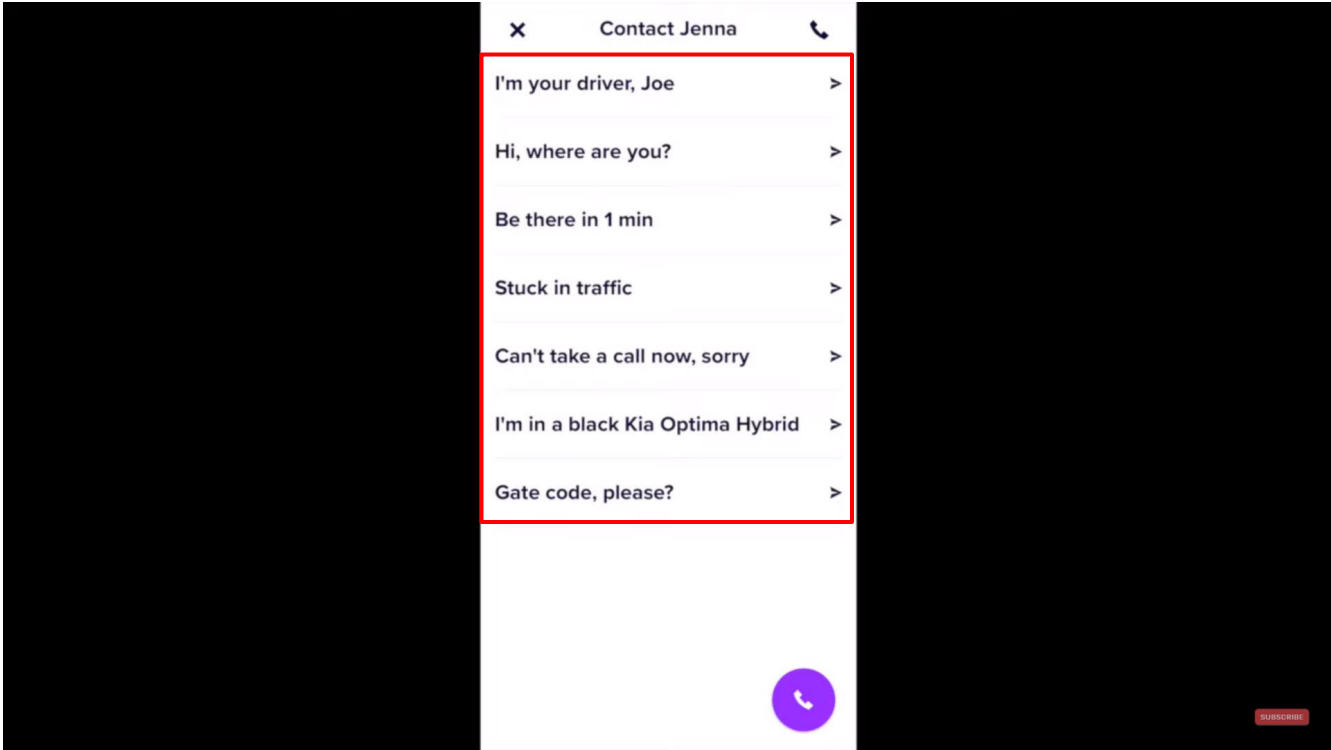
Claim – 7,630,724	Accused Products
	 <p>https://www.youtube.com/watch?v=jVUy9poJDng at 11:21</p>

Attachment B for US Patent No. 7,630,724 Against Lyft Accused Products

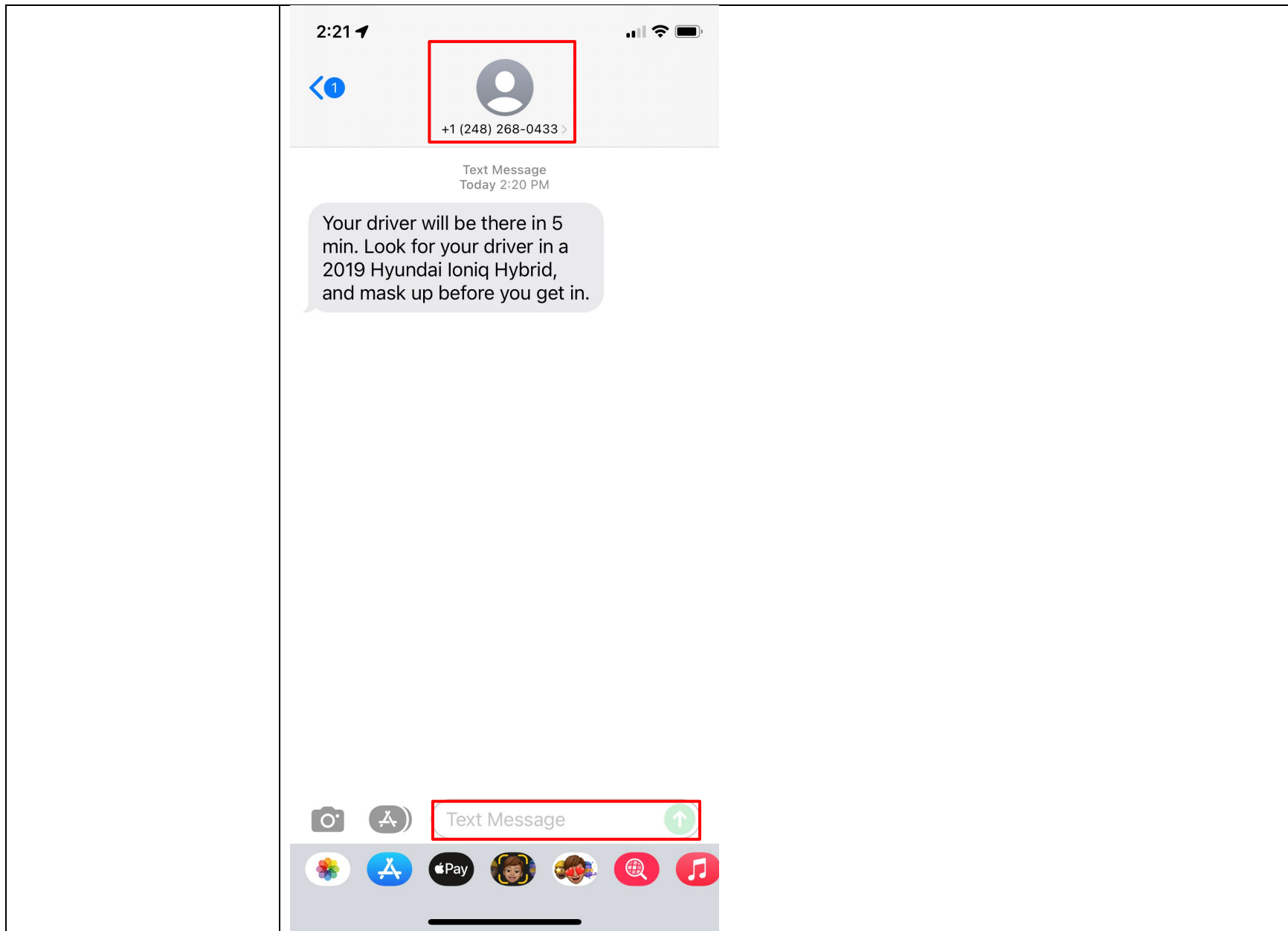

Attachment B for US Patent No. 7,630,724 Against Lyft Accused Products

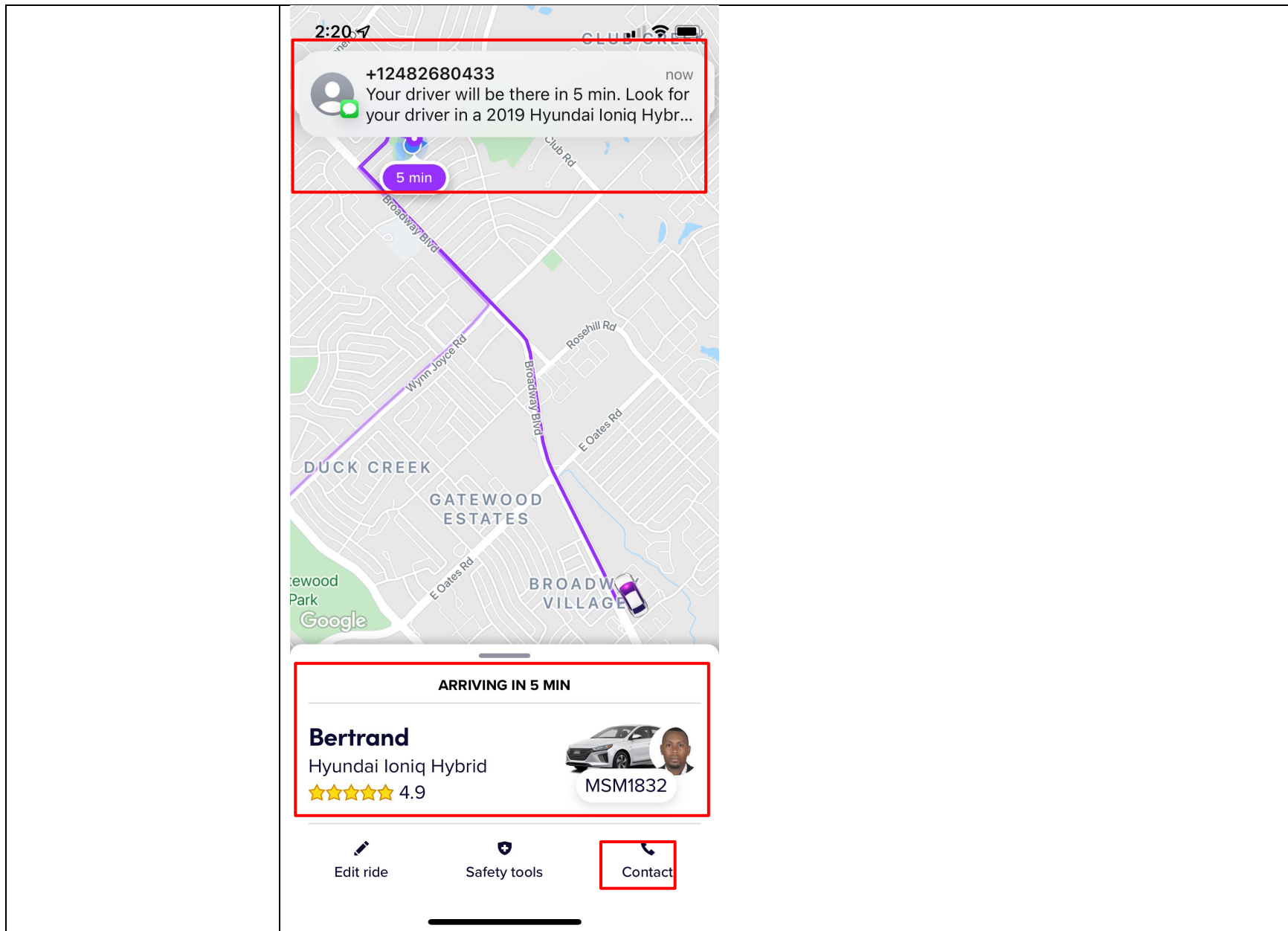

Attachment B for US Patent No. 7,630,724 Against Lyft Accused Products

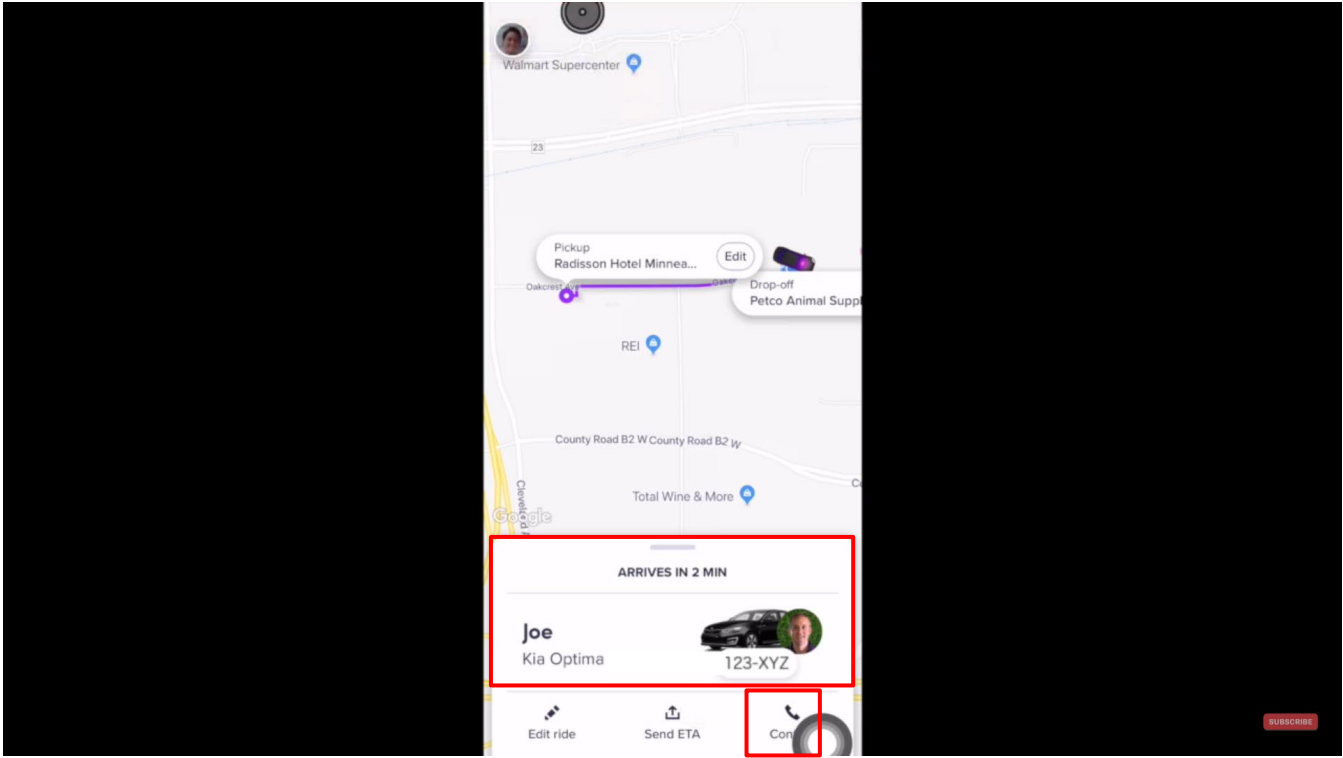
Claim – 7,630,724	Accused Products
	 <p>https://www.youtube.com/watch?v=j0RDMLcmOgU at 5:07</p>

Attachment B for US Patent No. 7,630,724 Against Lyft Accused Products

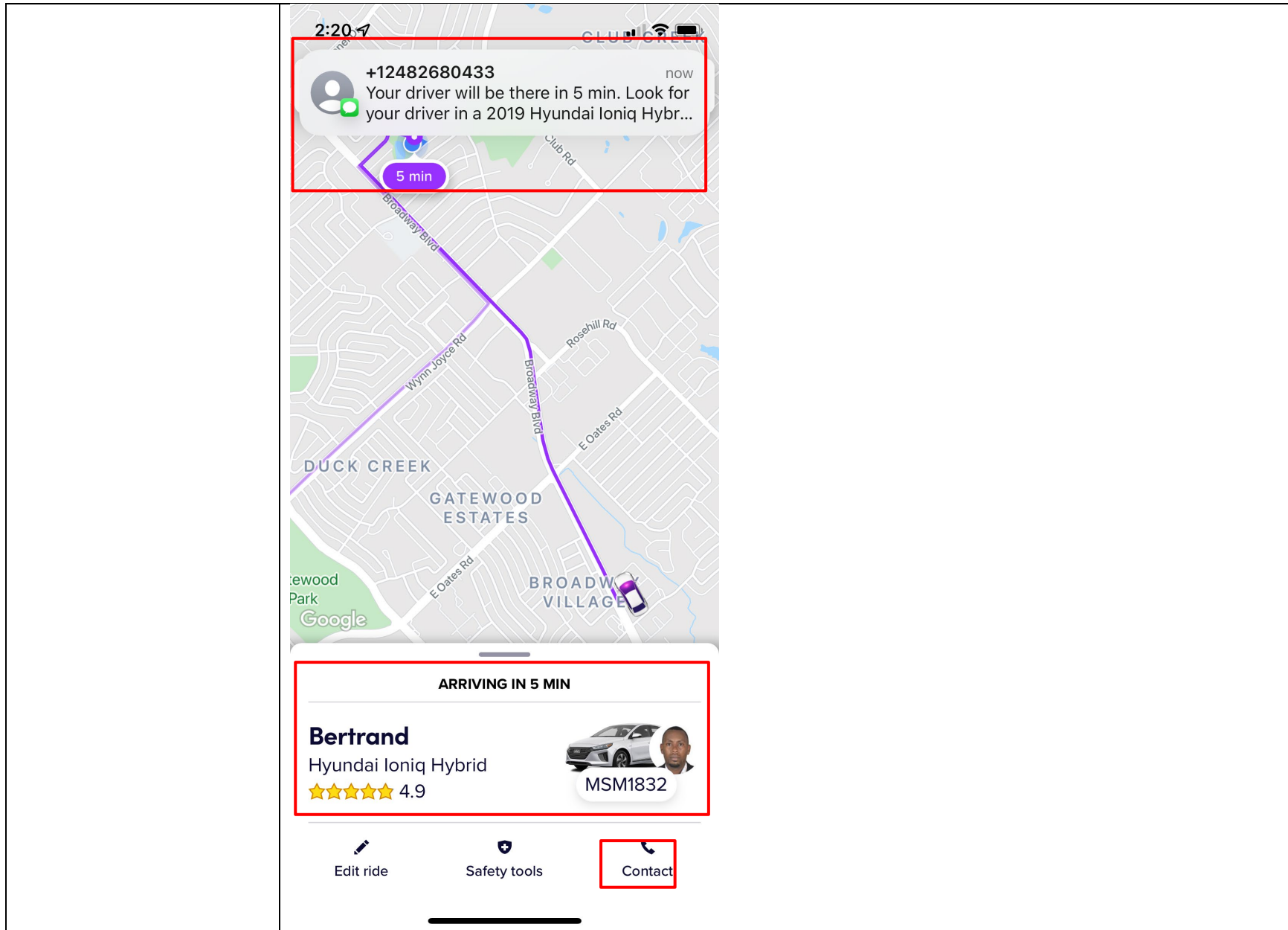

Attachment B for US Patent No. 7,630,724 Against Lyft Accused Products

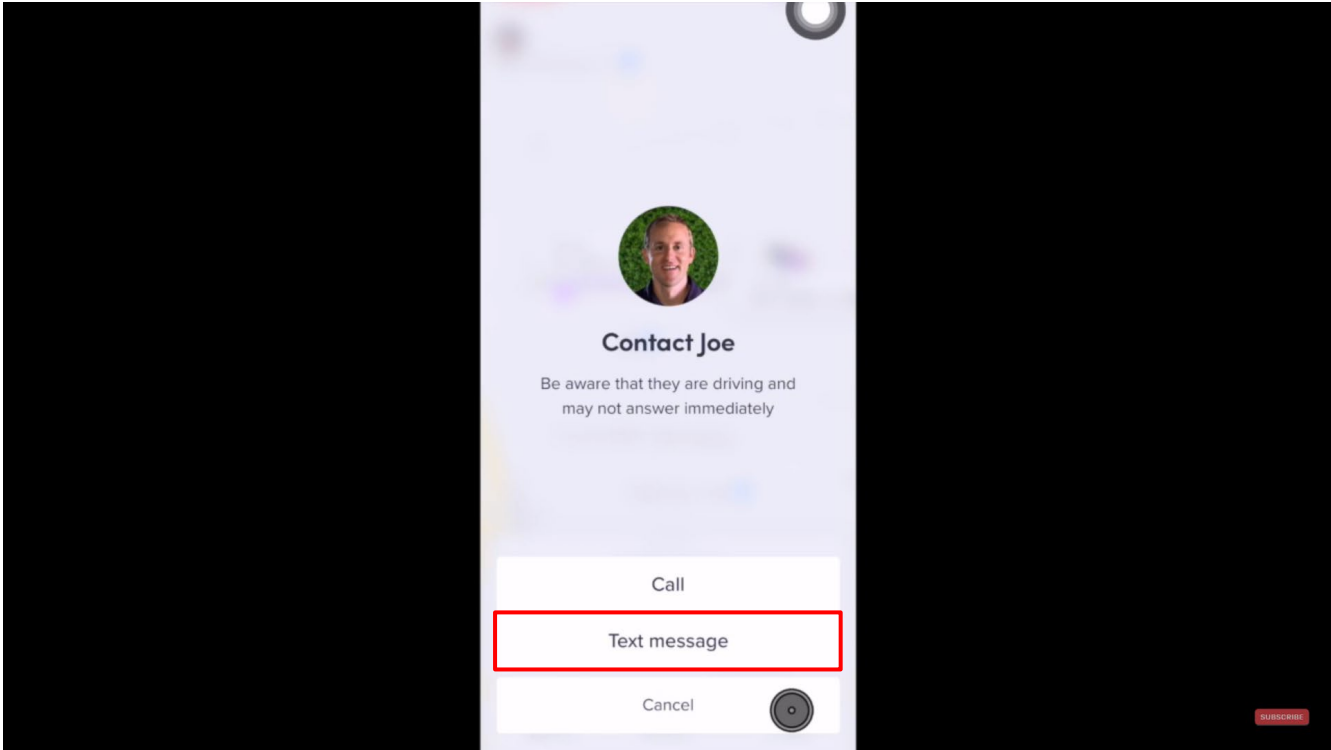
Claim – 7,630,724	Accused Products
	 <p>The screenshot shows a mobile contact card for 'Contact Joe'. At the top is a circular profile picture of a man. Below the picture is the name 'Contact Joe' and a warning: 'Be aware that they are driving and may not answer immediately'. At the bottom, there are three buttons: 'Call', 'Text message', and 'Cancel'. The 'Text message' button is highlighted with a red rectangular box. A 'SUBSCRIBE' button is visible in the bottom right corner of the contact card area.</p> <p>https://www.youtube.com/watch?v=j0RDMLcmOgU at 5:32</p>

Attachment B for US Patent No. 7,630,724 Against Lyft Accused Products

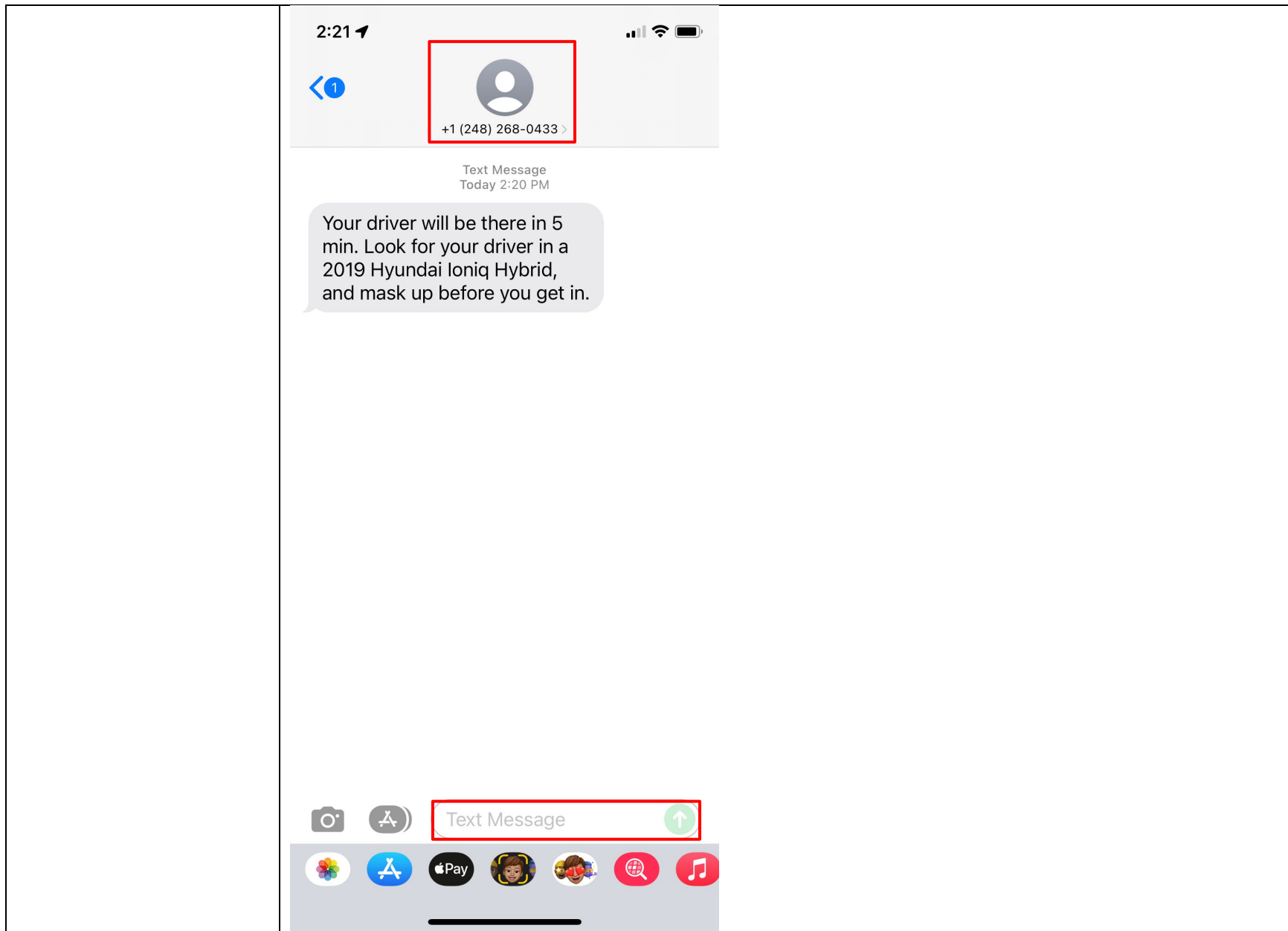

Attachment B for US Patent No. 7,630,724 Against Lyft Accused Products

Claim – 7,630,724	Accused Products
	<p data-bbox="575 277 957 315">Network addressing</p> <p data-bbox="590 350 1906 451">When a 'message' such as a file, image or video is transmitted across a network, it is first broken down into small blocks called <i>segments</i>. These are placed into containers called <i>packets</i>, typically by the Internet Protocol (IP). There are two versions of IP: version 4 and version 6.</p> <p data-bbox="590 475 1906 542">IP is responsible for delivering the packets from source to destination, and regardless of the version being used packets must use some form of addressing to uniquely identify the message source and message destination.</p> <p data-bbox="575 566 1717 597">https://www.open.edu/openlearncreate/mod/oucontent/view.php?id=129584&printable=1</p>
<p data-bbox="201 678 546 1359">12. A method for providing a cellular phone communication network as in claim 9 including the additional steps of: adding a new cell phone participant into a communication network of participating users by having the new cell phone participant transmit an identifier, a cell phone number and an IP address in an initial message to other participant users or to a server for retransmission of the data other network participants.</p>	<p data-bbox="569 678 1896 854">The Lyft Accused Products infringe directly and/or indirectly by performing, inducing others to perform, and/or contributing to the performance of: adding a new cell phone participant into a communication network of participating users by having the new cell phone participant transmit an identifier, a cell phone number and an IP address in an initial message to other participant users or to a server for retransmission of the data other network participants.</p> <p data-bbox="569 932 1896 1036">Lyft meets this limitation because riders/drivers add their account/identity information which includes their cell phone number. Additionally, when using the Lyft app, IP based communication to the Lyft server(s) includes IP addresses.</p> <p data-bbox="569 1045 1896 1221">For example, Lyft's servers provide shared rides where multiple passengers can share a ride using the Lyft app. Through this app, Lyft's servers add new passengers into the network in which a driver and a passenger may already be present. This new passenger has a cell phone number and IP address associated with their account which is used to match the new passenger with the already existing driver and passenger.</p>

Attachment B for US Patent No. 7,630,724 Against Lyft Accused Products

Claim – 7,630,724	Accused Products
	<p>Sharing your ride</p> <p>Our goal for Shared rides is to fill the empty seats in cars with riders going in the same direction. Chaining brings us one step closer to achieving that goal by pairing multiple parties together in one ride.</p> <p>It's important that you only request Shared rides for one or two riders and accurately choose the number of people in the app. If you don't follow this rule, the driver will be prompted to cancel your ride upon arrival.</p> <p>https://help.lyft.com/hc/e/articles/115013078848-About-Shared-rides</p> <p>See Claim 9[C] above.</p> <p>With respect to the limitations reciting the cellular phone number(s) or telephone number(s), the claim is met either literally or under the doctrine of equivalents.</p> <p>Further, to the extent this element is performed at least in part by Lyft's software source code, AGIS reserves the right to supplement these contentions pursuant to production of such source code by Lyft and to the extent Lyft requires additional information in accordance with P.R. 3-1 and for any other reasons.</p>
<p>13. A method for providing a cellular phone communication network as in claim 9 including the additional steps of: sending each participating user directly or to a server for retransmission the geographic location of the sender of a message.</p>	<p>The Lyft Accused Products infringes directly and/or indirectly by performing, inducing others to perform, and/or contributing to the performance of: sending each participating user directly or to a server for retransmission the geographic location of the sender of a message.</p> <p>Lyft meets this limitation because riders/drivers add their account/identity information which includes their cell phone number. Additionally, when using the Lyft app, IP based communication to the Lyft server(s) includes IP addresses. For example, Lyft's servers continuously fetch the location information of all the passengers and the driver present in a ride. Therefore, even when a passenger sends a message to the driver, the geographic location is retransmitted from their phone.</p>

Attachment B for US Patent No. 7,630,724 Against Lyft Accused Products

Claim – 7,630,724	Accused Products
<p>14. A method for providing a cellular phone communication network as in claim 9 including the additional steps of: automatically calling the nearest fixed location from a particular group including: police stations, fire stations, or EMTs or other fixed locations by one or more of the cellular phone network participants.</p>	<p>The Lyft Accused Products infringes directly and/or indirectly by performing, inducing others to perform, and/or contributing to the performance of: automatically calling the nearest fixed location from a particular group including: police stations, fire stations, or EMTs or other fixed locations by one or more of the cellular phone network participants.</p> <p>For example, Lyft provides an emergency button to its passengers which allows Lyft to automatically place a 911 call to the nearest fixed location such as a police station.</p> <div data-bbox="577 592 1218 1323" data-label="Image"> </div> <p>https://www.lyft.com/safety</p> <div data-bbox="1365 868 1890 917" data-label="Section-Header"> <p>911 is just a few taps away</p> </div> <div data-bbox="1365 950 1890 1136" data-label="Text"> <p>To give you immediate access to emergency help in case you ever need it (and to help you ride a little easier even when you don't), we built a 911 button into your app. It's there for both riders and drivers, and when you tap it, the app will display your current location and vehicle info so you can quickly share details with emergency dispatchers.</p> </div>

Attachment B for US Patent No. 7,630,724 Against Lyft Accused Products

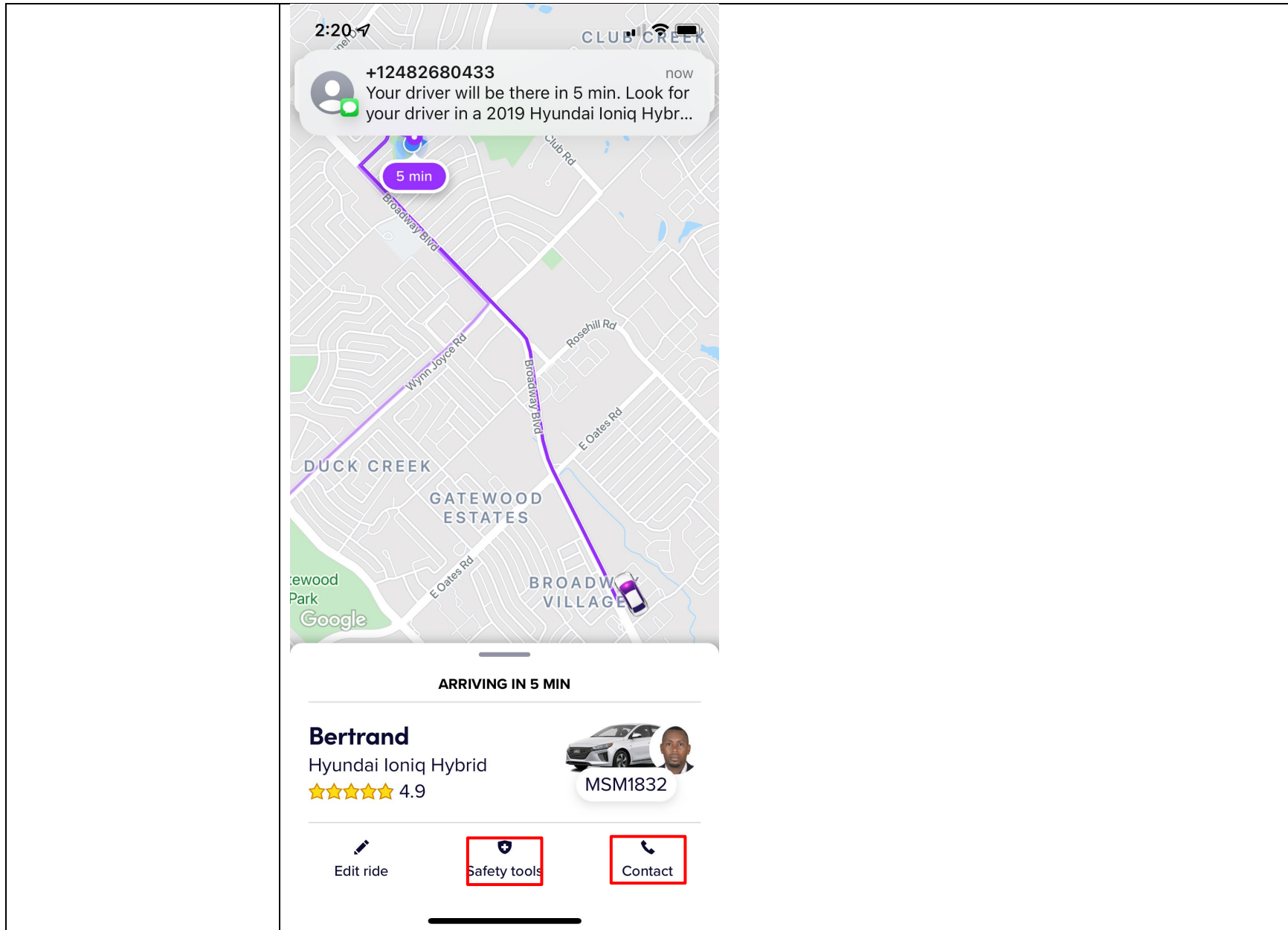

Attachment B for US Patent No. 7,630,724 Against Lyft Accused Products

Claim – 7,630,724	Accused Products
	Further, to the extent this element is performed at least in part by Lyft's software source code, AGIS reserves the right to supplement these contentions pursuant to production of such source code by Lyft and to the extent Lyft requires additional information in accordance with P.R. 3-1 and for any other reasons.
<p>15. A method for providing a cellular phone communication network as in claim 9 including the additional steps of: entering on a user's touch display screen a new track by touching the display screen at the correct map location and selecting the type of symbol to be displayed, causing that symbol identifier to be transmitted to the other network participants either directly or through a server and as the track's location moves, sending new location data to the other participants relative to the new track so that each of the participating user's display is updated with the new track's position.</p>	<p>The Lyft Accused Products infringes directly and/or indirectly by performing, inducing others to perform, and/or contributing to the performance of: entering on a user's touch display screen a new track by touching the display screen at the correct map location and selecting the type of symbol to be displayed, causing that symbol identifier to be transmitted to the other network participants either directly or through a server and as the track's location moves, sending new location data to the other participants relative to the new track so that each of the participating user's display is updated with the new track's position.</p> <p>For example, Lyft allows passengers to change the destination address while executing a ride. As a result, the new location is transmitted to the co-passengers and the driver on their mobile devices. Further, a new symbol is displayed for the new location selected by the passenger.</p>

Attachment B for US Patent No. 7,630,724 Against Lyft Accused Products

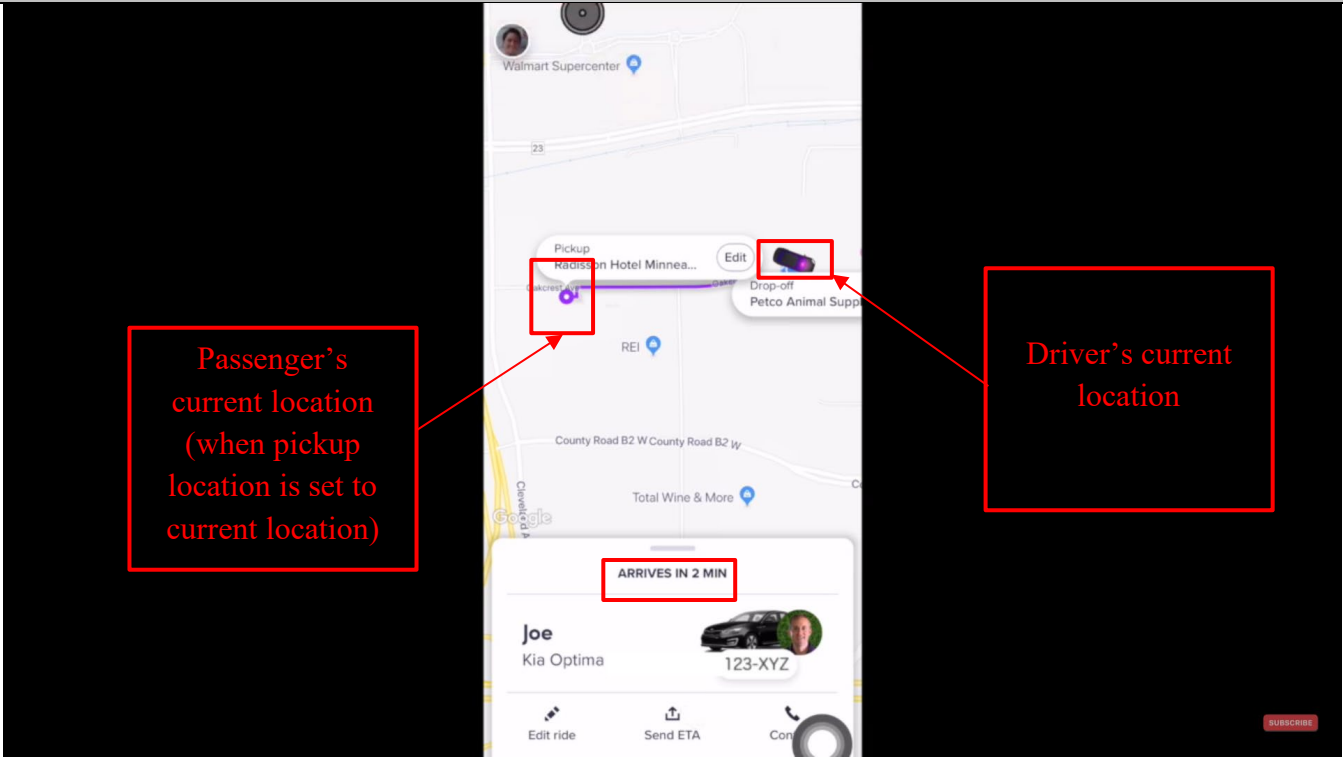
Claim – 7,630,724	Accused Products
	 <p>Passenger's current location (when pickup location is set to current location)</p> <p>Driver's current location</p> <p>ARRIVES IN 2 MIN</p> <p>Joe Kia Optima 123-XYZ</p> <p>https://www.youtube.com/watch?v=j0RDMLcmOgU at 5:07, Annotated</p>

Attachment B for US Patent No. 7,630,724 Against Lyft Accused Products

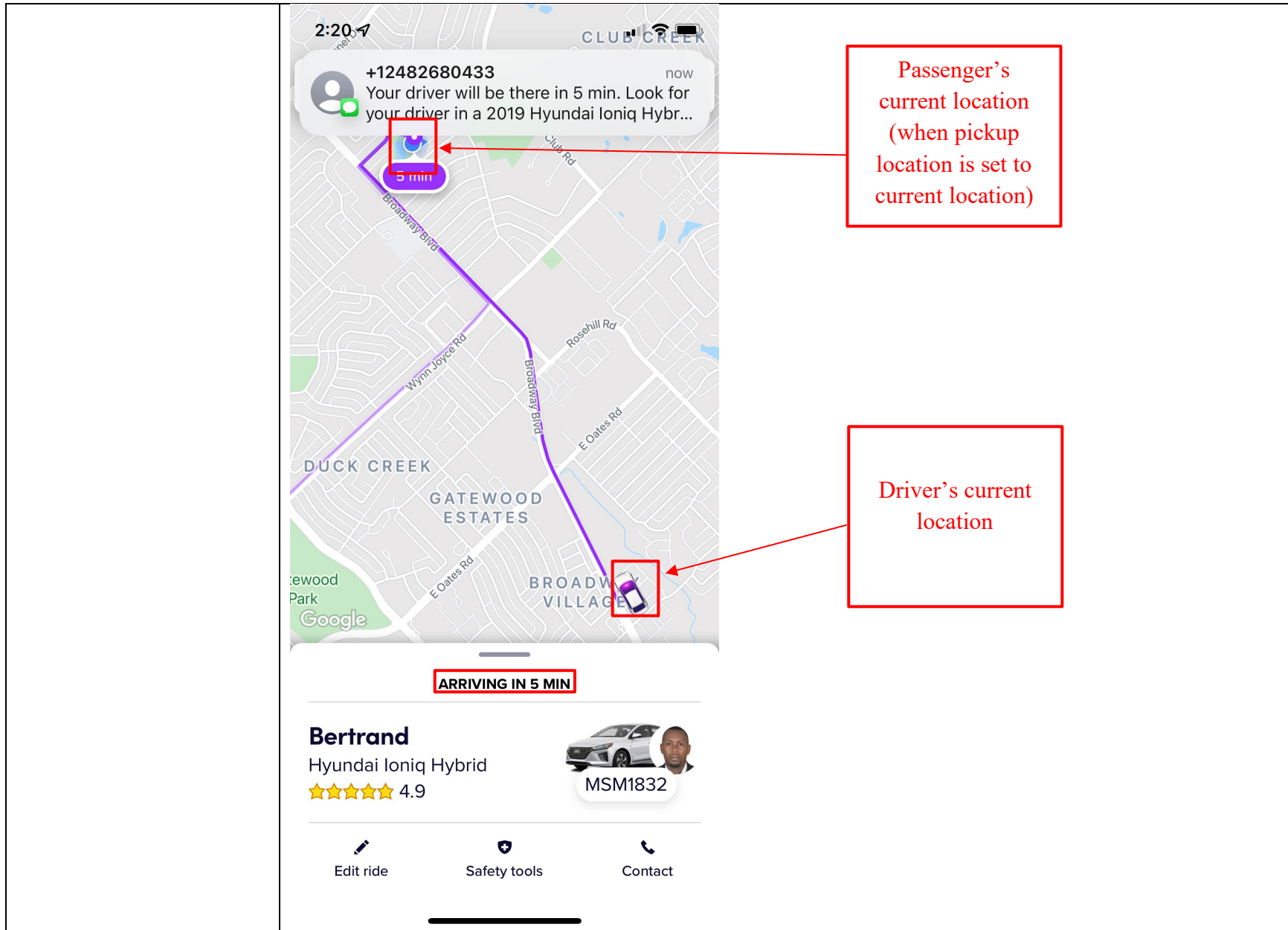

Attachment B for US Patent No. 7,630,724 Against Lyft Accused Products

Claim – 7,630,724	Accused Products
<p>16[P]. A method of providing a cellular phone communication network for designated participating users, each having a similarly equipped PDA cellular phone that includes a CPU, a GPS navigational system and a touch screen display comprising:</p>	<p><i>See claim 9[A] above</i></p>
<p>16[A]. selecting an icon that establishes rapid voice call initiation and communication to the users of the cellular telephone PDA/GPS network system by touching their symbol on the phone's a touch screen;</p>	<p>The Lyft Accused Product(s) performs a computer implemented method as set forth below. Lyft further infringes directly and/or indirectly by performing, inducing others to perform, and/or contributing to the performance of: selecting an icon that establishes rapid voice call initiation and communication to the users of the cellular telephone PDA/GPS network system by touching their symbol on the phone's a touch screen.</p> <p>Lyft meets this limitation because riders/drivers are provided with the functionality of selectable interface elements for calling the drivers/riders. For example, when the driver is matched to the passenger, both the driver and the passenger get the call icon (“rapid voice initiation and communication”) on their respective mobile phones display in the Lyft driver and Lyft app respectively through which both of them call each other by tapping the call icon on their respective touch screen display.</p>

Attachment B for US Patent No. 7,630,724 Against Lyft Accused Products

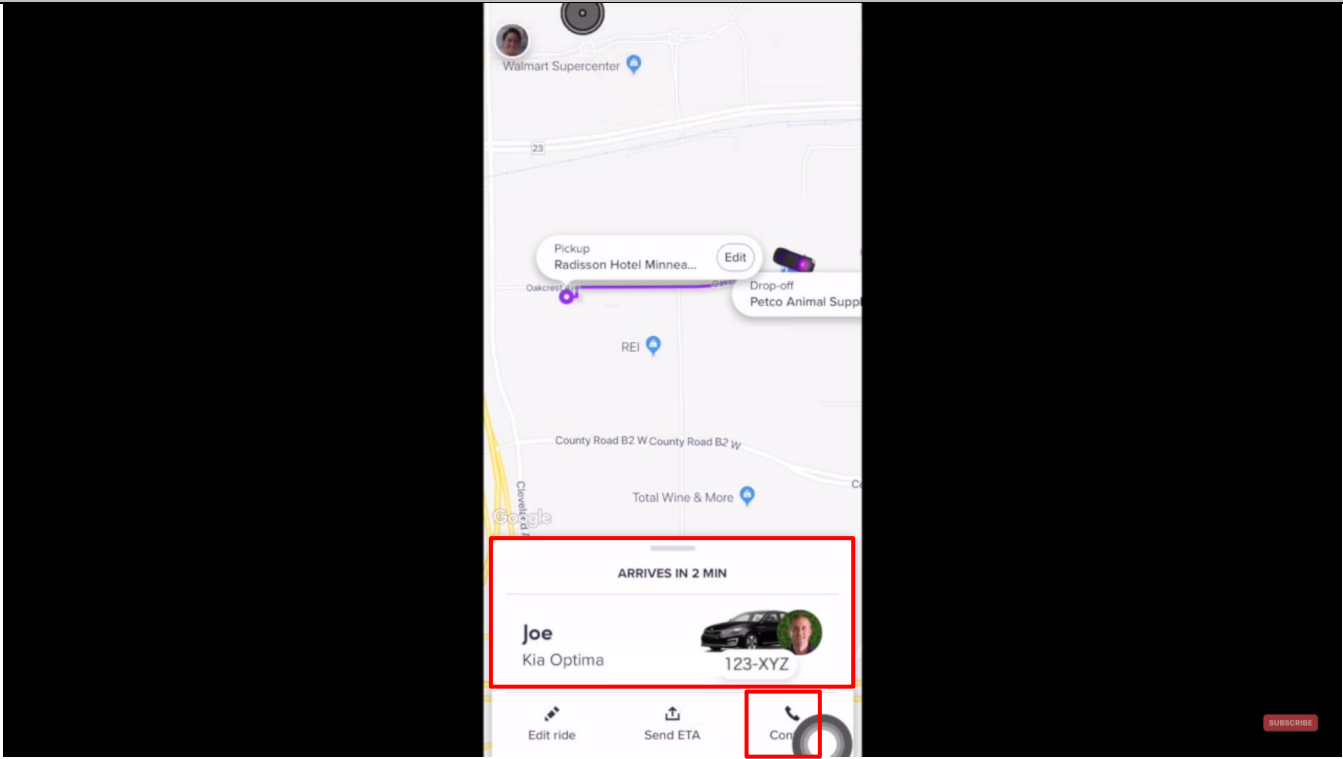
Claim – 7,630,724	Accused Products
	 <p>https://www.youtube.com/watch?v=j0RDMLcmOgU at 5:07</p>

Attachment B for US Patent No. 7,630,724 Against Lyft Accused Products

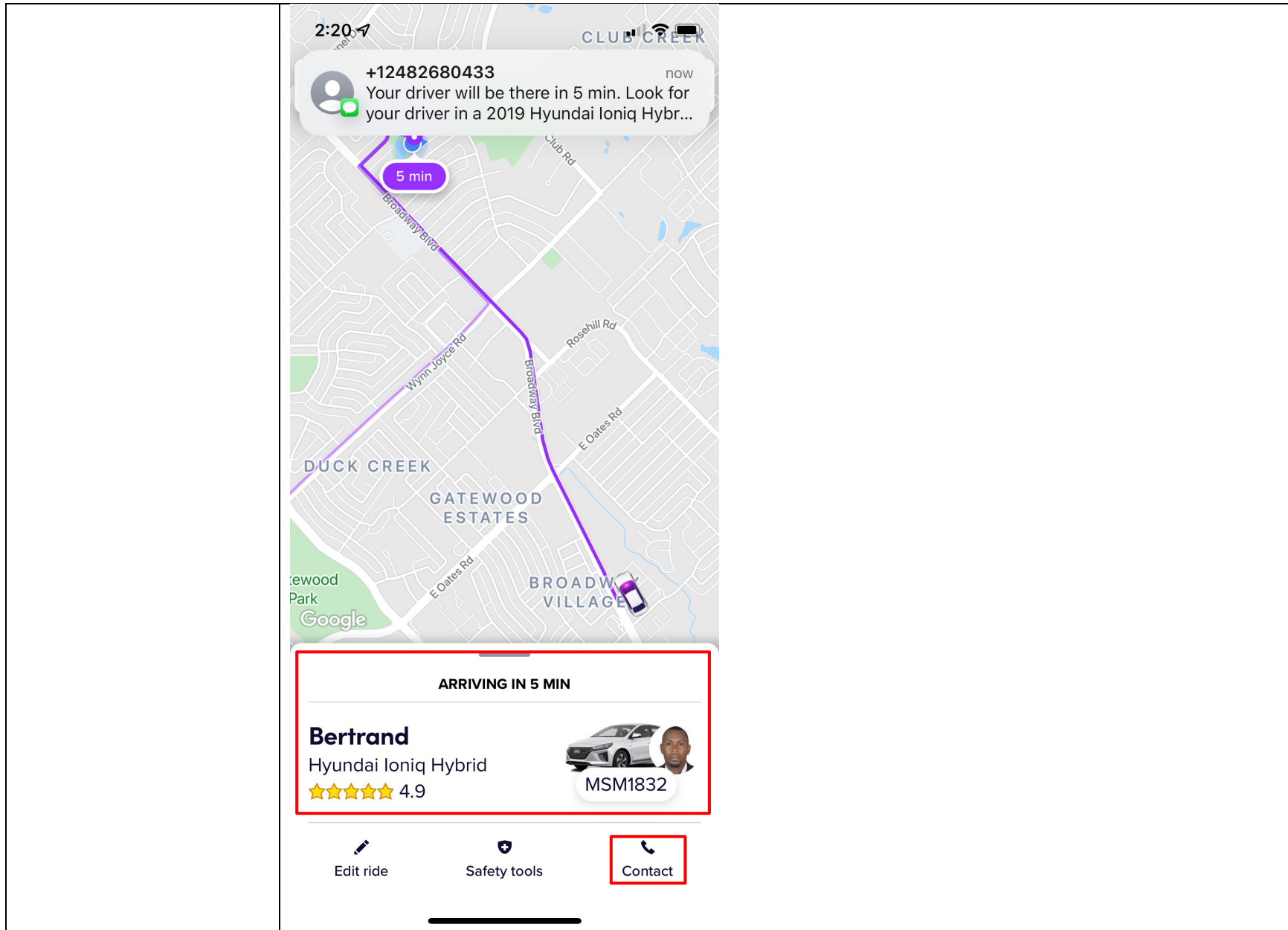

Attachment B for US Patent No. 7,630,724 Against Lyft Accused Products

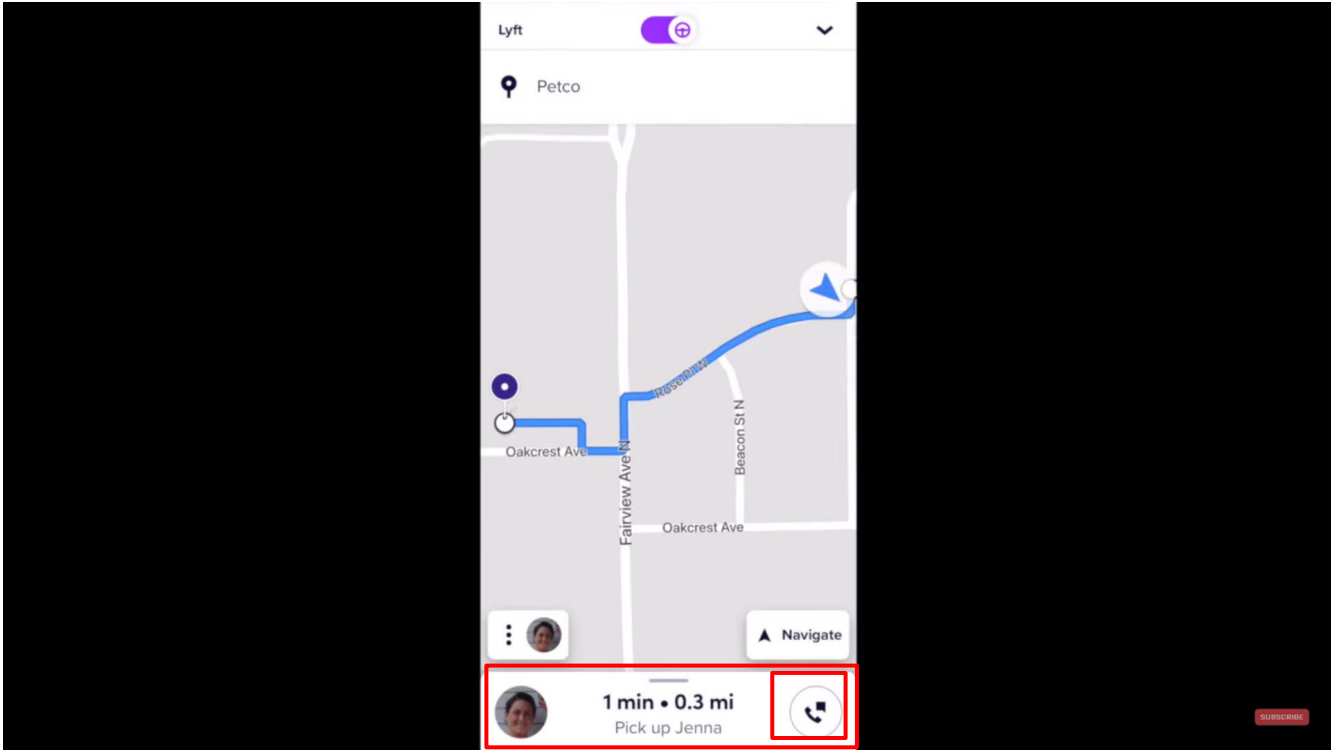
Claim – 7,630,724	Accused Products
	 <p>The screenshot shows the Lyft mobile application interface. At the top, the word "Lyft" is displayed with a toggle switch and a dropdown arrow. Below this, the destination "Petco" is shown with a location pin icon. The main area is a map with a blue route line. The route starts at a pickup location (a white circle) and goes through several streets: Oakcrest Ave, Fairview Ave N, and Beacon St N. A driver profile card is visible at the bottom, showing a driver's photo, the text "1 min • 0.3 mi", and "Pick up Jenna". A red box highlights the driver's profile card and a call icon to the right of it. A "SUBSCRIBE" button is visible in the bottom right corner of the video frame.</p> <p>https://www.youtube.com/watch?v=jVUy9poJDng at 10:46</p>

Attachment B for US Patent No. 7,630,724 Against Lyft Accused Products

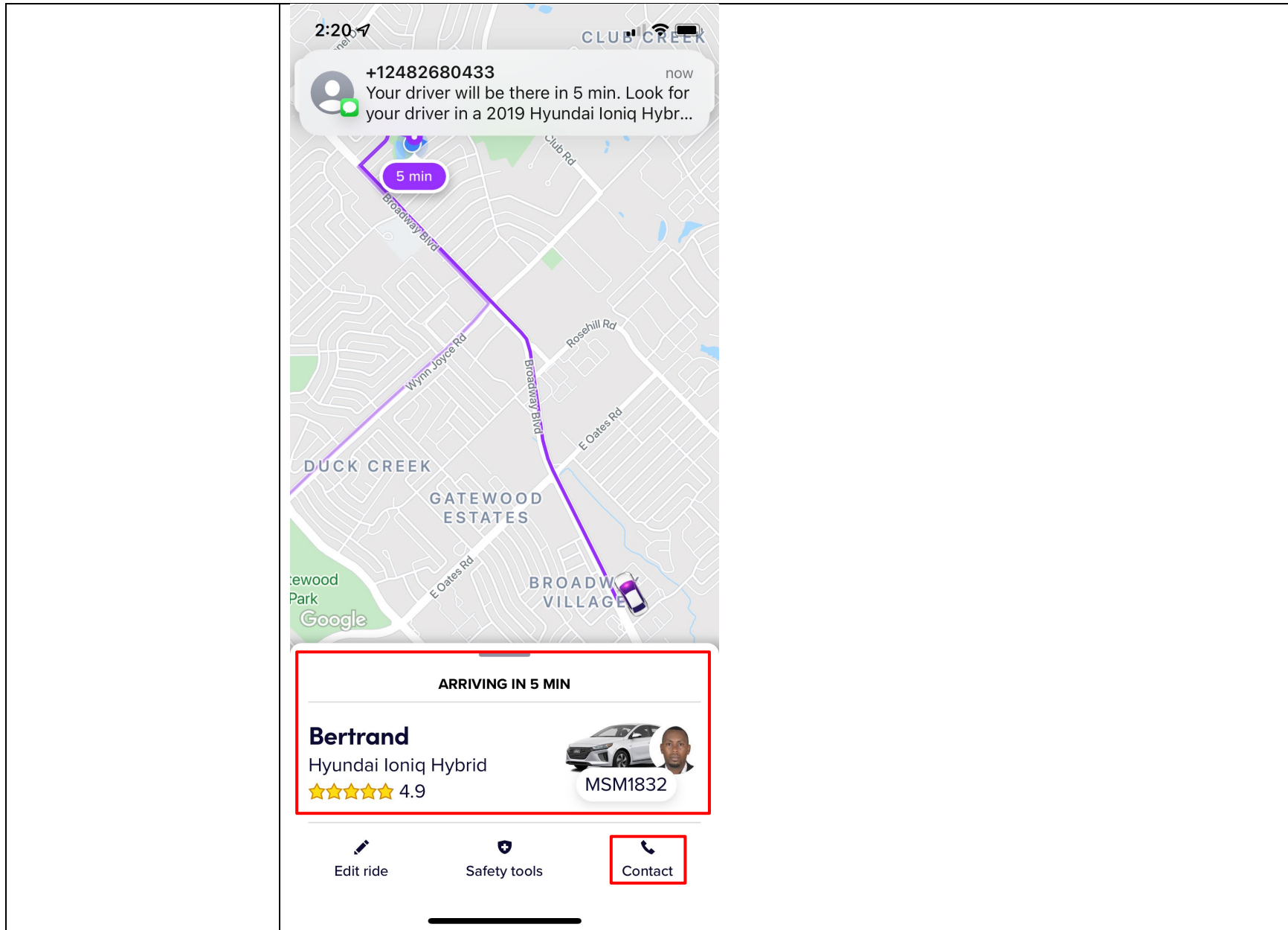

Attachment B for US Patent No. 7,630,724 Against Lyft Accused Products

Claim – 7,630,724	Accused Products
	<p>See claim 9[D] above.</p> <p>Further, to the extent this element is performed at least in part by Lyft's software source code, AGIS reserves the right to supplement these contentions pursuant to production of such source code by Lyft and to the extent Lyft requires additional information in accordance with P.R. 3-1 and for any other reasons.</p>
<p>16[B]. transmitting high speed internet rapid transmission of operator selected text messages, photographs, voice recordings and video to other cellular phone users using the touch screen;</p>	<p>The Lyft Accused Product(s) performs a computer implemented method as set forth below. Lyft further infringes directly and/or indirectly by performing, inducing others to perform, and/or contributing to the performance of: transmitting high speed internet rapid transmission of operator selected text messages, photographs, voice recordings and video to other cellular phone users using the touch screen.</p> <p>Lyft meets this limitation because the riders/drivers, via the Lyft apps, are provided with the functionality of communicating messages to drivers/riders using selectable interface elements on the display. The messages include text, voice, and/or video. The messages can be transmitted over IP based communications.</p> <p>For example, when the driver is matched to the passenger, both the driver and the passenger get the call icon on their respective mobile phones display in the Lyft driver and Lyft app respectively through which both of them call each other by tapping the call icon on their respective touch screen display.</p>

Attachment B for US Patent No. 7,630,724 Against Lyft Accused Products

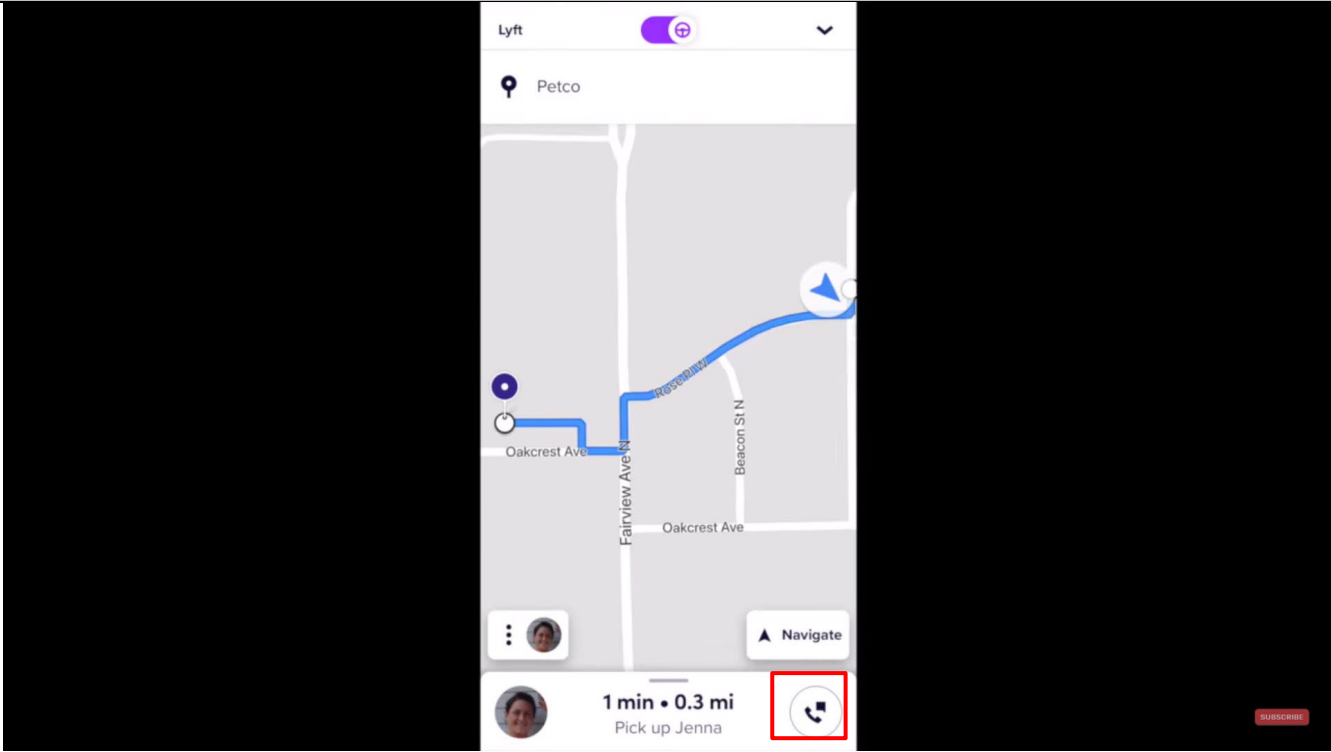
Claim – 7,630,724	Accused Products
	 <p>https://www.youtube.com/watch?v=jVUy9poJDng at 10:46</p>

Attachment B for US Patent No. 7,630,724 Against Lyft Accused Products

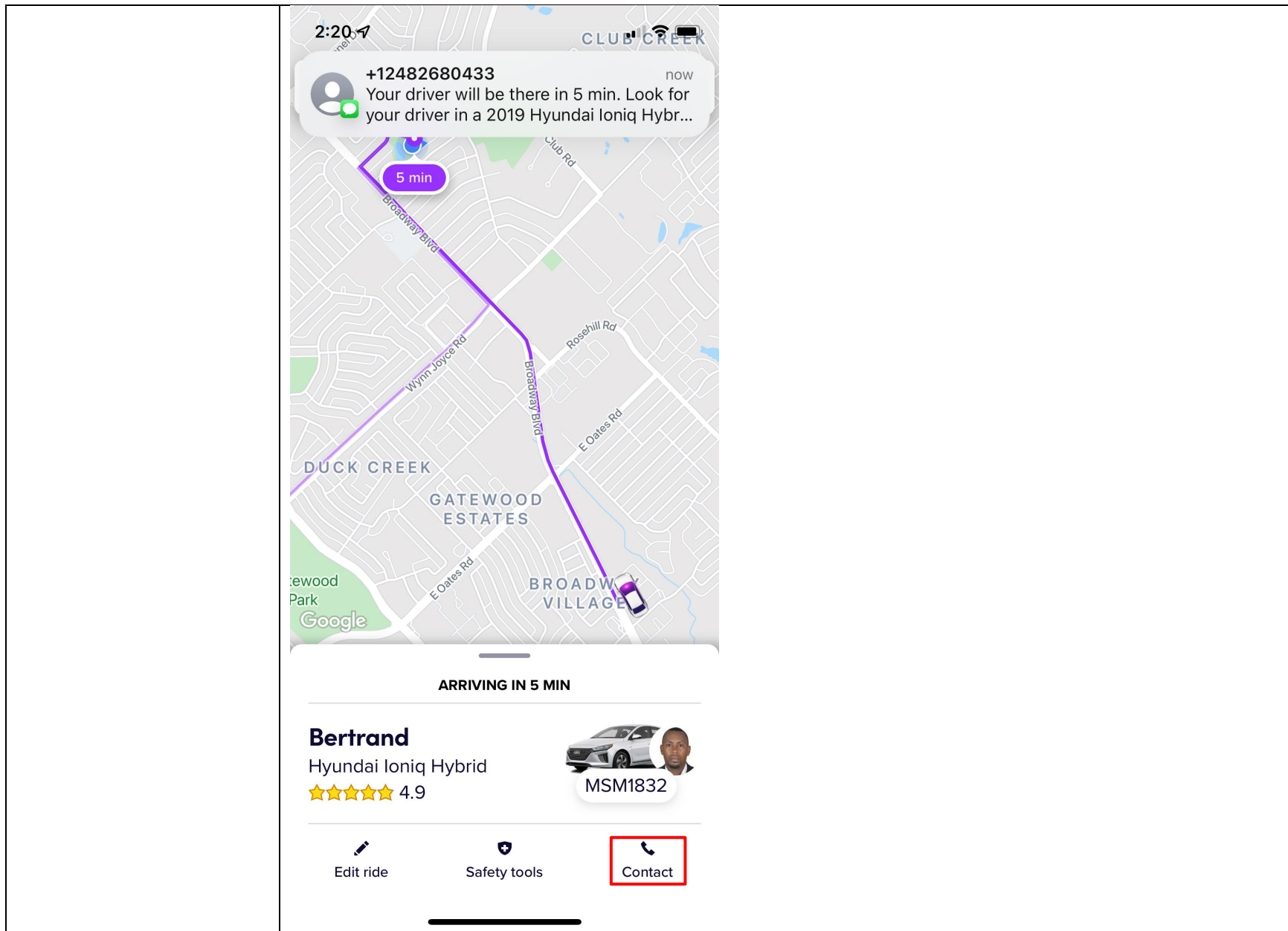

Attachment B for US Patent No. 7,630,724 Against Lyft Accused Products

Claim – 7,630,724	Accused Products
	 <p>The screenshot shows a mobile interface for contacting a Lyft driver named Jenna. The text messages are as follows:</p> <ul style="list-style-type: none">✕ Contact Jenna ☎I'm your driver, Joe >Hi, where are you? >Be there in 1 min >Stuck in traffic >Can't take a call now, sorry >I'm in a black Kia Optima Hybrid >Gate code, please? > <p>A red square highlights a purple circular call button with a white telephone handset icon. A 'SUBSCRIBE' button is visible in the bottom right corner of the video frame.</p> <p>https://www.youtube.com/watch?v=jVUy9poJDng at 11:21</p>

Attachment B for US Patent No. 7,630,724 Against Lyft Accused Products

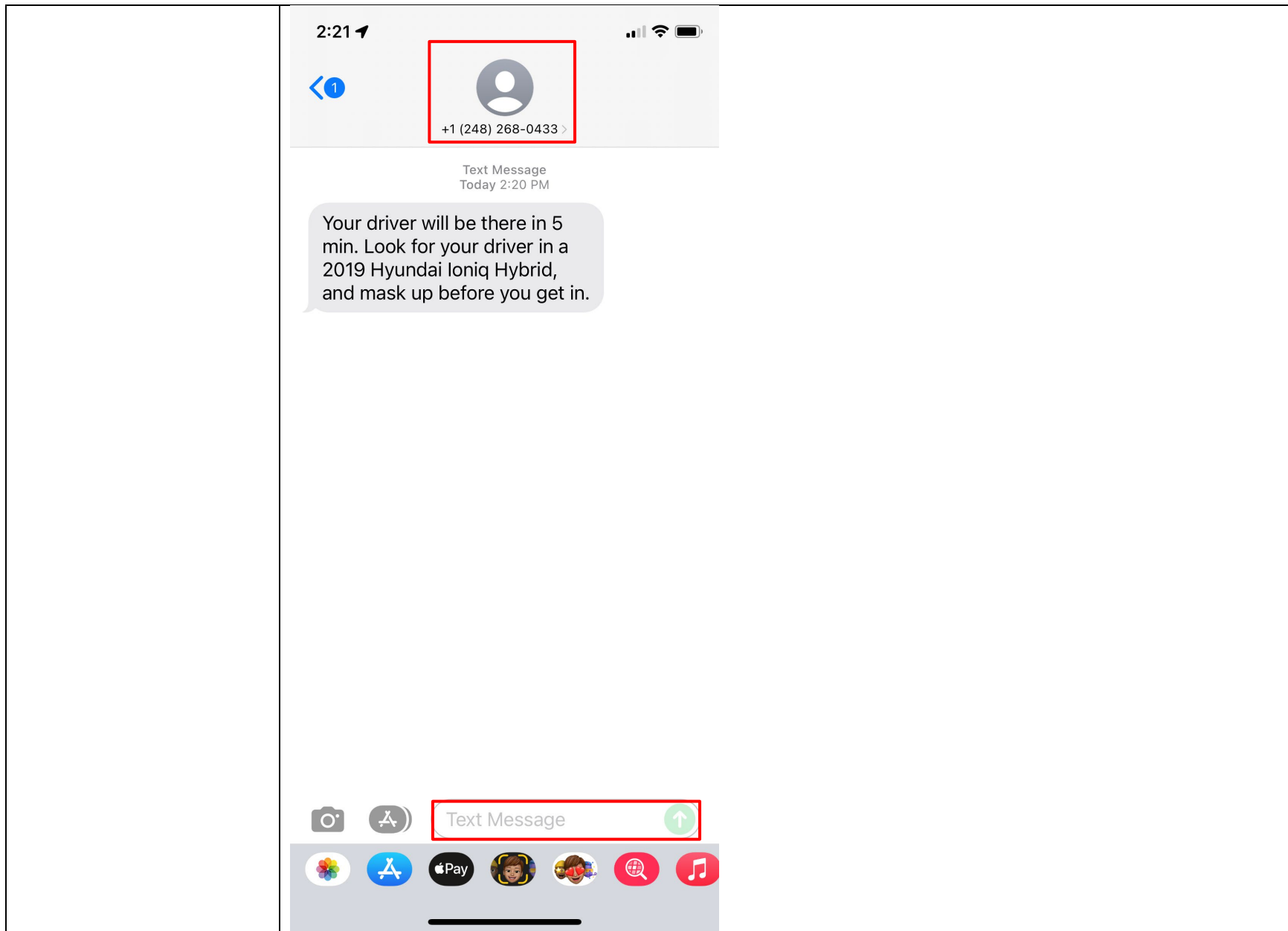

Attachment B for US Patent No. 7,630,724 Against Lyft Accused Products

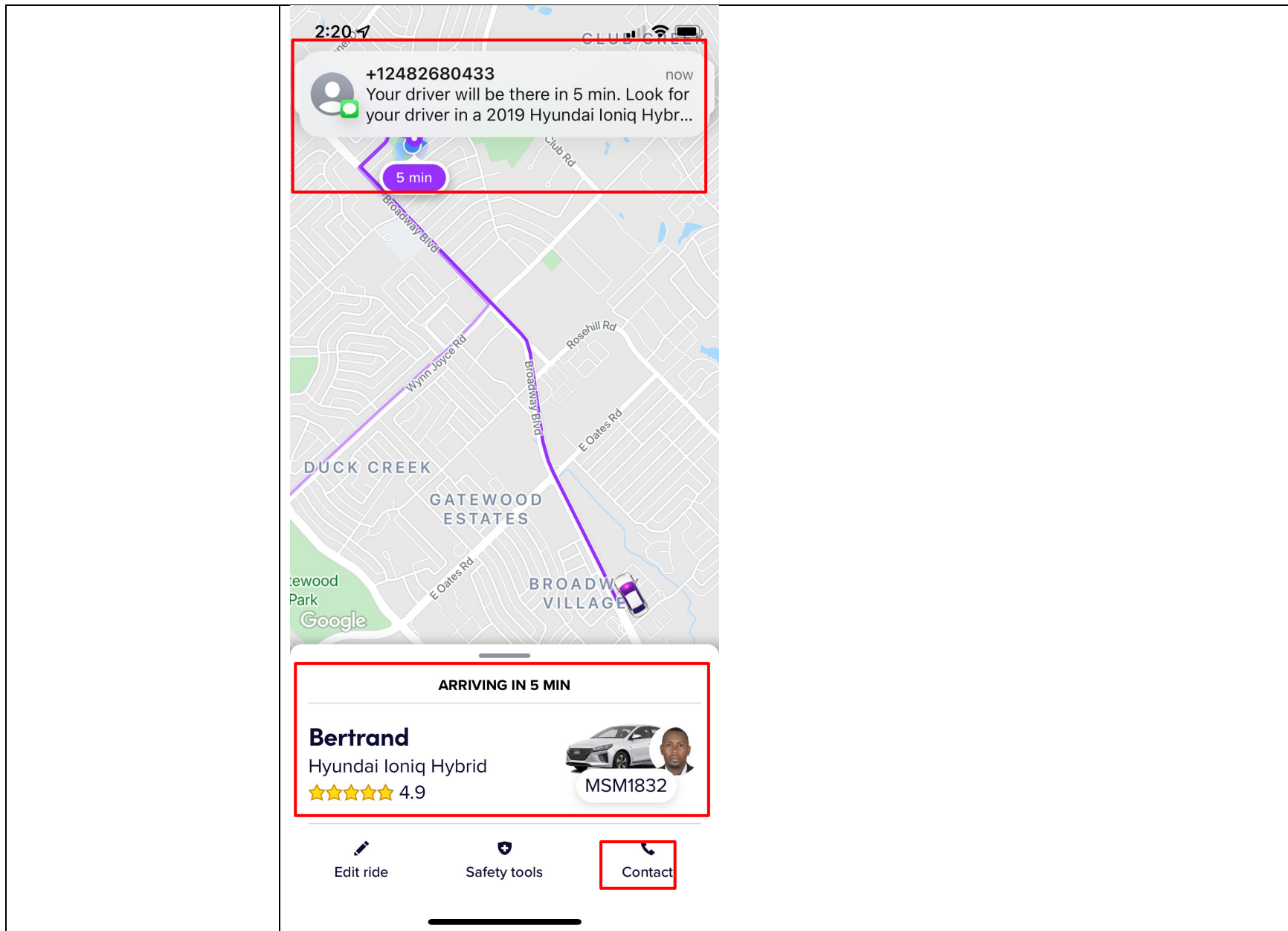

Attachment B for US Patent No. 7,630,724 Against Lyft Accused Products

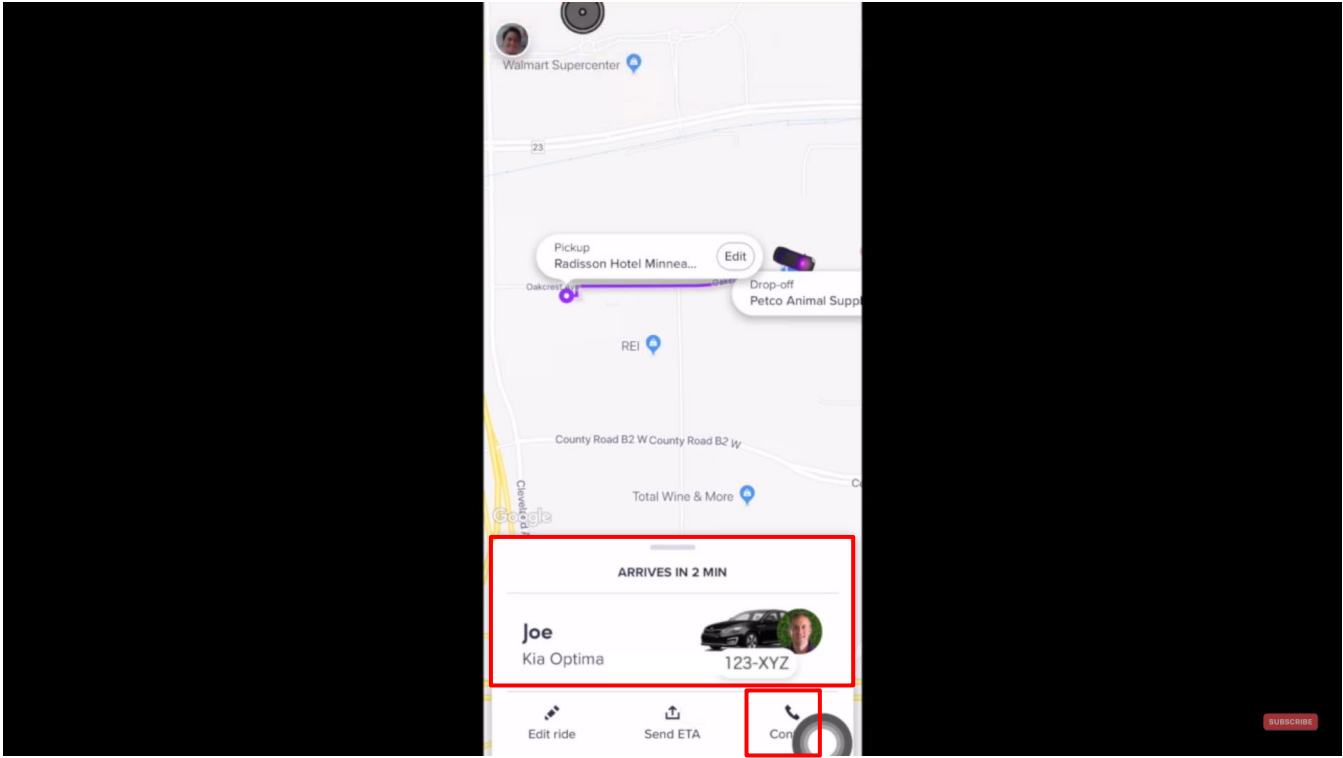
Claim – 7,630,724	Accused Products
	 <p>https://www.youtube.com/watch?v=j0RDMLcmOgU at 5:07</p>

Attachment B for US Patent No. 7,630,724 Against Lyft Accused Products

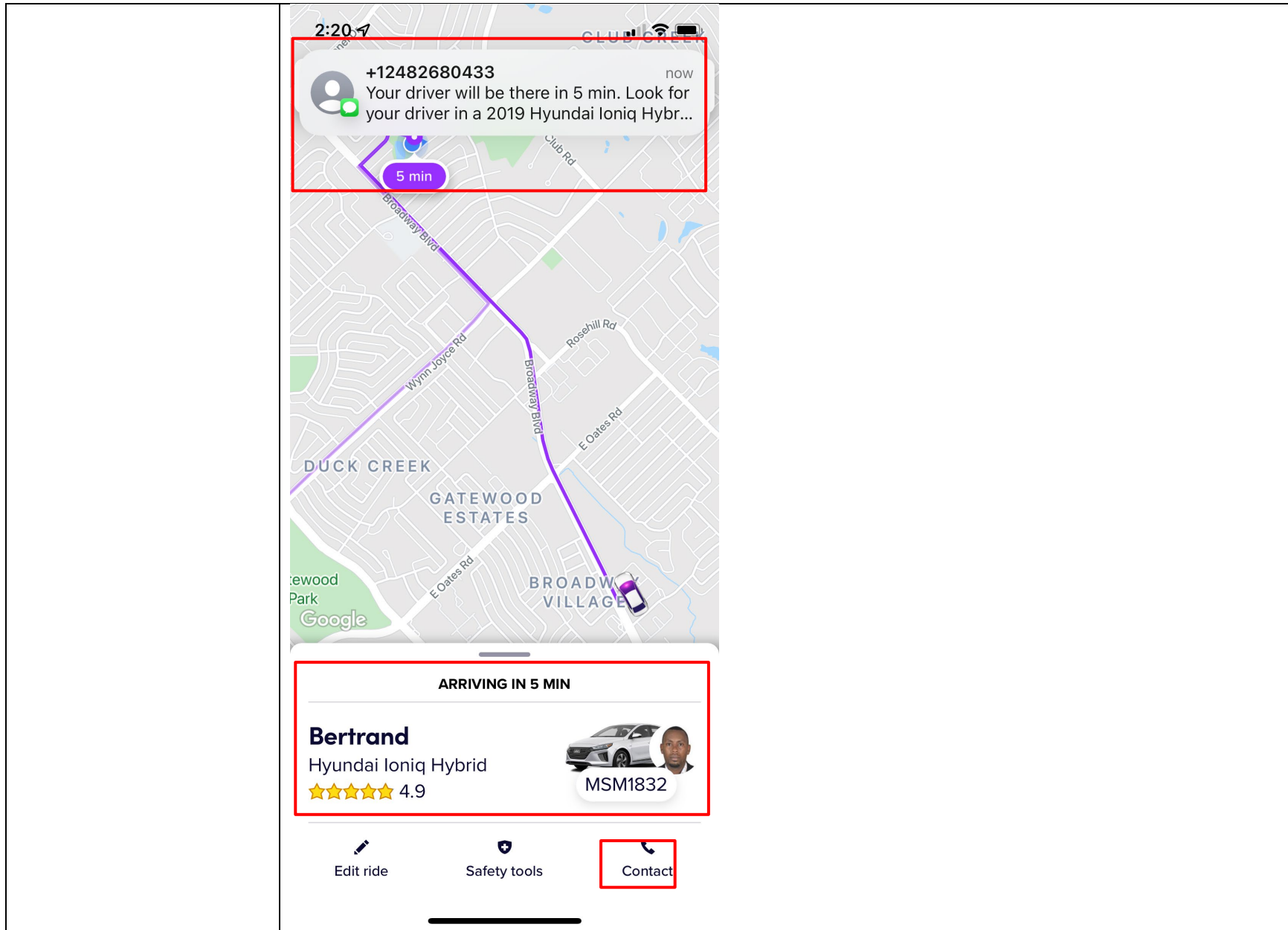

Attachment B for US Patent No. 7,630,724 Against Lyft Accused Products

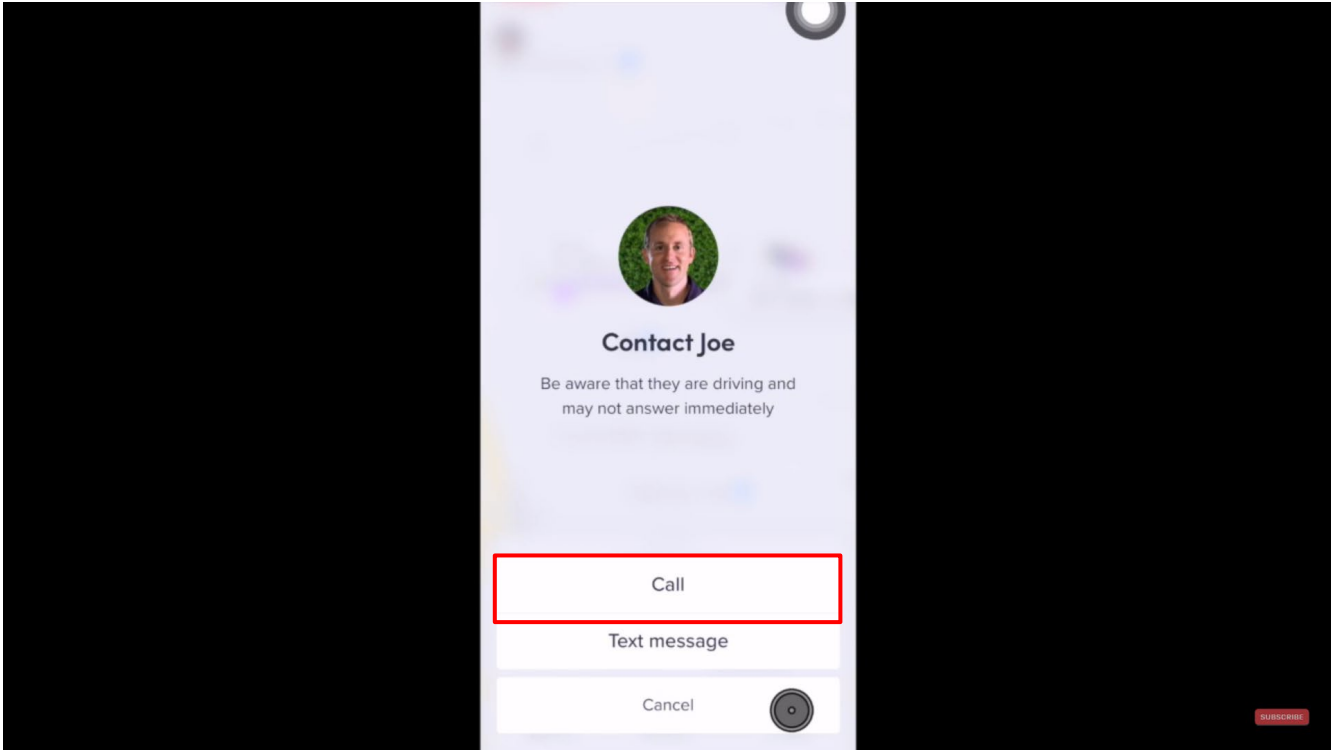
Claim – 7,630,724	Accused Products
	 <p>The screenshot shows a mobile application interface for contacting a driver named 'Contact Joe'. The interface includes a circular profile picture of a man, the name 'Contact Joe', and a warning: 'Be aware that they are driving and may not answer immediately'. Below this, there are three buttons: 'Call' (highlighted with a red rectangular box), 'Text message', and 'Cancel'. A 'SUBSCRIBE' button is visible in the bottom right corner of the app interface.</p> <p>https://www.youtube.com/watch?v=j0RDMLcmOgU at 5:32</p>

Attachment B for US Patent No. 7,630,724 Against Lyft Accused Products

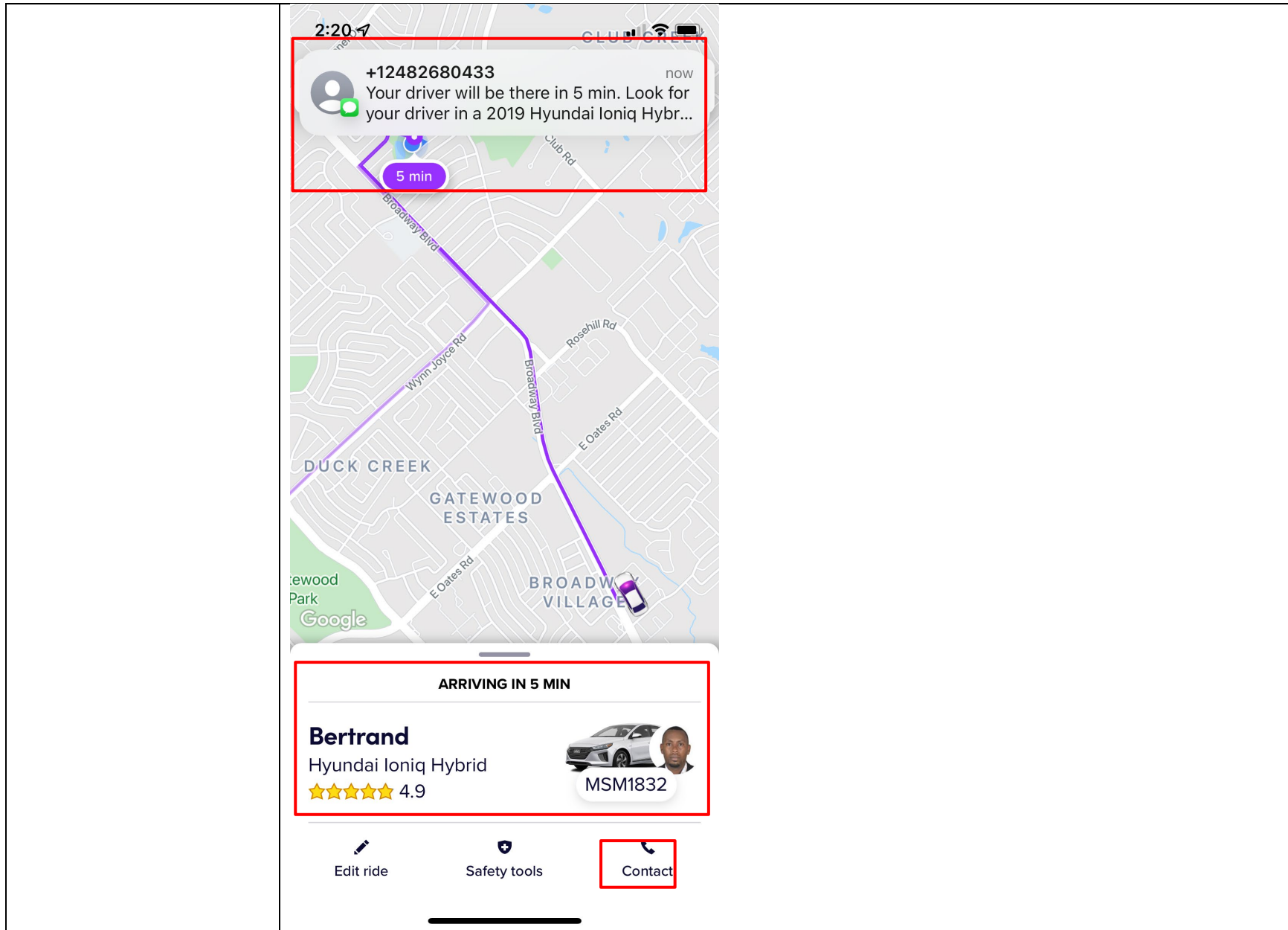

Attachment B for US Patent No. 7,630,724 Against Lyft Accused Products

Claim – 7,630,724	Accused Products
	<p>See claim 9[D] above.</p> <p>Further, to the extent this element is performed at least in part by Lyft's software source code, AGIS reserves the right to supplement these contentions pursuant to production of such source code by Lyft and to the extent Lyft requires additional information in accordance with P.R. 3-1 and for any other reasons.</p>
<p>16[C]. accessing a server for establishing high speed internet communications between said cellular phone network users and said server; and</p>	<p>The Lyft Accused Product(s) performs a computer implemented method as set forth below. Lyft further infringes directly and/or indirectly by performing, inducing others to perform, and/or contributing to the performance of: accessing a server for establishing high speed internet communications between said cellular phone network users and said server.</p> <p>Lyft meets this limitation because the riders/drivers, via the Lyft apps, use IP based communications to/from Lyft server(s). For example, when the passenger requests a ride from the Lyft app installed on their mobile phone, the ride request message is broadcasted to the nearby drivers who are online on the Lyft driver app.</p> <p>For example, when the driver accepts the ride request of the passenger, the passenger's mobile phone receives the driver's information such as name, location, and driver's photo. After the passenger and the driver match, both of them get the option ("icon") to text and call ("low speed communication") each other.</p>

Attachment B for US Patent No. 7,630,724 Against Lyft Accused Products

Claim – 7,630,724	Accused Products
	<p data-bbox="625 261 840 423">Driver's device displaying passenger's ride request message</p> <p data-bbox="667 578 844 691">Passenger's profile photo and name</p>  <p data-bbox="575 883 1491 914">https://www.youtube.com/watch?v=jVUy9poJDng at 10:24, Annotated</p>

Attachment B for US Patent No. 7,630,724 Against Lyft Accused Products

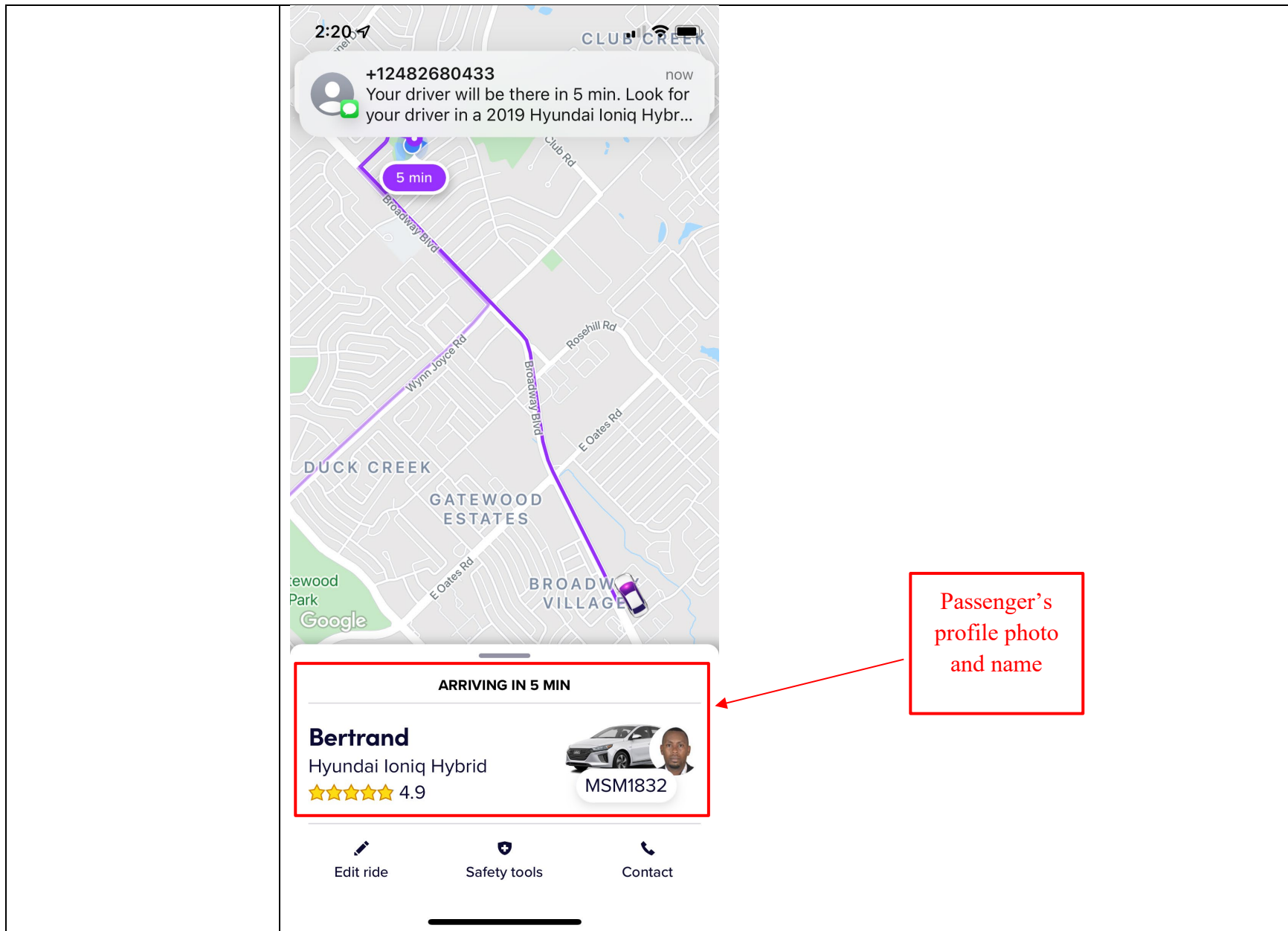

Attachment B for US Patent No. 7,630,724 Against Lyft Accused Products

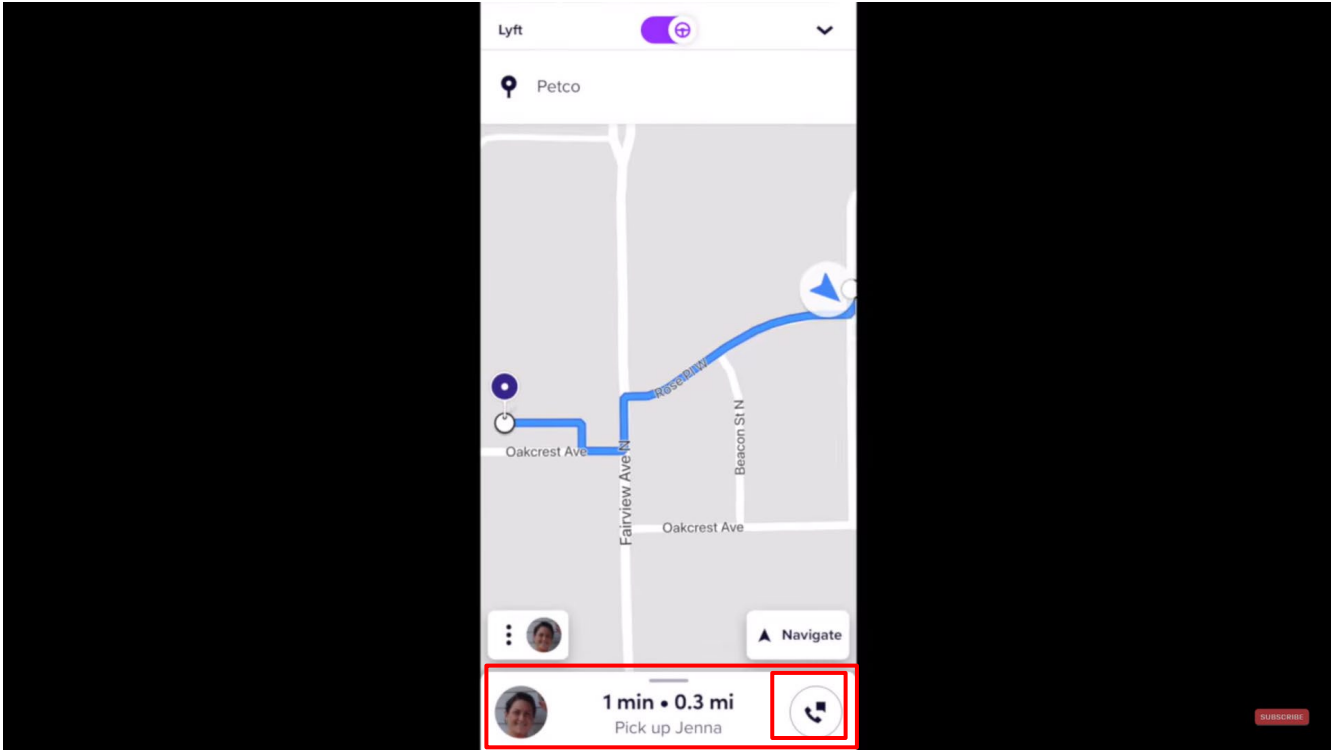
Claim – 7,630,724	Accused Products
	 <p>The screenshot displays the Lyft mobile application interface. At the top, the word "Lyft" is visible with a toggle switch and a dropdown arrow. Below this, the destination "Petco" is shown with a location pin icon. The main area features a map with a blue navigation route. The route starts at a location marked with a white circle, goes south on Oakcrest Ave, then east on Fairview Ave N, then north on Beacon St N, and finally east on Oakcrest Ave. A blue arrow at the end of the route indicates the direction of travel. At the bottom of the screen, there is a pickup card for "Jenna" with a profile picture, a timer showing "1 min • 0.3 mi", and a "Pick up Jenna" button. A red box highlights the "Call" icon (a telephone handset) on the right side of the pickup card. A "SUBSCRIBE" button is visible in the bottom right corner of the video frame.</p> <p>https://www.youtube.com/watch?v=jVUy9poJDng at 10:46</p>

Attachment B for US Patent No. 7,630,724 Against Lyft Accused Products

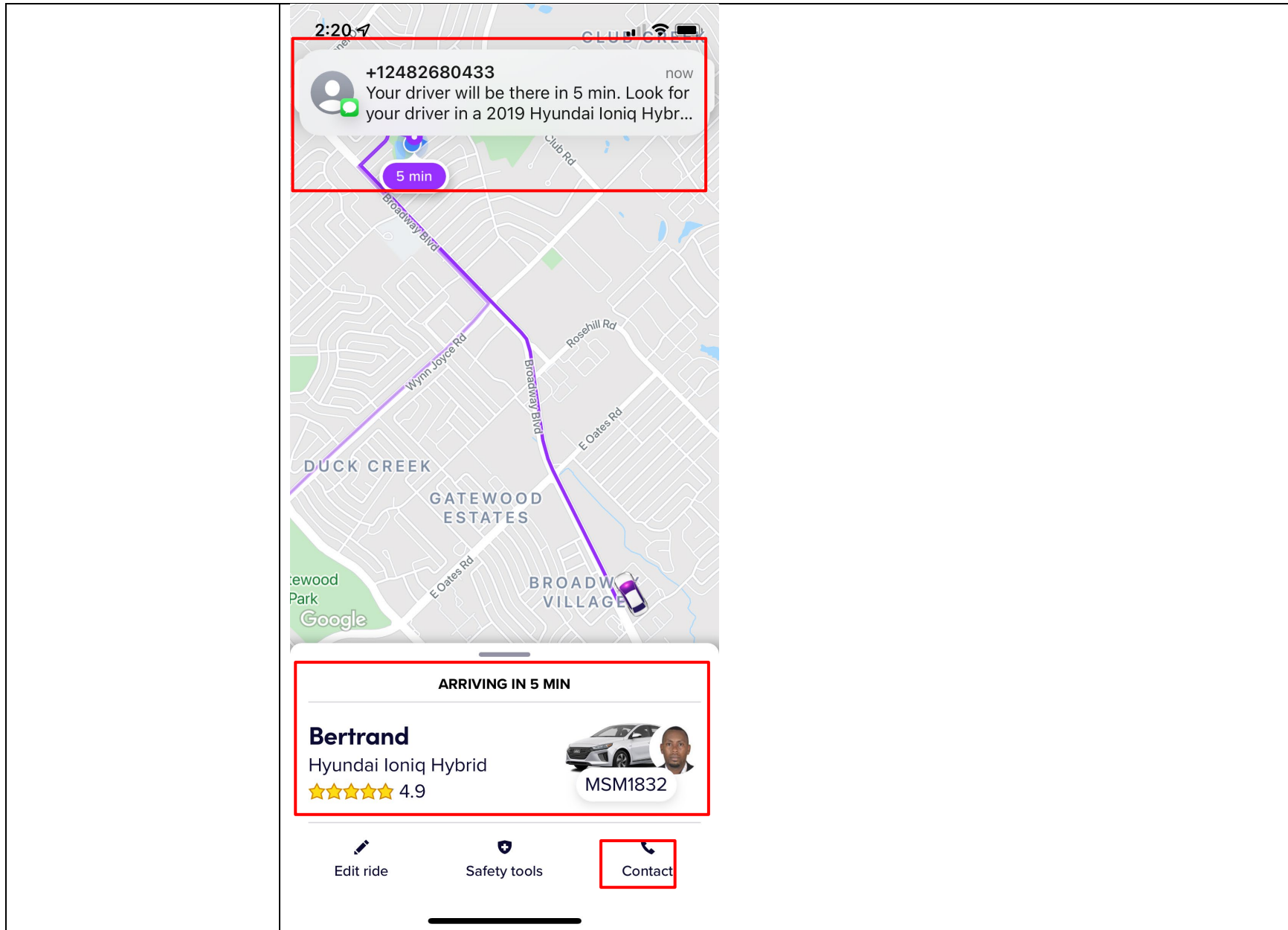

Attachment B for US Patent No. 7,630,724 Against Lyft Accused Products

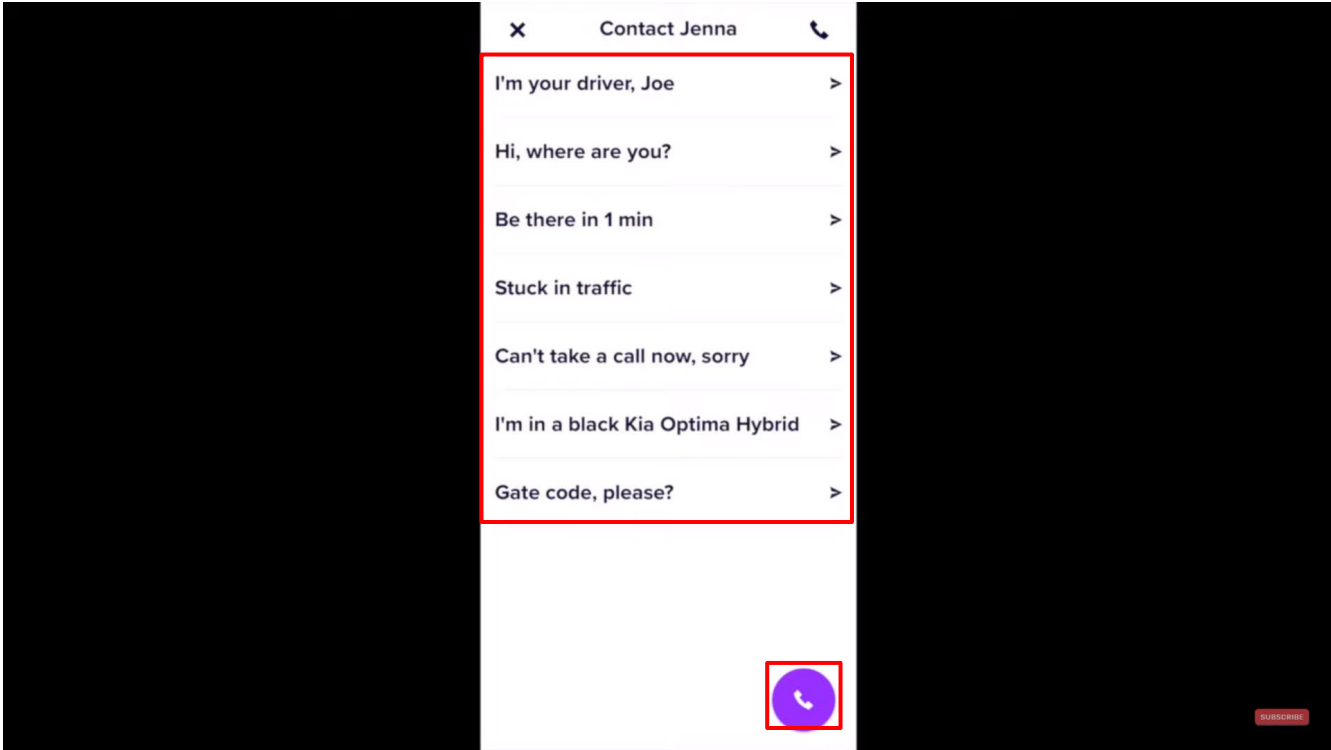
Claim – 7,630,724	Accused Products
	 <p>The screenshot shows a mobile application interface for a Lyft driver. At the top, there is a header with a close button (X), the name 'Contact Jenna', and a phone icon. Below this is a list of seven menu items, each with a right-pointing chevron: 'I'm your driver, Joe', 'Hi, where are you?', 'Be there in 1 min', 'Stuck in traffic', 'Can't take a call now, sorry', 'I'm in a black Kia Optima Hybrid', and 'Gate code, please?'. A red rectangular box highlights this entire list. At the bottom right of the screen, there is a purple circular button with a white phone icon, also highlighted by a red rectangular box. A 'SUBSCRIBE' button is visible in the bottom right corner of the video frame. Below the screenshot, the URL https://www.youtube.com/watch?v=jVUy9poJDng is provided, followed by the text 'at 11:21'.</p> <p>https://www.youtube.com/watch?v=jVUy9poJDng at 11:21</p>

Attachment B for US Patent No. 7,630,724 Against Lyft Accused Products

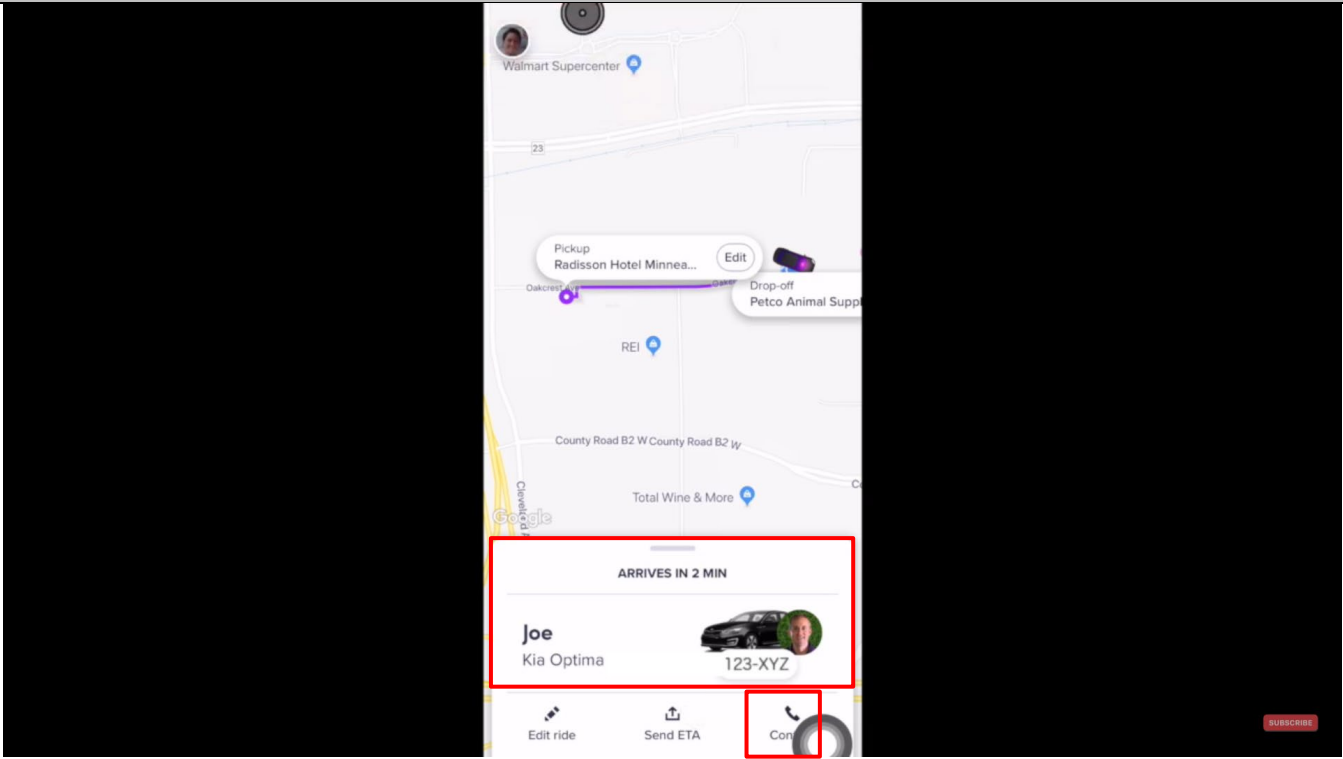
Claim – 7,630,724	Accused Products
	 <p>https://www.youtube.com/watch?v=j0RDMLcmOgU at 5:07</p>

Attachment B for US Patent No. 7,630,724 Against Lyft Accused Products

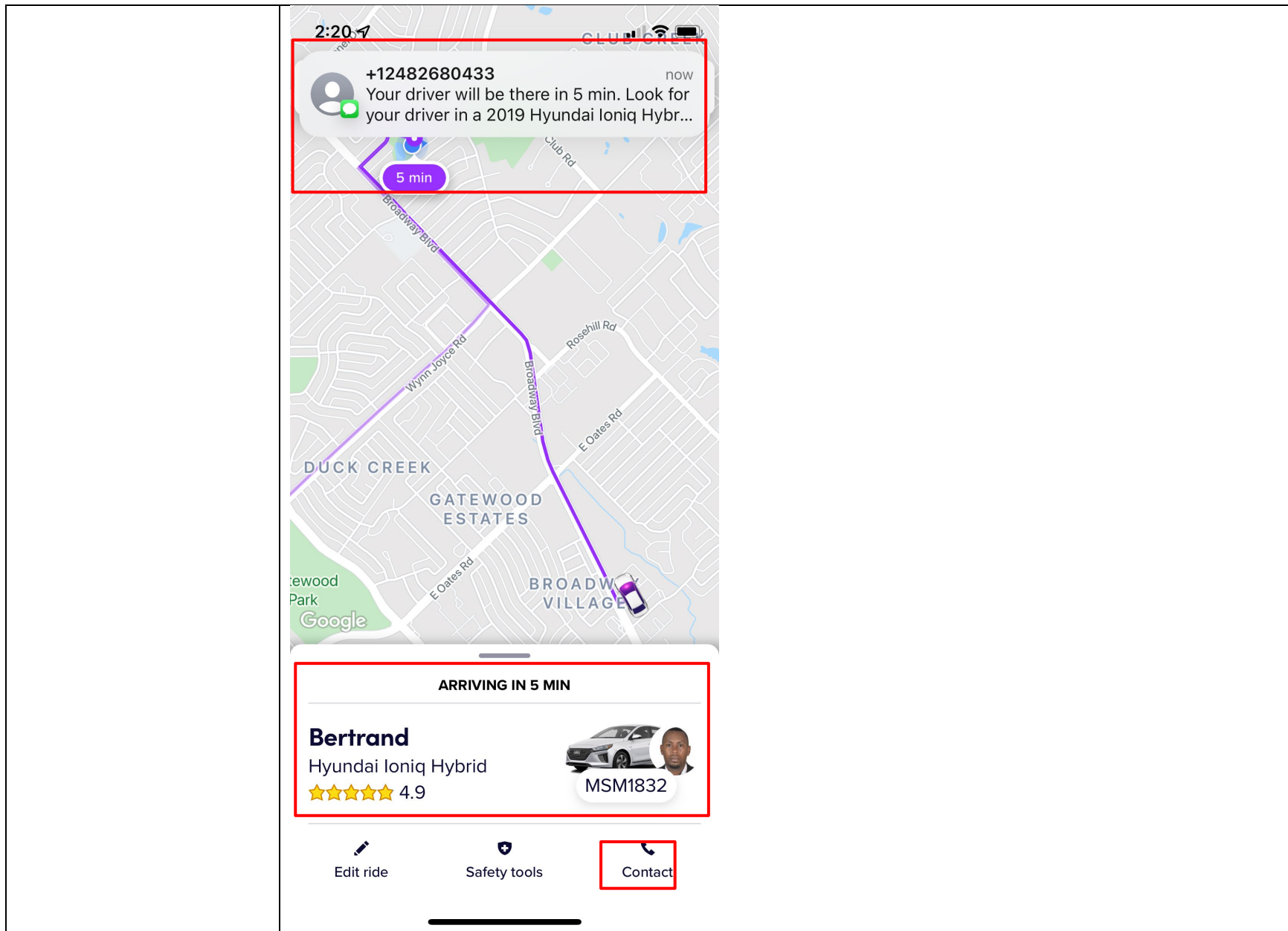

Attachment B for US Patent No. 7,630,724 Against Lyft Accused Products

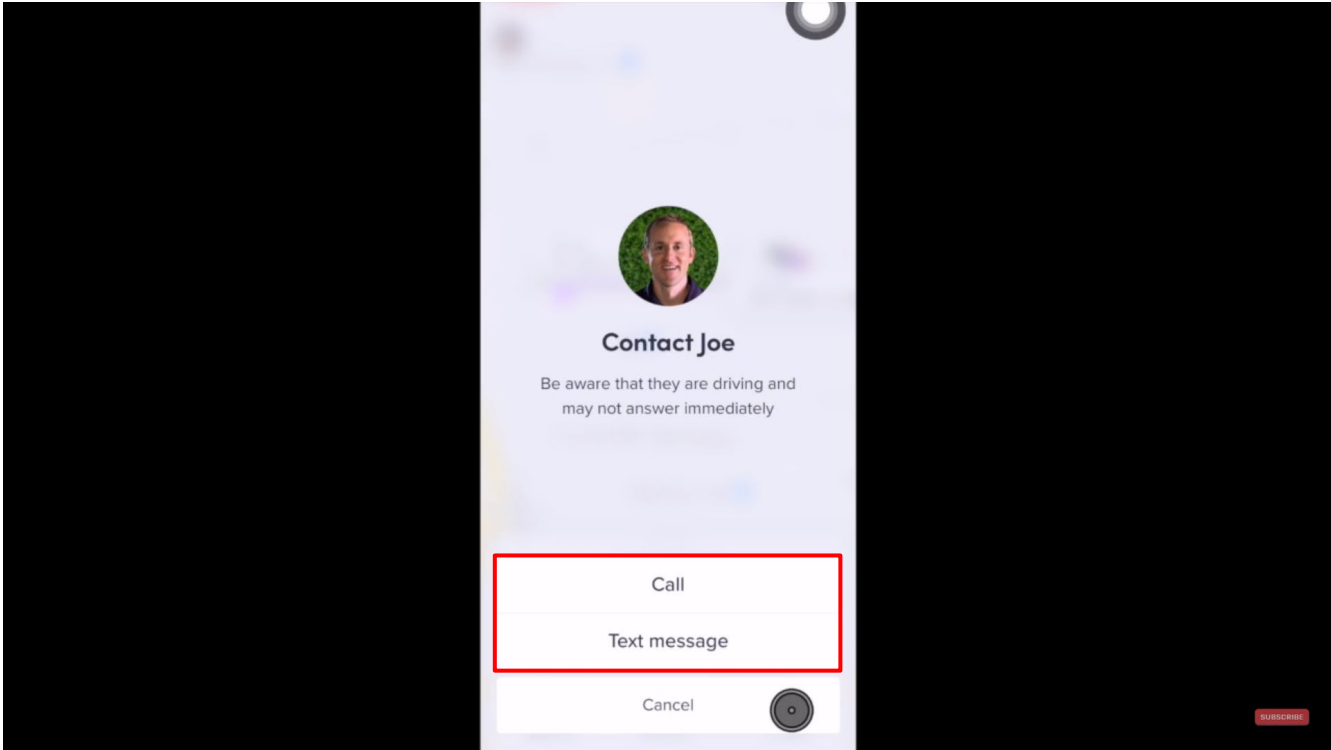
Claim – 7,630,724	Accused Products
	 <p>The screenshot shows a mobile application interface for a contact named 'Contact Joe'. The contact's name is displayed in bold black text. Below the name, a warning message reads: 'Be aware that they are driving and may not answer immediately'. At the bottom of the contact card, there are three buttons: 'Call', 'Text message', and 'Cancel'. The 'Call' and 'Text message' buttons are enclosed in a red rectangular box. A 'SUBSCRIBE' button is visible in the bottom right corner of the app interface.</p> <p>https://www.youtube.com/watch?v=j0RDMLcmOgU at 5:32</p>

Attachment B for US Patent No. 7,630,724 Against Lyft Accused Products

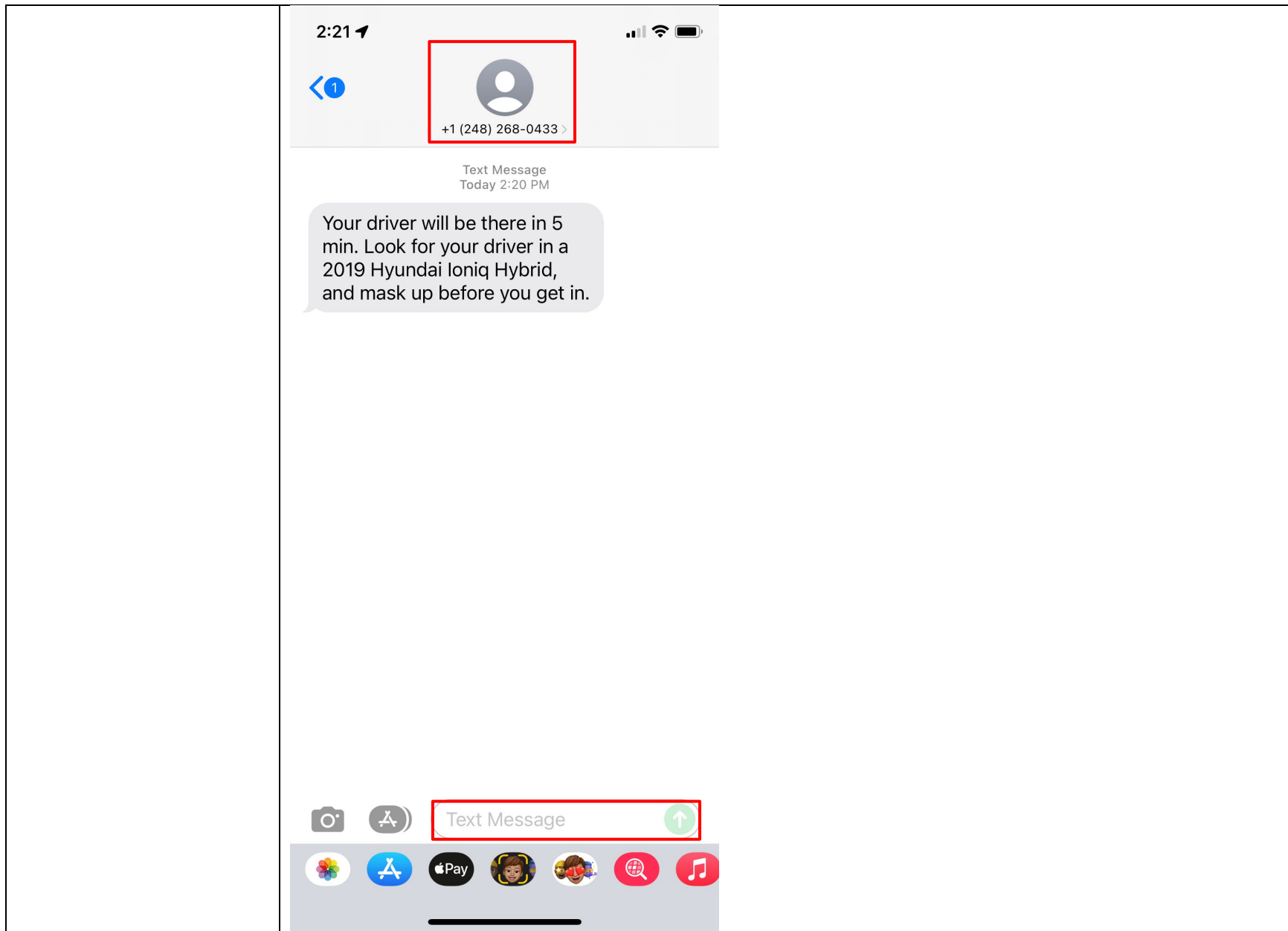

Attachment B for US Patent No. 7,630,724 Against Lyft Accused Products

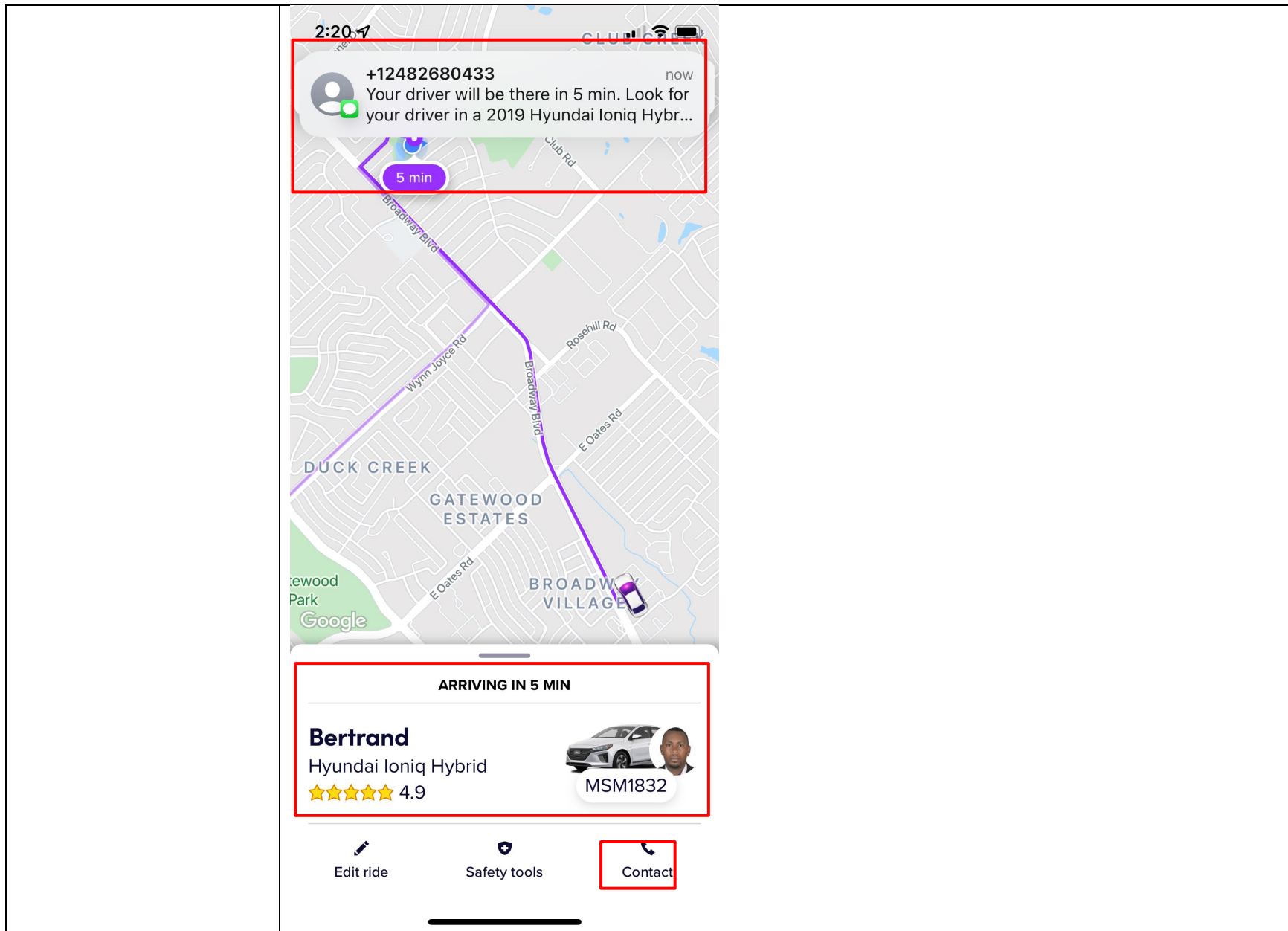

Attachment B for US Patent No. 7,630,724 Against Lyft Accused Products

Claim – 7,630,724	Accused Products
	<p>See claim 9[D] above.</p> <p>Further, to the extent this element is performed at least in part by Lyft's software source code, AGIS reserves the right to supplement these contentions pursuant to production of such source code by Lyft and to the extent Lyft requires additional information in accordance with P.R. 3-1 and for any other reasons.</p>
<p>16[D]. generating at the server networks enabling anonymous voice and data communications so that neither the originator of the phone call or data transmission nor the receiver of the phone call or data transmission need to know the other's phone number, name or other identifier other than a symbol location on a map.</p>	<p>The Lyft Accused Products perform a computer implemented method as set forth below. Lyft further infringes directly and/or indirectly by performing, inducing others to perform, and/or contributing to the performance of: generating at the server networks enabling anonymous voice and data communications so that neither the originator of the phone call or data transmission nor the receiver of the phone call or data transmission need to know the other's phone number, name or other identifier other than a symbol location on a map.</p> <p>Lyft meets this limitation because the Lyft server(s) is an intermediary between riders/drivers using their respective Lyft apps for communication of data. Communications between riders/drivers do not require knowledge of the drivers/riders' identity or phone number. For example, Lyft hides the personal phone numbers of the driver as well as the passenger when a call is placed by either the driver or passenger. Therefore, Lyft's servers generate an anonymous voice and data communication where both participants do not see their phone numbers.</p> <p>See claim 9[D] above.</p> <p>Further, to the extent this element is performed at least in part by Lyft's software source code, AGIS reserves the right to supplement these contentions pursuant to production of such source code by Lyft and to the extent Lyft requires additional information in accordance with P.R. 3-1 and for any other reasons.</p>

Attachment C for US Patent No. 10,299,100 Against Lyft Accused Products

Based on information presently available,¹ Defendant AGIS Software Development LLC (“AGIS Software”) contends that Plaintiff Lyft Inc. (“Lyft” or “Plaintiff”) infringes claims 1-31 (the “Asserted Claims”) of U.S. Patent No. 10,299,100 (the “’100 Patent”) through the Accused Products which are manufactured, sold, offered for sale, and/or used by Lyft.

The Accused Products comprise the Lyft and Lyft Driver applications, servers, and services manufactured, used, or sold by Lyft, Inc. during and after 2016. AGIS Software reserves the right to seek leave of court to amend this list of Accused Products after the filing of an amended complaint or as discovery progresses.

Lyft directly infringes each of the Asserted Claims by making, using, importing, testing, distributing, selling, and/or offering for sale the Accused Products in violation of 35 U.S.C. § 271(a).

Lyft indirectly infringes the Asserted Claims in violation of 35 U.S.C. § 271(b) by inducing third parties, including its users and/or customers, to directly infringe through their operation and use of the Accused Products. Lyft has knowingly and intentionally induced this direct infringement by, *inter alia*, (i) selling, importing, or otherwise providing the Accused Products to third parties with the intent that the Accused Products will be operated and used in a manner that practices the Asserted Claims; and (ii) marketing and advertising the Accused Products. Lyft’s marketing and promotional materials for the Accused Products are found, for example, on Lyft’s website, and in App stores of operating systems for which the Accused Products are made available. For example, Lyft’s website offers customers instructions and/or manuals for the Accused Products that instruct customers to, among other things, use the accused services in the Accused Products. Lyft’s website also offers support to customers, including instruction to, among other things, use the Accused Products share location information with a group of users. Lyft knows, or should have known, that its actions will result in infringement of the Asserted Claims, or subjectively believes that there is a high probability that its actions will result in infringement of the Asserted Claims but has taken deliberate actions to avoid learning these facts.

Lyft also contributorily infringes each of the Asserted Claims in violation of 35 U.S.C. § 271(c) by selling, importing, offering for sale, and otherwise providing the Accused Products, which when used directly infringe the Asserted Claims. The Accused Products constitute a material part of the Asserted Claims.

¹ There is no operative complaint asserting non-infringement of any patent claim in this action at this time. AGIS Software reserves the right to update its contentions upon receipt of any future amended complaint.

Attachment C for US Patent No. 10,299,100 Against Lyft Accused Products

The following chart identifies specifically where each limitation of each Asserted Claim is found within the Accused Products, and in particular, the corresponding elements that meet the limitations in the Lyft and Lyft Driver applications, services, and services. On information and belief, each charted version of the Lyft and Lyft Driver Apps are representative of all versions of the Accused Products, including all variants of the Accused Products made, sold, offered for sale, or used on any version of the Android and iOS operating systems.

AGIS Software does not concede that any claims of the '100 Patent that are not listed below are not infringed by the identified Accused Products. Moreover, the citations to certain documents and other information below are intended to be exemplary only and in no way foreclose AGIS from citing or relying on additional documents, information, source code, and/or testimony at a later time. These contentions are preliminary in nature and an analysis of Lyft's products, internal documentation, source code, and/or testimony from relevant witnesses may more fully and accurately describe the infringing features of its accused products. Accordingly, AGIS Software reserves the right to seek leave of court to supplement, correct, modify, and/or amend these contentions once such additional information is made available to AGIS Software. Furthermore, AGIS Software reserves the right to seek leave of court to supplement, correct, modify, and/or amend these contentions as discovery in this case progresses; in view of the Court's claim construction order(s);² in view of any positions taken by Lyft, including but not limited to positions on claim construction, invalidity, and/or non-infringement; and in connection with the preparation and exchange of expert reports.

The contents of each claim cell below on which another claim cell depends are expressly incorporated by reference in that dependent cell, as if set forth in their entirety therein.

² The construction of claim terms herein is consistent with the constructions in *AGIS Software Dev. LLC v. Huawei Device USA, Inc.*, No. 2:17-cv-00513-JRG, Dkt. 205 (E.D. Tex. Oct. 10, 2018); *AGIS Software Dev. LLC v. Google LLC*, No. 2:19-cv-00361-JRG, Dkt. 147 (E.D. Tex. Dec. 8, 2020); *AGIS Software Dev. LLC v. T-Mobile USA, Inc., et al.*, No. 2:21-cv-00072-JRG, Dkt. 213 (E.D. Tex. Nov. 10, 2021). AGIS Software reserves the right to update its constructions and contentions in view of this Court's claim construction order.

RESTRICTED CONFIDENTIAL SOURCE CODE

Attachment C for US Patent No. 10,299,100 Against Lyft Accused Products

Claim 10,299,100	Lyft's Accused Products
<p>1[P]. A method performed by a mobile device having a display and one or more processors, the method comprising:</p>	<p>The Lyft Accused Products perform a computer implemented method as set forth below. Lyft further infringes directly and/or indirectly by performing, inducing others to perform, and/or contributing to the performance of: a method performed by a mobile device having a display and one or more processors.</p> <p>For example, Lyft provides Lyft Rider app for passengers and Lyft Driver app for drivers. The Lyft apps for riders and drivers, in conjunction with Lyft's servers and services, provide users with interactive methods to request, view, and track locations of passengers/riders using real-time maps and communications. The Lyft server(s) and their services communicate with the Lyft apps for riders and drivers. The Lyft server(s) and their services host information related to and instructions for processing user/device/vehicle accounts, location data, and map data. The claimed methods are distributed by Lyft in the Lyft apps. The claimed methods are used/tested by Lyft using the Lyft apps. The claimed methods are downloaded and installed by Lyft's customers (riders) and personnel (drivers, personnel) at the direction/encouragement of Lyft and used by Lyft's customers and Lyft's personnel.</p> <h2 data-bbox="468 878 957 951">Lyft Driver app</h2> <div data-bbox="464 992 1696 1073" style="border: 1px solid red; padding: 5px;"> <p>We've separated the passenger and driver experiences into two separate mobile apps — one exclusively for passengers (named the Lyft app) and the other exclusively for drivers (named the Lyft Driver app).</p> </div> <p>The Lyft Driver app will eventually be standard for all drivers and required for driving. At this time, drivers can keep using the Lyft app to give rides. Don't worry! While we have some planned improvements to the Lyft Driver app, we've kept its features the same.</p> <p>https://help.lyft.com/hc/en-ca/articles/115013079208-Lyft-Driver-app</p>

RESTRICTED CONFIDENTIAL SOURCE CODE

Attachment C for US Patent No. 10,299,100 Against Lyft Accused Products

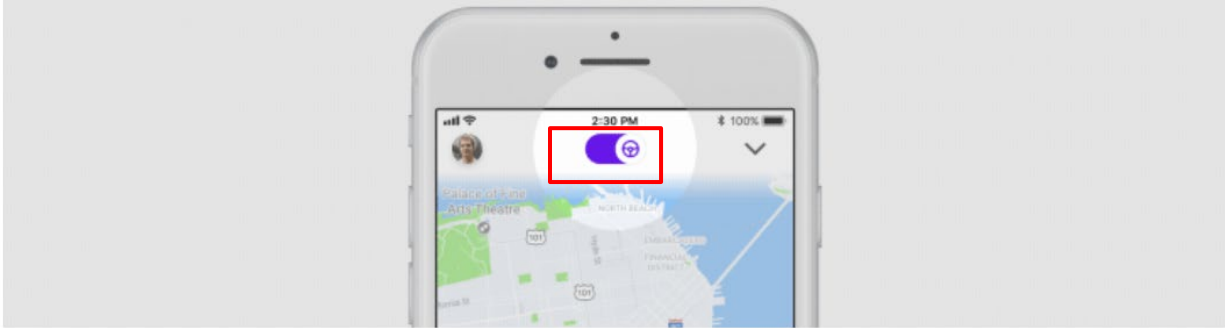
Claim 10,299,100	- Lyft's Accused Products
	<p data-bbox="468 331 768 380">What is Lyft?</p> <p data-bbox="468 433 1535 500">Lyft is a platform that connects drivers with individuals and organizations that need rides.</p> <p data-bbox="457 529 932 561">https://www.lyft.com/drive-with-lyft</p>  <p data-bbox="457 997 583 1024">Go online</p> <p data-bbox="457 1062 1654 1167">Open your Lyft Driver app and tap the steering wheel icon. Lyft will now find the closest passenger to your location requesting a ride. Turn on some music and get comfortable: that first ride request may come quickly or may take a while, depending on the number of current passenger requests.</p> <p data-bbox="457 1175 1115 1208">https://www.lyft.com/hub/posts/how-to-give-a-ride</p>

RESTRICTED CONFIDENTIAL SOURCE CODE

Attachment C for US Patent No. 10,299,100 Against Lyft Accused Products

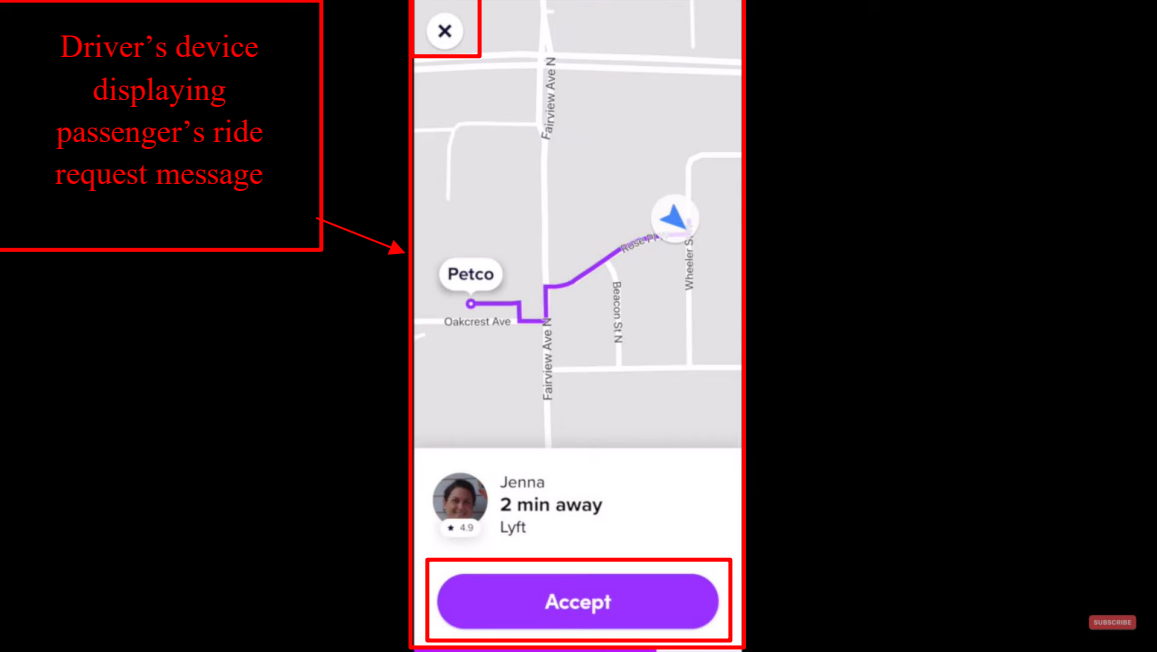
Claim 10,299,100	- Lyft's Accused Products
	<p data-bbox="457 318 777 568">Driver's device displaying passenger's ride request message</p>  <p data-bbox="457 971 1375 1003">https://www.youtube.com/watch?v=jVUy9poJDng at 10:24, Annotated</p>

RESTRICTED CONFIDENTIAL SOURCE CODE

Attachment C for US Patent No. 10,299,100 Against Lyft Accused Products

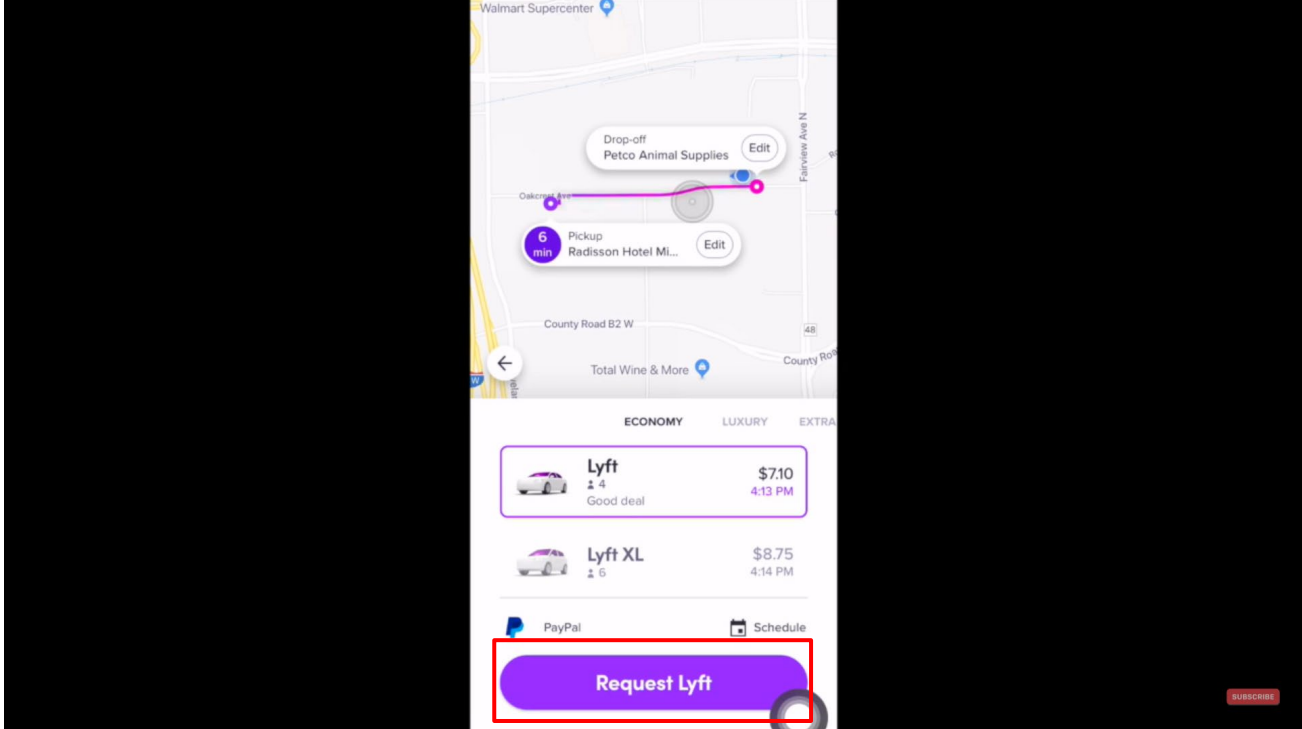
Claim 10,299,100	- Lyft's Accused Products
	 <p>https://www.youtube.com/watch?v=j0RDMLcmOgU at 4:01</p>

RESTRICTED CONFIDENTIAL SOURCE CODE

Attachment C for US Patent No. 10,299,100 Against Lyft Accused Products

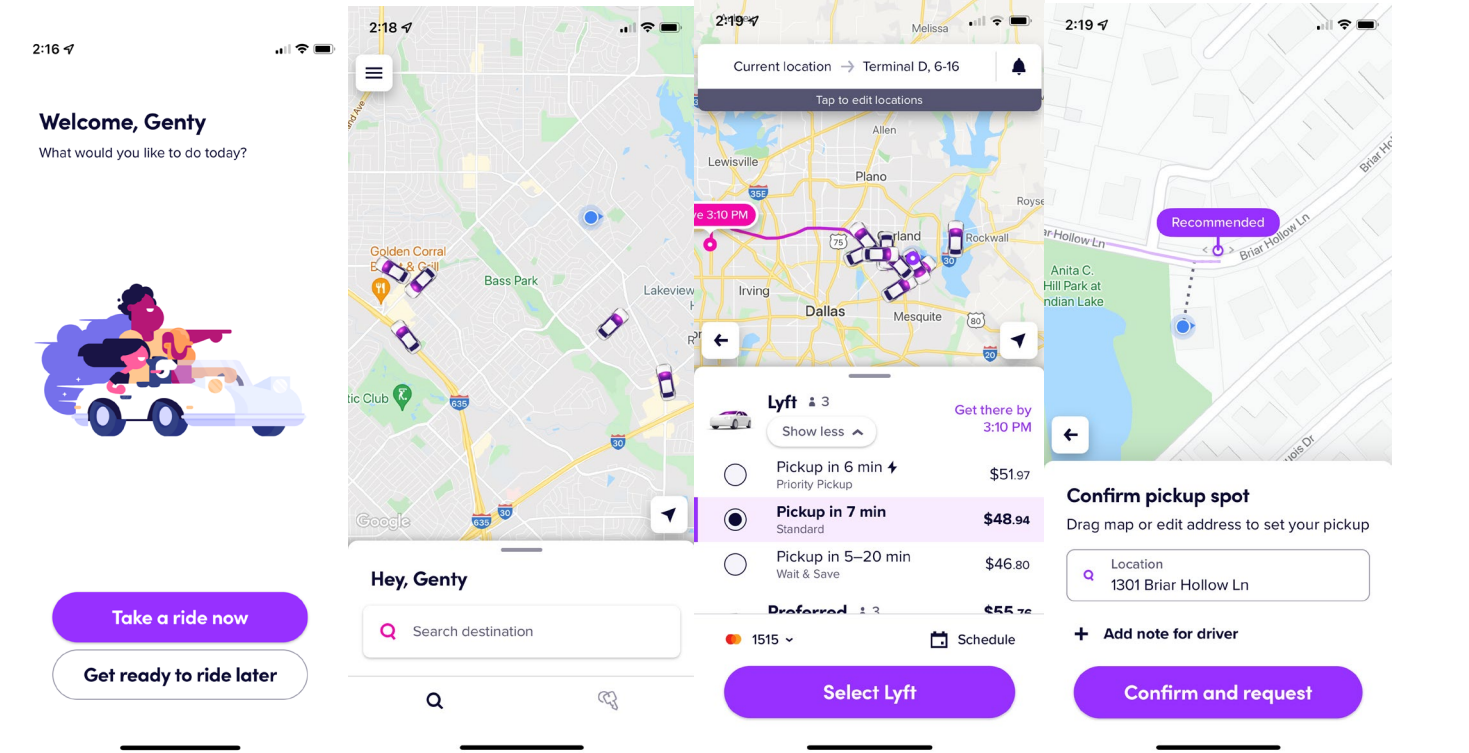
Claim 10,299,100	- Lyft's Accused Products
	 <p>2:16</p> <p>Welcome, Genty What would you like to do today?</p> <p>Take a ride now</p> <p>Get ready to ride later</p> <p>2:18</p> <p>Current location → Terminal D, 6-16 Tap to edit locations</p> <p>Golden Corral Bass Park Lakeview Irving Dallas Mesquite Rockwall Plano Allen Lewisville</p> <p>Lyft 3 Show less</p> <p>Pickup in 6 min Priority Pickup \$51.97</p> <p>Pickup in 7 min Standard \$48.94</p> <p>Pickup in 5-20 min Wait & Save \$46.80</p> <p>Preferred 3 \$55.76</p> <p>1515 Schedule</p> <p>Hey, Genty</p> <p>Search destination</p> <p>2:19</p> <p>Recommended Briar Hollow Ln</p> <p>Confirm pickup spot Drag map or edit address to set your pickup</p> <p>Location 1301 Briar Hollow Ln</p> <p>Add note for driver</p> <p>Select Lyft</p> <p>Confirm and request</p>

RESTRICTED CONFIDENTIAL SOURCE CODE

Attachment C for US Patent No. 10,299,100 Against Lyft Accused Products

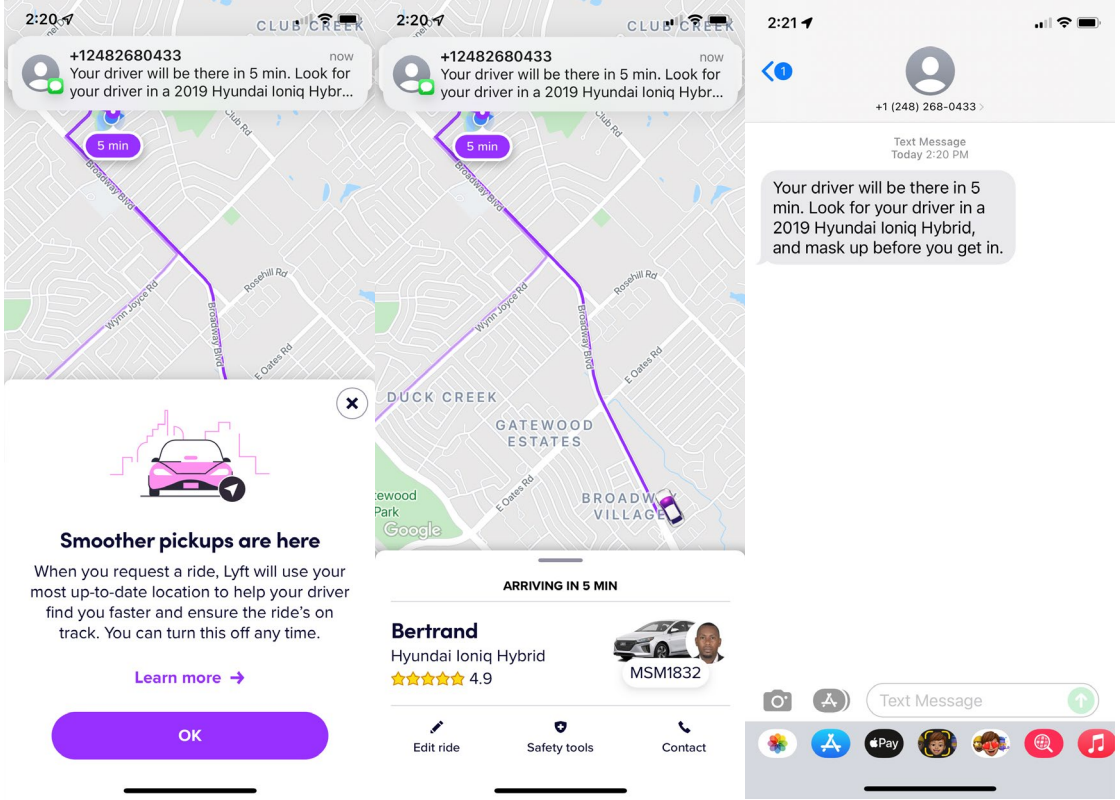
Claim 10,299,100	- Lyft's Accused Products
	 <p>Further, to the extent this element is performed at least in part by Lyft's software source code, AGIS reserves the right to supplement these contentions pursuant to production of such source code by Lyft and to the extent Lyft requires additional information in accordance with P.R. 3-1 and for any other reasons.</p>
1[A]. executing operations on the one or more processors of the	The Lyft Accused Products infringe directly and/or indirectly by performing, inducing others to perform, and/or contributing to the performance of: executing operations on the one or more processors of the mobile device.

RESTRICTED CONFIDENTIAL SOURCE CODE

Attachment C for US Patent No. 10,299,100 Against Lyft Accused Products

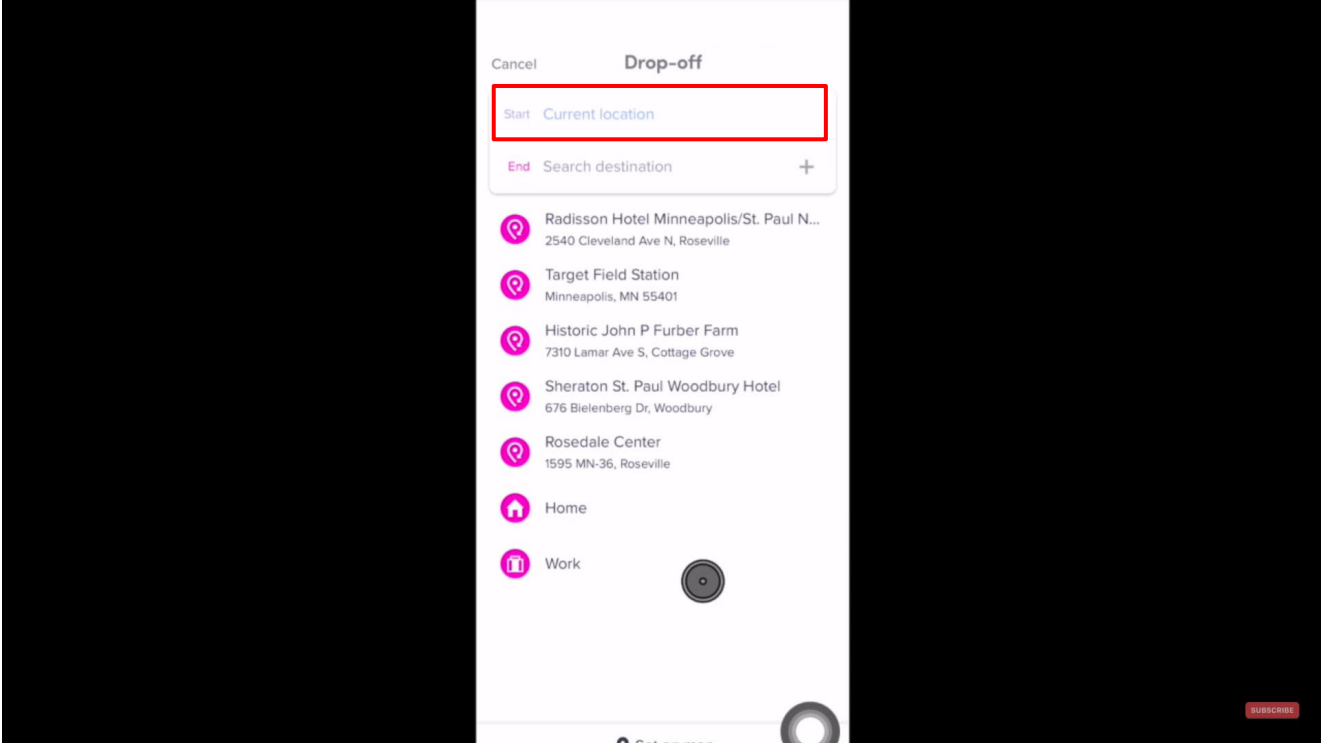
Claim 10,299,100	Lyft's Accused Products
<p>mobile device, the operations comprising:</p>	<p>Lyft's apps perform the limitations by executing operations on processors (either hardware or software). Lyft's apps perform the operations in conjunction with Lyft's servers, which receive passenger's request for a ride and communicates the request to the nearby drivers. The nearby drivers receive the request for a ride from the passengers which they accept or decline. The servers further facilitate the communication between the passenger and the allocated driver during a ride.</p>  <p>https://www.youtube.com/watch?v=j0RDMLcmOgU at 3:27</p>

RESTRICTED CONFIDENTIAL SOURCE CODE

Attachment C for US Patent No. 10,299,100 Against Lyft Accused Products

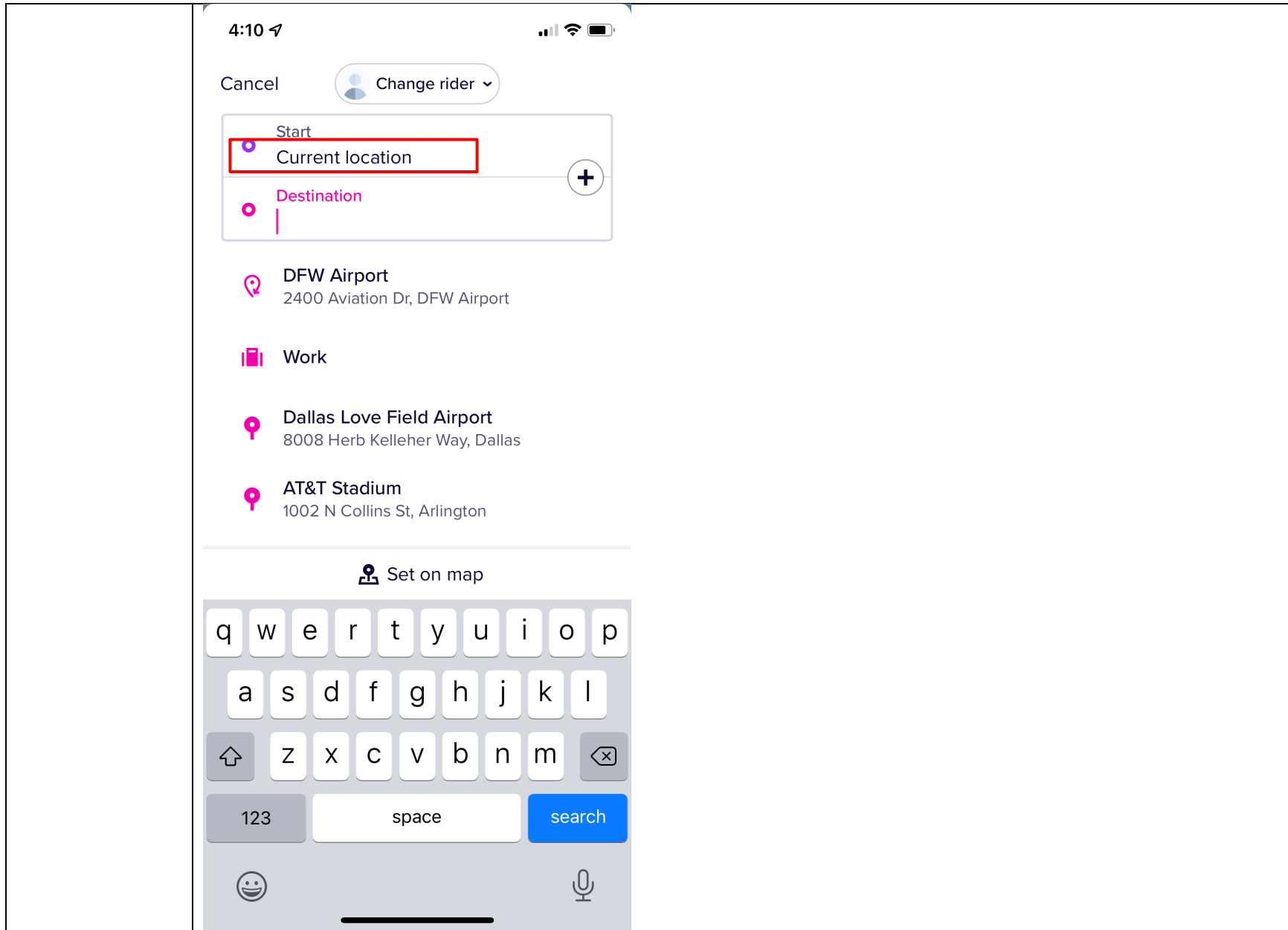

RESTRICTED CONFIDENTIAL SOURCE CODE

Attachment C for US Patent No. 10,299,100 Against Lyft Accused Products

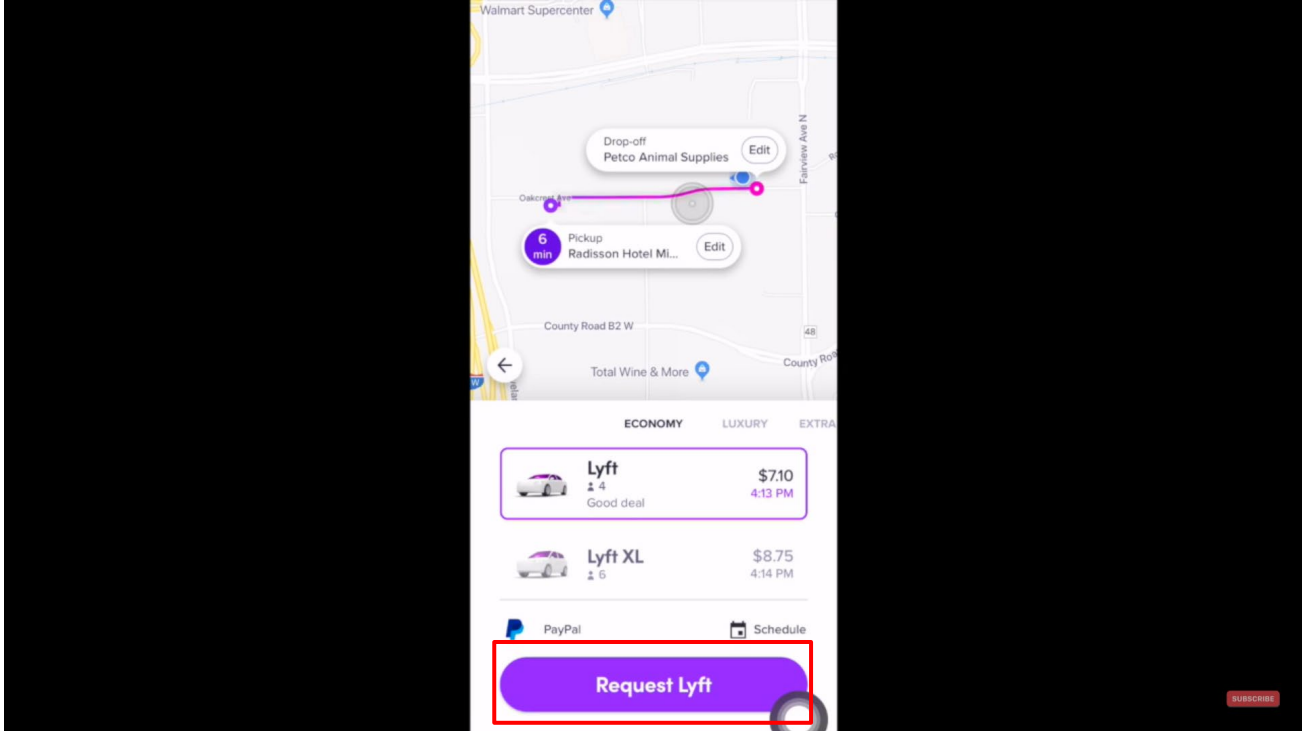
Claim 10,299,100	- Lyft's Accused Products
	 <p>https://www.youtube.com/watch?v=j0RDMLcmOgU at 4:01</p>

RESTRICTED CONFIDENTIAL SOURCE CODE

Attachment C for US Patent No. 10,299,100 Against Lyft Accused Products

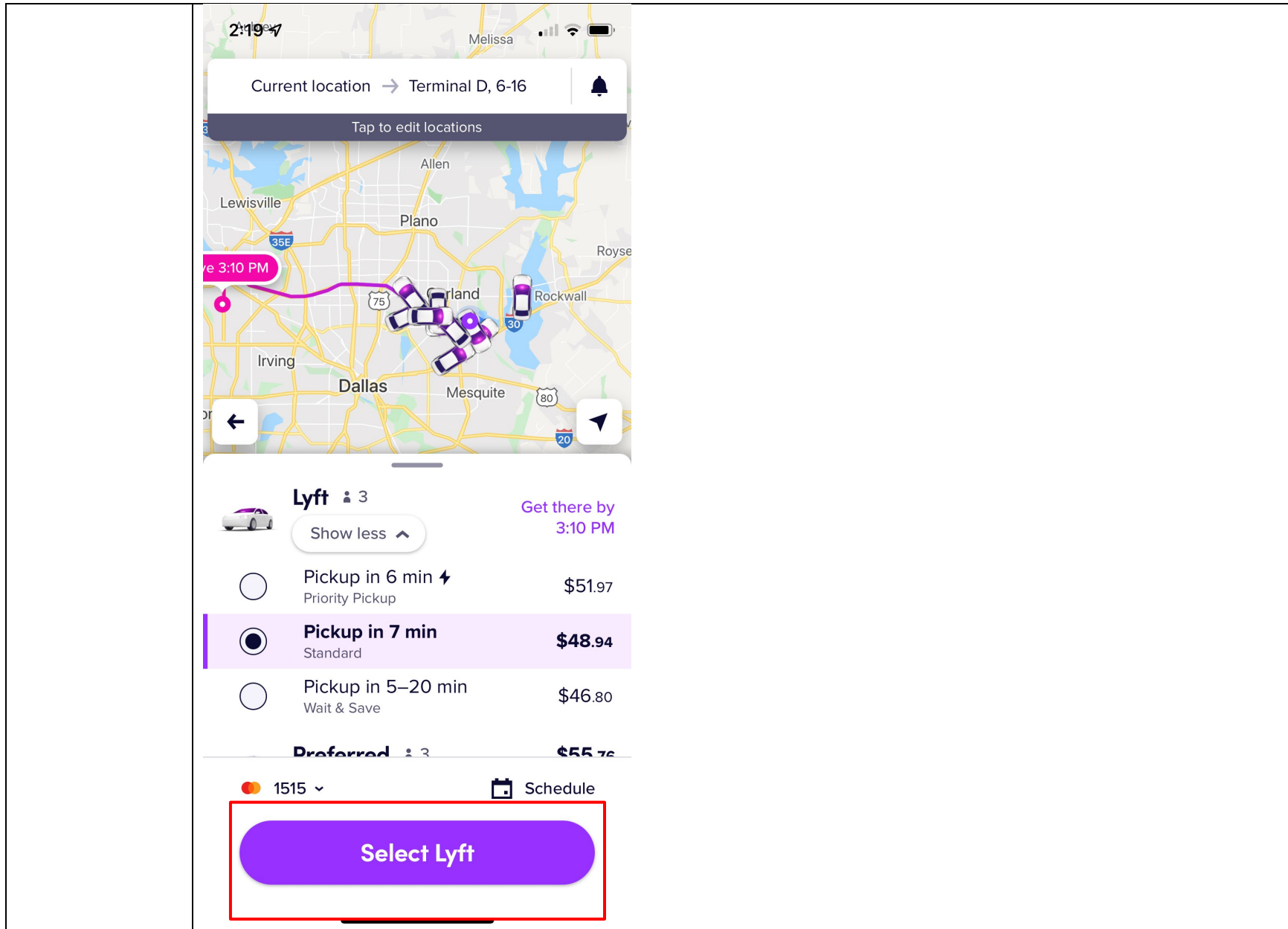

RESTRICTED CONFIDENTIAL SOURCE CODE

Attachment C for US Patent No. 10,299,100 Against Lyft Accused Products

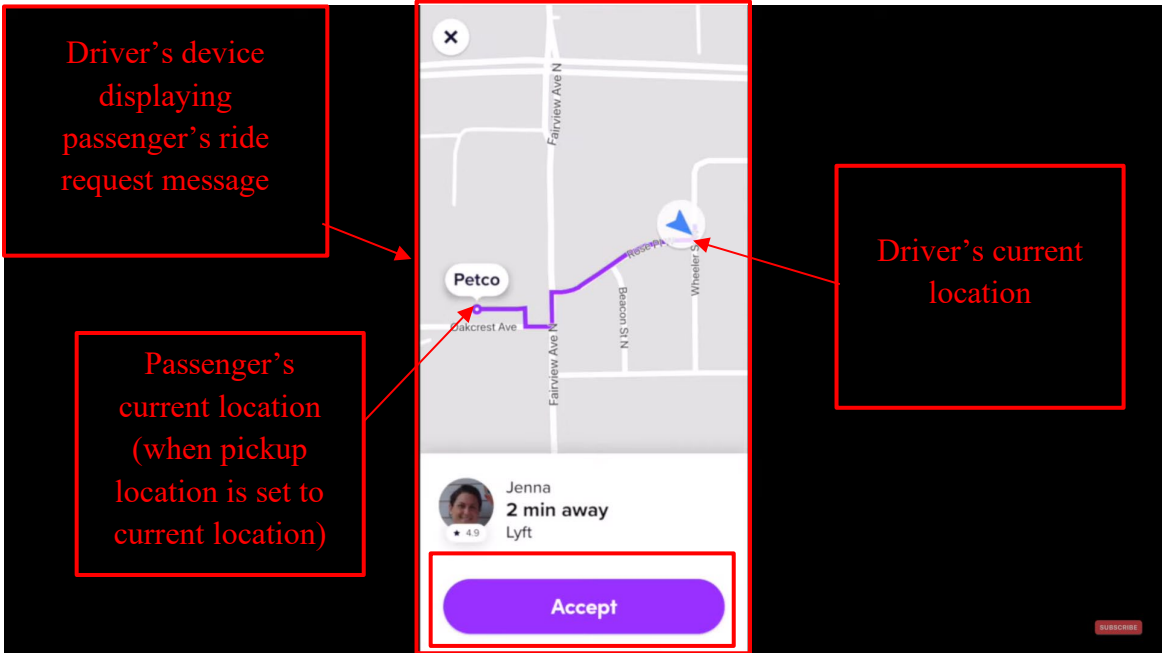
Claim 10,299,100	- Lyft's Accused Products
	 <p>Driver's device displaying passenger's ride request message</p> <p>Passenger's current location (when pickup location is set to current location)</p> <p>Driver's current location</p> <p>https://www.youtube.com/watch?v=jVUy9poJDng at 10:24, Annotated</p>

RESTRICTED CONFIDENTIAL SOURCE CODE

Attachment C for US Patent No. 10,299,100 Against Lyft Accused Products

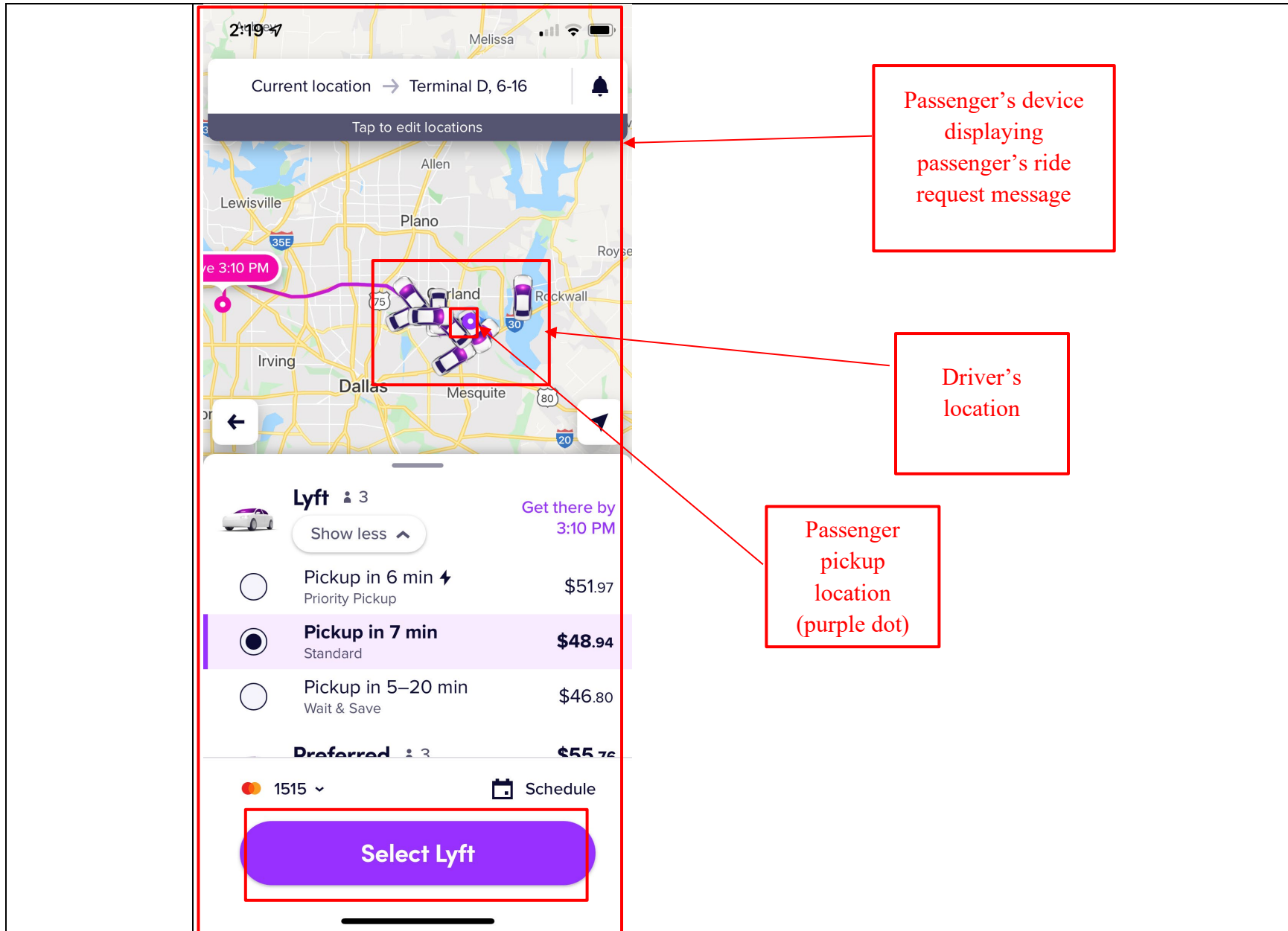

RESTRICTED CONFIDENTIAL SOURCE CODE

Attachment C for US Patent No. 10,299,100 Against Lyft Accused Products

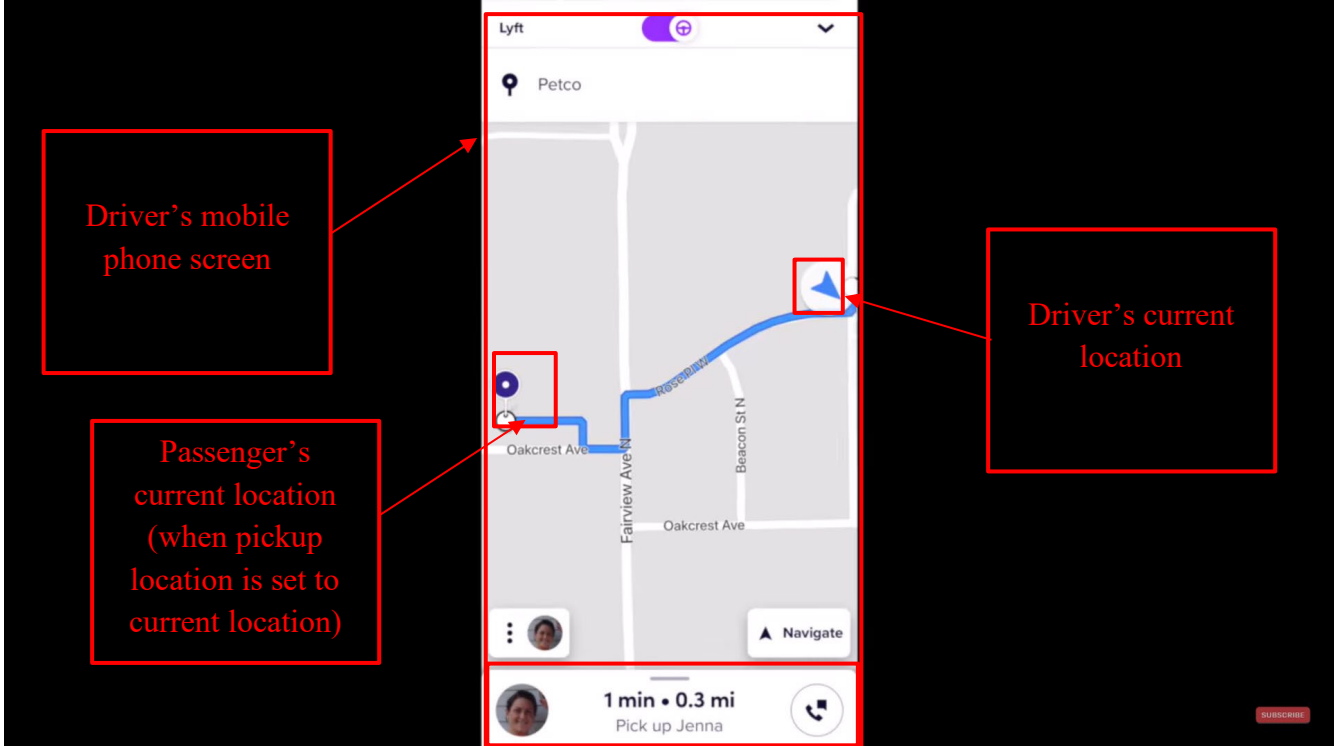
Claim 10,299,100	- Lyft's Accused Products
	 <p>The image is a screenshot of a Lyft mobile application interface. It features a map with a blue route line. A red box on the left side of the map highlights a blue location pin, with an arrow pointing to a text box that reads "Passenger's current location (when pickup location is set to current location)". Another red box on the right side of the map highlights a blue location pin with a white arrow, with an arrow pointing to a text box that reads "Driver's current location". A third red box on the left side of the map highlights the top portion of the app, with an arrow pointing to a text box that reads "Driver's mobile phone screen". At the bottom of the screen, there is a white bar with a driver's profile picture, the text "1 min • 0.3 mi Pick up Jenna", and a "SUBSCRIBE" button.</p> <p>https://www.youtube.com/watch?v=jVUy9poJDng at 10:46, Annotated</p>

RESTRICTED CONFIDENTIAL SOURCE CODE

Attachment C for US Patent No. 10,299,100 Against Lyft Accused Products

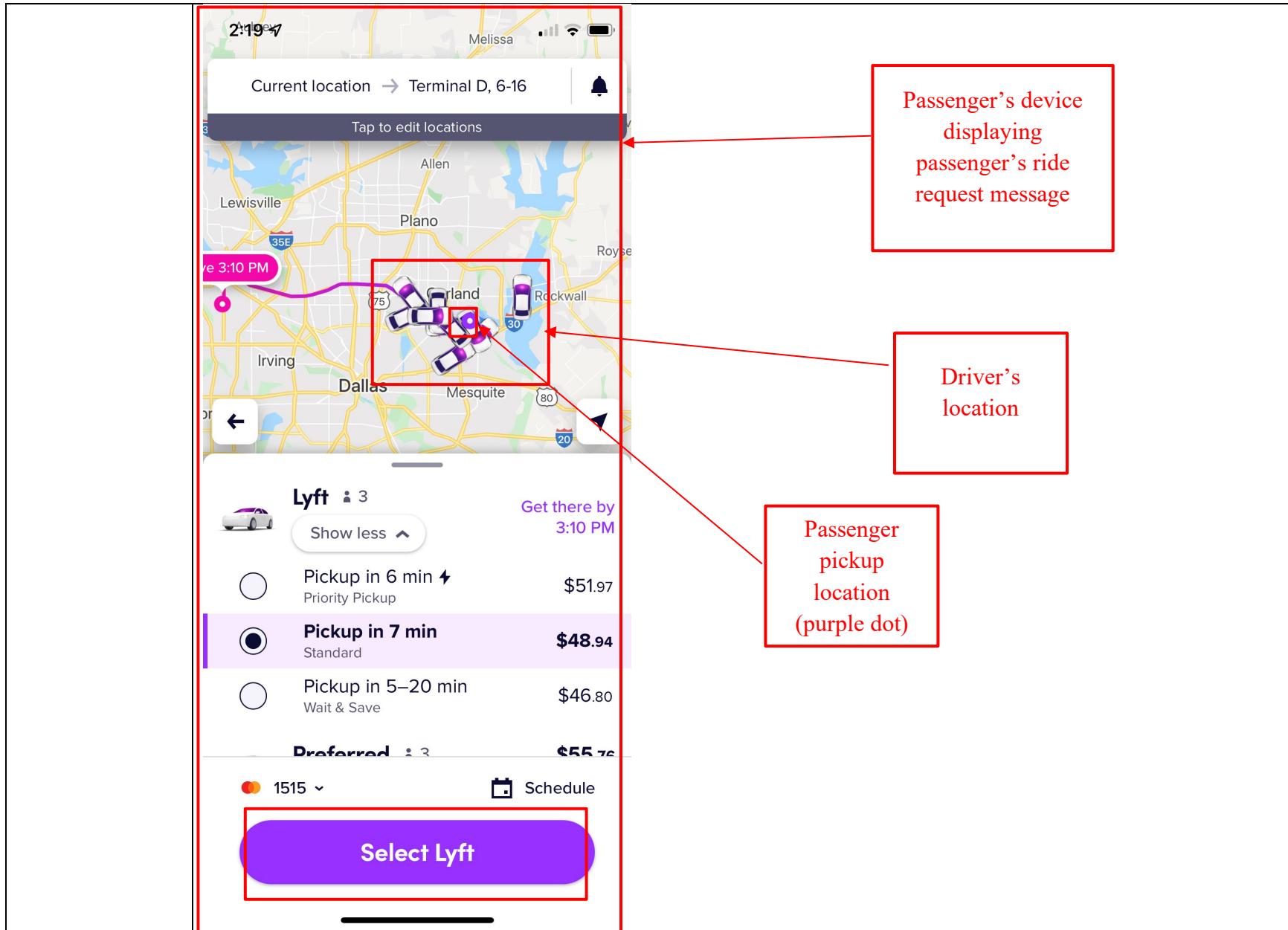

RESTRICTED CONFIDENTIAL SOURCE CODE

Attachment C for US Patent No. 10,299,100 Against Lyft Accused Products

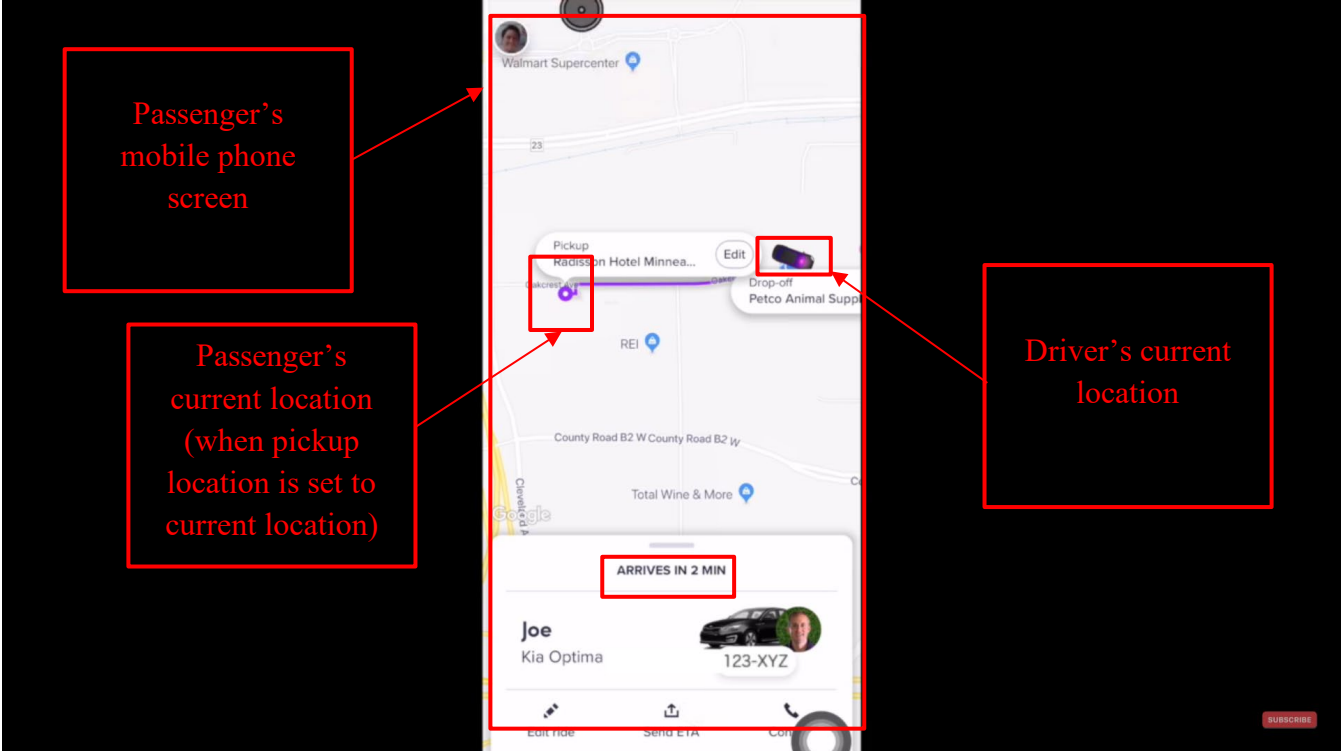
Claim 10,299,100	- Lyft's Accused Products
	 <p>The image is a screenshot of a Lyft mobile application interface, annotated with red boxes and arrows. The central part of the screen shows a map with a pickup location (Walmart Supercenter) and a drop-off location (Petco Animal Supply). A red box highlights the pickup location, with an arrow pointing to a text box that reads "Passenger's mobile phone screen". Another red box highlights the drop-off location, with an arrow pointing to a text box that reads "Passenger's current location (when pickup location is set to current location)". A third red box highlights the driver's current location on the map, with an arrow pointing to a text box that reads "Driver's current location". Below the map, the driver's name "Joe" and vehicle "Kia Optima" are displayed, along with the license plate "123-XYZ". A red box highlights the text "ARRIVES IN 2 MIN". At the bottom of the screen, there are buttons for "Edit Ride", "Send ETA", and "Call". A "SUBSCRIBE" button is visible in the bottom right corner.</p> <p>https://www.youtube.com/watch?v=j0RDMLcmOgU at 5:07, Annotated</p>

RESTRICTED CONFIDENTIAL SOURCE CODE

Attachment C for US Patent No. 10,299,100 Against Lyft Accused Products

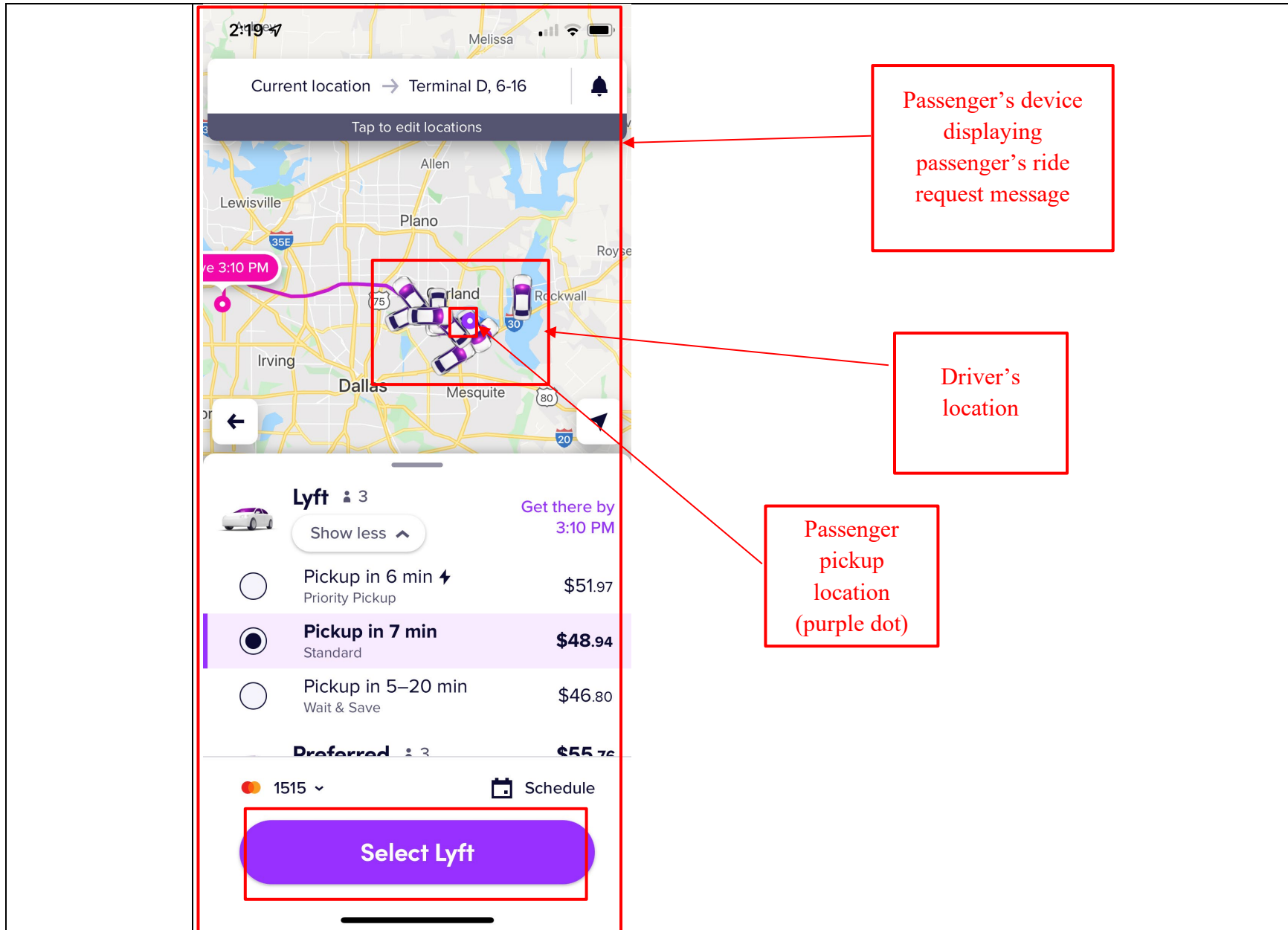

RESTRICTED CONFIDENTIAL SOURCE CODE

Attachment C for US Patent No. 10,299,100 Against Lyft Accused Products

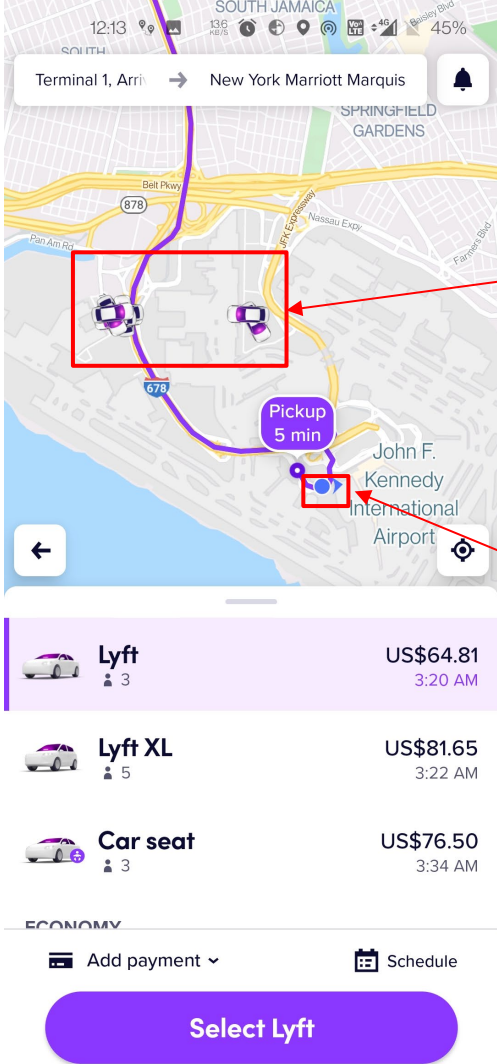
Claim 10,299,100	- Lyft's Accused Products												
	 <p>The screenshot displays the Lyft app interface. At the top, the map shows the route from Terminal 1, Arrivals to New York Marriott Marquis. A red box highlights two nearby driver icons on the map, with a red arrow pointing to a text box labeled "Nearby Drivers' location". Another red box highlights the passenger's location at John F. Kennedy International Airport, with a red arrow pointing to a text box labeled "Passenger's location". Below the map, a list of ride options is shown:</p> <table border="1"><thead><tr><th>Service</th><th>Price</th><th>Time</th></tr></thead><tbody><tr><td>Lyft (3 seats)</td><td>US\$64.81</td><td>3:20 AM</td></tr><tr><td>Lyft XL (5 seats)</td><td>US\$81.65</td><td>3:22 AM</td></tr><tr><td>Car seat (3 seats)</td><td>US\$76.50</td><td>3:34 AM</td></tr></tbody></table> <p>At the bottom, there are options for "Add payment" and "Schedule", and a large purple button labeled "Select Lyft".</p>	Service	Price	Time	Lyft (3 seats)	US\$64.81	3:20 AM	Lyft XL (5 seats)	US\$81.65	3:22 AM	Car seat (3 seats)	US\$76.50	3:34 AM
Service	Price	Time											
Lyft (3 seats)	US\$64.81	3:20 AM											
Lyft XL (5 seats)	US\$81.65	3:22 AM											
Car seat (3 seats)	US\$76.50	3:34 AM											

RESTRICTED CONFIDENTIAL SOURCE CODE

Attachment C for US Patent No. 10,299,100 Against Lyft Accused Products

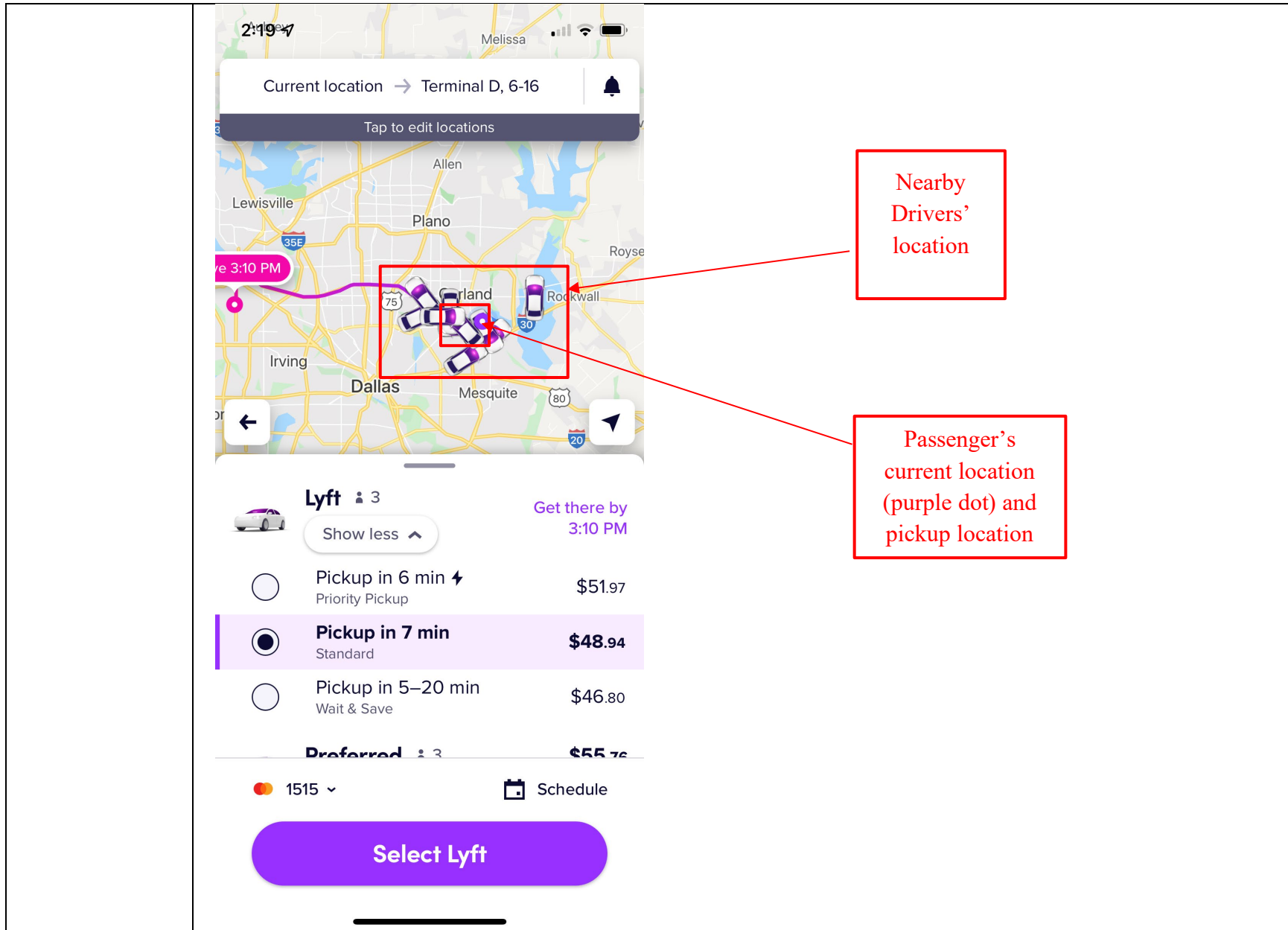

RESTRICTED CONFIDENTIAL SOURCE CODE

Attachment C for US Patent No. 10,299,100 Against Lyft Accused Products

Claim 10,299,100	- Lyft's Accused Products
<p>1[B]. associating the mobile device with an identifier, wherein the identifier corresponds to a network participant</p>	<p>The Lyft Accused Products infringe directly and/or indirectly by performing, inducing others to perform, and/or contributing to the performance of: associating the mobile device with an identifier, wherein the identifier corresponds to a network participant.</p> <p>The Lyft app, either alone or in conjunction with services provided Lyft's server and/or services, performs this limitation when it receives the account creation data from the Lyft app for riders. The Lyft app also performs this limitation, after account creation, during the sign-in or log-in process from the Lyft app for riders. The Lyft app also performs this limitation when the Lyft server requests status or other data via the Lyft app for riders. In all cases, the identifier is information associated with the identity of the rider, account, device, phone number, or Lyft app for riders. For example, a Lyft passenger sets up their account by providing details including but not limited to name, email address, and phone number. After verifying the details of the passenger, Lyft adds them to the Lyft platform or network of drivers and passengers. Thereafter, the passenger starts booking rides.</p>

RESTRICTED CONFIDENTIAL SOURCE CODE

Attachment C for US Patent No. 10,299,100 Against Lyft Accused Products

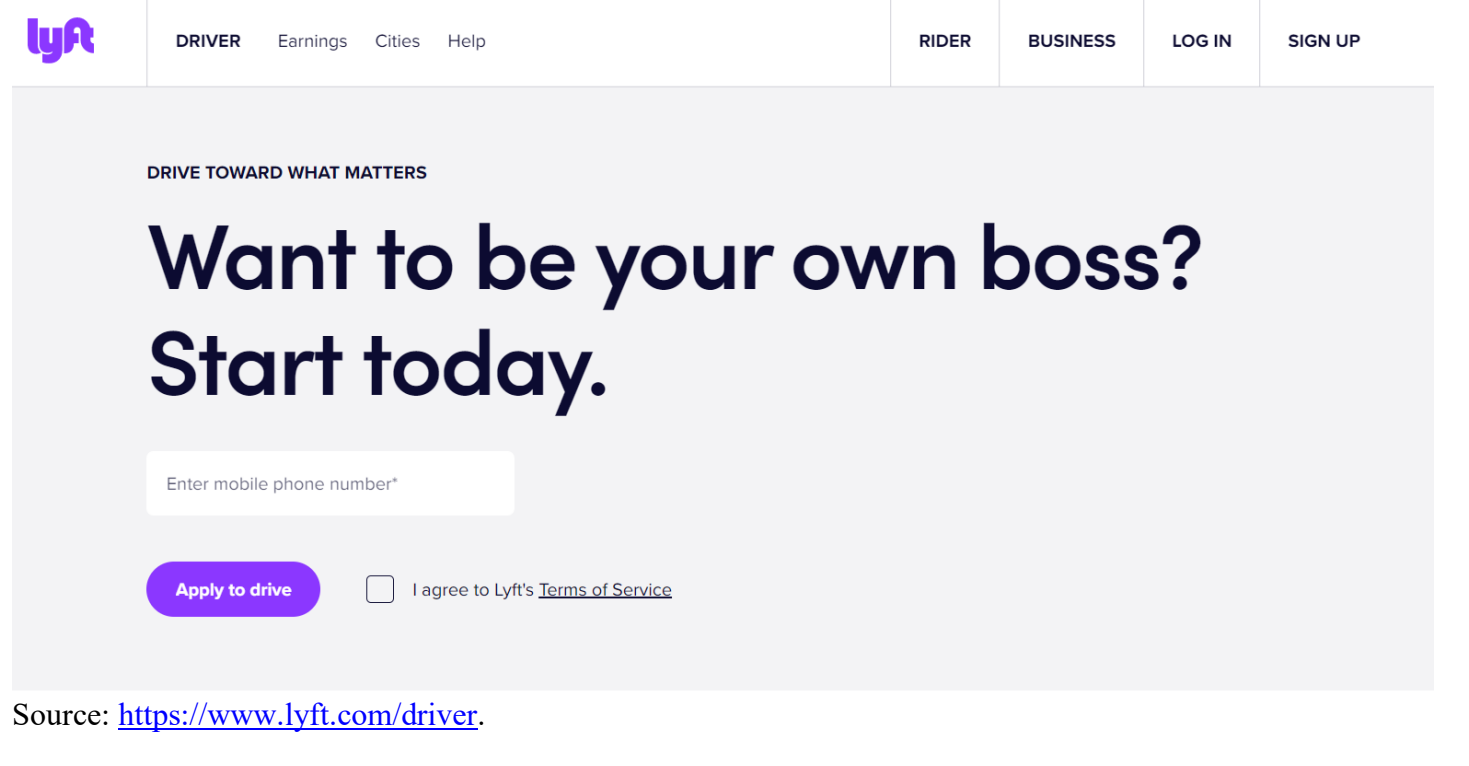
Claim 10,299,100	- Lyft's Accused Products
	 <p>The screenshot shows the Lyft website's driver sign-up page. At the top left is the Lyft logo. To its right are navigation links: DRIVER, Earnings, Cities, and Help. Further right are links for RIDER, BUSINESS, LOG IN, and SIGN UP. The main content area features the tagline "DRIVE TOWARD WHAT MATTERS" followed by the large headline "Want to be your own boss? Start today." Below this is a text input field labeled "Enter mobile phone number*". At the bottom of the form is a purple "Apply to drive" button and a checkbox labeled "I agree to Lyft's Terms of Service".</p> <p>Source: https://www.lyft.com/driver.</p>

RESTRICTED CONFIDENTIAL SOURCE CODE

Attachment C for US Patent No. 10,299,100 Against Lyft Accused Products

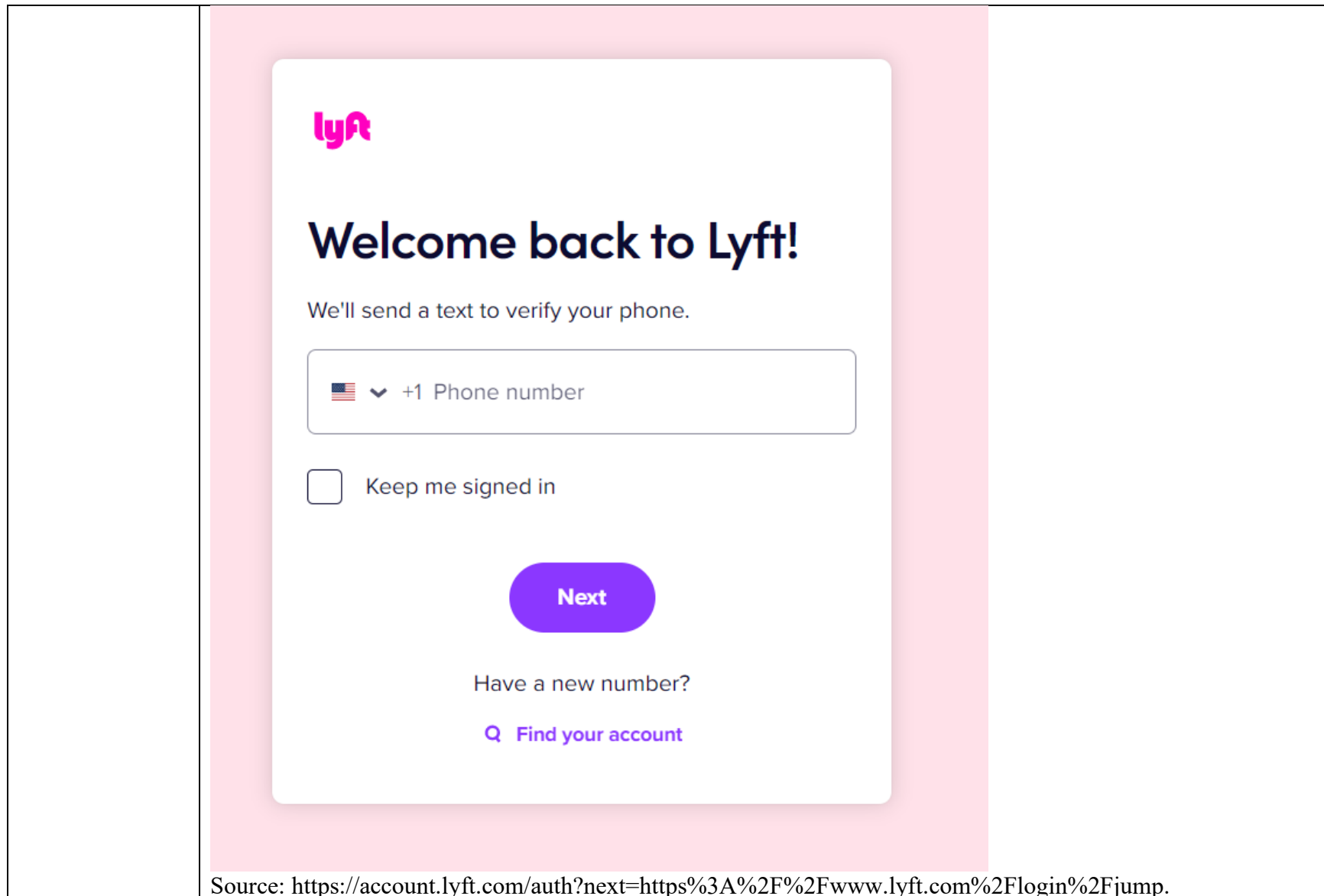

Source: <https://account.lyft.com/auth?next=https%3A%2F%2Fwww.lyft.com%2Flogin%2Fjump>.

RESTRICTED CONFIDENTIAL SOURCE CODE

Attachment C for US Patent No. 10,299,100 Against Lyft Accused Products

Claim 10,299,100	- Lyft's Accused Products
	<p>Before you begin, be sure you have the following:</p> <ul style="list-style-type: none"> • Your phone number • Your email address • A photo of yourself <p>Get started</p> <ol style="list-style-type: none"> 1. Type in your device's phone number 2. To verify your identity, we'll send a verification code via text to your phone number. We want to make sure you're human! 3. The text message should arrive immediately. If you don't see it after a bit, tap 'Resend code.' 4. Type in your name, email address, and take a selfie so your driver knows who to pick up 5. That's it! Once you've set up your account, you'll be able to request a ride (Learn How to request a ride). <p>https://help.lyft.com/hc/e/articles/115012926947-How-to-create-a-Lyft-account</p> <p>Further, to the extent this element is performed at least in part by Lyft's software source code, AGIS reserves the right to supplement these contentions pursuant to production of such source code by Lyft and to the extent Lyft requires additional information in accordance with P.R. 3-1 and for any other reasons.</p>
1[C]. determining a device location corresponding to	The Lyft Accused Products infringe directly and/or indirectly by performing, inducing others to perform, and/or contributing to the performance of: determining a device location corresponding to a geographical location of the mobile device.

RESTRICTED CONFIDENTIAL SOURCE CODE**Attachment C for US Patent No. 10,299,100 Against Lyft Accused Products**

Claim 10,299,100	- Lyft's Accused Products
a geographical location of the mobile device	The Lyft app performs this limitation by determining the location of the device associated with the account or identity data described above. For example, the passenger's Lyft app installed determines the passenger's location and displays it on the map in the Lyft app. Similarly, the driver's mobile phone with the Lyft Driver app installed determines the driver's location and displays it on the map in the Lyft Driver app. The rider's location comprises geographical coordinates or geotagged/geocoded/georeferenced information related to a rider's geographical location.

RESTRICTED CONFIDENTIAL SOURCE CODE

Attachment C for US Patent No. 10,299,100 Against Lyft Accused Products

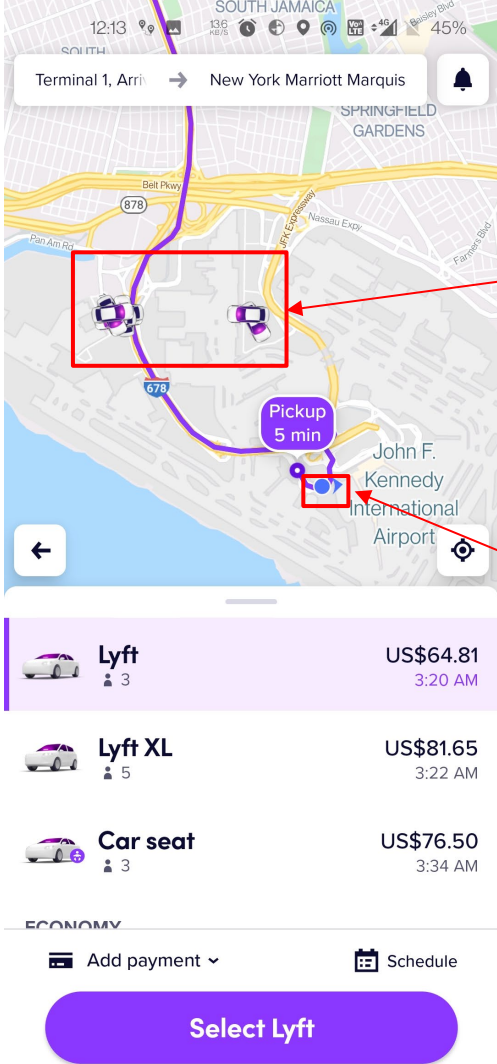
Claim 10,299,100	- Lyft's Accused Products												
	 <p>The screenshot displays the Lyft app interface. At the top, the map shows the route from Terminal 1, Arrivals to New York Marriott Marquis. A red box highlights two driver icons on the map, with a red arrow pointing to a text box labeled "Nearby Drivers' location". Another red box highlights the passenger's location icon on the map, with a red arrow pointing to a text box labeled "Passenger's location". Below the map, a list of ride options is shown:</p> <table border="1"><thead><tr><th>Option</th><th>Price</th><th>Time</th></tr></thead><tbody><tr><td>Lyft (3 seats)</td><td>US\$64.81</td><td>3:20 AM</td></tr><tr><td>Lyft XL (5 seats)</td><td>US\$81.65</td><td>3:22 AM</td></tr><tr><td>Car seat (3 seats)</td><td>US\$76.50</td><td>3:34 AM</td></tr></tbody></table> <p>At the bottom, there are options for "Add payment" and "Schedule", and a large purple button labeled "Select Lyft".</p>	Option	Price	Time	Lyft (3 seats)	US\$64.81	3:20 AM	Lyft XL (5 seats)	US\$81.65	3:22 AM	Car seat (3 seats)	US\$76.50	3:34 AM
Option	Price	Time											
Lyft (3 seats)	US\$64.81	3:20 AM											
Lyft XL (5 seats)	US\$81.65	3:22 AM											
Car seat (3 seats)	US\$76.50	3:34 AM											

RESTRICTED CONFIDENTIAL SOURCE CODE

Attachment C for US Patent No. 10,299,100 Against Lyft Accused Products

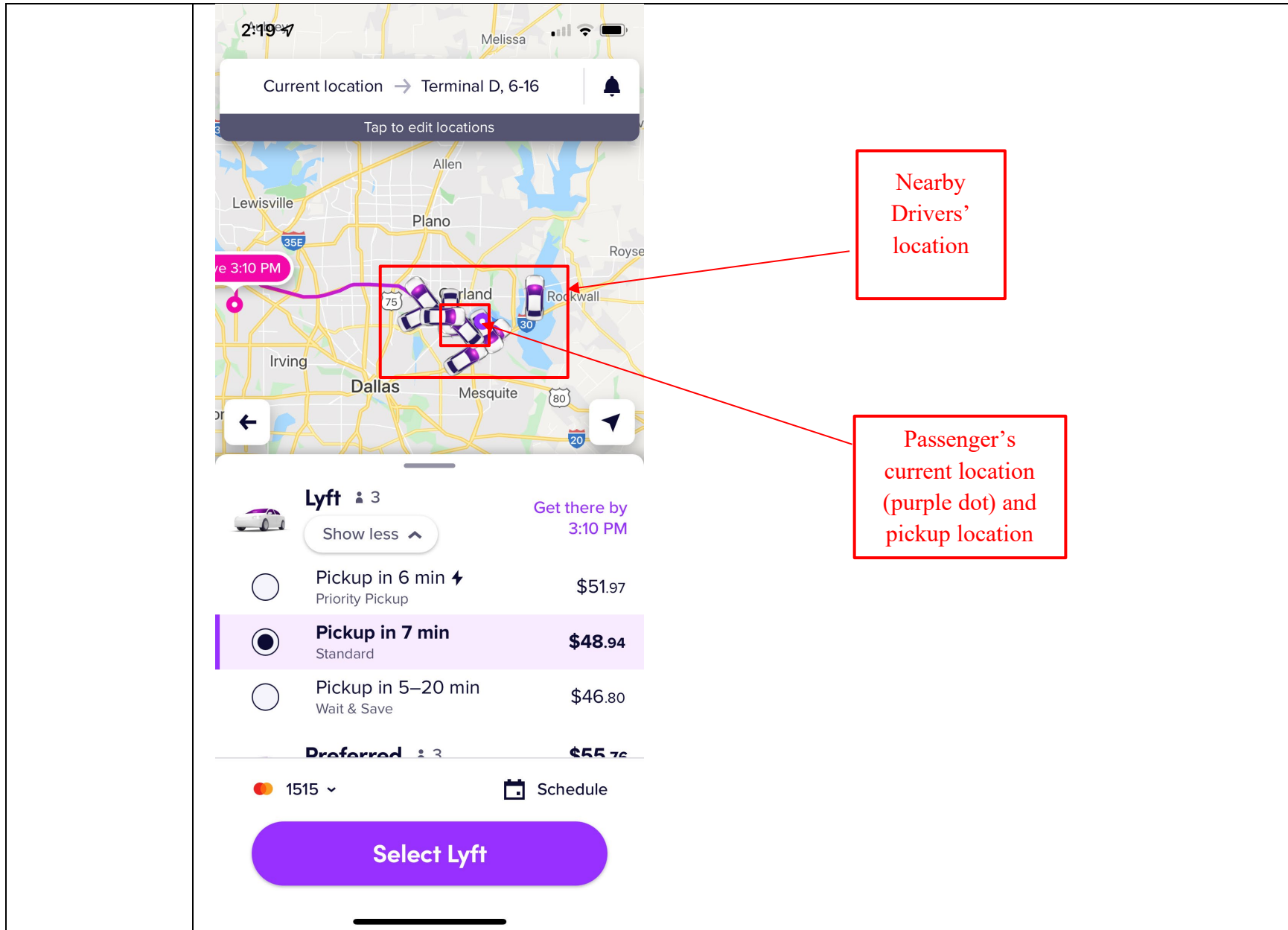

RESTRICTED CONFIDENTIAL SOURCE CODE

Attachment C for US Patent No. 10,299,100 Against Lyft Accused Products

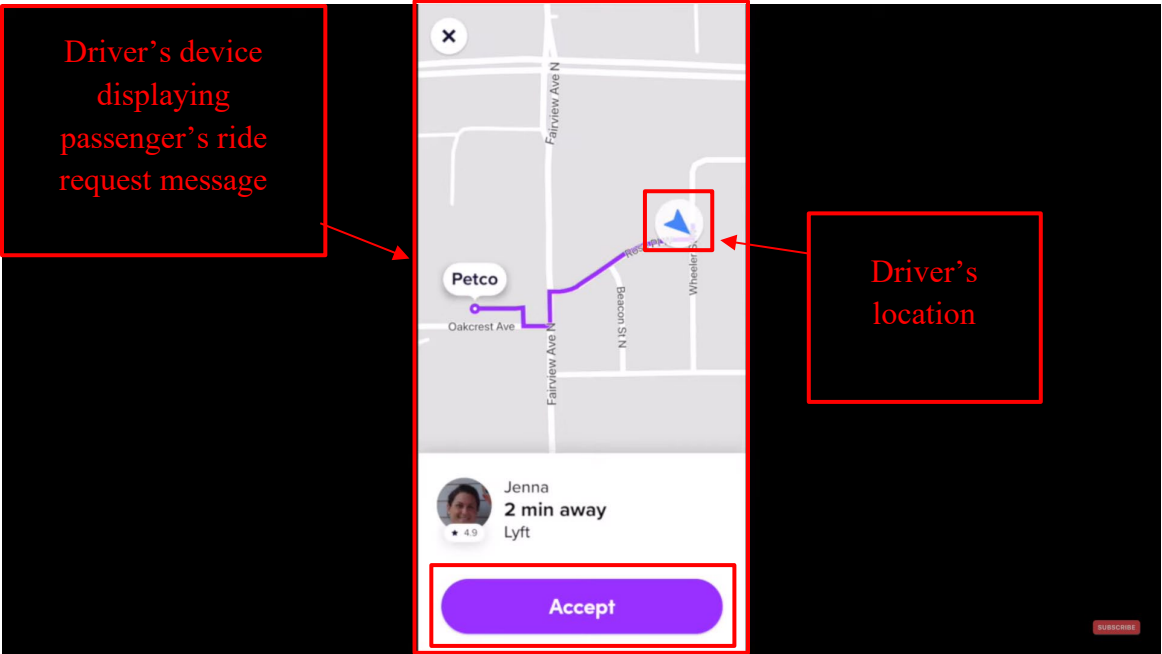
Claim 10,299,100	- Lyft's Accused Products
	 <p>Driver's device displaying passenger's ride request message</p> <p>Driver's location</p> <p>https://www.youtube.com/watch?v=jVUy9poJDng at 10:24, Annotated</p>

RESTRICTED CONFIDENTIAL SOURCE CODE

Attachment C for US Patent No. 10,299,100 Against Lyft Accused Products

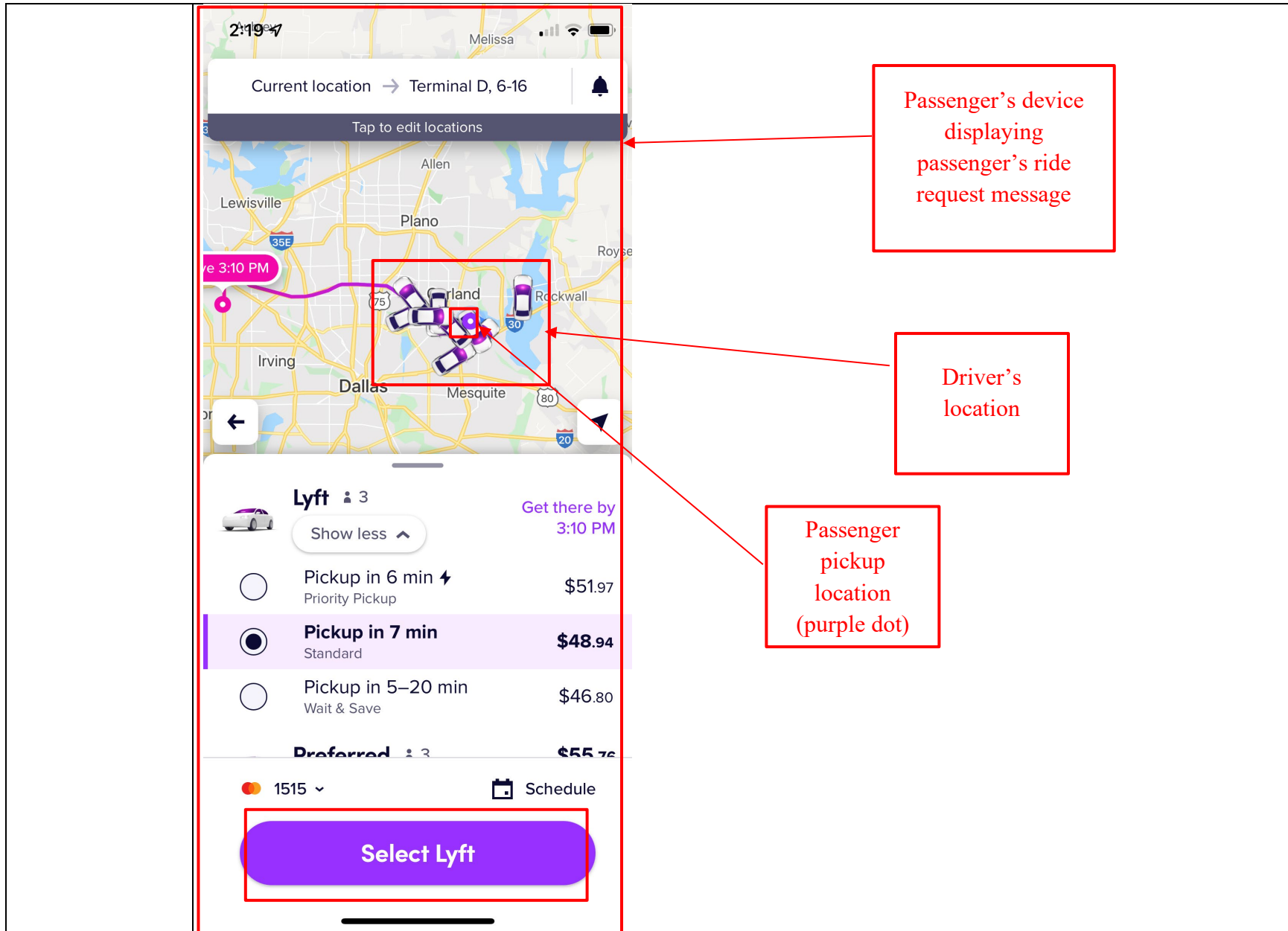

RESTRICTED CONFIDENTIAL SOURCE CODE**Attachment C for US Patent No. 10,299,100 Against Lyft Accused Products**

Claim 10,299,100	- Lyft's Accused Products
	<p>Provided certain conditions are met, users of the Rider and Driver Apps can share their location with other users of Driver and Rider Apps as well as additional contacts, friends, and family. Lyft encourages and instructs users of the Rider and Driver Apps to configure their phones to share their locations. The Driver and Rider Apps are pre-configured to show the location of riders and drivers and to update the locations continuously. For example, the Rider App provides rider locations to Lyft Servers in the forms of pickup locations and current locations and Lyft Servers transmit these locations to Driver Apps with ride requests and trip details. The Rider App can update the pickup locations and current locations and these location updates are similarly transmitted to Lyft Servers and Driver Apps. In another example, the Driver App provides driver locations to Lyft Servers immediately during sign up or log in to the Driver App and continuously provides updates to the Lyft Servers before, during, and after rides. The Rider App can show the location of drivers before requesting a ride, after requesting a ride, after being matched with a particular driver, during the approach of the driver, and during the ride until the completion of the ride. In other circumstances, Rider and Driver Apps are configured by Lyft to permit users to share their locations with others by specifying contacts, friends, family members. In some instances, Lyft Servers create a link for distribution to others for access to maps containing shared locations from Lyft Servers. These shared locations permit others to track the locations of riders and drivers during rides provided by Lyft. Location sharing in Lyft's products also enables features to view and share trip progress and to track locations and computed routes. These features are built in to the Rider and Driver Apps and serviced by Lyft Servers.</p> <p>Further, to the extent this element is performed at least in part by Lyft's software source code, AGIS reserves the right to supplement these contentions pursuant to production of such source code by Lyft and to the extent Lyft requires additional information in accordance with P.R. 3-1 and for any other reasons.</p>
1[D]. receiving, from a server, mapping data including a map	The Lyft Accused Products infringe directly and/or indirectly by performing, inducing others to perform, and/or contributing to the performance of: receiving, from a server, mapping data including a map and coordinate translation data correlating coordinates of positions on the map with corresponding coordinates of geographical locations.

RESTRICTED CONFIDENTIAL SOURCE CODE

Attachment C for US Patent No. 10,299,100 Against Lyft Accused Products

Claim 10,299,100	Lyft's Accused Products
and coordinate translation data correlating coordinates of positions on the map with corresponding coordinates of geographical locations	The Lyft app performs this limitation because it receives maps and/or map tiles from a server for displaying a map in the Lyft app display. The Lyft app also receives data for correlating map coordinates to geographical locations. For example, the Lyft server transmits the calculated location coordinates of the passenger and nearby drivers to the passenger's device and loads them on the map. Further, the location coordinates of the driver and the passenger (pickup location) are transmitted to the driver's device during the ride request from the passenger. Once the ride is accepted and the passenger is picked up by the driver, the destination address of the passenger is also loaded on the map in the Lyft Driver app on the driver's device.

RESTRICTED CONFIDENTIAL SOURCE CODE

Attachment C for US Patent No. 10,299,100 Against Lyft Accused Products

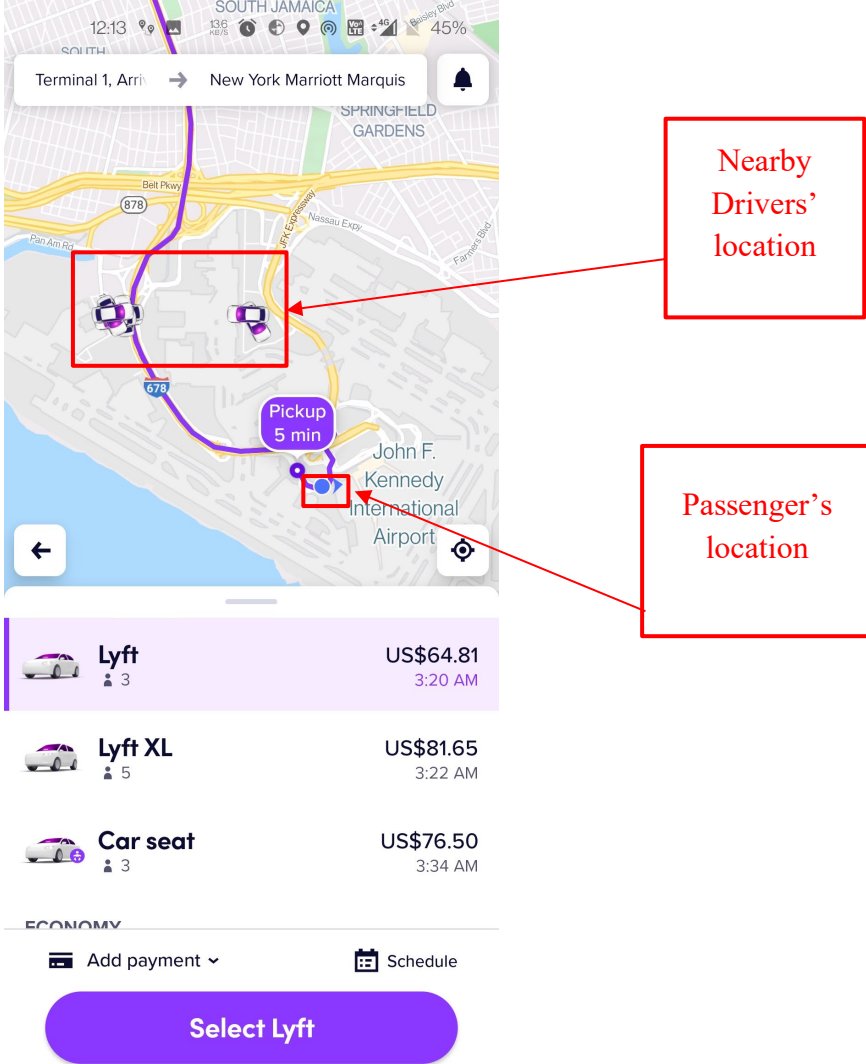
Claim 10,299,100	- Lyft's Accused Products
	 <p>The screenshot displays the Lyft app interface. At the top, the map shows the route from Terminal 1, Arrivals at JFK Airport to New York Marriott Marquis. A red box highlights two nearby driver locations on the map, with a red arrow pointing to a text label: "Nearby Drivers' location". Another red box highlights the passenger's location at JFK Airport, with a red arrow pointing to a text label: "Passenger's location". Below the map, three ride options are listed: Lyft (US\$64.81, 3:20 AM), Lyft XL (US\$81.65, 3:22 AM), and Car seat (US\$76.50, 3:34 AM). At the bottom, there is a "Select Lyft" button.</p>

RESTRICTED CONFIDENTIAL SOURCE CODE

Attachment C for US Patent No. 10,299,100 Against Lyft Accused Products

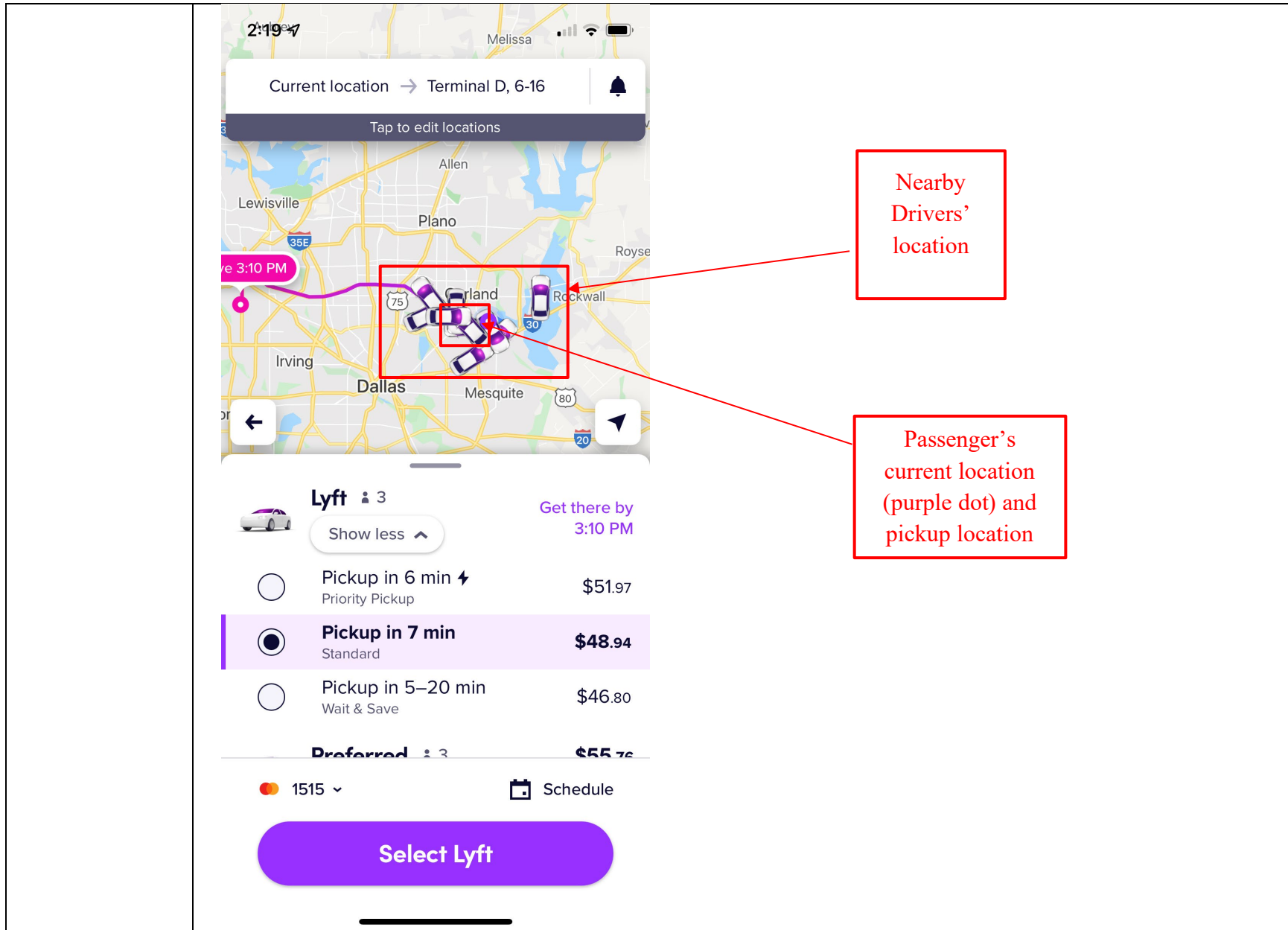

RESTRICTED CONFIDENTIAL SOURCE CODE

Attachment C for US Patent No. 10,299,100 Against Lyft Accused Products

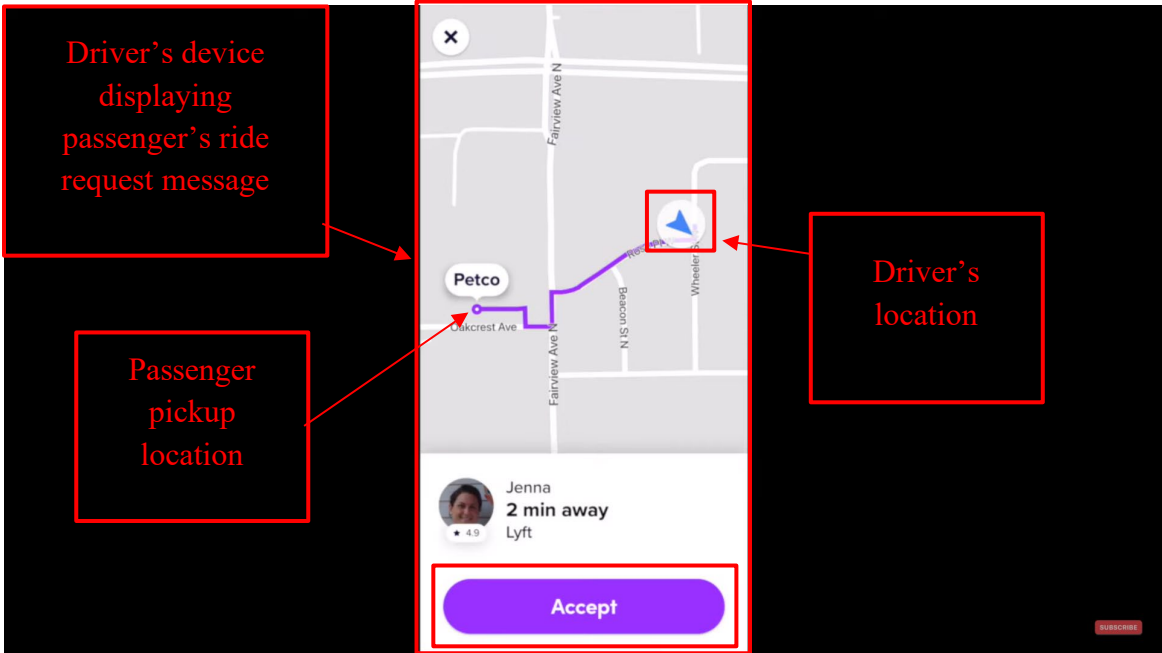
Claim 10,299,100	- Lyft's Accused Products
	 <p>The screenshot shows a Lyft driver's interface. At the top, a message reads "Petco" with a location pin. Below it, a map displays a route from the driver's location (marked with a blue triangle) to the pickup location (marked with a red pin). The driver's name "Jenna" and "2 min away" are visible. A prominent purple "Accept" button is at the bottom. Red boxes and arrows highlight these key elements: the message, the pickup location, the driver's location, and the "Accept" button.</p> <p>https://www.youtube.com/watch?v=jVUy9poJDng at 10:24, Annotated</p>

RESTRICTED CONFIDENTIAL SOURCE CODE

Attachment C for US Patent No. 10,299,100 Against Lyft Accused Products

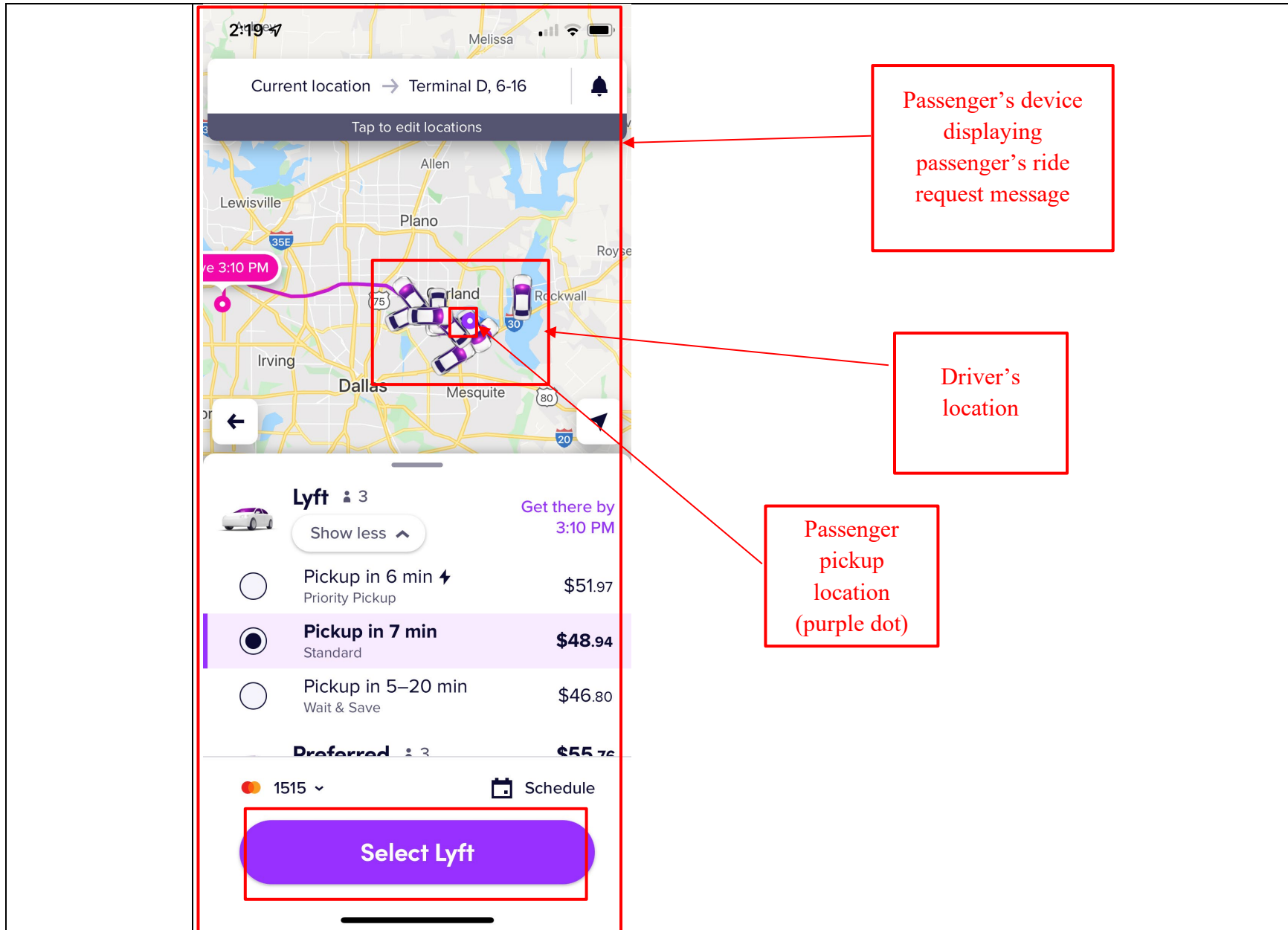

RESTRICTED CONFIDENTIAL SOURCE CODE

Attachment C for US Patent No. 10,299,100 Against Lyft Accused Products

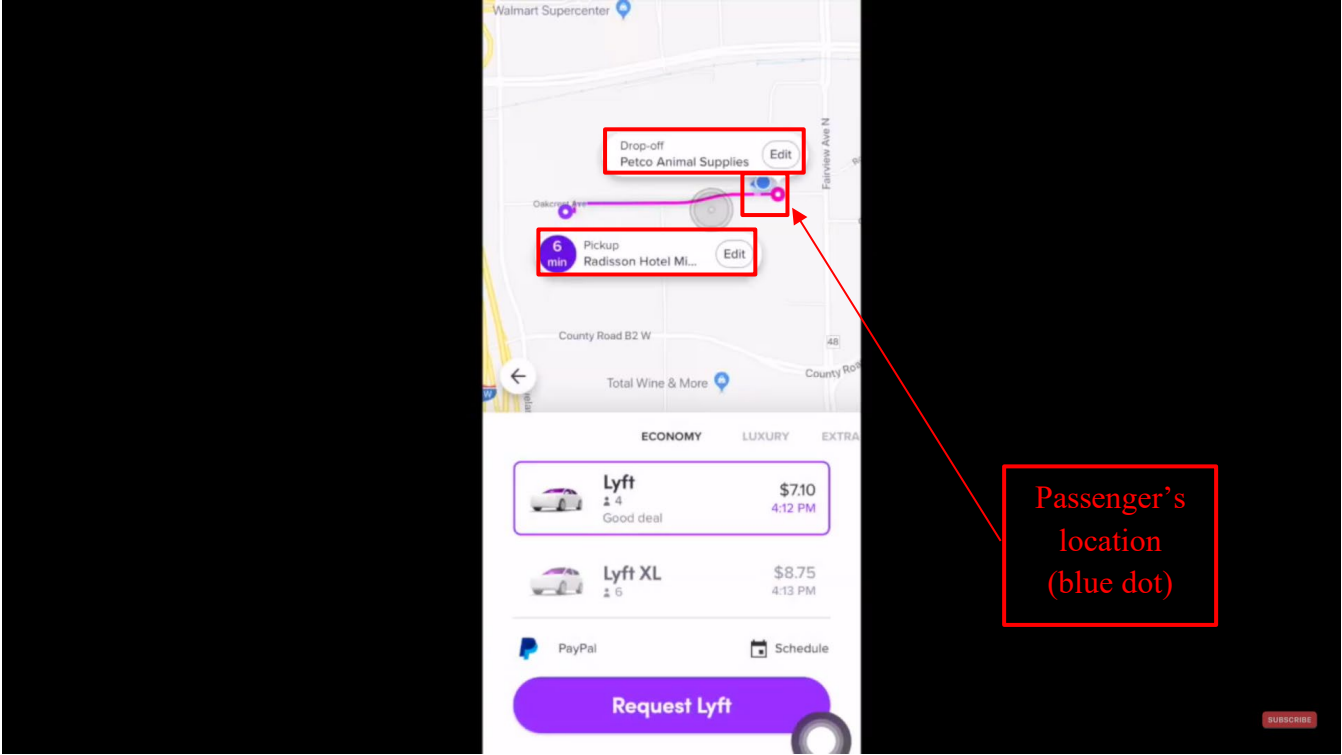
Claim 10,299,100	- Lyft's Accused Products
	 <p>The screenshot displays the Lyft app interface. At the top, a map shows a route from a pickup location to a drop-off location. The pickup location is labeled "Pickup Radisson Hotel M..." with a "6 min" icon. The drop-off location is labeled "Drop-off Petco Animal Supplies". A blue dot on the map indicates the passenger's location. Below the map, there are two pricing options: "Lyft" for \$7.10 (4:12 PM) and "Lyft XL" for \$8.75 (4:13 PM). A "Request Lyft" button is visible at the bottom. A red box highlights the blue dot on the map, with a red arrow pointing to it from a text box that reads "Passenger's location (blue dot)".</p> <p>https://www.youtube.com/watch?v=j0RDMLcmOgU at 3:49</p>

RESTRICTED CONFIDENTIAL SOURCE CODE

Attachment C for US Patent No. 10,299,100 Against Lyft Accused Products

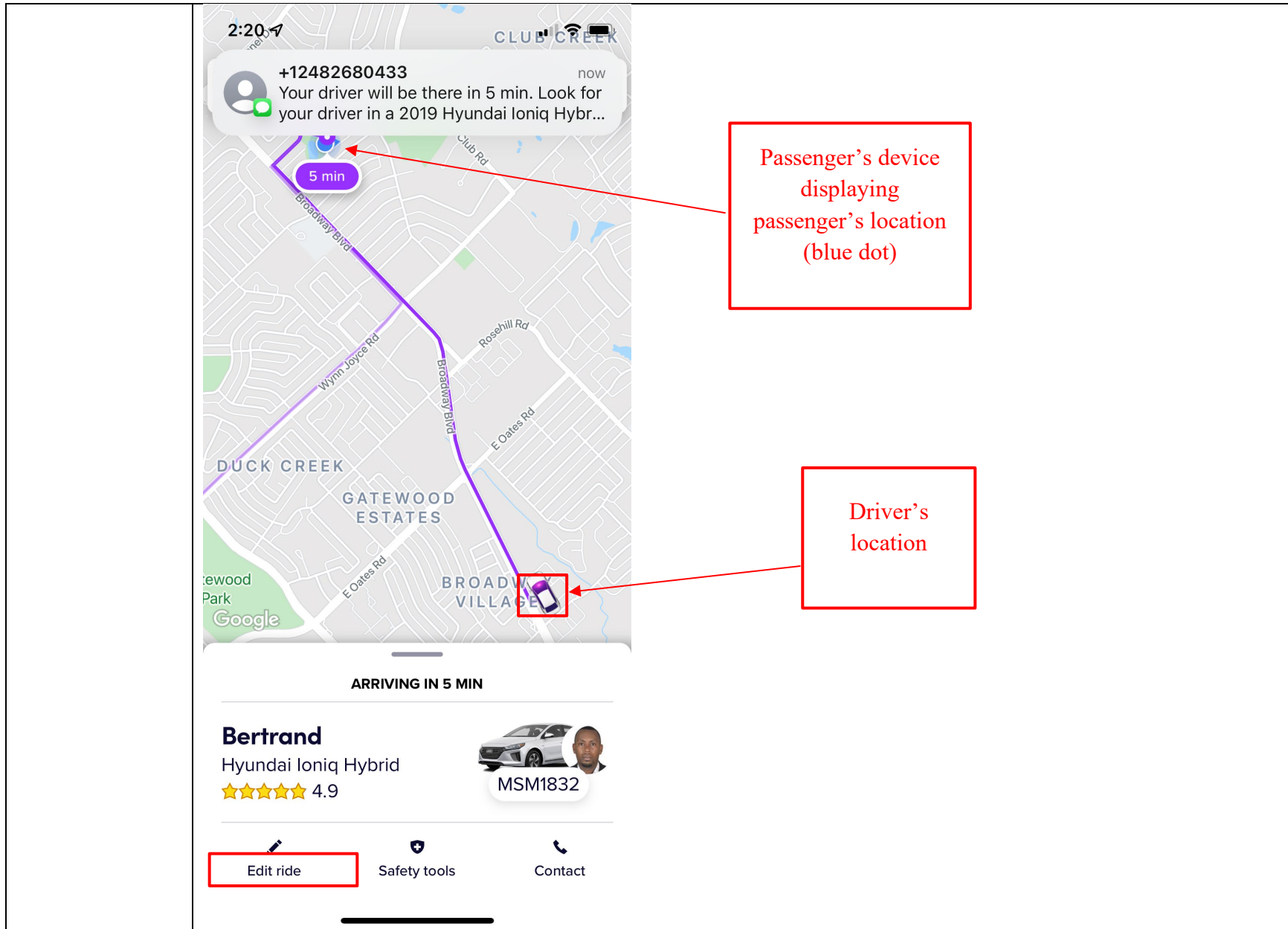

RESTRICTED CONFIDENTIAL SOURCE CODE

Attachment C for US Patent No. 10,299,100 Against Lyft Accused Products

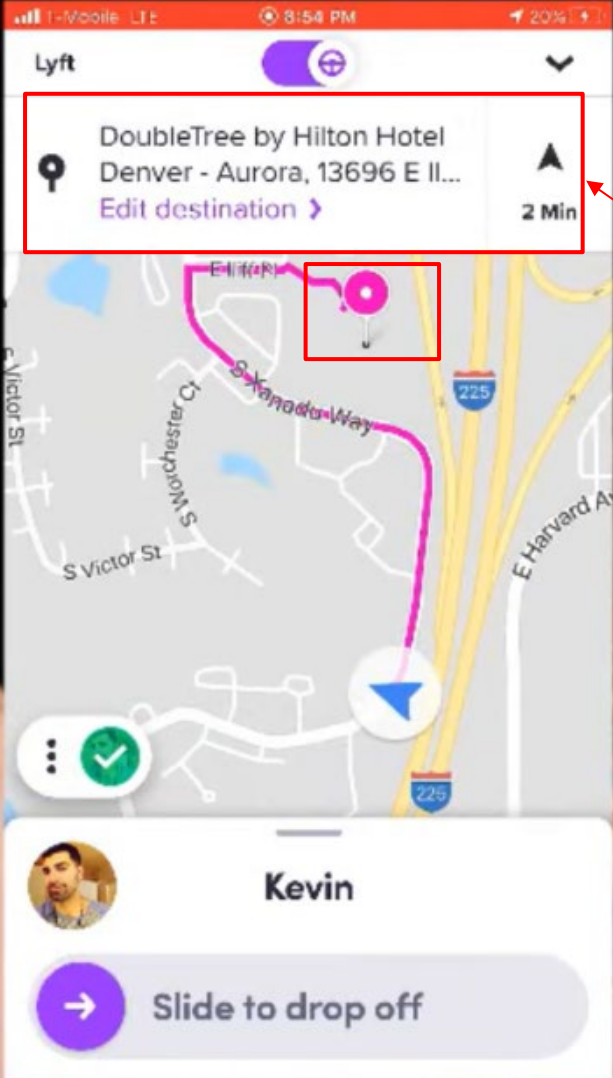
Claim 10,299,100	- Lyft's Accused Products
	 <p>The screenshot shows the Lyft mobile application interface. At the top, the status bar displays 'T-Mobile LTE', '8:54 PM', and '20%' battery. The app header shows the 'Lyft' logo and a toggle switch. Below the header, a destination card is visible, containing the text 'DoubleTree by Hilton Hotel Denver - Aurora, 13696 E Il...' and '2 Min'. A red box highlights this destination card. Below the card is a map showing a route in purple. A red box highlights a specific location on the map, which is a pink pin. A red arrow points from this pin to a text box on the right. The text box contains the text: 'Passenger's destination location loaded after the driver picks him/her up'. At the bottom of the screen, there is a driver profile for 'Kevin' and a 'Slide to drop off' button.</p>

RESTRICTED CONFIDENTIAL SOURCE CODE

Attachment C for US Patent No. 10,299,100 Against Lyft Accused Products

Claim 10,299,100	-	Lyft's Accused Products
		https://www.youtube.com/watch?v=b31WorLlcqE at 9:40

RESTRICTED CONFIDENTIAL SOURCE CODE

Attachment C for US Patent No. 10,299,100 Against Lyft Accused Products

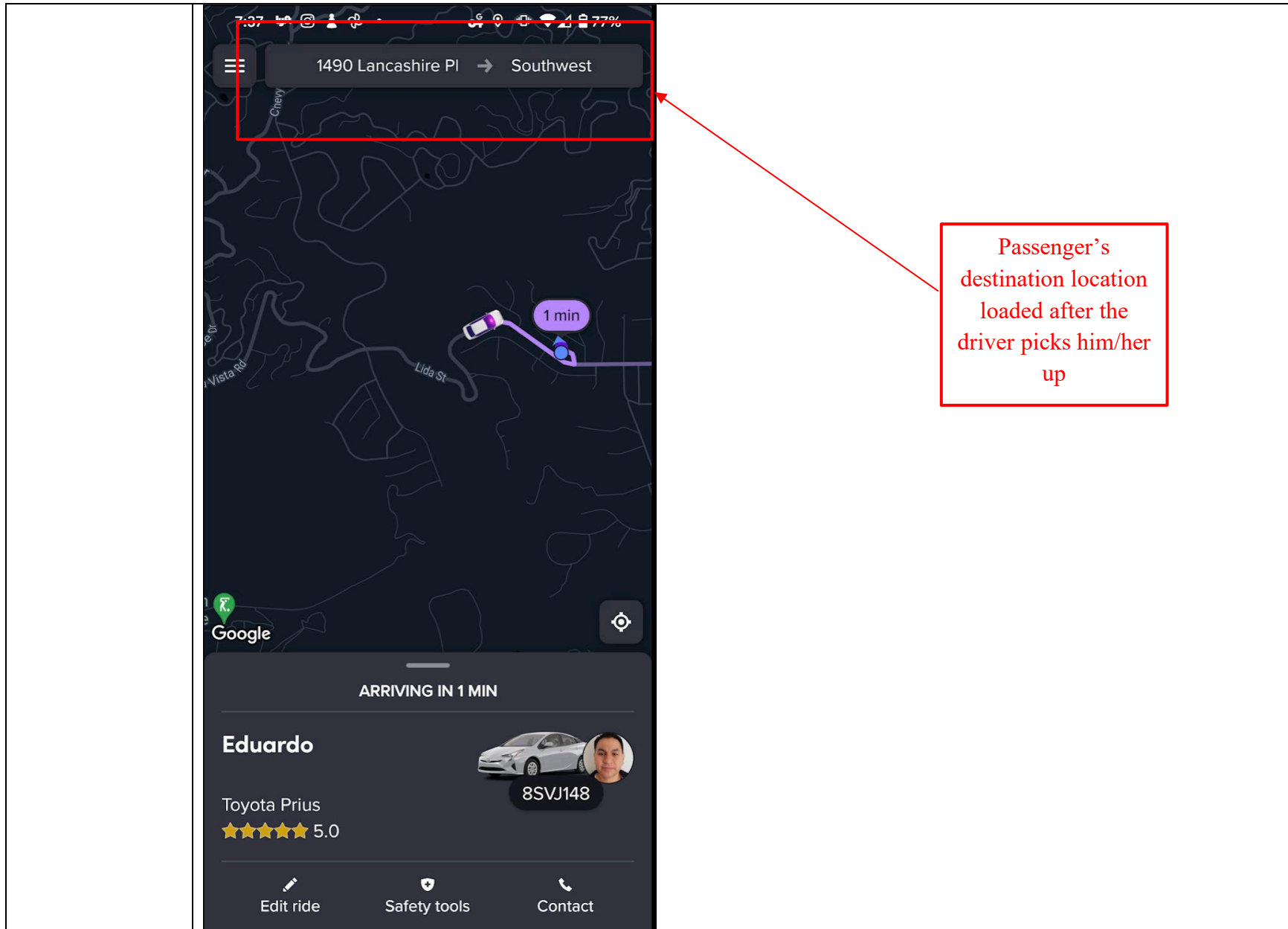

RESTRICTED CONFIDENTIAL SOURCE CODE**Attachment C for US Patent No. 10,299,100 Against Lyft Accused Products**

Claim 10,299,100	- Lyft's Accused Products
	<p>See also 1[C].</p> <p>Further, to the extent this element is performed at least in part by Lyft's software source code, AGIS reserves the right to supplement these contentions pursuant to production of such source code by Lyft and to the extent Lyft requires additional information in accordance with P.R. 3-1 and for any other reasons.</p>
<p>1[E]. receiving, from a server, location data indicating vehicle locations of one or more vehicles</p>	<p>The Lyft Accused Products infringe directly and/or indirectly by performing, inducing others to perform, and/or contributing to the performance of: receiving, from a server, location data indicating vehicle locations of one or more vehicles.</p> <p>The Lyft app performs this limitation because it receives vehicle location data from a server and that vehicle location data indicates the locations of drivers/vehicles. For example, the Lyft server transmits the calculated location coordinates of the passenger and nearby drivers (“location data indicating vehicle locations of one or more vehicles”) to the passenger’s device and loads them on the map in the Lyft app on the passenger’s device.</p>

RESTRICTED CONFIDENTIAL SOURCE CODE

Attachment C for US Patent No. 10,299,100 Against Lyft Accused Products

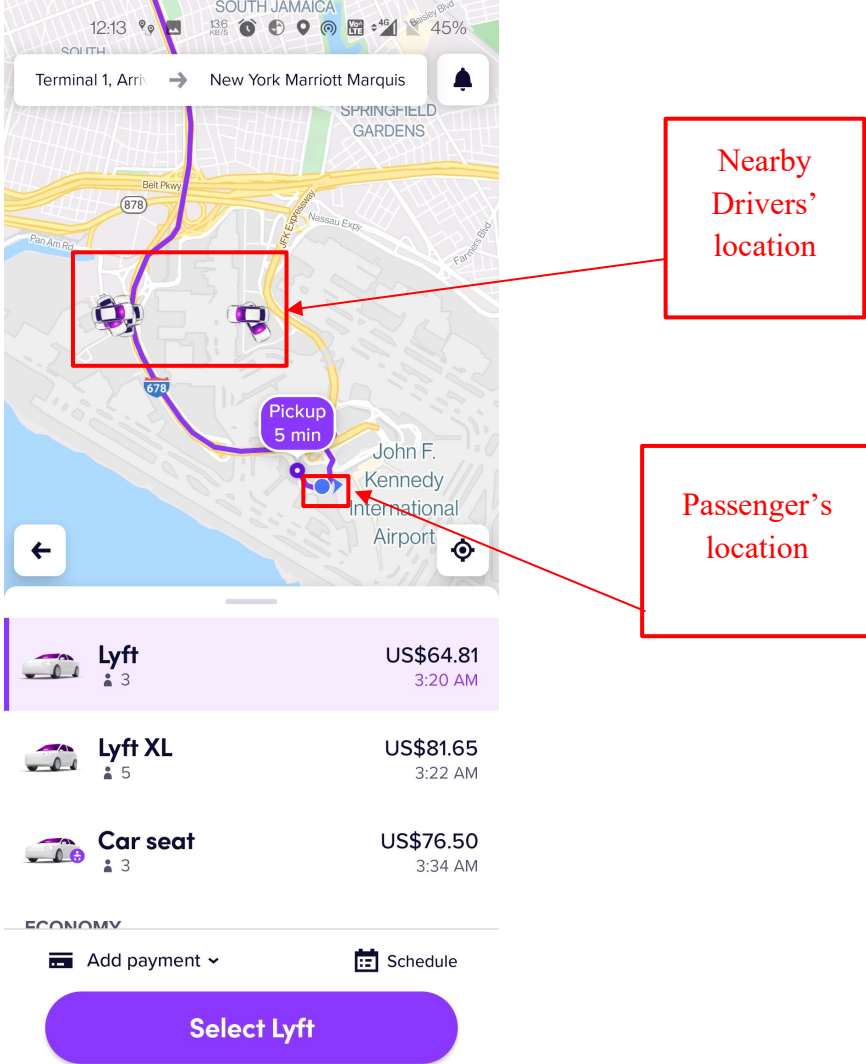
Claim 10,299,100	- Lyft's Accused Products
	 <p>The screenshot displays the Lyft app interface. At the top, the map shows the route from Terminal 1, Arrivals to New York Marriott Marquis. A red box highlights two nearby driver locations on the map, with an arrow pointing to the text 'Nearby Drivers' location'. Another red box highlights the pickup location at John F. Kennedy International Airport, with an arrow pointing to the text 'Passenger's location'. Below the map, the app shows three ride options: Lyft (US\$64.81, 3:20 AM), Lyft XL (US\$81.65, 3:22 AM), and Car seat (US\$76.50, 3:34 AM). At the bottom, there is a 'Select Lyft' button.</p>

RESTRICTED CONFIDENTIAL SOURCE CODE

Attachment C for US Patent No. 10,299,100 Against Lyft Accused Products

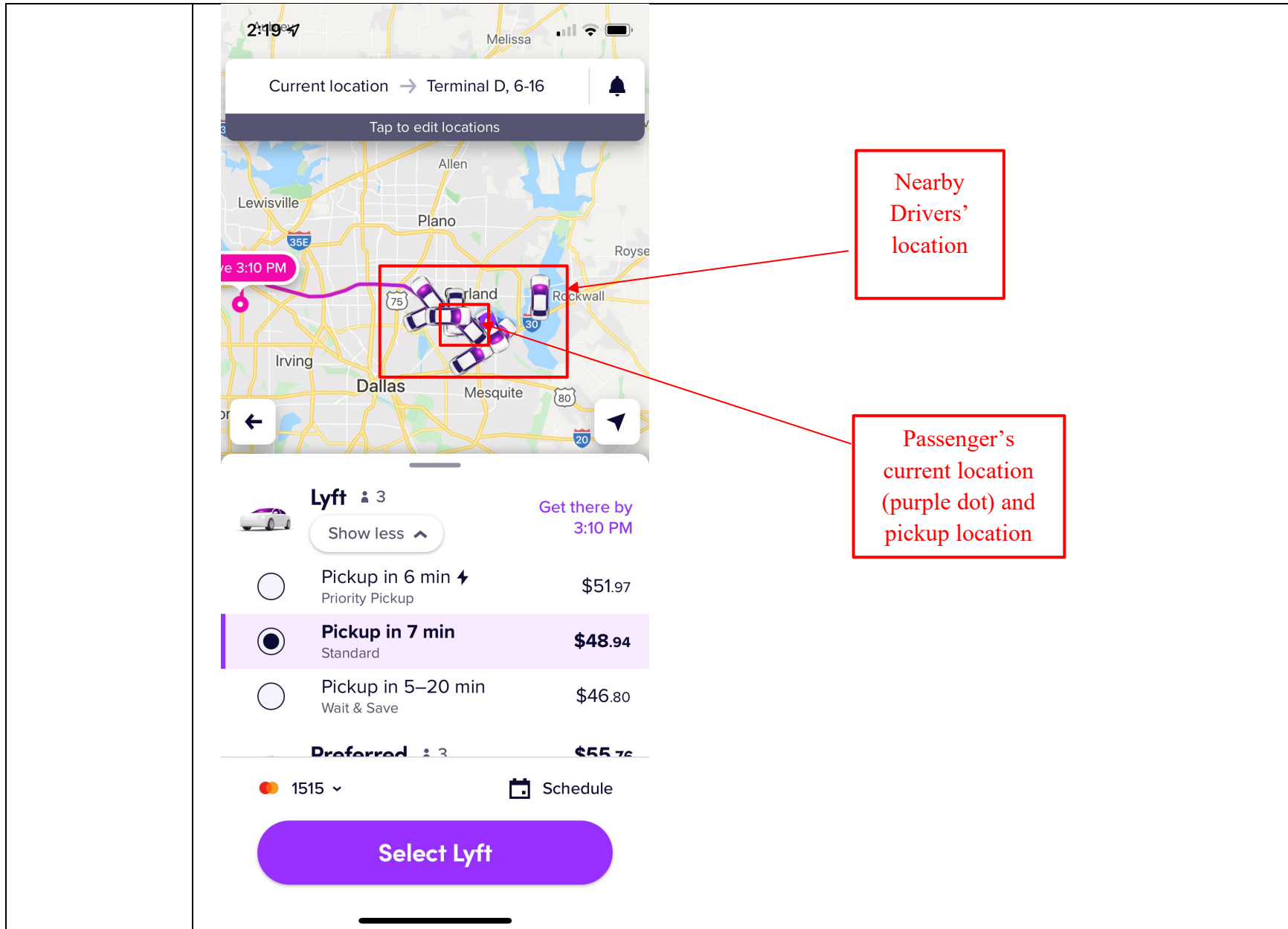

RESTRICTED CONFIDENTIAL SOURCE CODE**Attachment C for US Patent No. 10,299,100 Against Lyft Accused Products**

Claim 10,299,100	- Lyft's Accused Products
	<p>See also 1[C].</p> <p>Further, to the extent this element is performed at least in part by Lyft's software source code, AGIS reserves the right to supplement these contentions pursuant to production of such source code by Lyft and to the extent Lyft requires additional information in accordance with P.R. 3-1 and for any other reasons.</p>
<p>1[F]. marking the map with a plurality of symbols comprising: a participant symbol corresponding to the device location, one or more facility symbols corresponding to respective facility locations of one or more facilities, and one or more vehicle symbols corresponding to the respective vehicle locations of the one or</p>	<p>The Lyft Accused Products infringe directly and/or indirectly by performing, inducing others to perform, and/or contributing to the performance of: marking the map with a plurality of symbols comprising: a participant symbol corresponding to the device location, one or more facility symbols corresponding to respective facility locations of one or more facilities, and one or more vehicle symbols corresponding to the respective vehicle locations of the one or more vehicles.</p> <p>The Lyft app performs this limitation because the Lyft app displays multiple symbols on its map, including a symbol for vehicles, facilities, businesses, landmarks, and other points of interest. For example, the map in the Lyft app on the passenger's device comprises a blue dot ("participant symbol") depicting the passenger's current location. The map also identifies a pickup location which may correspond to the current location of the rider. Further, the map also highlights locations including but not limited to airports, road names, parks, shops and railway stations ("facility symbol"). The location of the nearby drivers is highlighted on the map in the passenger's device using vehicle icons.</p>

RESTRICTED CONFIDENTIAL SOURCE CODE

Attachment C for US Patent No. 10,299,100 Against Lyft Accused Products

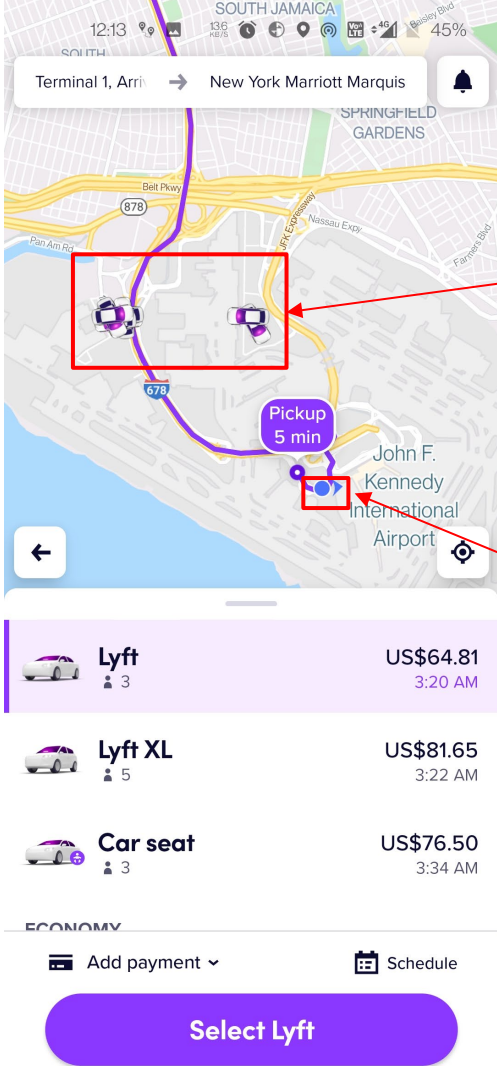
Claim 10,299,100	Lyft's Accused Products
more vehicles, wherein marking the map comprises	 <p>The screenshot shows the Lyft app interface. At the top, the route is from Terminal 1, Arrivals to New York Marriott Marquis. The map displays the area around John F. Kennedy International Airport. A red box highlights two driver icons on the map, with an arrow pointing to a text box labeled "Nearby Drivers' location". Another red box highlights the passenger location icon (a blue circle with a white eye) on the map, with an arrow pointing to a text box labeled "Passenger's location". Below the map, three ride options are listed: Lyft (US\$64.81, 3:20 AM), Lyft XL (US\$81.65, 3:22 AM), and Car seat (US\$76.50, 3:34 AM). At the bottom, there is a "Select Lyft" button.</p>

RESTRICTED CONFIDENTIAL SOURCE CODE

Attachment C for US Patent No. 10,299,100 Against Lyft Accused Products

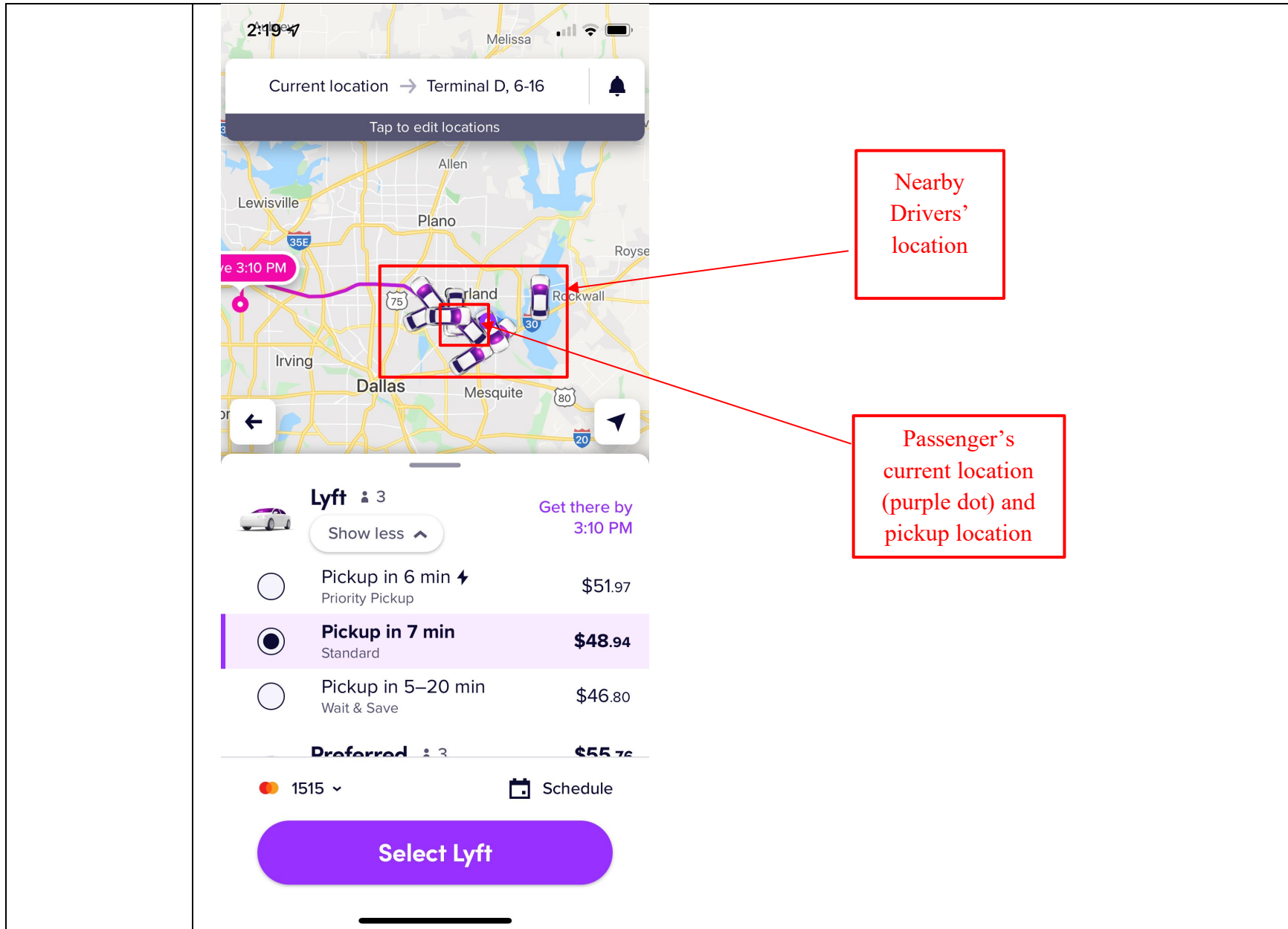

RESTRICTED CONFIDENTIAL SOURCE CODE**Attachment C for US Patent No. 10,299,100 Against Lyft Accused Products**

Claim 10,299,100	- Lyft's Accused Products
	<p>See also 1[C].</p> <p>Further, to the extent this element is performed at least in part by Lyft's software source code, AGIS reserves the right to supplement these contentions pursuant to production of such source code by Lyft and to the extent Lyft requires additional information in accordance with P.R. 3-1 and for any other reasons.</p>
<p>1[G]. wherein marking the map comprises: determining, based at least in part on the vehicle locations and the coordinate translation data, positions on the map corresponding to the vehicle locations, displaying the map on the display of the</p>	<p>The Lyft Accused Products infringe directly and/or indirectly by performing, inducing others to perform, and/or contributing to the performance of: wherein marking the map comprises: determining, based at least in part on the vehicle locations and the coordinate translation data, positions on the map corresponding to the vehicle locations, displaying the map on the display of the mobile device, and placing the vehicle symbols on the map at the determined positions corresponding to the vehicle locations.</p> <p>The Lyft app performs this limitation because it determines where to place symbols on its map and places those symbols based on the data received from the server. For example, the Lyft server determines the location coordinates of the nearby drivers with respect to the passenger and transmits them to the Lyft app on the passenger's device. The location coordinates of the nearby drivers are loaded on the map and is displayed on the passenger's device. Each vehicle on the map indicates the position of a nearby driver.</p>

RESTRICTED CONFIDENTIAL SOURCE CODE

Attachment C for US Patent No. 10,299,100 Against Lyft Accused Products

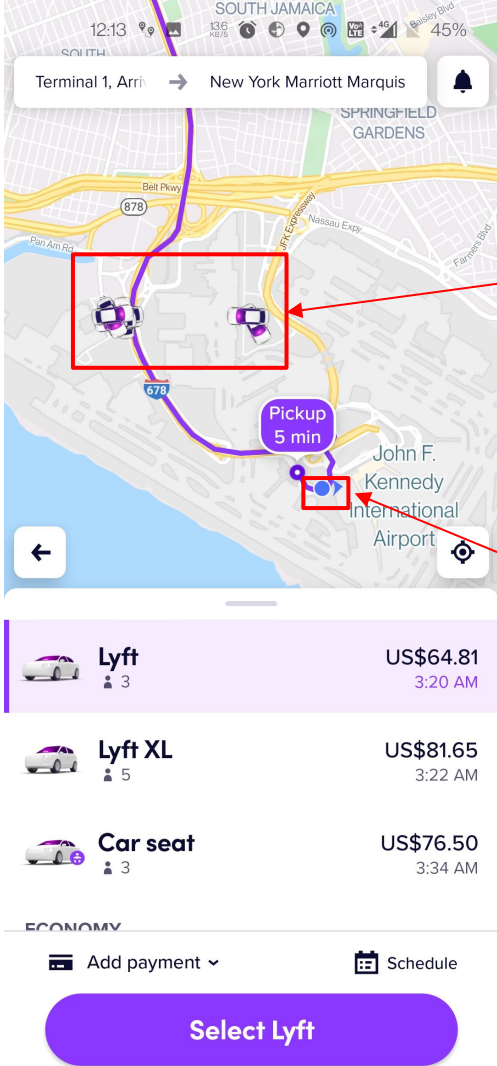
Claim 10,299,100	Lyft's Accused Products
<p>mobile device, and placing the vehicle symbols on the map at the determined positions corresponding to the vehicle locations.</p>	 <p>The screenshot shows the Lyft app interface. At the top, the map displays the route from Terminal 1, Arrivals to New York Marriott Marquis. A red box highlights two purple car icons representing nearby drivers. Another red box highlights a blue location pin representing the passenger's location. Below the map, three ride options are listed: Lyft (US\$64.81, 3:20 AM), Lyft XL (US\$81.65, 3:22 AM), and Car seat (US\$76.50, 3:34 AM). A purple button at the bottom says 'Select Lyft'.</p>

RESTRICTED CONFIDENTIAL SOURCE CODE

Attachment C for US Patent No. 10,299,100 Against Lyft Accused Products

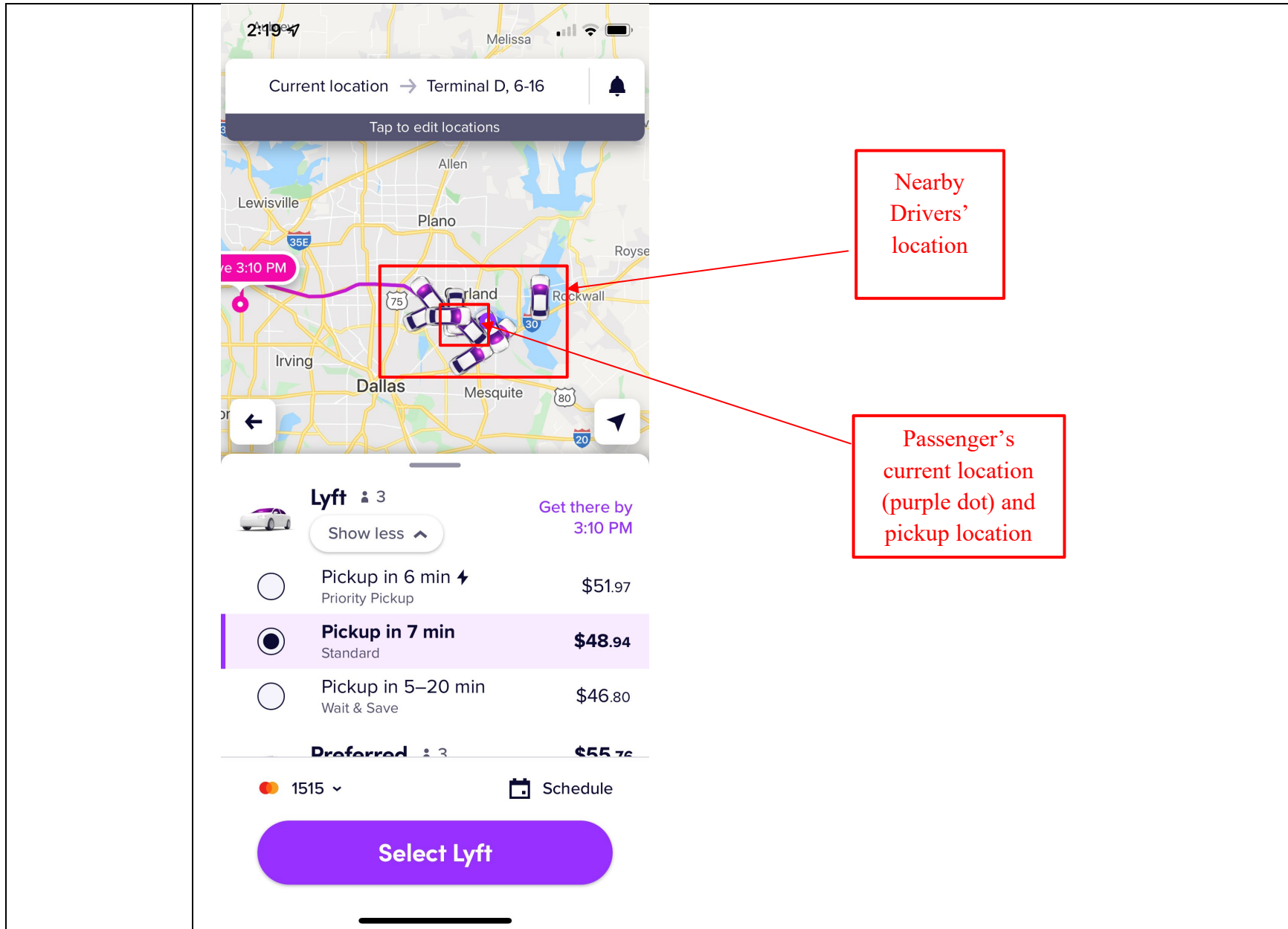

Nearby Drivers' location

Passenger's current location (purple dot) and pickup location

RESTRICTED CONFIDENTIAL SOURCE CODE**Attachment C for US Patent No. 10,299,100 Against Lyft Accused Products**

Claim 10,299,100	- Lyft's Accused Products
	<p>See also 1[C] and 1[F].</p> <p>Further, to the extent this element is performed at least in part by Lyft's software source code, AGIS reserves the right to supplement these contentions pursuant to production of such source code by Lyft and to the extent Lyft requires additional information in accordance with P.R. 3-1 and for any other reasons.</p>
<p>1[H]. responsive to user selection of a portion of the display corresponding to a position on the map, identifying a selected facility symbol based on the selected position, comprising: initiating a search of a set of symbols including the facility symbols for a symbol located nearest to the selected position and, based on a result</p>	<p>The Lyft Accused Products infringe directly and/or indirectly by performing, inducing others to perform, and/or contributing to the performance of: responsive to user selection of a portion of the display corresponding to a position on the map, identifying a selected facility symbol based on the selected position, comprising: initiating a search of a set of symbols including the facility symbols for a symbol located nearest to the selected position and, based on a result of the search, identifying the selected facility symbol as the symbol located nearest to the selected position.</p> <p>The Lyft app performs this limitation because it receives user input data regarding pickups, stops or destinations entered by a user and those pickups, stops or destinations correspond to geographical locations on a map. For example, the Lyft passenger uses the Lyft app for riders to select a pickup location and a destination location. The Lyft passenger can add entities of interest and select one or more entities of interest as a pickup or destination. The Lyft passenger can choose the pickup/stop/destination location by entering an address/location/shortcut or by choosing it on a map which will add/enter a symbol on the map and the passenger can change the location of the added/enter symbol to specify the location of the added/entered symbol as a pickup/stop/destination. Each of these methods will cause a symbol corresponding to the pickup/stop/destination to be added/entered on the map at the corresponding location. When the passenger completes this process, data associated with the added/entered symbol as a pickup/stop/destination is communicated to the Lyft server(s). Adding/entering the symbol for a pickup/stop/destination can occur before or during a ride. When a user enters an address, place, or shortcut, the Lyft app will search for and place a symbol at the nearest position to the address, place or shortcut.</p>

RESTRICTED CONFIDENTIAL SOURCE CODE**Attachment C for US Patent No. 10,299,100 Against Lyft Accused Products**

Claim 10,299,100	- Lyft's Accused Products
of the search, identifying the selected facility symbol as the symbol located nearest to the selected position	The Lyft app performs this limitation because it receives user input identifying a destination/stop. For example, when a passenger is booking the ride, Lyft provides a set location on the map providing an option for which the passenger selects the position on a map. For example, the passenger selects the position for a pickup such as an airport, in response to which Lyft initiates identifying the selected position and searching for all the symbols located nearby to the airport and identifying them (including but not limited to Terminal 1, Terminal 2 and Terminal 4).

RESTRICTED CONFIDENTIAL SOURCE CODE

Attachment C for US Patent No. 10,299,100 Against Lyft Accused Products

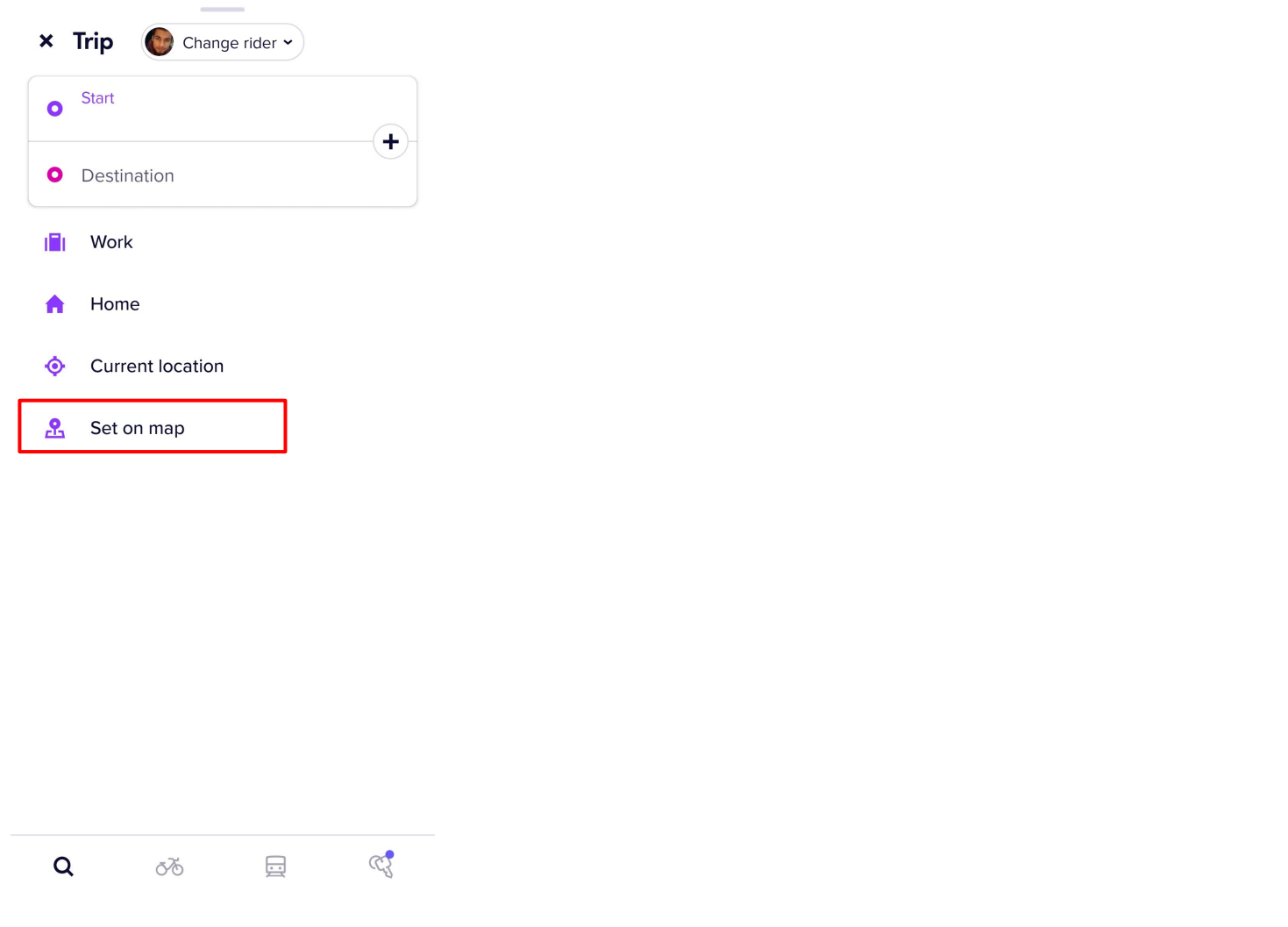
Claim 10,299,100	- Lyft's Accused Products
	 <p>The screenshot shows the Lyft mobile application interface. At the top, there is a header with a close button (x) and the word "Trip", followed by a profile picture and a "Change rider" dropdown menu. Below this is a form with two input fields: "Start" and "Destination", each with a location pin icon and a plus sign to its right. Underneath the form are four location suggestions: "Work" (with a building icon), "Home" (with a house icon), "Current location" (with a location pin icon), and "Set on map" (with a person icon). The "Set on map" option is highlighted with a red rectangular box. At the bottom of the screen, there is a navigation bar with four icons: a magnifying glass (search), a bicycle (ride), a train (public transit), and a person with a plus sign (add).</p>

RESTRICTED CONFIDENTIAL SOURCE CODE

Attachment C for US Patent No. 10,299,100 Against Lyft Accused Products

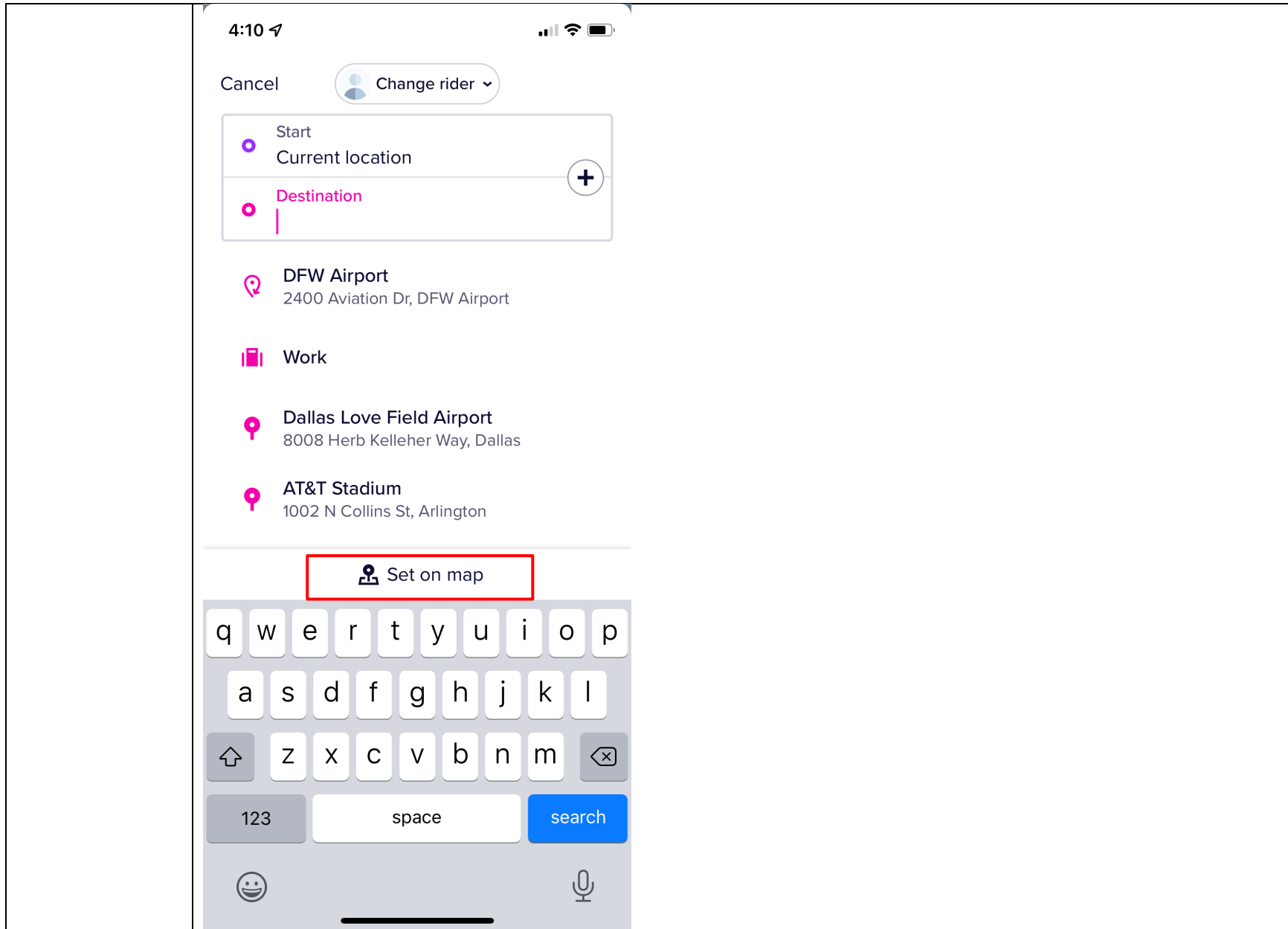

RESTRICTED CONFIDENTIAL SOURCE CODE

Attachment C for US Patent No. 10,299,100 Against Lyft Accused Products

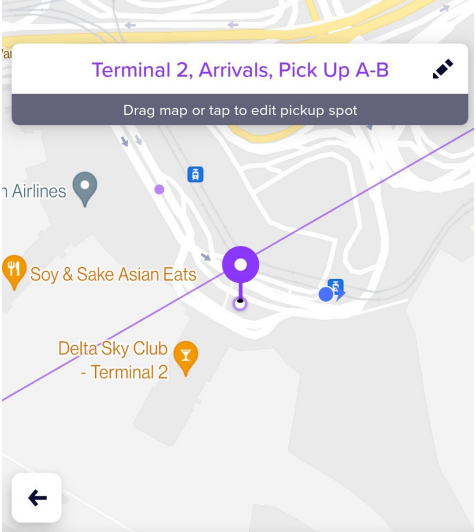
Claim 10,299,100	- Lyft's Accused Products			
	 <p>Terminal 2, Arrivals, Pick Up A-B</p> <p>Drag map or tap to edit pickup spot</p> <p>John F. Kennedy Int'l Airport</p> <p>Head down to the Arrivals curb and follow signs to Passenger Pick Up</p> <table border="1"><tr><td>Terminal 1, Arrivals</td></tr><tr><td>Terminal 2, Arrivals Pick Up A-B</td></tr><tr><td>Terminal 4, Arrivals</td></tr></table> <p>Set pickup</p>	Terminal 1, Arrivals	Terminal 2, Arrivals Pick Up A-B	Terminal 4, Arrivals
Terminal 1, Arrivals				
Terminal 2, Arrivals Pick Up A-B				
Terminal 4, Arrivals				

RESTRICTED CONFIDENTIAL SOURCE CODE

Attachment C for US Patent No. 10,299,100 Against Lyft Accused Products

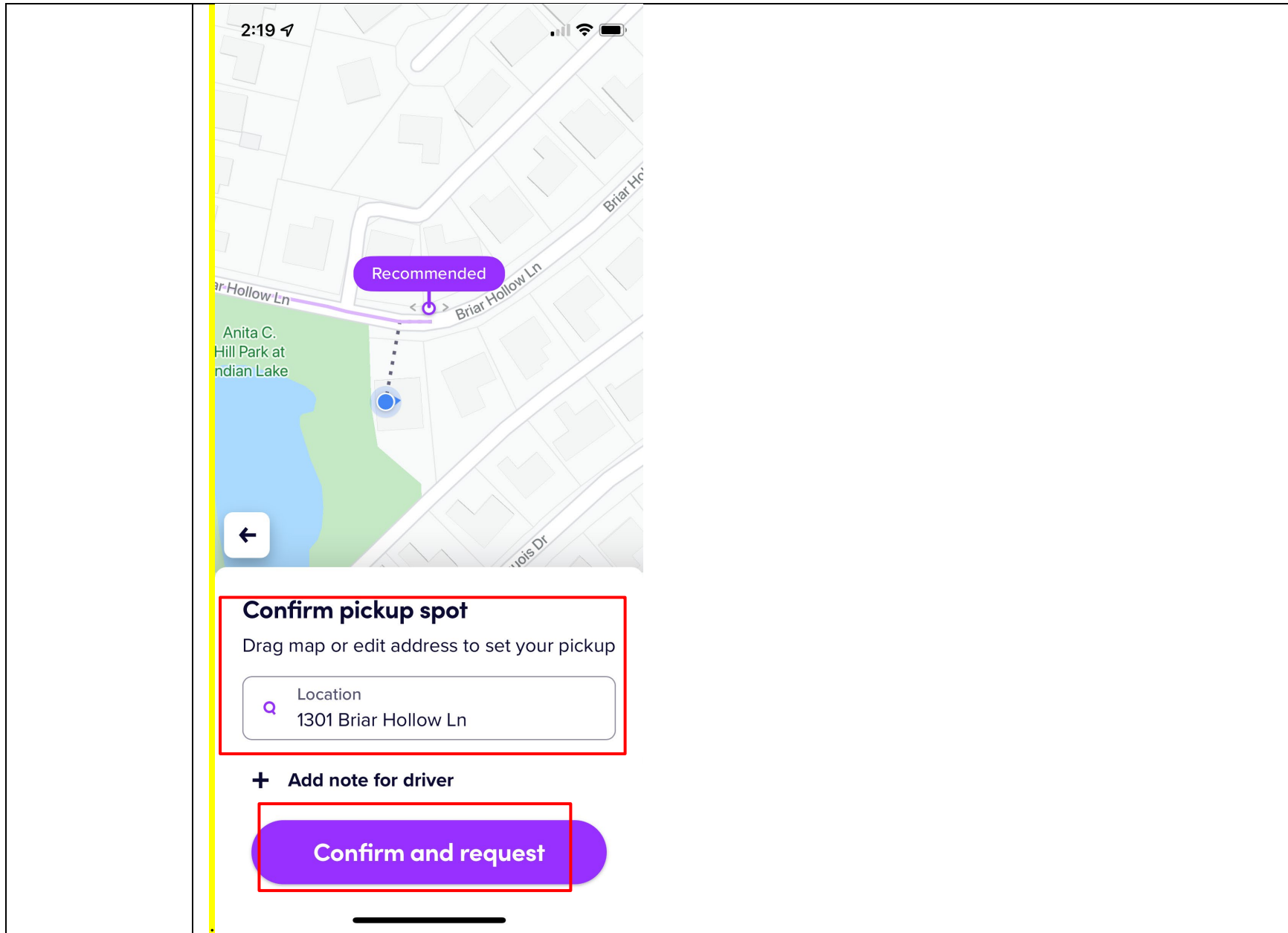

RESTRICTED CONFIDENTIAL SOURCE CODE

Attachment C for US Patent No. 10,299,100 Against Lyft Accused Products

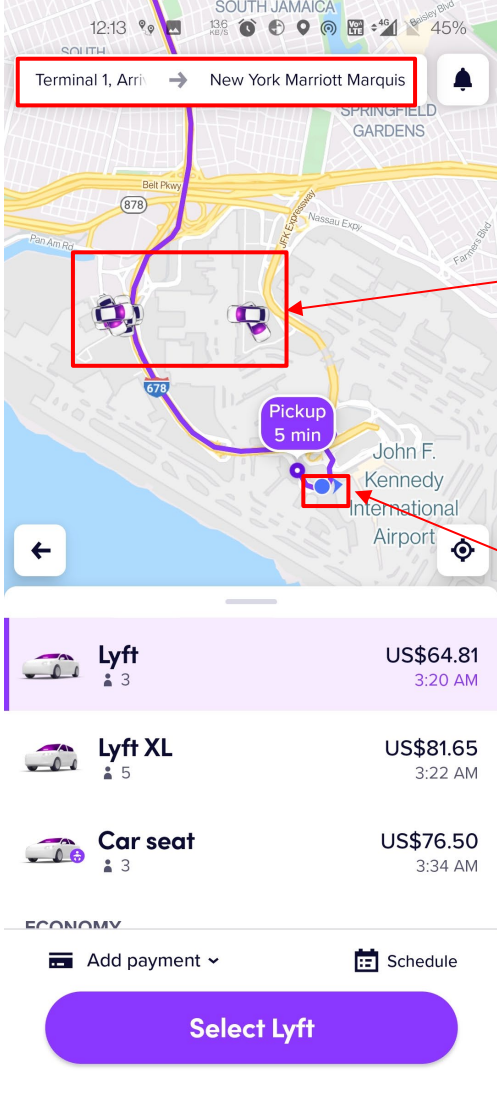
Claim 10,299,100	- Lyft's Accused Products												
	 <p>The screenshot displays the Lyft app interface. At the top, the route is set from 'Terminal 1, Arrivals' to 'New York Marriott Marquis'. The map shows the passenger's location at John F. Kennedy International Airport and several nearby drivers' locations. A 'Pickup 5 min' timer is shown. Below the map, three ride options are listed:</p> <table border="1"><thead><tr><th>Ride Type</th><th>Price</th><th>ETA</th></tr></thead><tbody><tr><td>Lyft</td><td>US\$64.81</td><td>3:20 AM</td></tr><tr><td>Lyft XL</td><td>US\$81.65</td><td>3:22 AM</td></tr><tr><td>Car seat</td><td>US\$76.50</td><td>3:34 AM</td></tr></tbody></table> <p>At the bottom, there is a 'Select Lyft' button.</p>	Ride Type	Price	ETA	Lyft	US\$64.81	3:20 AM	Lyft XL	US\$81.65	3:22 AM	Car seat	US\$76.50	3:34 AM
Ride Type	Price	ETA											
Lyft	US\$64.81	3:20 AM											
Lyft XL	US\$81.65	3:22 AM											
Car seat	US\$76.50	3:34 AM											

RESTRICTED CONFIDENTIAL SOURCE CODE

Attachment C for US Patent No. 10,299,100 Against Lyft Accused Products

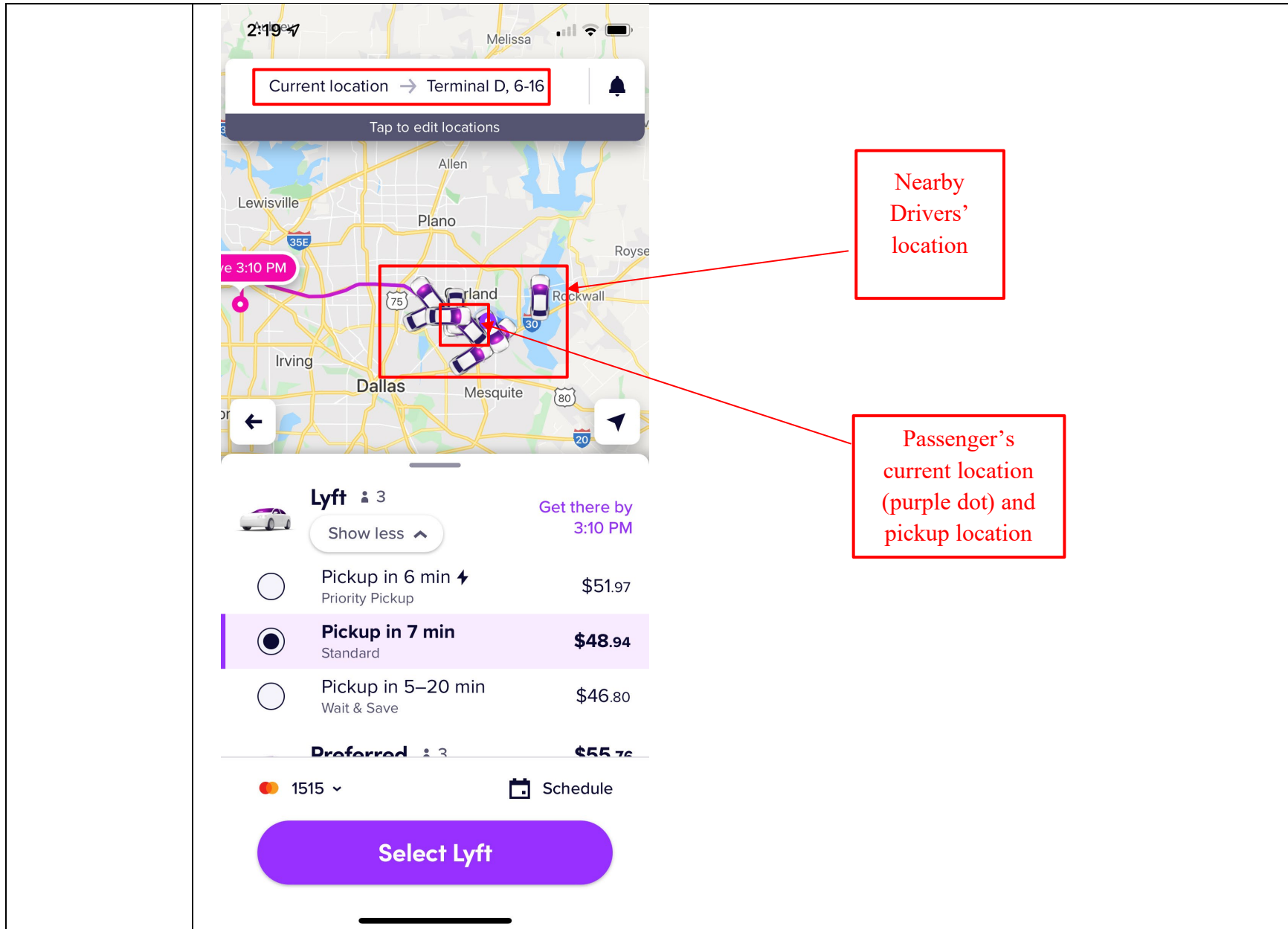

Nearby Drivers' location

Passenger's current location (purple dot) and pickup location

RESTRICTED CONFIDENTIAL SOURCE CODE**Attachment C for US Patent No. 10,299,100 Against Lyft Accused Products**

Claim 10,299,100	- Lyft's Accused Products
	Further, to the extent this element is performed at least in part by Lyft's software source code, AGIS reserves the right to supplement these contentions pursuant to production of such source code by Lyft and to the extent Lyft requires additional information in accordance with P.R. 3-1 and for any other reasons.
1[I]. responsive to user input, transmitting first information to a first vehicle of the one or more vehicles; and	<p>The Lyft Accused Products infringe directly and/or indirectly by performing, inducing others to perform, and/or contributing to the performance of: responsive to user input, transmitting first information to a first vehicle of the one or more vehicles.</p> <p>The Lyft app sends information regarding the pickup/stops/destination and/or information about the passenger and this information is communicated to a driver. For example, when a passenger requests a ride by providing a pickup location (current location of passenger or any specific location) and a destination address, the request ride message comprising the pickup location and the passenger's name and photo ("first information") is communicated to nearby drivers to find the ride.</p>

RESTRICTED CONFIDENTIAL SOURCE CODE

Attachment C for US Patent No. 10,299,100 Against Lyft Accused Products

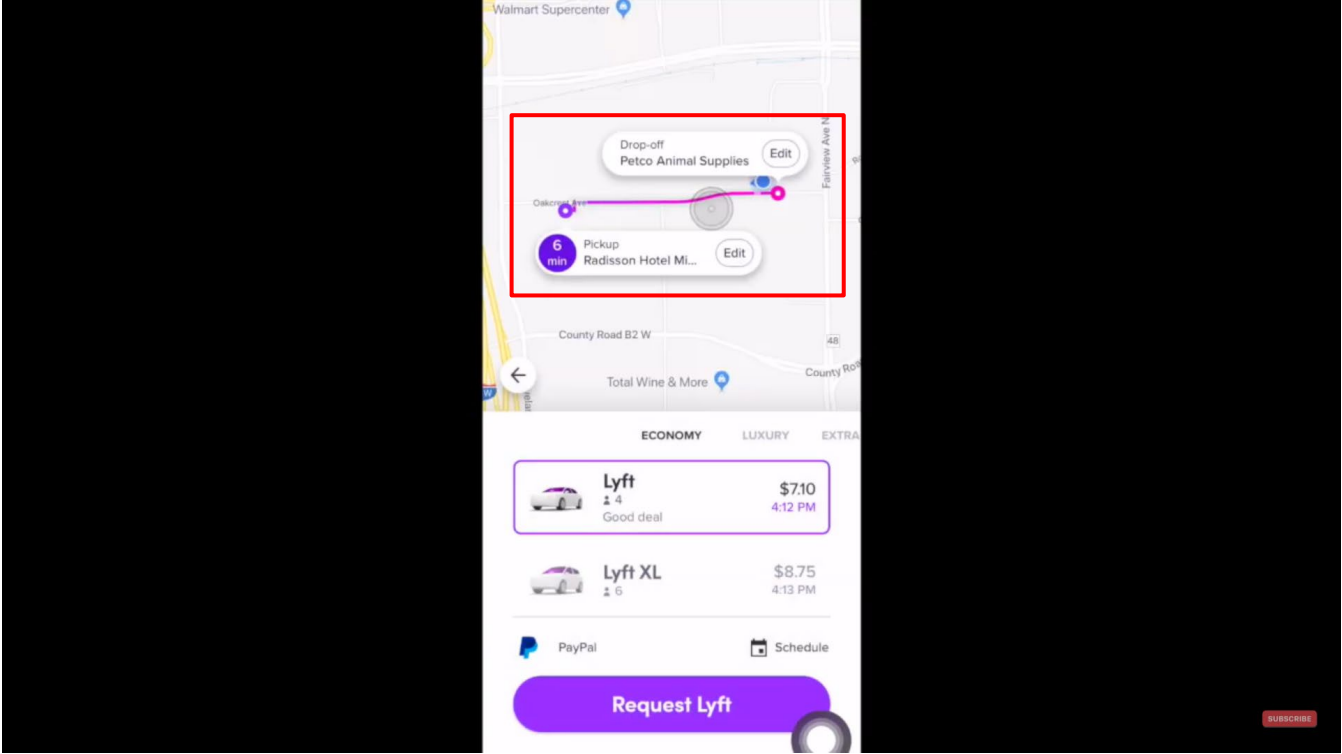
Claim 10,299,100	- Lyft's Accused Products
	 <p>https://www.youtube.com/watch?v=j0RDMLcmOgU at 3:49</p>

RESTRICTED CONFIDENTIAL SOURCE CODE

Attachment C for US Patent No. 10,299,100 Against Lyft Accused Products

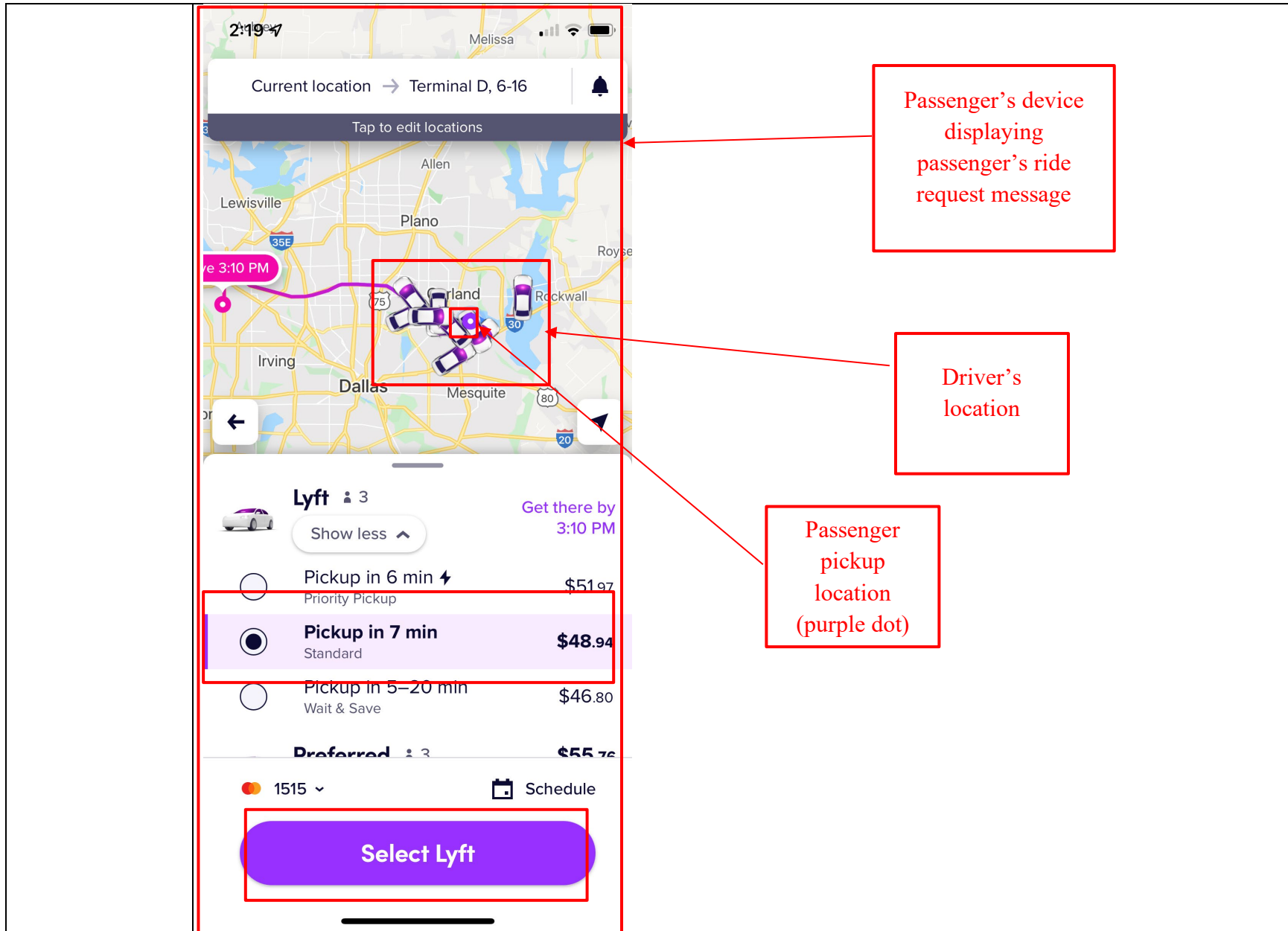

Passenger's device displaying passenger's ride request message

Driver's location

Passenger pickup location (purple dot)

RESTRICTED CONFIDENTIAL SOURCE CODE

Attachment C for US Patent No. 10,299,100 Against Lyft Accused Products

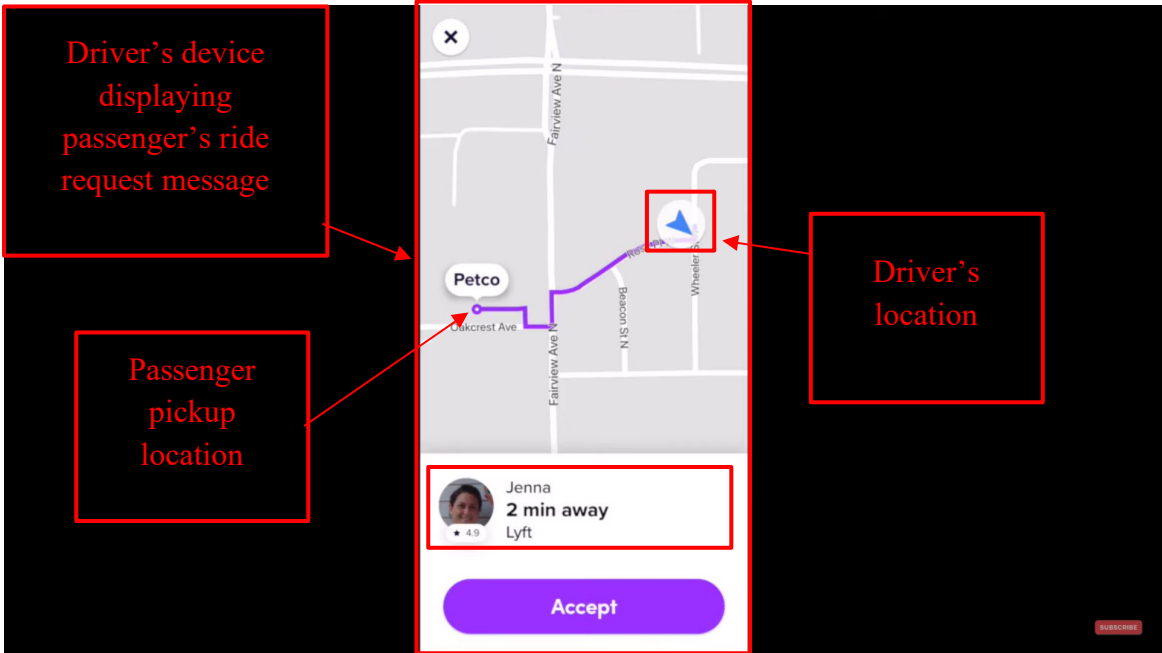
Claim 10,299,100	- Lyft's Accused Products
	 <p>The image is a screenshot of a Lyft driver's mobile application interface. It features a map with a purple route line starting from a pickup location (marked with a blue dot) and ending at a destination (marked with a blue dot). A driver's profile card is visible at the bottom, showing the driver's name 'Jenna', a rating of 4.9, and the text '2 min away Lyft'. A large purple 'Accept' button is positioned below the profile card. The screenshot is annotated with red boxes and arrows. Three red boxes on the left side contain the text: 'Driver's device displaying passenger's ride request message', 'Passenger pickup location', and 'Driver's location'. A fourth red box on the right side contains the text 'Driver's location'. Arrows point from these boxes to the corresponding elements on the screenshot. Below the screenshot, the URL https://www.youtube.com/watch?v=jVUy9poJDng is provided, followed by the text 'at 10:24, Annotated'.</p> <p>https://www.youtube.com/watch?v=jVUy9poJDng at 10:24, Annotated</p>

RESTRICTED CONFIDENTIAL SOURCE CODE

Attachment C for US Patent No. 10,299,100 Against Lyft Accused Products

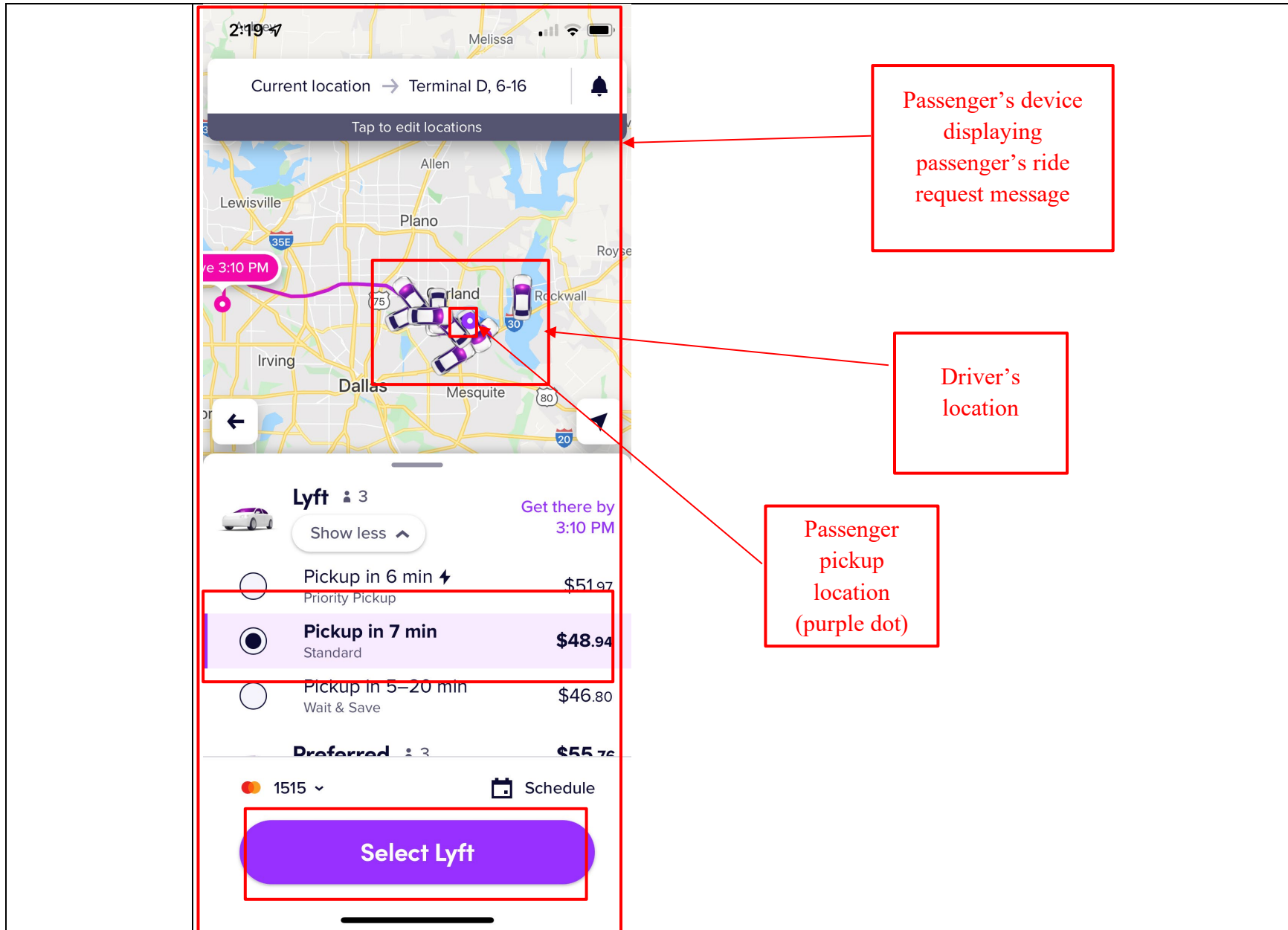

RESTRICTED CONFIDENTIAL SOURCE CODE**Attachment C for US Patent No. 10,299,100 Against Lyft Accused Products**

Claim 10,299,100	- Lyft's Accused Products
	Further, to the extent this element is performed at least in part by Lyft's software source code, AGIS reserves the right to supplement these contentions pursuant to production of such source code by Lyft and to the extent Lyft requires additional information in accordance with P.R. 3-1 and for any other reasons.
1[J]. receiving second information corresponding to the first vehicle and displaying the received second information on the display of the mobile device	<p>The Lyft Accused Products infringe directly and/or indirectly by performing, inducing others to perform, and/or contributing to the performance of: receiving second information corresponding to the first vehicle and displaying the received second information on the display of the mobile device.</p> <p>The Lyft app for the rider can receive and display information about the driver/vehicle. For example, when a driver accepts a ride request from a passenger, the passenger via the Lyft app receives the driver's information (such as name, location, vehicle model and vehicle number). .</p>

RESTRICTED CONFIDENTIAL SOURCE CODE

Attachment C for US Patent No. 10,299,100 Against Lyft Accused Products

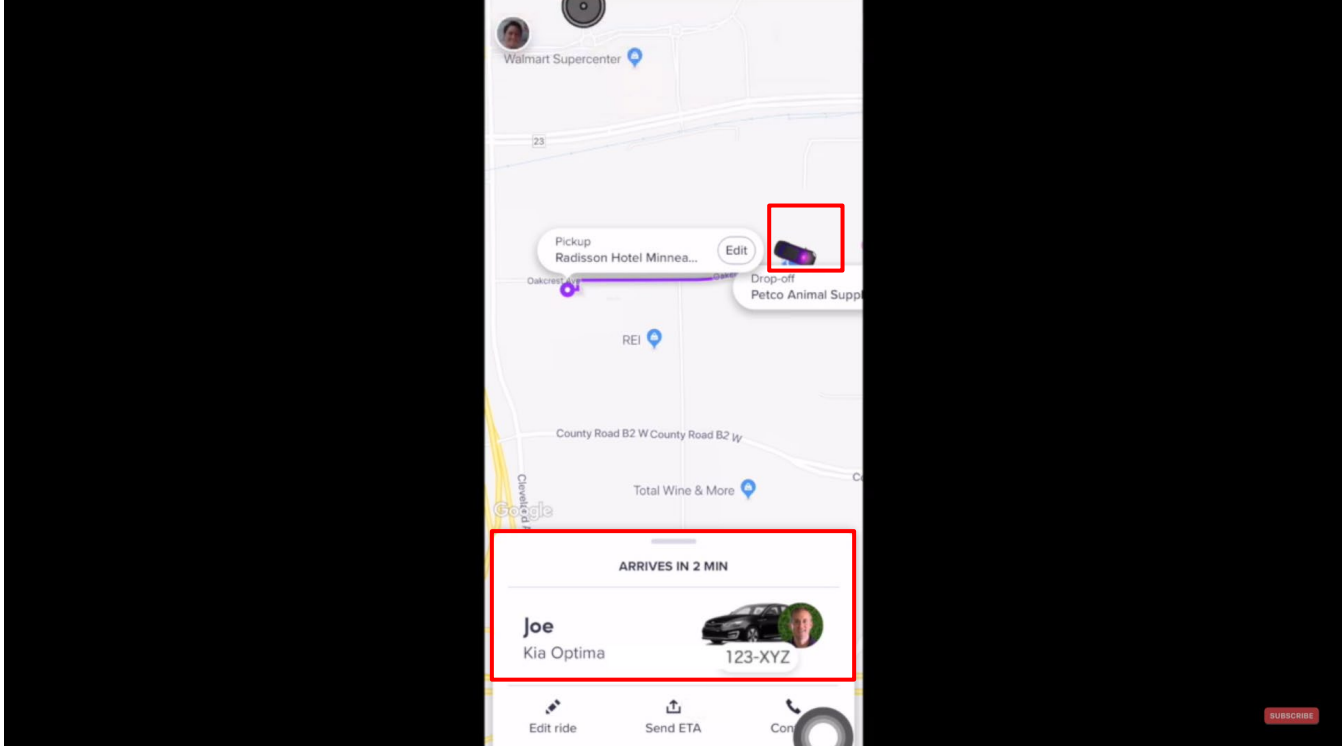
Claim 10,299,100	- Lyft's Accused Products
	 <p>https://www.youtube.com/watch?v=j0RDMLcmOgU at 5:07</p>

RESTRICTED CONFIDENTIAL SOURCE CODE

Attachment C for US Patent No. 10,299,100 Against Lyft Accused Products

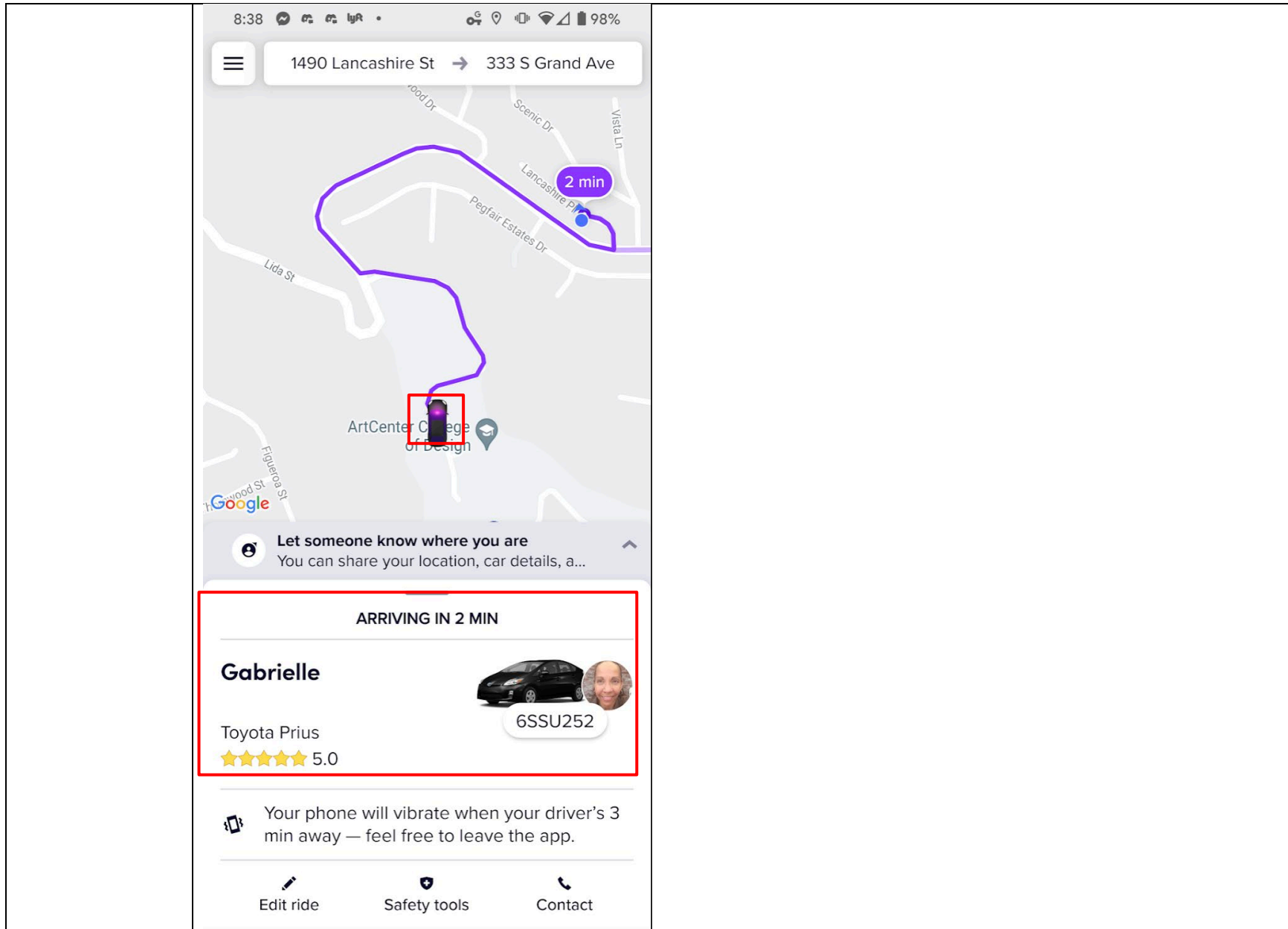

RESTRICTED CONFIDENTIAL SOURCE CODE

Attachment C for US Patent No. 10,299,100 Against Lyft Accused Products

Claim 10,299,100	- Lyft's Accused Products
<p>1[K]. wherein the mobile device does not have access to a phone number associated with a computing device corresponding to the first vehicle, an Internet Protocol (IP) address associated with the computing device corresponding to the first vehicle, and an e-mail address associated with the computing device corresponding to the first vehicle.</p>	<p>The Lyft Accused Products infringe directly and/or indirectly by performing, inducing others to perform, and/or contributing to the performance of: wherein the mobile device does not have access to a phone number associated with a computing device corresponding to the first vehicle, an Internet Protocol (IP) address associated with the computing device corresponding to the first vehicle, and an e-mail address associated with the computing device corresponding to the first vehicle.</p> <p>The Lyft app for the rider does not have access to the driver's phone number associated with the driver's account. The Lyft app for the rider also does not have access to the driver's email address or driver's IP address associated with the driver's device through the Lyft app. For example, the passenger does not have any information of the driver (such as email address, IP address, and contact number) and this information is not available through the Lyft app for the rider.</p>

RESTRICTED CONFIDENTIAL SOURCE CODE

Attachment C for US Patent No. 10,299,100 Against Lyft Accused Products

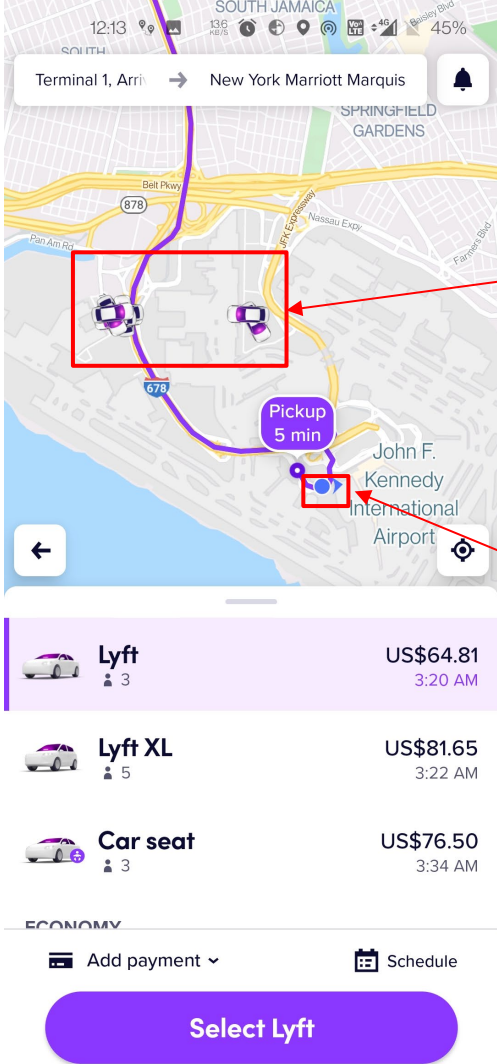
Claim 10,299,100	- Lyft's Accused Products												
	 <p>The screenshot displays the Lyft app interface. At the top, the map shows the route from Terminal 1, Arrivals to New York Marriott Marquis. A red box highlights two driver icons on the map, with a red arrow pointing to a text box labeled "Nearby Drivers' location". Another red box highlights the passenger location icon on the map, with a red arrow pointing to a text box labeled "Passenger's location". Below the map, a list of ride options is shown:</p> <table border="1"><thead><tr><th>Service</th><th>Price</th><th>Time</th></tr></thead><tbody><tr><td>Lyft (3 seats)</td><td>US\$64.81</td><td>3:20 AM</td></tr><tr><td>Lyft XL (5 seats)</td><td>US\$81.65</td><td>3:22 AM</td></tr><tr><td>Car seat (3 seats)</td><td>US\$76.50</td><td>3:34 AM</td></tr></tbody></table> <p>At the bottom, there are options for "Add payment" and "Schedule", and a large purple button labeled "Select Lyft".</p>	Service	Price	Time	Lyft (3 seats)	US\$64.81	3:20 AM	Lyft XL (5 seats)	US\$81.65	3:22 AM	Car seat (3 seats)	US\$76.50	3:34 AM
Service	Price	Time											
Lyft (3 seats)	US\$64.81	3:20 AM											
Lyft XL (5 seats)	US\$81.65	3:22 AM											
Car seat (3 seats)	US\$76.50	3:34 AM											

RESTRICTED CONFIDENTIAL SOURCE CODE

Attachment C for US Patent No. 10,299,100 Against Lyft Accused Products

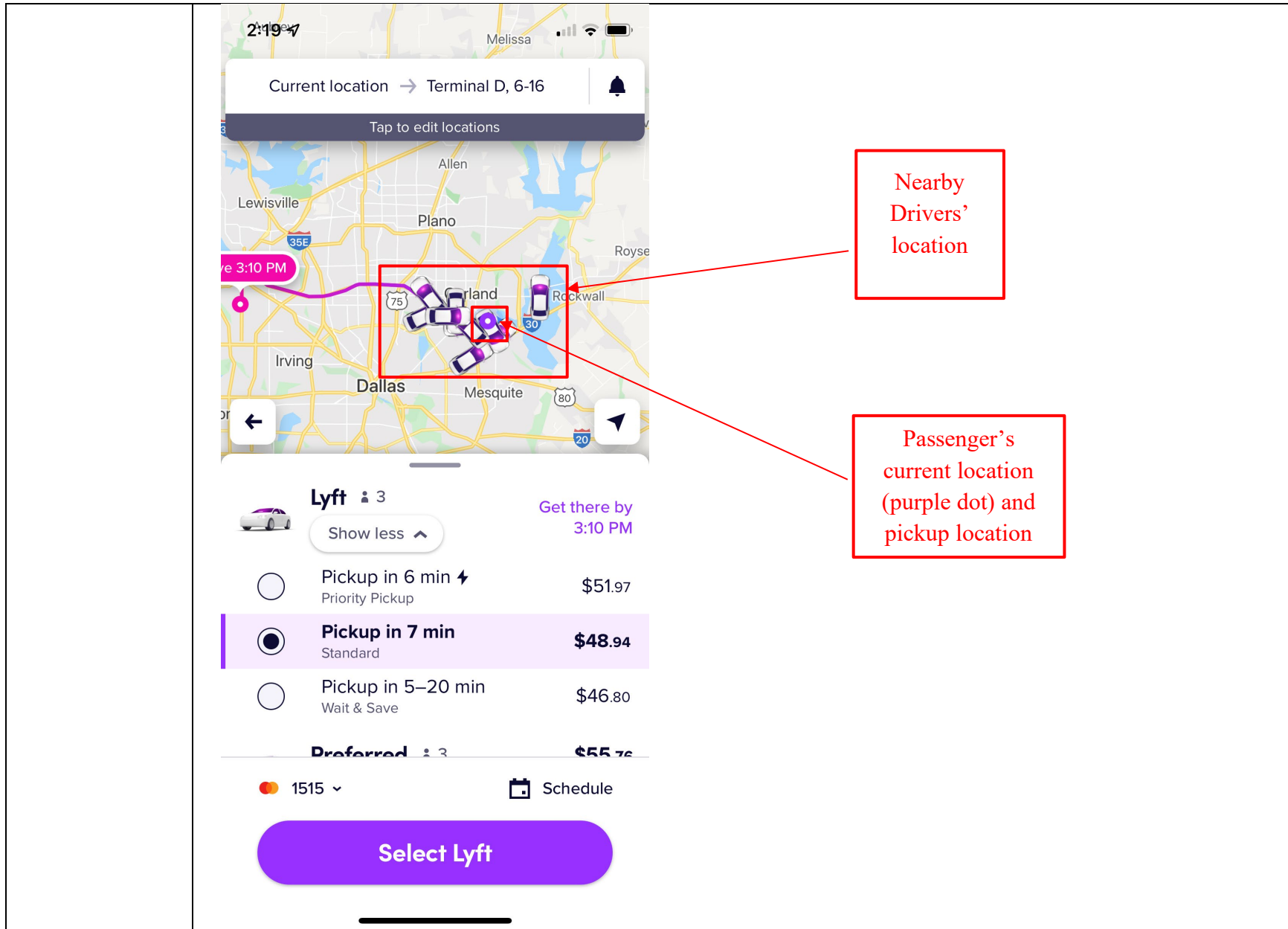

RESTRICTED CONFIDENTIAL SOURCE CODE

Attachment C for US Patent No. 10,299,100 Against Lyft Accused Products

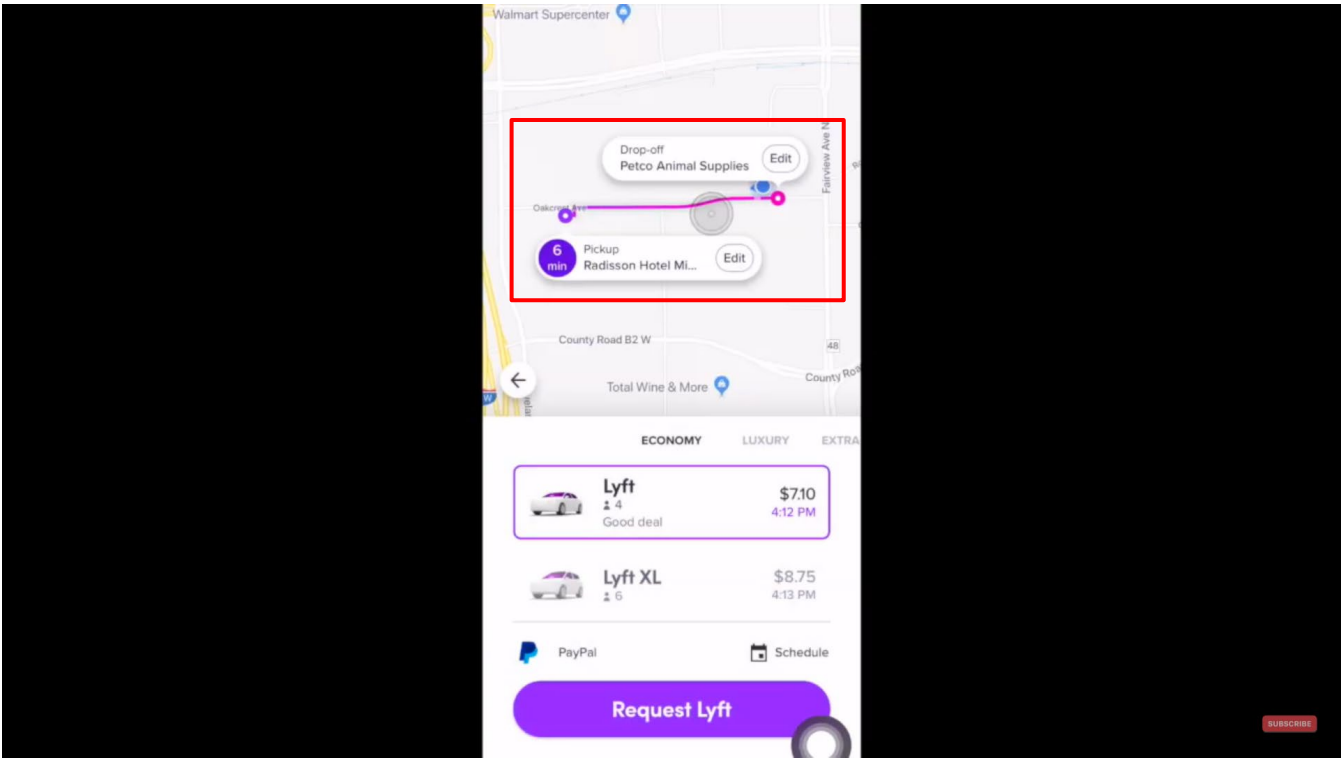
Claim 10,299,100	- Lyft's Accused Products
	 <p>https://www.youtube.com/watch?v=j0RDMLcmOgU at 3:49</p>

RESTRICTED CONFIDENTIAL SOURCE CODE

Attachment C for US Patent No. 10,299,100 Against Lyft Accused Products

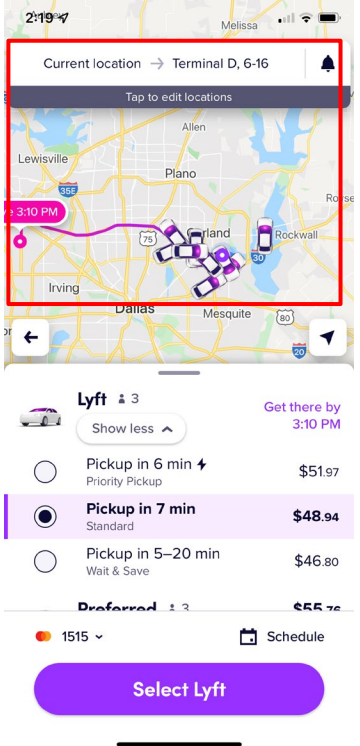
Claim 10,299,100	- Lyft's Accused Products
	
<p>2. The method of claim 1, wherein: determining the device location comprises obtaining geographical</p>	<p>The Lyft Accused Products infringe directly and/or indirectly by performing, inducing others to perform, and/or contributing to the performance of: The method of claim 1, wherein: determining the device location comprises obtaining geographical coordinates representing the geographical location of the mobile device from a global positioning system (GPS) receiver located within the mobile device; and marking the map further comprises placing the participant symbol at a position on the map corresponding to the geographical coordinates representing the geographical location of the mobile device.</p>

RESTRICTED CONFIDENTIAL SOURCE CODE**Attachment C for US Patent No. 10,299,100 Against Lyft Accused Products**

Claim 10,299,100	Lyft's Accused Products
<p>coordinates representing the geographical location of the mobile device from a global positioning system (GPS) receiver located within the mobile device; and marking the map further comprises placing the participant symbol at a position on the map corresponding to the geographical coordinates representing the geographical location of the mobile device.</p>	<p>See claims 1[C] and 1[F] above.</p> <p>Further, the Lyft app meets this limitation because it can receive GPS data to determine a location and use that location to place a symbol at the location on the map. The location is provided in coordinates.</p>

RESTRICTED CONFIDENTIAL SOURCE CODE

Attachment C for US Patent No. 10,299,100 Against Lyft Accused Products

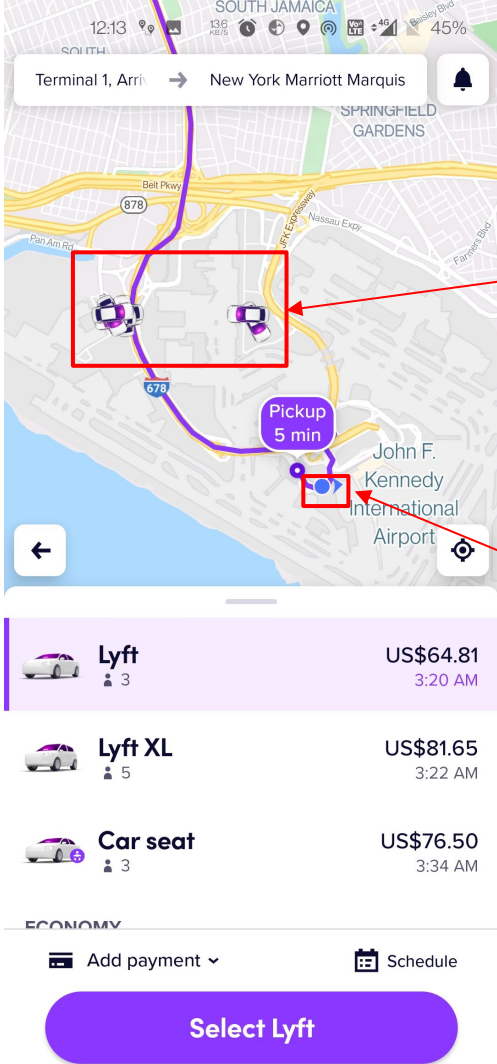
Claim 10,299,100	- Lyft's Accused Products												
	 <p>The screenshot displays the Lyft app interface. At the top, the destination is set to "New York Marriott Marquis" starting from "Terminal 1, Arrivals". The map shows the area around JFK Airport, with a red box highlighting two nearby driver icons. A red box also highlights the passenger's location icon at the airport. Below the map, a list of ride options is shown:</p> <table border="1"><thead><tr><th>Service</th><th>Price</th><th>Time</th></tr></thead><tbody><tr><td>Lyft (3 seats)</td><td>US\$64.81</td><td>3:20 AM</td></tr><tr><td>Lyft XL (5 seats)</td><td>US\$81.65</td><td>3:22 AM</td></tr><tr><td>Car seat (3 seats)</td><td>US\$76.50</td><td>3:34 AM</td></tr></tbody></table> <p>At the bottom, there are options to "Add payment" and "Schedule", and a large purple "Select Lyft" button.</p>	Service	Price	Time	Lyft (3 seats)	US\$64.81	3:20 AM	Lyft XL (5 seats)	US\$81.65	3:22 AM	Car seat (3 seats)	US\$76.50	3:34 AM
Service	Price	Time											
Lyft (3 seats)	US\$64.81	3:20 AM											
Lyft XL (5 seats)	US\$81.65	3:22 AM											
Car seat (3 seats)	US\$76.50	3:34 AM											

RESTRICTED CONFIDENTIAL SOURCE CODE

Attachment C for US Patent No. 10,299,100 Against Lyft Accused Products

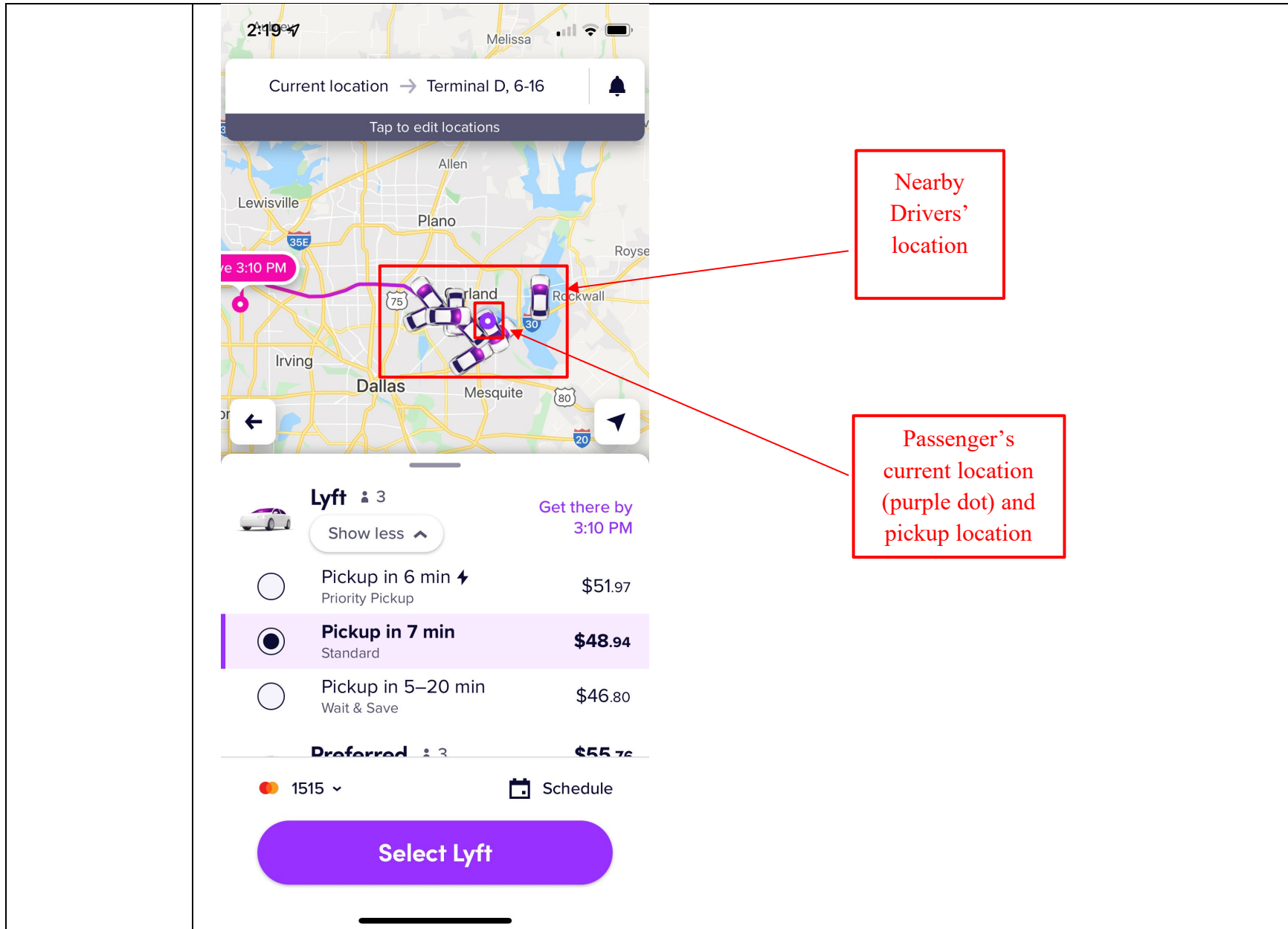

RESTRICTED CONFIDENTIAL SOURCE CODE**Attachment C for US Patent No. 10,299,100 Against Lyft Accused Products**

Claim 10,299,100	- Lyft's Accused Products
	<p data-bbox="457 354 1625 537">You must have seen that every Android and iOS device in today's age comes with GPS right inside it. This is one feature that will be there in every smartphone no matter what the price of that device might be. And that is because of the fact that GPS is the most basic yet most useful feature on every smartphone.</p> <p data-bbox="457 581 1650 857">Just for information, the GPS stands for Global Positioning System and it provides accurate geolocation and time information for every equipment that is equipped with a GPS receiver. Now, the best example of using GPS is with services such as Google Maps, Apple Maps, and others where you can see where exactly you are right now on the Map. This is thanks to the GPS receiver which sends a signal to the GPS satellite.</p> <p data-bbox="457 867 1402 899">https://www.cashify.in/how-to-turn-off-gps-on-any-android-or-ios-device</p>
<p data-bbox="201 979 432 1365">3. The method of claim 1, wherein transmitting the first information to the first vehicle comprises sending data comprising at least one of the identifier and the</p>	<p data-bbox="453 979 1890 1084">The Lyft Accused Products infringe directly and/or indirectly by performing, inducing others to perform, and/or contributing to the performance of: transmitting the first information to the first vehicle comprises sending data comprising at least one of the identifier and the device location to a server.</p> <p data-bbox="453 1198 1890 1268">See claim 1[B] above. In addition, the Lyft app meets this limitation because it communicates the account/identity information and location to the Lyft server. This can occur during the request or during the ride.</p>

RESTRICTED CONFIDENTIAL SOURCE CODE

Attachment C for US Patent No. 10,299,100 Against Lyft Accused Products

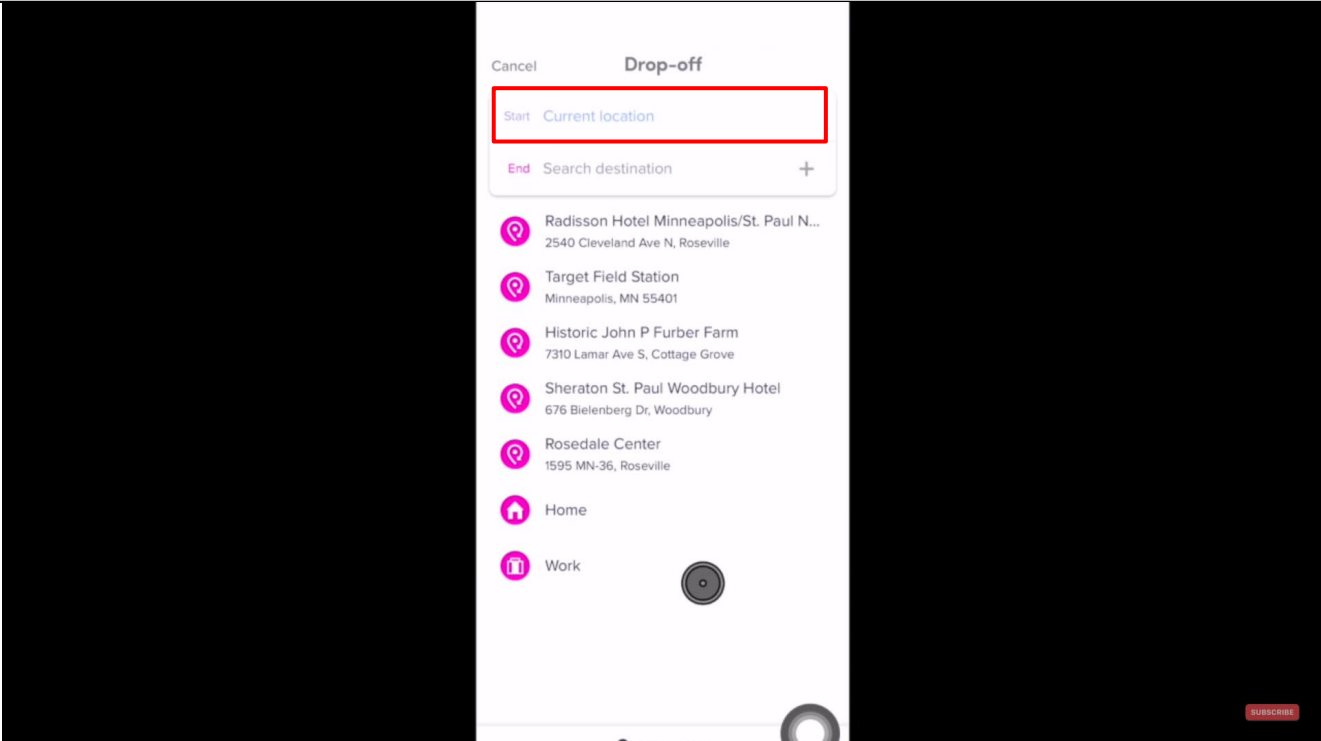
Claim 10,299,100	- Lyft's Accused Products
device location to a server.	 <p>https://www.youtube.com/watch?v=j0RDMLcmOgU at 3:27</p>

RESTRICTED CONFIDENTIAL SOURCE CODE

Attachment C for US Patent No. 10,299,100 Against Lyft Accused Products

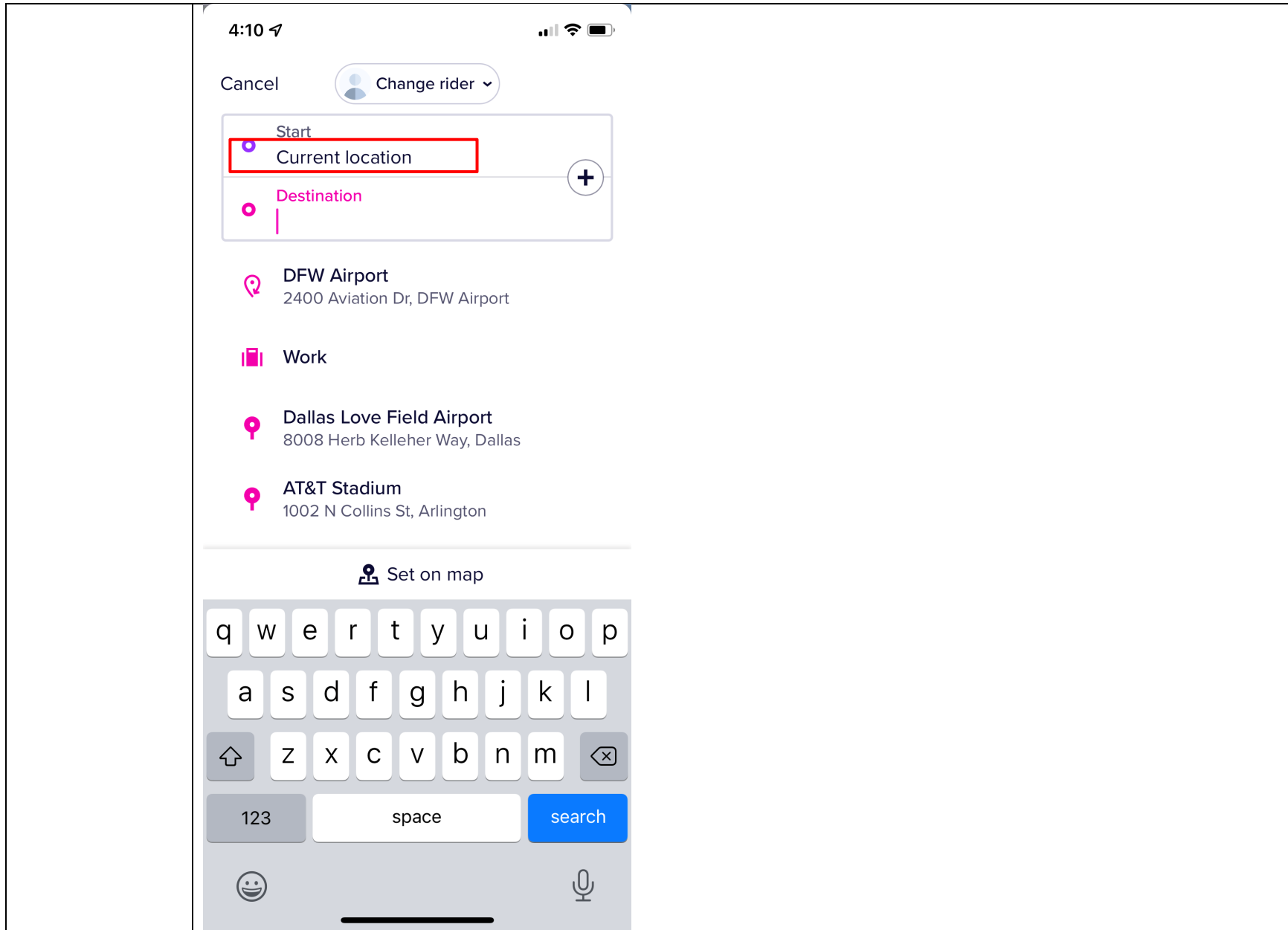

RESTRICTED CONFIDENTIAL SOURCE CODE

Attachment C for US Patent No. 10,299,100 Against Lyft Accused Products

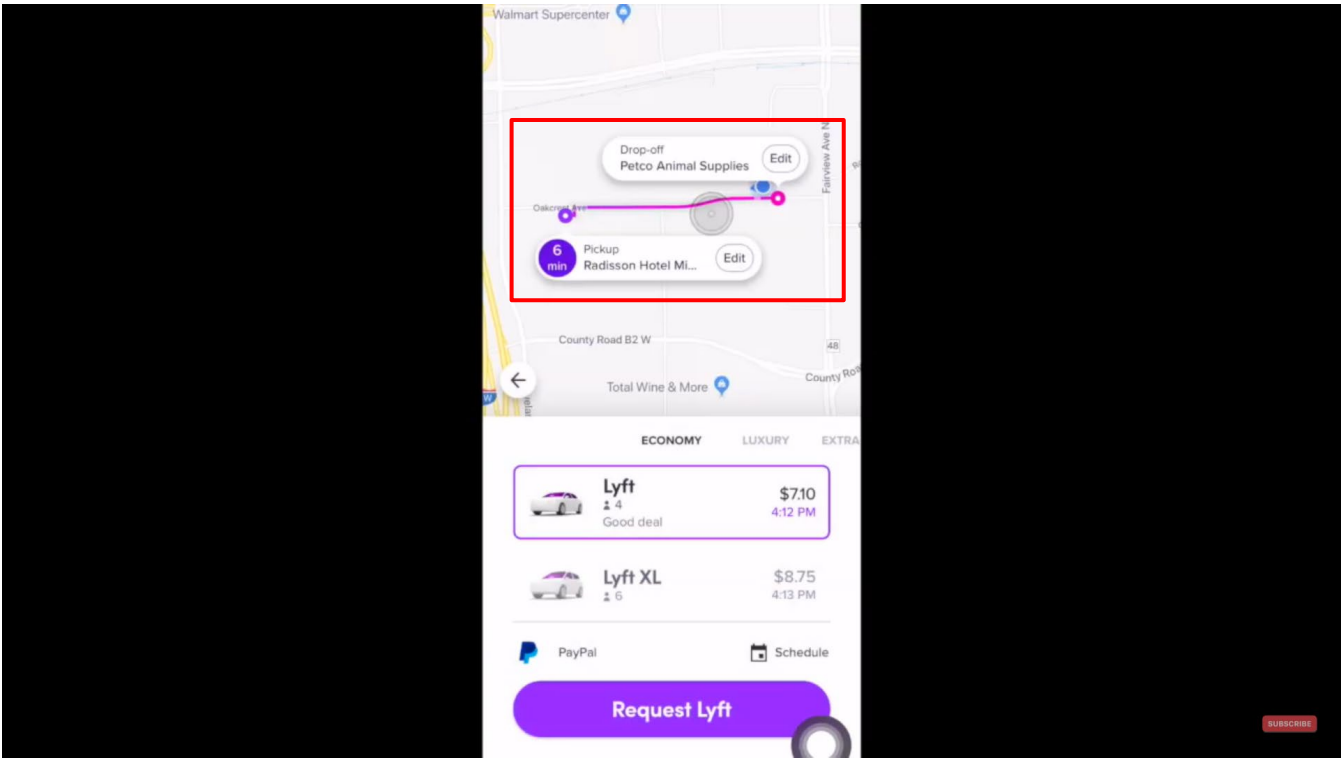
Claim 10,299,100	- Lyft's Accused Products
	 <p>https://www.youtube.com/watch?v=j0RDMLcmOgU at 3:49</p>

RESTRICTED CONFIDENTIAL SOURCE CODE

Attachment C for US Patent No. 10,299,100 Against Lyft Accused Products

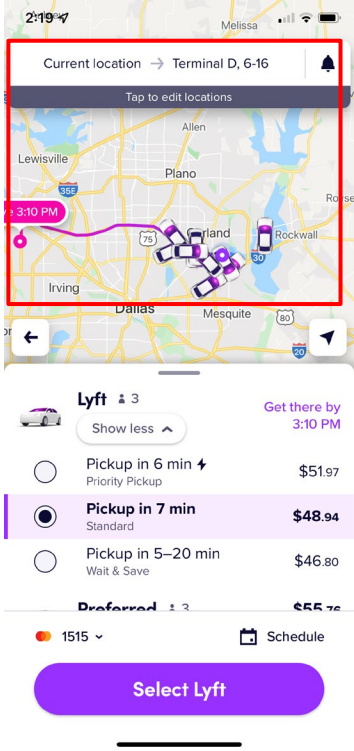
Claim 10,299,100	- Lyft's Accused Products
	 <p>The screenshot displays the Lyft mobile application interface. At the top, the current location is set to 'Terminal D, 6-16'. Below this, a map shows the Dallas area with a pink route line and a '3:10 PM' arrival time. The interface lists three pickup options: 'Priority Pickup' (6 min, \$51.97), 'Standard' (7 min, \$48.94), and 'Wait & Save' (5-20 min, \$46.80). A 'Preferred' section is partially visible below, showing a price of \$55.76. At the bottom, there is a 'Select Lyft' button and a 'Schedule' option.</p>

RESTRICTED CONFIDENTIAL SOURCE CODE

Attachment C for US Patent No. 10,299,100 Against Lyft Accused Products

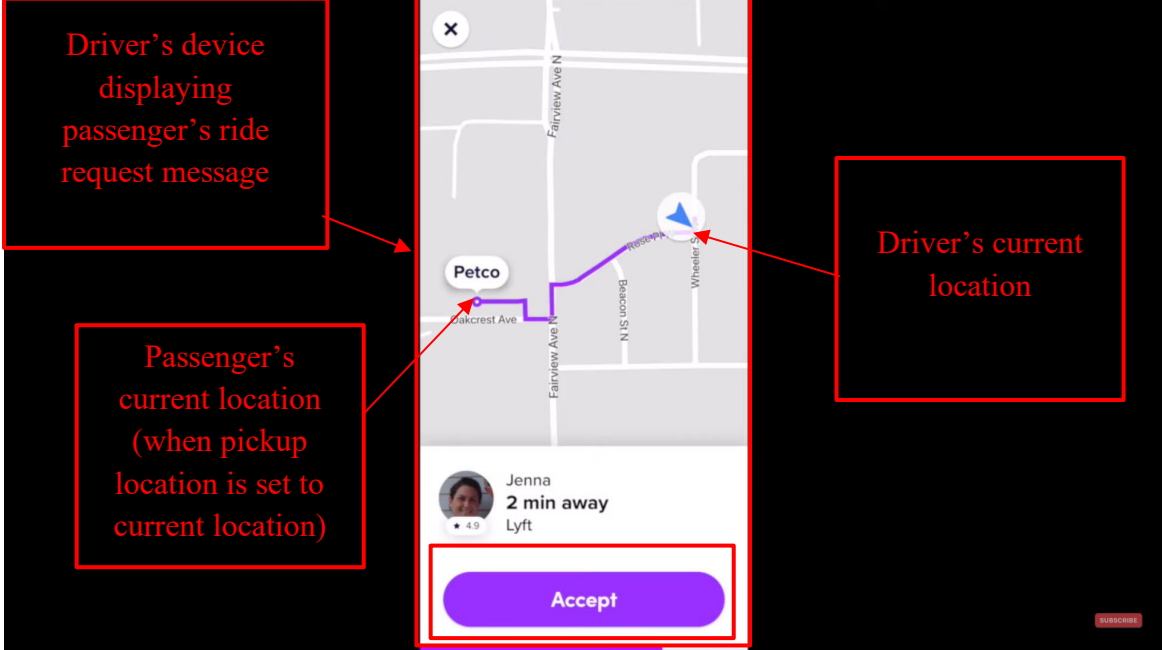
Claim 10,299,100	- Lyft's Accused Products
	 <p>The screenshot shows a Lyft ride request notification on a mobile device. The notification includes a map showing the pickup location (Petco) and the driver's current location. The driver's name is Jenna, and the estimated time to arrival is 2 minutes. A purple 'Accept' button is visible at the bottom of the notification. Three red boxes with arrows point to specific elements: one to the map area, one to the driver's current location on the map, and one to the 'Accept' button.</p> <p>Driver's device displaying passenger's ride request message</p> <p>Passenger's current location (when pickup location is set to current location)</p> <p>Driver's current location</p> <p>https://www.youtube.com/watch?v=jVUy9poJDng at 10:24, Annotated</p>

RESTRICTED CONFIDENTIAL SOURCE CODE

Attachment C for US Patent No. 10,299,100 Against Lyft Accused Products

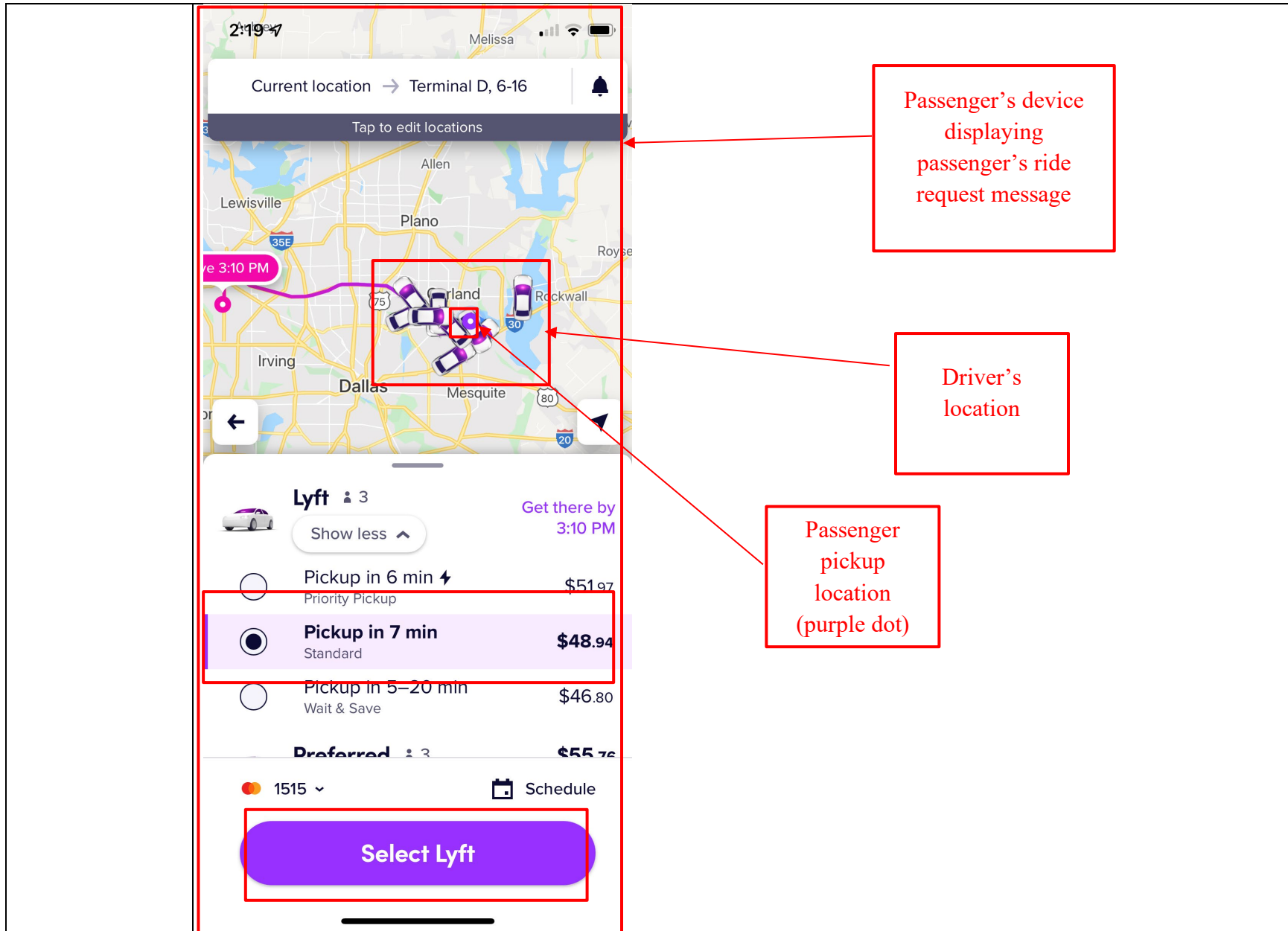

RESTRICTED CONFIDENTIAL SOURCE CODE

Attachment C for US Patent No. 10,299,100 Against Lyft Accused Products

Claim 10,299,100	Lyft's Accused Products
<p>4. The method of claim 1, further comprising updating the map by updating at least one item selected from the group consisting of: a position of the participant symbol, positions of the one or more vehicle symbols, and a portion of the map displayed on the display of the mobile device.</p>	<p>The Lyft Accused Products infringe directly and/or indirectly by performing, inducing others to perform, and/or contributing to the performance of: updating the map by updating at least one item selected from the group consisting of: a position of the participant symbol, positions of the one or more vehicle symbols, and a portion of the map displayed on the display of the mobile device.</p> <p>See claim 1[F] above. In addition, the Lyft app meets this limitation because it can update the location of the rider or participant and the app can update the map. The map is updated with updated locations or new areas. For example, the Lyft app updates the map with the passenger's current location coordinates and the nearby drivers' location corresponding to their respective location coordinates. The map portion, such as the tiles or overlays (such as routes), can be updated in response to interactions with the map, change of time/orientation, zoom, pan, and/or user input or automatic input to the Lyft app from the user or Lyft server.</p>

RESTRICTED CONFIDENTIAL SOURCE CODE

Attachment C for US Patent No. 10,299,100 Against Lyft Accused Products

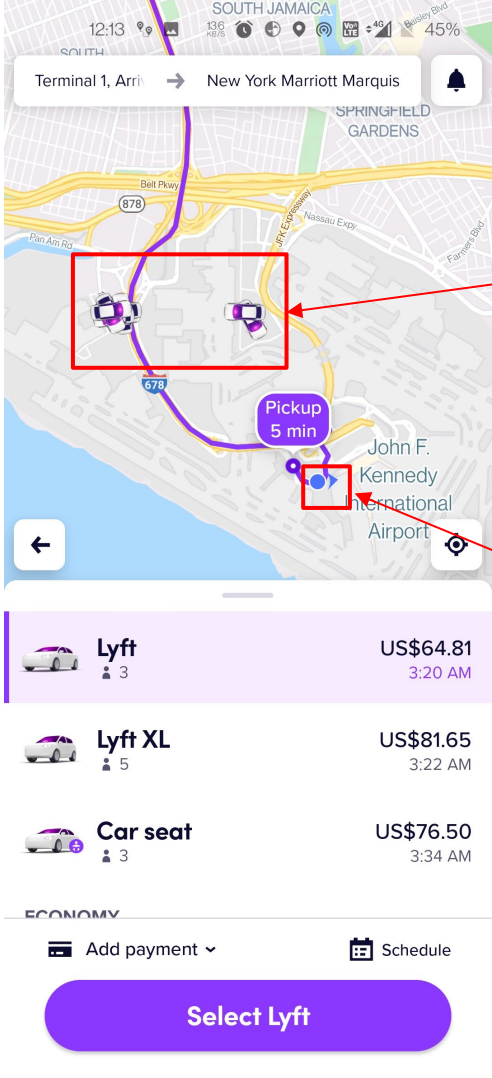
Claim 10,299,100	- Lyft's Accused Products												
	 <p>The screenshot shows the Lyft app interface. At the top, the map displays the route from Terminal 1, Arrivals to New York Marriott Marquis. A red box highlights two nearby driver icons on the map, with a red arrow pointing to a text box labeled "Nearby Drivers' location". Another red box highlights the passenger's location at John F. Kennedy International Airport, with a red arrow pointing to a text box labeled "Passenger's location". Below the map, the ride options are listed:</p> <table border="1"><thead><tr><th>Option</th><th>Price</th><th>Time</th></tr></thead><tbody><tr><td>Lyft (3 seats)</td><td>US\$64.81</td><td>3:20 AM</td></tr><tr><td>Lyft XL (5 seats)</td><td>US\$81.65</td><td>3:22 AM</td></tr><tr><td>Car seat (3 seats)</td><td>US\$76.50</td><td>3:34 AM</td></tr></tbody></table> <p>At the bottom, there is a purple button labeled "Select Lyft".</p>	Option	Price	Time	Lyft (3 seats)	US\$64.81	3:20 AM	Lyft XL (5 seats)	US\$81.65	3:22 AM	Car seat (3 seats)	US\$76.50	3:34 AM
Option	Price	Time											
Lyft (3 seats)	US\$64.81	3:20 AM											
Lyft XL (5 seats)	US\$81.65	3:22 AM											
Car seat (3 seats)	US\$76.50	3:34 AM											

RESTRICTED CONFIDENTIAL SOURCE CODE

Attachment C for US Patent No. 10,299,100 Against Lyft Accused Products

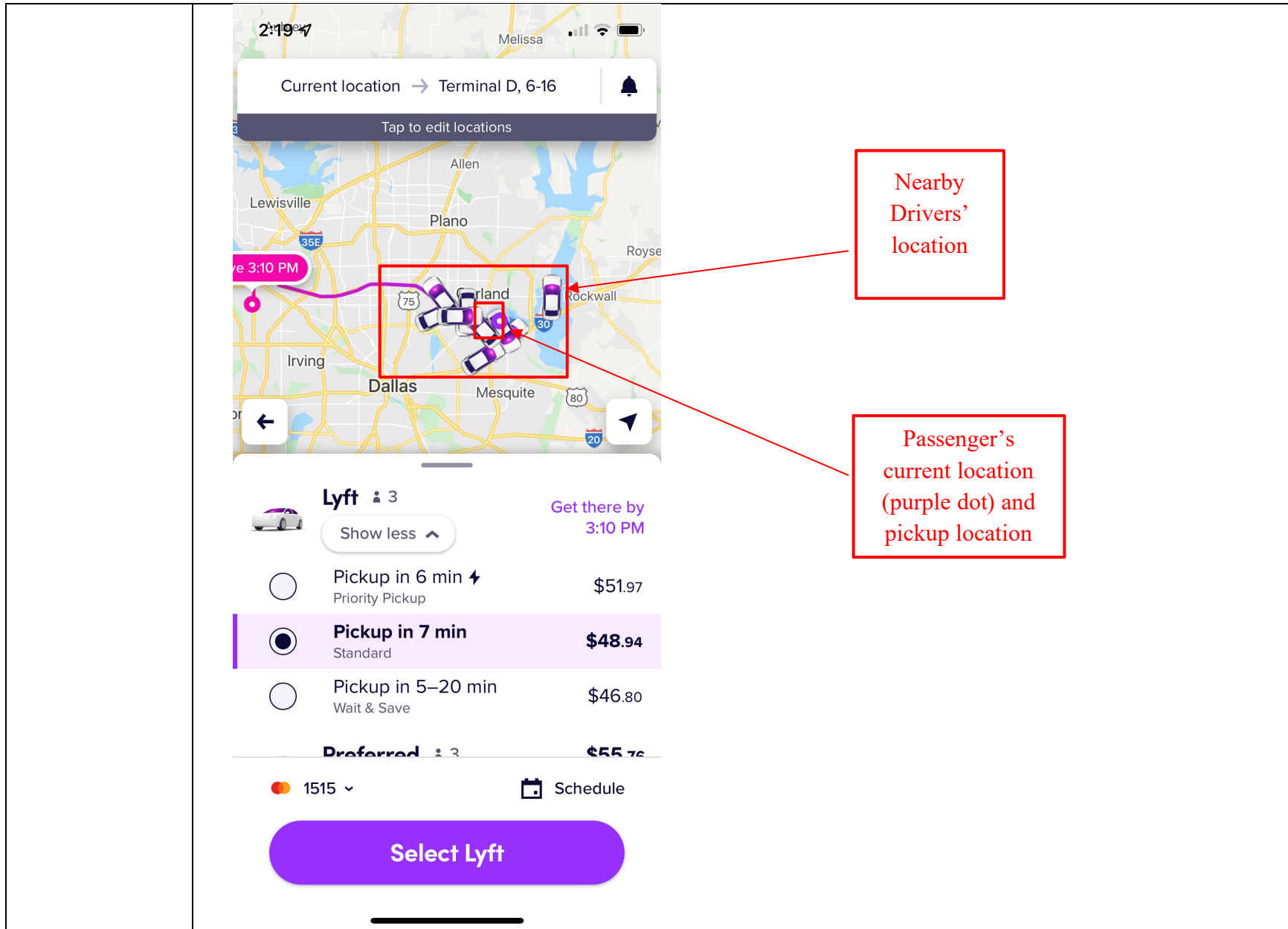

RESTRICTED CONFIDENTIAL SOURCE CODE**Attachment C for US Patent No. 10,299,100 Against Lyft Accused Products**

Claim 10,299,100	- Lyft's Accused Products
<p>5. The method of claim 1, further comprising: receiving, from a server, updated respective vehicle locations of the one or more vehicles; and updating, based on the received updated vehicle locations and the coordinate translation data, positions of the one or more vehicle symbols on the map.</p>	<p>Every Lyft Accused Product infringes directly and/or indirectly by performing, inducing others to perform, and/or contributing to the performance of: receiving, from a server, updated respective vehicle locations of the one or more vehicles; and updating, based on the received updated vehicle locations and the coordinate translation data, positions of the one or more vehicle symbols on the map.</p> <p>See claims 1[F] and 4 above. Further, the Lyft app meets this limitation because the locations can be updated based on data received from the Lyft server and the locations presented on the map can be updated based on that data from the server. For example, the Lyft server updates the map in the Lyft app with the nearby drivers' location (vehicle icons) corresponding to their respective location coordinates.</p>

RESTRICTED CONFIDENTIAL SOURCE CODE

Attachment C for US Patent No. 10,299,100 Against Lyft Accused Products

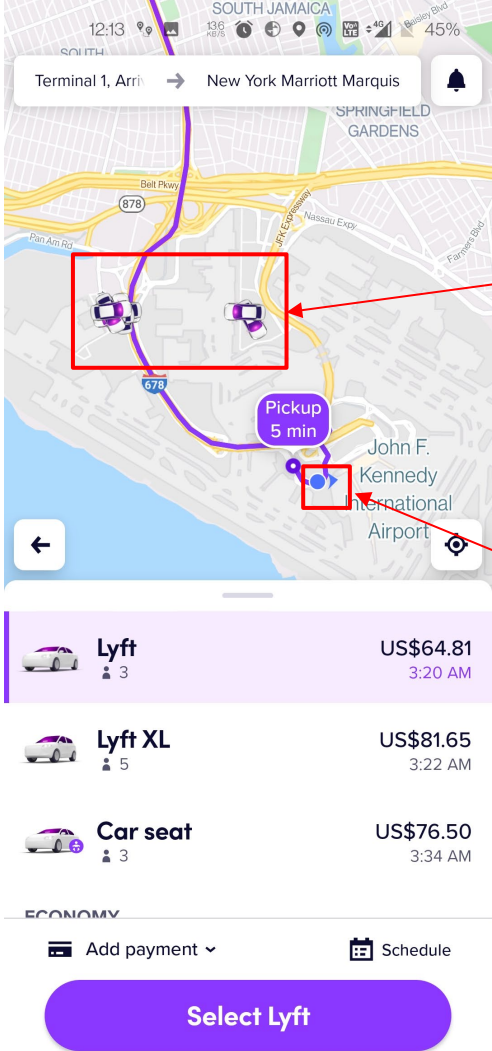
Claim 10,299,100	- Lyft's Accused Products												
	 <p>The screenshot shows the Lyft app interface. At the top, the map displays the route from Terminal 1, Arrivals to New York Marriott Marquis. A red box highlights two nearby driver locations on the map. Another red box highlights the passenger's location at John F. Kennedy International Airport. Below the map, a list of ride options is shown:</p> <table border="1"><thead><tr><th>Ride Type</th><th>Price</th><th>Time</th></tr></thead><tbody><tr><td>Lyft (3 seats)</td><td>US\$64.81</td><td>3:20 AM</td></tr><tr><td>Lyft XL (5 seats)</td><td>US\$81.65</td><td>3:22 AM</td></tr><tr><td>Car seat (3 seats)</td><td>US\$76.50</td><td>3:34 AM</td></tr></tbody></table> <p>At the bottom, there are options to 'Add payment' and 'Schedule', and a large purple button labeled 'Select Lyft'.</p>	Ride Type	Price	Time	Lyft (3 seats)	US\$64.81	3:20 AM	Lyft XL (5 seats)	US\$81.65	3:22 AM	Car seat (3 seats)	US\$76.50	3:34 AM
Ride Type	Price	Time											
Lyft (3 seats)	US\$64.81	3:20 AM											
Lyft XL (5 seats)	US\$81.65	3:22 AM											
Car seat (3 seats)	US\$76.50	3:34 AM											

RESTRICTED CONFIDENTIAL SOURCE CODE

Attachment C for US Patent No. 10,299,100 Against Lyft Accused Products

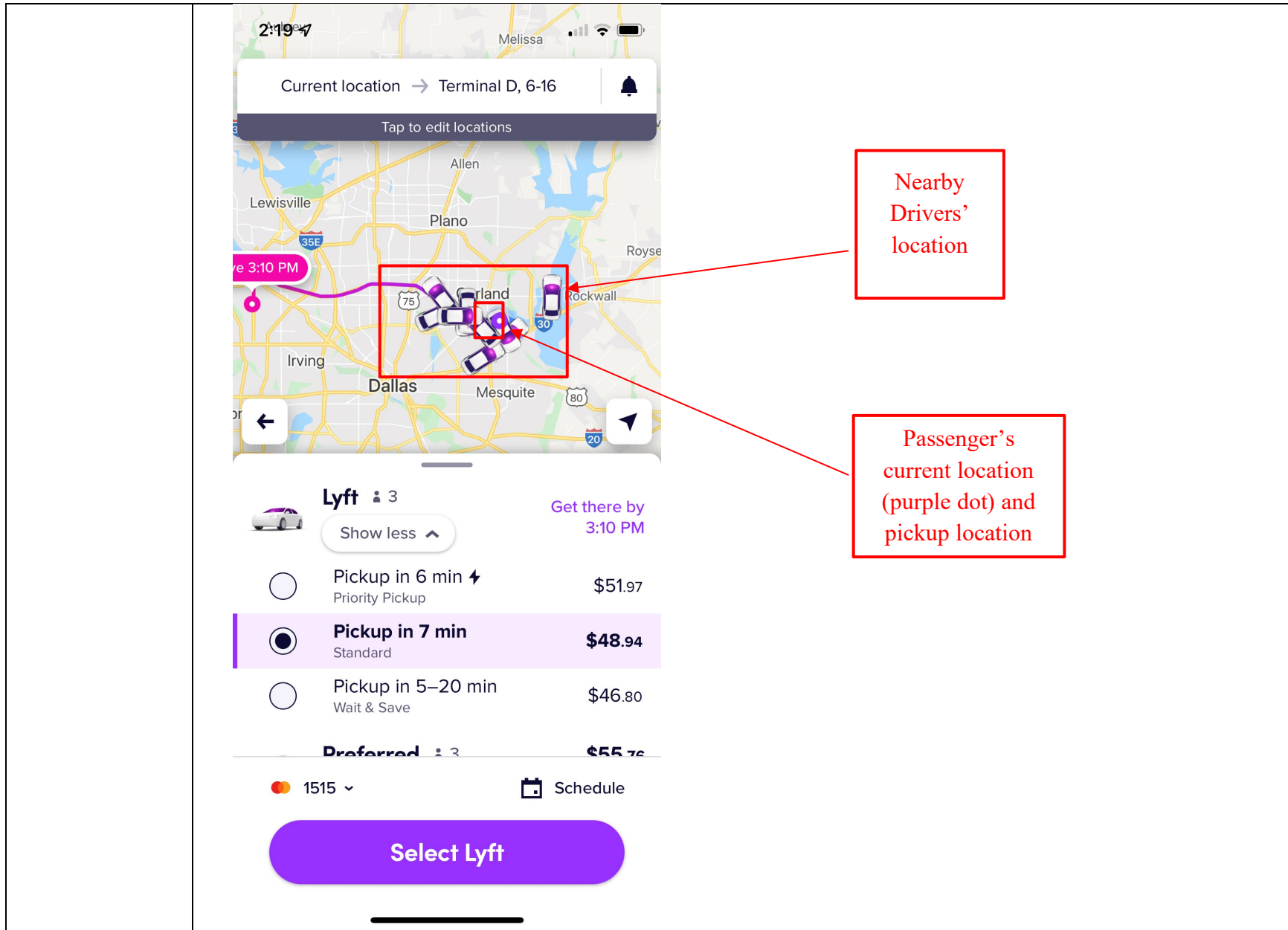

RESTRICTED CONFIDENTIAL SOURCE CODE**Attachment C for US Patent No. 10,299,100 Against Lyft Accused Products**

Claim 10,299,100	- Lyft's Accused Products
<p>6. The method of claim 1, further comprising: receiving, from a GPS receiver, updated device locations; and updating, based on the received device locations and the coordinate translation data, a position of the participant symbol on the map.</p>	<p>The Lyft Accused Products infringe directly and/or indirectly by performing, inducing others to perform, and/or contributing to the performance of receiving, from a GPS receiver, updated device locations and updated, based on the received device locations and the coordinate translation data, a position of the participant symbol on the map.</p> <p><i>See Claims 1 and 2 above.</i></p>
<p>7. The method of claim 1, wherein the received second information is sent by the computing device corresponding to</p>	<p>The Lyft Accused Products infringe directly and/or indirectly by performing, inducing others to perform, and/or contributing to the performance of the received second information is sent by the computing device corresponding to the first vehicle based on at least one criterion selected from the group consisting of: (1) passage of time, and (2) movement of the first vehicle.</p> <p><i>See claim 1. In addition, the Lyft app meets this limitation because it can update the location of the vehicle including location information or ETA or status information about the driver/vehicle. For example, vehicle</i></p>

RESTRICTED CONFIDENTIAL SOURCE CODE

Attachment C for US Patent No. 10,299,100 Against Lyft Accused Products

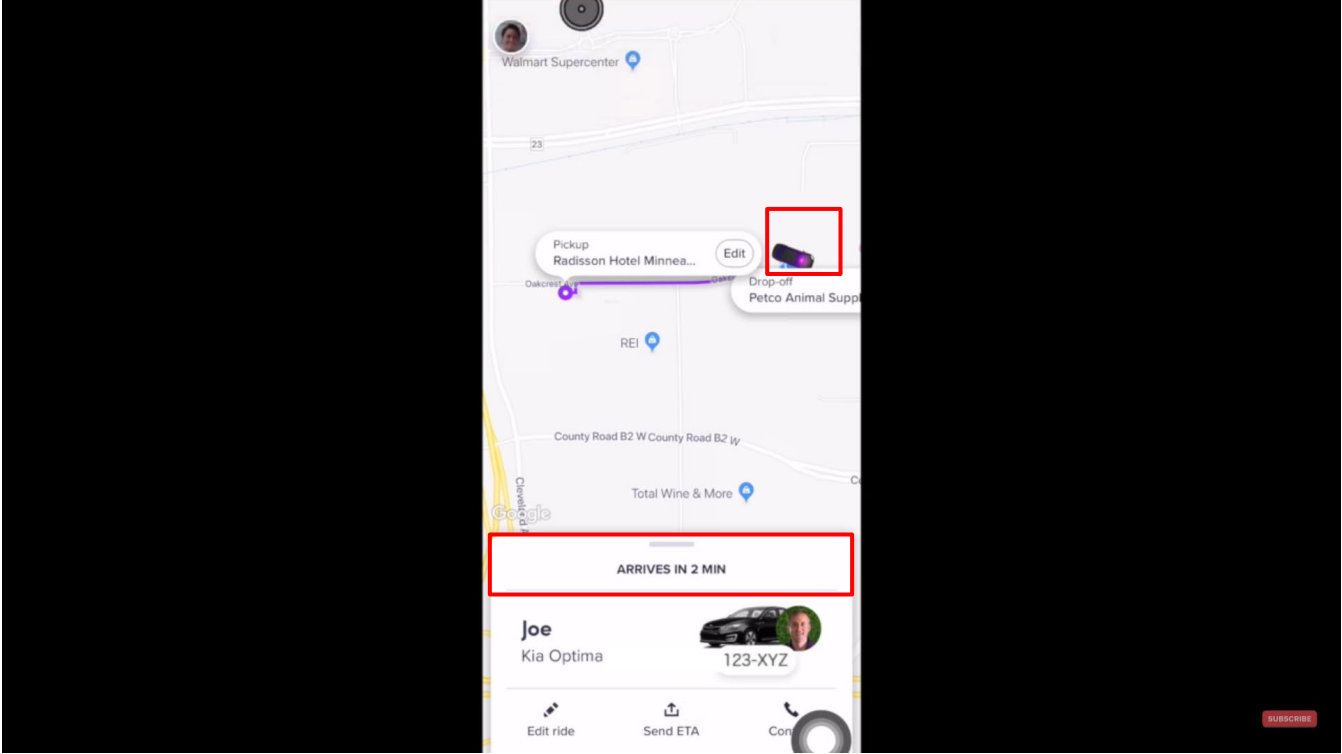
<p>Claim 10,299,100</p>	<p>- Lyft's Accused Products</p>
<p>the first vehicle based on at least one criterion selected from the group consisting of: (1) passage of time, and (2) movement of the first vehicle.</p>	<p>location information is sent to the server periodically and then forwarded to riders. There is no other way to receive this second information (besides movement of location or periodic time elapse).</p>  <p>https://www.youtube.com/watch?v=j0RDMLcmOgU at 5:07</p>

RESTRICTED CONFIDENTIAL SOURCE CODE

Attachment C for US Patent No. 10,299,100 Against Lyft Accused Products

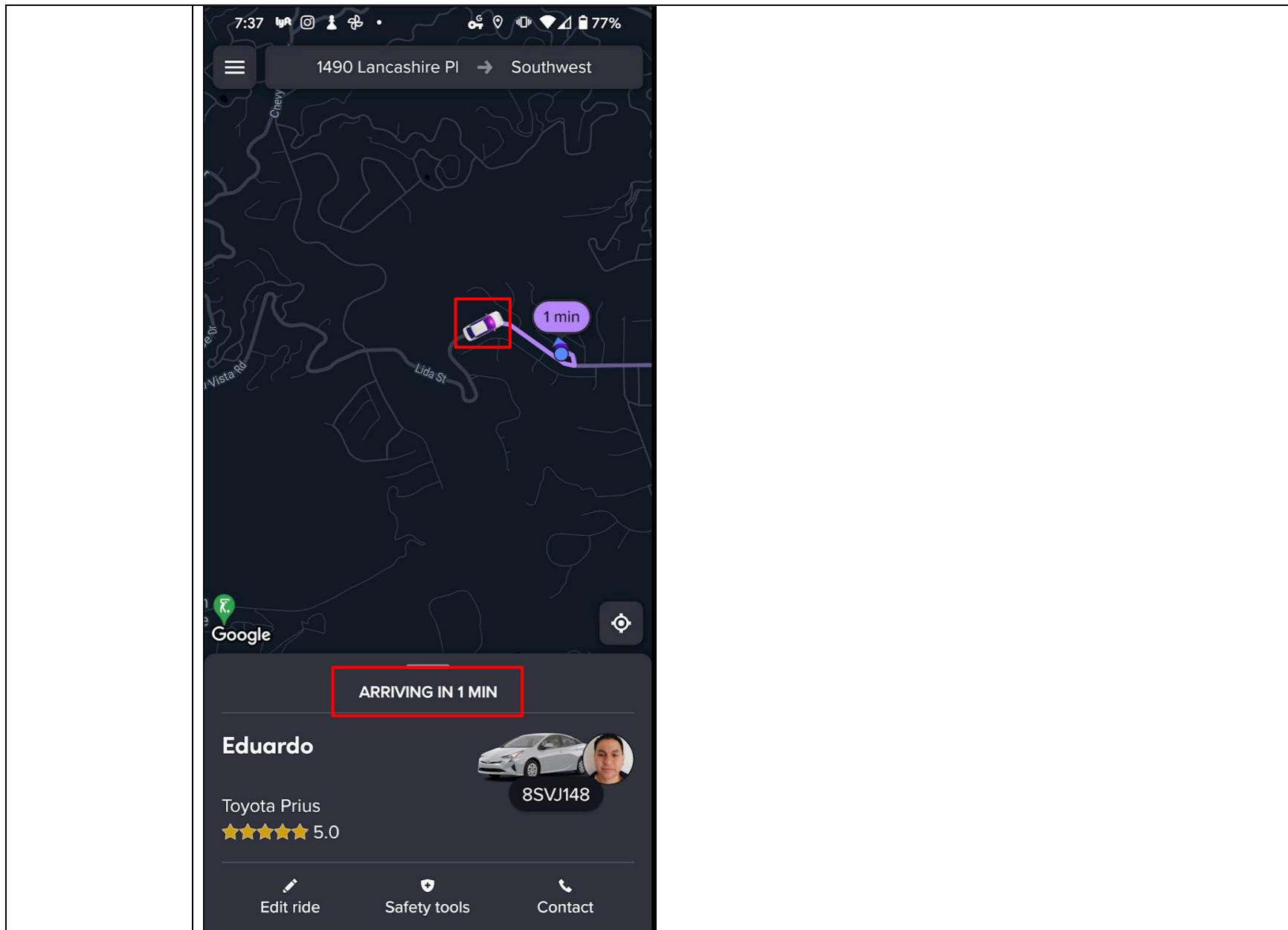

RESTRICTED CONFIDENTIAL SOURCE CODE**Attachment C for US Patent No. 10,299,100 Against Lyft Accused Products**

Claim 10,299,100	- Lyft's Accused Products
8. The method of claim 1, wherein the received second information comprises one or more messages.	<p>The Lyft Accused Products infringe directly and/or indirectly by performing, inducing others to perform, and/or contributing to the performance of receiving second information which comprises one or more messages.</p> <p><i>See claim 1[J] above.</i></p>
9. The method of claim 8, wherein the one or more messages comprise data to facilitate the mobile device transmitting the first information to the first vehicle without the mobile device using the phone number, IP address, and e-mail address associated with the first vehicle.	<p>The Lyft Accused Products infringe directly and/or indirectly by performing, inducing others to perform, and/or contributing to the performance of the one or more messages which comprises data to facilitate the mobile device transmitting the first information to the first vehicle without the mobile device using the phone number, IP address, and e-mail address associated with the first vehicle.</p> <p><i>See claim 1[K] above. The Lyft app meets this limitation because a rider is able to communicate a text message or voice message to the driver without knowing the driver's phone number, IP address and email address. This communication is transmitted via a Lyft server.</i></p>

RESTRICTED CONFIDENTIAL SOURCE CODE

Attachment C for US Patent No. 10,299,100 Against Lyft Accused Products

Claim - 10,299,100	Lyft's Accused Products
<p>10. The method of claim 1, further comprising: communicating the identifier to a server; and joining a communication network after the communication of the identifier to the server.</p>	<p>The Lyft Accused Products infringe directly and/or indirectly by performing, inducing others to perform, and/or contributing to the performance of communicating the identifier to a server and joining a communication network after the communication of the identifier to the server.</p> <p>See claim 1[B] above</p>
<p>11. The method of claim 10, wherein the communication network comprises one or more communication devices corresponding, respectively, to the one or more vehicles, and wherein each of the one or more communication devices is</p>	<p>The Lyft Accused Products infringe directly and/or indirectly by performing, inducing others to perform, and/or contributing to the performance of the communication network comprises one or more communication devices corresponding, respectively, to the one or more vehicles, and wherein each of the one or more communication devices is associated with a respective identifier.</p> <p>See Claims 1 and 10. The Lyft app meets this limitation because the installed Lyft apps and their respective accounts are part of the Lyft platform/network. For example, Lyft is a communication network of drivers and passengers. The Lyft Driver app allows a driver to set up their account by providing information, including but not limited to, name, email address, phone number, driver's license and vehicle information and associates the information with the respective device of the driver.</p> <p>For example, the Lyft app also allows a passenger to set up their account by providing information including but not limited to name, email address and phone number and associates the information with the respective device of the passenger.</p>

RESTRICTED CONFIDENTIAL SOURCE CODE

Attachment C for US Patent No. 10,299,100 Against Lyft Accused Products

Claim 10,299,100	- Lyft's Accused Products
associated with a respective identifier.	<p>What is Lyft?</p> <p>Lyft is a platform that connects drivers with individuals and organizations that need rides.</p> <p>https://www.lyft.com/drive-with-lyft</p>

RESTRICTED CONFIDENTIAL SOURCE CODE

Attachment C for US Patent No. 10,299,100 Against Lyft Accused Products

Claim 10,299,100	- Lyft's Accused Products
	<h2 data-bbox="470 329 1159 402">Driver requirements</h2> <p data-bbox="470 451 1759 516">All Lyft drivers must meet certain requirements to drive on the platform. Applicant and vehicle requirements can vary depending on your City or State.</p> <p data-bbox="470 553 1352 578">To start an application, see How to apply to become a driver for instructions.</p> <p data-bbox="470 618 562 643">Skip to:</p> <ul data-bbox="537 678 1104 1068" style="list-style-type: none"><li data-bbox="537 678 898 703">• State and local requirement<ul data-bbox="642 727 970 857" style="list-style-type: none"><li data-bbox="642 727 882 751">◦ Age requirement<li data-bbox="642 776 970 824" style="border: 1px solid red;">◦ Vehicle requirements<li data-bbox="642 833 852 857">◦ Driving history<li data-bbox="537 894 793 919">• Background check<li data-bbox="537 943 709 967">• DMV check<li data-bbox="537 992 1104 1032" style="border: 1px solid red;">• Driver license, license plates, and insurance<li data-bbox="537 1040 1016 1065">• Community Safety Education program <p data-bbox="464 1101 1352 1133">https://help.lyft.com/hc/e/articles/115012925687-Driver-requirements</p>

RESTRICTED CONFIDENTIAL SOURCE CODE

Attachment C for US Patent No. 10,299,100 Against Lyft Accused Products

Claim 10,299,100	- Lyft's Accused Products
	<p data-bbox="464 326 982 367">How to start an application</p> <p data-bbox="464 399 1297 427">Create a Lyft account through the app or on the web at lyft.com/drivers.</p> <p data-bbox="464 464 1717 526">Enter your name, phone number, and email address, then submit all the info we need to ensure you meet the requirements. If you sign out of your account, any application info you've submitted will be saved.</p> <p data-bbox="464 563 1738 625">If you have a promo code, enter it when creating an account. If you apply through a link on a website, the code will be added automatically.</p> <p data-bbox="464 662 596 690">Back to top</p> <p data-bbox="464 708 1083 735">https://help.lyft.com/hc/e/articles/115013081188</p> <p data-bbox="464 777 806 818">Applicant Waitlist</p> <p data-bbox="464 855 1730 917">New applicants will be automatically added to our waitlist. This makes sure there's a better balance of drivers and passengers in your region.</p> <p data-bbox="464 954 1759 1089">The waitlist is a hold on your application request that will be removed when additional spots for new drivers open up in your city. It's hard to say exactly how long you'll be on the waitlist due to a variety of factors that affect demand in certain areas. The waitlist doesn't impact existing drivers. We'll send you a notification as soon as a spot opens up!</p> <p data-bbox="464 1127 1717 1188">As soon as you're removed from the waitlist you'll be able to complete all necessary application steps. Once your application and documents are approved, you can start driving.</p> <p data-bbox="464 1219 1083 1247">https://help.lyft.com/hc/e/articles/115013081188</p>

RESTRICTED CONFIDENTIAL SOURCE CODE

Attachment C for US Patent No. 10,299,100 Against Lyft Accused Products

Claim 10,299,100	- Lyft's Accused Products
	<p>Before you begin, be sure you have the following:</p> <ul style="list-style-type: none"> • Your phone number • Your email address • A photo of yourself <p>Get started</p> <ol style="list-style-type: none"> 1. Type in your device's phone number 2. To verify your identity, we'll send a verification code via text to your phone number. We want to make sure you're human! 3. The text message should arrive immediately. If you don't see it after a bit, tap 'Resend code.' 4. Type in your name, email address, and take a selfie so your driver knows who to pick up 5. That's it! Once you've set up your account, you'll be able to request a ride (Learn How to request a ride). <p>https://help.lyft.com/hc/e/articles/115012926947-How-to-create-a-Lyft-account</p> <p>See claim 10 above.</p>
<p>12. The method of claim 1, further comprising determining a location-reporting status</p>	<p>The Lyft Accused Products infringe directly and/or indirectly by performing, inducing others to perform, and/or contributing to the performance of: determining a location-reporting status of the mobile device, wherein the location-reporting status is one of a reporting state and a non-reporting state, and wherein transmitting the first information to the first vehicle comprises sending the device location to a server only when the location-reporting status is in the reporting state.</p>

RESTRICTED CONFIDENTIAL SOURCE CODE

Attachment C for US Patent No. 10,299,100 Against Lyft Accused Products

Claim - 10,299,100	Lyft's Accused Products
<p>of the mobile device, wherein the location-reporting status is one of a reporting state and a non-reporting state, and wherein transmitting the first information to the first vehicle comprises sending the device location to a server only when the location-reporting status is in the reporting state.</p>	<p>See claims 1 and 2 above. The Lyft apps perform this limitation because they determine whether locations services/mode are enabled/disabled and if the location services/mode is enabled the Lyft app communicates location to the Lyft server. When location services are disabled, the Lyft app requests that the user enable location services to use the app and thus does not send location to the Lyft server. Locations retrieved from location services are sent when location services are enabled.</p>
<p>13. The method of claim 1, wherein transmitting the first information to the first vehicle comprises</p>	<p>The Lyft Accused Products infringe directly and/or indirectly by performing, inducing others to perform, and/or contributing to the performance of: transmitting the first information to the first vehicle comprises transmitting data including the first information to a server using an Internet Protocol, wherein the second information corresponding to the first vehicle is transmitted by the server to the mobile device using the Internet Protocol, and wherein an IP address of the server is accessible to the mobile device.</p>

RESTRICTED CONFIDENTIAL SOURCE CODE

Attachment C for US Patent No. 10,299,100 Against Lyft Accused Products

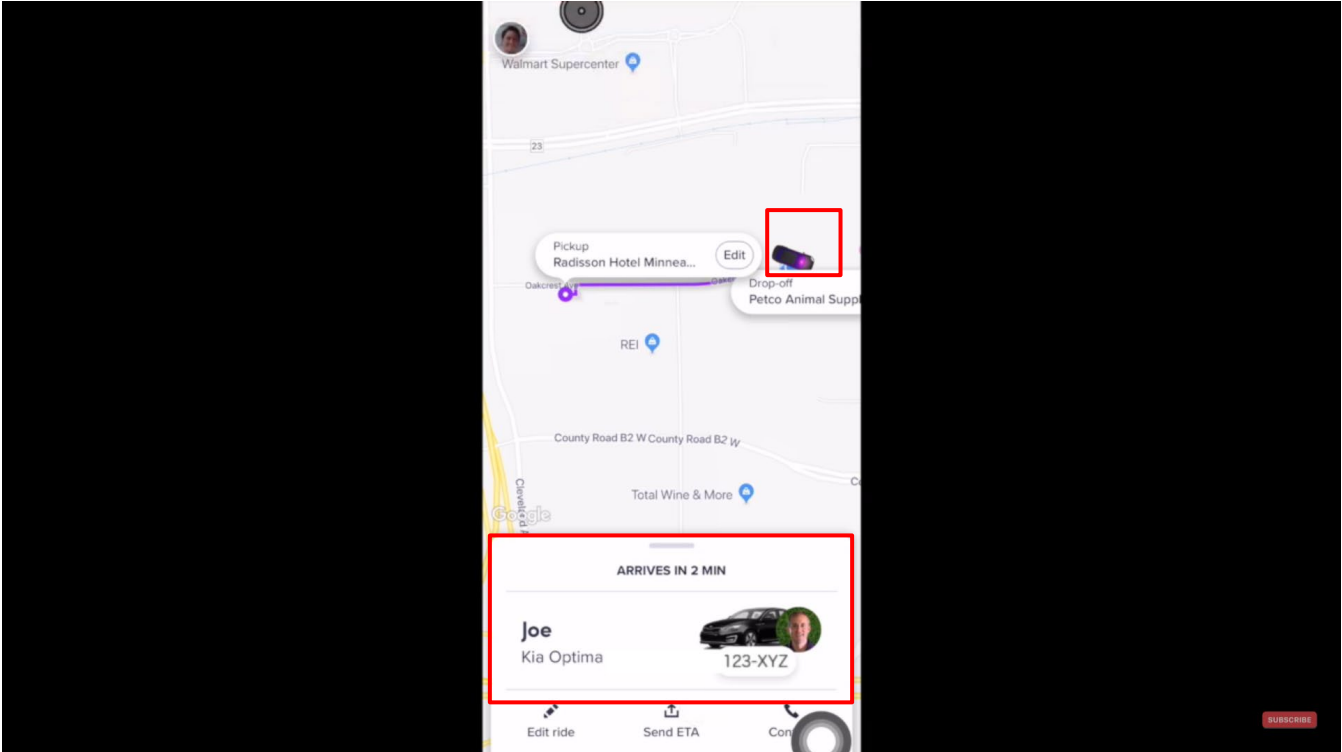
Claim 10,299,100 -	Lyft's Accused Products
<p>transmitting data including the first information to a server using an Internet Protocol, wherein the second information corresponding to the first vehicle is transmitted by the server to the mobile device using the Internet Protocol, and wherein an IP address of the server is accessible to the mobile device.</p>	<p>See claims 1[E] and 1[I] above. The Lyft app meets this limitation because it communicates information to the Lyft server(s) via IP-based communications. For example, a passenger's Lyft app transmits the ride request message to the nearby drivers via the Lyft server using IP based communication which includes the IP address of the server. After the driver accepts the ride request, the driver's information (including but not limited to driver's name, photo, vehicle name and vehicle model) is transmitted to the passenger's Lyft app via the server using IP based communication which includes the IP address of the server.</p>  <p>https://www.youtube.com/watch?v=j0RDMLcmOgU at 5:07</p>

RESTRICTED CONFIDENTIAL SOURCE CODE

Attachment C for US Patent No. 10,299,100 Against Lyft Accused Products

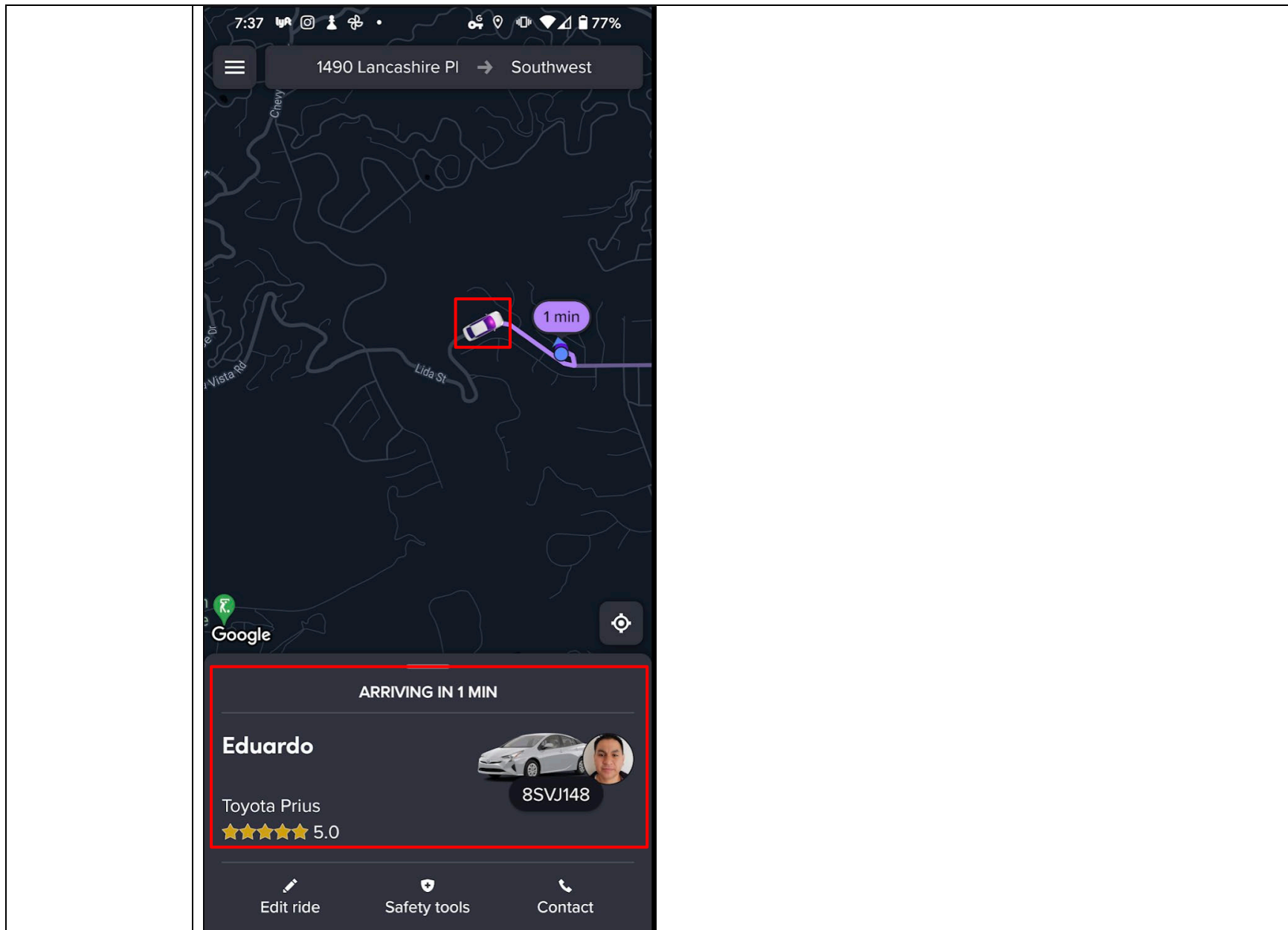

RESTRICTED CONFIDENTIAL SOURCE CODE

Attachment C for US Patent No. 10,299,100 Against Lyft Accused Products

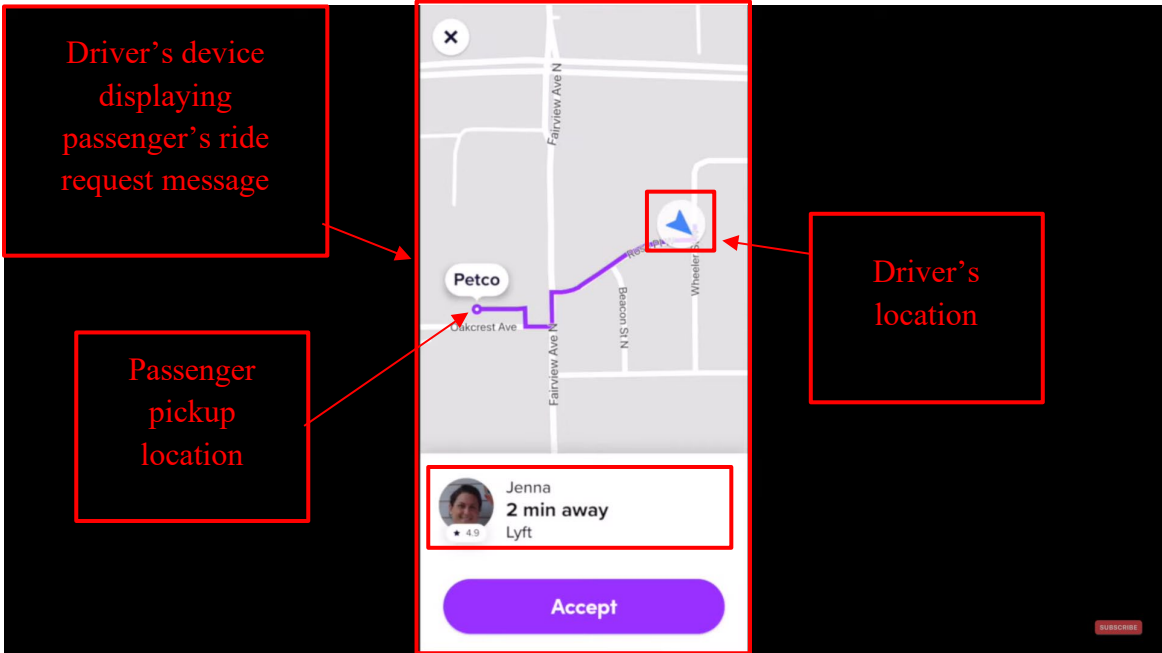
Claim 10,299,100	- Lyft's Accused Products
	 <p>The screenshot shows a Lyft driver's interface. On the left, a black box contains the text "Driver's device displaying passenger's ride request message" in red. Below it, another black box contains "Passenger pickup location" in red. On the right, a black box contains "Driver's location" in red. The central map shows a route from a pickup location (marked with a blue dot) to a destination (Petco). A blue arrow icon on the map is highlighted with a red box. Below the map, a driver profile for Jenna is shown with the text "2 min away" and "Lyft". A purple "Accept" button is visible at the bottom. A "subscribe" button is in the bottom right corner of the video frame.</p> <p>https://www.youtube.com/watch?v=jVUy9poJDng at 10:24, Annotated</p>

RESTRICTED CONFIDENTIAL SOURCE CODE

Attachment C for US Patent No. 10,299,100 Against Lyft Accused Products

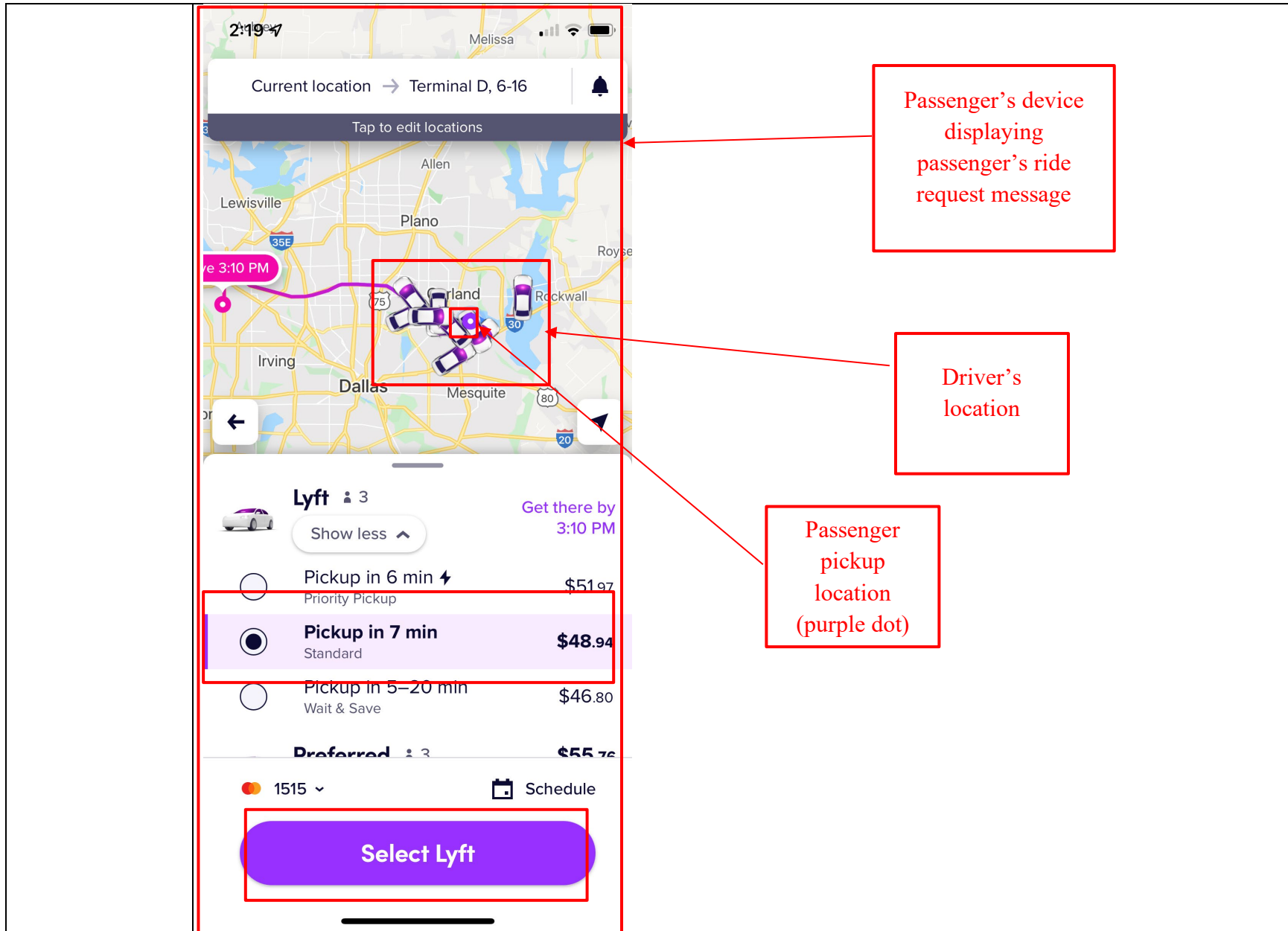

RESTRICTED CONFIDENTIAL SOURCE CODE

Attachment C for US Patent No. 10,299,100 Against Lyft Accused Products

Claim 10,299,100	- Lyft's Accused Products
	<p>Network addressing</p> <p>When a 'message' such as a file, image or video is transmitted across a network, it is first broken down into small blocks called <i>segments</i>. These are placed into containers called <i>packets</i>, typically by the Internet Protocol (IP). There are two versions of IP: version 4 and version 6.</p> <p>IP is responsible for delivering the packets from source to destination, and regardless of the version being used, packets must use some form of addressing to uniquely identify the message source and message destination.</p> <p>https://www.open.edu/openlearncreate/mod/oucontent/view.php?id=129584&printable=1</p>
<p>14. The method of claim 13, wherein the data transmitted to the server further includes a second identifier corresponding to a second network participant associated with the computing device corresponding to the first vehicle.</p>	<p>The Lyft Accused Products infringe directly and/or indirectly by performing, inducing others to perform, and/or contributing to the performance of: the data transmitted to the server further includes a second identifier corresponding to a second network participant associated with the computing device corresponding to the first vehicle.</p> <p>See claims 1 and 13. The Lyft app meets this limitation because the communications include account/identity information. This information is included in the data communicated to the server(s). For example, when a driver accepts the ride request of the passenger, the rider's Lyft app receives the driver's information (such as name, location, vehicle model and vehicle number) ("second identifier corresponding to a second network participant") from the server and vice versa.</p>

RESTRICTED CONFIDENTIAL SOURCE CODE

Attachment C for US Patent No. 10,299,100 Against Lyft Accused Products

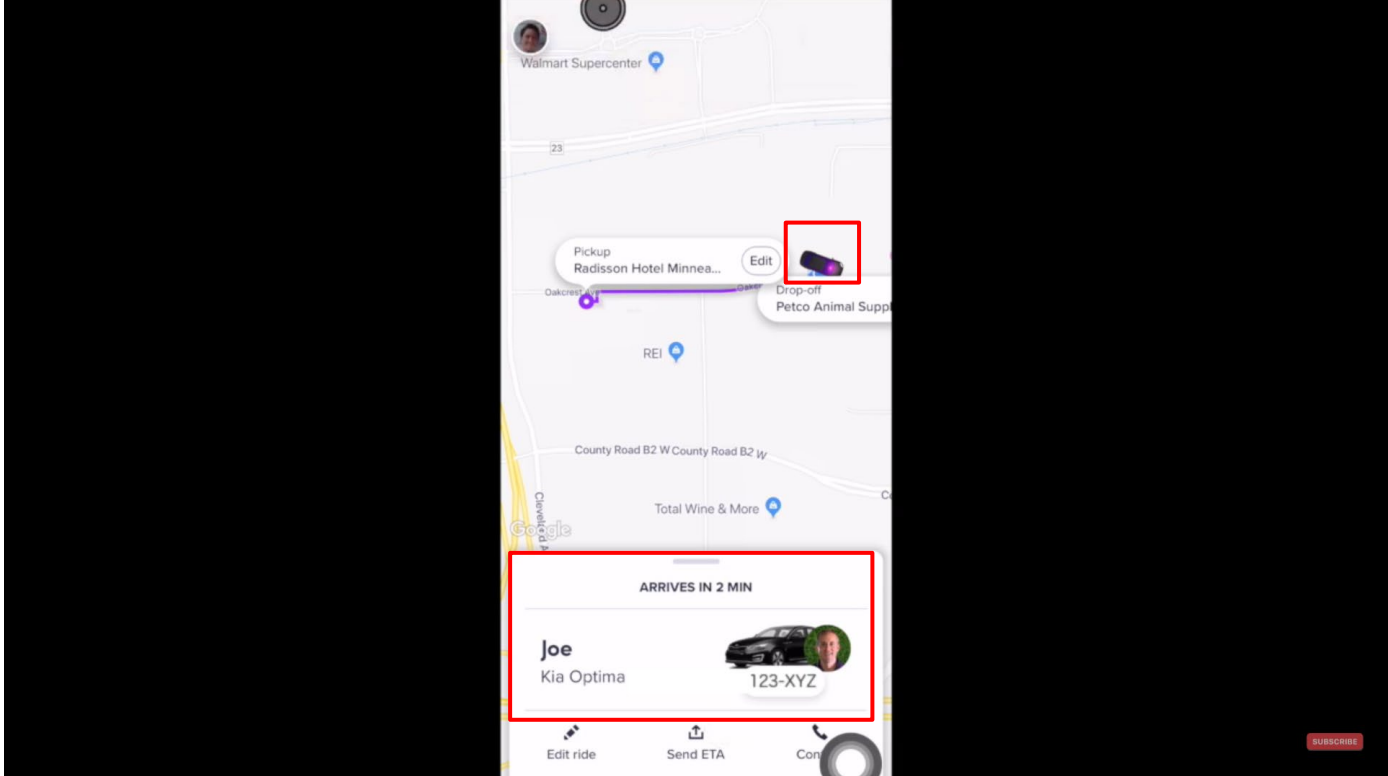
Claim 10,299,100	- Lyft's Accused Products
	 <p>The screenshot shows a Lyft ride interface. At the top, the pickup location is "Radisson Hotel Minnea..." and the drop-off location is "Petco Animal Supp...". A red box highlights a small icon of a car. Below the map, a red box highlights the driver's profile information: "ARRIVES IN 2 MIN", "Joe", "Kia Optima", and "123-XYZ". At the bottom, there are buttons for "Edit ride", "Send ETA", and "Con...".</p> <p>https://www.youtube.com/watch?v=j0RDMLcmOgU at 5:07</p>

RESTRICTED CONFIDENTIAL SOURCE CODE

Attachment C for US Patent No. 10,299,100 Against Lyft Accused Products

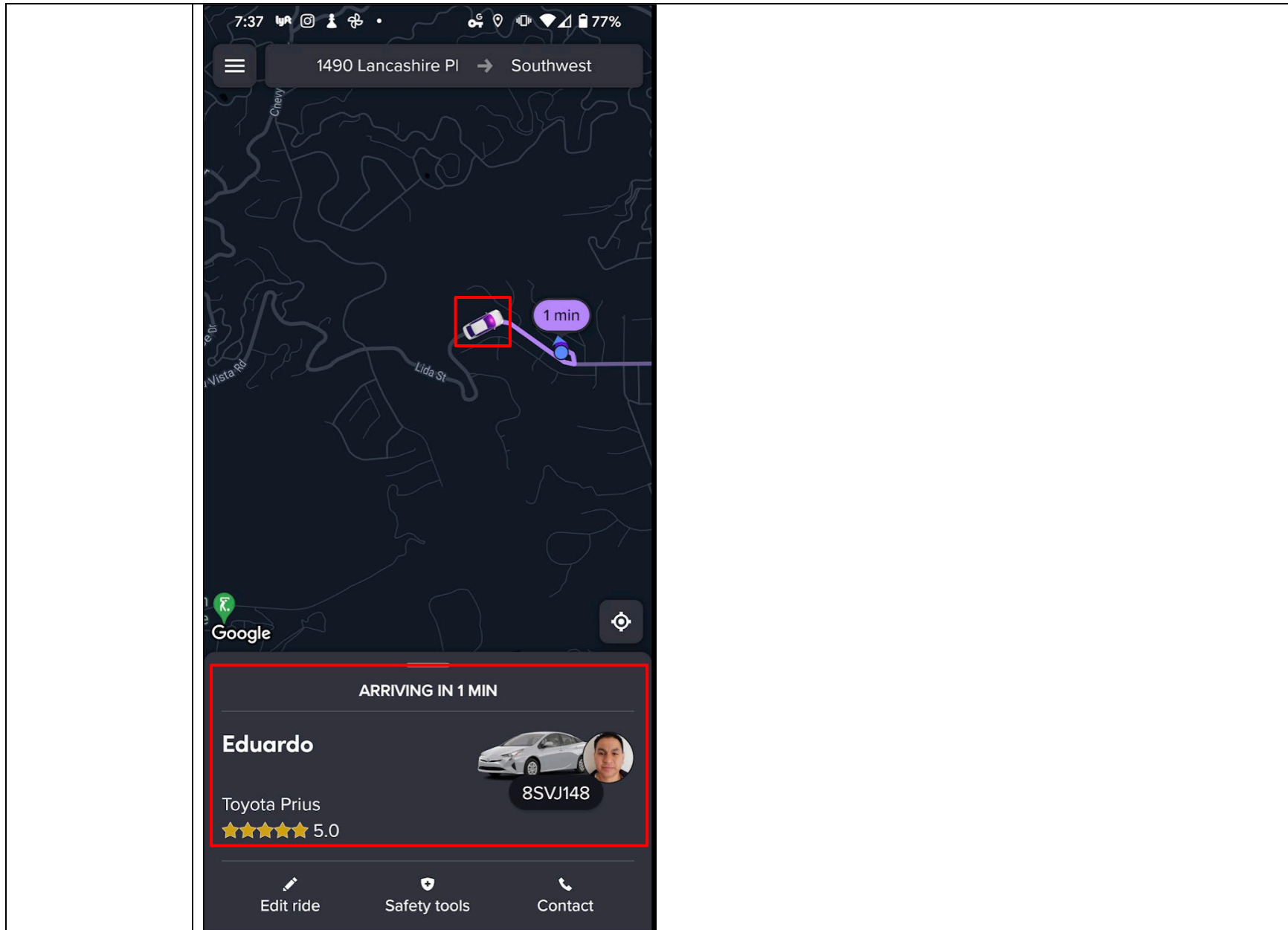

RESTRICTED CONFIDENTIAL SOURCE CODE**Attachment C for US Patent No. 10,299,100 Against Lyft Accused Products**

Claim 10,299,100	Lyft's Accused Products
<p>15. The method of claim 14, wherein: the server stores an IP address of the computing device associated with the second network participant identified by the second identifier; and the server transmits the first information to the computing device corresponding to the first vehicle in a message addressed to the stored IP address of the computing device corresponding to the first vehicle.</p>	<p>The Lyft Accused Products infringe directly and/or indirectly by performing, inducing others to perform, and/or contributing to the performance of: the server stores an IP address of the computing device associated with the second network participant identified by the second identifier; and the server transmits the first information to the computing device corresponding to the first vehicle in a message addressed to the stored IP address of the computing device corresponding to the first vehicle.</p> <p>See claims 1, 13, 14. The Lyft app stores the IP address of the Lyft app and communicates with the Lyft app (and accounts or identities) via IP based communication. Lyft server(s) store the IP addresses of Lyft app/accounts for use in IP based communication. For example, Lyft's server store IP addresses of each driver's device and associates it to the respective driver's information including but not limited to as name, location, vehicle model and vehicle number. When the passenger requests a ride, the request ride message ("first information") comprising pickup location and passenger's name and photo ("identifier") is communicated to the nearby drivers using their respective IP addresses which are stored in the server.</p>

RESTRICTED CONFIDENTIAL SOURCE CODE

Attachment C for US Patent No. 10,299,100 Against Lyft Accused Products

Claim 10,299,100	- Lyft's Accused Products
	<h2 data-bbox="470 326 1159 402">Driver requirements</h2> <p data-bbox="470 451 1759 516">All Lyft drivers must meet certain requirements to drive on the platform. Applicant and vehicle requirements can vary depending on your City or State.</p> <p data-bbox="470 553 1352 578">To start an application, see How to apply to become a driver for instructions.</p> <p data-bbox="470 615 558 639">Skip to:</p> <ul data-bbox="537 678 1104 1068" style="list-style-type: none"><li data-bbox="537 678 898 703">• State and local requirement<ul data-bbox="642 727 968 857" style="list-style-type: none"><li data-bbox="642 727 884 751">◦ Age requirement<li data-bbox="642 776 968 824" style="border: 1px solid red;">◦ Vehicle requirements<li data-bbox="642 833 852 857">◦ Driving history<li data-bbox="537 894 793 919">• Background check<li data-bbox="537 943 709 967">• DMV check<li data-bbox="537 992 1104 1032" style="border: 1px solid red;">• Driver license, license plates, and insurance<li data-bbox="537 1040 1020 1065">• Community Safety Education program <p data-bbox="464 1101 1352 1133">https://help.lyft.com/hc/e/articles/115012925687-Driver-requirements</p>

RESTRICTED CONFIDENTIAL SOURCE CODE

Attachment C for US Patent No. 10,299,100 Against Lyft Accused Products

Claim 10,299,100	- Lyft's Accused Products
	<p data-bbox="464 326 982 367">How to start an application</p> <p data-bbox="464 399 1297 427">Create a Lyft account through the app or on the web at lyft.com/drivers.</p> <p data-bbox="464 464 1717 526">Enter your name, phone number, and email address, then submit all the info we need to ensure you meet the requirements. If you sign out of your account, any application info you've submitted will be saved.</p> <p data-bbox="464 563 1738 625">If you have a promo code, enter it when creating an account. If you apply through a link on a website, the code will be added automatically.</p> <p data-bbox="464 662 600 690">Back to top</p> <p data-bbox="464 708 1083 735">https://help.lyft.com/hc/e/articles/115013081188</p> <p data-bbox="464 777 810 818">Applicant Waitlist</p> <p data-bbox="464 855 1728 917">New applicants will be automatically added to our waitlist. This makes sure there's a better balance of drivers and passengers in your region.</p> <p data-bbox="464 954 1759 1089">The waitlist is a hold on your application request that will be removed when additional spots for new drivers open up in your city. It's hard to say exactly how long you'll be on the waitlist due to a variety of factors that affect demand in certain areas. The waitlist doesn't impact existing drivers. We'll send you a notification as soon as a spot opens up!</p> <p data-bbox="464 1127 1717 1188">As soon as you're removed from the waitlist you'll be able to complete all necessary application steps. Once your application and documents are approved, you can start driving.</p> <p data-bbox="464 1219 1083 1247">https://help.lyft.com/hc/e/articles/115013081188</p>

RESTRICTED CONFIDENTIAL SOURCE CODE

Attachment C for US Patent No. 10,299,100 Against Lyft Accused Products

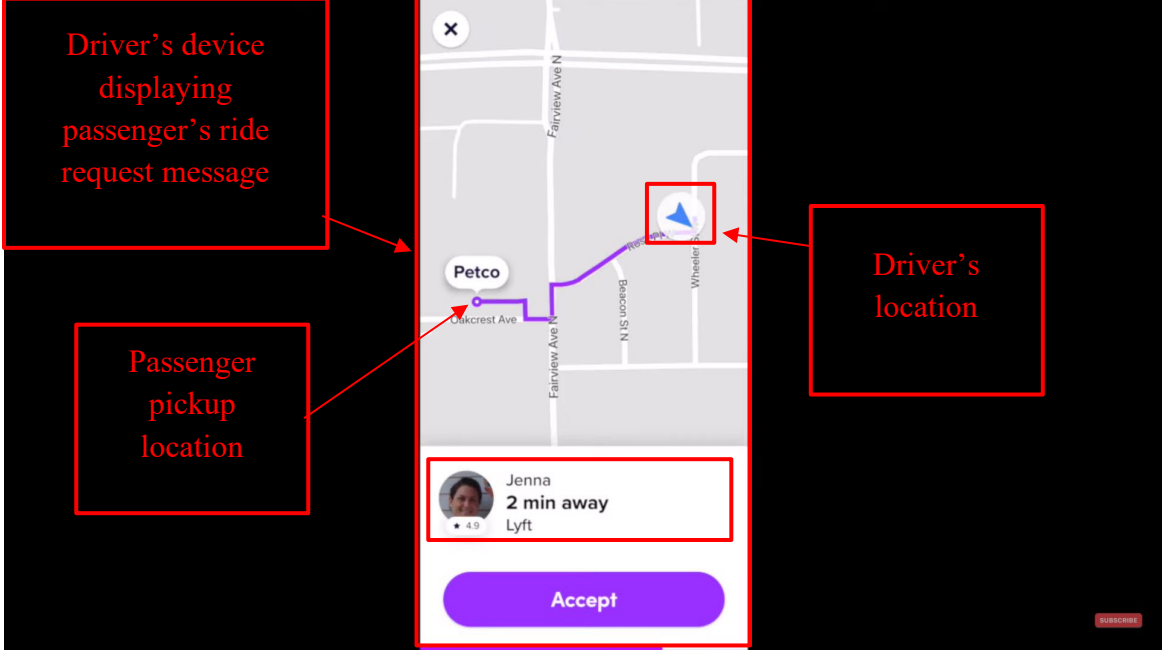
Claim 10,299,100	- Lyft's Accused Products
	 <p>Driver's device displaying passenger's ride request message</p> <p>Passenger pickup location</p> <p>Driver's location</p> <p>Jenna 2 min away Lyft</p> <p>Accept</p> <p>https://www.youtube.com/watch?v=jVUy9poJDng at 10:24, Annotated</p>

RESTRICTED CONFIDENTIAL SOURCE CODE

Attachment C for US Patent No. 10,299,100 Against Lyft Accused Products

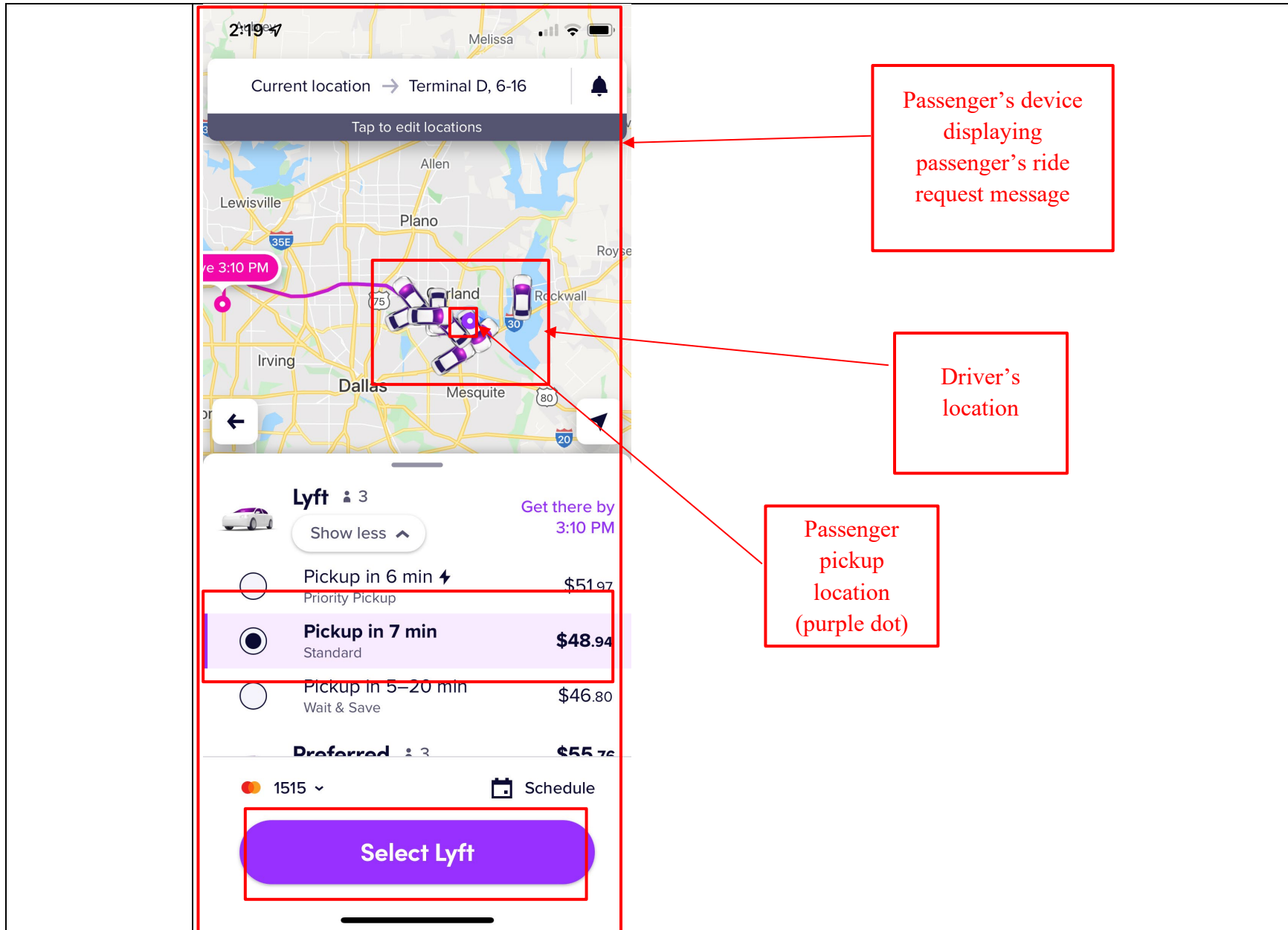

RESTRICTED CONFIDENTIAL SOURCE CODE

Attachment C for US Patent No. 10,299,100 Against Lyft Accused Products

Claim 10,299,100	- Lyft's Accused Products
	<p>Network addressing</p> <p>When a 'message' such as a file, image or video is transmitted across a network, it is first broken down into small blocks called <i>segments</i>. These are placed into containers called <i>packets</i>, typically by the Internet Protocol (IP). There are two versions of IP: version 4 and version 6.</p> <p>IP is responsible for delivering the packets from source to destination, and regardless of the version being used, packets must use some form of addressing to uniquely identify the message source and message destination.</p> <p>https://www.open.edu/openlearncreate/mod/oucontent/view.php?id=129584&printable=1</p>
<p>16. The method of claim 1, further comprising determining coordinates of the selected position on the map, wherein data associated with the set of symbols include coordinates of positions on the map of the symbols in the set,</p>	<p>The Lyft Accused Products infringe directly and/or indirectly by performing, inducing others to perform, and/or contributing to the performance of determining coordinates of the selected position on the map, wherein data associated with the set of symbols include coordinates of positions on the map of the symbols in the set, wherein the search of the set of symbols includes a search of the coordinates of the positions of the symbols in the set for coordinates located nearest to the coordinates of the selected position, and wherein the selected facility symbol is identified as the symbol located nearest to the selected position based on a result of the search of the coordinates of the positions on the map of the symbols.</p> <p>See claim 1[H] above.</p>

RESTRICTED CONFIDENTIAL SOURCE CODE

Attachment C for US Patent No. 10,299,100 Against Lyft Accused Products

Claim - 10,299,100	Lyft's Accused Products
<p>wherein the search of the set of symbols includes a search of the coordinates of the positions of the symbols in the set for coordinates located nearest to the coordinates of the selected position, and wherein the selected facility symbol is identified as the symbol located nearest to the selected position based on a result of the search of the coordinates of the positions on the map of the symbols.</p>	
<p>17. The method of claim 1, further</p>	<p>The Lyft Accused Products infringe directly and/or indirectly by performing, inducing others to perform, and/or contributing to the performance of determining coordinates of the selected portion of the display, wherein data associated with the set of symbols include coordinates of portions of the display corresponding to the symbols in</p>

RESTRICTED CONFIDENTIAL SOURCE CODE

Attachment C for US Patent No. 10,299,100 Against Lyft Accused Products

Claim 10,299,100	Lyft's Accused Products
<p>comprising determining coordinates of the selected portion of the display, wherein data associated with the set of symbols include coordinates of portions of the display corresponding to the symbols in the set, wherein the search of the set of symbols includes a search of the coordinates of the portions of the display corresponding to the symbols in the set for coordinates located nearest to the coordinates of the selected</p>	<p>the set, wherein the search of the set of symbols includes a search of the coordinates of the portions of the display corresponding to the symbols in the set for coordinates located nearest to the coordinates of the selected portion of the display, and wherein the selected facility symbol is identified as the symbol located nearest to the selected position based on a result of the search of the coordinates of the portions of the display corresponding to the symbols.</p> <p><i>See claim 1[H] above.</i></p>

RESTRICTED CONFIDENTIAL SOURCE CODE**Attachment C for US Patent No. 10,299,100 Against Lyft Accused Products**

Claim - 10,299,100	Lyft's Accused Products
<p>portion of the display, and wherein the selected facility symbol is identified as the symbol located nearest to the selected position based on a result of the search of the coordinates of the portions of the display corresponding to the symbols.</p>	
<p>18. The method of claim 1, further comprising determining coordinates of a location represented by the selected position on the map, wherein data associated with the set of</p>	<p>The Lyft Accused Products infringe directly and/or indirectly by performing, inducing others to perform, and/or contributing to the performance of determining coordinates of a location represented by the selected position on the map, wherein data associated with the set of symbols include coordinates of locations of entities represented by the symbols in the set, wherein the search of the set of symbols includes a search of the coordinates of the locations of the entities represented by the symbols in the set for coordinates located nearest to the coordinates of the location represented by the selected position on the map, and wherein the selected facility symbol is identified as the symbol located nearest to the selected position based on a result of the search of the coordinates of the locations of the entities represented by the symbols.</p> <p>See claim 1[H] above.</p>

RESTRICTED CONFIDENTIAL SOURCE CODE

Attachment C for US Patent No. 10,299,100 Against Lyft Accused Products

Claim 10,299,100	- Lyft's Accused Products
<p>symbols include coordinates of locations of entities represented by the symbols in the set, wherein the search of the set of symbols includes a search of the coordinates of the locations of the entities represented by the symbols in the set for coordinates located nearest to the coordinates of the location represented by the selected position on the map, and wherein the selected facility symbol is identified as the</p>	

RESTRICTED CONFIDENTIAL SOURCE CODE

Attachment C for US Patent No. 10,299,100 Against Lyft Accused Products

Claim - 10,299,100	Lyft's Accused Products
<p>symbol located nearest to the selected position based on a result of the search of the coordinates of the locations of the entities represented by the symbols.</p>	
<p>19. The method of claim 1, further comprising: after identifying the selected facility symbol, displaying an address of the facility represented by the facility symbol.</p>	<p>The Lyft Accused Products infringe directly and/or indirectly by performing, inducing others to perform, and/or contributing to the performance of: after identifying the selected facility symbol, displaying an address of the facility represented by the facility symbol.</p> <p>See claim 1. The Lyft apps meet this limitation because the Lyft app displays the address for selected entities on the display. For example, after Lyft identifies the selected facility symbol (<i>e.g.</i> airport), it displays the address of the selected facility represented by the facility symbol.</p>

RESTRICTED CONFIDENTIAL SOURCE CODE

Attachment C for US Patent No. 10,299,100 Against Lyft Accused Products

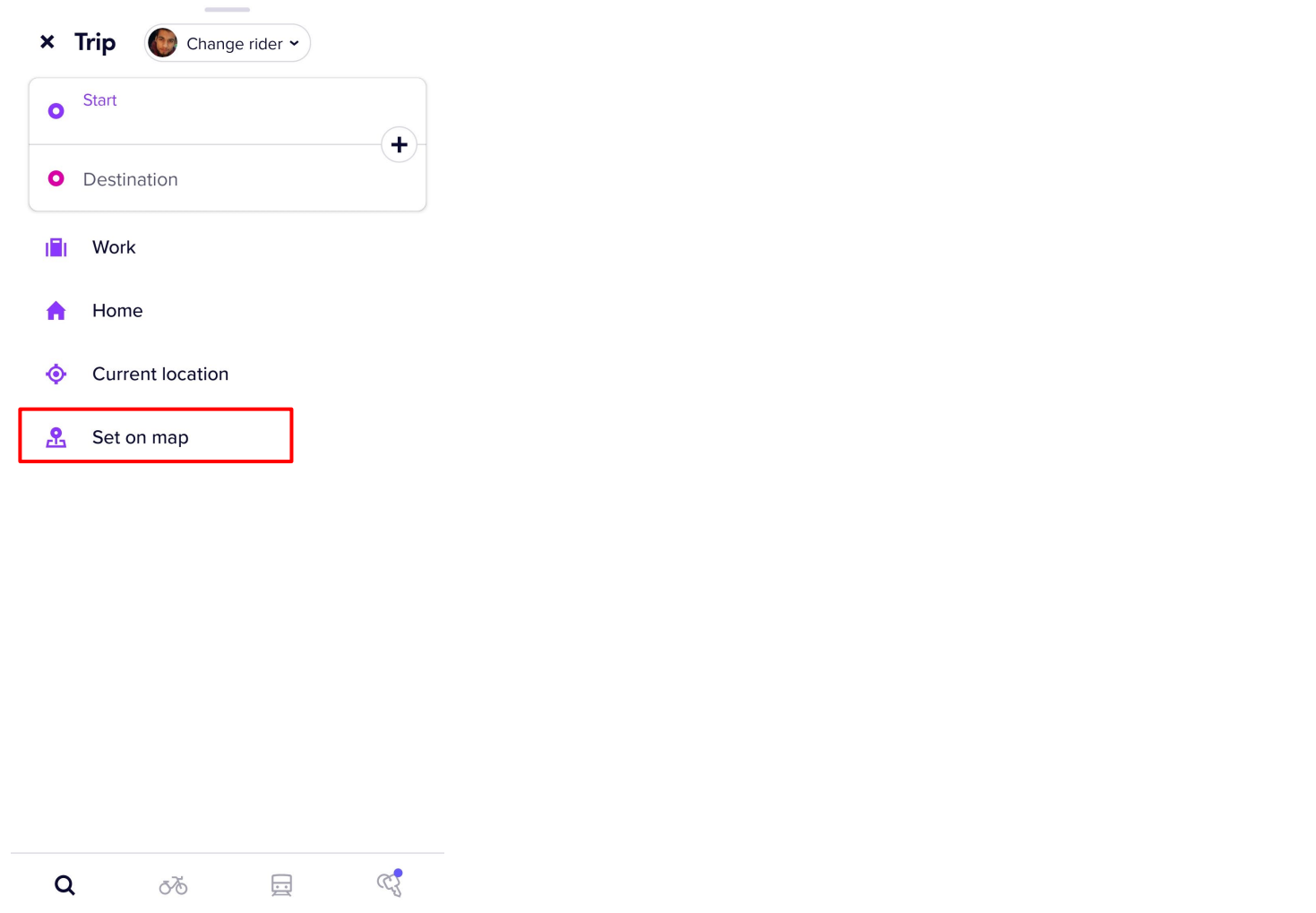
Claim 10,299,100	- Lyft's Accused Products
	 <p>The screenshot displays the Lyft app's 'Trip' screen. At the top, there is a 'Trip' header with a close button (x) and a 'Change rider' dropdown menu. Below this is a form with two input fields: 'Start' and 'Destination', each with a location pin icon and a plus sign to its right. Underneath the form are four location suggestions: 'Work' (with a building icon), 'Home' (with a house icon), 'Current location' (with a location pin icon), and 'Set on map' (with a person icon). The 'Set on map' option is highlighted with a red rectangular box. At the bottom of the screen, there is a navigation bar with four icons: a magnifying glass (search), a bicycle (bike share), a train (public transit), and a person with a plus sign (add rider).</p>

RESTRICTED CONFIDENTIAL SOURCE CODE

Attachment C for US Patent No. 10,299,100 Against Lyft Accused Products

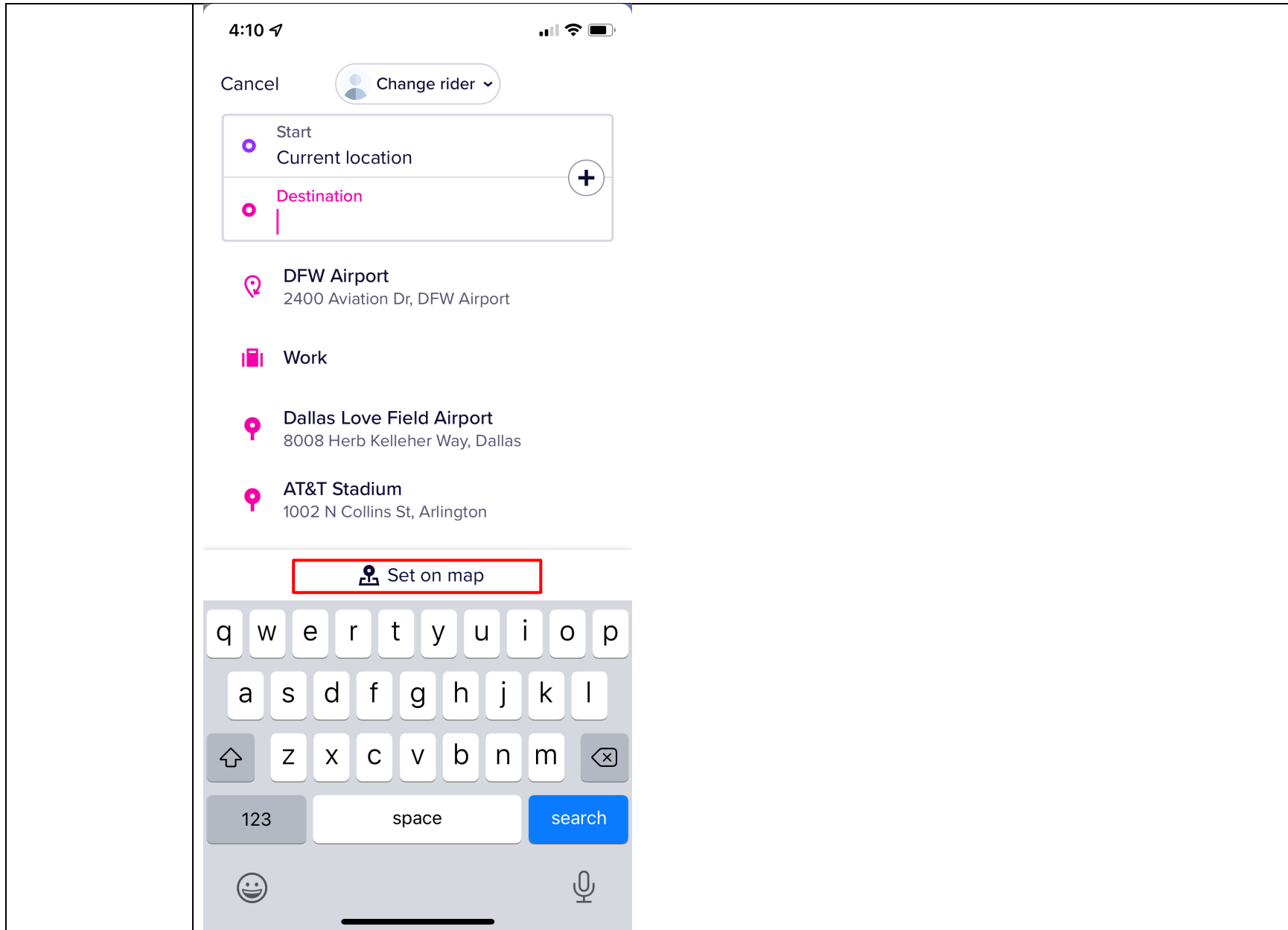

RESTRICTED CONFIDENTIAL SOURCE CODE

Attachment C for US Patent No. 10,299,100 Against Lyft Accused Products

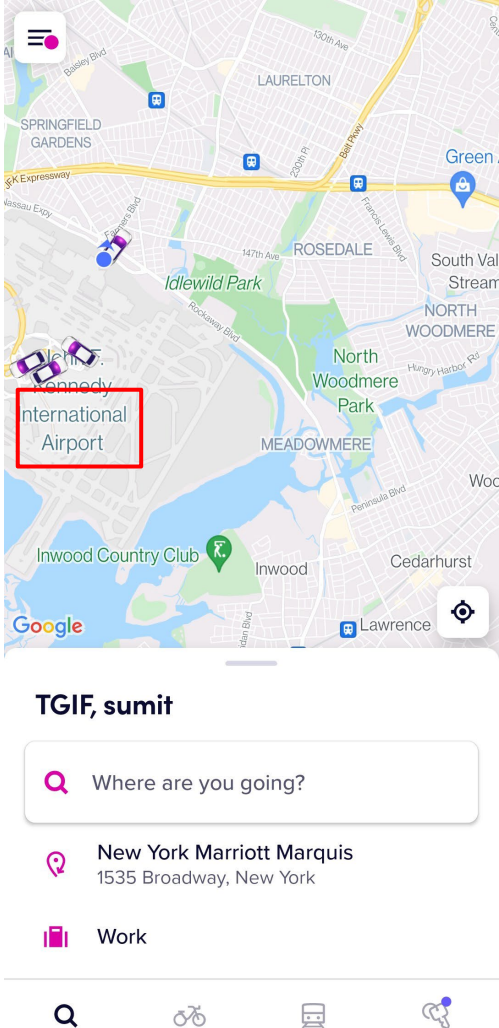
Claim 10,299,100	- Lyft's Accused Products
	 <p>The screenshot displays the Lyft mobile application interface. At the top, there is a map of the New York City area, specifically showing the area around JFK International Airport, which is highlighted with a red rectangular box. Below the map, the text "TGIF, sumit" is visible. Underneath this, there is a search bar with the placeholder text "Where are you going?". Below the search bar, there are two suggestions: "New York Marriott Marquis" with the address "1535 Broadway, New York" and "Work". At the bottom of the screen, there is a navigation bar with icons for search, bicycle, car, and a location pin.</p>

RESTRICTED CONFIDENTIAL SOURCE CODE

Attachment C for US Patent No. 10,299,100 Against Lyft Accused Products

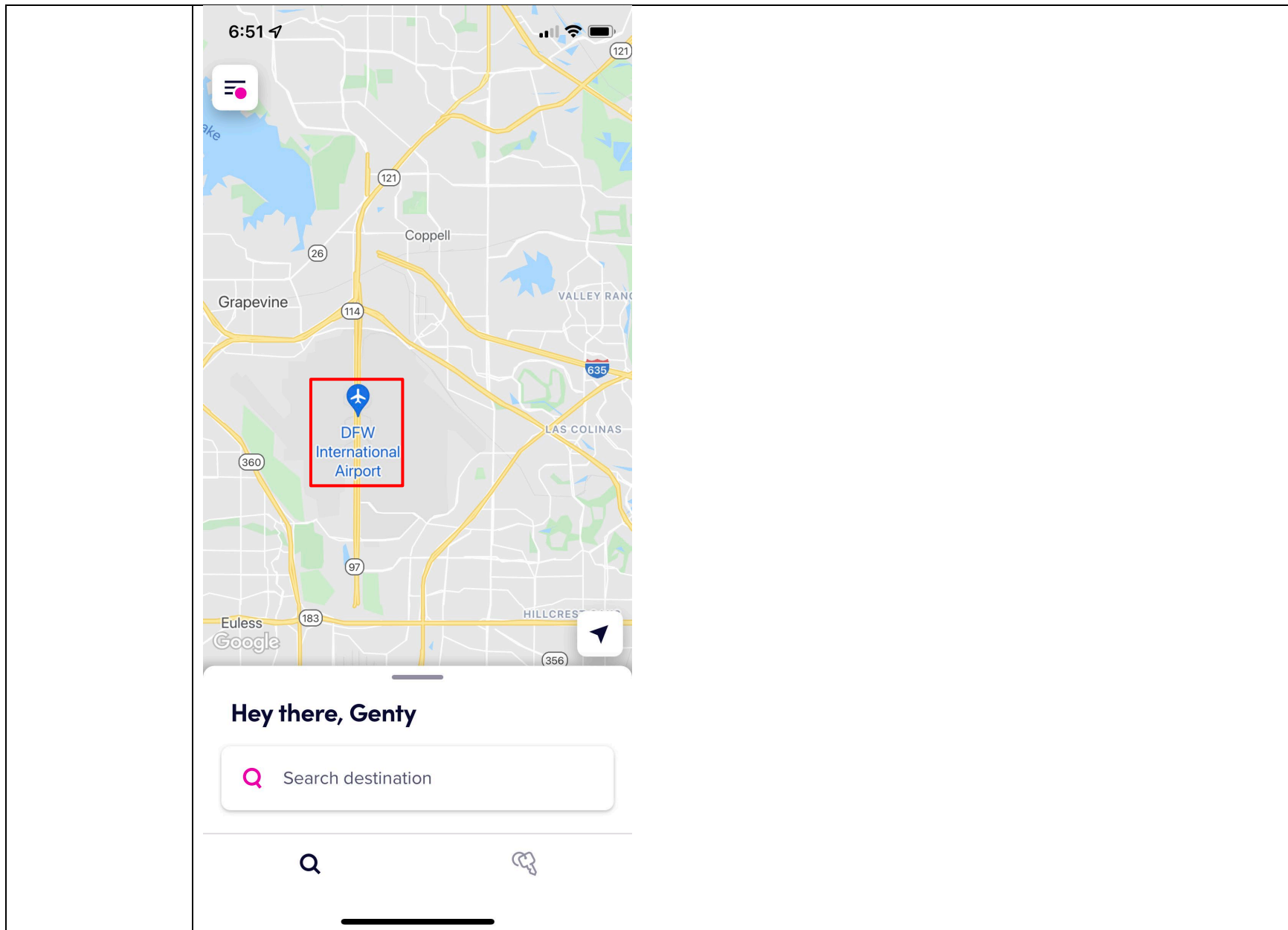

RESTRICTED CONFIDENTIAL SOURCE CODE

Attachment C for US Patent No. 10,299,100 Against Lyft Accused Products

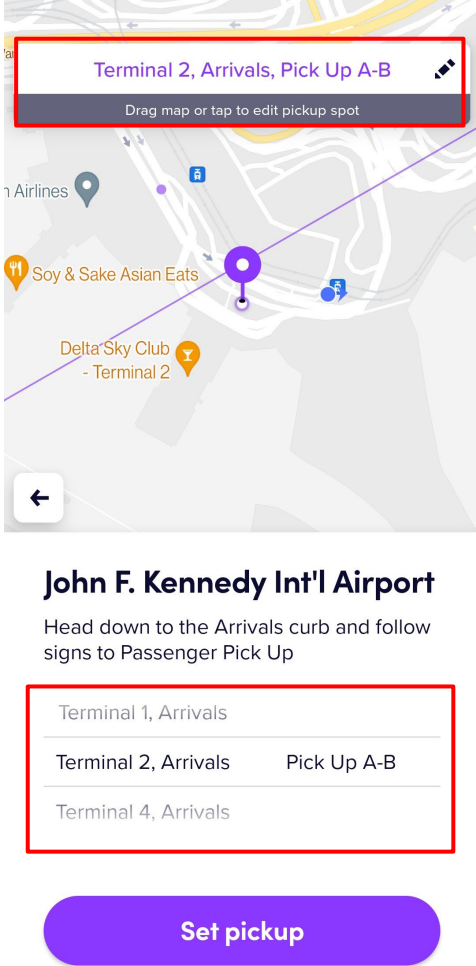
Claim 10,299,100	- Lyft's Accused Products
	 <p>Terminal 2, Arrivals, Pick Up A-B</p> <p>Drag map or tap to edit pickup spot</p> <p>John F. Kennedy Int'l Airport</p> <p>Head down to the Arrivals curb and follow signs to Passenger Pick Up</p> <p>Terminal 1, Arrivals</p> <p>Terminal 2, Arrivals Pick Up A-B</p> <p>Terminal 4, Arrivals</p> <p>Set pickup</p>

RESTRICTED CONFIDENTIAL SOURCE CODE

Attachment C for US Patent No. 10,299,100 Against Lyft Accused Products

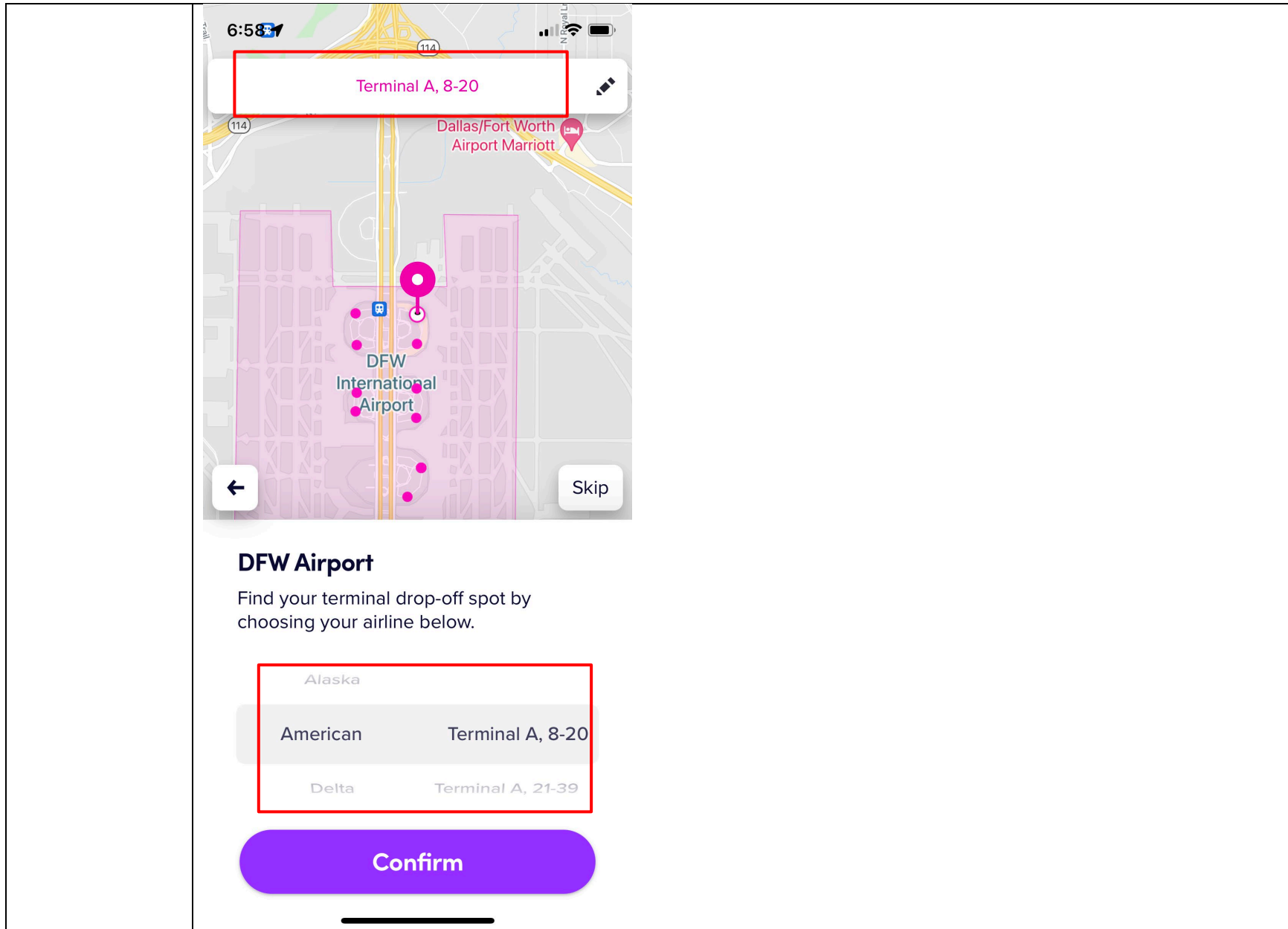

RESTRICTED CONFIDENTIAL SOURCE CODE**Attachment C for US Patent No. 10,299,100 Against Lyft Accused Products**

Claim 10,299,100	- Lyft's Accused Products
<p>20. The method of claim 1, wherein the mobile device is a first mobile device, wherein the map is a first map, and wherein the method further comprises: receiving second user input via user interaction with a second portion of the display of the first mobile device, the second user input specifying a position on the first map of an event symbol representing an event; and</p>	<p>The Lyft Accused Products infringe directly and/or indirectly by performing, inducing others to perform, and/or contributing to the performance of: the mobile device is a first mobile device, wherein the map is a first map, and wherein the method further comprises: receiving second user input via user interaction with a second portion of the display of the first mobile device, the second user input specifying a position on the first map of an event symbol representing an event; and based on the second user input: determining coordinates of a location of the event based on coordinates of the specified position on the first map and the coordinate translation data; associating the location of the event with the event symbol; displaying the event symbol at the specified position on the first map; and transmitting the location of the event to a second mobile device corresponding to the first vehicle, wherein the second mobile device is operable to display a second map and to place the event symbol on the second map.</p> <p>See claim 1. The Lyft app meets this limitation because the user can provided user input in the Lyft app to specify multiple pickup/stop/destinations and the corresponding symbol/location will be placed on the map. This symbol/location is communicated to the driver's Lyft app. For example, through the Lyft app, a passenger inputs a destination address by clicking on the map interface. This input specifies a position on the map and is displayed as a symbol after the user inputs it. Further, this location is transmitted to the driver and is displayed as a symbol on the driver's app.</p>

RESTRICTED CONFIDENTIAL SOURCE CODE

Attachment C for US Patent No. 10,299,100 Against Lyft Accused Products

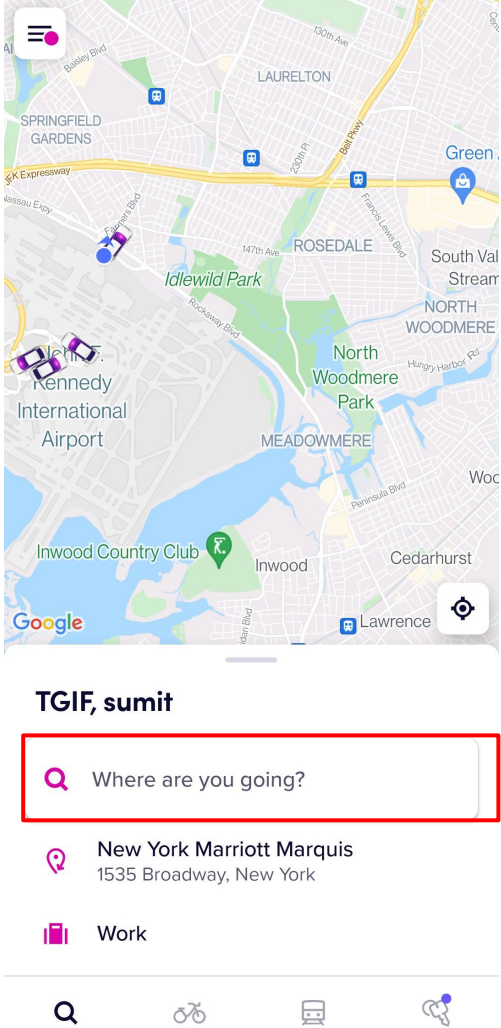
Claim 10,299,100	Lyft's Accused Products
<p>based on the second user input: determining coordinates of a location of the event based on coordinates of the specified position on the first map and the coordinate translation data; associating the location of the event with the event symbol; displaying the event symbol at the specified position on the first map; and transmitting the location of the event to a second mobile device corresponding to the first vehicle, wherein the second mobile</p>	 <p>The screenshot shows a mobile application interface. At the top, there is a map of a city area, likely New York City, with labels for neighborhoods like LAURELTON, ROSEDALE, and MEADOWMERE. A purple Lyft car icon is visible on the map. Below the map, the text "TGIF, sumit" is displayed. Underneath, there is a search bar with a magnifying glass icon and the placeholder text "Where are you going?". Below the search bar, there are two location suggestions: "New York Marriott Marquis" with the address "1535 Broadway, New York" and "Work". At the bottom of the screen, there is a navigation bar with icons for search, bicycle, car, and a location pin.</p>

RESTRICTED CONFIDENTIAL SOURCE CODE

Attachment C for US Patent No. 10,299,100 Against Lyft Accused Products

device is operable to display a second map and to place the event symbol on the second map.

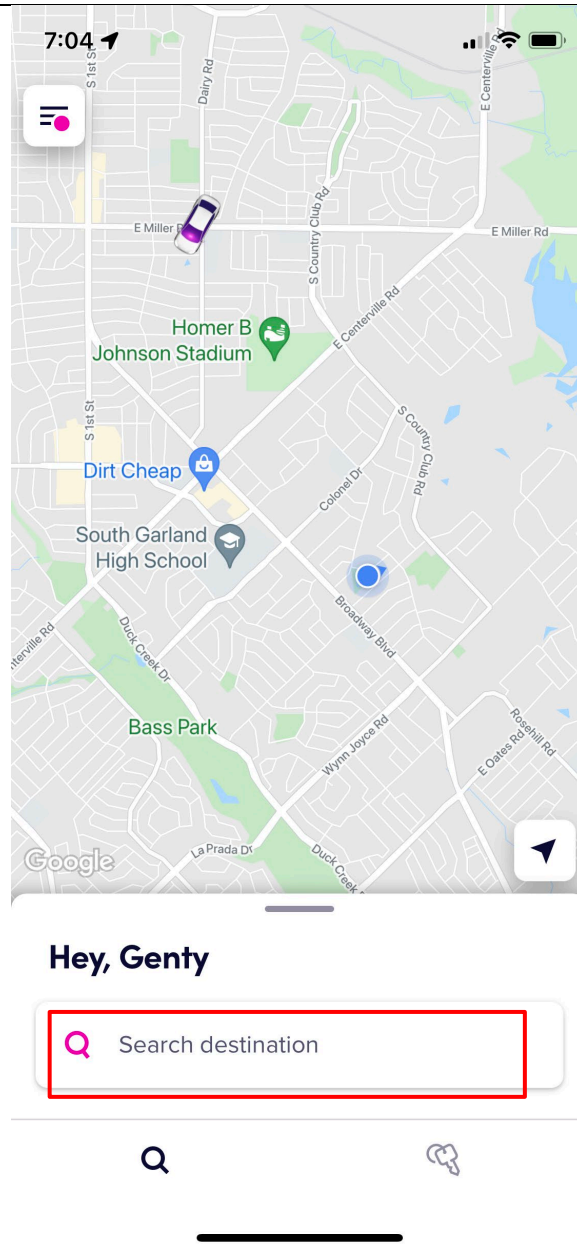

RESTRICTED CONFIDENTIAL SOURCE CODE

Attachment C for US Patent No. 10,299,100 Against Lyft Accused Products

Claim 10,299,100	- Lyft's Accused Products
<p>21. The method of claim 20, wherein the coordinates of the location of the event are determined based on coordinates of the position of the event symbol on the map and the coordinate translation data.</p>	<p>The Lyft Accused Products infringe directly and/or indirectly by performing, inducing others to perform, and/or contributing to the performance of: the coordinates of the location of the event are determined based on coordinates of the position of the event symbol on the map and the coordinate translation data.</p> <p>See claims 1[H] and 20. For example, the coordinates of the destination address (“event”) are determined by the symbol placed by the passenger on the map in the Lyft app.</p>

RESTRICTED CONFIDENTIAL SOURCE CODE

Attachment C for US Patent No. 10,299,100 Against Lyft Accused Products

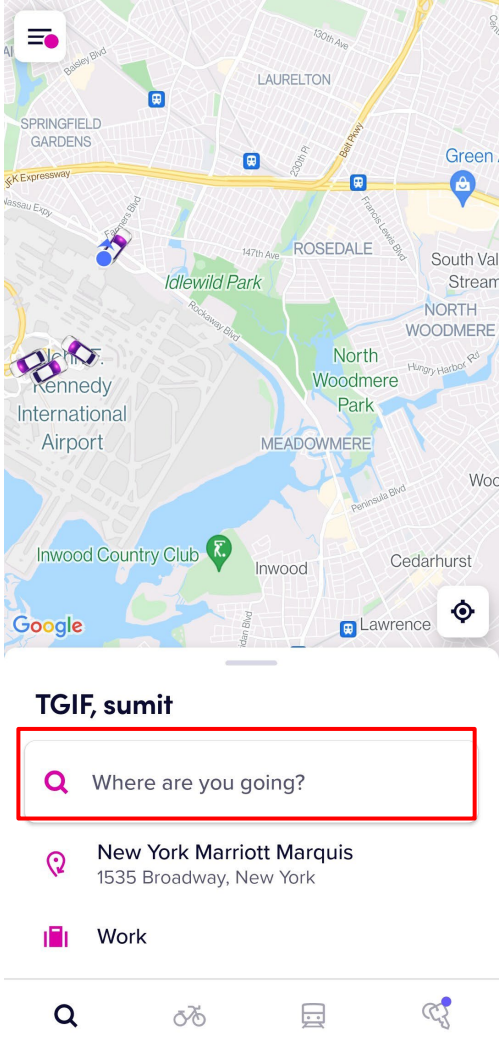
Claim 10,299,100	- Lyft's Accused Products
	 <p>The screenshot displays the Lyft mobile application interface. At the top, a map of New York City is shown, centered on the area around Kennedy International Airport and Idlewild Park. Below the map, the text "TGIF, sumit" is visible. A search bar with a magnifying glass icon contains the text "Where are you going?", which is highlighted with a red rectangular border. Below the search bar, there are two suggested destinations: "New York Marriott Marquis" with the address "1535 Broadway, New York" and "Work". At the bottom of the screen, there is a navigation bar with icons for search, bicycle, car, and a location pin.</p>

RESTRICTED CONFIDENTIAL SOURCE CODE

Attachment C for US Patent No. 10,299,100 Against Lyft Accused Products

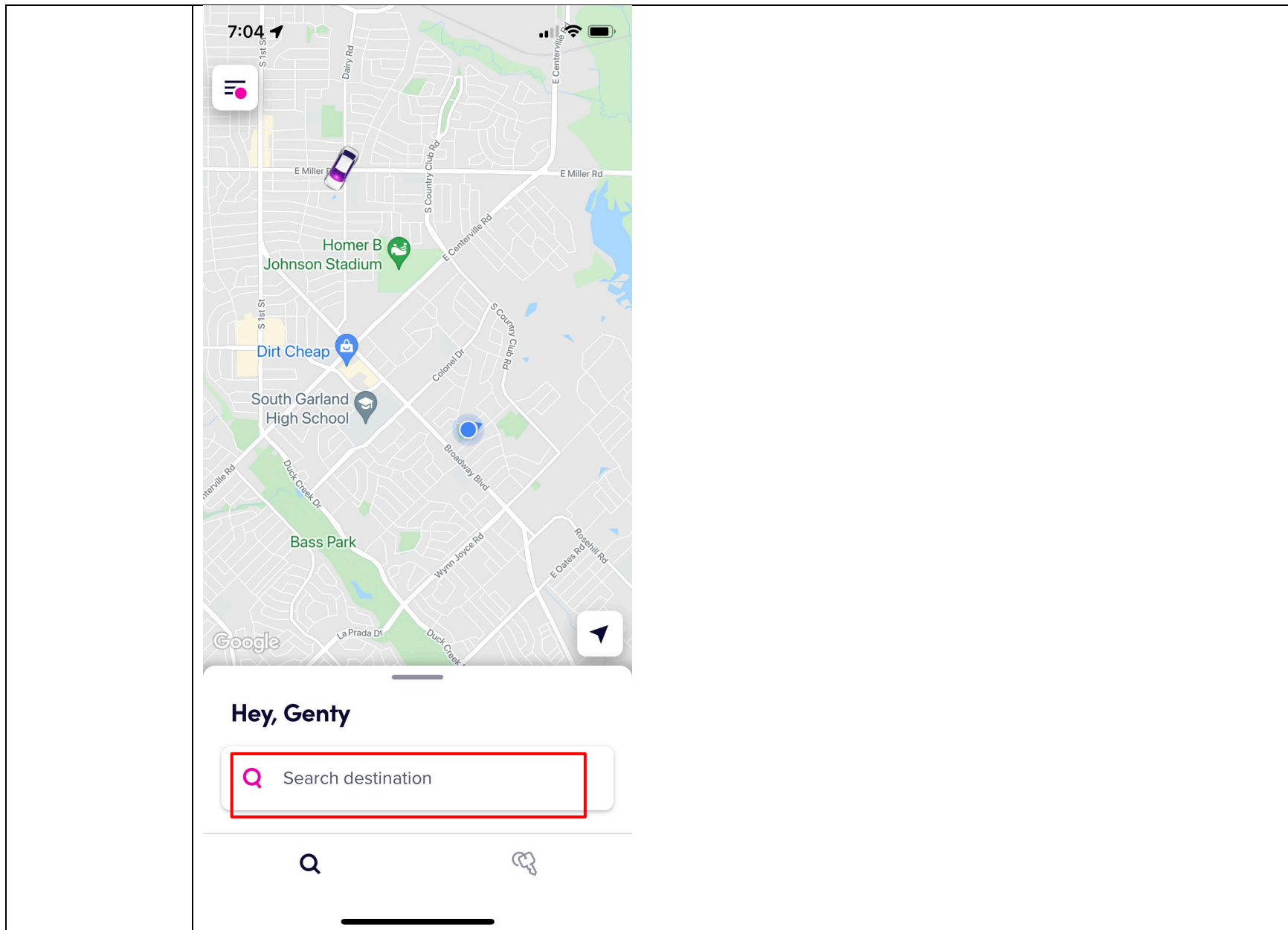

RESTRICTED CONFIDENTIAL SOURCE CODE**Attachment C for US Patent No. 10,299,100 Against Lyft Accused Products**

Claim 10,299,100	- Lyft's Accused Products
22. The method of claim 20, wherein the coordinates of the location of the event are determined based on coordinates of the second portion of the display and the coordinate translation data.	<p>The Lyft Accused Products infringe directly and/or indirectly by performing, inducing others to perform, and/or contributing to the performance of: the coordinates of the location of the event are determined based on coordinates of the second portion of the display and the coordinate translation data.</p> <p>See claims 20-21. For example, the coordinates of the destination address (“event”) are determined by the symbol placed in the second portion of the map by the passenger in the Lyft app.</p>
23. The method of claim 1, wherein the map is first map, wherein the coordinate translation data are first coordinate translation data, wherein an area depicted in the first map represents a first	<p>The Lyft Accused Products infringe directly and/or indirectly by performing, inducing others to perform, and/or contributing to the performance of: wherein the map is first map, wherein the coordinate translation data are first coordinate translation data, wherein an area depicted in the first map represents a first portion of an area depicted in a second map, and wherein the method further comprises: receiving, from a server, a third map representing a second portion of the area depicted in the second map and second coordinate translation data correlating coordinates of positions on the second map with corresponding coordinates of geographical locations.</p> <p>See claim 1. The Lyft app presents a map display to a user which can include multiple maps. The multiple maps can include multiple portions of the maps and can be modified via user interaction with the map or automatically based on information received from the Lyft app or Lyft server(s) or based on changes in location/orientation/view. The data used to present the maps can include multiple sets of coordinates.</p>

RESTRICTED CONFIDENTIAL SOURCE CODE

Attachment C for US Patent No. 10,299,100 Against Lyft Accused Products

Claim - 10,299,100	Lyft's Accused Products
<p>portion of an area depicted in a second map, and wherein the method further comprises: receiving, from a server, a third map representing a second portion of the area depicted in the second map and second coordinate translation data correlating coordinates of positions on the second map with corresponding coordinates of geographical locations.</p>	
<p>24[P]. A system comprising a mobile device contained in a portable housing, the mobile</p>	<p>The Lyft Accused Products comprise a system comprising a mobile device contained in a portable housing, the mobile device comprising</p>

RESTRICTED CONFIDENTIAL SOURCE CODE**Attachment C for US Patent No. 10,299,100 Against Lyft Accused Products**

Claim 10,299,100	- Lyft's Accused Products
device comprising:	<p>For example, Lyft provides the Lyft app for passengers and the Lyft Driver app for drivers. The Lyft apps for riders and drivers, in conjunction with Lyft's servers and services, provide users with interactive methods to request, view, and track locations of passengers/riders using real-time maps and communications via mobile phones to establish a wireless communication network.</p> <p>The Lyft apps for riders and drivers, in conjunction with Lyft's servers and services, provide users with interactive methods to request, view, and track locations of passengers/riders using real-time maps and communications. The Lyft server(s) and their services communicate with the Lyft apps for riders and drivers. The Lyft server(s) and their services host information related to and instructions for processing user/device/vehicle accounts, location data, and map data. The claimed methods are distributed by Lyft in the Lyft apps. The claimed methods are used/tested by Lyft using the Lyft apps. The claimed methods are downloaded and installed by Lyft's customers (riders) and personnel (drivers, personnel) at the direction/encouragement of Lyft and used by Lyft's customers and Lyft's personnel.</p> <p>This process is facilitated through drivers' and passengers' smart devices including but not limited to smartphones and tablets having Lyft and Lyft Driver app installed. The smart devices of passengers and drivers are contained in a portable housing.</p> <h2 data-bbox="468 987 957 1062">Lyft Driver app</h2> <div data-bbox="464 1101 1696 1182" style="border: 1px solid red; padding: 5px;"> <p>We've separated the passenger and driver experiences into two separate mobile apps — one exclusively for passengers (named the Lyft app) and the other exclusively for drivers (named the Lyft Driver app).</p> </div> <p>The Lyft Driver app will eventually be standard for all drivers and required for driving. At this time, drivers can keep using the Lyft app to give rides. Don't worry! While we have some planned improvements to the Lyft Driver app, we've kept its features the same.</p> <p>https://help.lyft.com/hc/en-ca/articles/115013079208-Lyft-Driver-app</p>

RESTRICTED CONFIDENTIAL SOURCE CODE

Attachment C for US Patent No. 10,299,100 Against Lyft Accused Products

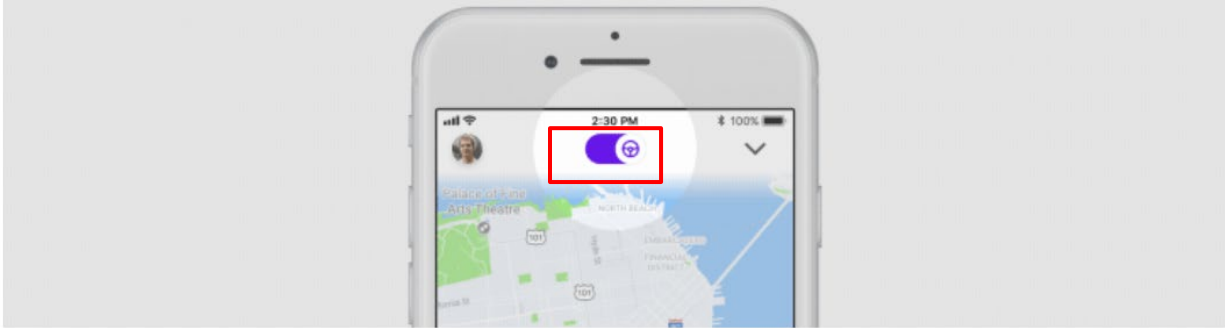
Claim 10,299,100	- Lyft's Accused Products
	<p data-bbox="468 331 768 380">What is Lyft?</p> <p data-bbox="468 433 1535 501">Lyft is a platform that connects drivers with individuals and organizations that need rides.</p> <p data-bbox="457 531 932 563">https://www.lyft.com/drive-with-lyft</p>  <p data-bbox="457 997 583 1024">Go online</p> <p data-bbox="457 1062 1654 1167">Open your Lyft Driver app and tap the steering wheel icon. Lyft will now find the closest passenger to your location requesting a ride. Turn on some music and get comfortable: that first ride request may come quickly or may take a while, depending on the number of current passenger requests.</p> <p data-bbox="457 1175 1115 1208">https://www.lyft.com/hub/posts/how-to-give-a-ride</p>

RESTRICTED CONFIDENTIAL SOURCE CODE

Attachment C for US Patent No. 10,299,100 Against Lyft Accused Products

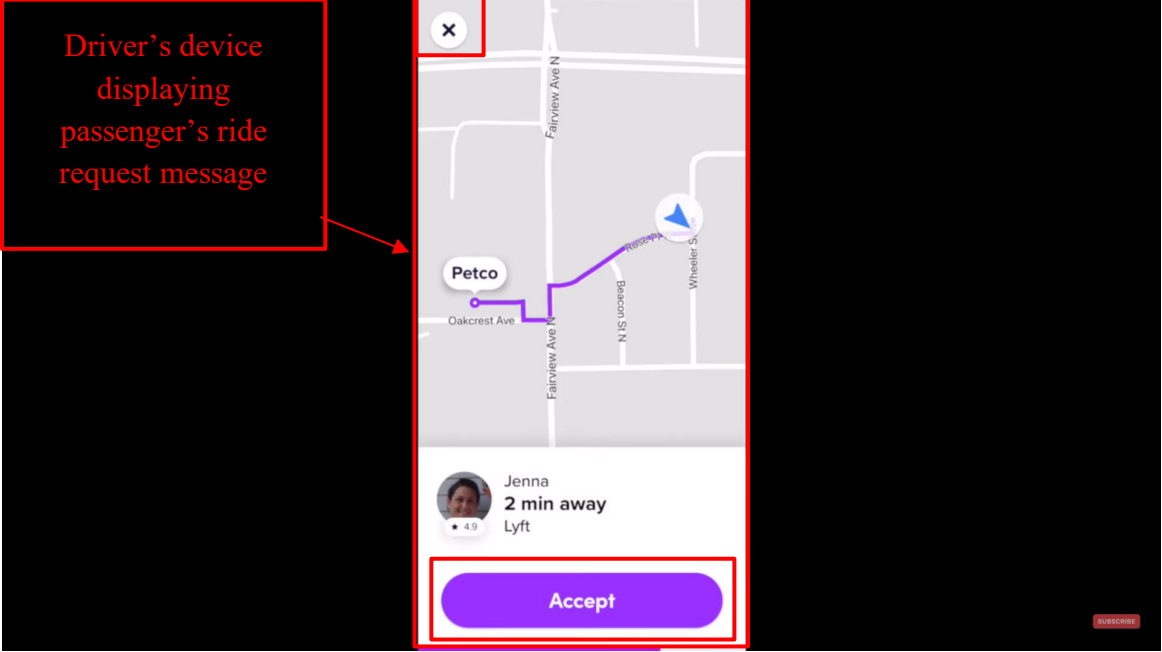
Claim 10,299,100	- Lyft's Accused Products
	<p data-bbox="506 347 722 505">Driver's device displaying passenger's ride request message</p>  <p data-bbox="453 967 1373 1000">https://www.youtube.com/watch?v=jVUy9poJDng at 10:24, Annotated</p>

RESTRICTED CONFIDENTIAL SOURCE CODE

Attachment C for US Patent No. 10,299,100 Against Lyft Accused Products

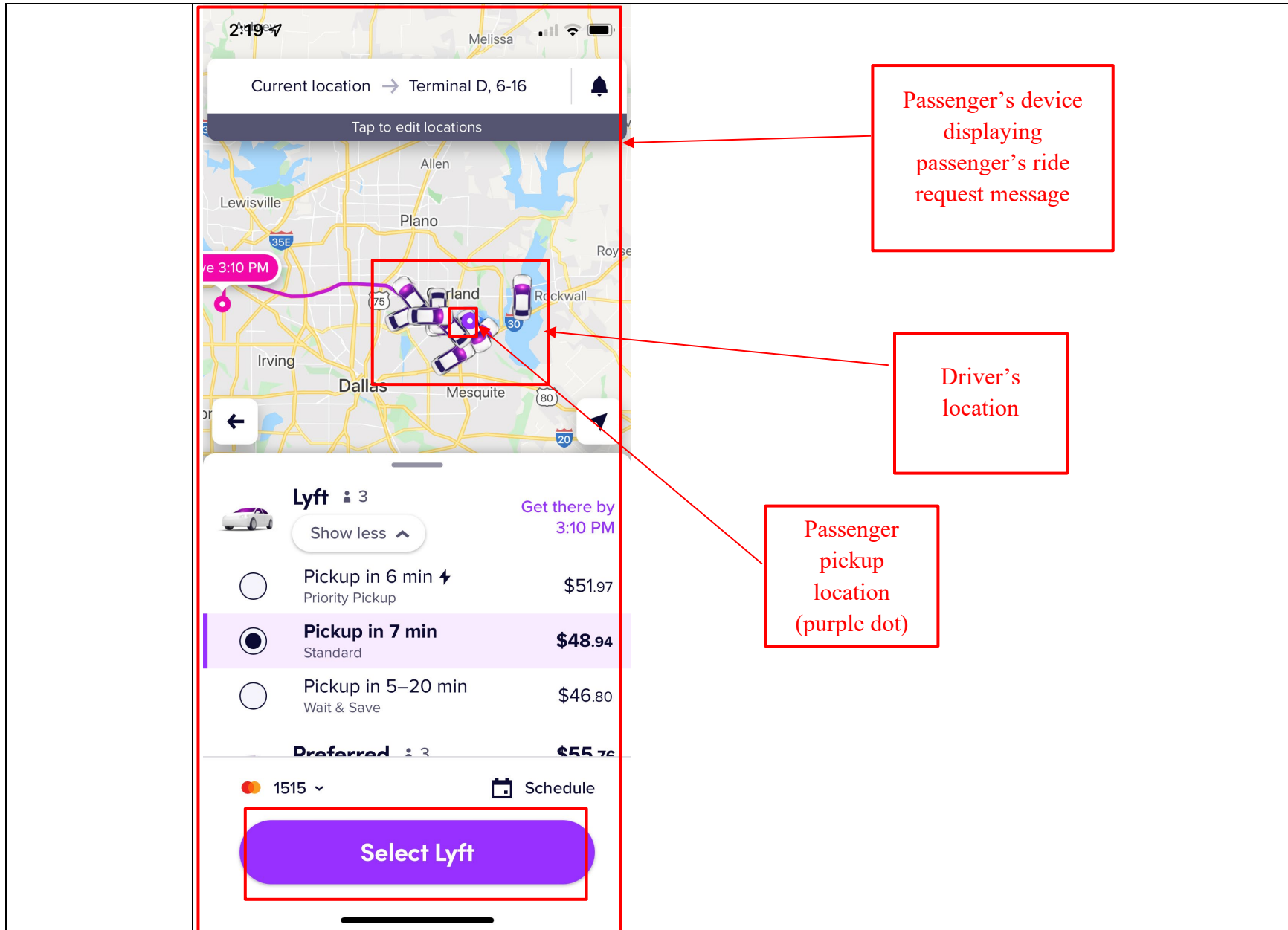

RESTRICTED CONFIDENTIAL SOURCE CODE

Attachment C for US Patent No. 10,299,100 Against Lyft Accused Products

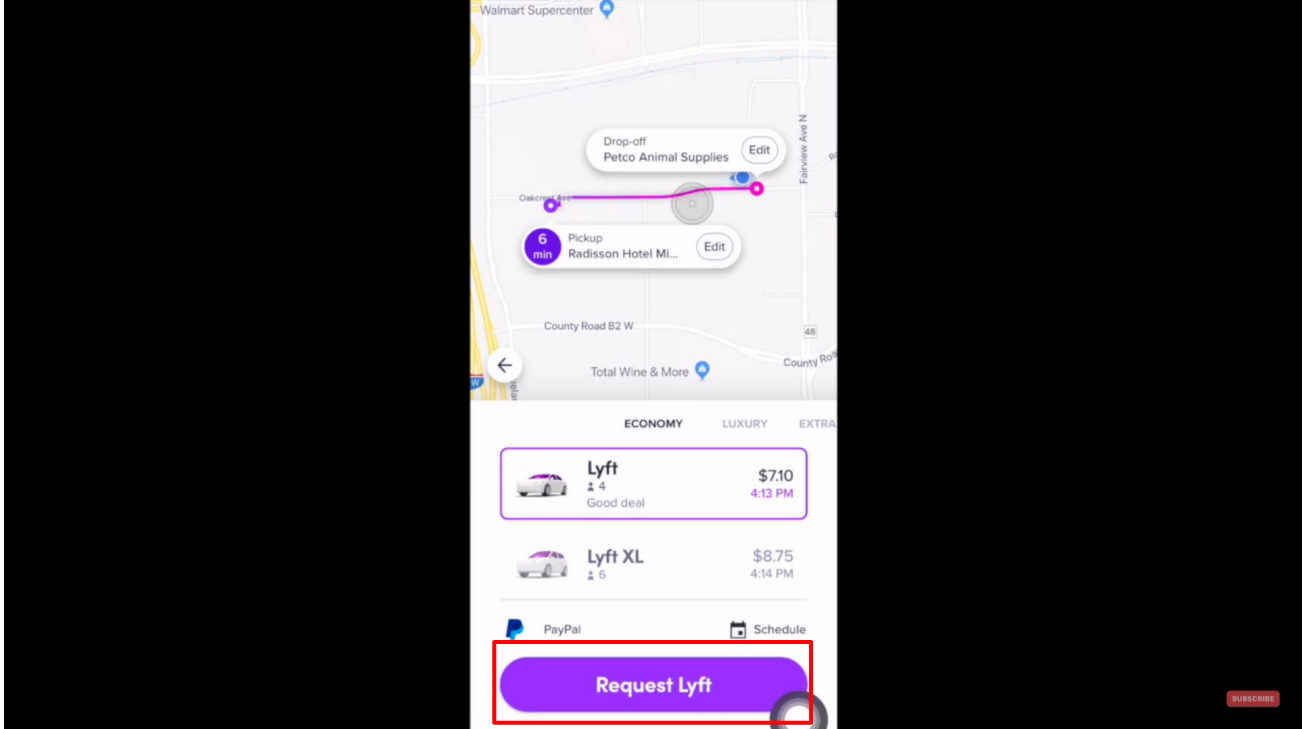
Claim 10,299,100	- Lyft's Accused Products
	 <p>https://www.youtube.com/watch?v=j0RDMLcmOgU at 4:01</p>

RESTRICTED CONFIDENTIAL SOURCE CODE

Attachment C for US Patent No. 10,299,100 Against Lyft Accused Products

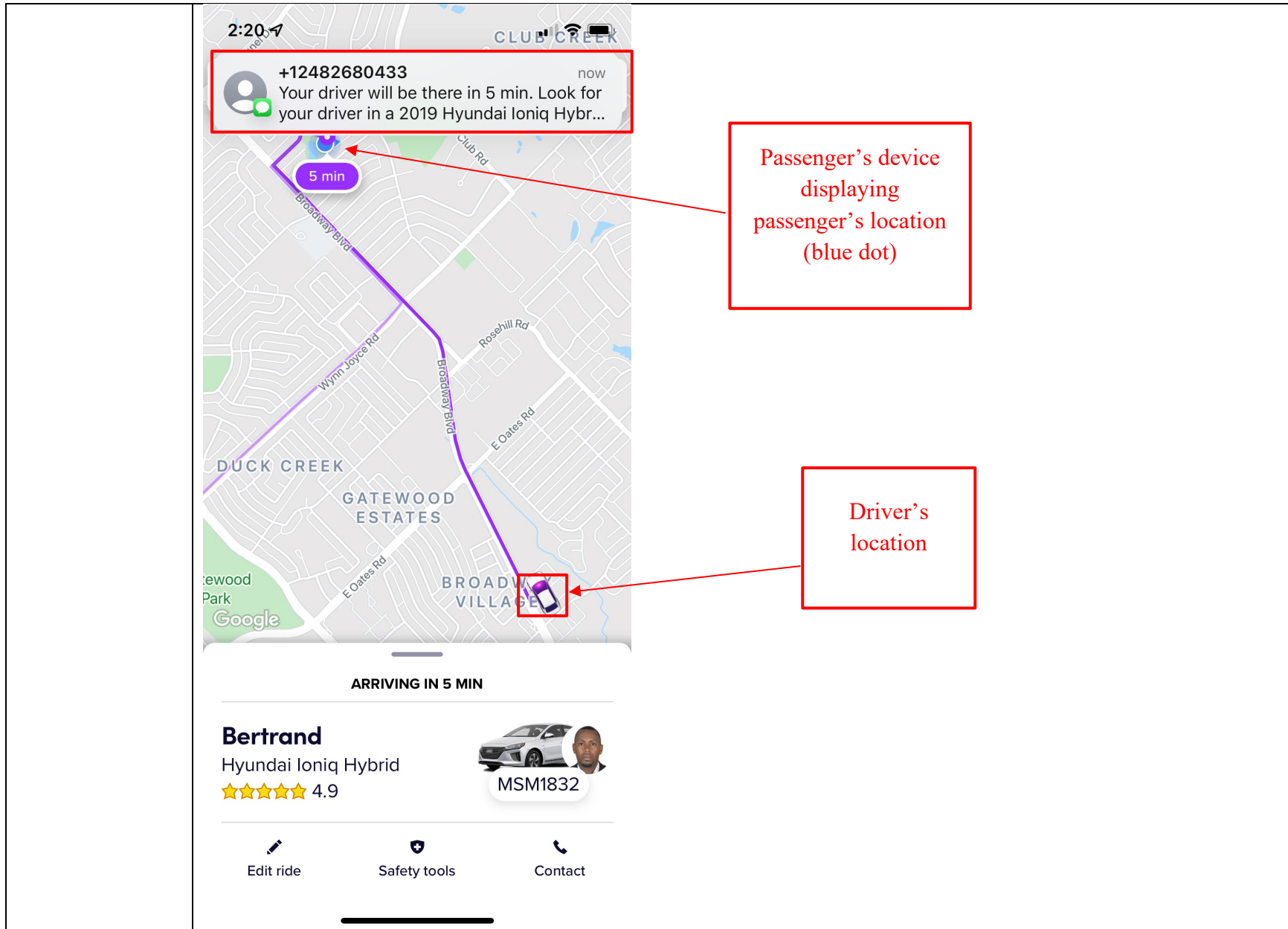

RESTRICTED CONFIDENTIAL SOURCE CODE

Attachment C for US Patent No. 10,299,100 Against Lyft Accused Products

Claim 10,299,100	- Lyft's Accused Products
	 <p>Photo: iFixit</p> <p>https://spectrum.ieee.org/telecom/wireless/building-smartphone-antennas-that-play-nice-together</p>
24[A]. a touch screen display, non-transitory	The Lyft Accused Products comprise a touch screen display, non-transitory computer-readable media, and a central processing unit (CPU).

RESTRICTED CONFIDENTIAL SOURCE CODE**Attachment C for US Patent No. 10,299,100 Against Lyft Accused Products**

Claim 10,299,100	- Lyft's Accused Products
computer-readable media, and a central processing unit (CPU);	For example, Lyft drivers' and passengers' smart devices including but not limited to smartphones and tablets (with the Lyft or Lyft Driver app installed) comprises a display, processor and storage media.

RESTRICTED CONFIDENTIAL SOURCE CODE

Attachment C for US Patent No. 10,299,100 Against Lyft Accused Products

Claim 10,299,100	- Lyft's Accused Products
	<p>Combining multiple components into a single chip saves on space, cost, and power consumption. Essentially, an SoC is the brain of your smartphone that handles everything from the Android operating system to detecting when you press the power off button. SoCs connect to other components too, such as cameras, a display, RAM, flash storage, and much more.</p> <p>The list below contains the most common components that you will find inside a smartphone System-on-a-Chip. We're going to cover a few of the most important ones later on in this article.</p> <ul style="list-style-type: none"> • Central Processing Unit (CPU) — The “brains” of the SoC. Runs most of the code for the Android OS and most of your apps. • Graphics Processing Unit (GPU) — Handles graphics-related tasks, such as visualizing an app's user interface and 2D/3D gaming. • Image Processing Unit (ISP) — Converts data from the phone's camera into image and video files. • Digital Signal Processor (DSP) — Handles more mathematically intensive functions than a CPU. Includes decompressing music files and analyzing gyroscope sensor data. • Neural Processing Unit (NPU) — Used in high-end smartphones to accelerate machine learning (AI) tasks. These include voice recognition and camera processing. • Video encoder/decoder — Handles the power-efficient conversion of video files and formats. • Modems — Converts wireless signals into data your phone understands. Components include 4G LTE, 5G, WiFi, and Bluetooth modems. <p>https://www.androidauthority.com/what-is-an-soc-smartphone-chipsets-explained-1051600/</p>
24[B]. a mobile device	The Lyft Accused Products comprise a mobile device transmitter communicatively coupled to the CPU.

RESTRICTED CONFIDENTIAL SOURCE CODE**Attachment C for US Patent No. 10,299,100 Against Lyft Accused Products**

Claim 10,299,100	- Lyft's Accused Products
transmitter communicatively coupled to the CPU;	<p>For example, Lyft drivers' and passengers' smart devices including but not limited to smartphones and tablets (with the Lyft or Lyft Driver app installed) comprise a transmitter module (antenna) coupled to a processor to send data.</p> <p>1. Antenna</p> <p>Antenna is used to receive and transmit radio frequency. It is inbuilt in the cabinet of the mobile phone. These are called inbuilt antenna.</p> <p>http://www.mobilecellphonerepairing.com/mobile-phone-parts.html</p>

RESTRICTED CONFIDENTIAL SOURCE CODE**Attachment C for US Patent No. 10,299,100 Against Lyft Accused Products**

Claim 10,299,100	- Lyft's Accused Products
	<p data-bbox="472 334 936 375">Mobile phone contents</p> <p data-bbox="472 418 1703 557">Mobile phones contain a large amount of circuitry, each of which is carefully designed to optimise its performance. The cell phone comprises analogue electronics as well as digital circuits ranging from processors to display and keypad electronics. A mobile phone typically consists of a single board, but within this there are a number of distinct functional areas, but designed to integrate to become a complete mobile phone:</p> <ul data-bbox="472 591 989 894" style="list-style-type: none"> <li data-bbox="472 591 989 634">• Radio frequency - receiver and transmitter <li data-bbox="472 651 789 678">• Digital signal processing <li data-bbox="472 703 837 730">• Analogue / digital conversion <li data-bbox="472 755 716 782">• Control processor <li data-bbox="472 807 705 834">• SIM or USIM card <li data-bbox="472 859 800 886">• Power control and battery <p data-bbox="453 924 1850 992">Source: https://www.electronics-notes.com/articles/connectivity/cellular-mobile-phone/how-cellphone-works-inside-components.php</p>
24[C]. a mobile device receiver communicatively coupled to the CPU;	<p data-bbox="453 1073 1745 1105">The Lyft Accused Products comprise a mobile device receiver communicatively coupled to the CPU.</p> <p data-bbox="453 1219 1892 1321">For example, Lyft drivers' and passengers' smart devices including but not limited to smartphones and tablets (with the Lyft or Lyft Driver app installed) comprise a receiver module (antenna) coupled to a processor to receive data.</p>

RESTRICTED CONFIDENTIAL SOURCE CODE**Attachment C for US Patent No. 10,299,100 Against Lyft Accused Products**

Claim 10,299,100	- Lyft's Accused Products
	<p data-bbox="457 337 680 380">1. Antenna</p> <p data-bbox="457 423 1635 500">Antenna is used to receive and transmit radio frequency. It is inbuilt in the cabinet of the mobile phone. These are called inbuilt antenna.</p> <p data-bbox="457 526 1331 553">http://www.mobilecellphonerepairing.com/mobile-phone-parts.html</p> <p data-bbox="470 613 936 656">Mobile phone contents</p> <p data-bbox="470 699 1703 834">Mobile phones contain a large amount of circuitry, each of which is carefully designed to optimise its performance. The cell phone comprises analogue electronics as well as digital circuits ranging from processors to display and keypad electronics. A mobile phone typically consists of a single board, but within this there are a number of distinct functional areas, but designed to integrate to become a complete mobile phone:</p> <ul data-bbox="478 862 989 1175" style="list-style-type: none"><li data-bbox="478 862 989 915">• Radio frequency - receiver and transmitter<li data-bbox="478 927 789 954">• Digital signal processing<li data-bbox="478 980 840 1008">• Analogue / digital conversion<li data-bbox="478 1034 716 1062">• Control processor<li data-bbox="478 1088 705 1115">• SIM or USIM card<li data-bbox="478 1141 800 1169">• Power control and battery <p data-bbox="449 1203 1850 1273">Source: https://www.electronics-notes.com/articles/connectivity/cellular-mobile-phone/how-cellphone-works-inside-components.php</p>

RESTRICTED CONFIDENTIAL SOURCE CODE

Attachment C for US Patent No. 10,299,100 Against Lyft Accused Products

Claim 10,299,100	Lyft's Accused Products
<p>24[D]. a global positioning system (GPS) receiver, communicatively coupled to the CPU, configured to obtain geographical coordinates corresponding to a geographical location of the mobile device;</p>	<p>The Lyft Accused Products comprise a global positioning system (GPS) receiver, communicatively coupled to the CPU, configured to obtain geographical coordinates corresponding to a geographical location of the mobile device.</p> <p>For example, Lyft drivers' and passengers' smart devices including but not limited to smartphones and tablets (with the Lyft or Lyft Driver app installed) comprise a GPS module coupled to a processor to determine the location of the smart device.</p> <p>You must have seen that every Android and iOS device in today's age comes with GPS right inside it. This is one feature that will be there in every smartphone no matter what the price of that device might be. And that is because of the fact that GPS is the most basic yet most useful feature on every smartphone.</p> <p>Just for information, the GPS stands for Global Positioning System and it provides accurate geolocation and time information for every equipment that is equipped with a GPS receiver. Now, the best example of using GPS is with services such as Google Maps, Apple Maps, and others where you can see where exactly you are right now on the Map. This is thanks to the GPS receiver which sends a signal to the GPS satellite.</p> <p>https://www.cashify.in/how-to-turn-off-gps-on-any-android-or-ios-device</p>
<p>24[E]. the CPU configured to</p>	<p>See Claim 1[A] above.</p>

RESTRICTED CONFIDENTIAL SOURCE CODE**Attachment C for US Patent No. 10,299,100 Against Lyft Accused Products**

Claim 10,299,100	- Lyft's Accused Products
execute instructions to perform operations comprising:	
24[F]. associating the mobile device with an identifier, wherein the identifier corresponds to a network participant	<i>See Claim 1[B] above.</i>
24[G]. determining, by the CPU, a device location corresponding to the geographical location of the mobile device based on the geographical coordinates obtained by the GPS receiver located within	<i>See Claim 1[C] above.</i>

RESTRICTED CONFIDENTIAL SOURCE CODE**Attachment C for US Patent No. 10,299,100 Against Lyft Accused Products**

Claim 10,299,100	- Lyft's Accused Products
the mobile device;	
24[H]. receiving, from a server, mapping data including a map and coordinate translation data correlating coordinates of positions on the map with corresponding coordinates of geographical locations	<i>See Claim 1[D] above.</i>
24[I]. receiving, from a server, location data indicating vehicle locations of one or more vehicles	<i>See Claim 1[E] above.</i>
24[J]. marking the map with a plurality of symbols comprising: a participant symbol	<i>See Claim 1[F] above.</i>

RESTRICTED CONFIDENTIAL SOURCE CODE

Attachment C for US Patent No. 10,299,100 Against Lyft Accused Products

Claim - 10,299,100	Lyft's Accused Products
corresponding to the device location, one or more facility symbols corresponding to respective facility locations of one or more facilities, and one or more vehicle symbols corresponding to respective vehicle locations of the one or more vehicles, wherein marking the map comprises:	
24[K]. determining, based at least in part on the vehicle locations and the coordinate translation data, positions on the map	<i>See Claim 1[G] above.</i>

RESTRICTED CONFIDENTIAL SOURCE CODE

Attachment C for US Patent No. 10,299,100 Against Lyft Accused Products

Claim - 10,299,100	Lyft's Accused Products
<p>corresponding to the vehicle locations, displaying the map on the display of the mobile device, and placing the vehicle symbols on the map at the determined positions corresponding to the vehicle locations;</p>	
<p>24[L]. responsive to user selection of a portion of the display corresponding to a position on the map, identifying a selected facility symbol based on the selected position, comprising: initiating a</p>	<p>See Claim 1[H] above.</p>

RESTRICTED CONFIDENTIAL SOURCE CODE

Attachment C for US Patent No. 10,299,100 Against Lyft Accused Products

Claim - 10,299,100	Lyft's Accused Products
search of a set of symbols including the facility symbols for a symbol located nearest to the selected position and, based on a result of the search, identifying the selected facility symbol as the symbol located nearest to the selected position;	
24[M]. after receiving user input on the touch screen display, transmitting, by the mobile device transmitter, first information to a first vehicle of the one or more vehicles; and	<i>See Claim 1[I] above.</i>

RESTRICTED CONFIDENTIAL SOURCE CODE**Attachment C for US Patent No. 10,299,100 Against Lyft Accused Products**

Claim - 10,299,100	Lyft's Accused Products
24[N]. after transmitting the first information to the first vehicle, receiving, at the mobile device receiver, second information corresponding to the first vehicle and displaying the received second information on the touch screen display of the mobile device,	<i>See Claim 1[J] above.</i>
24[O]. wherein the mobile device does not have access to a phone number associated with a computing device corresponding to the first vehicle, an Internet Protocol (IP)	<i>See Claim 1[K] above.</i>

RESTRICTED CONFIDENTIAL SOURCE CODE**Attachment C for US Patent No. 10,299,100 Against Lyft Accused Products**

Claim 10,299,100	- Lyft's Accused Products
<p>address associated with the computing device corresponding to the first vehicle, and an e-mail address associated with the computing device corresponding to the first vehicle.</p>	
<p>25. The system of claim 24, wherein the operations further comprise: receiving, from a server, at the mobile device receiver, updated respective vehicle locations of the one or more vehicles; and updating, based on the received updated vehicle</p>	<p><i>See Claim 5 above.</i></p>

RESTRICTED CONFIDENTIAL SOURCE CODE**Attachment C for US Patent No. 10,299,100 Against Lyft Accused Products**

Claim - 10,299,100	Lyft's Accused Products
locations and the coordinate translation data, positions of the one or more vehicle symbols on the map displayed on the touch screen display.	
26. The system of claim 24, wherein the operations further comprise: communicating, by the mobile device transmitter, the identifier to a server; and joining a communication network after the communication of the first identifier to the server.	<i>See Claim 10 above.</i>
27. The system of claim 26,	<i>See Claim 11 above.</i>

RESTRICTED CONFIDENTIAL SOURCE CODE

Attachment C for US Patent No. 10,299,100 Against Lyft Accused Products

Claim - 10,299,100	Lyft's Accused Products
<p>wherein the identifier is a first identifier, and wherein the communication network comprises one or more communication devices corresponding, respectively, to one or more second vehicles, and wherein each of the one or more communication devices is associated with a respective second identifier.</p>	
<p>28. The system of claim 27, wherein the operations further comprise: receiving, by the mobile device receiver, the</p>	<p>The Lyft Accused Products infringe directly and/or indirectly by performing, inducing others to perform, and/or contributing to the performance of: the operations further comprise: receiving, by the mobile device receiver, the second identifiers corresponding to one or more communication devices; and displaying, on the map displayed on the touch screen display, one or more second vehicle symbols corresponding to the second identifiers corresponding to the second vehicles.</p>

RESTRICTED CONFIDENTIAL SOURCE CODE**Attachment C for US Patent No. 10,299,100 Against Lyft Accused Products**

Claim 10,299,100	- Lyft's Accused Products
<p>second identifiers corresponding to one or more communication devices; and displaying, on the map displayed on the touch screen display, one or more second vehicle symbols corresponding to the second identifiers corresponding to the second vehicles.</p>	<p>For example, before a passenger requests for a ride, the Lyft app displays symbols corresponding to multiple vehicles based on their location near the passenger's location. Therefore, Lyft's servers fetch identifiers and locations of the drivers and their vehicles and display the drivers as symbols on the passenger's mobile device.</p>

RESTRICTED CONFIDENTIAL SOURCE CODE

Attachment C for US Patent No. 10,299,100 Against Lyft Accused Products

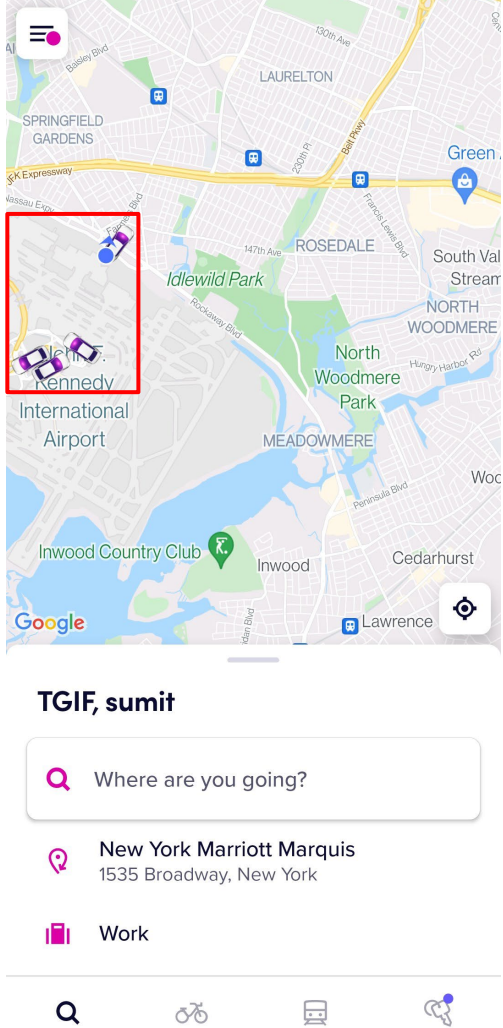
Claim 10,299,100	- Lyft's Accused Products
	

RESTRICTED CONFIDENTIAL SOURCE CODE

Attachment C for US Patent No. 10,299,100 Against Lyft Accused Products

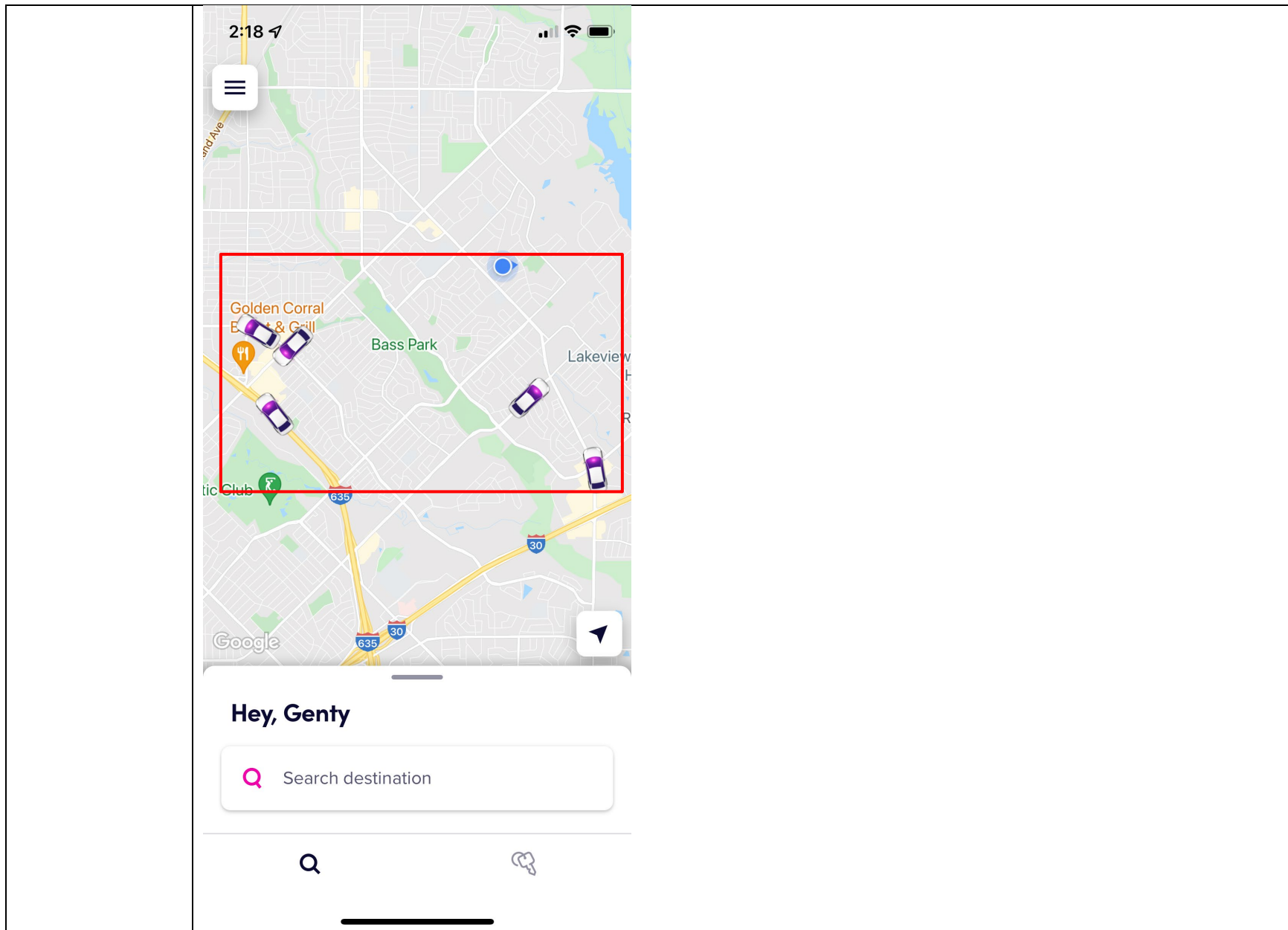

RESTRICTED CONFIDENTIAL SOURCE CODE**Attachment C for US Patent No. 10,299,100 Against Lyft Accused Products**

Claim 10,299,100	- Lyft's Accused Products
	Further, to the extent this element is performed at least in part by Lyft's software source code, AGIS reserves the right to supplement these contentions pursuant to production of such source code by Lyft and to the extent Lyft requires additional information in accordance with P.R. 3-1 and for any other reasons.
29. The system of claim 27, wherein the operations further comprise: receiving, by the mobile device receiver, the second identifiers corresponding to one or more communication devices; and displaying, on the map displayed on the touch screen display, one or more second vehicle symbols corresponding to the second identifiers corresponding to the second vehicles.	<i>See Claim 12 above.</i>

RESTRICTED CONFIDENTIAL SOURCE CODE**Attachment C for US Patent No. 10,299,100 Against Lyft Accused Products**

Claim - 10,299,100	Lyft's Accused Products
<p>30. The system of claim 24, wherein: transmitting the first information to the first vehicle comprises transmitting data to a server using an Internet Protocol; the data transmitted to the server includes the first information and a second identifier corresponding to a second network participant associated with the computing device corresponding to the first vehicle; the second information corresponding to the first vehicle;</p>	<p>The Lyft Accused Products infringe directly and/or indirectly by performing, inducing others to perform, and/or contributing to the performance of: The system of claim 24, wherein: transmitting the first information to the first vehicle comprises transmitting data to a server using an Internet Protocol; the data transmitted to the server includes the first information and a second identifier corresponding to a second network participant associated with the computing device corresponding to the first vehicle; the second information corresponding to the first vehicle is transmitted by the server to the mobile device using the Internet Protocol; and an IP address of the server is accessible to the mobile device.</p> <p>For example, Lyft's servers access passengers' and drivers' data through the Lyft app installed on the passengers' and drivers' mobile devices using an Internet Protocol. All information including but not limited to the location information and the identifier are transmitted to the Lyft servers via Internet Protocol.</p> <h2 data-bbox="470 841 957 915">Lyft Driver app</h2> <div data-bbox="464 954 1696 1036" style="border: 1px solid red; padding: 5px;"> <p>We've separated the passenger and driver experiences into two separate mobile apps — one exclusively for passengers (named the Lyft app) and the other exclusively for drivers (named the Lyft Driver app).</p> </div> <p>The Lyft Driver app will eventually be standard for all drivers and required for driving. At this time, drivers can keep using the Lyft app to give rides. Don't worry! While we have some planned improvements to the Lyft Driver app, we've kept its features the same.</p> <p>https://help.lyft.com/hc/en-ca/articles/115013079208-Lyft-Driver-app</p>

RESTRICTED CONFIDENTIAL SOURCE CODE

Attachment C for US Patent No. 10,299,100 Against Lyft Accused Products

Claim - 10,299,100	Lyft's Accused Products
<p>the first vehicle is transmitted by the server to the mobile device using the Internet Protocol; and an IP address of the server is accessible to the mobile device.</p>	<p>What is Lyft?</p> <p>Lyft is a platform that connects drivers with individuals and organizations that need rides.</p> <p>https://www.lyft.com/drive-with-lyft</p> <p>Further, to the extent this element is performed at least in part by Lyft's software source code, AGIS reserves the right to supplement these contentions pursuant to production of such source code by Lyft and to the extent Defendant requires additional information in accordance with P.R. 3-1 and for any other reasons.</p>
<p>31. The system of claim 30, wherein: the server stores an IP address of the computing device associated with the second network participant identified by the second identifier; and the server transmits the first information to the computing device corresponding to</p>	<p><i>See claim 30 above.</i></p>

RESTRICTED CONFIDENTIAL SOURCE CODE

Attachment C for US Patent No. 10,299,100 Against Lyft Accused Products

Claim 10,299,100	- Lyft's Accused Products
the first vehicle in a message addressed to the stored IP address of the computing device corresponding to the first vehicle.	

Attachment D for US Patent No. 8,213,970 Against Lyft Accused Products

Based on information presently available,¹ Defendant AGIS Software Development LLC (“AGIS Software”) contends that Defendant Lyft Technologies Inc. (“Lyft” or “Plaintiff”) infringes claims 2, 10, 12, and 13 (the “Asserted Claims”) of U.S. Patent No. 8,213,970 (the “’970 Patent”) through the Accused Products which are manufactured, sold, offered for sale, and/or used by Lyft

The Accused Products comprise the Lyft and Lyft Driver applications, servers, and services manufactured, used, or sold by Lyft, Inc. during and after 2016. AGIS Software reserves the right to seek leave of court to amend this list of Accused Products after the filing of an amended complaint or as discovery progresses.

Lyft directly infringes each of the Asserted Claims by making, using, importing, testing, distributing, selling, and/or offering for sale the Accused Products in violation of 35 U.S.C. § 271(a).

Lyft indirectly infringes the Asserted Claims in violation of 35 U.S.C. § 271(b) by inducing third parties, including its users and/or customers, to directly infringe through their operation and use of the Accused Products. Lyft has knowingly and intentionally induced this direct infringement by, *inter alia*, (i) selling, importing, or otherwise providing the Accused Products to third parties with the intent that the Accused Products will be operated and used in a manner that practices the Asserted Claims; and (ii) marketing and advertising the Accused Products. Lyft’s marketing and promotional materials for the Accused Products are found, for example, on Lyft’s website, and in App stores of operating systems for which the Accused Products are made available. For example, Lyft’s website offers customers instructions and/or manuals for the Accused Products that instruct customers to, among other things, use the accused services in the Accused Products. Lyft’s website also offers support to customers, including instruction to, among other things, use the Accused Products share location information with a group of users. Lyft knows, or should have known, that its actions will result in infringement of the Asserted Claims, or subjectively believes that there is a high probability that its actions will result in infringement of the Asserted Claims but has taken deliberate actions to avoid learning these facts.

Lyft also contributorily infringes each of the Asserted Claims in violation of 35 U.S.C. § 271(c) by selling, importing, offering for sale, and otherwise providing the Accused Products, which when used directly infringe the Asserted Claims. The Accused Products constitute a material part of the Asserted Claims.

¹ There is no operative complaint asserting non-infringement of any patent claim in this action at this time. AGIS Software reserves the right to update its contentions upon receipt of any future amended complaint.

Attachment D for US Patent No. 8,213,970 Against Lyft Accused Products

The following chart identifies specifically where each limitation of each Asserted Claim is found within the Accused Products, and in particular, the corresponding elements that meet the limitations in the Lyft and Lyft Driver applications, services, and services. On information and belief, each charted version of the Lyft Rider and Driver Apps are representative of all versions of the Accused Products, including all variants of the Accused Products made, sold, offered for sale, or used on any version of the Android and iOS operating systems.

AGIS Software does not concede that any claims of the '970 Patent that are not listed below are not infringed by the identified Accused Products. Moreover, the citations to certain documents and other information below are intended to be exemplary only and in no way foreclose AGIS from citing or relying on additional documents, information, source code, and/or testimony at a later time. These contentions are preliminary in nature and an analysis of Lyft's products, internal documentation, source code, and/or testimony from relevant witnesses may more fully and accurately describe the infringing features of its accused products. Accordingly, AGIS Software reserves the right to seek leave of court to supplement, correct, modify, and/or amend these contentions once such additional information is made available to AGIS Software. Furthermore, AGIS Software reserves the right to seek leave of court to supplement, correct, modify, and/or amend these contentions as discovery in this case progresses; in view of the Court's claim construction order(s);² in view of any positions taken by Lyft, including but not limited to positions on claim construction, invalidity, and/or non-infringement; and in connection with the preparation and exchange of expert reports.

The contents of each claim cell below on which another claim cell depends are expressly incorporated by reference in that dependent cell, as if set forth in their entirety therein.

² The construction of claim terms herein is consistent with the constructions in *AGIS Software Dev. LLC v. Huawei Device USA, Inc.*, No. 2:17-cv-00513-JRG, Dkt. 205 (E.D. Tex. Oct. 10, 2018); *AGIS Software Dev. LLC v. Google LLC*, No. 2:19-cv-00361-JRG, Dkt. 147 (E.D. Tex. Dec. 8, 2020); *AGIS Software Dev. LLC v. T-Mobile USA, Inc., et al.*, No. 2:21-cv-00072-JRG, Dkt. 213 (E.D. Tex. Nov. 10, 2021). AGIS Software reserves the right to update its constructions and contentions in view of this Court's claim construction order.

RESTRICTED CONFIDENTIAL SOURCE CODE

Attachment D for US Patent No. 8,213,970 Against Lyft Accused Products

Claim - 8,213,970	Exemplary Supporting Evidence Regarding Accused Products
<p>(Unasserted) 1[P]. A communication system for transmitting, receiving, confirming receipt, and responding to an electronic message, comprising:</p>	<p>The Lyft Accused Products comprise a communication system for transmitting, receiving, confirming receipt, and responding to an electronic message.</p> <p>For example, Lyft provides Lyft Rider app for passengers and Lyft Driver app for drivers. The Lyft apps for riders and drivers, in conjunction with Lyft’s servers and services, provide users with interactive methods to request, view, and track locations of passengers/riders using real-time maps and communications. The Lyft server(s) and their services communicate with the Lyft apps for riders and drivers. The Lyft server(s) and their services host information related to and instructions for processing user/device/vehicle accounts, location data, and map data. The claimed methods are distributed by Lyft in the Lyft apps. The claimed methods are used/tested by Lyft using the Lyft apps. The claimed methods are downloaded and installed by Lyft’s customers (riders) and personnel (drivers, personnel) at the direction/encouragement of Lyft and used by Lyft’s customers and Lyft’s personnel.</p> <p>The Lyft Driver application receives an electronically transmitted request for a ride message and acknowledges the receipt of the message which triggers a forced message alert that locks the device for a period of time until the driver sends a response message (decline or accept) to clear the locked display (“transmitting, receiving, confirming receipt, and responding to an electronic message”).</p> <h2 data-bbox="489 1062 978 1138">Lyft Driver app</h2> <div data-bbox="485 1175 1719 1260" style="border: 1px solid red; padding: 5px;"> <p>We’ve separated the passenger and driver experiences into two separate mobile apps — one exclusively for passengers (named the Lyft app) and the other exclusively for drivers (named the Lyft Driver app).</p> </div> <p>The Lyft Driver app will eventually be standard for all drivers and required for driving. At this time, drivers can keep using the Lyft app to give rides. Don’t worry! While we have some planned improvements to the Lyft Driver app, we’ve kept its features the same.</p>

RESTRICTED CONFIDENTIAL SOURCE CODE

Attachment D for US Patent No. 8,213,970 Against Lyft Accused Products

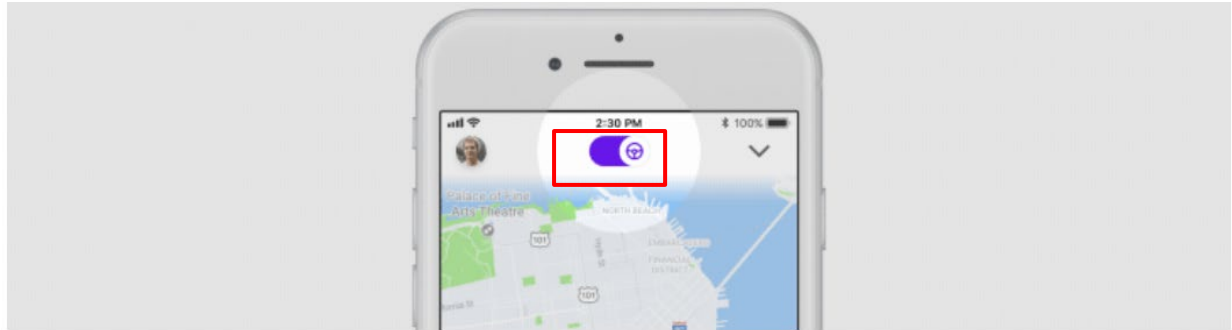
Claim - 8,213,970	Exemplary Supporting Evidence Regarding Accused Products
	<p data-bbox="478 321 1377 358">https://help.lyft.com/hc/en-ca/articles/115013079208-Lyft-Driver-app</p> <h2 data-bbox="487 407 793 456">What is Lyft?</h2> <p data-bbox="487 508 1560 578">Lyft is a platform that connects drivers with individuals and organizations that need rides.</p> <p data-bbox="478 605 957 643">https://www.lyft.com/drive-with-lyft</p>  <p data-bbox="478 1073 606 1101">Go online</p> <p data-bbox="478 1138 1682 1247">Open your Lyft Driver app and tap the steering wheel icon. Lyft will now find the closest passenger to your location requesting a ride. Turn on some music and get comfortable: that first ride request may come quickly or may take a while, depending on the number of current passenger requests.</p> <p data-bbox="478 1252 1140 1289">https://www.lyft.com/hub/posts/how-to-give-a-ride</p>

RESTRICTED CONFIDENTIAL SOURCE CODE

Attachment D for US Patent No. 8,213,970 Against Lyft Accused Products

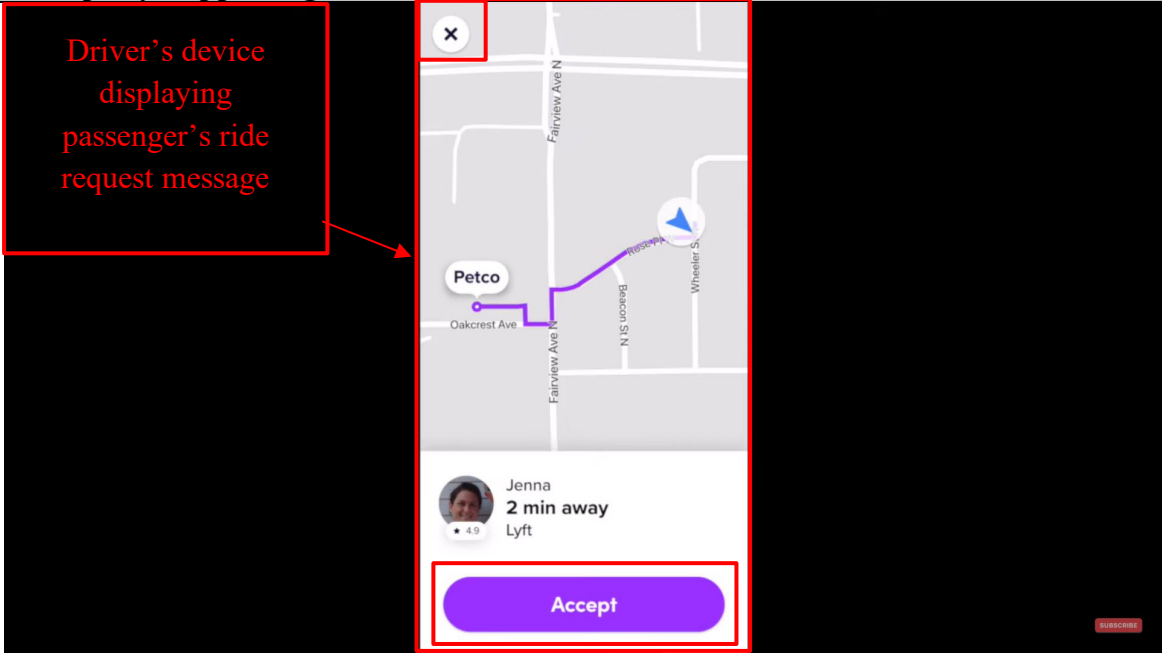
Claim - 8,213,970	Exemplary Supporting Evidence Regarding Accused Products
	<p data-bbox="527 315 743 475">Driver's device displaying passenger's ride request message</p>  <p data-bbox="480 935 1396 967">https://www.youtube.com/watch?v=jVUy9poJDng at 10:24, Annotated</p>

RESTRICTED CONFIDENTIAL SOURCE CODE

Attachment D for US Patent No. 8,213,970 Against Lyft Accused Products

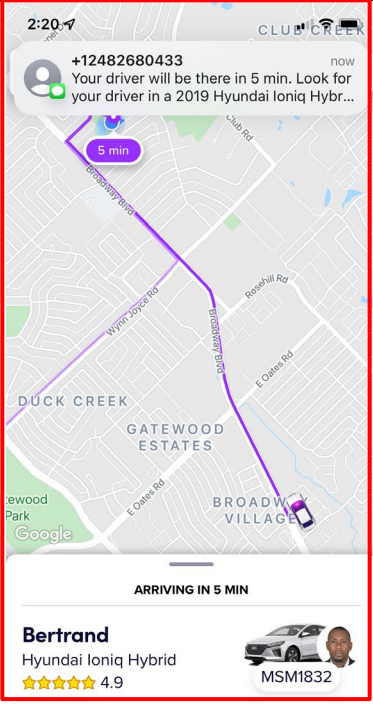
Claim - 8,213,970	Exemplary Supporting Evidence Regarding Accused Products
	 <p>The screenshot shows a mobile app interface for a ride confirmation. At the top, the time is 2:20. A notification bubble from the number +12482680433 says "Your driver will be there in 5 min. Look for your driver in a 2019 Hyundai Ioniq Hybr...". Below this is a map showing a purple route from a starting point to a destination, with a "5 min" timer. The map labels include "DUCK CREEK", "GATEWOOD ESTATES", and "BROADWAY VILLAGE". Below the map, it says "ARRIVING IN 5 MIN". The driver's name is "Bertrand", the car is a "Hyundai Ioniq Hybrid", and the rating is "4.9" (5 stars). The license plate is "MSM1832". At the bottom are icons for "Edit ride", "Safety tools", and "Contact".</p> <p data-bbox="1003 342 1325 592">Passenger's device displaying passenger's ride request message</p>

RESTRICTED CONFIDENTIAL SOURCE CODE

Attachment D for US Patent No. 8,213,970 Against Lyft Accused Products

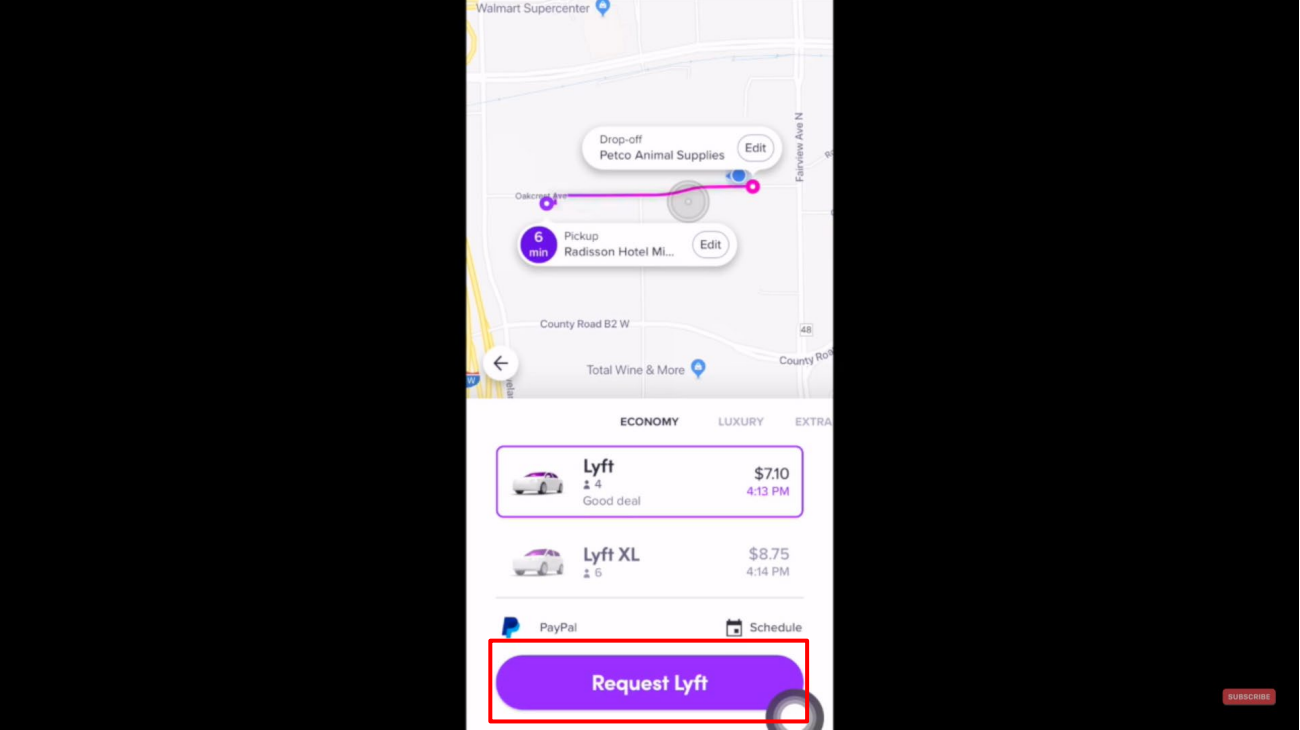
Claim - 8,213,970	Exemplary Supporting Evidence Regarding Accused Products
	 <p>https://www.youtube.com/watch?v=j0RDMLcmOgU at 4:01</p> <p>Further, to the extent this element is performed at least in part by Lyft's software source code, AGIS reserves the right to supplement these contentions pursuant to production of such source code by Lyft and to the extent Lyft requires additional information in accordance with P.R. 3-1 and for any other reasons.</p>

RESTRICTED CONFIDENTIAL SOURCE CODE

Attachment D for US Patent No. 8,213,970 Against Lyft Accused Products

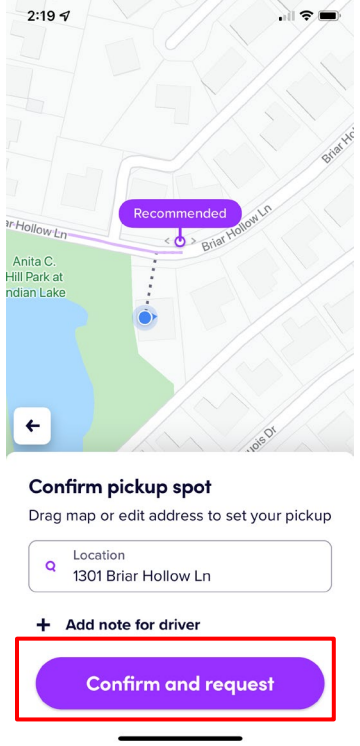
Claim - 8,213,970	Exemplary Supporting Evidence Regarding Accused Products
	 <p>The screenshot shows a mobile application interface for confirming a pickup location. At the top, there is a map with a purple dot indicating a 'Recommended' pickup spot at 1301 Briar Hollow Ln. Below the map, the text 'Confirm pickup spot' is displayed, followed by the instruction 'Drag map or edit address to set your pickup'. A search bar contains the text 'Location 1301 Briar Hollow Ln'. Below the search bar, there is a plus sign icon and the text '+ Add note for driver'. At the bottom, a large purple button with the text 'Confirm and request' is highlighted with a red rectangular border.</p>
<p>1[A]. a predetermined network of participants, wherein each participant has a similarly equipped PDA/cell phone</p>	<p>The Lyft Accused Products comprise: a predetermined network of participants, wherein each participant has a similarly equipped PDA/cell phone that includes a CPU and a touch screen display a CPU and memory.</p> <p>For example, Lyft is a network of drivers and passengers where drivers connect with individuals requesting a ride. Drivers access the platform using the Lyft Driver app and passengers access the platform using the Lyft</p>

RESTRICTED CONFIDENTIAL SOURCE CODE

Attachment D for US Patent No. 8,213,970 Against Lyft Accused Products

Claim - 8,213,970	Exemplary Supporting Evidence Regarding Accused Products
<p>that includes a CPU and a touch screen display a CPU and memory</p>	<p>app on their respective smart devices including but not limited to smartphones and tablets comprising a display, a processor and a storage media.</p> <h2 data-bbox="489 402 978 480">Lyft Driver app</h2> <div data-bbox="485 516 1719 602" style="border: 1px solid red; padding: 5px;"><p>We've separated the passenger and driver experiences into two separate mobile apps — one exclusively for passengers (named the Lyft app) and the other exclusively for drivers (named the Lyft Driver app).</p></div> <p>The Lyft Driver app will eventually be standard for all drivers and required for driving. At this time, drivers can keep using the Lyft app to give rides. Don't worry! While we have some planned improvements to the Lyft Driver app, we've kept its features the same.</p> <p>https://help.lyft.com/hc/en-ca/articles/115013079208-Lyft-Driver-app</p> <h2 data-bbox="489 834 789 883">What is Lyft?</h2> <p>Lyft is a platform that connects drivers with individuals and organizations that need rides.</p> <p>https://www.lyft.com/drive-with-lyft</p>

RESTRICTED CONFIDENTIAL SOURCE CODE

Attachment D for US Patent No. 8,213,970 Against Lyft Accused Products

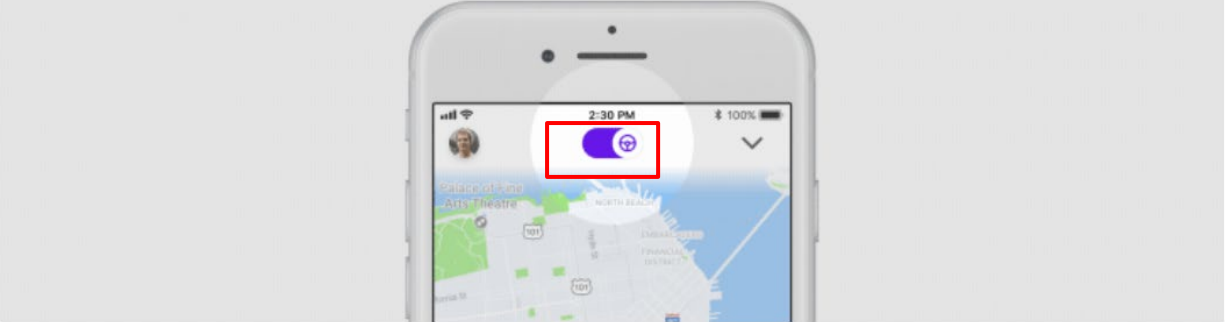
Claim - 8,213,970	Exemplary Supporting Evidence Regarding Accused Products
	 <p data-bbox="485 678 604 704">Go online</p> <p data-bbox="485 743 1682 813">Open your Lyft Driver app and tap the steering wheel icon. Lyft will now find the closest passenger to your location requesting a ride. Turn on some music and get comfortable: that first ride request</p> <p data-bbox="485 818 1654 850">may come quickly or may take a while, depending on the number of current passenger requests.</p> <p data-bbox="485 855 1140 888">https://www.lyft.com/hub/posts/how-to-give-a-ride</p>

RESTRICTED CONFIDENTIAL SOURCE CODE

Attachment D for US Patent No. 8,213,970 Against Lyft Accused Products

Claim - 8,213,970	Exemplary Supporting Evidence Regarding Accused Products
	<p data-bbox="531 315 743 472">Driver's device displaying passenger's ride request message</p>  <p data-bbox="480 935 1394 967">https://www.youtube.com/watch?v=jVUy9poJDng at 10:24, Annotated</p>

RESTRICTED CONFIDENTIAL SOURCE CODE

Attachment D for US Patent No. 8,213,970 Against Lyft Accused Products

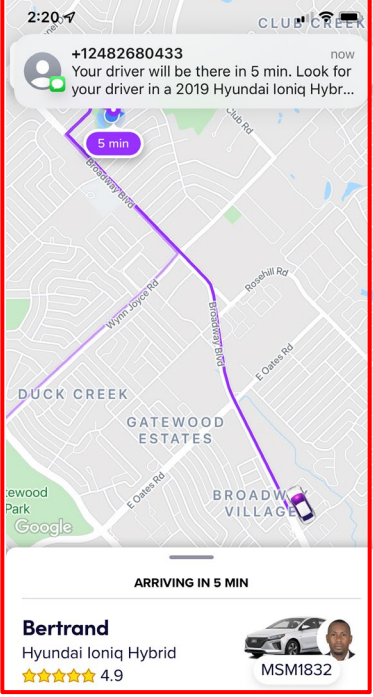
Claim - 8,213,970	Exemplary Supporting Evidence Regarding Accused Products
	 <p data-bbox="1039 370 1285 532">Passenger's device displaying passenger's ride request message</p>

RESTRICTED CONFIDENTIAL SOURCE CODE

Attachment D for US Patent No. 8,213,970 Against Lyft Accused Products

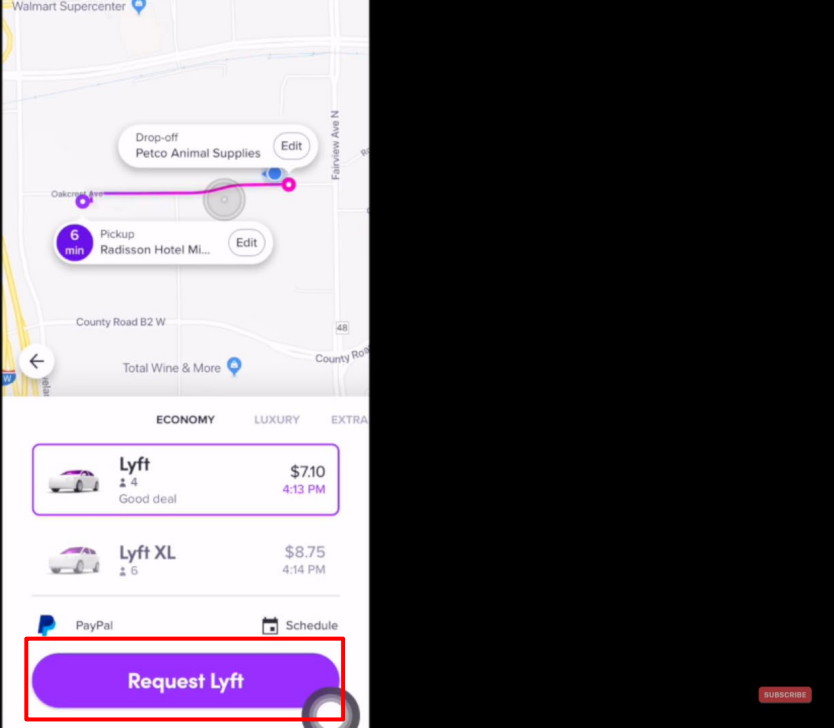
Claim - 8,213,970	Exemplary Supporting Evidence Regarding Accused Products
	 <p>The screenshot displays the Lyft app interface. At the top, a map shows the route from the pickup location, Radisson Hotel ML... (6 min), to the drop-off location, Petco Animal Supplies. Below the map, the app lists two options: Lyft (4 seats, \$7.10, 4:13 PM) and Lyft XL (6 seats, \$8.75, 4:14 PM). The Lyft XL option is selected. At the bottom, there are buttons for 'PayPal' and 'Schedule', and a prominent purple 'Request Lyft' button which is highlighted with a red rectangular box. A 'SUBSCRIBE' button is visible in the bottom right corner of the app interface.</p> <p>https://www.youtube.com/watch?v=j0RDMLcmOgU at 4:01</p>

RESTRICTED CONFIDENTIAL SOURCE CODE

Attachment D for US Patent No. 8,213,970 Against Lyft Accused Products

Claim - 8,213,970	Exemplary Supporting Evidence Regarding Accused Products
	<p data-bbox="1346 334 1667 583">Passenger's device displaying passenger's ride request message</p>

RESTRICTED CONFIDENTIAL SOURCE CODE

Attachment D for US Patent No. 8,213,970 Against Lyft Accused Products

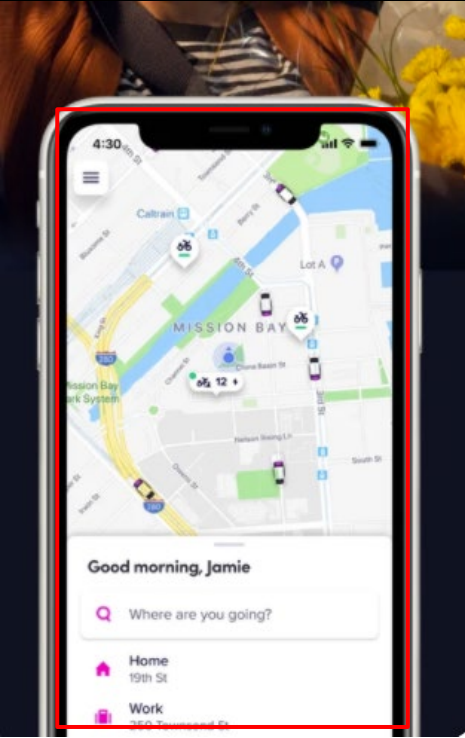
Claim - 8,213,970	Exemplary Supporting Evidence Regarding Accused Products
	 <p>https://apps.apple.com/in/app/lyft/id529379082</p>

RESTRICTED CONFIDENTIAL SOURCE CODE

Attachment D for US Patent No. 8,213,970 Against Lyft Accused Products

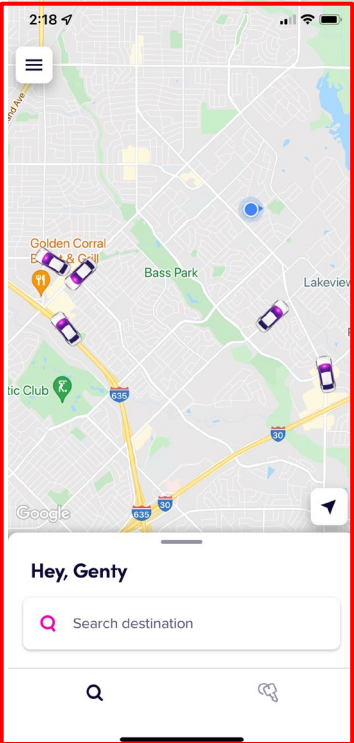
Claim - 8,213,970	Exemplary Supporting Evidence Regarding Accused Products
	 <p data-bbox="485 1068 1119 1122">5. Central Processing Unit (CPU)</p> <p data-bbox="485 1154 1623 1235">The CPU is the Main Control Section of a mobile phone, Android Smartphone and Apple iPhone. It controls all the function and does all the processing work.</p> <p data-bbox="485 1279 1356 1317">http://www.mobilecellphonerepairing.com/mobile-phone-parts.html</p>

RESTRICTED CONFIDENTIAL SOURCE CODE**Attachment D for US Patent No. 8,213,970 Against Lyft Accused Products**

Claim - 8,213,970	Exemplary Supporting Evidence Regarding Accused Products
	<p data-bbox="499 293 1205 342">6. RAM (<i>Random Access Memory</i>)</p> <p data-bbox="499 380 1730 461">RAM is an erasable memory where older data and information can be erased and new data and information can be stored.</p> <p data-bbox="485 505 1352 537">http://www.mobilecellphonerepairing.com/mobile-phone-parts.html</p>
<p data-bbox="205 691 426 1040">1[B]. a data transmission means that facilitates the transmission of electronic files between said PDA/cell phones in different locations</p>	<p data-bbox="478 691 1814 789">The Lyft Accused Products infringe directly and/or indirectly by performing, inducing others to perform, and/or contributing to the performance of: a data transmission means that facilitates the transmission of electronic files between said PDA/cell phones in different locations</p> <p data-bbox="478 911 1839 1040">For example, Lyft's servers connect passengers to nearby drivers when a request for a ride is placed. The servers receive a passenger's request for a ride and communicate the request to nearby drivers. The nearby drivers receive the request for a ride from the passengers to which they either accept or decline the request. The locations of the passenger and the nearby drivers are different from each other.</p>

RESTRICTED CONFIDENTIAL SOURCE CODE

Attachment D for US Patent No. 8,213,970 Against Lyft Accused Products

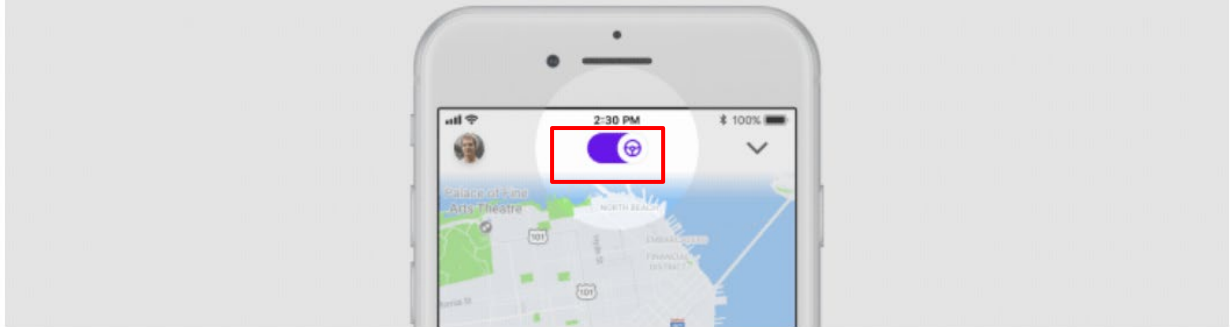
Claim - 8,213,970	Exemplary Supporting Evidence Regarding Accused Products
	 <p>Go online</p> <p>Open your Lyft Driver app and tap the steering wheel icon. Lyft will now find the closest passenger to your location requesting a ride. Turn on some music and get comfortable: that first ride request may come quickly or may take a while, depending on the number of current passenger requests.</p> <p>https://www.lyft.com/hub/posts/how-to-give-a-ride</p>

RESTRICTED CONFIDENTIAL SOURCE CODE

Attachment D for US Patent No. 8,213,970 Against Lyft Accused Products

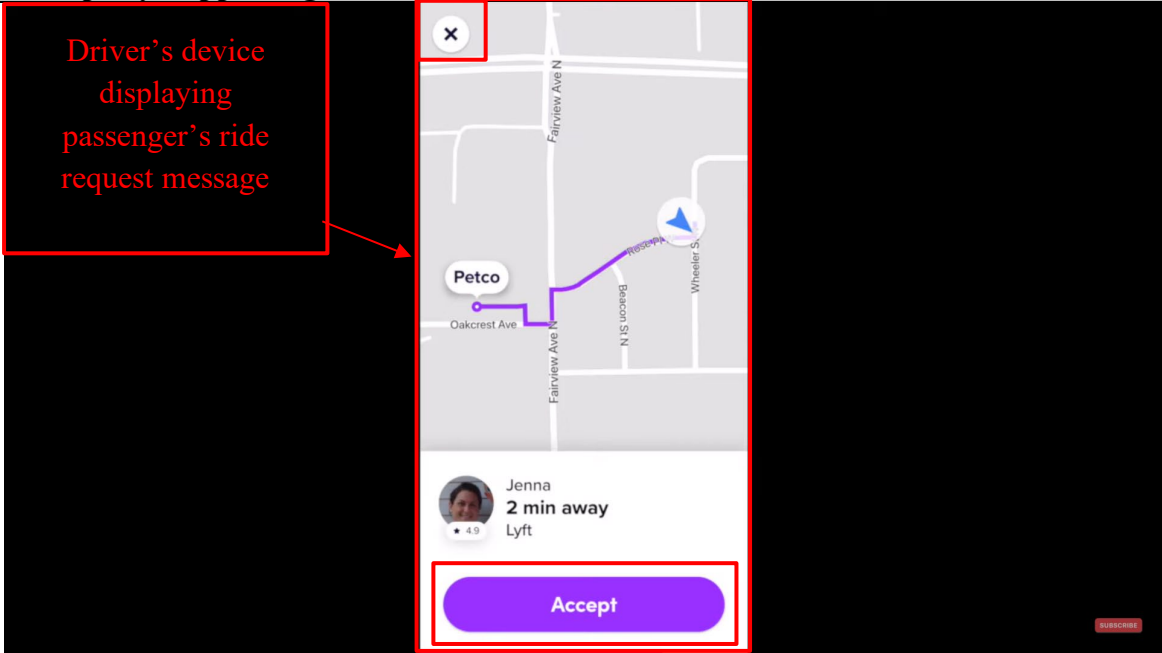
Claim - 8,213,970	Exemplary Supporting Evidence Regarding Accused Products
	<p data-bbox="531 315 743 475">Driver's device displaying passenger's ride request message</p>  <p data-bbox="480 935 1396 967">https://www.youtube.com/watch?v=jVUy9poJDng at 10:24, Annotated</p>

RESTRICTED CONFIDENTIAL SOURCE CODE

Attachment D for US Patent No. 8,213,970 Against Lyft Accused Products

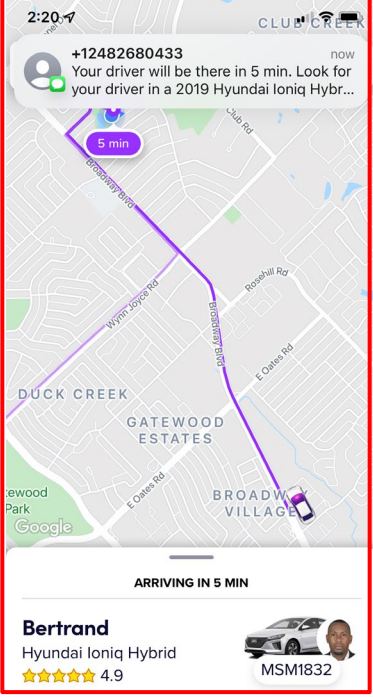
Claim - 8,213,970	Exemplary Supporting Evidence Regarding Accused Products
	 <p data-bbox="1003 342 1325 592">Passenger's device displaying passenger's ride request message</p>

RESTRICTED CONFIDENTIAL SOURCE CODE

Attachment D for US Patent No. 8,213,970 Against Lyft Accused Products

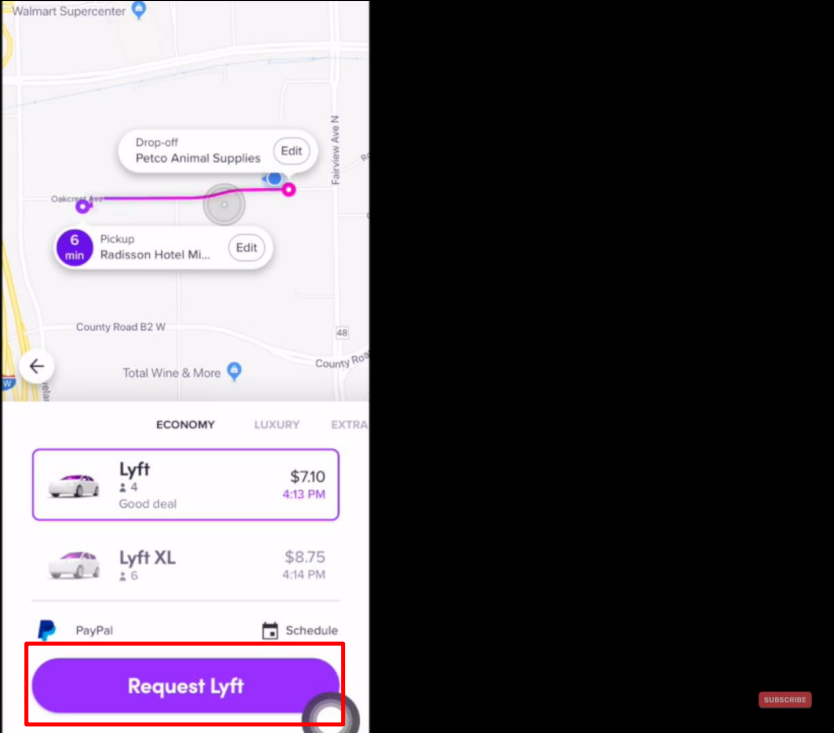
Claim - 8,213,970	Exemplary Supporting Evidence Regarding Accused Products
	 <p>https://www.youtube.com/watch?v=j0RDMLcmOgU at 4:01</p>

RESTRICTED CONFIDENTIAL SOURCE CODE

Attachment D for US Patent No. 8,213,970 Against Lyft Accused Products

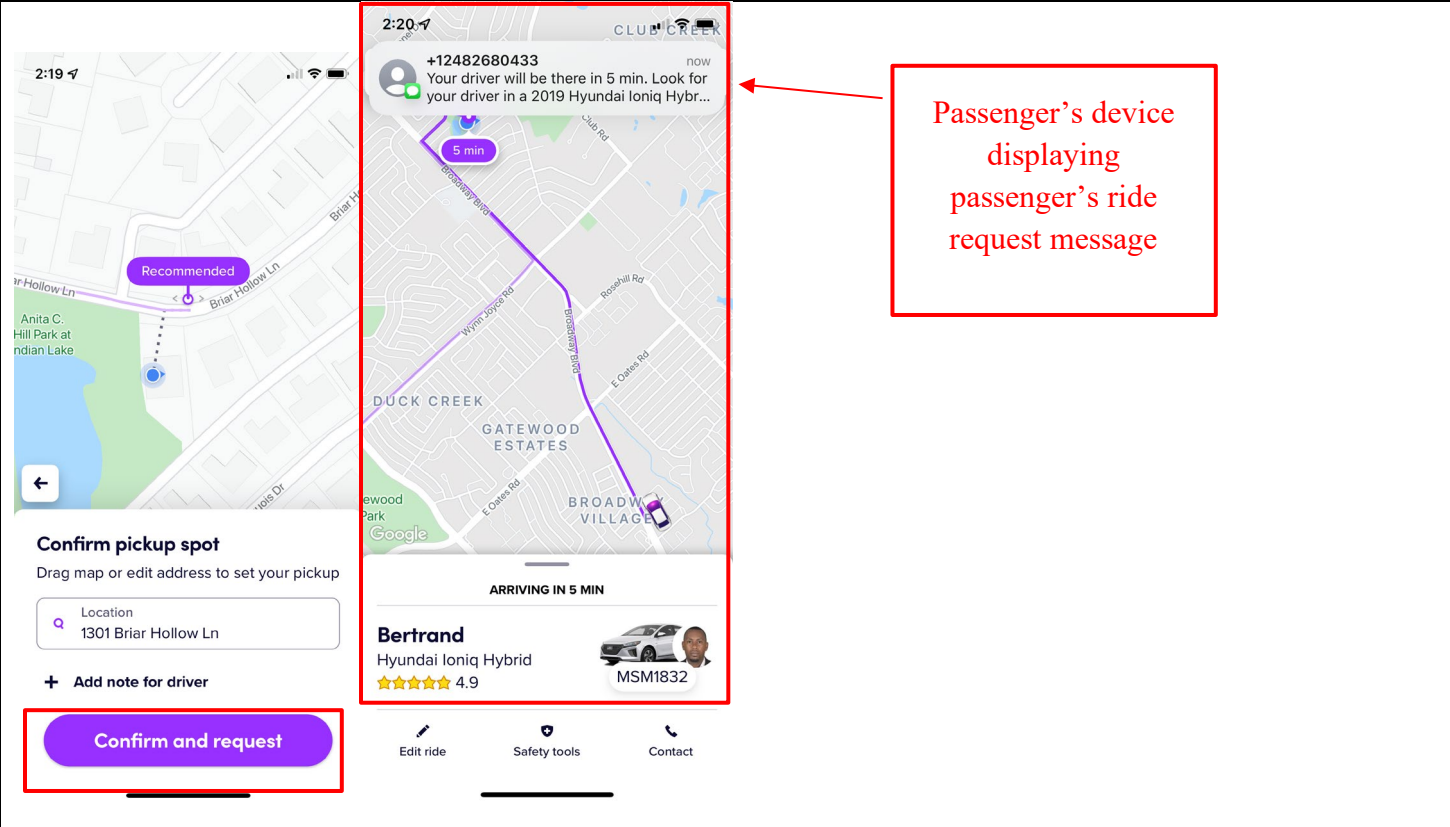
Claim - 8,213,970	Exemplary Supporting Evidence Regarding Accused Products
	 <p data-bbox="1352 344 1673 596">Passenger's device displaying passenger's ride request message</p> <p data-bbox="464 1117 1906 1230">Further, to the extent this element is performed at least in part by Lyft's software source code, AGIS reserves the right to supplement these contentions pursuant to production of such source code by Lyft and to the extent Lyft requires additional information in accordance with P.R. 3-1 and for any other reasons.</p>

RESTRICTED CONFIDENTIAL SOURCE CODE

Attachment D for US Patent No. 8,213,970 Against Lyft Accused Products

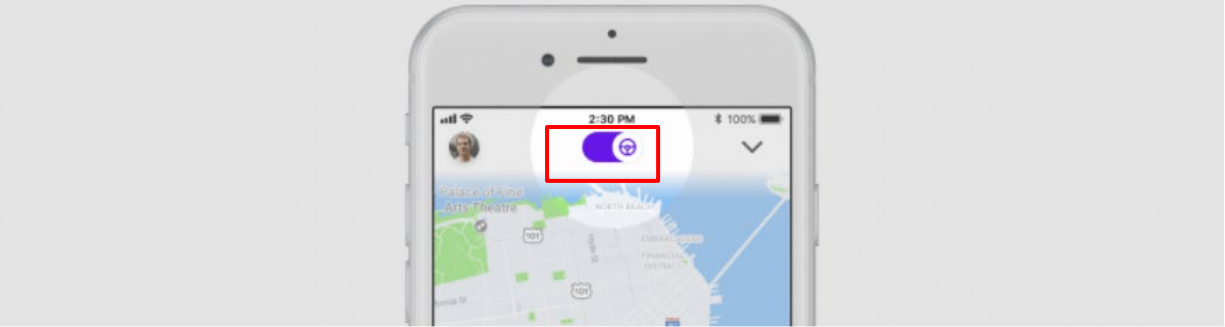
Claim - 8,213,970	Exemplary Supporting Evidence Regarding Accused Products
<p>1[C]. a sender PDA/cell phone and at least one recipient PDA/cell phone for each electronic message</p>	<p>The Lyft Accused Products infringe directly and/or indirectly by performing, inducing others to perform, and/or contributing to the performance of: a sender PDA/cell phone and at least one recipient PDA/cell phone for each electronic message</p> <p>For example, Lyft’s servers connects the passengers (“sender”) to the nearby drivers (“recipient”) when a request for a ride is placed. The servers receive a passenger’s request for a ride and communicates the request to nearby drivers. The nearby drivers receive the request for a ride from the passengers to which they either accept or decline the request.</p>  <p>Go online</p> <p>Open your Lyft Driver app and tap the steering wheel icon. Lyft will now find the closest passenger to your location requesting a ride. Turn on some music and get comfortable: that first ride request may come quickly or may take a while, depending on the number of current passenger requests.</p> <p>https://www.lyft.com/hub/posts/how-to-give-a-ride</p>

RESTRICTED CONFIDENTIAL SOURCE CODE

Attachment D for US Patent No. 8,213,970 Against Lyft Accused Products

Claim - 8,213,970	Exemplary Supporting Evidence Regarding Accused Products
	<p data-bbox="531 315 743 472">Driver's device displaying passenger's ride request message</p>  <p data-bbox="480 935 1396 967">https://www.youtube.com/watch?v=jVUy9poJDng at 10:24, Annotated</p>

RESTRICTED CONFIDENTIAL SOURCE CODE

Attachment D for US Patent No. 8,213,970 Against Lyft Accused Products

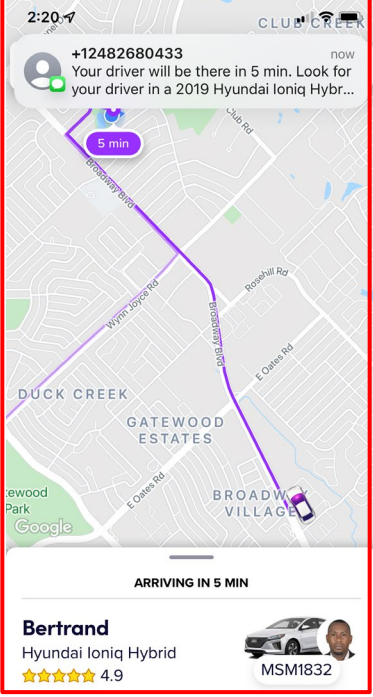
Claim - 8,213,970	Exemplary Supporting Evidence Regarding Accused Products
	 <p>The screenshot shows a mobile app interface for a ride confirmation. At the top, the time is 2:20. A notification bubble from the number +12482680433 says "Your driver will be there in 5 min. Look for your driver in a 2019 Hyundai Ioniq Hybr...". Below this is a map showing a purple route from a starting point to a destination, with a "5 min" arrival indicator. The map labels include "DUCK CREEK", "GATEWOOD ESTATES", and "BROADWAY VILLAGE". Below the map, it says "ARRIVING IN 5 MIN". The driver's name is "Bertrand", the car is a "Hyundai Ioniq Hybrid", and the rating is "★★★★★ 4.9". A car icon and the license plate "MSM1832" are also visible. At the bottom, there are icons for "Edit ride", "Safety tools", and "Contact".</p> <p data-bbox="1003 342 1325 592">Passenger's device displaying passenger's ride request message</p>

RESTRICTED CONFIDENTIAL SOURCE CODE

Attachment D for US Patent No. 8,213,970 Against Lyft Accused Products

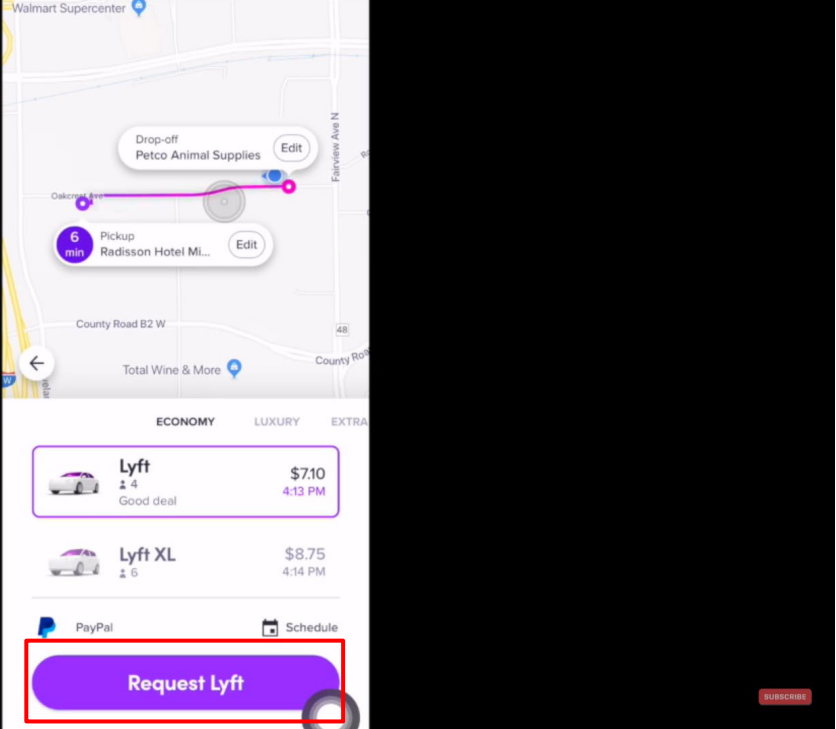
Claim - 8,213,970	Exemplary Supporting Evidence Regarding Accused Products
	 <p>The screenshot displays the Lyft app interface. At the top, a map shows the route from the pickup location, Radisson Hotel ML... (6 min), to the drop-off location, Petco Animal Supplies. Below the map, the fare is listed as \$7.10 for a Lyft car (4 seats) with an estimated arrival time of 4:13 PM. A Lyft XL option is also visible for \$8.75. At the bottom, a red box highlights the purple 'Request Lyft' button. The interface also shows 'PayPal' and 'Schedule' options.</p> <p>https://www.youtube.com/watch?v=j0RDMLcmOgU at 4:01</p>

RESTRICTED CONFIDENTIAL SOURCE CODE

Attachment D for US Patent No. 8,213,970 Against Lyft Accused Products

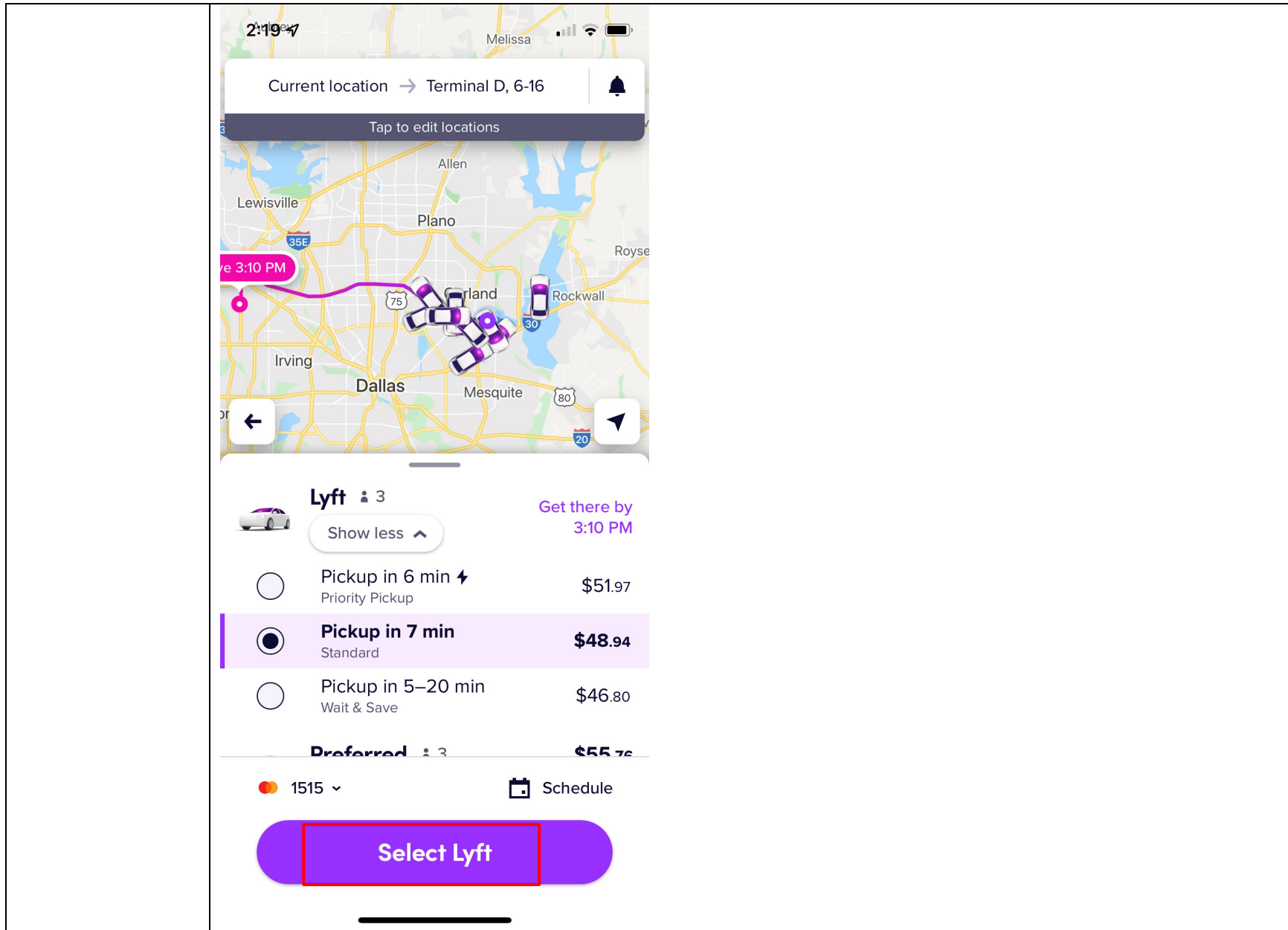

RESTRICTED CONFIDENTIAL SOURCE CODE

Attachment D for US Patent No. 8,213,970 Against Lyft Accused Products

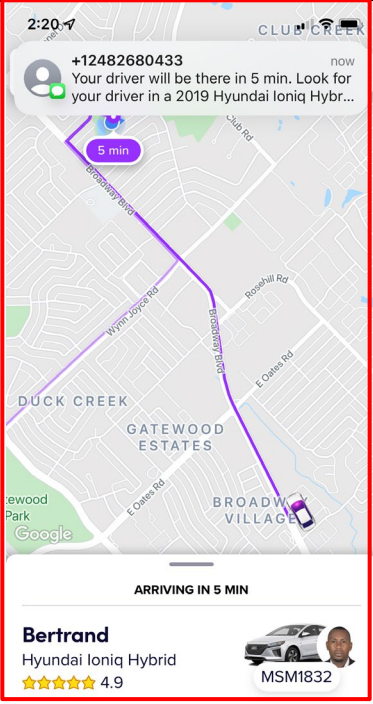
Claim - 8,213,970	Exemplary Supporting Evidence Regarding Accused Products
	 <p>The screenshot shows a mobile application interface for a ride request. At the top, the time is 2:20. A notification bubble from the number +12482680433 says "now Your driver will be there in 5 min. Look for your driver in a 2019 Hyundai Ioniq Hybr...". Below this is a map with a purple route and a "5 min" arrival indicator. The driver's name is Bertrand, driving a 2019 Hyundai Ioniq Hybrid with a 4.9 star rating and license plate MSM1832. At the bottom are buttons for "Edit ride", "Safety tools", and "Contact".</p> <p data-bbox="1003 342 1325 592">Passenger's device displaying passenger's ride request message</p>

RESTRICTED CONFIDENTIAL SOURCE CODE

Attachment D for US Patent No. 8,213,970 Against Lyft Accused Products

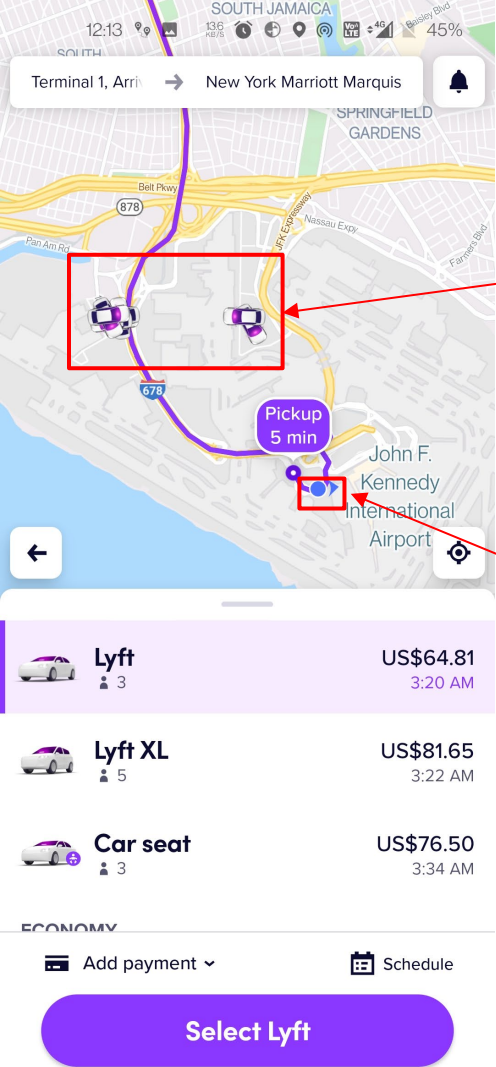
Claim - 8,213,970	Exemplary Supporting Evidence Regarding Accused Products												
	 <p>The screenshot displays the Lyft app interface. At the top, the map shows the route from Terminal 1, Arrivals to New York Marriott Marquis. A red box highlights two driver icons on the map, with a red arrow pointing to a text box labeled "Nearby Drivers' location". Another red box highlights the pickup location at John F. Kennedy International Airport, with a red arrow pointing to a text box labeled "Passenger's location". Below the map, a list of ride options is shown:</p> <table border="1"><thead><tr><th>Ride Type</th><th>Price</th><th>Time</th></tr></thead><tbody><tr><td>Lyft (3 seats)</td><td>US\$64.81</td><td>3:20 AM</td></tr><tr><td>Lyft XL (5 seats)</td><td>US\$81.65</td><td>3:22 AM</td></tr><tr><td>Car seat (3 seats)</td><td>US\$76.50</td><td>3:34 AM</td></tr></tbody></table> <p>At the bottom, there are options for "Add payment" and "Schedule", and a large purple button labeled "Select Lyft".</p>	Ride Type	Price	Time	Lyft (3 seats)	US\$64.81	3:20 AM	Lyft XL (5 seats)	US\$81.65	3:22 AM	Car seat (3 seats)	US\$76.50	3:34 AM
Ride Type	Price	Time											
Lyft (3 seats)	US\$64.81	3:20 AM											
Lyft XL (5 seats)	US\$81.65	3:22 AM											
Car seat (3 seats)	US\$76.50	3:34 AM											

RESTRICTED CONFIDENTIAL SOURCE CODE

Attachment D for US Patent No. 8,213,970 Against Lyft Accused Products

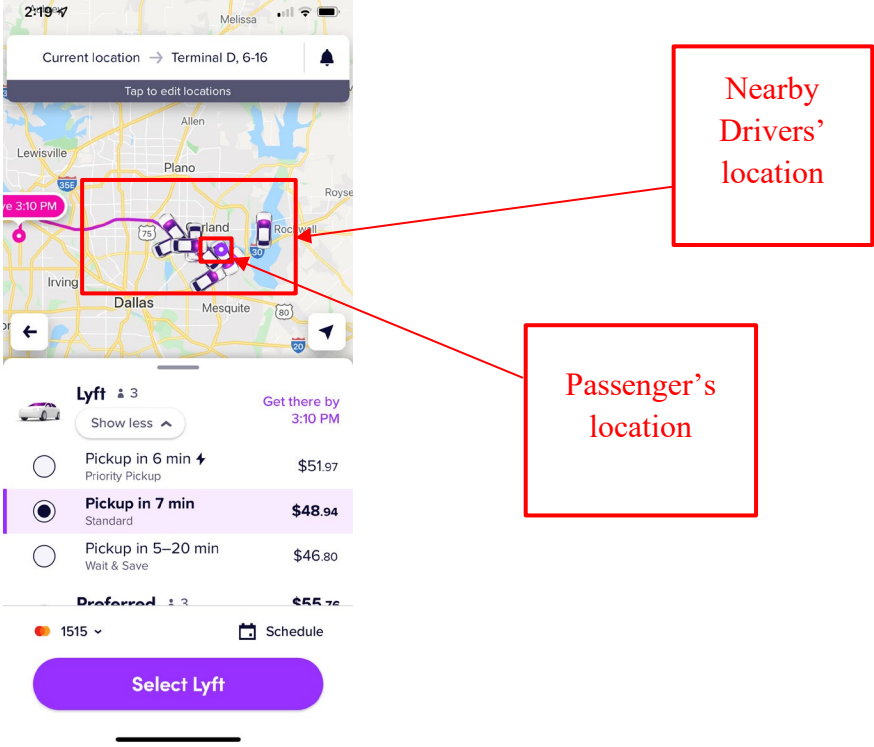
Claim - 8,213,970	Exemplary Supporting Evidence Regarding Accused Products
	 <p data-bbox="472 1076 1881 1182">Further, to the extent this element is performed at least in part by Lyft's software source code, AGIS reserves the right to supplement these contentions pursuant to production of such source code by Lyft and to the extent Lyft requires additional information in accordance with P.R. 3-1 and for any other reasons.</p>
<p>1[D]. a forced message alert software application program including</p>	<p>The Lyft Accused Products infringe directly and/or indirectly by performing, inducing others to perform, and/or contributing to the performance of: a forced message alert software application program including a list of required possible responses to be selected by a participant recipient of a forced message response loaded on each participating PDA/cell phone</p>

RESTRICTED CONFIDENTIAL SOURCE CODE

Attachment D for US Patent No. 8,213,970 Against Lyft Accused Products

Claim - 8,213,970	Exemplary Supporting Evidence Regarding Accused Products
<p>a list of required possible responses to be selected by a participant recipient of a forced message response loaded on each participating PDA/cell phone</p>	<p>For example, Lyft provides Lyft app for passengers and Lyft Driver app for drivers. The Lyft apps for riders and drivers, in conjunction with Lyft’s servers and services, provide users with interactive methods to request, view, and track locations of passengers/riders using real-time maps and communications. The Lyft server(s) and their services communicate with the Lyft apps for riders and drivers. The Lyft server(s) and their services host information related to and instructions for processing user/device/vehicle accounts, location data, and map data. The claimed methods are distributed by Lyft in the Lyft apps. The claimed methods are used/tested by Lyft using the Lyft apps. The claimed methods are downloaded and installed by Lyft’s customers (riders) and personnel (drivers, personnel) at the direction/encouragement of Lyft and used by Lyft’s customers and Lyft’s personnel.</p> <p>The Lyft Driver application receives an electronically transmitted request for a ride which triggers a forced message alert that locks the device for a period of time until the driver (“recipient”) sends a response message (decline or accept) to clear the locked display.</p>

RESTRICTED CONFIDENTIAL SOURCE CODE

Attachment D for US Patent No. 8,213,970 Against Lyft Accused Products

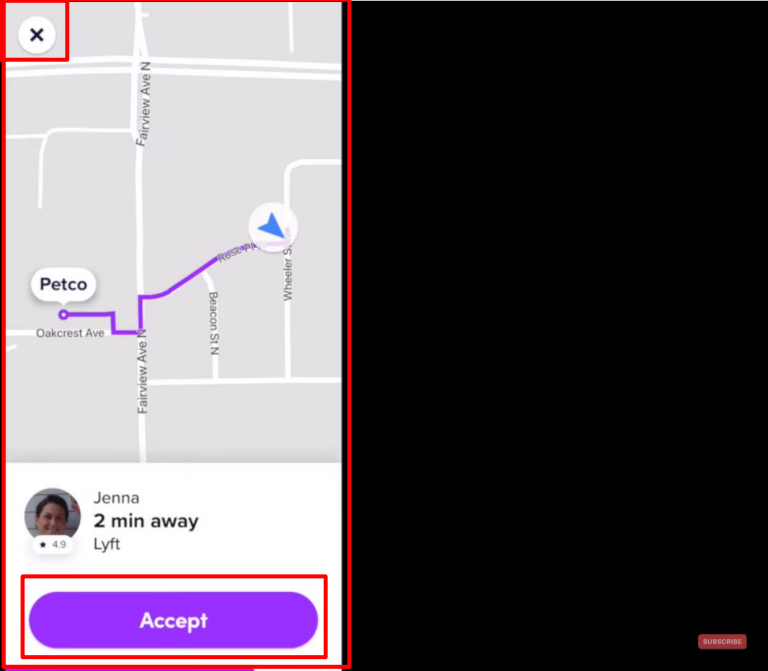
Claim - 8,213,970	Exemplary Supporting Evidence Regarding Accused Products
	<p data-bbox="531 302 743 505">Driver's device screen locked displaying passenger's ride request message</p>  <p data-bbox="478 954 1394 984">https://www.youtube.com/watch?v=jVUy9poJDng at 10:24, Annotated</p>

RESTRICTED CONFIDENTIAL SOURCE CODE

Attachment D for US Patent No. 8,213,970 Against Lyft Accused Products

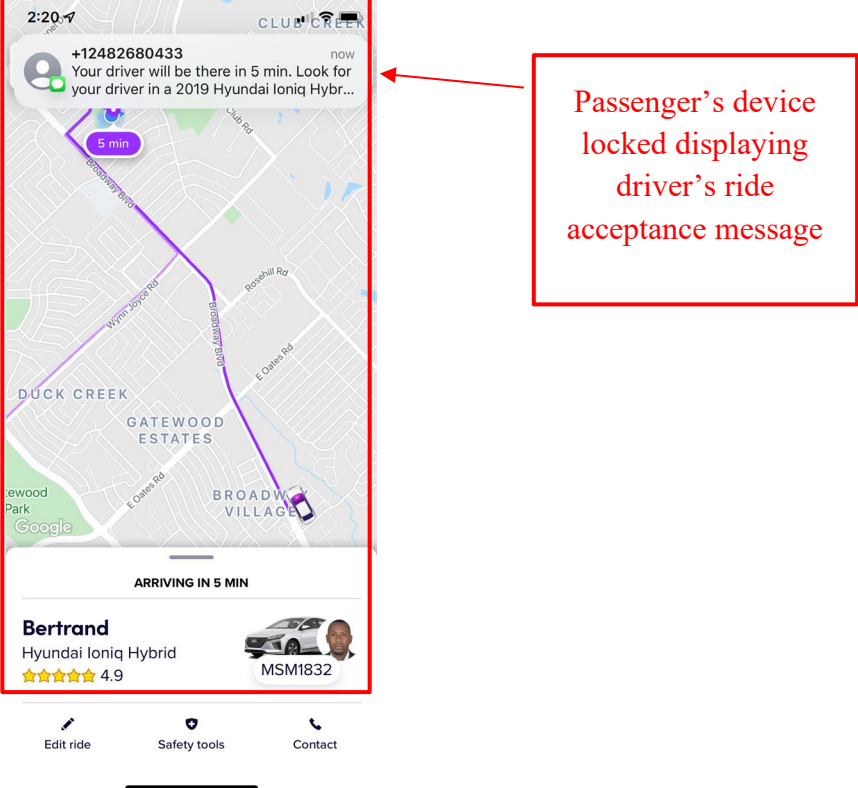
Claim - 8,213,970	Exemplary Supporting Evidence Regarding Accused Products
	 <p data-bbox="1003 342 1325 591">Passenger's device locked displaying driver's ride acceptance message</p>

RESTRICTED CONFIDENTIAL SOURCE CODE

Attachment D for US Patent No. 8,213,970 Against Lyft Accused Products

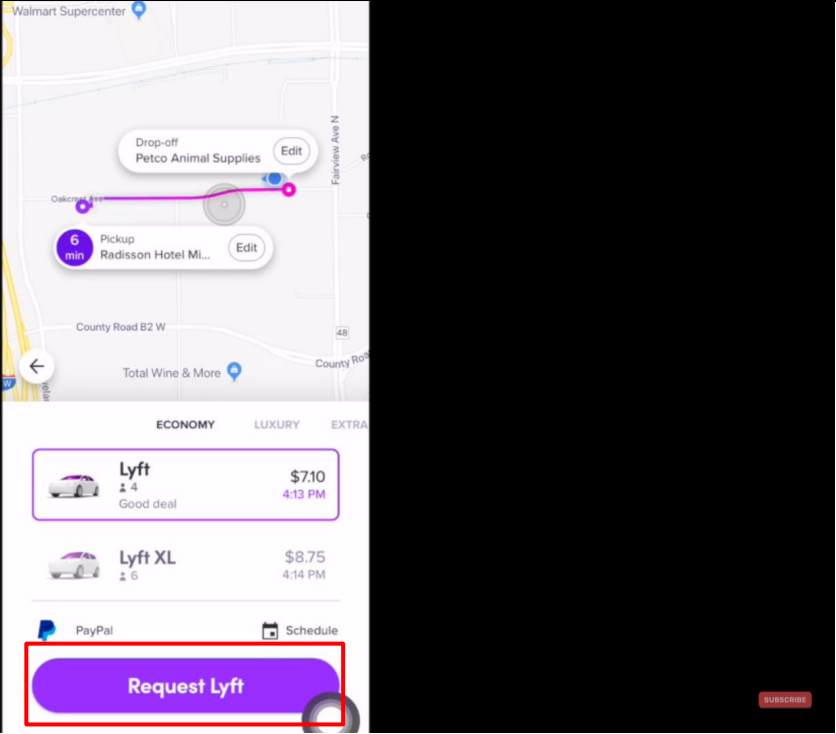
Claim - 8,213,970	Exemplary Supporting Evidence Regarding Accused Products
	 <p>https://www.youtube.com/watch?v=j0RDMLcmOgU at 4:01</p>

RESTRICTED CONFIDENTIAL SOURCE CODE

Attachment D for US Patent No. 8,213,970 Against Lyft Accused Products

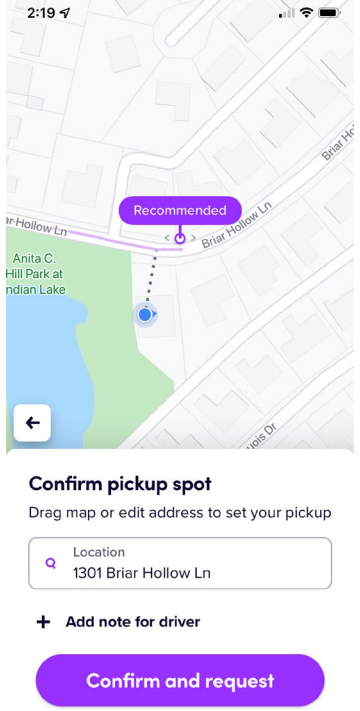
Claim - 8,213,970	Exemplary Supporting Evidence Regarding Accused Products
	 <p>The screenshot displays a mobile application interface for confirming a pickup location. At the top, a map shows a residential area with a purple dot indicating a 'Recommended' pickup spot at 1301 Briar Hollow Ln. Below the map, the text 'Confirm pickup spot' is followed by the instruction 'Drag map or edit address to set your pickup'. A search bar contains the text 'Location 1301 Briar Hollow Ln'. Below the search bar, there is a plus sign icon and the text '+ Add note for driver'. At the bottom, a large purple button is labeled 'Confirm and request'.</p>

RESTRICTED CONFIDENTIAL SOURCE CODE

Attachment D for US Patent No. 8,213,970 Against Lyft Accused Products

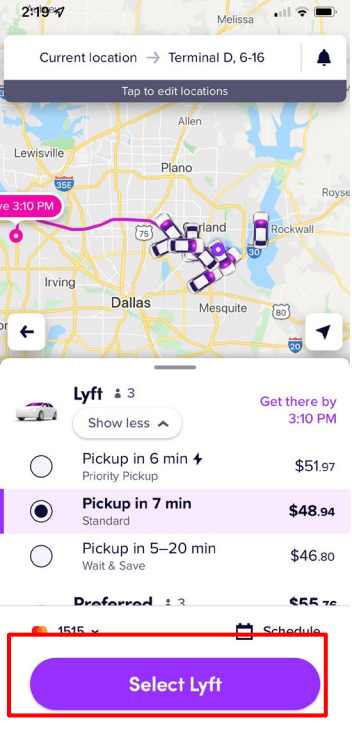
Claim - 8,213,970	Exemplary Supporting Evidence Regarding Accused Products												
	 <p>The screenshot shows the Lyft app interface. At the top, the current location is 'Terminal D, 6-16'. Below the map, there are three Lyft options listed:</p> <table border="1"><thead><tr><th>Option</th><th>Price</th><th>Time</th></tr></thead><tbody><tr><td>Pickup in 6 min (Priority Pickup)</td><td>\$51.97</td><td>6 min</td></tr><tr><td>Pickup in 7 min (Standard)</td><td>\$48.94</td><td>7 min</td></tr><tr><td>Pickup in 5-20 min (Wait & Save)</td><td>\$46.80</td><td>5-20 min</td></tr></tbody></table> <p>A red box highlights the 'Select Lyft' button at the bottom of the screen.</p>	Option	Price	Time	Pickup in 6 min (Priority Pickup)	\$51.97	6 min	Pickup in 7 min (Standard)	\$48.94	7 min	Pickup in 5-20 min (Wait & Save)	\$46.80	5-20 min
Option	Price	Time											
Pickup in 6 min (Priority Pickup)	\$51.97	6 min											
Pickup in 7 min (Standard)	\$48.94	7 min											
Pickup in 5-20 min (Wait & Save)	\$46.80	5-20 min											

RESTRICTED CONFIDENTIAL SOURCE CODE

Attachment D for US Patent No. 8,213,970 Against Lyft Accused Products

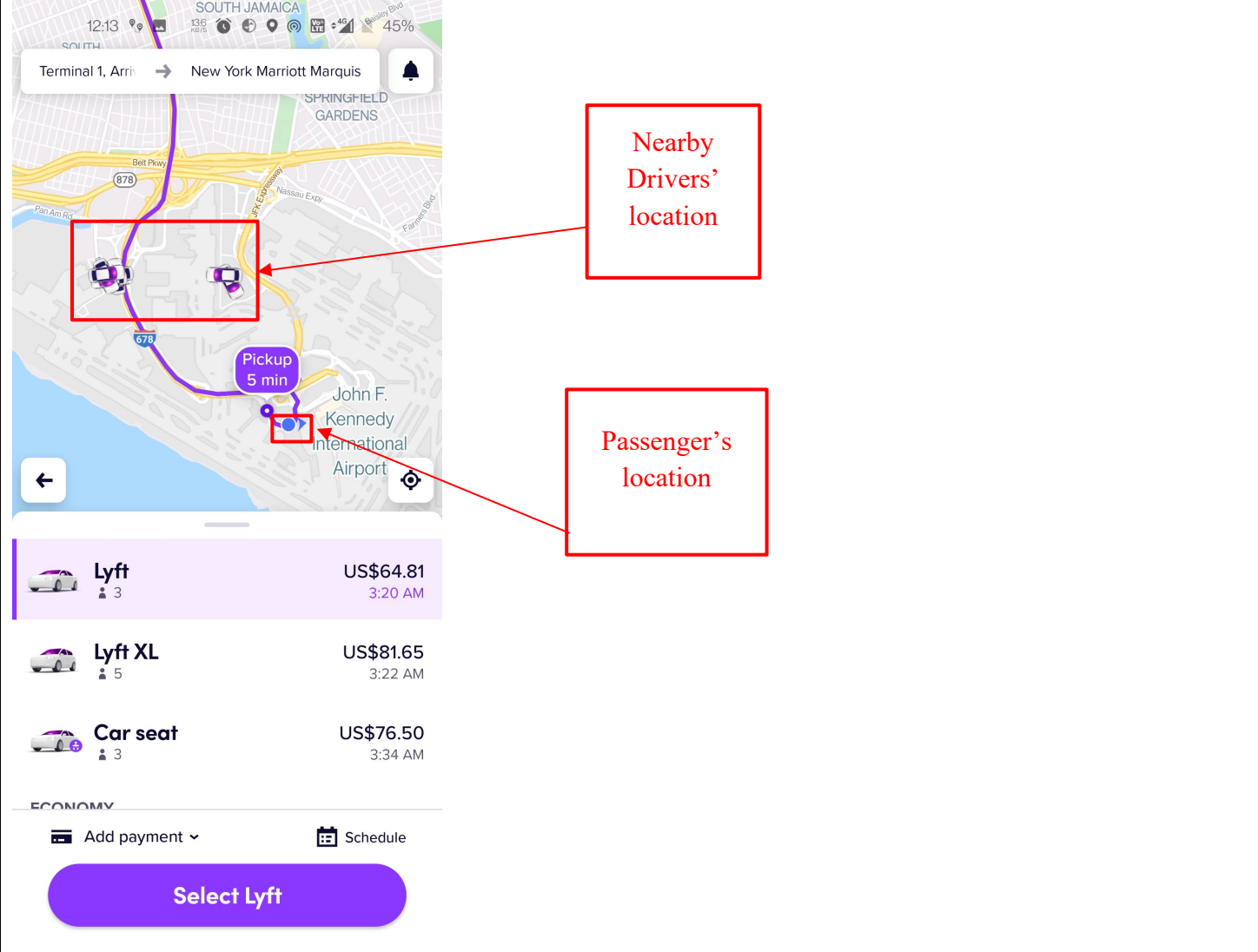
Claim - 8,213,970	Exemplary Supporting Evidence Regarding Accused Products
	 <p>The screenshot displays the Lyft app interface. At the top, the map shows the route from Terminal 1, Arrivals to New York Marriott Marquis. A red box highlights two driver icons on the map, with a red arrow pointing to a text box labeled "Nearby Drivers' location". Another red box highlights the passenger location on the map, with a red arrow pointing to a text box labeled "Passenger's location". Below the map, the ride options list includes Lyft (US\$64.81, 3:20 AM), Lyft XL (US\$81.65, 3:22 AM), and Car seat (US\$76.50, 3:34 AM). A "Select Lyft" button is visible at the bottom.</p>

RESTRICTED CONFIDENTIAL SOURCE CODE

Attachment D for US Patent No. 8,213,970 Against Lyft Accused Products

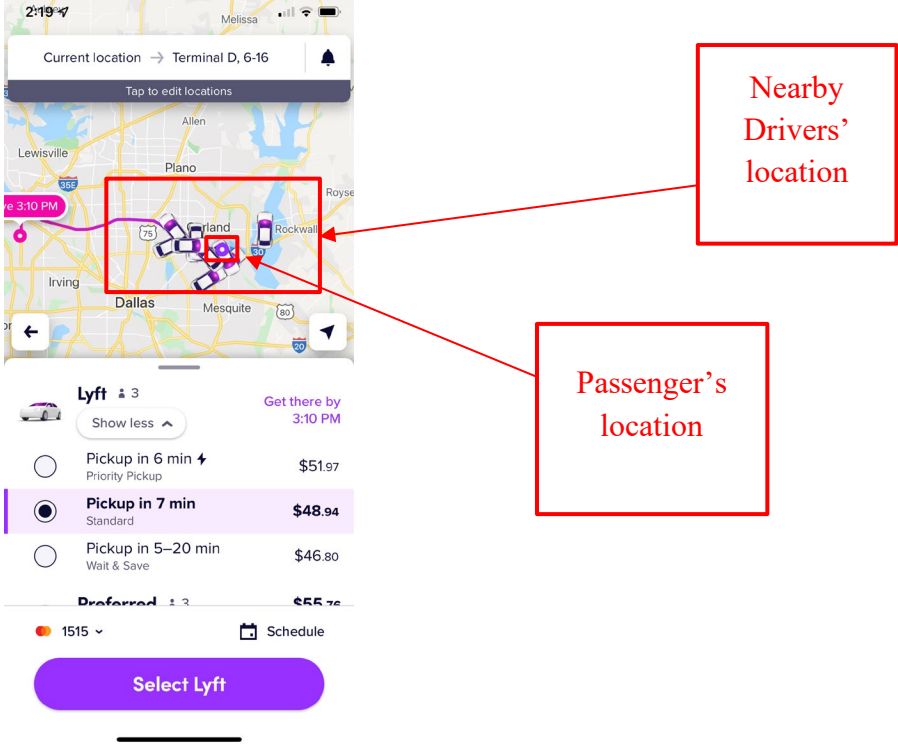
Claim - 8,213,970	Exemplary Supporting Evidence Regarding Accused Products
	 <p data-bbox="472 1076 1881 1182">Further, to the extent this element is performed at least in part by Lyft's software source code, AGIS reserves the right to supplement these contentions pursuant to production of such source code by Lyft and to the extent Lyft requires additional information in accordance with P.R. 3-1 and for any other reasons.</p>
<p>1[E]. means for attaching a forced message alert software packet to</p>	<p>The Lyft Accused Products infringe directly and/or indirectly by performing, inducing others to perform, and/or contributing to the performance of: means for attaching a forced message alert software packet to a voice or text message creating a forced message alert that is transmitted by said sender PDA/cell phone to the recipient PDA/cell phone, said forced message alert software packet containing a list of possible required</p>

RESTRICTED CONFIDENTIAL SOURCE CODE

Attachment D for US Patent No. 8,213,970 Against Lyft Accused Products

Claim - 8,213,970	Exemplary Supporting Evidence Regarding Accused Products
<p>a voice or text message creating a forced message alert that is transmitted by said sender PDA/cell phone to the recipient PDA/cell phone, said forced message alert software packet containing a list of possible required responses and requiring the forced message alert software on said recipient PDA/cell phone to transmit an automatic acknowledgment to the sender PDA/cell phone as soon as said forced message alert is received by the recipient PDA/cell phone;</p>	<p>responses and requiring the forced message alert software on said recipient PDA/cell phone to transmit an automatic acknowledgment to the sender PDA/cell phone as soon as said forced message alert is received by the recipient PDA/cell phone.</p> <p>For example, the Lyft Driver app receives an electronically transmitted request for a ride from a passenger which triggers a forced message alert that locks the driver’s device for a period of time until the driver (“recipient”) sends a response message (decline or accept) to clear the locked display.</p> <p>For example, at the backend, each nearby driver’s Lyft app that receives the ride request sends an acknowledgement of receipt to the Lyft server(s). The acknowledgement is communicated to the rider’s Lyft app via the Lyft server(s).</p>

RESTRICTED CONFIDENTIAL SOURCE CODE

Attachment D for US Patent No. 8,213,970 Against Lyft Accused Products

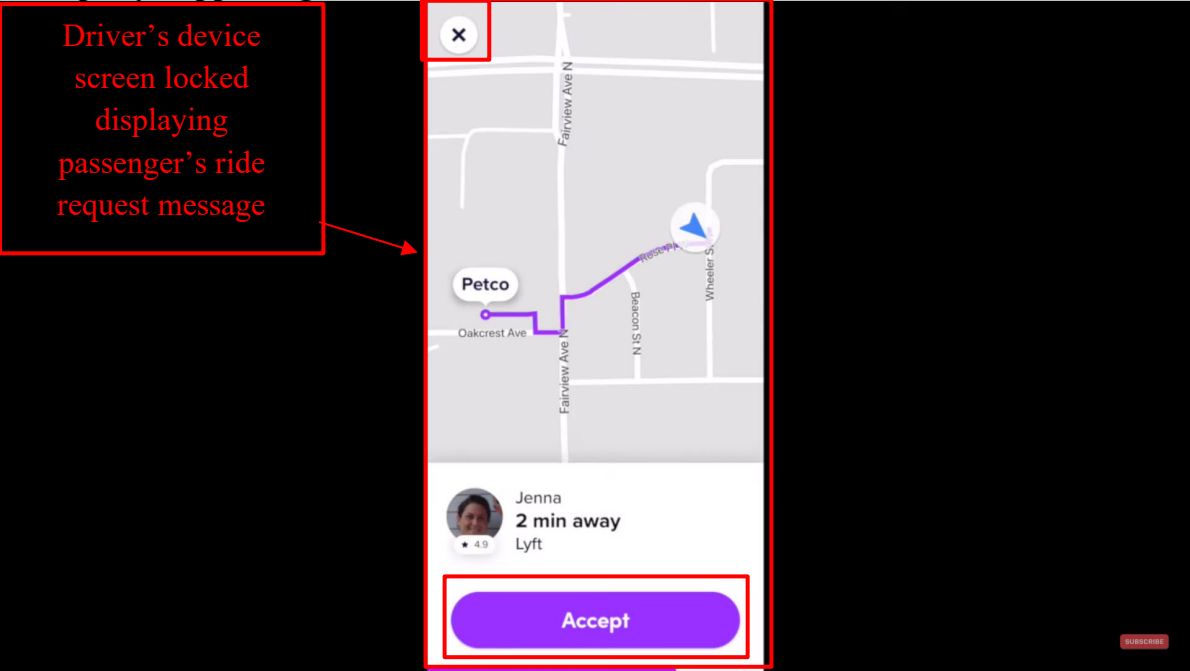
Claim - 8,213,970	Exemplary Supporting Evidence Regarding Accused Products
	<p data-bbox="531 300 743 500">Driver's device screen locked displaying passenger's ride request message</p>  <p data-bbox="478 954 1396 982">https://www.youtube.com/watch?v=jVUy9poJDng at 10:24, Annotated</p>

RESTRICTED CONFIDENTIAL SOURCE CODE

Attachment D for US Patent No. 8,213,970 Against Lyft Accused Products

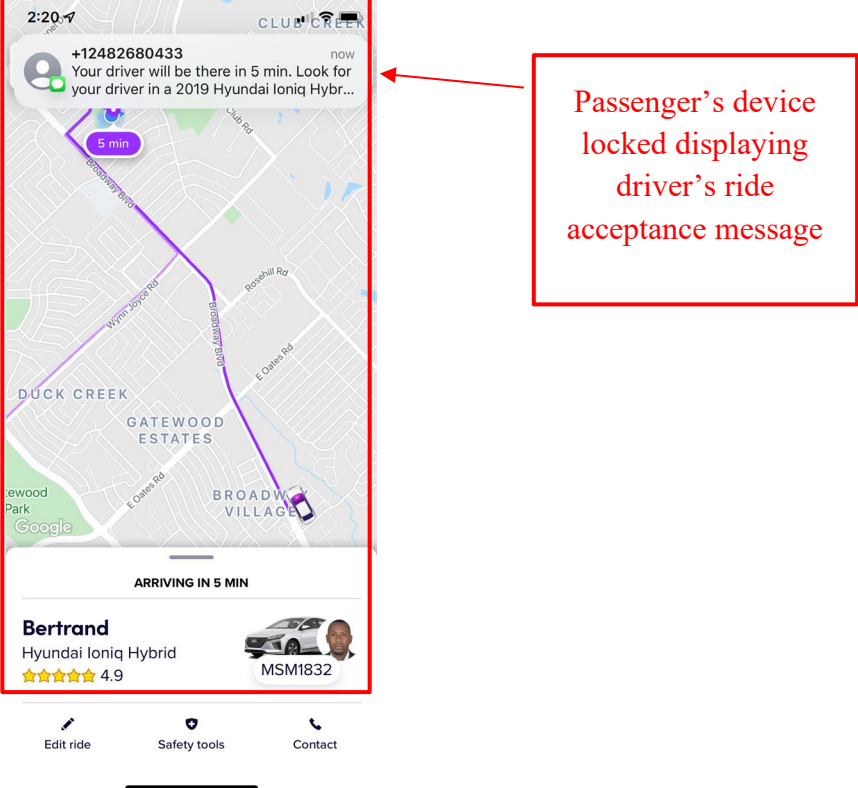
Claim - 8,213,970	Exemplary Supporting Evidence Regarding Accused Products
	 <p data-bbox="1003 342 1325 594">Passenger's device locked displaying driver's ride acceptance message</p>

RESTRICTED CONFIDENTIAL SOURCE CODE

Attachment D for US Patent No. 8,213,970 Against Lyft Accused Products

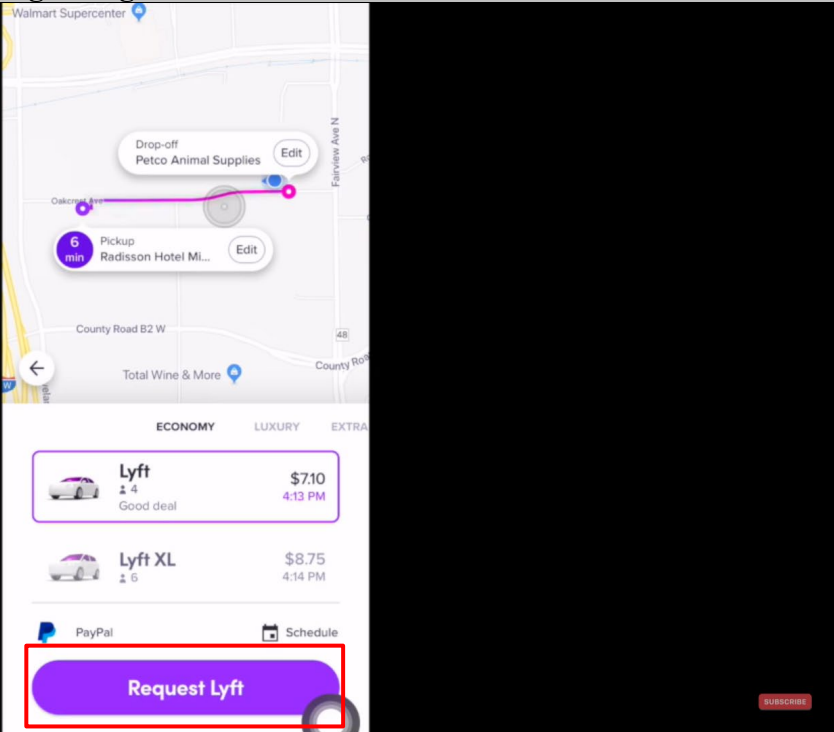
Claim - 8,213,970	Exemplary Supporting Evidence Regarding Accused Products
	 <p>https://www.youtube.com/watch?v=j0RDMLcmOgU at 4:01</p>

RESTRICTED CONFIDENTIAL SOURCE CODE

Attachment D for US Patent No. 8,213,970 Against Lyft Accused Products

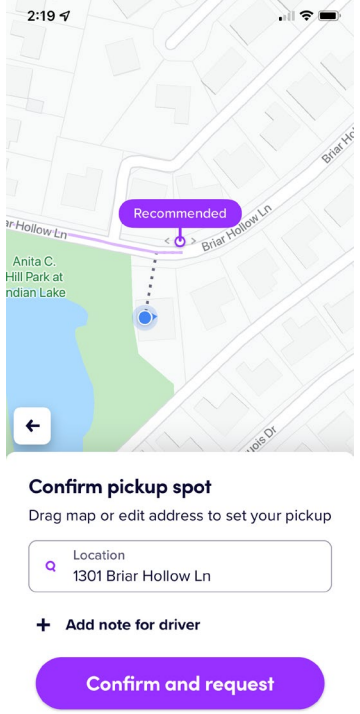
Claim - 8,213,970	Exemplary Supporting Evidence Regarding Accused Products
	 <p>The screenshot displays a mobile application interface for setting a pickup location. At the top, a map shows a residential area with a purple dot indicating a 'Recommended' pickup spot at 1301 Briar Hollow Ln. Below the map, the text 'Confirm pickup spot' is followed by the instruction 'Drag map or edit address to set your pickup'. A search bar contains the text 'Location 1301 Briar Hollow Ln'. Below the search bar, there is a plus sign icon and the text '+ Add note for driver'. At the bottom, a large purple button is labeled 'Confirm and request'.</p>

RESTRICTED CONFIDENTIAL SOURCE CODE

Attachment D for US Patent No. 8,213,970 Against Lyft Accused Products

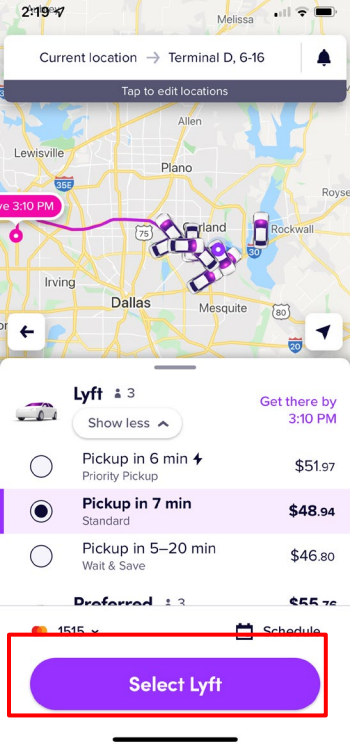
Claim - 8,213,970	Exemplary Supporting Evidence Regarding Accused Products
	 <p>The screenshot displays the Lyft app interface. At the top, the current location is 'Terminal D, 6-16'. The destination is marked on a map of Dallas. The estimated arrival time is 3:10 PM. Below the map, there are three pickup options:</p> <ul style="list-style-type: none"><input type="radio"/> Pickup in 6 min (Priority Pickup) - \$51.97<input checked="" type="radio"/> Pickup in 7 min (Standard) - \$48.94<input type="radio"/> Pickup in 5-20 min (Wait & Save) - \$46.80 <p>Below these options, there is a 'Preferred' section with a price of \$55.76. At the bottom of the screen, a purple button labeled 'Select Lyft' is highlighted with a red rectangular box.</p>

RESTRICTED CONFIDENTIAL SOURCE CODE

Attachment D for US Patent No. 8,213,970 Against Lyft Accused Products

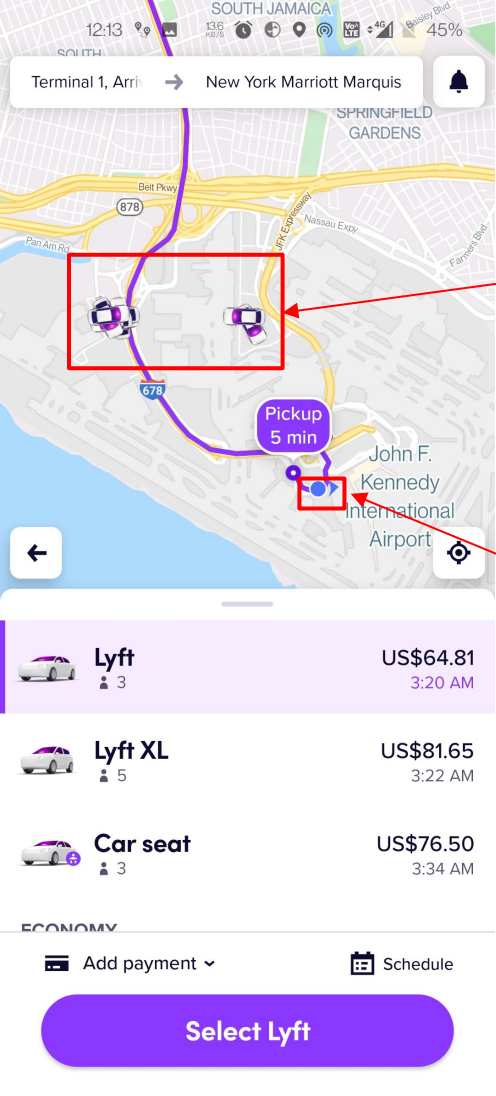
Claim - 8,213,970	Exemplary Supporting Evidence Regarding Accused Products												
	 <p>The screenshot displays a Lyft app interface. At the top, the map shows a route from Terminal 1, Arrivals to New York Marriott Marquis. A red box on the map highlights two driver icons, with a red arrow pointing to a text box labeled "Nearby Drivers' location". Another red box highlights the pickup location at John F. Kennedy International Airport, with a red arrow pointing to a text box labeled "Passenger's location". Below the map, a list of ride options is shown:</p> <table border="1"><thead><tr><th>Ride Type</th><th>Price</th><th>Time</th></tr></thead><tbody><tr><td>Lyft (3 seats)</td><td>US\$64.81</td><td>3:20 AM</td></tr><tr><td>Lyft XL (5 seats)</td><td>US\$81.65</td><td>3:22 AM</td></tr><tr><td>Car seat (3 seats)</td><td>US\$76.50</td><td>3:34 AM</td></tr></tbody></table> <p>At the bottom, there are options for "Add payment" and "Schedule", and a large purple button labeled "Select Lyft".</p>	Ride Type	Price	Time	Lyft (3 seats)	US\$64.81	3:20 AM	Lyft XL (5 seats)	US\$81.65	3:22 AM	Car seat (3 seats)	US\$76.50	3:34 AM
Ride Type	Price	Time											
Lyft (3 seats)	US\$64.81	3:20 AM											
Lyft XL (5 seats)	US\$81.65	3:22 AM											
Car seat (3 seats)	US\$76.50	3:34 AM											

RESTRICTED CONFIDENTIAL SOURCE CODE

Attachment D for US Patent No. 8,213,970 Against Lyft Accused Products

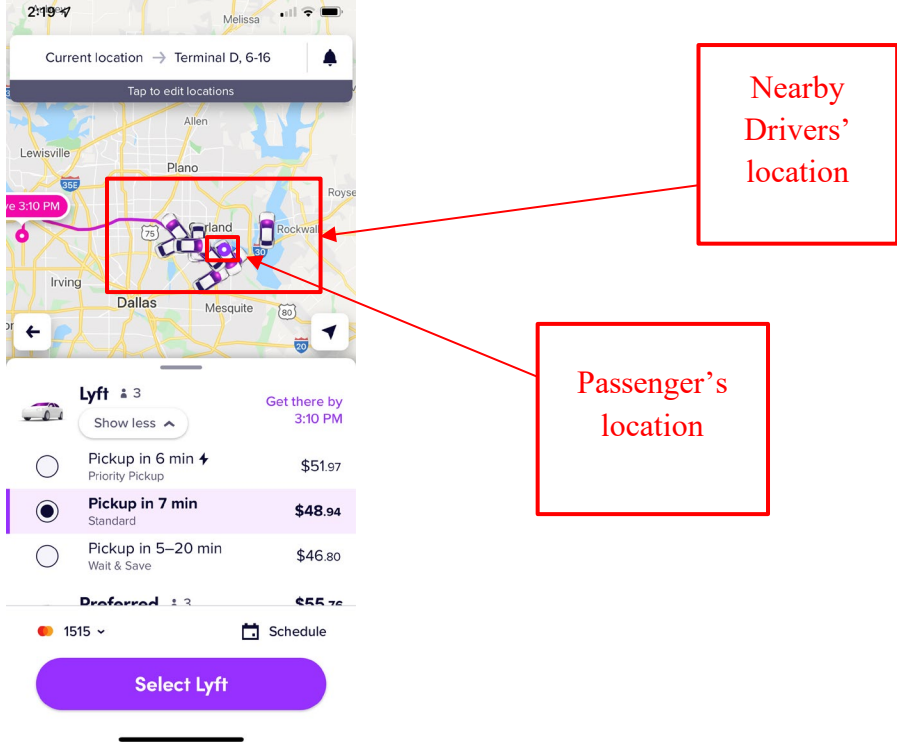
Claim - 8,213,970	Exemplary Supporting Evidence Regarding Accused Products
	 <p data-bbox="472 1076 1881 1182">Further, to the extent this element is performed at least in part by Lyft's software source code, AGIS reserves the right to supplement these contentions pursuant to production of such source code by Lyft and to the extent Lyft requires additional information in accordance with P.R. 3-1 and for any other reasons.</p>
<p>1[F]. means for requiring a required manual response from the</p>	<p>The Lyft Accused Products infringe directly and/or indirectly by performing, inducing others to perform, and/or contributing to the performance of: means for requiring a required manual response from the response list by the recipient in order to clear recipient's response list from recipient's cell phone display.</p>

RESTRICTED CONFIDENTIAL SOURCE CODE

Attachment D for US Patent No. 8,213,970 Against Lyft Accused Products

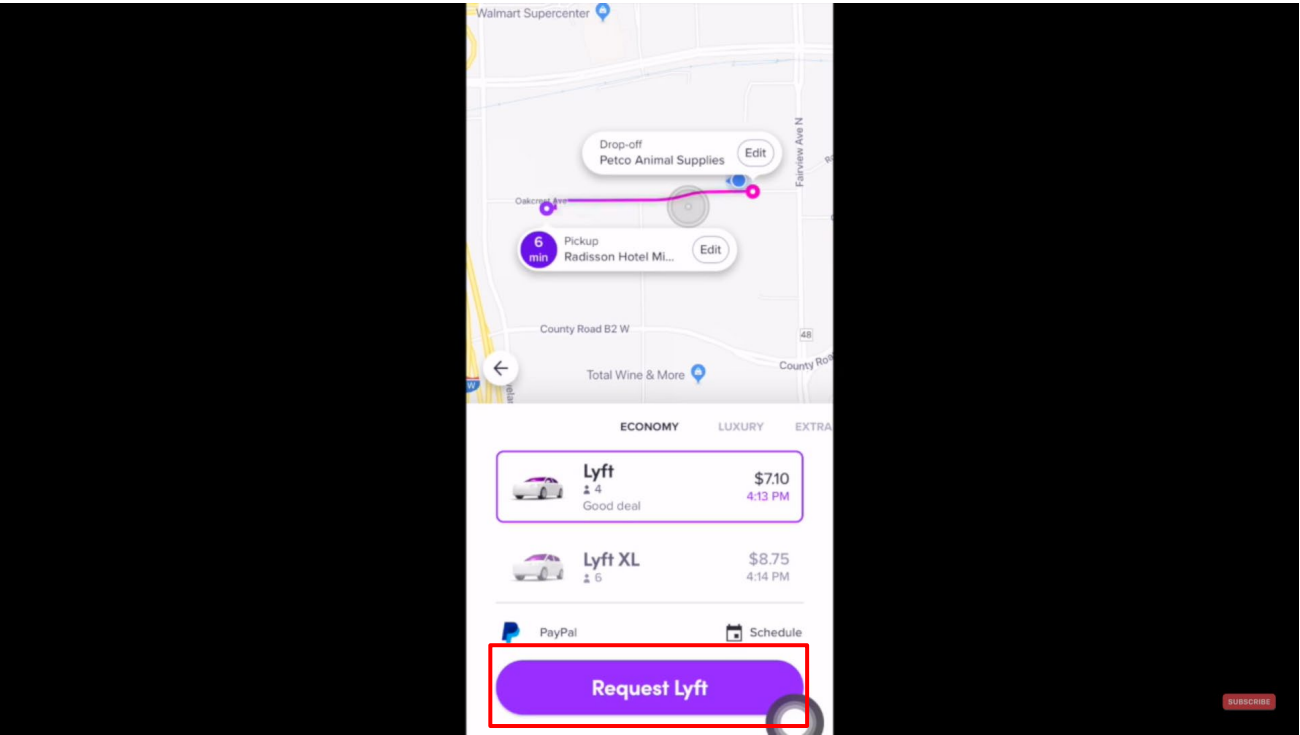
Claim - 8,213,970	Exemplary Supporting Evidence Regarding Accused Products
<p>response list by the recipient in order to clear recipient's response list from recipient's cell phone display;</p>	<p>For example, the Lyft Driver app receives an electronically transmitted request for a ride from a passenger which triggers a forced message alert that locks the driver's device for a period of time until the driver ("recipient") sends a response message (decline (cross button) or accept) to clear the locked display.</p>  <p>https://www.youtube.com/watch?v=j0RDMLcmOgU at 4:01</p>

RESTRICTED CONFIDENTIAL SOURCE CODE

Attachment D for US Patent No. 8,213,970 Against Lyft Accused Products

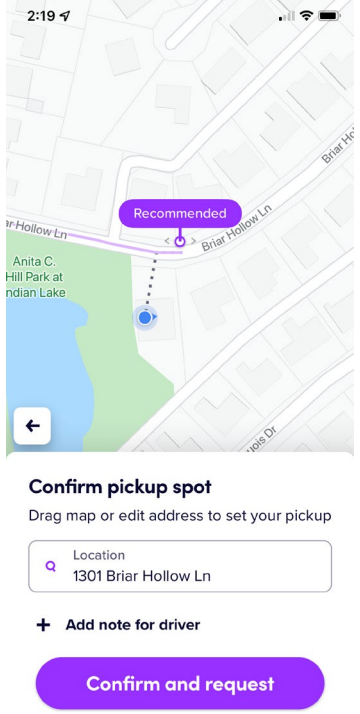
Claim - 8,213,970	Exemplary Supporting Evidence Regarding Accused Products
	 <p>The screenshot displays a mobile application interface for selecting a pickup location. At the top, a map shows a residential area with a purple dot and a purple arrow pointing to it, labeled "Recommended". The address "1301 Briar Hollow Ln" is entered in a search field. Below the map, the text "Confirm pickup spot" is followed by the instruction "Drag map or edit address to set your pickup". The search field contains "Location 1301 Briar Hollow Ln". There is also an option to "+ Add note for driver" and a prominent purple button labeled "Confirm and request".</p>





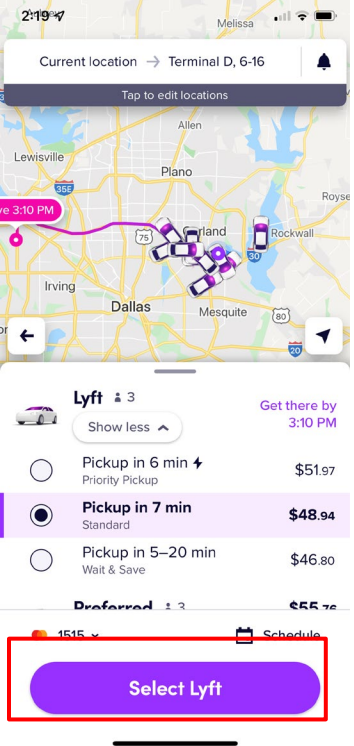



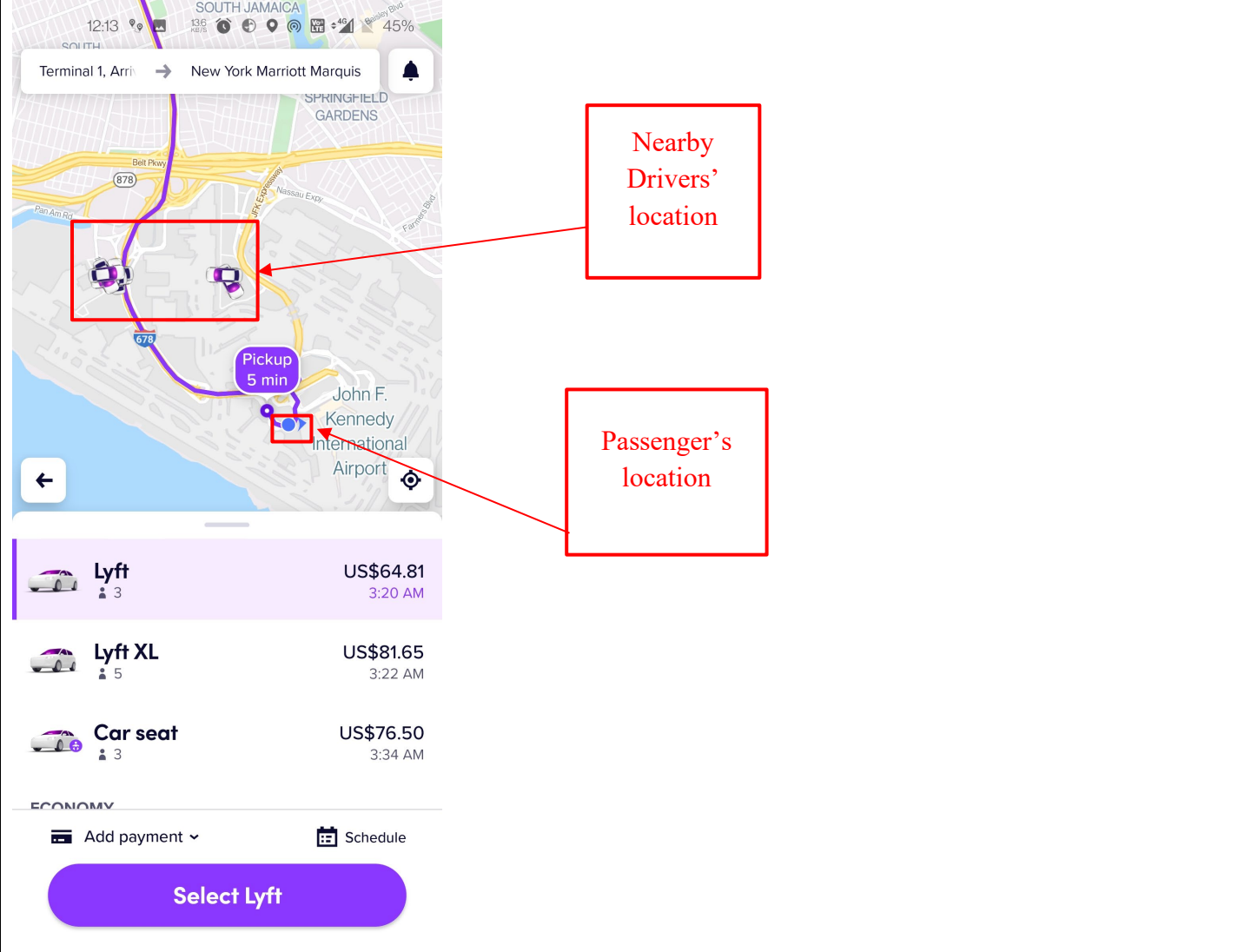

RESTRICTED CONFIDENTIAL SOURCE CODE

Attachment D for US Patent No. 8,213,970 Against Lyft Accused Products

Claim - 8,213,970	Exemplary Supporting Evidence Regarding Accused Products												
	 <p>The screenshot shows the Lyft app interface. At the top, the current location is 'Terminal D, 6-16'. The destination is set to 'Dallas'. The app displays three Lyft options:</p> <table border="1"><thead><tr><th>Option</th><th>Estimated Time</th><th>Price</th></tr></thead><tbody><tr><td>Priority Pickup</td><td>Pickup in 6 min</td><td>\$51.97</td></tr><tr><td>Standard</td><td>Pickup in 7 min</td><td>\$48.94</td></tr><tr><td>Wait & Save</td><td>Pickup in 5-20 min</td><td>\$46.80</td></tr></tbody></table> <p>A red box highlights the 'Select Lyft' button at the bottom of the screen.</p>	Option	Estimated Time	Price	Priority Pickup	Pickup in 6 min	\$51.97	Standard	Pickup in 7 min	\$48.94	Wait & Save	Pickup in 5-20 min	\$46.80
Option	Estimated Time	Price											
Priority Pickup	Pickup in 6 min	\$51.97											
Standard	Pickup in 7 min	\$48.94											
Wait & Save	Pickup in 5-20 min	\$46.80											

RESTRICTED CONFIDENTIAL SOURCE CODE

Attachment D for US Patent No. 8,213,970 Against Lyft Accused Products

Claim - 8,213,970	Exemplary Supporting Evidence Regarding Accused Products						
	 <p data-bbox="478 285 970 893">Screenshot of a Lyft app interface. The top shows the route from Terminal 1, Arrivals to New York Marriott Marquis. The map displays the pickup location at JFK Airport and nearby drivers' locations. A red box highlights the pickup location, and another red box highlights nearby drivers' locations. Red arrows point from text boxes to these areas.</p> <table border="1" data-bbox="478 893 970 1201"><tbody><tr><td> Lyft</td><td>US\$64.81 3:20 AM</td></tr><tr><td> Lyft XL</td><td>US\$81.65 3:22 AM</td></tr><tr><td> Car seat</td><td>US\$76.50 3:34 AM</td></tr></tbody></table> <p data-bbox="478 1201 970 1375">ECONOMY Add payment Schedule Select Lyft</p>	 Lyft	US\$64.81 3:20 AM	 Lyft XL	US\$81.65 3:22 AM	 Car seat	US\$76.50 3:34 AM
 Lyft	US\$64.81 3:20 AM						
 Lyft XL	US\$81.65 3:22 AM						
 Car seat	US\$76.50 3:34 AM						

RESTRICTED CONFIDENTIAL SOURCE CODE

Attachment D for US Patent No. 8,213,970 Against Lyft Accused Products

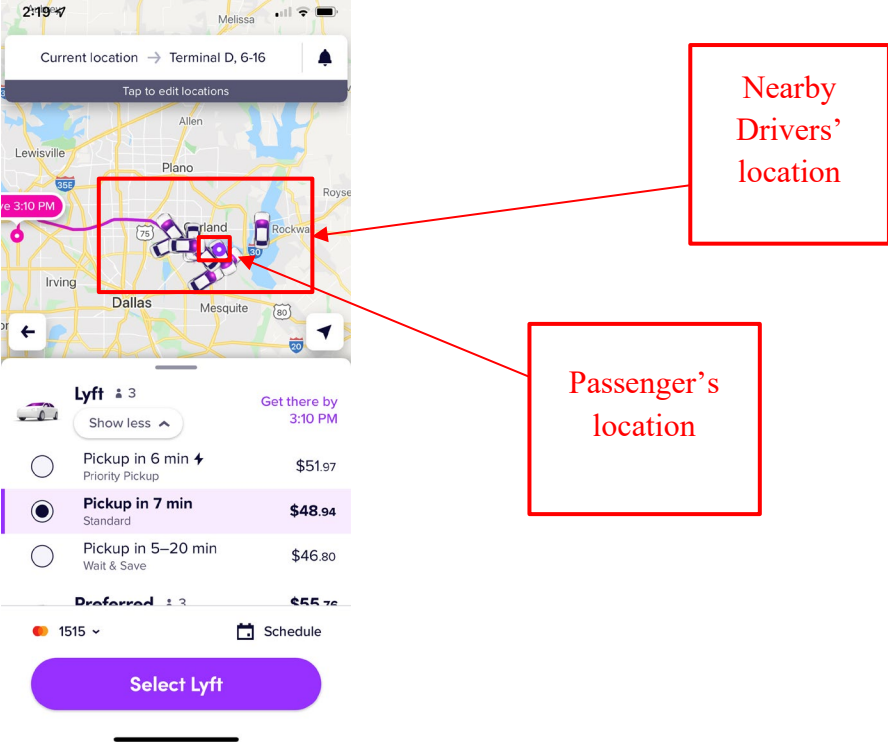
Claim - 8,213,970	Exemplary Supporting Evidence Regarding Accused Products												
	 <p>The screenshot displays the Lyft app interface. At the top, the current location is set to 'Terminal D, 6-16'. Below the map, there are three ride options:</p> <table border="1"><thead><tr><th>Pickup Time</th><th>Service Type</th><th>Price</th></tr></thead><tbody><tr><td>Pickup in 6 min</td><td>Priority Pickup</td><td>\$51.97</td></tr><tr><td>Pickup in 7 min</td><td>Standard</td><td>\$48.94</td></tr><tr><td>Pickup in 5-20 min</td><td>Wait & Save</td><td>\$46.80</td></tr></tbody></table> <p>At the bottom, there is a 'Select Lyft' button. The map shows several driver icons (purple squares) near the passenger's location (blue circle). Red boxes and arrows highlight these elements, with labels 'Nearby Drivers' location' and 'Passenger's location' pointing to them.</p>	Pickup Time	Service Type	Price	Pickup in 6 min	Priority Pickup	\$51.97	Pickup in 7 min	Standard	\$48.94	Pickup in 5-20 min	Wait & Save	\$46.80
Pickup Time	Service Type	Price											
Pickup in 6 min	Priority Pickup	\$51.97											
Pickup in 7 min	Standard	\$48.94											
Pickup in 5-20 min	Wait & Save	\$46.80											

RESTRICTED CONFIDENTIAL SOURCE CODE

Attachment D for US Patent No. 8,213,970 Against Lyft Accused Products

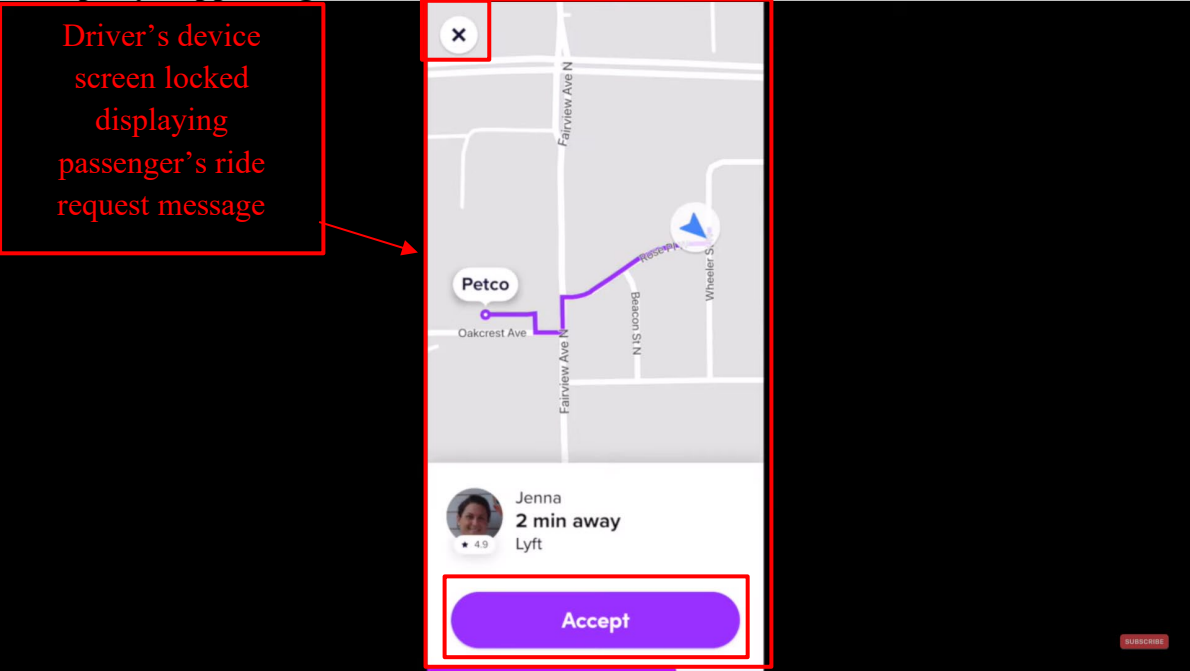
Claim - 8,213,970	Exemplary Supporting Evidence Regarding Accused Products
	<p data-bbox="527 302 743 500">Driver's device screen locked displaying passenger's ride request message</p>  <p data-bbox="478 954 1396 982">https://www.youtube.com/watch?v=jVUy9poJDng at 10:24, Annotated</p>

RESTRICTED CONFIDENTIAL SOURCE CODE

Attachment D for US Patent No. 8,213,970 Against Lyft Accused Products

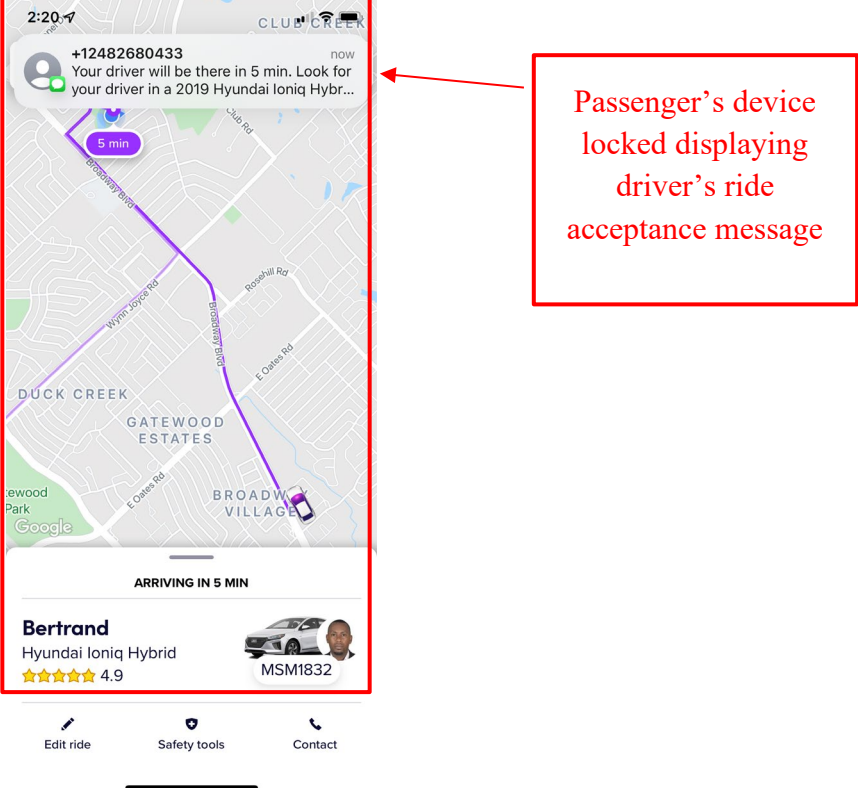
Claim - 8,213,970	Exemplary Supporting Evidence Regarding Accused Products
	 <p>The screenshot displays a Lyft ride acceptance notification. At the top, the time is 2:20. The message text reads: "+12482680433 now Your driver will be there in 5 min. Look for your driver in a 2019 Hyundai Ioniq Hybr...". Below the text is a map showing a route from the pickup location to the destination, with a "5 min" arrival indicator. The driver's name "Bertrand" and vehicle "Hyundai Ioniq Hybrid" are listed, along with a 4.9 star rating and license plate "MSM1832". At the bottom, there are icons for "Edit ride", "Safety tools", and "Contact". A red rectangular box highlights the message text and map area. A red arrow points from a text box on the right to the highlighted message.</p> <p>Passenger's device locked displaying driver's ride acceptance message</p>

RESTRICTED CONFIDENTIAL SOURCE CODE

Attachment D for US Patent No. 8,213,970 Against Lyft Accused Products

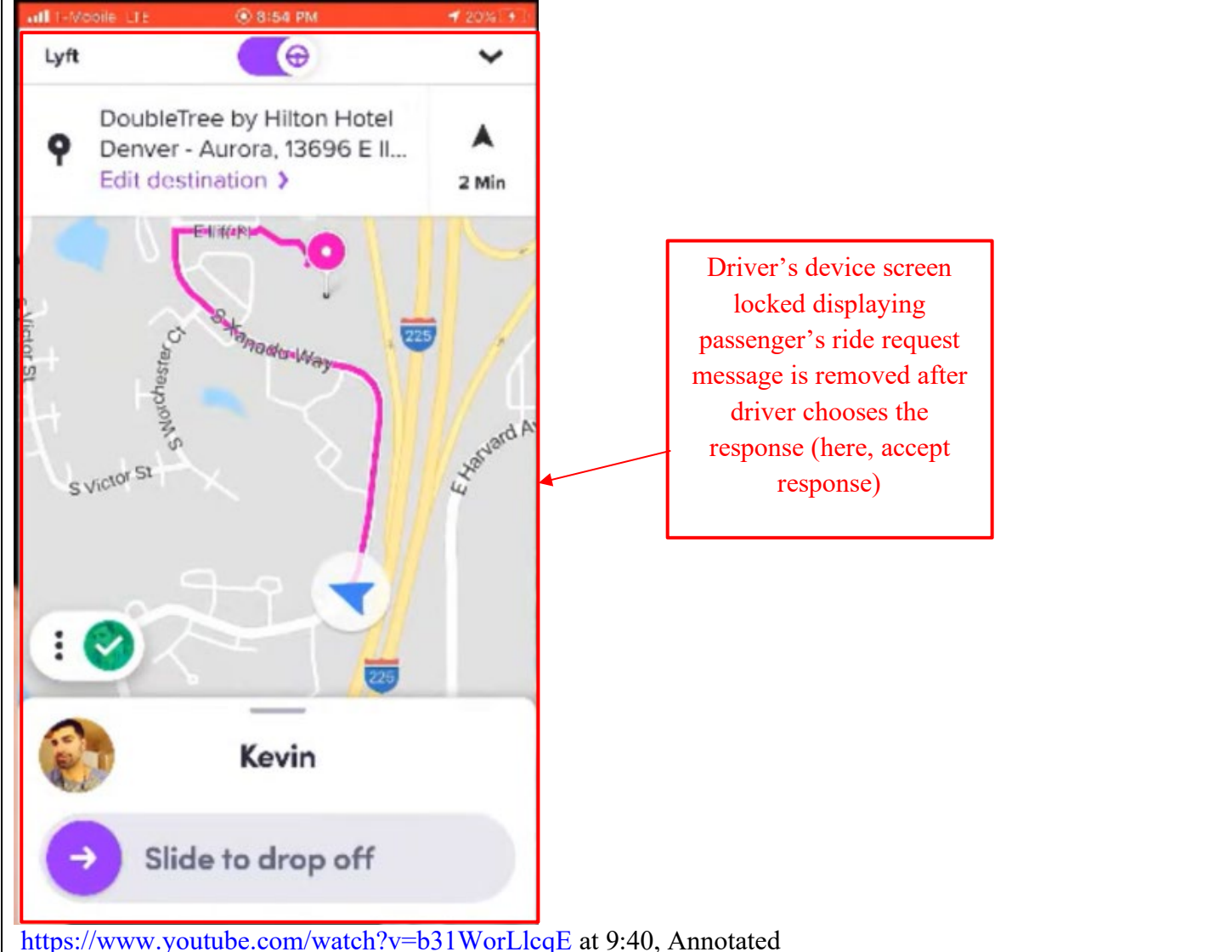
Claim - 8,213,970	Exemplary Supporting Evidence Regarding Accused Products
	 <p>Driver's device screen locked displaying passenger's ride request message is removed after driver chooses the response (here, accept response)</p> <p>https://www.youtube.com/watch?v=b31WorLlcqE at 9:40, Annotated</p>

RESTRICTED CONFIDENTIAL SOURCE CODE

Attachment D for US Patent No. 8,213,970 Against Lyft Accused Products

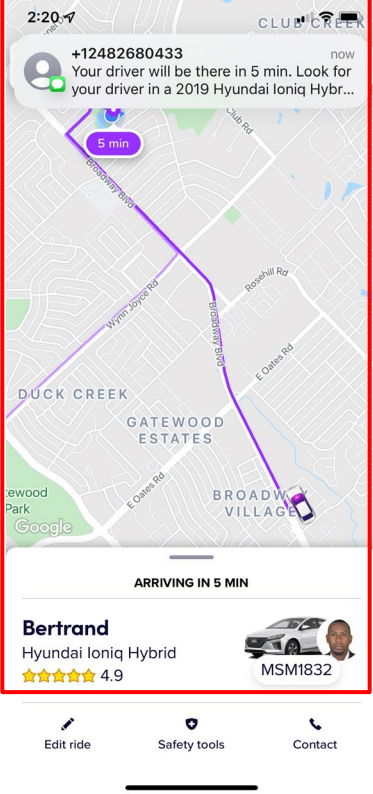
Claim - 8,213,970	Exemplary Supporting Evidence Regarding Accused Products
	 <p data-bbox="1024 342 1325 760">Passenger's device locked displaying driver's ride acceptance message message is removed after passenger chooses the response (here, accept response)</p> <p data-bbox="472 1122 1881 1230">Further, to the extent this element is performed at least in part by Lyft's software source code, AGIS reserves the right to supplement these contentions pursuant to production of such source code by Lyft and to the extent Lyft requires additional information in accordance with P.R. 3-1 and for any other reasons.</p>
<p>1[G]. means for receiving and displaying a listing of which recipient</p>	<p>The Lyft Accused Products infringe directly and/or indirectly by performing, inducing others to perform, and/or contributing to the performance of: means for receiving and displaying a listing of which recipient PDA/cell phones have automatically acknowledged the forced message alert and which recipient PDA/cell phones have not automatically acknowledged the forced message alert.</p>

RESTRICTED CONFIDENTIAL SOURCE CODE

Attachment D for US Patent No. 8,213,970 Against Lyft Accused Products

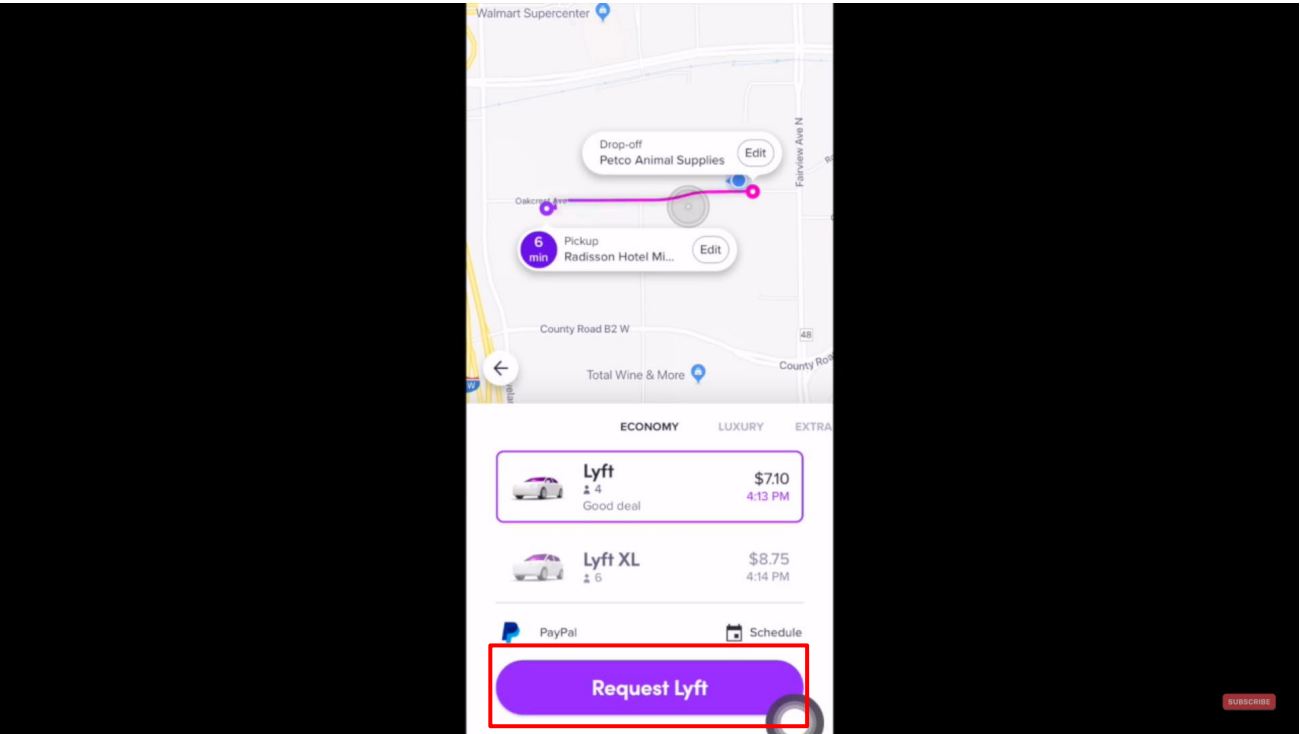
Claim - 8,213,970	Exemplary Supporting Evidence Regarding Accused Products
<p>PDA/cell phones have automatically acknowledged the forced message alert and which recipient PDA/cell phones have not automatically acknowledged the forced message alert;</p>	<p>For example, at the backend, each nearby driver's Lyft App ("recipient PDA/cell phone") that received ride request sends an acknowledgement of receipt to Lyft server(s).</p>  <p>https://www.youtube.com/watch?v=j0RDMLcmOgU at 4:01</p>

RESTRICTED CONFIDENTIAL SOURCE CODE

Attachment D for US Patent No. 8,213,970 Against Lyft Accused Products

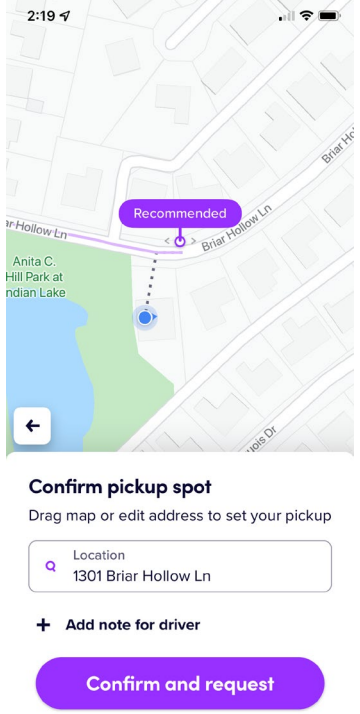
Claim - 8,213,970	Exemplary Supporting Evidence Regarding Accused Products
	 <p>The screenshot displays a mobile application interface for selecting a pickup location. At the top, a map shows a residential area with a purple dot and a purple arrow pointing to it, labeled "Recommended". The address "1301 Briar Hollow Ln" is entered in a search field. Below the map, the text "Confirm pickup spot" is followed by the instruction "Drag map or edit address to set your pickup". The search field contains "Location 1301 Briar Hollow Ln". There is an option to "+ Add note for driver" and a large purple button labeled "Confirm and request".</p>

RESTRICTED CONFIDENTIAL SOURCE CODE

Attachment D for US Patent No. 8,213,970 Against Lyft Accused Products

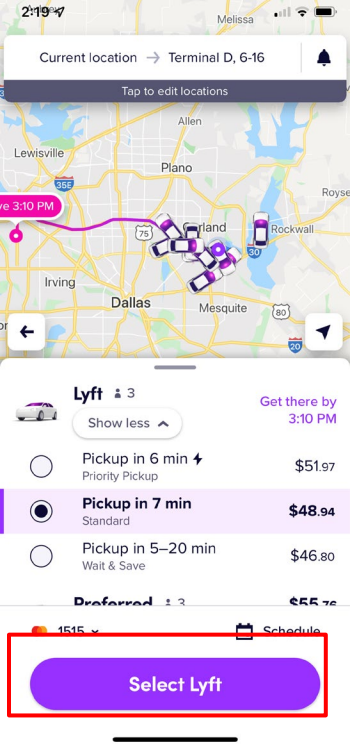
Claim - 8,213,970	Exemplary Supporting Evidence Regarding Accused Products
	 <p>The screenshot shows the Lyft app interface. At the top, the current location is 'Terminal D, 6-16'. The destination is marked with a purple dot on a map of Dallas. The estimated arrival time is 3:10 PM. Below the map, there are three pickup options: 'Priority Pickup' (6 min, \$51.97), 'Standard' (7 min, \$48.94), and 'Wait & Save' (5-20 min, \$46.80). The 'Standard' option is selected. At the bottom, there is a purple button labeled 'Select Lyft' which is highlighted with a red rectangular box.</p>

RESTRICTED CONFIDENTIAL SOURCE CODE

Attachment D for US Patent No. 8,213,970 Against Lyft Accused Products

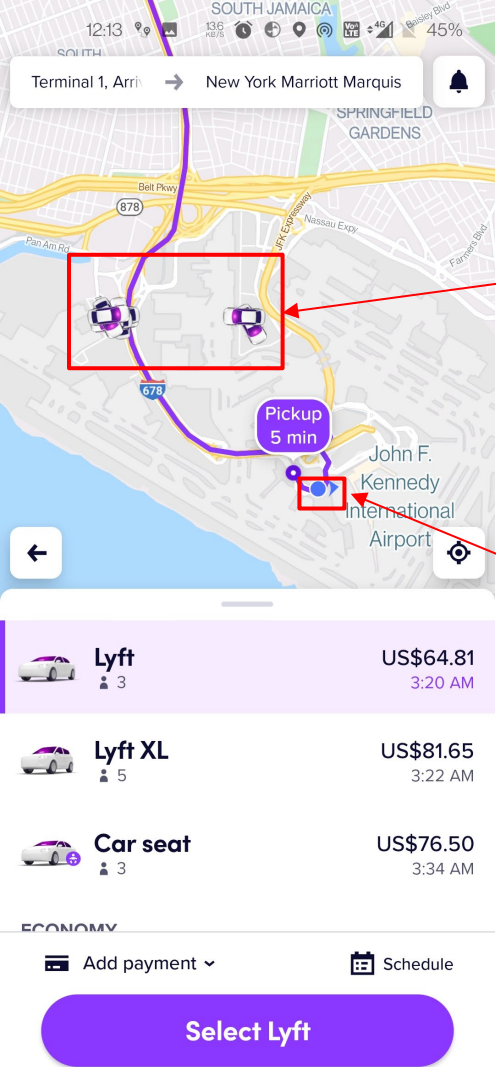
Claim - 8,213,970	Exemplary Supporting Evidence Regarding Accused Products												
	 <p data-bbox="478 285 970 893">Screenshot of a Lyft app interface. The top shows the route from Terminal 1, Arrivals to New York Marriott Marquis. The map displays the pickup location at JFK Airport and nearby drivers' locations. A red box highlights the pickup location, and another red box highlights nearby drivers' locations. Red arrows point from text boxes to these areas.</p> <table border="1" data-bbox="478 893 970 1201"><thead><tr><th>Vehicle Type</th><th>Price</th><th>Time</th></tr></thead><tbody><tr><td>Lyft (3 seats)</td><td>US\$64.81</td><td>3:20 AM</td></tr><tr><td>Lyft XL (5 seats)</td><td>US\$81.65</td><td>3:22 AM</td></tr><tr><td>Car seat (3 seats)</td><td>US\$76.50</td><td>3:34 AM</td></tr></tbody></table> <p data-bbox="478 1201 970 1347">ECONOMY Add payment Schedule Select Lyft</p> <p data-bbox="1134 402 1333 604">Nearby Drivers' location</p> <p data-bbox="1108 727 1341 922">Passenger's location</p>	Vehicle Type	Price	Time	Lyft (3 seats)	US\$64.81	3:20 AM	Lyft XL (5 seats)	US\$81.65	3:22 AM	Car seat (3 seats)	US\$76.50	3:34 AM
Vehicle Type	Price	Time											
Lyft (3 seats)	US\$64.81	3:20 AM											
Lyft XL (5 seats)	US\$81.65	3:22 AM											
Car seat (3 seats)	US\$76.50	3:34 AM											

RESTRICTED CONFIDENTIAL SOURCE CODE

Attachment D for US Patent No. 8,213,970 Against Lyft Accused Products

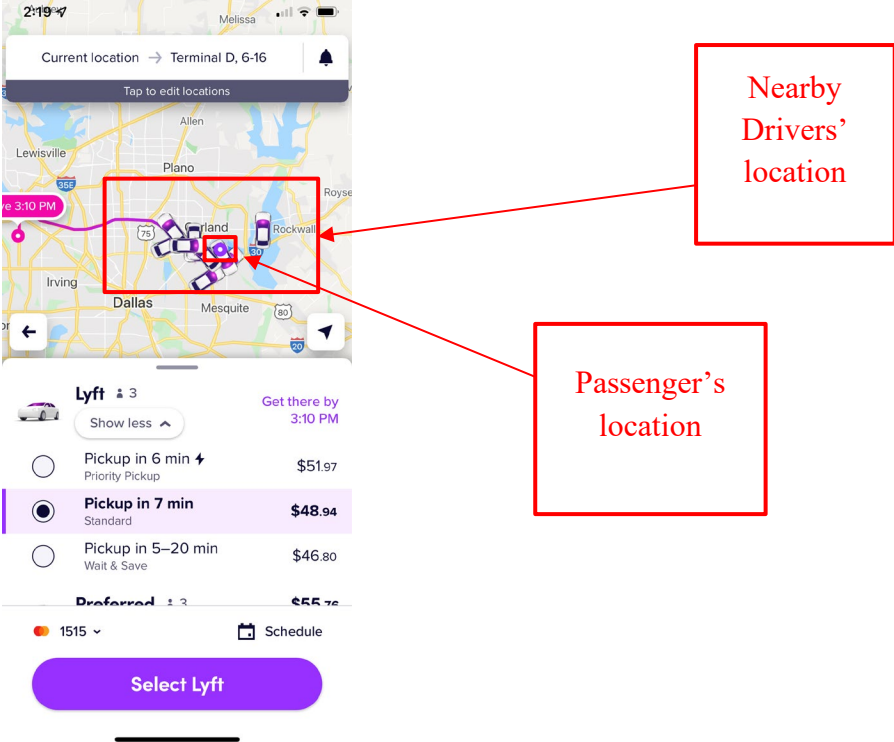
Claim - 8,213,970	Exemplary Supporting Evidence Regarding Accused Products
	 <p>The screenshot displays the Lyft app interface. At the top, the current location is 'Terminal D, 6-16' and the destination is '3:10 PM'. A map shows the area around Dallas, Texas, with a red box highlighting a cluster of driver icons. A red arrow points from this box to a text box labeled 'Nearby Drivers' location'. Another red arrow points from a specific driver icon to a text box labeled 'Passenger's location'. Below the map, the Lyft app shows three ride options: 'Priority Pickup' for \$51.97, 'Standard' for \$48.94 (selected), and 'Wait & Save' for \$46.80. A 'Select Lyft' button is visible at the bottom.</p>

RESTRICTED CONFIDENTIAL SOURCE CODE

Attachment D for US Patent No. 8,213,970 Against Lyft Accused Products

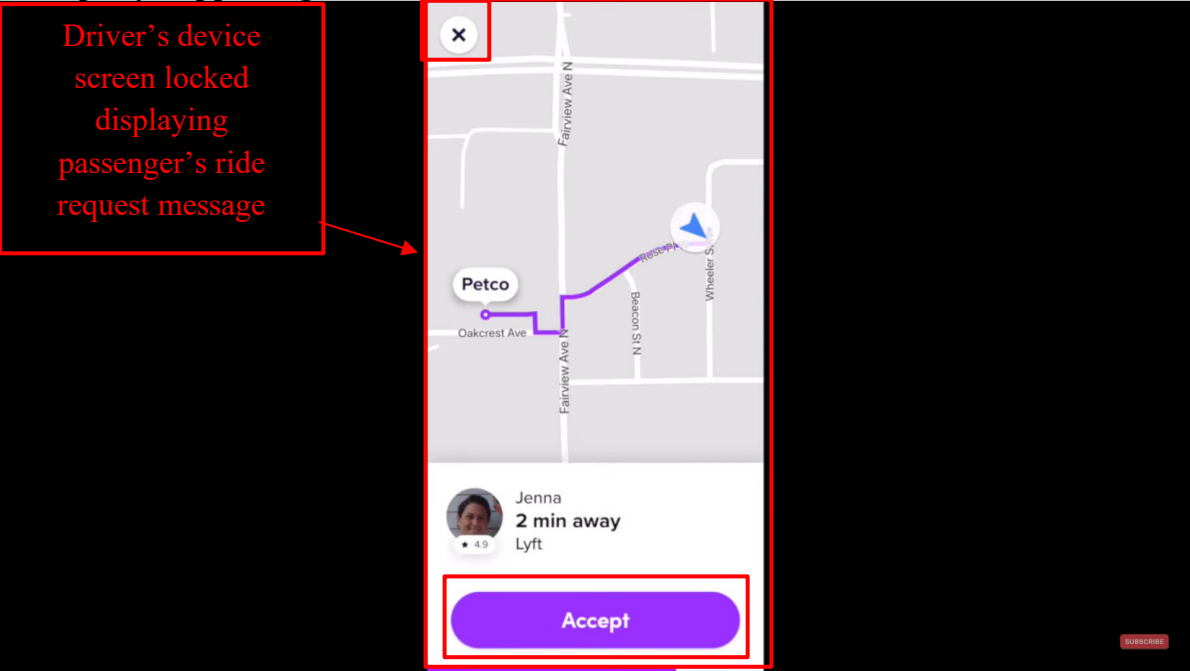
Claim - 8,213,970	Exemplary Supporting Evidence Regarding Accused Products
	<p data-bbox="531 302 743 505">Driver's device screen locked displaying passenger's ride request message</p>  <p data-bbox="478 954 1396 984">https://www.youtube.com/watch?v=jVUy9poJDng at 10:24, Annotated</p>

RESTRICTED CONFIDENTIAL SOURCE CODE

Attachment D for US Patent No. 8,213,970 Against Lyft Accused Products

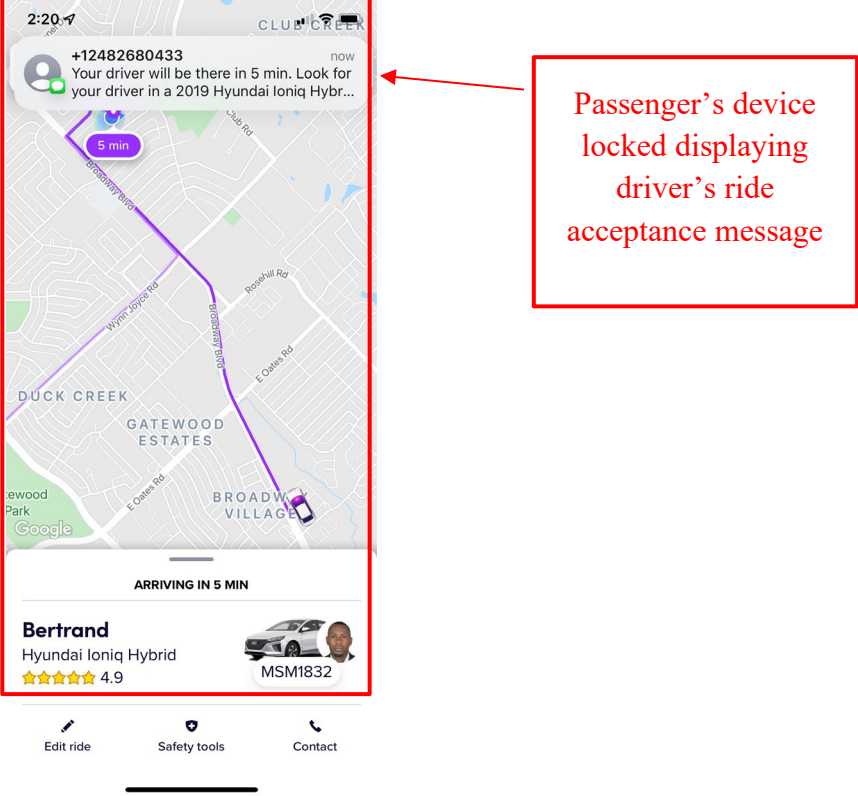
Claim - 8,213,970	Exemplary Supporting Evidence Regarding Accused Products
	 <p>Further, to the extent this element is performed at least in part by Lyft's software source code, AGIS reserves the right to supplement these contentions pursuant to production of such source code by Lyft and to the extent Lyft requires additional information in accordance with P.R. 3-1 and for any other reasons.</p>
<p>1[H]. means for periodically resending said forced message</p>	<p>The Lyft Accused Products infringe directly and/or indirectly by performing, inducing others to perform, and/or contributing to the performance of: means for periodically resending said forced message alert to said recipient PDA/cell phones that have not automatically acknowledged the forced message alert.</p>

RESTRICTED CONFIDENTIAL SOURCE CODE

Attachment D for US Patent No. 8,213,970 Against Lyft Accused Products

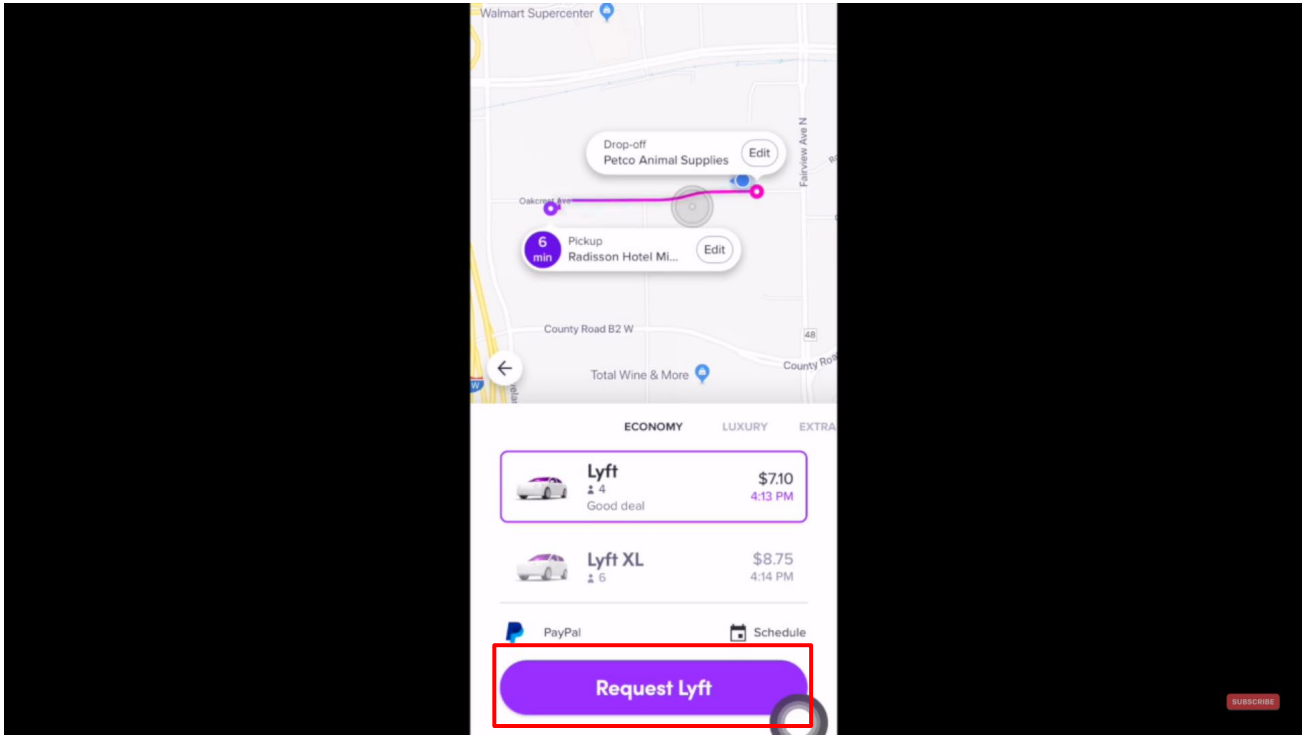
Claim - 8,213,970	Exemplary Supporting Evidence Regarding Accused Products
<p>alert to said recipient PDA/cell phones that have not automatically acknowledged the forced message alert; and</p>	<p>For example, at the backend, each nearby driver's Lyft app that received ride request sends an acknowledgement of receipt to Lyft server(s). Therefore, the second communication of the ride request is sent to those drivers' Lyft app who did not acknowledge the ride request message. This communication of ride request is periodically sent until the ride is accepted by any driver.</p>  <p>https://www.youtube.com/watch?v=j0RDMLcmOgU at 4:01</p>

RESTRICTED CONFIDENTIAL SOURCE CODE

Attachment D for US Patent No. 8,213,970 Against Lyft Accused Products

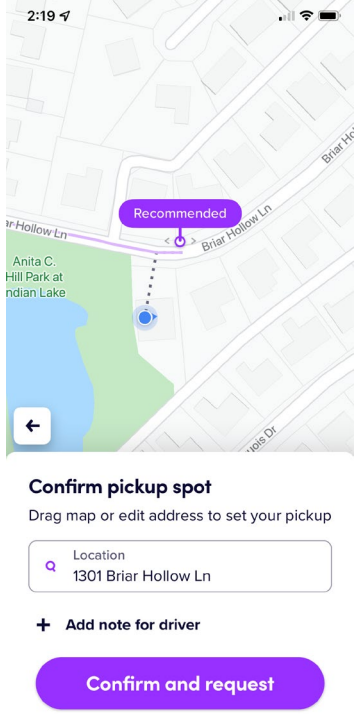
Claim - 8,213,970	Exemplary Supporting Evidence Regarding Accused Products
	 <p>The screenshot displays a mobile application interface for confirming a pickup location. At the top, a map shows a residential area with a purple dot indicating a 'Recommended' pickup spot at 1301 Briar Hollow Ln. Below the map, the text 'Confirm pickup spot' is followed by the instruction 'Drag map or edit address to set your pickup'. A search bar contains the text 'Location 1301 Briar Hollow Ln'. Below the search bar, there is a plus sign icon and the text '+ Add note for driver'. At the bottom, a large purple button is labeled 'Confirm and request'.</p>

RESTRICTED CONFIDENTIAL SOURCE CODE

Attachment D for US Patent No. 8,213,970 Against Lyft Accused Products

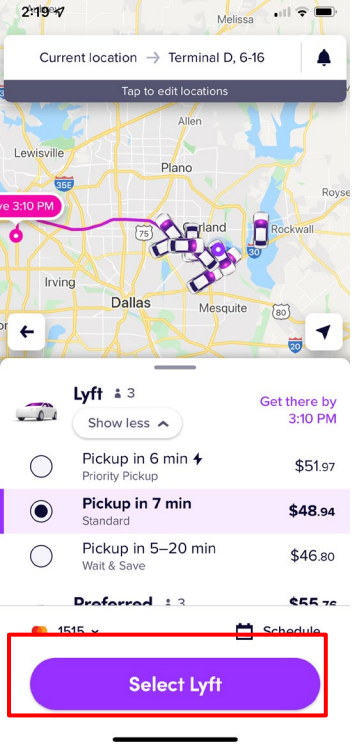
Claim - 8,213,970	Exemplary Supporting Evidence Regarding Accused Products												
	 <p>The screenshot displays the Lyft mobile application interface. At the top, the current location is set to 'Terminal D, 6-16' and the destination is '3:10 PM'. Below the map, three ride options are listed:</p> <table border="1"><thead><tr><th>Option</th><th>Estimated Time</th><th>Price</th></tr></thead><tbody><tr><td>Priority Pickup</td><td>Pickup in 6 min</td><td>\$51.97</td></tr><tr><td>Standard</td><td>Pickup in 7 min</td><td>\$48.94</td></tr><tr><td>Wait & Save</td><td>Pickup in 5-20 min</td><td>\$46.80</td></tr></tbody></table> <p>Below these options, a 'Preferred' section shows a price of \$55.76. At the bottom of the screen, a purple button labeled 'Select Lyft' is highlighted with a red rectangular box.</p>	Option	Estimated Time	Price	Priority Pickup	Pickup in 6 min	\$51.97	Standard	Pickup in 7 min	\$48.94	Wait & Save	Pickup in 5-20 min	\$46.80
Option	Estimated Time	Price											
Priority Pickup	Pickup in 6 min	\$51.97											
Standard	Pickup in 7 min	\$48.94											
Wait & Save	Pickup in 5-20 min	\$46.80											

RESTRICTED CONFIDENTIAL SOURCE CODE

Attachment D for US Patent No. 8,213,970 Against Lyft Accused Products

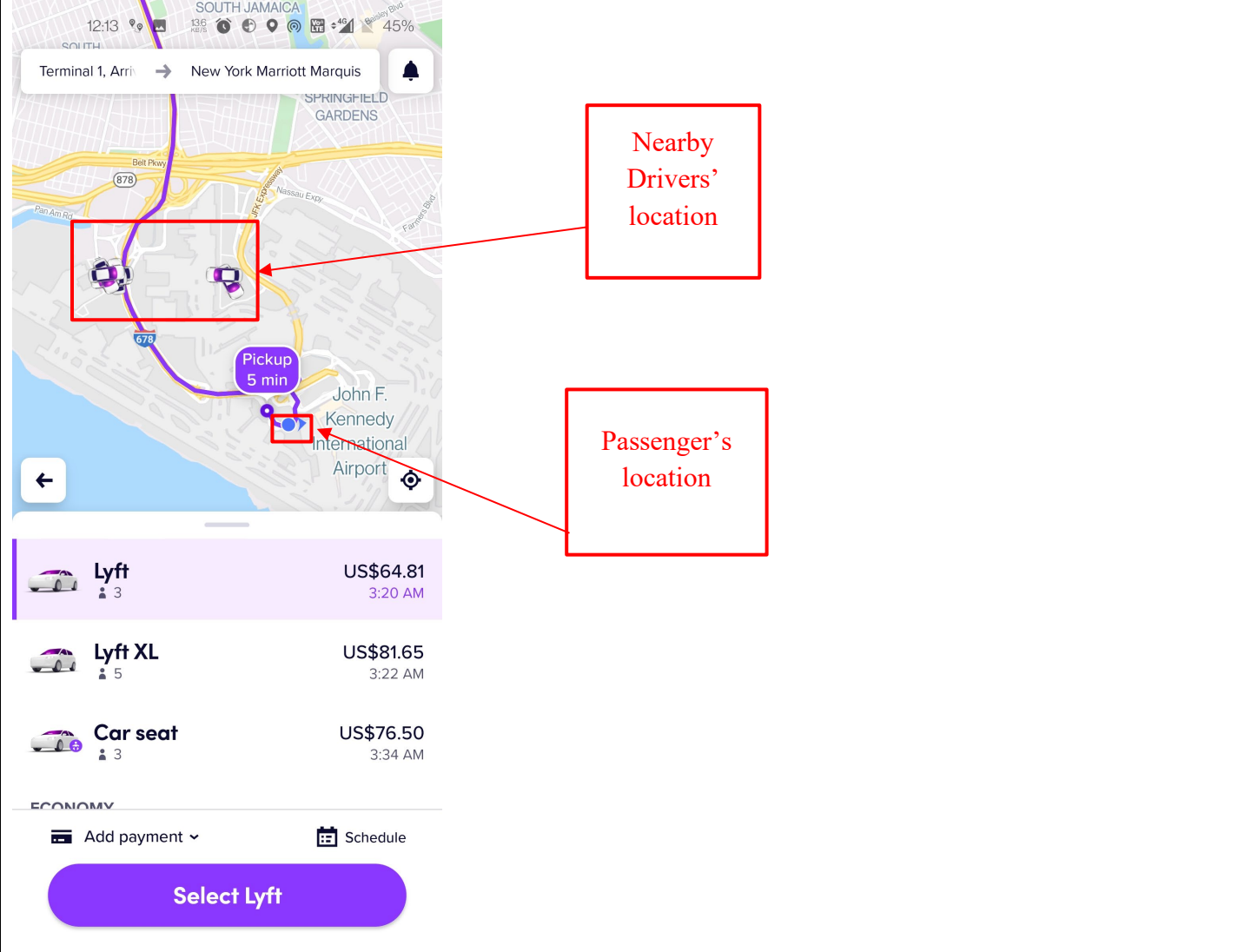
Claim - 8,213,970	Exemplary Supporting Evidence Regarding Accused Products
	 <p>The screenshot displays the Lyft app interface. At the top, the destination is set to 'New York Marriott Marquis' starting from 'Terminal 1, Arri'. The map shows the route from the airport to the hotel. A red box on the map highlights two driver icons, with a red arrow pointing to a text box labeled 'Nearby Drivers' location'. Another red box highlights the pickup location at John F. Kennedy International Airport, with a red arrow pointing to a text box labeled 'Passenger's location'. Below the map, three ride options are listed: 'Lyft' (US\$64.81, 3:20 AM), 'Lyft XL' (US\$81.65, 3:22 AM), and 'Car seat' (US\$76.50, 3:34 AM). At the bottom, there are options for 'Add payment' and 'Schedule', and a large purple button labeled 'Select Lyft'.</p>

RESTRICTED CONFIDENTIAL SOURCE CODE

Attachment D for US Patent No. 8,213,970 Against Lyft Accused Products

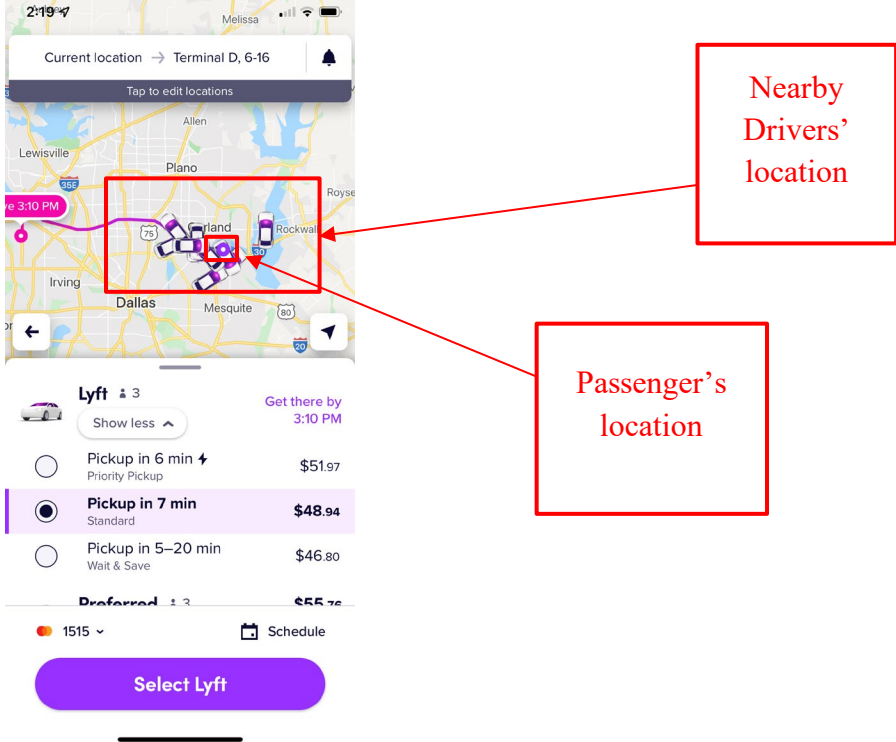
Claim - 8,213,970	Exemplary Supporting Evidence Regarding Accused Products
	 <p>The screenshot displays the Lyft app interface. At the top, the current location is 'Terminal D, 6-16' and the destination is '3:10 PM'. The map shows several driver icons clustered in the area around Rockwall, Texas. A red box highlights this cluster, with a red arrow pointing to a text box labeled 'Nearby Drivers' location'. Another red box highlights a single driver icon, with a red arrow pointing to a text box labeled 'Passenger's location'. Below the map, the app shows three ride options: 'Pickup in 6 min' for \$51.97, 'Pickup in 7 min' for \$48.94 (selected), and 'Pickup in 5-20 min' for \$46.80. A 'Select Lyft' button is visible at the bottom.</p>

RESTRICTED CONFIDENTIAL SOURCE CODE

Attachment D for US Patent No. 8,213,970 Against Lyft Accused Products

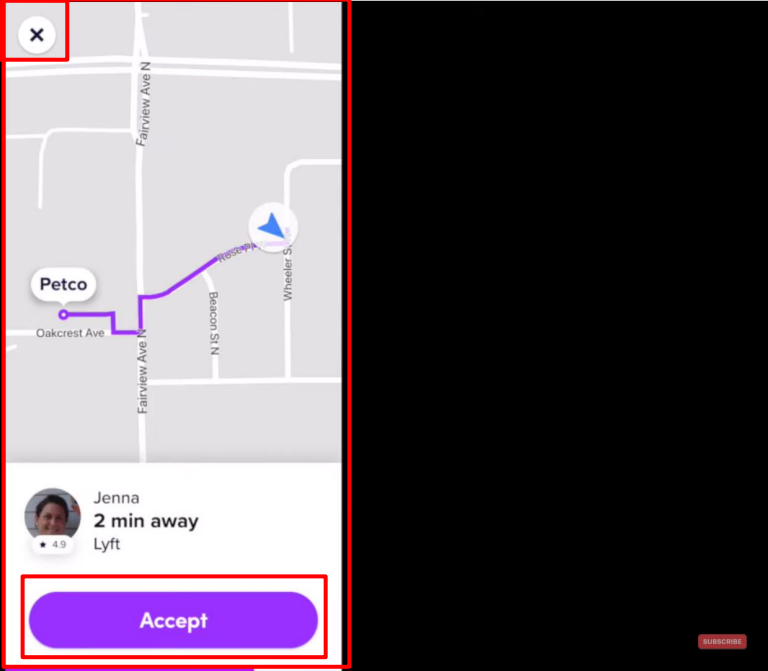
Claim - 8,213,970	Exemplary Supporting Evidence Regarding Accused Products
	<p data-bbox="531 302 743 505">Driver's device screen locked displaying passenger's ride request message</p>  <p data-bbox="478 954 1396 984">https://www.youtube.com/watch?v=jVUy9poJDng at 10:24, Annotated</p>

RESTRICTED CONFIDENTIAL SOURCE CODE

Attachment D for US Patent No. 8,213,970 Against Lyft Accused Products

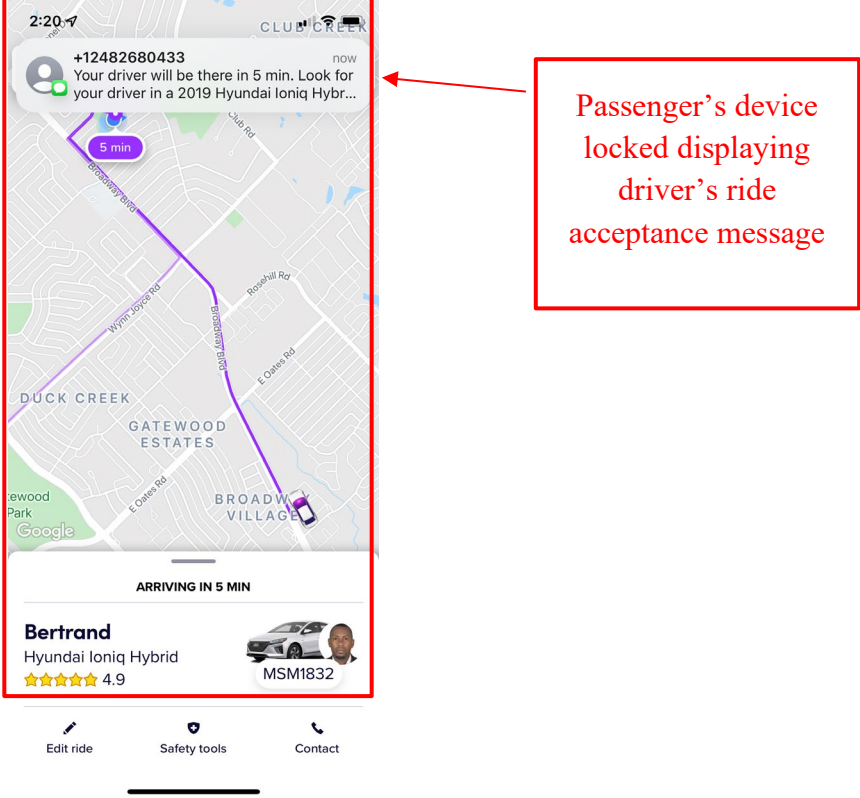
Claim - 8,213,970	Exemplary Supporting Evidence Regarding Accused Products
	 <p>2:20-7</p> <p>+12482680433 now Your driver will be there in 5 min. Look for your driver in a 2019 Hyundai Ioniq Hybr...</p> <p>5 min</p> <p>ARRIVING IN 5 MIN</p> <p>Bertrand Hyundai Ioniq Hybrid ★★★★★ 4.9 MSM1832</p> <p>Edit ride Safety tools Contact</p> <p>Further, to the extent this element is performed at least in part by Lyft's software source code, AGIS reserves the right to supplement these contentions pursuant to production of such source code by Lyft and to the extent Lyft requires additional information in accordance with P.R. 3-1 and for any other reasons.</p>
<p>1[I]. means for receiving and displaying a listing of which recipient</p>	<p>The Lyft Accused Products infringe directly and/or indirectly by performing, inducing others to perform, and/or contributing to the performance of: means for receiving and displaying a listing of which recipient PDA/cell phones have transmitted a manual response to said forced message alert and details the response from each recipient PDA/cell phone that responded.</p>

RESTRICTED CONFIDENTIAL SOURCE CODE

Attachment D for US Patent No. 8,213,970 Against Lyft Accused Products

Claim - 8,213,970	Exemplary Supporting Evidence Regarding Accused Products
<p>PDA/cell phones have transmitted a manual response to said forced message alert and details the response from each recipient PDA/cell phone that responded.</p>	<p>For example, at the backend, a list of all the drivers' Lyft app that transmitted the response to a ride request message of a passenger are maintained at Lyft's server(s). This ensures that drivers who declined the ride do not further receive the ride request of the same passenger in case the ride request has not been responded to and matches the driver to the passenger if the driver accepts the request. Therefore, Lyft's server(s) maintain a record of the responses from each of the drivers.</p> <div data-bbox="474 612 1766 1339" data-label="Image"> </div> <p>https://www.youtube.com/watch?v=j0RDMLcmOgU at 4:01</p>

RESTRICTED CONFIDENTIAL SOURCE CODE

Attachment D for US Patent No. 8,213,970 Against Lyft Accused Products

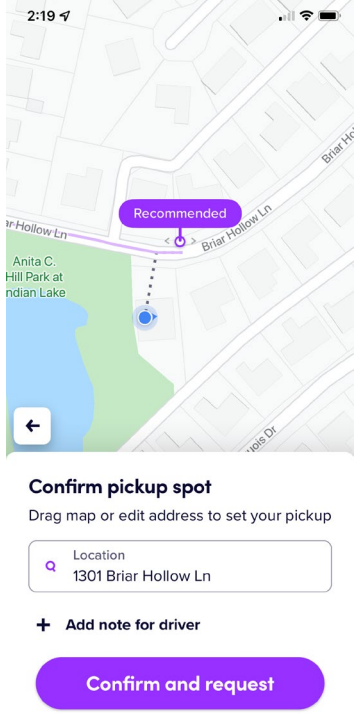
Claim - 8,213,970	Exemplary Supporting Evidence Regarding Accused Products
	 <p>The screenshot displays a mobile application interface for setting a pickup location. At the top, a map shows a residential area with a purple dot indicating a 'Recommended' pickup spot at 1301 Briar Hollow Ln. Below the map, the text 'Confirm pickup spot' is followed by the instruction 'Drag map or edit address to set your pickup'. A search bar contains the text 'Location 1301 Briar Hollow Ln'. Below the search bar, there is a plus sign icon and the text '+ Add note for driver'. At the bottom, a large purple button is labeled 'Confirm and request'.</p>

RESTRICTED CONFIDENTIAL SOURCE CODE

Attachment D for US Patent No. 8,213,970 Against Lyft Accused Products

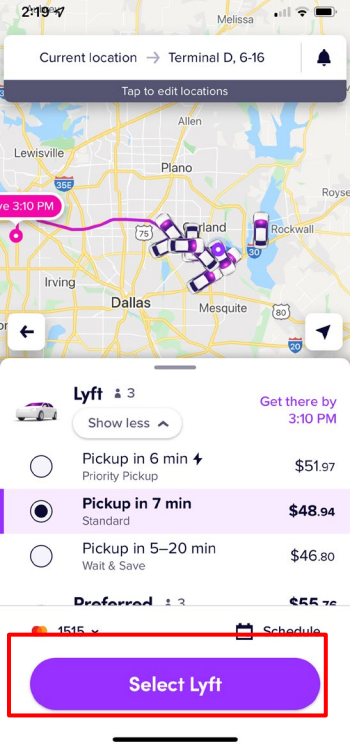
Claim - 8,213,970	Exemplary Supporting Evidence Regarding Accused Products												
	 <p>The screenshot displays the Lyft app interface. At the top, the current location is 'Terminal D, 6-16'. The destination is marked on a map of Dallas, Texas. The estimated arrival time is 3:10 PM. Below the map, there are three pickup options: 'Priority Pickup' (6 min, \$51.97), 'Standard' (7 min, \$48.94), and 'Wait & Save' (5-20 min, \$46.80). The 'Standard' option is selected. At the bottom, there is a 'Select Lyft' button highlighted with a red box.</p> <table border="1"><thead><tr><th>Pickup Option</th><th>Estimated Time</th><th>Estimated Price</th></tr></thead><tbody><tr><td>Priority Pickup</td><td>6 min</td><td>\$51.97</td></tr><tr><td>Standard</td><td>7 min</td><td>\$48.94</td></tr><tr><td>Wait & Save</td><td>5-20 min</td><td>\$46.80</td></tr></tbody></table>	Pickup Option	Estimated Time	Estimated Price	Priority Pickup	6 min	\$51.97	Standard	7 min	\$48.94	Wait & Save	5-20 min	\$46.80
Pickup Option	Estimated Time	Estimated Price											
Priority Pickup	6 min	\$51.97											
Standard	7 min	\$48.94											
Wait & Save	5-20 min	\$46.80											

RESTRICTED CONFIDENTIAL SOURCE CODE

Attachment D for US Patent No. 8,213,970 Against Lyft Accused Products

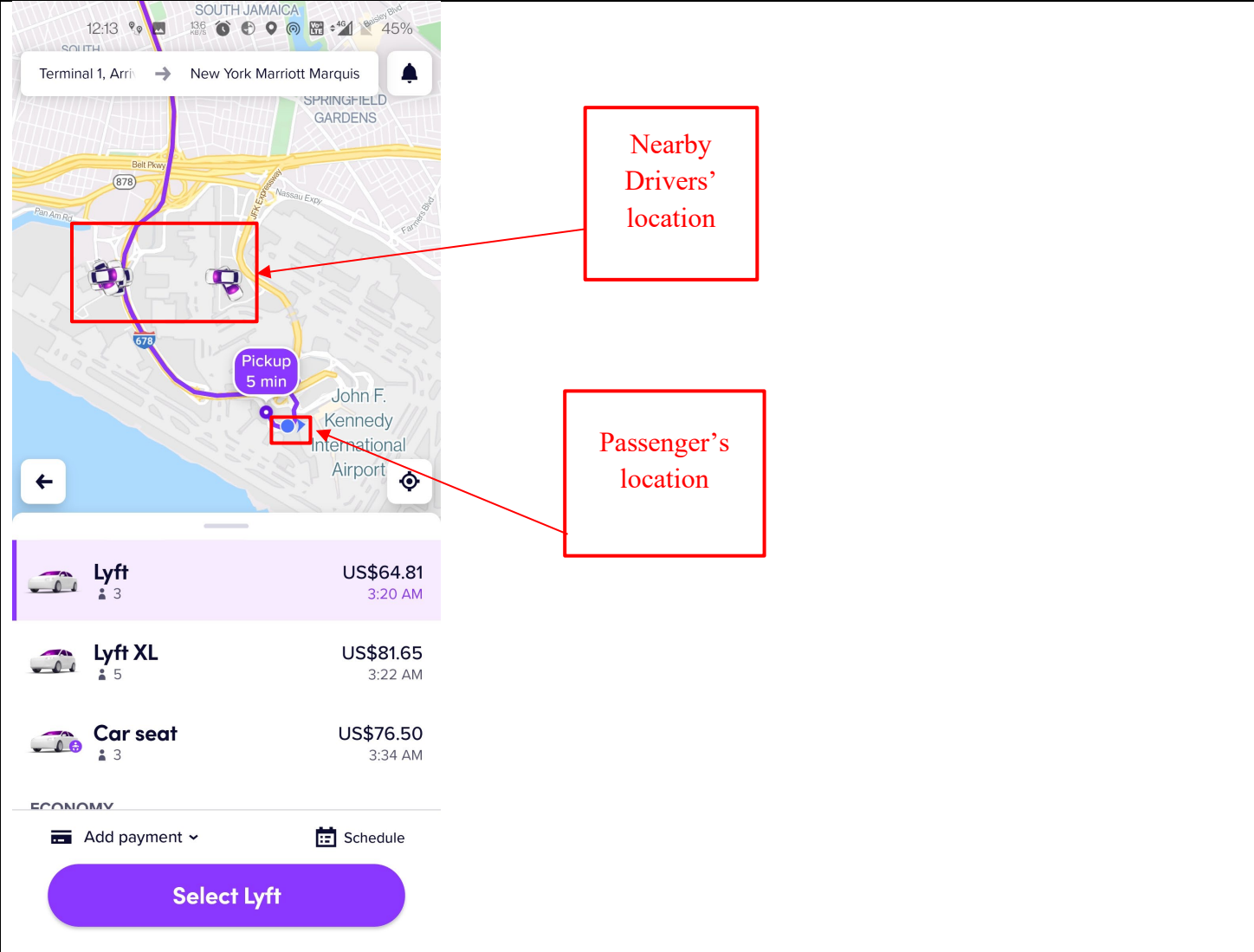
Claim - 8,213,970	Exemplary Supporting Evidence Regarding Accused Products												
	 <p>The screenshot displays the Lyft app interface. At the top, the map shows the route from Terminal 1, Arrivals to New York Marriott Marquis. A red box on the map highlights two driver icons, with a red arrow pointing to a text box labeled "Nearby Drivers' location". Another red box highlights the pickup location at John F. Kennedy International Airport, with a red arrow pointing to a text box labeled "Passenger's location". Below the map, the ride options are listed:</p> <table border="1"><thead><tr><th>Vehicle Type</th><th>Price</th><th>Time</th></tr></thead><tbody><tr><td>Lyft (3 seats)</td><td>US\$64.81</td><td>3:20 AM</td></tr><tr><td>Lyft XL (5 seats)</td><td>US\$81.65</td><td>3:22 AM</td></tr><tr><td>Car seat (3 seats)</td><td>US\$76.50</td><td>3:34 AM</td></tr></tbody></table> <p>At the bottom, there are options for "Add payment" and "Schedule", and a large purple button labeled "Select Lyft".</p>	Vehicle Type	Price	Time	Lyft (3 seats)	US\$64.81	3:20 AM	Lyft XL (5 seats)	US\$81.65	3:22 AM	Car seat (3 seats)	US\$76.50	3:34 AM
Vehicle Type	Price	Time											
Lyft (3 seats)	US\$64.81	3:20 AM											
Lyft XL (5 seats)	US\$81.65	3:22 AM											
Car seat (3 seats)	US\$76.50	3:34 AM											

RESTRICTED CONFIDENTIAL SOURCE CODE

Attachment D for US Patent No. 8,213,970 Against Lyft Accused Products

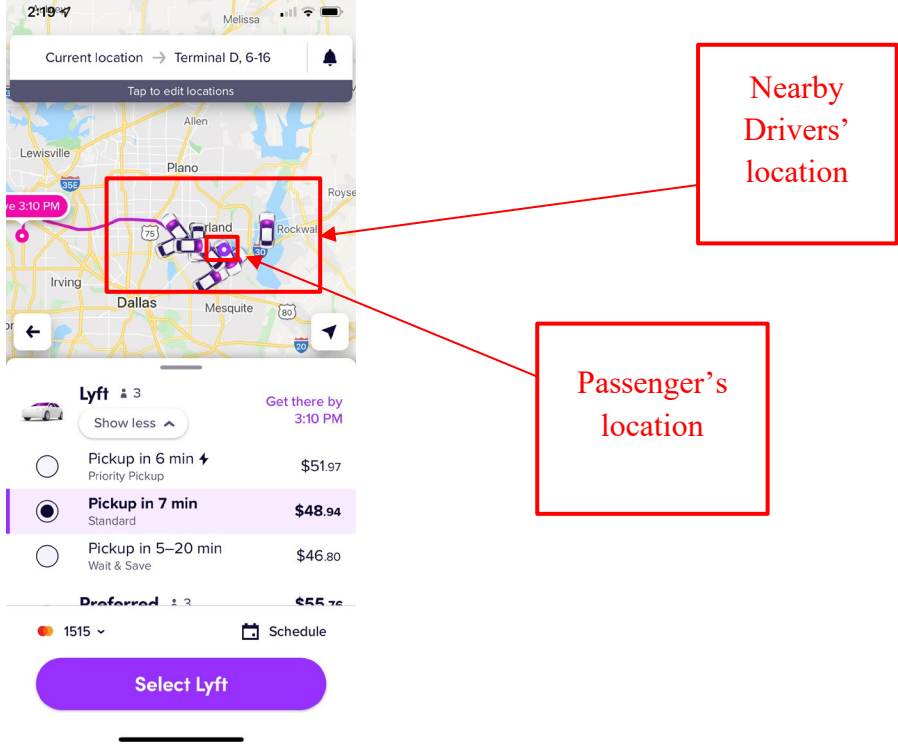
Claim - 8,213,970	Exemplary Supporting Evidence Regarding Accused Products
	 <p>The screenshot displays the Lyft app interface. At the top, the current location is 'Terminal D, 6-16'. The map shows a cluster of driver icons near Rockwall, Texas, highlighted by a red box. A red arrow points from this box to a text box labeled 'Nearby Drivers' location'. Another red arrow points from the same cluster to a text box labeled 'Passenger's location'. Below the map, the app shows three Lyft ride options: 'Priority Pickup' for \$51.97 (6 min), 'Standard' for \$48.94 (7 min), and 'Wait & Save' for \$46.80 (5-20 min). The 'Standard' option is selected. At the bottom, there is a 'Select Lyft' button.</p>

RESTRICTED CONFIDENTIAL SOURCE CODE

Attachment D for US Patent No. 8,213,970 Against Lyft Accused Products

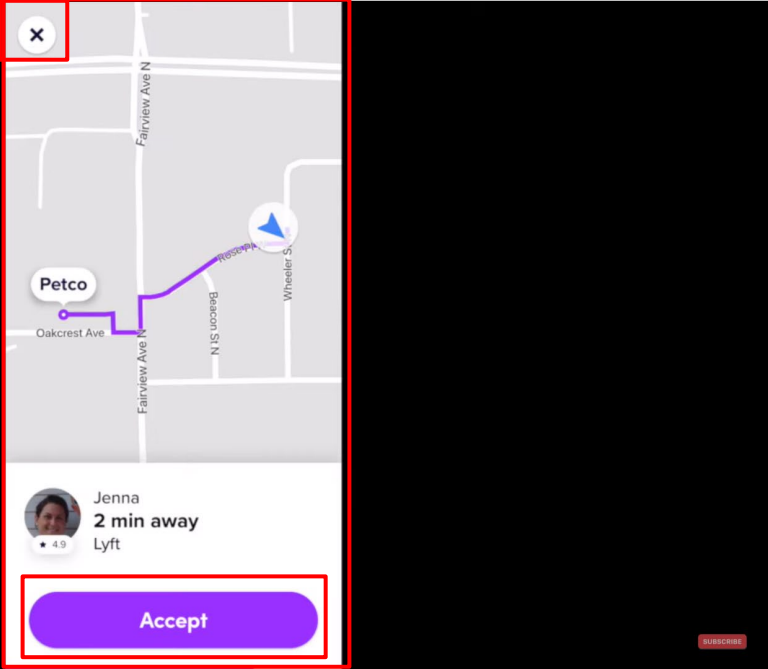
Claim - 8,213,970	Exemplary Supporting Evidence Regarding Accused Products
	<p data-bbox="531 300 743 500">Driver's device screen locked displaying passenger's ride request message</p>  <p data-bbox="478 954 1396 982">https://www.youtube.com/watch?v=jVUy9poJDng at 10:24, Annotated</p>

RESTRICTED CONFIDENTIAL SOURCE CODE

Attachment D for US Patent No. 8,213,970 Against Lyft Accused Products

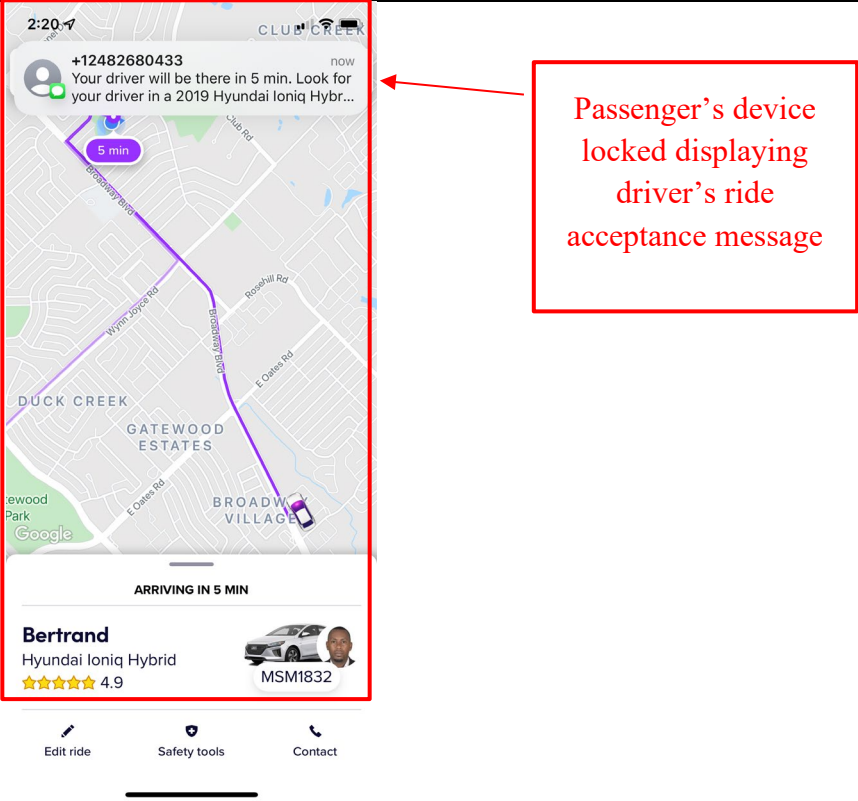
Claim - 8,213,970	Exemplary Supporting Evidence Regarding Accused Products
	 <p>The screenshot displays a Lyft ride acceptance notification. At the top, it shows the time 2:20 and the phone number +12482680433. The message reads: "Your driver will be there in 5 min. Look for your driver in a 2019 Hyundai Ioniq Hybr...". Below the message is a map showing the route from the pickup location to the destination, with a 5-minute arrival time indicated. The driver's name is Bertrand, and the vehicle is a 2019 Hyundai Ioniq Hybrid with a 4.9-star rating. The driver's license number is MSM1832. At the bottom, there are options to "Edit ride", "Safety tools", and "Contact". A red box highlights the message and driver information, with an arrow pointing to a text box that reads: "Passenger's device locked displaying driver's ride acceptance message".</p>

RESTRICTED CONFIDENTIAL SOURCE CODE

Attachment D for US Patent No. 8,213,970 Against Lyft Accused Products

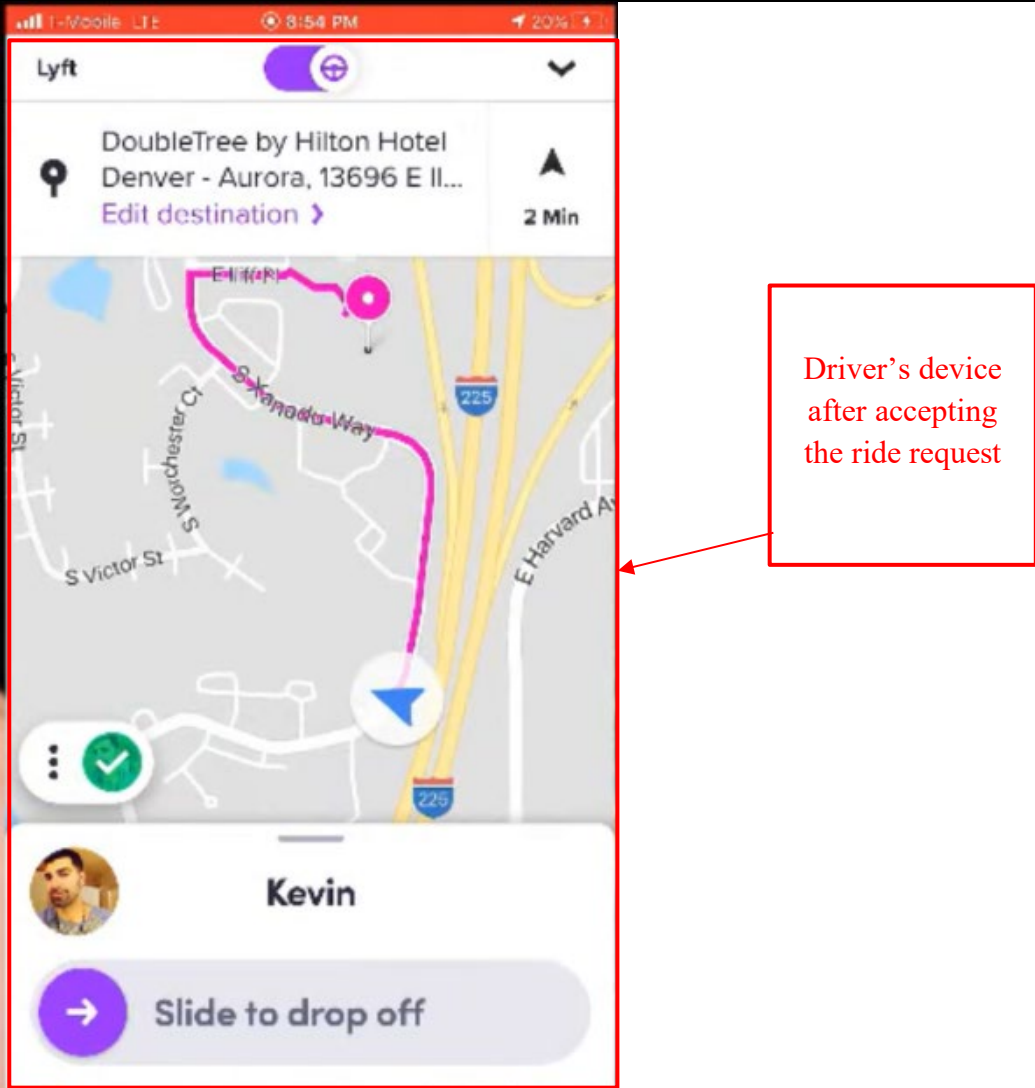
Claim - 8,213,970	Exemplary Supporting Evidence Regarding Accused Products
	 <p>https://www.youtube.com/watch?v=b31WorLlcqE at 9:40, Annotated</p>

RESTRICTED CONFIDENTIAL SOURCE CODE

Attachment D for US Patent No. 8,213,970 Against Lyft Accused Products

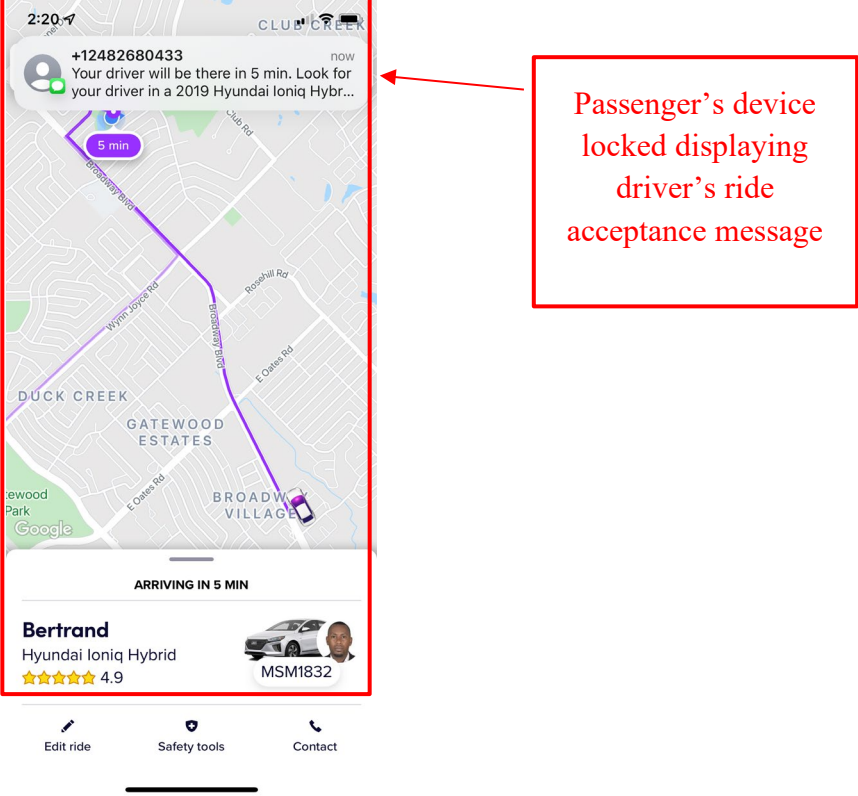
Claim - 8,213,970	Exemplary Supporting Evidence Regarding Accused Products
	 <p>2:20-7 CLU...CREK</p> <p>+12482680433 now Your driver will be there in 5 min. Look for your driver in a 2019 Hyundai Ioniq Hybr...</p> <p>5 min</p> <p>ARRIVING IN 5 MIN</p> <p>Bertrand Hyundai Ioniq Hybrid ★★★★★ 4.9 MSM1832</p> <p>Edit ride Safety tools Contact</p> <p>Further, to the extent this element is performed at least in part by Lyft's software source code, AGIS reserves the right to supplement these contentions pursuant to production of such source code by Lyft and to the extent Lyft requires additional information in accordance with P.R. 3-1 and for any other reasons.</p>
<p>2[A]. The system of claim 1, wherein the forced</p>	<p>The Lyft Accused Products comprise the system of claim 1: wherein the forced message alert software application program on the recipient PDA/cell phone includes: means for transmitting the acknowledgment of</p>

RESTRICTED CONFIDENTIAL SOURCE CODE

Attachment D for US Patent No. 8,213,970 Against Lyft Accused Products

Claim - 8,213,970	Exemplary Supporting Evidence Regarding Accused Products
<p>message alert software application program on the recipient PDA/cell phone includes: means for transmitting the acknowledgment of receipt to said sender PDA/cell phone immediately upon receiving a forced message alert from the sender PDA/cell phone;</p>	<p>receipt to said sender PDA/cell phone immediately upon receiving a forced message alert from the sender PDA/cell phone.</p> <p>For example, at the backend, the Lyft driver app in each nearby driver’s Lyft app that received a ride request sends an acknowledgement of receipt to Lyft’s server and further to the passenger’s Lyft app.</p>  <p>https://www.youtube.com/watch?v=j0RDMLcmOgU at 4:01</p>

RESTRICTED CONFIDENTIAL SOURCE CODE

Attachment D for US Patent No. 8,213,970 Against Lyft Accused Products

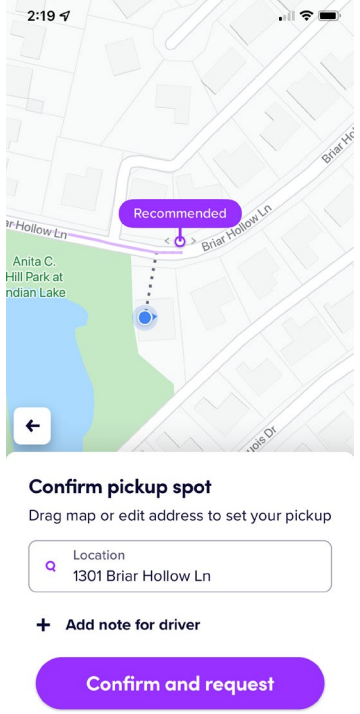
Claim - 8,213,970	Exemplary Supporting Evidence Regarding Accused Products
	 <p>The screenshot displays a mobile application interface for confirming a pickup location. At the top, a map shows a residential area with a purple dot indicating a 'Recommended' pickup spot at 1301 Briar Hollow Ln. Below the map, the text 'Confirm pickup spot' is followed by the instruction 'Drag map or edit address to set your pickup'. A search bar contains the text 'Location 1301 Briar Hollow Ln'. Below the search bar, there is a plus sign icon and the text '+ Add note for driver'. At the bottom, a large purple button is labeled 'Confirm and request'.</p>

RESTRICTED CONFIDENTIAL SOURCE CODE

Attachment D for US Patent No. 8,213,970 Against Lyft Accused Products

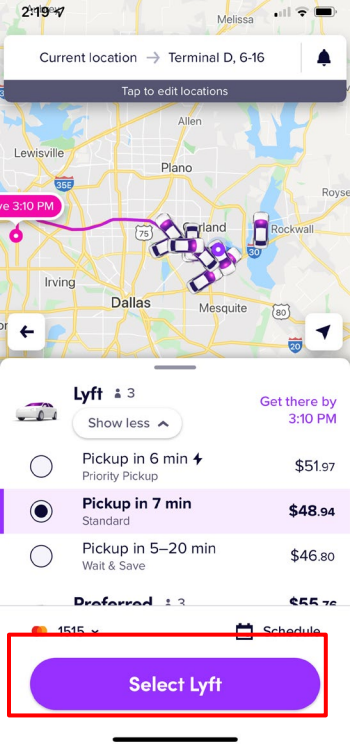
Claim - 8,213,970	Exemplary Supporting Evidence Regarding Accused Products												
	 <p>The screenshot shows the Lyft app interface. At the top, the current location is 'Terminal D, 6-16'. The destination is marked with a pink dot on a map of Dallas. The estimated arrival time is 3:10 PM. Below the map, there are three pickup options: 'Priority Pickup' (6 min, \$51.97), 'Standard' (7 min, \$48.94), and 'Wait & Save' (5-20 min, \$46.80). The 'Standard' option is selected. At the bottom, there is a 'Select Lyft' button highlighted with a red box.</p> <table border="1"><thead><tr><th>Option</th><th>Time</th><th>Price</th></tr></thead><tbody><tr><td>Priority Pickup</td><td>6 min</td><td>\$51.97</td></tr><tr><td>Standard</td><td>7 min</td><td>\$48.94</td></tr><tr><td>Wait & Save</td><td>5-20 min</td><td>\$46.80</td></tr></tbody></table>	Option	Time	Price	Priority Pickup	6 min	\$51.97	Standard	7 min	\$48.94	Wait & Save	5-20 min	\$46.80
Option	Time	Price											
Priority Pickup	6 min	\$51.97											
Standard	7 min	\$48.94											
Wait & Save	5-20 min	\$46.80											

RESTRICTED CONFIDENTIAL SOURCE CODE

Attachment D for US Patent No. 8,213,970 Against Lyft Accused Products

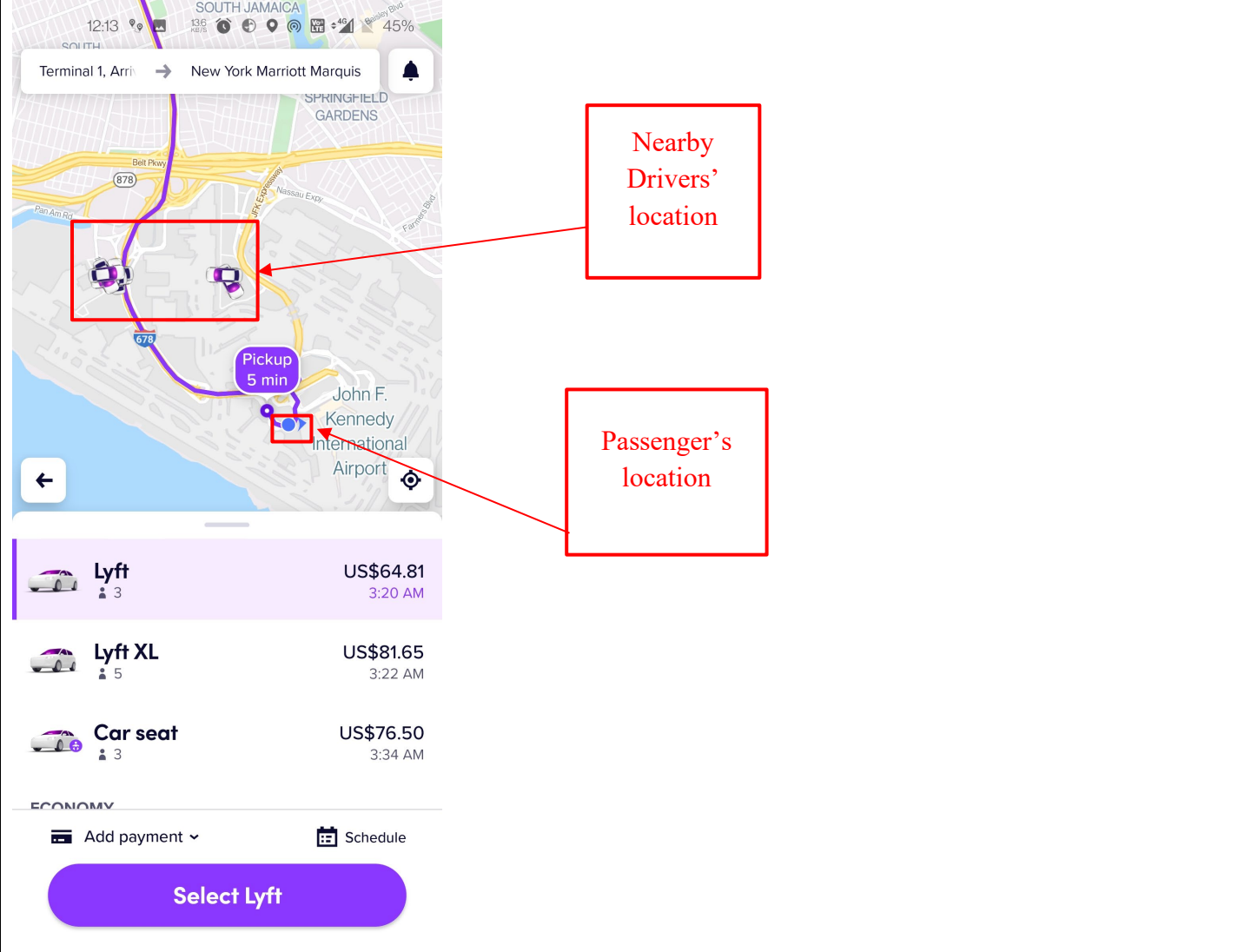
Claim - 8,213,970	Exemplary Supporting Evidence Regarding Accused Products
	 <p>The screenshot displays the Lyft app interface. At the top, the destination is set to 'New York Marriott Marquis' starting from 'Terminal 1, Arrivals'. The map shows the area around John F. Kennedy International Airport. A red box highlights two driver icons on the map, with a red arrow pointing to a text box labeled 'Nearby Drivers' location'. Another red box highlights the pickup location at John F. Kennedy International Airport, with a red arrow pointing to a text box labeled 'Passenger's location'. Below the map, three ride options are listed: 'Lyft' (US\$64.81, 3:20 AM), 'Lyft XL' (US\$81.65, 3:22 AM), and 'Car seat' (US\$76.50, 3:34 AM). At the bottom, there are options for 'Add payment' and 'Schedule', and a large purple button labeled 'Select Lyft'.</p>

RESTRICTED CONFIDENTIAL SOURCE CODE

Attachment D for US Patent No. 8,213,970 Against Lyft Accused Products

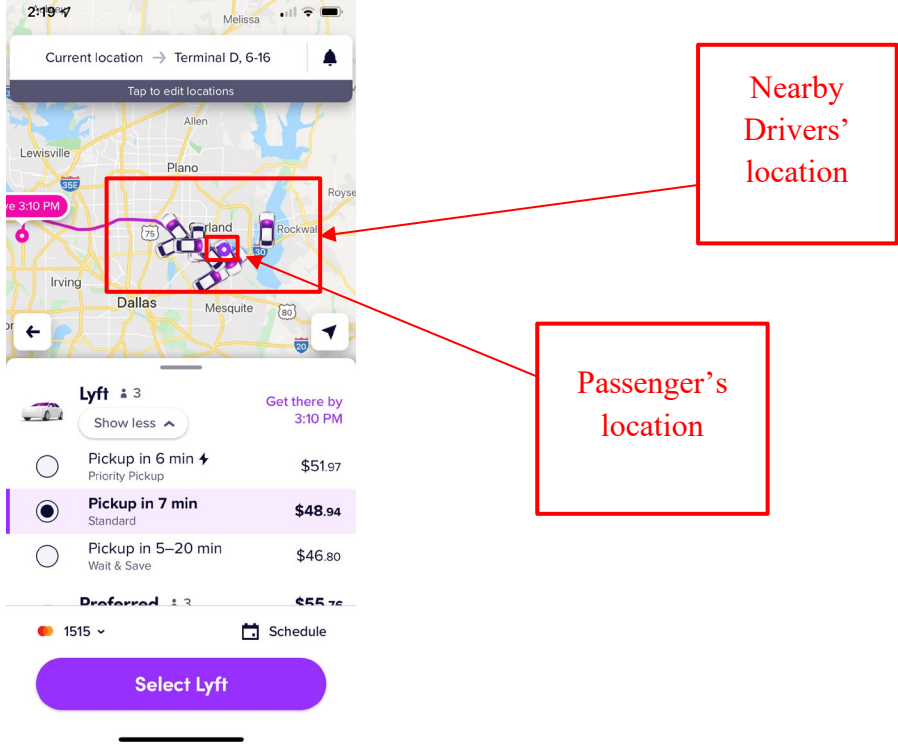
Claim - 8,213,970	Exemplary Supporting Evidence Regarding Accused Products
	 <p>The screenshot displays the Lyft app interface. At the top, the current location is set to 'Terminal D, 6-16'. The map shows a cluster of driver icons near Rockwall, Texas, highlighted by a red box. A red arrow points from this box to a text box labeled 'Nearby Drivers' location'. Another red arrow points from the same area to a text box labeled 'Passenger's location'. Below the map, the app shows three ride options: 'Priority Pickup' for \$51.97, 'Standard' for \$48.94 (selected), and 'Wait & Save' for \$46.80. A 'Select Lyft' button is visible at the bottom.</p>

RESTRICTED CONFIDENTIAL SOURCE CODE

Attachment D for US Patent No. 8,213,970 Against Lyft Accused Products

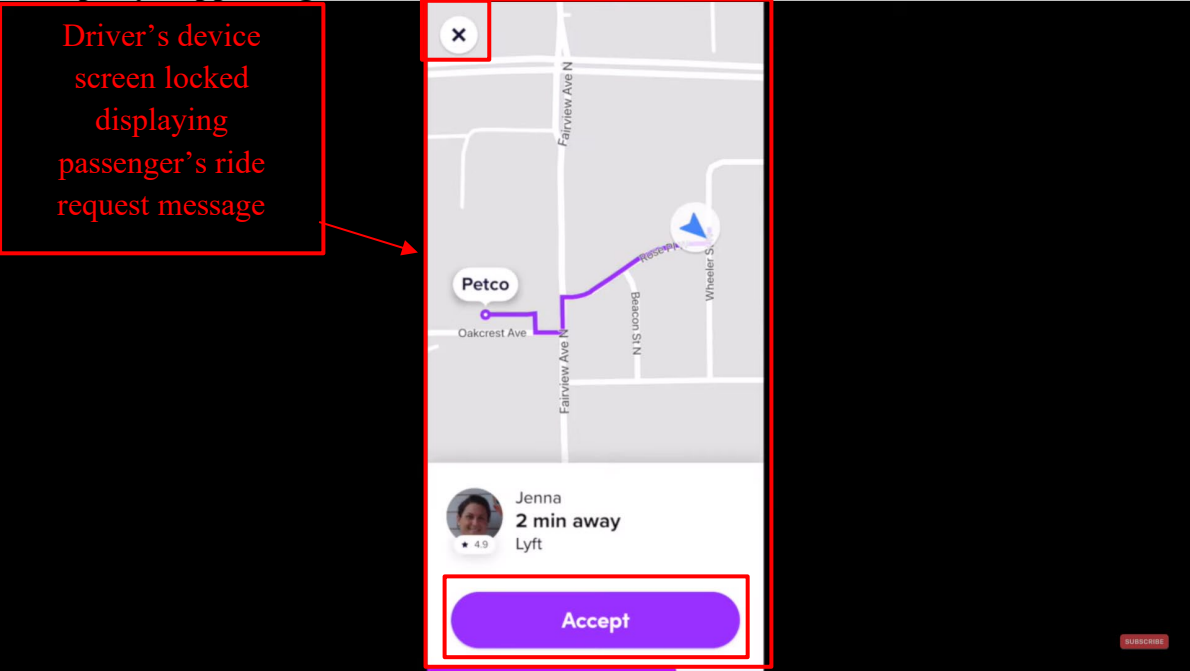
Claim - 8,213,970	Exemplary Supporting Evidence Regarding Accused Products
	<p data-bbox="531 300 743 500">Driver's device screen locked displaying passenger's ride request message</p>  <p data-bbox="478 954 1396 982">https://www.youtube.com/watch?v=jVUy9poJDng at 10:24, Annotated</p>

RESTRICTED CONFIDENTIAL SOURCE CODE

Attachment D for US Patent No. 8,213,970 Against Lyft Accused Products

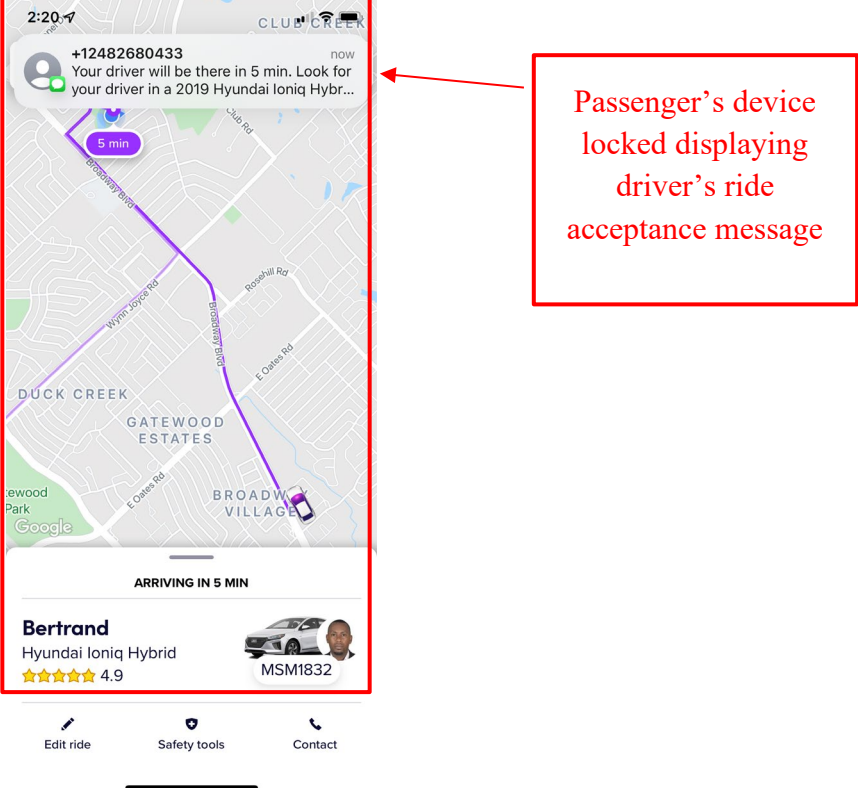
Claim - 8,213,970	Exemplary Supporting Evidence Regarding Accused Products
	 <p>The screenshot displays a Lyft ride acceptance notification. At the top, it shows the time 2:20 and the phone number +12482680433. The message reads: "Your driver will be there in 5 min. Look for your driver in a 2019 Hyundai Ioniq Hybr...". Below the message is a map showing a route from the pickup location to the destination, with a 5-minute arrival time. The driver's name is Bertrand, and the vehicle is a 2019 Hyundai Ioniq Hybrid with a 4.9-star rating. The license plate is MSM1832. At the bottom, there are options to "Edit ride", "Safety tools", and "Contact". A red box highlights the message and driver information, with an arrow pointing to a text box that reads: "Passenger's device locked displaying driver's ride acceptance message".</p>

RESTRICTED CONFIDENTIAL SOURCE CODE

Attachment D for US Patent No. 8,213,970 Against Lyft Accused Products

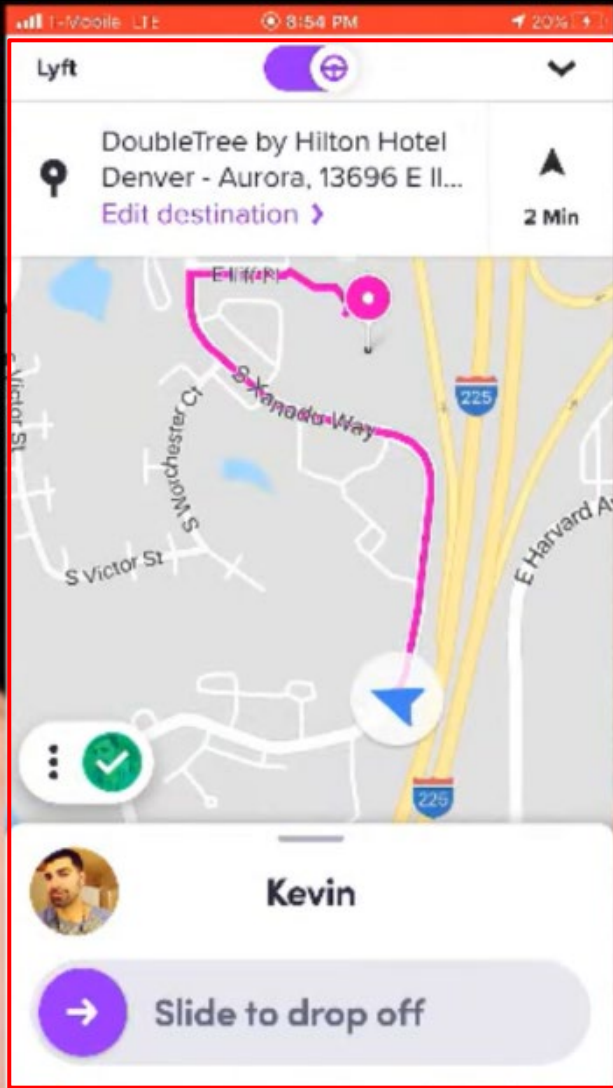
Claim - 8,213,970	Exemplary Supporting Evidence Regarding Accused Products
	 <p data-bbox="1241 565 1507 846">Driver's device after accepting the ride request</p> <p data-bbox="478 1365 1377 1399">https://www.youtube.com/watch?v=b31WorLlcqE at 9:40, Annotated</p>

RESTRICTED CONFIDENTIAL SOURCE CODE

Attachment D for US Patent No. 8,213,970 Against Lyft Accused Products

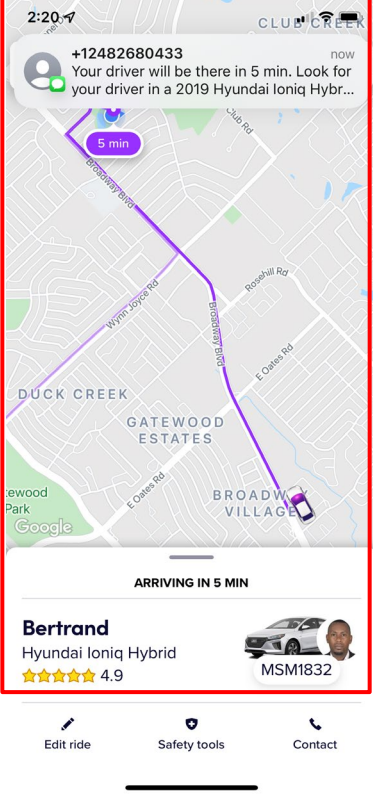
Claim - 8,213,970	Exemplary Supporting Evidence Regarding Accused Products
	 <p data-bbox="1003 342 1325 592" style="border: 1px solid red; padding: 5px; color: red; text-align: center;">Passenger's device locked displaying driver's ride acceptance message</p> <p data-bbox="472 1122 768 1154">See Claim 1[E] above.</p> <p data-bbox="472 1203 1881 1308">Further, to the extent this element is performed at least in part by Lyft's software source code, AGIS reserves the right to supplement these contentions pursuant to production of such source code by Lyft and to the extent Lyft requires additional information in accordance with P.R. 3-1 and for any other reasons.</p>
<p>2[B]. means for controlling of the</p>	<p>The Lyft Accused Products infringe directly and/or indirectly by performing, inducing others to perform, and/or contributing to the performance of: means for controlling of the recipient PDA/cell phone upon</p>

RESTRICTED CONFIDENTIAL SOURCE CODE

Attachment D for US Patent No. 8,213,970 Against Lyft Accused Products

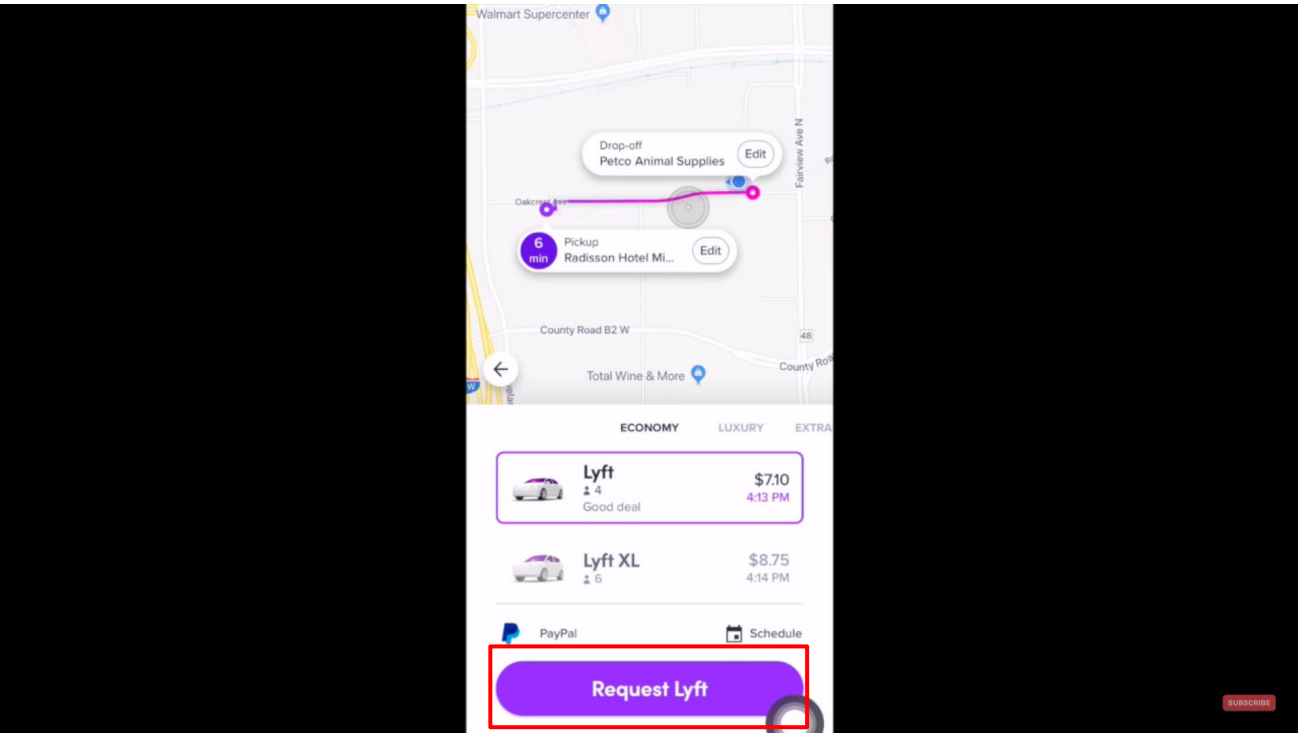
Claim - 8,213,970	Exemplary Supporting Evidence Regarding Accused Products
<p>recipient PDA/cell phone upon transmitting said automatic acknowledgment and causing, in cases where the force message alert is a text message, the text message and a response list to be shown on the display of the recipient PDA/cell phone or causes, in cases where the forced message alert is a voice message, the voice message being periodically repeated by the speakers of the recipient PDA/cell phone while said response list is shown on the display</p>	<p>transmitting said automatic acknowledgment and causing, in cases where the force message alert is a text message, the text message and a response list to be shown on the display of the recipient PDA/cell phone or causes, in cases where the forced message alert is a voice message, the voice message being periodically repeated by the speakers of the recipient PDA/cell phone while said response list is shown on the display</p> <p>For example, the Lyft Driver app receives an electronically transmitted request for a ride from a passenger which triggers a forced message alert that locks the driver’s Lyft app for a period of time until the driver sends a response message (decline (cross button) or accept) to clear the locked display.</p> 

RESTRICTED CONFIDENTIAL SOURCE CODE

Attachment D for US Patent No. 8,213,970 Against Lyft Accused Products

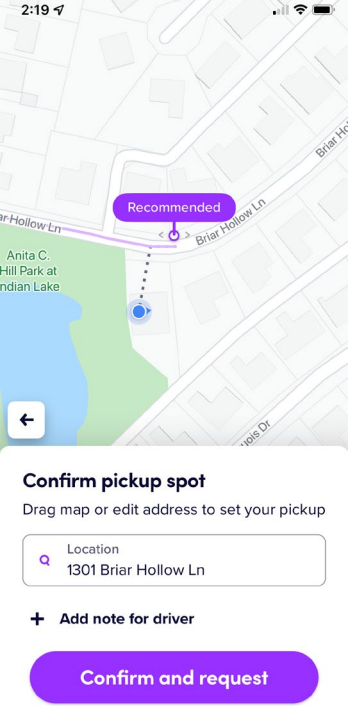
Claim - 8,213,970	Exemplary Supporting Evidence Regarding Accused Products
	<p data-bbox="478 289 1260 321">https://www.youtube.com/watch?v=j0RDMLcmOgU at 4:01</p>  <p data-bbox="478 332 829 779">The screenshot shows a mobile application interface for setting a pickup location. At the top, the time is 2:19. The map displays a residential area with streets labeled 'Briar Hollow Ln' and 'Anita C. Hill Park at Indian Lake'. A purple dot on the map is labeled 'Recommended'. Below the map, the text 'Confirm pickup spot' is followed by the instruction 'Drag map or edit address to set your pickup'. A search bar contains the text 'Location' and '1301 Briar Hollow Ln'. Below the search bar is a plus sign and the text 'Add note for driver'. At the bottom, there is a large purple button labeled 'Confirm and request'.</p>

RESTRICTED CONFIDENTIAL SOURCE CODE

Attachment D for US Patent No. 8,213,970 Against Lyft Accused Products

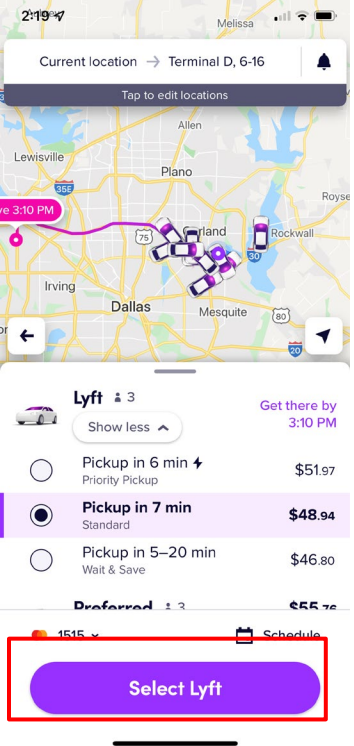
Claim - 8,213,970	Exemplary Supporting Evidence Regarding Accused Products												
	 <p>The screenshot shows the Lyft app interface. At the top, the current location is 'Terminal D, 6-16'. Below the map, there are three Lyft options:</p> <table border="1"><thead><tr><th>Option</th><th>Price</th><th>Time</th></tr></thead><tbody><tr><td>Pickup in 6 min (Priority Pickup)</td><td>\$51.97</td><td>6 min</td></tr><tr><td>Pickup in 7 min (Standard)</td><td>\$48.94</td><td>7 min</td></tr><tr><td>Pickup in 5-20 min (Wait & Save)</td><td>\$46.80</td><td>5-20 min</td></tr></tbody></table> <p>A red box highlights the 'Select Lyft' button at the bottom of the screen.</p>	Option	Price	Time	Pickup in 6 min (Priority Pickup)	\$51.97	6 min	Pickup in 7 min (Standard)	\$48.94	7 min	Pickup in 5-20 min (Wait & Save)	\$46.80	5-20 min
Option	Price	Time											
Pickup in 6 min (Priority Pickup)	\$51.97	6 min											
Pickup in 7 min (Standard)	\$48.94	7 min											
Pickup in 5-20 min (Wait & Save)	\$46.80	5-20 min											

RESTRICTED CONFIDENTIAL SOURCE CODE

Attachment D for US Patent No. 8,213,970 Against Lyft Accused Products

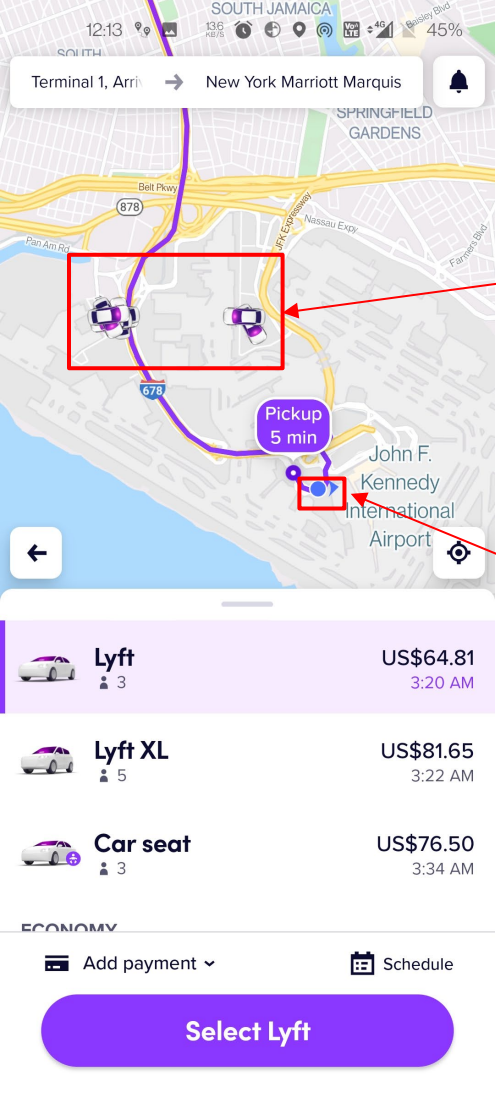
Claim - 8,213,970	Exemplary Supporting Evidence Regarding Accused Products												
	 <p data-bbox="478 285 970 893">The screenshot shows a Lyft ride request from Terminal 1, Arrivals to New York Marriott Marquis. The map displays the pickup location at JFK Airport and nearby drivers' locations. A red box highlights the pickup location, and another red box highlights nearby drivers' locations. Red arrows point from text boxes to these areas.</p> <table border="1" data-bbox="478 893 970 1201"><thead><tr><th>Vehicle Type</th><th>Price</th><th>Time</th></tr></thead><tbody><tr><td>Lyft (3 seats)</td><td>US\$64.81</td><td>3:20 AM</td></tr><tr><td>Lyft XL (5 seats)</td><td>US\$81.65</td><td>3:22 AM</td></tr><tr><td>Car seat (3 seats)</td><td>US\$76.50</td><td>3:34 AM</td></tr></tbody></table> <p data-bbox="478 1201 970 1375">ECONOMY Add payment Schedule Select Lyft</p> <p data-bbox="1129 402 1333 604">Nearby Drivers' location</p> <p data-bbox="1108 727 1341 922">Passenger's location</p>	Vehicle Type	Price	Time	Lyft (3 seats)	US\$64.81	3:20 AM	Lyft XL (5 seats)	US\$81.65	3:22 AM	Car seat (3 seats)	US\$76.50	3:34 AM
Vehicle Type	Price	Time											
Lyft (3 seats)	US\$64.81	3:20 AM											
Lyft XL (5 seats)	US\$81.65	3:22 AM											
Car seat (3 seats)	US\$76.50	3:34 AM											

RESTRICTED CONFIDENTIAL SOURCE CODE

Attachment D for US Patent No. 8,213,970 Against Lyft Accused Products

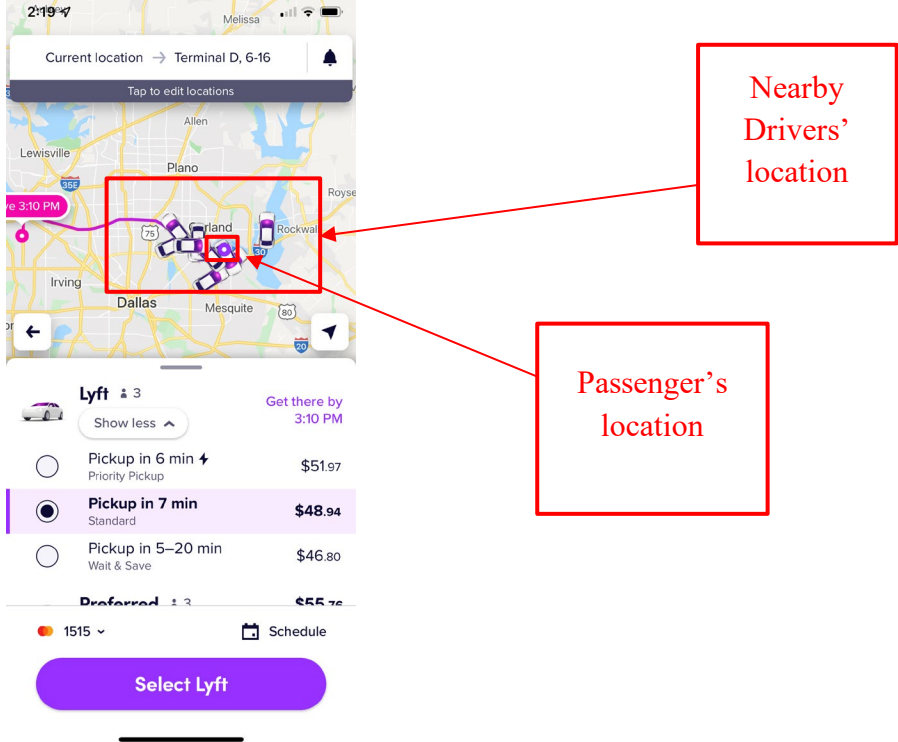
Claim - 8,213,970	Exemplary Supporting Evidence Regarding Accused Products
	 <p>The screenshot displays the Lyft app interface. At the top, the current location is set to 'Terminal D, 6-16'. The map shows a cluster of driver icons near Rockwall, Texas, highlighted by a red box. A red arrow points from this box to a text box labeled 'Nearby Drivers' location'. Another red arrow points from the same area to a text box labeled 'Passenger's location'. Below the map, the app shows three Lyft ride options: 'Priority Pickup' for \$51.97 (6 min), 'Standard' for \$48.94 (7 min), and 'Wait & Save' for \$46.80 (5-20 min). The 'Standard' option is selected. At the bottom, there is a 'Select Lyft' button.</p>

RESTRICTED CONFIDENTIAL SOURCE CODE

Attachment D for US Patent No. 8,213,970 Against Lyft Accused Products

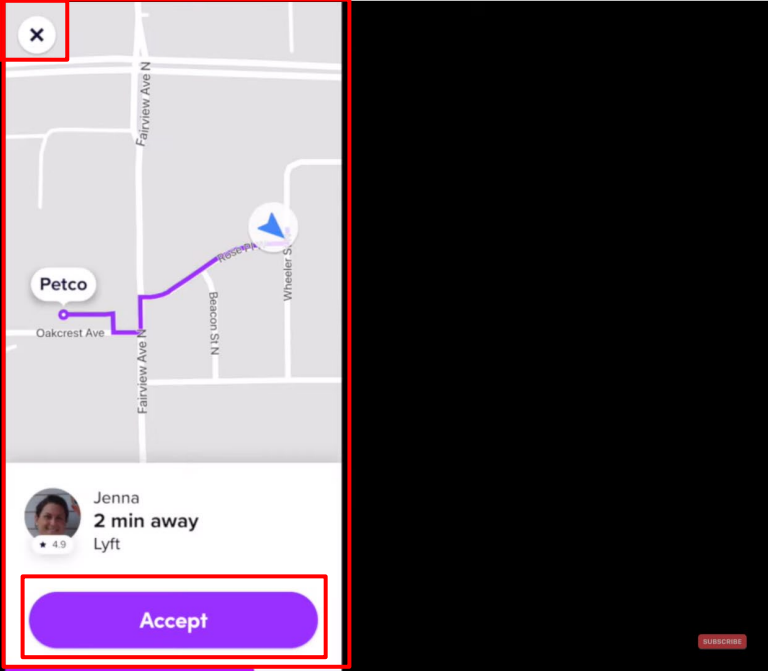
Claim - 8,213,970	Exemplary Supporting Evidence Regarding Accused Products
	<p data-bbox="531 302 743 505">Driver's device screen locked displaying passenger's ride request message</p>  <p data-bbox="478 954 1396 982">https://www.youtube.com/watch?v=jVUy9poJDng at 10:24, Annotated</p>

RESTRICTED CONFIDENTIAL SOURCE CODE

Attachment D for US Patent No. 8,213,970 Against Lyft Accused Products

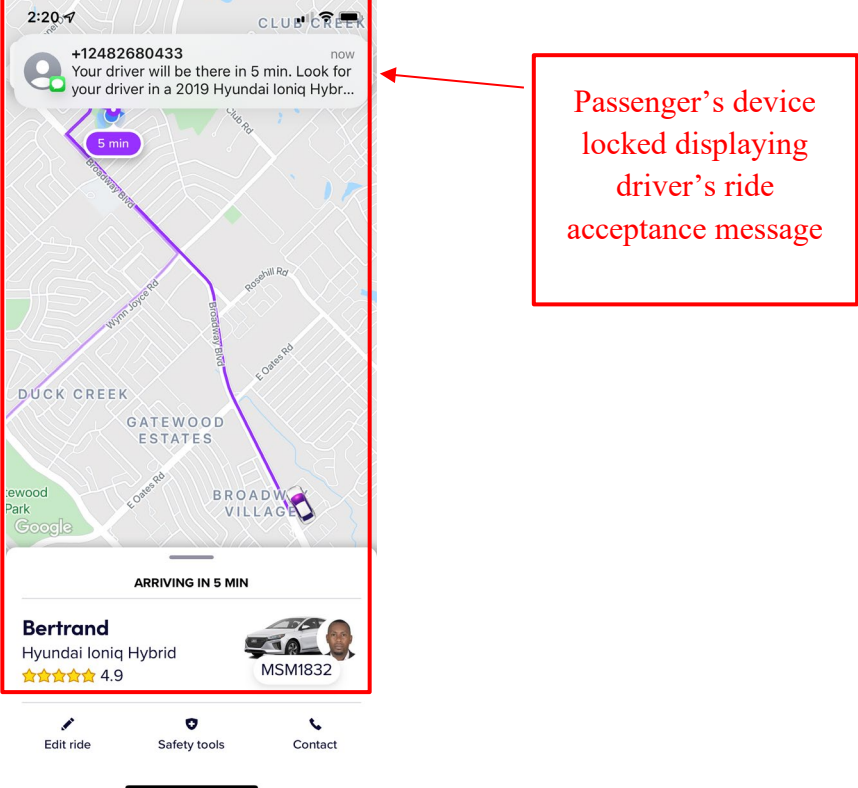
Claim - 8,213,970	Exemplary Supporting Evidence Regarding Accused Products
	 <p data-bbox="1003 342 1325 591">Passenger's device locked displaying driver's ride acceptance message</p>

RESTRICTED CONFIDENTIAL SOURCE CODE

Attachment D for US Patent No. 8,213,970 Against Lyft Accused Products

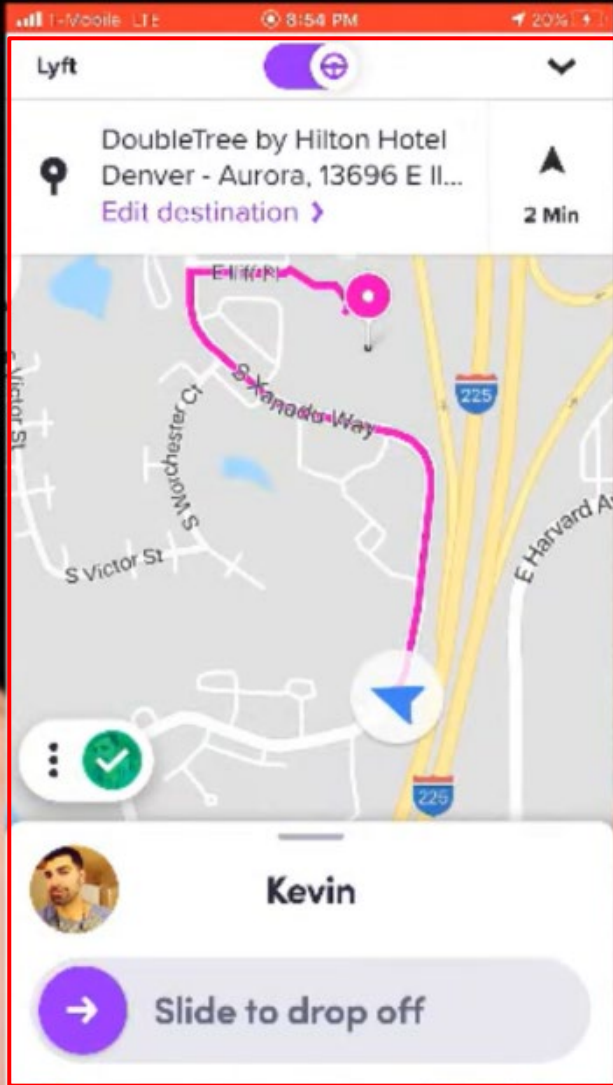
Claim - 8,213,970	Exemplary Supporting Evidence Regarding Accused Products
	 <p data-bbox="1241 565 1507 846">Driver's device after accepting the ride request</p> <p data-bbox="478 1369 1377 1399">https://www.youtube.com/watch?v=b31WorLlcqE at 9:40, Annotated</p>

RESTRICTED CONFIDENTIAL SOURCE CODE

Attachment D for US Patent No. 8,213,970 Against Lyft Accused Products

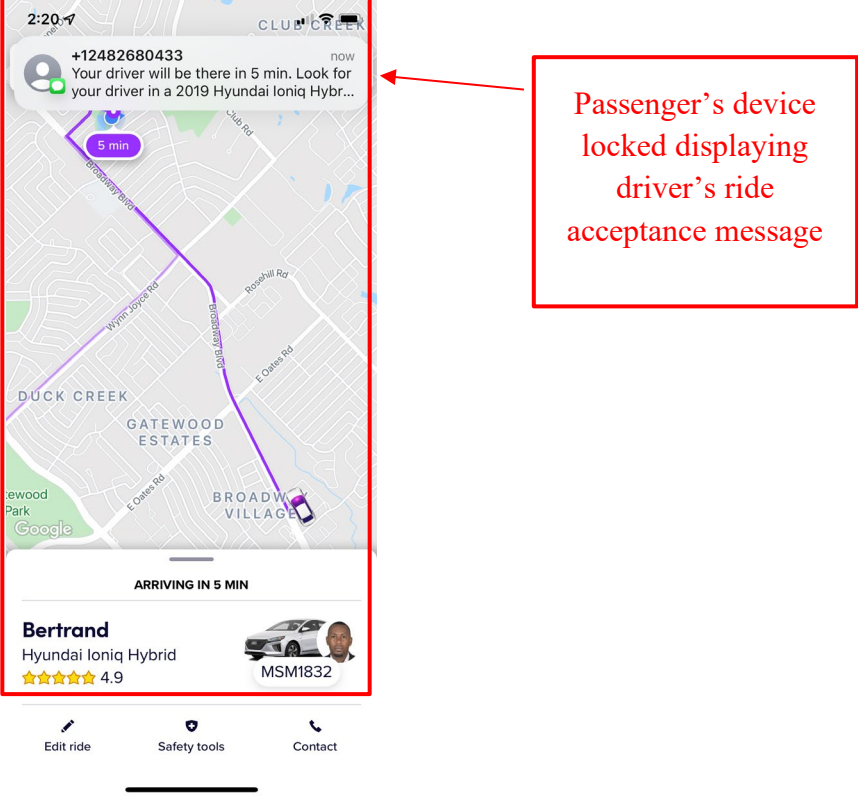
Claim - 8,213,970	Exemplary Supporting Evidence Regarding Accused Products
	 <p>2:20-7 CLU... CREEK</p> <p>+12482680433 now Your driver will be there in 5 min. Look for your driver in a 2019 Hyundai Ioniq Hybr...</p> <p>5 min</p> <p>ARRIVING IN 5 MIN</p> <p>Bertrand Hyundai Ioniq Hybrid ★★★★★ 4.9 MSM1832</p> <p>Edit ride Safety tools Contact</p> <p>Passenger's device locked displaying driver's ride acceptance message</p>
<p>2[C]. means for allowing a manual response to be manually selected from the response list or manually recorded and</p>	<p>The Lyft Accused Products infringe directly and/or indirectly by performing, inducing others to perform, and/or contributing to the performance of: means for allowing a manual response to be manually selected from the response list or manually recorded and transmitting said manual response to the sender PDA/cell phone</p>

RESTRICTED CONFIDENTIAL SOURCE CODE

Attachment D for US Patent No. 8,213,970 Against Lyft Accused Products

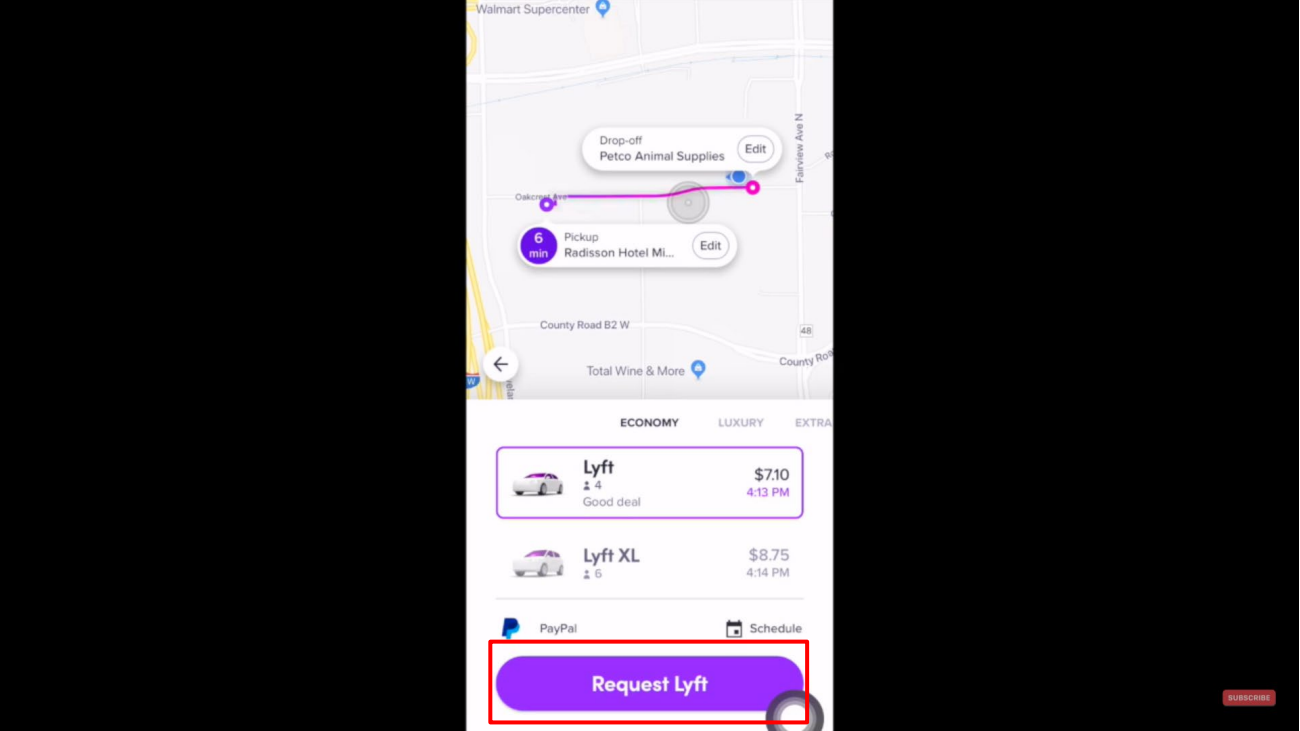
Claim - 8,213,970	Exemplary Supporting Evidence Regarding Accused Products
<p>transmitting said manual response to the sender PDA/cell phone; and</p>	<p>For example, the response list, including but not limited to accept and decline (cross button) in the forced message alert is displayed on the driver's device which is manually selected by the driver. The response from the driver who accepts the ride request is transmitted to the passenger along with the driver's information including but not limited to vehicle model, driver name, location and vehicle number.</p>  <p>https://www.youtube.com/watch?v=j0RDMLcmOgU at 4:01</p>

RESTRICTED CONFIDENTIAL SOURCE CODE

Attachment D for US Patent No. 8,213,970 Against Lyft Accused Products

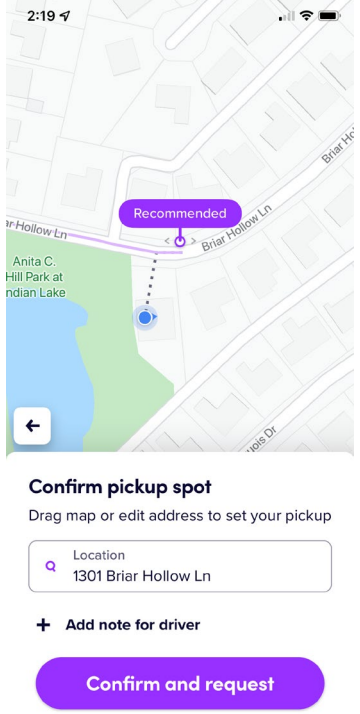
Claim - 8,213,970	Exemplary Supporting Evidence Regarding Accused Products
	 <p>The screenshot displays a mobile application interface for selecting a pickup location. At the top, a map shows a residential area with a purple dot and a purple arrow pointing to it, labeled "Recommended". The address "1301 Briar Hollow Ln" is entered in a search field. Below the map, the text "Confirm pickup spot" is followed by the instruction "Drag map or edit address to set your pickup". The search field contains "Location" and "1301 Briar Hollow Ln". There is a plus sign icon and the text "Add note for driver". At the bottom, a large purple button reads "Confirm and request".</p>

RESTRICTED CONFIDENTIAL SOURCE CODE

Attachment D for US Patent No. 8,213,970 Against Lyft Accused Products

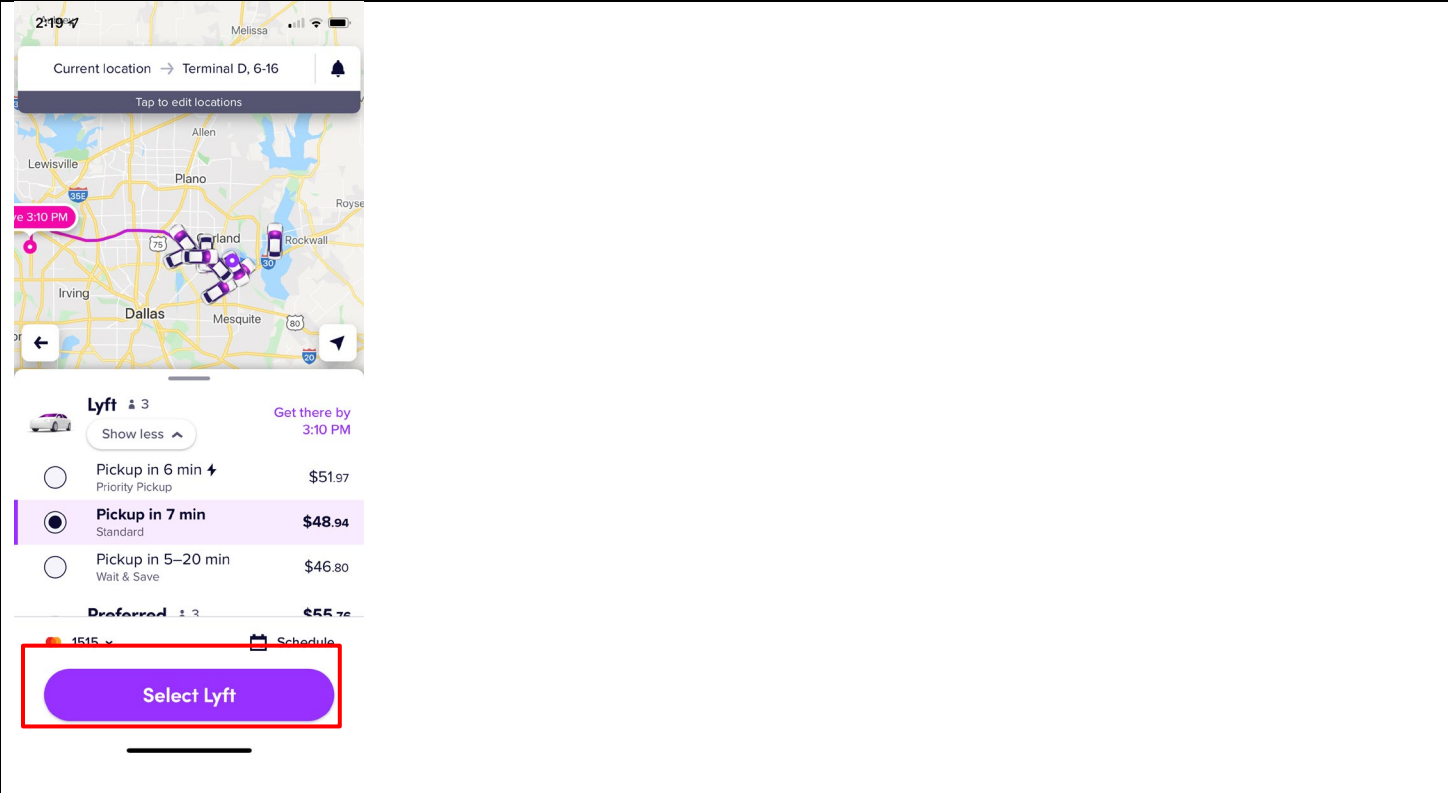
Claim - 8,213,970	Exemplary Supporting Evidence Regarding Accused Products												
	 <p>The screenshot shows the Lyft app interface. At the top, the current location is 'Terminal D, 6-16'. Below the map, there are three Lyft ride options:</p> <table border="1"><thead><tr><th>Option</th><th>Price</th><th>Estimated Time</th></tr></thead><tbody><tr><td>Priority Pickup</td><td>\$51.97</td><td>Pickup in 6 min</td></tr><tr><td>Standard</td><td>\$48.94</td><td>Pickup in 7 min</td></tr><tr><td>Wait & Save</td><td>\$46.80</td><td>Pickup in 5-20 min</td></tr></tbody></table> <p>A red box highlights the 'Select Lyft' button at the bottom of the screen.</p>	Option	Price	Estimated Time	Priority Pickup	\$51.97	Pickup in 6 min	Standard	\$48.94	Pickup in 7 min	Wait & Save	\$46.80	Pickup in 5-20 min
Option	Price	Estimated Time											
Priority Pickup	\$51.97	Pickup in 6 min											
Standard	\$48.94	Pickup in 7 min											
Wait & Save	\$46.80	Pickup in 5-20 min											

RESTRICTED CONFIDENTIAL SOURCE CODE

Attachment D for US Patent No. 8,213,970 Against Lyft Accused Products

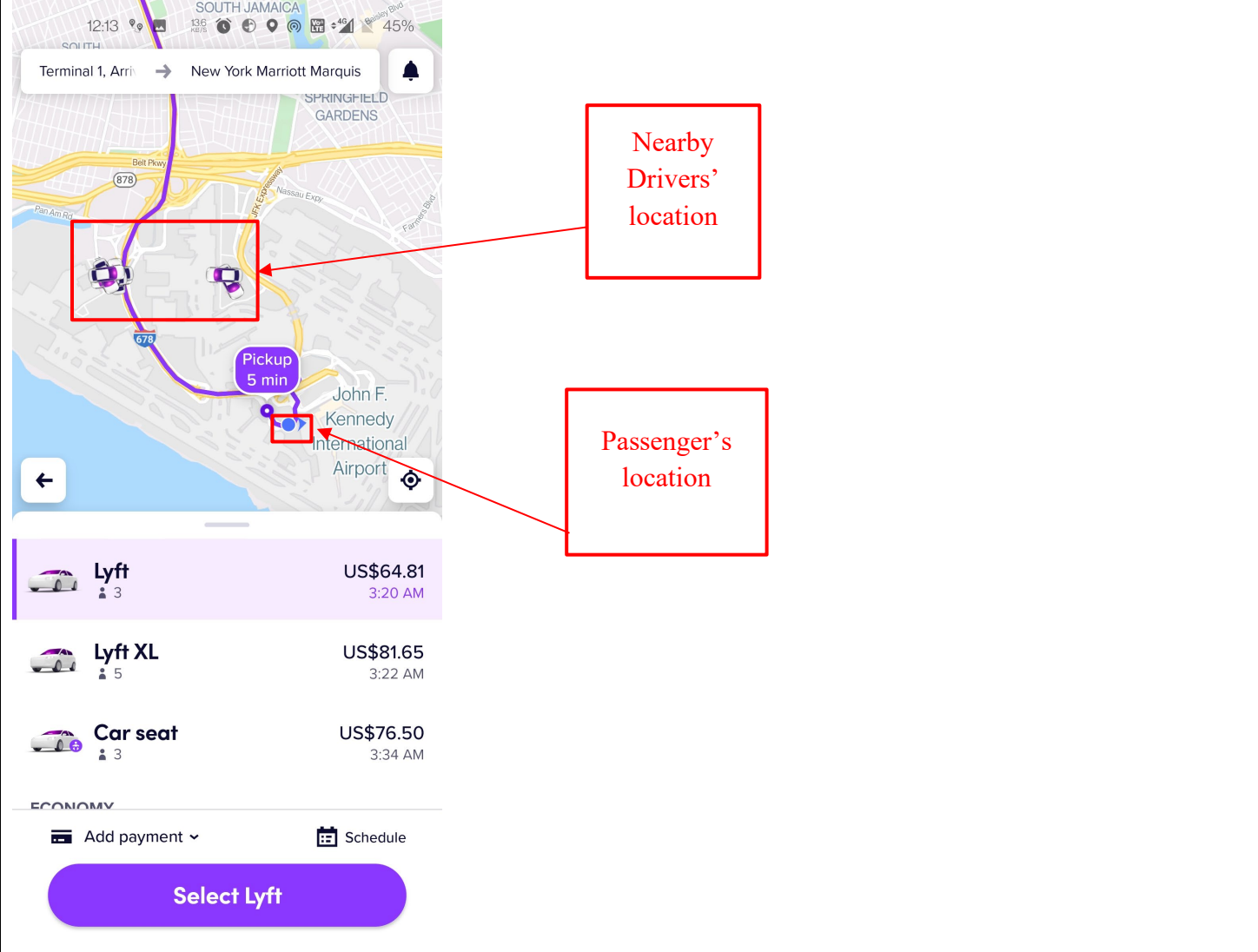
Claim - 8,213,970	Exemplary Supporting Evidence Regarding Accused Products												
	 <p>The screenshot displays the Lyft app interface. At the top, the map shows the route from Terminal 1, Arrivals to New York Marriott Marquis. A red box on the map highlights two driver icons, with a red arrow pointing to a text box labeled "Nearby Drivers' location". Another red box highlights the passenger location icon, with a red arrow pointing to a text box labeled "Passenger's location". Below the map, the ride options are listed:</p> <table border="1"><thead><tr><th>Vehicle Type</th><th>Price</th><th>Time</th></tr></thead><tbody><tr><td>Lyft (3 seats)</td><td>US\$64.81</td><td>3:20 AM</td></tr><tr><td>Lyft XL (5 seats)</td><td>US\$81.65</td><td>3:22 AM</td></tr><tr><td>Car seat (3 seats)</td><td>US\$76.50</td><td>3:34 AM</td></tr></tbody></table> <p>At the bottom, there is a "Select Lyft" button.</p>	Vehicle Type	Price	Time	Lyft (3 seats)	US\$64.81	3:20 AM	Lyft XL (5 seats)	US\$81.65	3:22 AM	Car seat (3 seats)	US\$76.50	3:34 AM
Vehicle Type	Price	Time											
Lyft (3 seats)	US\$64.81	3:20 AM											
Lyft XL (5 seats)	US\$81.65	3:22 AM											
Car seat (3 seats)	US\$76.50	3:34 AM											

RESTRICTED CONFIDENTIAL SOURCE CODE

Attachment D for US Patent No. 8,213,970 Against Lyft Accused Products

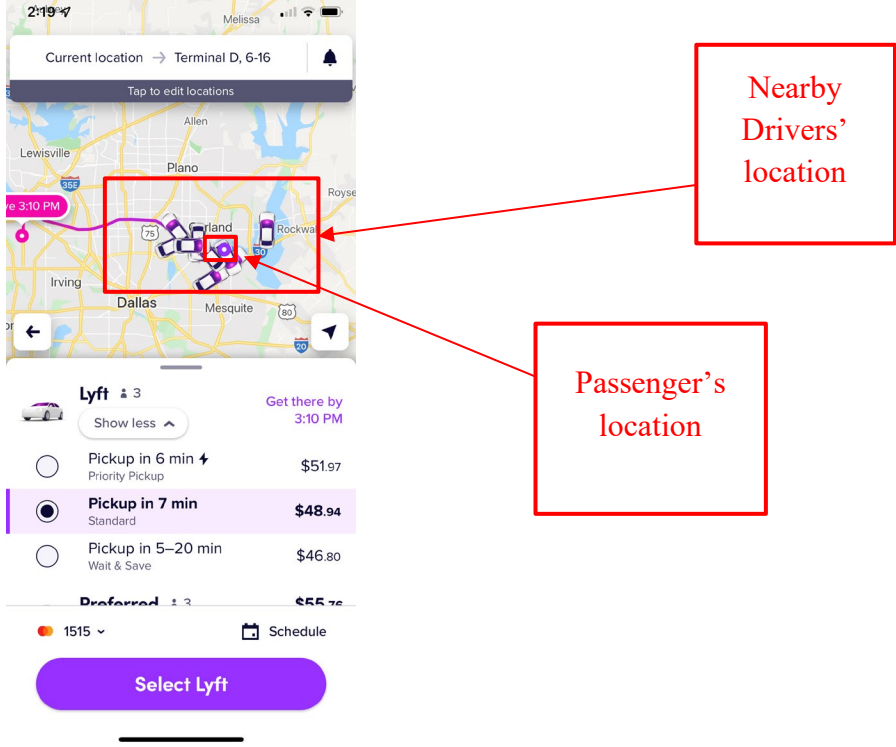
Claim - 8,213,970	Exemplary Supporting Evidence Regarding Accused Products
	 <p>The screenshot displays the Lyft app interface. At the top, the current location is 'Terminal D, 6-16'. The map shows a cluster of driver icons near Rockwall, Texas, highlighted by a red box. A red arrow points from this box to a text box labeled 'Nearby Drivers' location'. Another red box highlights a single passenger icon on the map, with a red arrow pointing to a text box labeled 'Passenger's location'. Below the map, the app shows three Lyft ride options: 'Priority Pickup' for \$51.97 (6 min), 'Standard' for \$48.94 (7 min), and 'Wait & Save' for \$46.80 (5-20 min). A 'Select Lyft' button is at the bottom.</p>

RESTRICTED CONFIDENTIAL SOURCE CODE

Attachment D for US Patent No. 8,213,970 Against Lyft Accused Products

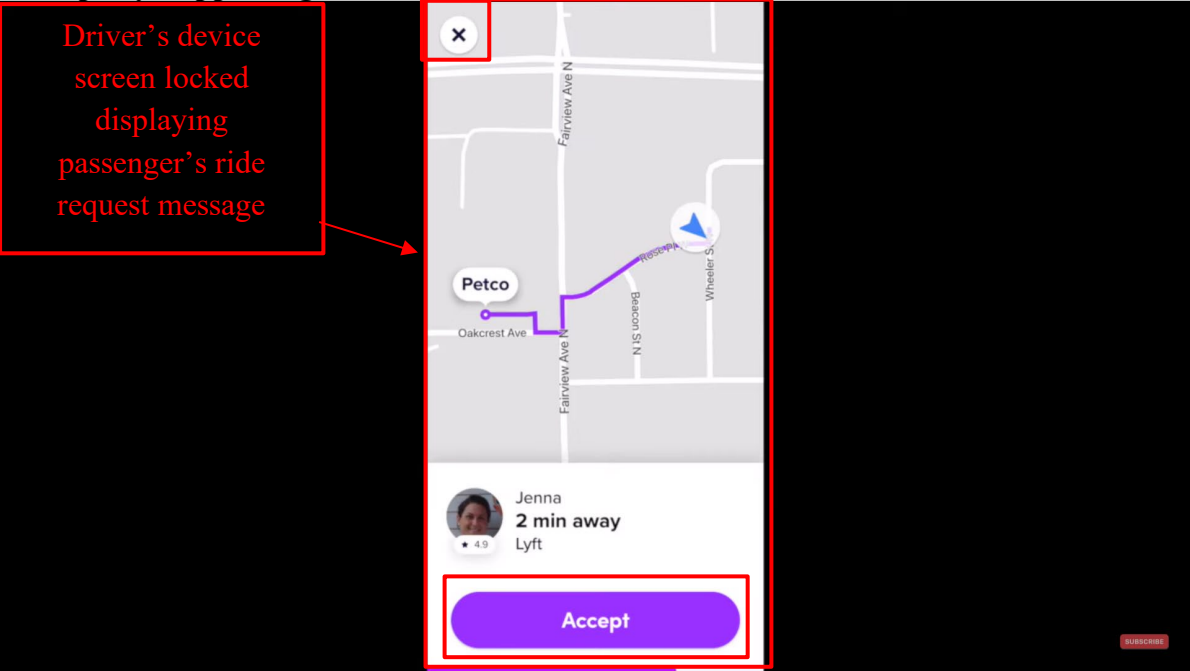
Claim - 8,213,970	Exemplary Supporting Evidence Regarding Accused Products
	<p data-bbox="527 300 743 500">Driver's device screen locked displaying passenger's ride request message</p>  <p data-bbox="478 954 1396 982">https://www.youtube.com/watch?v=jVUy9poJDng at 10:24, Annotated</p>

RESTRICTED CONFIDENTIAL SOURCE CODE

Attachment D for US Patent No. 8,213,970 Against Lyft Accused Products

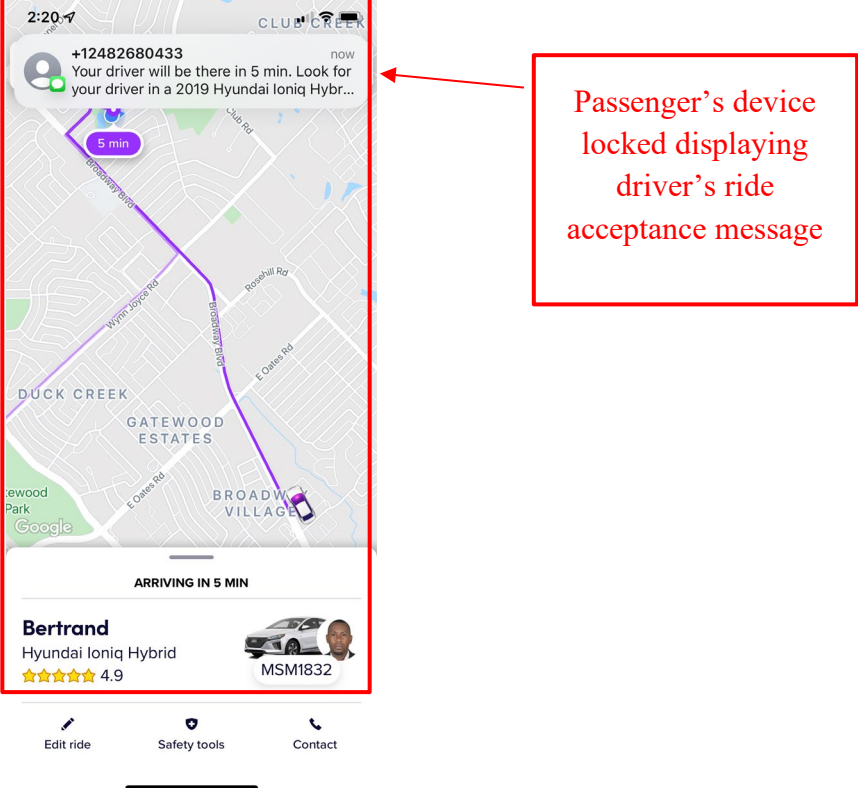
Claim - 8,213,970	Exemplary Supporting Evidence Regarding Accused Products
	 <p data-bbox="1003 342 1325 591">Passenger's device locked displaying driver's ride acceptance message</p>

RESTRICTED CONFIDENTIAL SOURCE CODE

Attachment D for US Patent No. 8,213,970 Against Lyft Accused Products

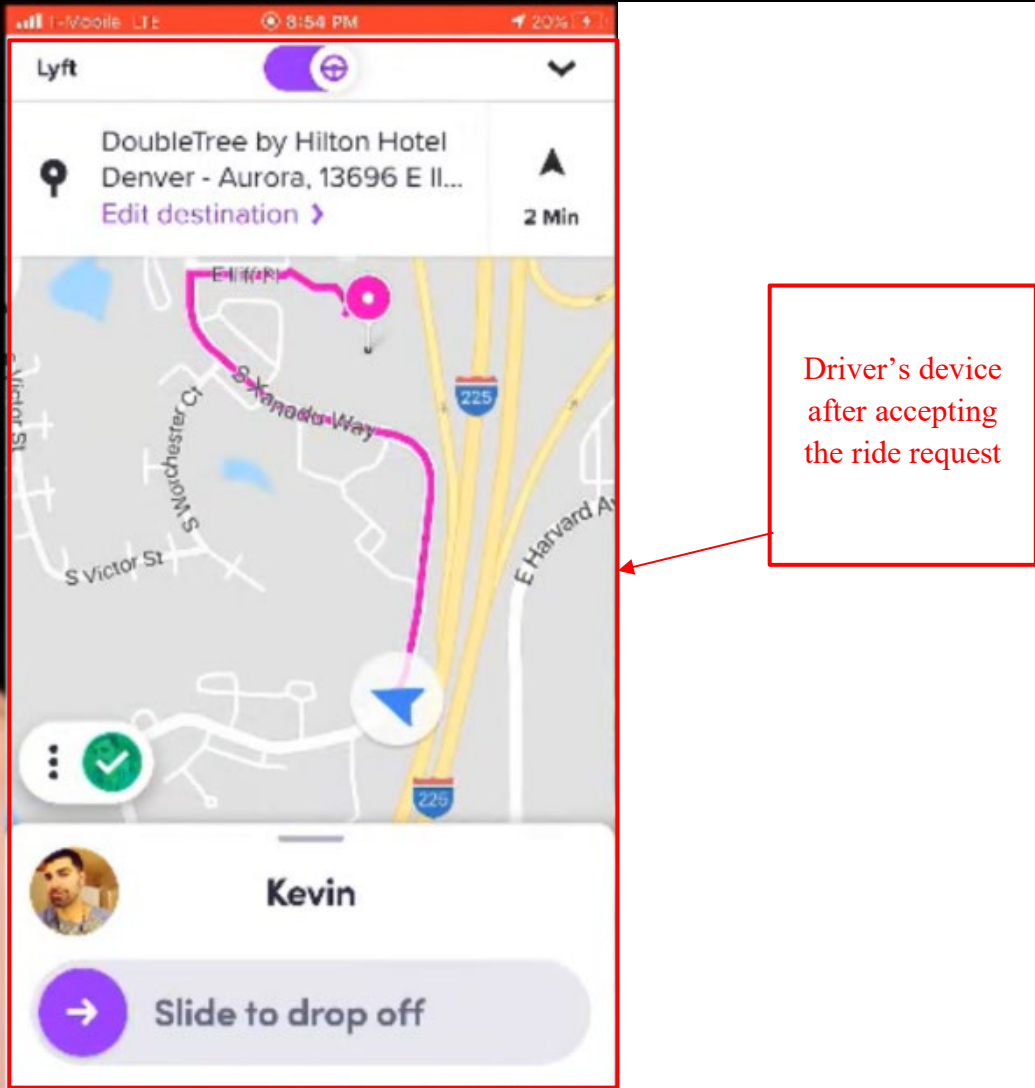
Claim - 8,213,970	Exemplary Supporting Evidence Regarding Accused Products
	 <p>https://www.youtube.com/watch?v=b31WorLlcqE at 9:40, Annotated</p>

RESTRICTED CONFIDENTIAL SOURCE CODE

Attachment D for US Patent No. 8,213,970 Against Lyft Accused Products

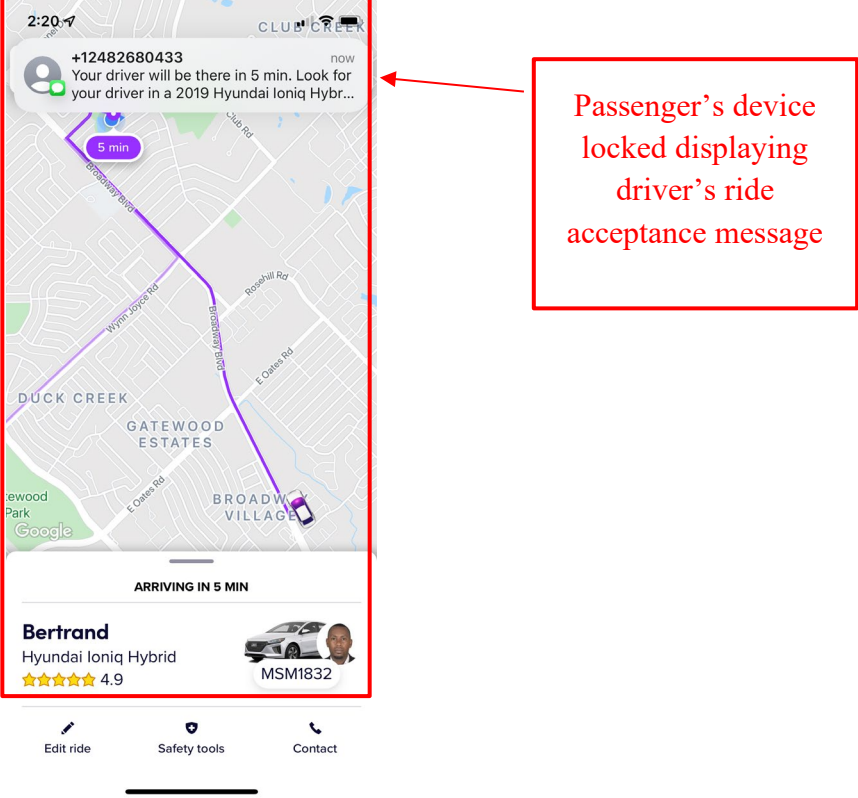
Claim - 8,213,970	Exemplary Supporting Evidence Regarding Accused Products
	 <p>2:20-7 CLU... CREEK</p> <p>+12482680433 now Your driver will be there in 5 min. Look for your driver in a 2019 Hyundai Ioniq Hybr...</p> <p>5 min</p> <p>BRADWAY BLVD WYNN LOYCE RD ROSEHILL RD E OWENS RD DUCK CREEK GATEWOOD ESTATES BROADWAY VILLAGE</p> <p>ARRIVING IN 5 MIN</p> <p>Bertrand Hyundai Ioniq Hybrid ★★★★★ 4.9 MSM1832</p> <p>Edit ride Safety tools Contact</p> <p>Passenger's device locked displaying driver's ride acceptance message</p>

RESTRICTED CONFIDENTIAL SOURCE CODE

Attachment D for US Patent No. 8,213,970 Against Lyft Accused Products

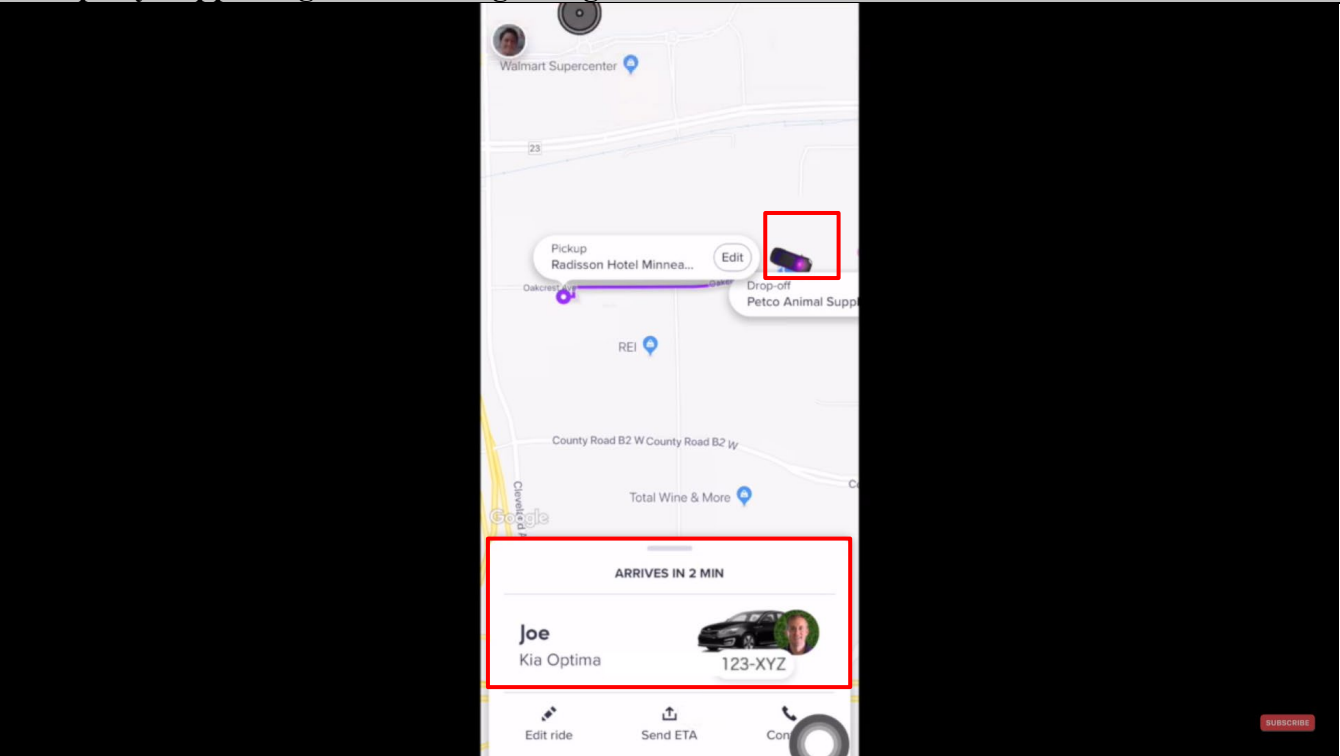
Claim - 8,213,970	Exemplary Supporting Evidence Regarding Accused Products
	 <p>https://www.youtube.com/watch?v=j0RDMLcmOgU at 5:07</p>

RESTRICTED CONFIDENTIAL SOURCE CODE

Attachment D for US Patent No. 8,213,970 Against Lyft Accused Products

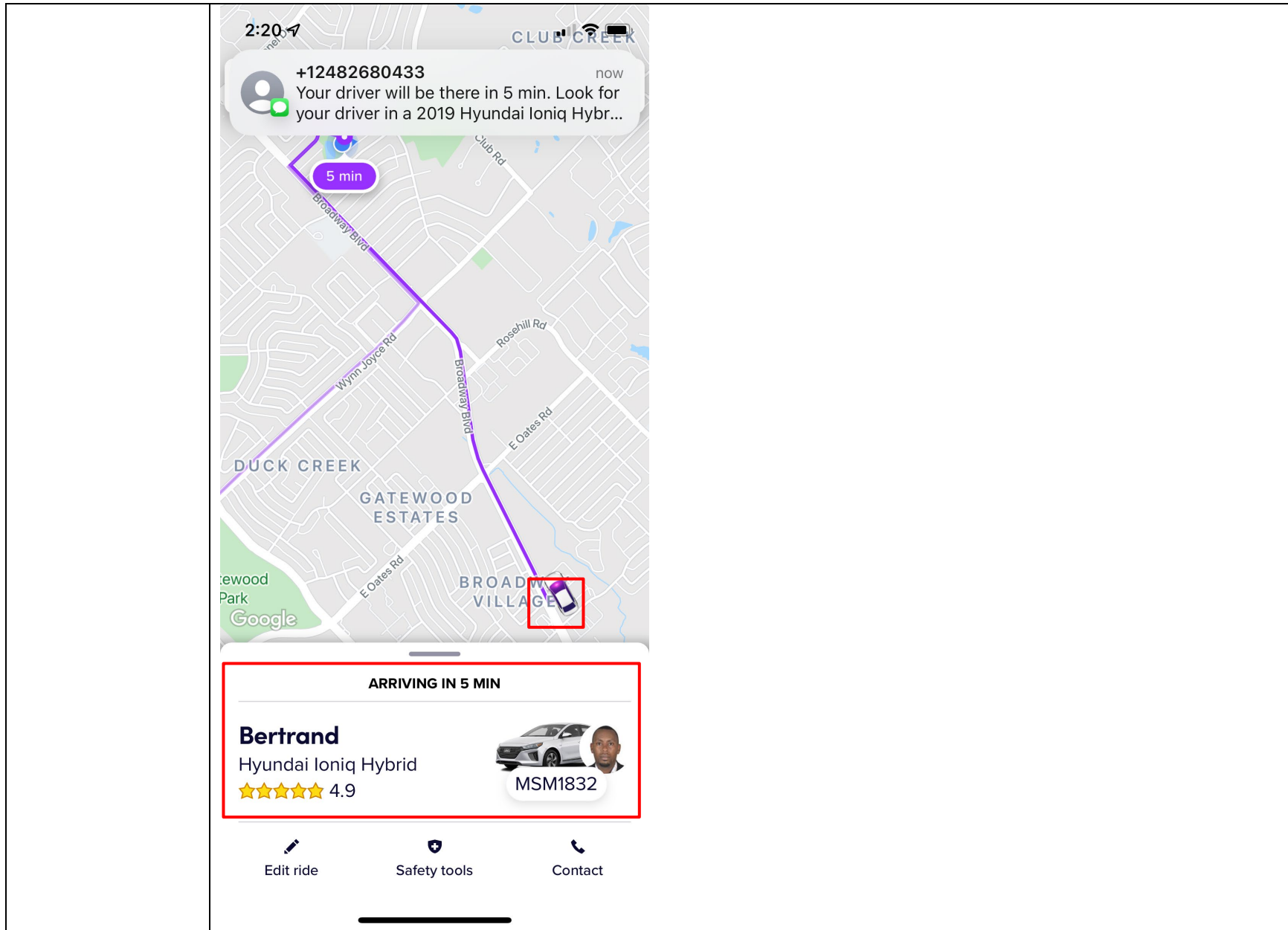

RESTRICTED CONFIDENTIAL SOURCE CODE**Attachment D for US Patent No. 8,213,970 Against Lyft Accused Products**

Claim - 8,213,970	Exemplary Supporting Evidence Regarding Accused Products
	See Claim 1[E] above.
<p>2[D]. means for clearing the text message and a response list from the display of the recipient PDA/cell phone or stopping the repeating voice message and clearing the response list from the display of the recipient PDA/cell phone once the manual response is transmitted.</p>	<p>The Lyft Accused Products infringe directly and/or indirectly by performing, inducing others to perform, and/or contributing to the performance of: means for clearing the text message and a response list from the display of the recipient PDA/cell phone or stopping the repeating voice message and clearing the response list from the display of the recipient PDA/cell phone once the manual response is transmitted.</p> <p>For example, the Lyft Driver app receives an electronically transmitted request for a ride from a passenger which triggers a forced message alert that locks the driver's device ("controlling of the recipient PDA/cell phone") for a period of time until the driver ("recipient") sends a response message (decline (cross button) or accept) to clear the locked display.</p>

RESTRICTED CONFIDENTIAL SOURCE CODE

Attachment D for US Patent No. 8,213,970 Against Lyft Accused Products

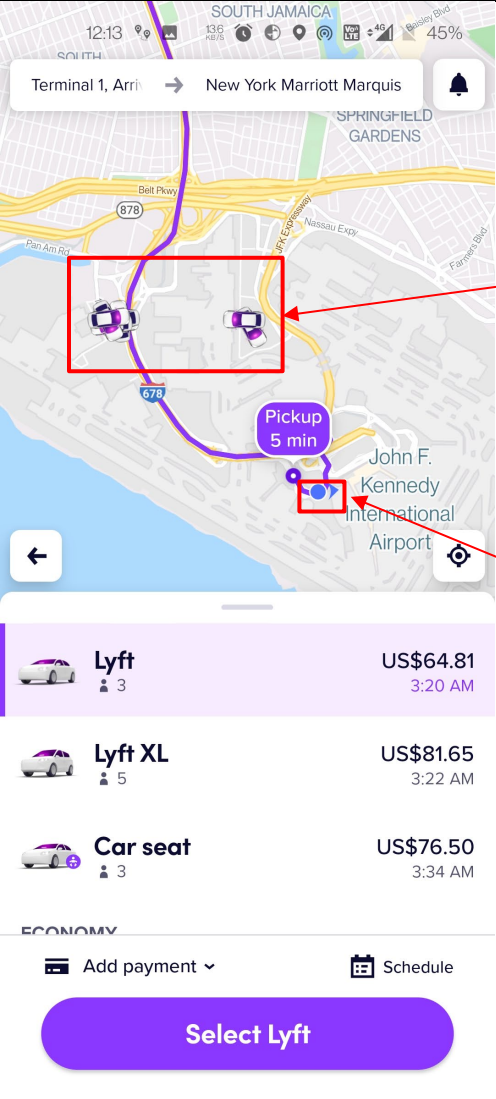
Claim - 8,213,970	Exemplary Supporting Evidence Regarding Accused Products												
	 <p>The screenshot displays the Lyft app interface. At the top, the map shows the route from Terminal 1, Arrivals to New York Marriott Marquis. A red box highlights two driver icons on the map, with a red arrow pointing to a text box labeled "Nearby Drivers' location". Another red box highlights the pickup location at John F. Kennedy International Airport, with a red arrow pointing to a text box labeled "Passenger's location". Below the map, a list of ride options is shown:</p> <table border="1"><thead><tr><th>Vehicle Type</th><th>Price</th><th>Time</th></tr></thead><tbody><tr><td>Lyft (3 seats)</td><td>US\$64.81</td><td>3:20 AM</td></tr><tr><td>Lyft XL (5 seats)</td><td>US\$81.65</td><td>3:22 AM</td></tr><tr><td>Car seat (3 seats)</td><td>US\$76.50</td><td>3:34 AM</td></tr></tbody></table> <p>At the bottom, there are options for "Add payment" and "Schedule", and a large purple button labeled "Select Lyft".</p>	Vehicle Type	Price	Time	Lyft (3 seats)	US\$64.81	3:20 AM	Lyft XL (5 seats)	US\$81.65	3:22 AM	Car seat (3 seats)	US\$76.50	3:34 AM
Vehicle Type	Price	Time											
Lyft (3 seats)	US\$64.81	3:20 AM											
Lyft XL (5 seats)	US\$81.65	3:22 AM											
Car seat (3 seats)	US\$76.50	3:34 AM											

RESTRICTED CONFIDENTIAL SOURCE CODE

Attachment D for US Patent No. 8,213,970 Against Lyft Accused Products

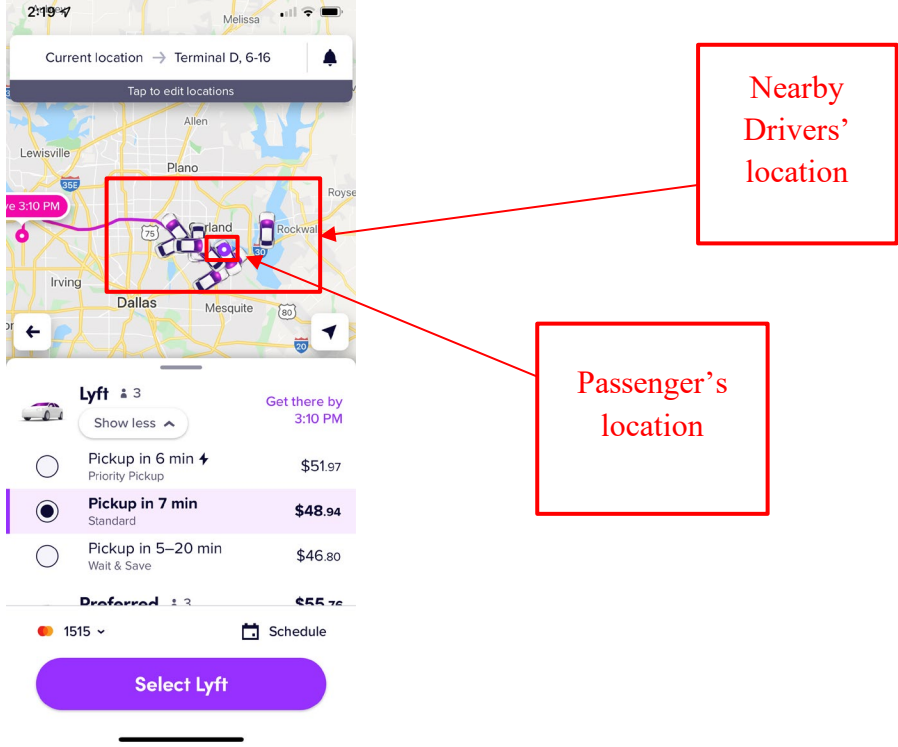
Claim - 8,213,970	Exemplary Supporting Evidence Regarding Accused Products
	 <p>The screenshot displays the Lyft app interface. At the top, the current location is 'Terminal D, 6-16'. Below the map, there are three ride options: 'Priority Pickup' (6 min, \$51.97), 'Standard' (7 min, \$48.94), and 'Wait & Save' (5-20 min, \$46.80). A 'Select Lyft' button is at the bottom. A red box on the map highlights a cluster of driver icons near the passenger's location. Two red callout boxes with arrows point to this area: one labeled 'Nearby Drivers' location' and another labeled 'Passenger's location'.</p>

RESTRICTED CONFIDENTIAL SOURCE CODE

Attachment D for US Patent No. 8,213,970 Against Lyft Accused Products

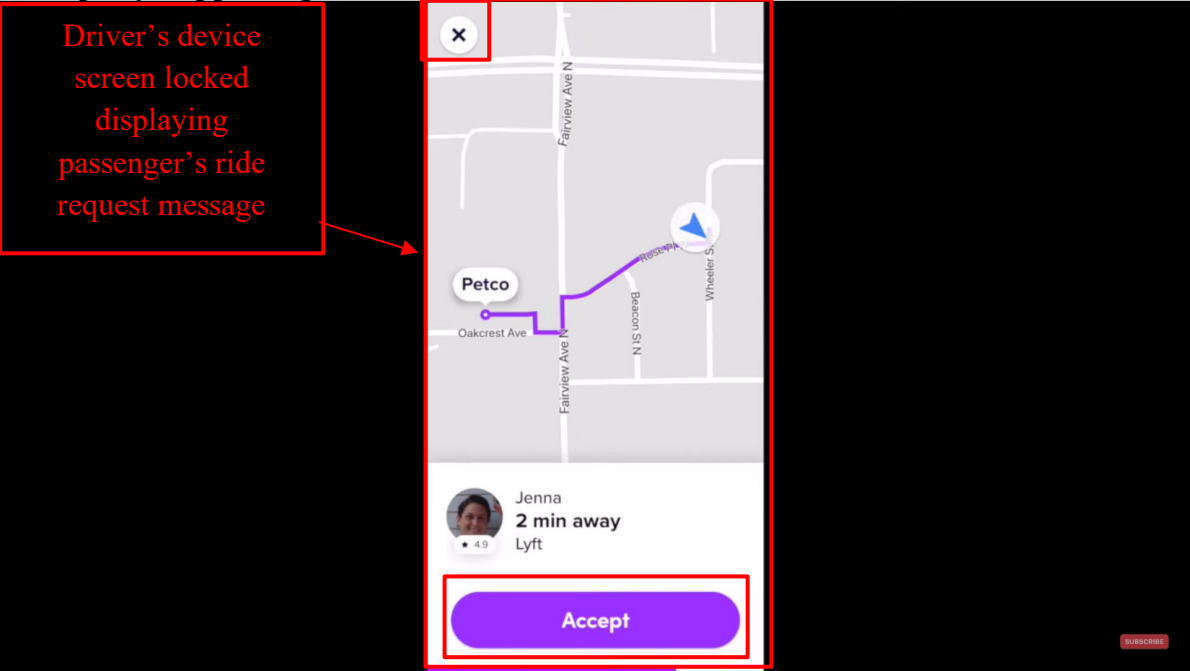
Claim - 8,213,970	Exemplary Supporting Evidence Regarding Accused Products
	<p data-bbox="527 302 743 500">Driver's device screen locked displaying passenger's ride request message</p>  <p data-bbox="478 954 1398 982">https://www.youtube.com/watch?v=jVUy9poJDng at 10:24, Annotated</p>

RESTRICTED CONFIDENTIAL SOURCE CODE

Attachment D for US Patent No. 8,213,970 Against Lyft Accused Products

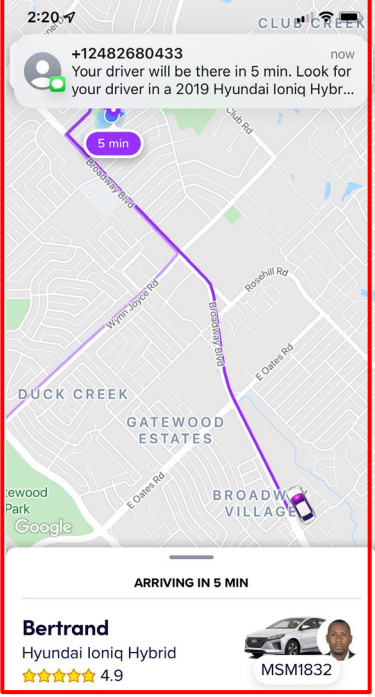
Claim - 8,213,970	Exemplary Supporting Evidence Regarding Accused Products
	 <p data-bbox="1003 342 1325 592">Passenger's device locked displaying driver's ride acceptance message</p>

RESTRICTED CONFIDENTIAL SOURCE CODE

Attachment D for US Patent No. 8,213,970 Against Lyft Accused Products

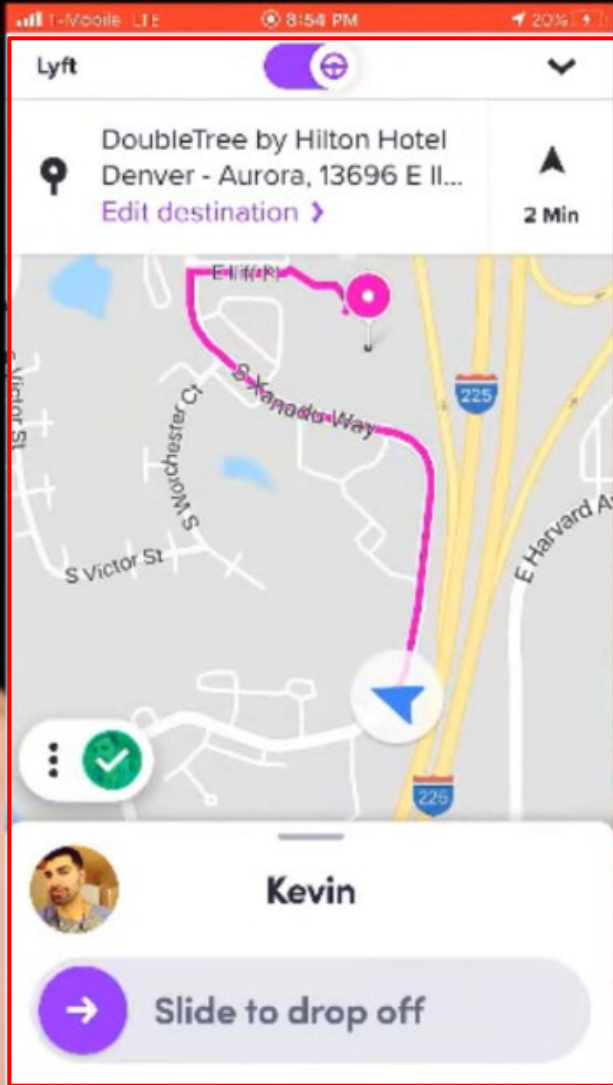
Claim - 8,213,970	Exemplary Supporting Evidence Regarding Accused Products
	 <p data-bbox="1241 565 1623 914">Driver's device screen locked displaying passenger's ride request message is removed after driver chooses the response (here accept response)</p> <p data-bbox="478 1369 1377 1399">https://www.youtube.com/watch?v=b31WorLlcqE at 9:40, Annotated</p>

RESTRICTED CONFIDENTIAL SOURCE CODE**Attachment D for US Patent No. 8,213,970 Against Lyft Accused Products**

Claim - 8,213,970	Exemplary Supporting Evidence Regarding Accused Products
	See Claim 1[E] above.
<p>10[P]. A method of receiving, acknowledging and responding to a forced message alert from a sender PDA/cell phone to a recipient PDA/cell phone, wherein the receipt, acknowledgment, and response to said forced message alert is forced by a forced message alert software application program, said method comprising the steps of:</p>	<p>The Lyft Accused Products performs a computer implemented method as set forth below. Lyft further infringe directly and/or indirectly by performing, inducing others to perform, and/or contributing to the performance of: a method of receiving, acknowledging and responding to a forced message alert from a sender PDA/cell phone to a recipient PDA/cell phone, wherein the receipt, acknowledgment, and response to said forced message alert is forced by a forced message alert software application program.</p> <p>For example, Lyft provides Lyft app for passengers and Lyft Driver app for drivers. The Lyft apps for riders and drivers, in conjunction with Lyft's servers and services, provide users with interactive methods to request, view, and track locations of passengers/riders using real-time maps and communications. The Lyft server(s) and their services communicate with the Lyft apps for riders and drivers. The Lyft server(s) and their services host information related to and instructions for processing user/device/vehicle accounts, location data, and map data. The claimed methods are distributed by Lyft in the Lyft apps. The claimed methods are used/tested by Lyft using the Lyft apps. The claimed methods are downloaded and installed by Lyft's customers (riders) and personnel (drivers, personnel) at the direction/encouragement of Lyft and used by Lyft's customers and Lyft's personnel.</p> <p>A passenger ("sender") requests a ride which is transmitted to the nearby drivers. The Lyft Driver application receives an electronically transmitted request for a ride which triggers a forced message alert that locks the device for a period of time until the driver ("recipient") sends a response message (decline or accept) to clear the locked display ("receiving, acknowledging and responding to a forced message alert").</p>

RESTRICTED CONFIDENTIAL SOURCE CODE

Attachment D for US Patent No. 8,213,970 Against Lyft Accused Products

Claim - 8,213,970	Exemplary Supporting Evidence Regarding Accused Products
	<h2 data-bbox="489 293 982 370">Lyft Driver app</h2> <div data-bbox="489 407 1719 492" style="border: 1px solid red; padding: 5px;"><p data-bbox="489 407 1719 480">We've separated the passenger and driver experiences into two separate mobile apps — one exclusively for passengers (named the Lyft app) and the other exclusively for drivers (named the Lyft Driver app).</p></div> <p data-bbox="489 513 1751 610">The Lyft Driver app will eventually be standard for all drivers and required for driving. At this time, drivers can keep using the Lyft app to give rides. Don't worry! While we have some planned improvements to the Lyft Driver app, we've kept its features the same.</p> <p data-bbox="489 643 1377 675">https://help.lyft.com/hc/en-ca/articles/115013079208-Lyft-Driver-app</p> <h3 data-bbox="489 727 793 776">What is Lyft?</h3> <p data-bbox="489 829 1562 894">Lyft is a platform that connects drivers with individuals and organizations that need rides.</p> <p data-bbox="489 927 957 959">https://www.lyft.com/drive-with-lyft</p>

RESTRICTED CONFIDENTIAL SOURCE CODE

Attachment D for US Patent No. 8,213,970 Against Lyft Accused Products

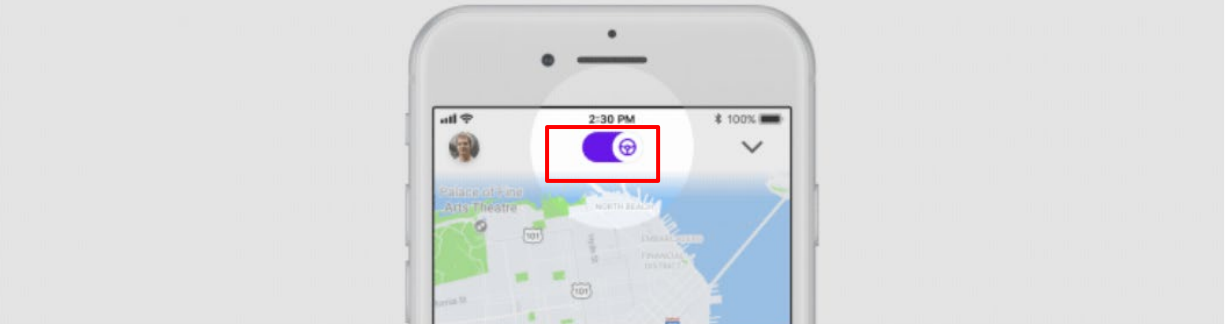
Claim - 8,213,970	Exemplary Supporting Evidence Regarding Accused Products
	 <p>Go online</p> <p>Open your Lyft Driver app and tap the steering wheel icon. Lyft will now find the closest passenger to your location requesting a ride. Turn on some music and get comfortable: that first ride request may come quickly or may take a while, depending on the number of current passenger requests.</p> <p>https://www.lyft.com/hub/posts/how-to-give-a-ride</p>

RESTRICTED CONFIDENTIAL SOURCE CODE

Attachment D for US Patent No. 8,213,970 Against Lyft Accused Products

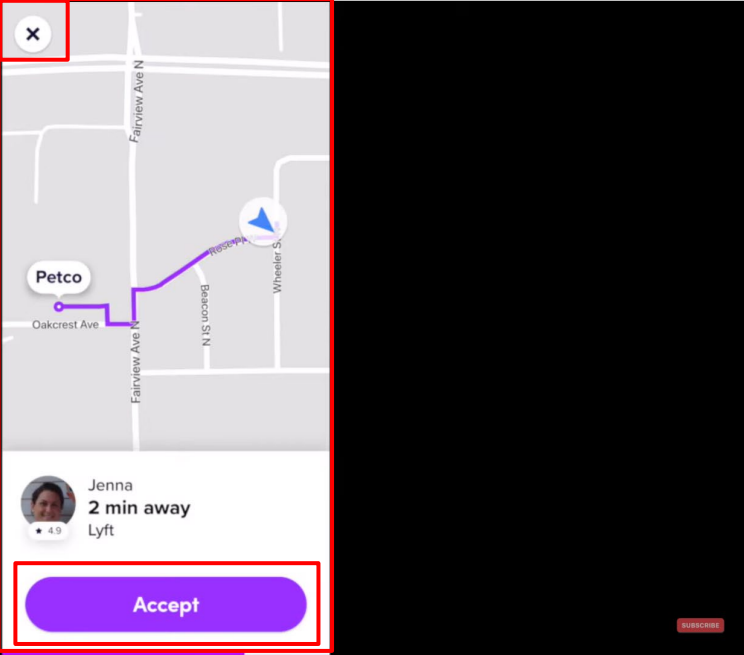
Claim - 8,213,970	Exemplary Supporting Evidence Regarding Accused Products
	<p data-bbox="520 302 751 505">Driver's device screen locked displaying passenger's ride request messages</p>  <p data-bbox="478 935 1398 969">https://www.youtube.com/watch?v=jVUy9poJDng at 10:24, Annotated</p>

RESTRICTED CONFIDENTIAL SOURCE CODE

Attachment D for US Patent No. 8,213,970 Against Lyft Accused Products

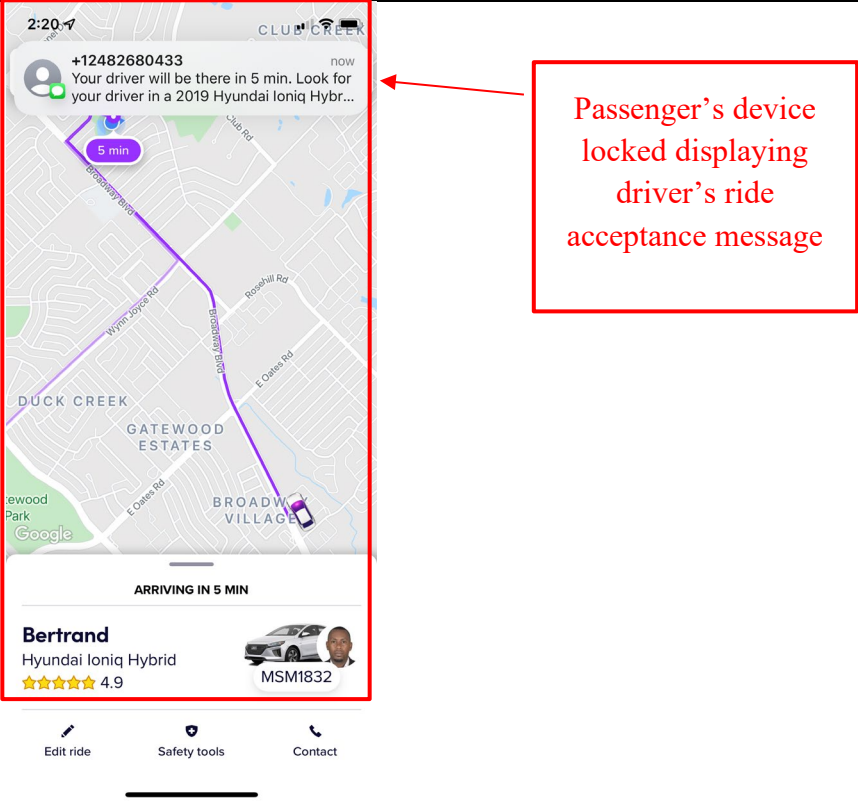
Claim - 8,213,970	Exemplary Supporting Evidence Regarding Accused Products
	 <p data-bbox="1003 342 1325 592">Passenger's device locked displaying driver's ride acceptance message</p>

RESTRICTED CONFIDENTIAL SOURCE CODE

Attachment D for US Patent No. 8,213,970 Against Lyft Accused Products

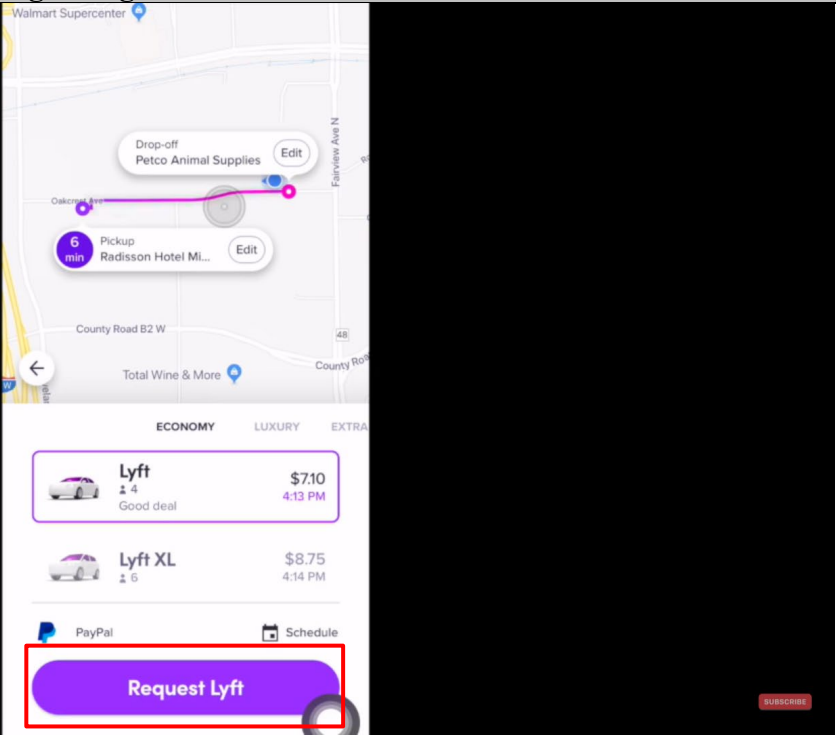
Claim - 8,213,970	Exemplary Supporting Evidence Regarding Accused Products
	 <p>The screenshot displays the Lyft app interface. At the top, a map shows the route from the pickup location, Radisson Hotel ML... (6 min), to the drop-off location, Petco Animal Supplies. Below the map, the app shows two ride options: Lyft (4 seats, \$7.10, 4:13 PM) and Lyft XL (6 seats, \$8.75, 4:14 PM). The Lyft option is marked as a 'Good deal'. At the bottom, there are icons for PayPal and Schedule, and a prominent purple 'Request Lyft' button which is highlighted with a red rectangular box.</p> <p>https://www.youtube.com/watch?v=j0RDMLcmOgU at 4:01</p>

RESTRICTED CONFIDENTIAL SOURCE CODE

Attachment D for US Patent No. 8,213,970 Against Lyft Accused Products

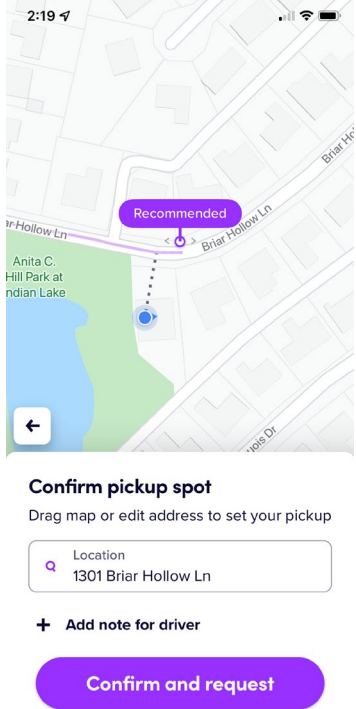
Claim - 8,213,970	Exemplary Supporting Evidence Regarding Accused Products
	 <p>The screenshot displays a mobile application interface for selecting a pickup location. At the top, a map shows a residential area with a purple dot indicating a 'Recommended' pickup spot at 1301 Briar Hollow Ln. Below the map, the text 'Confirm pickup spot' is followed by the instruction 'Drag map or edit address to set your pickup'. A search bar contains the text 'Location 1301 Briar Hollow Ln'. Below the search bar, there is a plus sign icon and the text '+ Add note for driver'. At the bottom, a large purple button is labeled 'Confirm and request'.</p>

RESTRICTED CONFIDENTIAL SOURCE CODE

Attachment D for US Patent No. 8,213,970 Against Lyft Accused Products

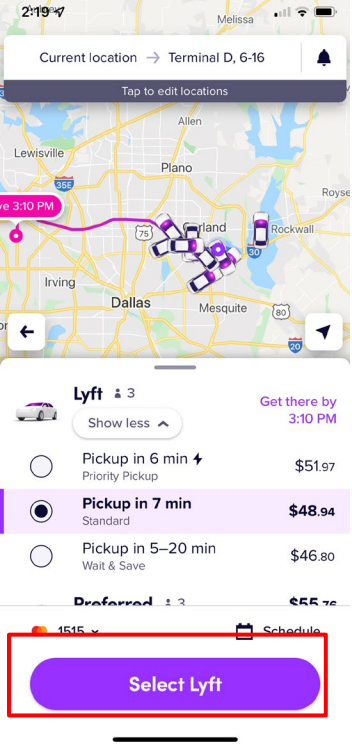
Claim - 8,213,970	Exemplary Supporting Evidence Regarding Accused Products
	 <p>The screenshot shows the Lyft app interface. At the top, the current location is 'Terminal D, 6-16'. Below the map, there are three pickup options listed:</p> <ul style="list-style-type: none"> Priority Pickup: Pickup in 6 min, \$51.97 Standard: Pickup in 7 min, \$48.94 (This option is selected) Wait & Save: Pickup in 5-20 min, \$46.80 <p>At the bottom of the screen, a purple button labeled 'Select Lyft' is highlighted with a red rectangular box.</p>
<p>10[A] receiving an electronically transmitted electronic message; identifying said electronic message as a forced message alert,</p>	<p>The Lyft Accused Products infringe directly and/or indirectly by performing, inducing others to perform, and/or contributing to the performance of: receiving an electronically transmitted electronic message; identifying said electronic message as a forced message alert, wherein said forced message alert comprises of a voice or text message and a forced message alert application software packet, which triggers the activation of the forced message alert software application program within the recipient PDA/cell phone.</p>

RESTRICTED CONFIDENTIAL SOURCE CODE

Attachment D for US Patent No. 8,213,970 Against Lyft Accused Products

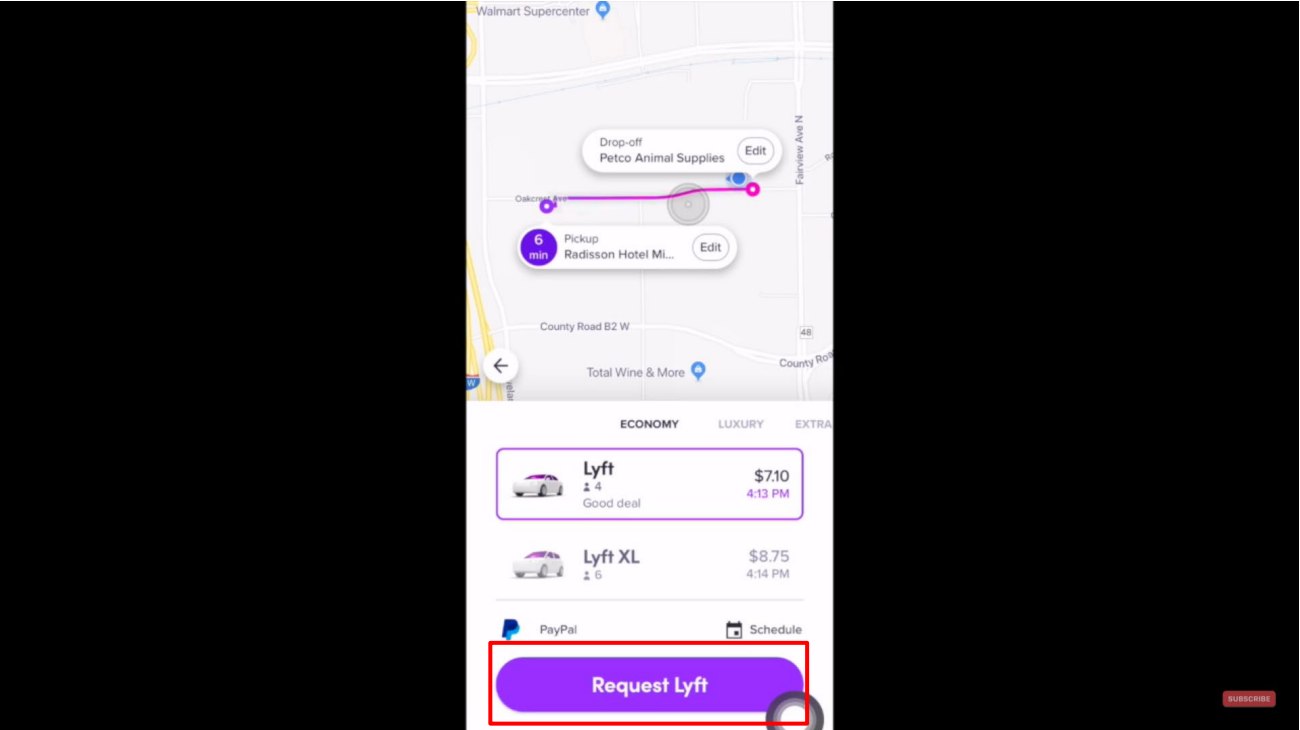
Claim - 8,213,970	Exemplary Supporting Evidence Regarding Accused Products
<p>wherein said forced message alert comprises of a voice or text message and a forced message alert application software packet, which triggers the activation of the forced message alert software application program within the recipient PDA/cell phone;</p>	<p>For example, the Lyft Driver application receives an electronically transmitted request for a ride from a passenger which triggers a forced message alert that locks the driver’s device for a period of time until the driver (“recipient”) sends a response message (decline or accept) to clear the locked display.</p>  <p>https://www.youtube.com/watch?v=j0RDMLcmOgU at 4:01</p>

RESTRICTED CONFIDENTIAL SOURCE CODE

Attachment D for US Patent No. 8,213,970 Against Lyft Accused Products

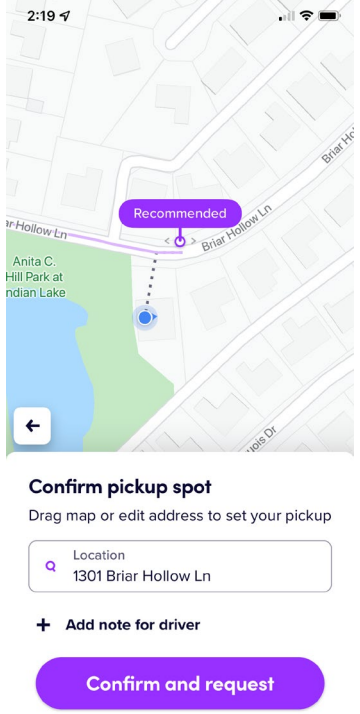
Claim - 8,213,970	Exemplary Supporting Evidence Regarding Accused Products
	 <p>The screenshot displays a mobile application interface for selecting a pickup location. At the top, a map shows a residential area with a purple dot indicating a 'Recommended' pickup spot at 1301 Briar Hollow Ln. Below the map, the text 'Confirm pickup spot' is followed by the instruction 'Drag map or edit address to set your pickup'. A search bar contains the text 'Location 1301 Briar Hollow Ln'. Below the search bar, there is a plus sign icon and the text '+ Add note for driver'. At the bottom, a large purple button is labeled 'Confirm and request'.</p>

RESTRICTED CONFIDENTIAL SOURCE CODE

Attachment D for US Patent No. 8,213,970 Against Lyft Accused Products

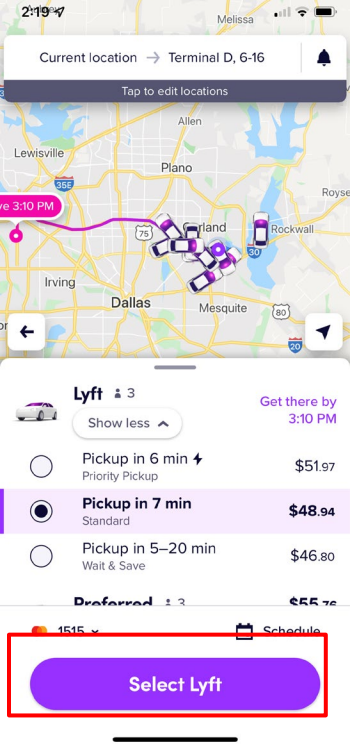
Claim - 8,213,970	Exemplary Supporting Evidence Regarding Accused Products												
	 <p>The screenshot shows the Lyft app interface for a ride request. The current location is Terminal D, 6-16. The destination is not explicitly named but is located in the Dallas area. The app displays three Lyft options:</p> <table border="1"><thead><tr><th>Option</th><th>Estimated Time</th><th>Price</th></tr></thead><tbody><tr><td>Priority Pickup</td><td>Pickup in 6 min</td><td>\$51.97</td></tr><tr><td>Standard</td><td>Pickup in 7 min</td><td>\$48.94</td></tr><tr><td>Wait & Save</td><td>Pickup in 5-20 min</td><td>\$46.80</td></tr></tbody></table> <p>A red box highlights the "Select Lyft" button at the bottom of the screen.</p>	Option	Estimated Time	Price	Priority Pickup	Pickup in 6 min	\$51.97	Standard	Pickup in 7 min	\$48.94	Wait & Save	Pickup in 5-20 min	\$46.80
Option	Estimated Time	Price											
Priority Pickup	Pickup in 6 min	\$51.97											
Standard	Pickup in 7 min	\$48.94											
Wait & Save	Pickup in 5-20 min	\$46.80											

RESTRICTED CONFIDENTIAL SOURCE CODE

Attachment D for US Patent No. 8,213,970 Against Lyft Accused Products

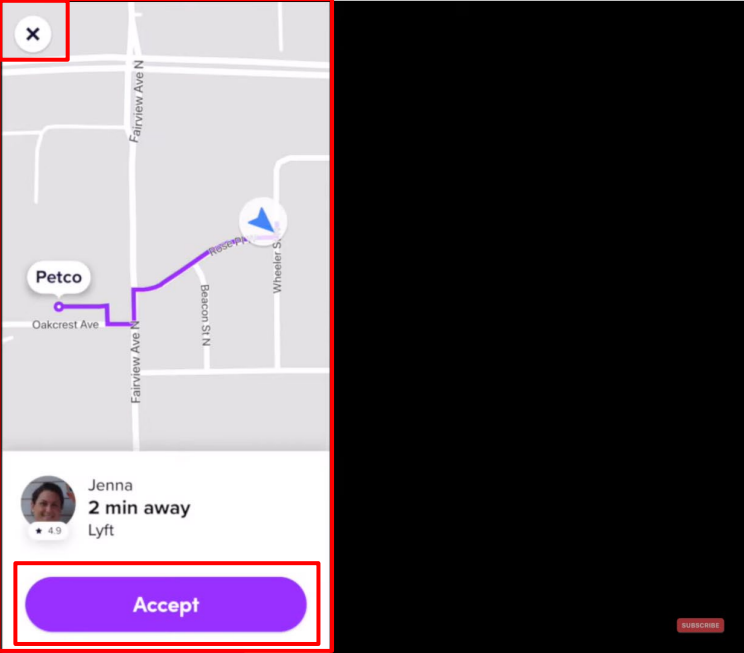
Claim - 8,213,970	Exemplary Supporting Evidence Regarding Accused Products
	<p data-bbox="520 302 751 505">Driver's device screen locked displaying passenger's ride request messages</p>  <p data-bbox="478 935 1398 969">https://www.youtube.com/watch?v=jVUy9poJDng at 10:24, Annotated</p>

RESTRICTED CONFIDENTIAL SOURCE CODE

Attachment D for US Patent No. 8,213,970 Against Lyft Accused Products

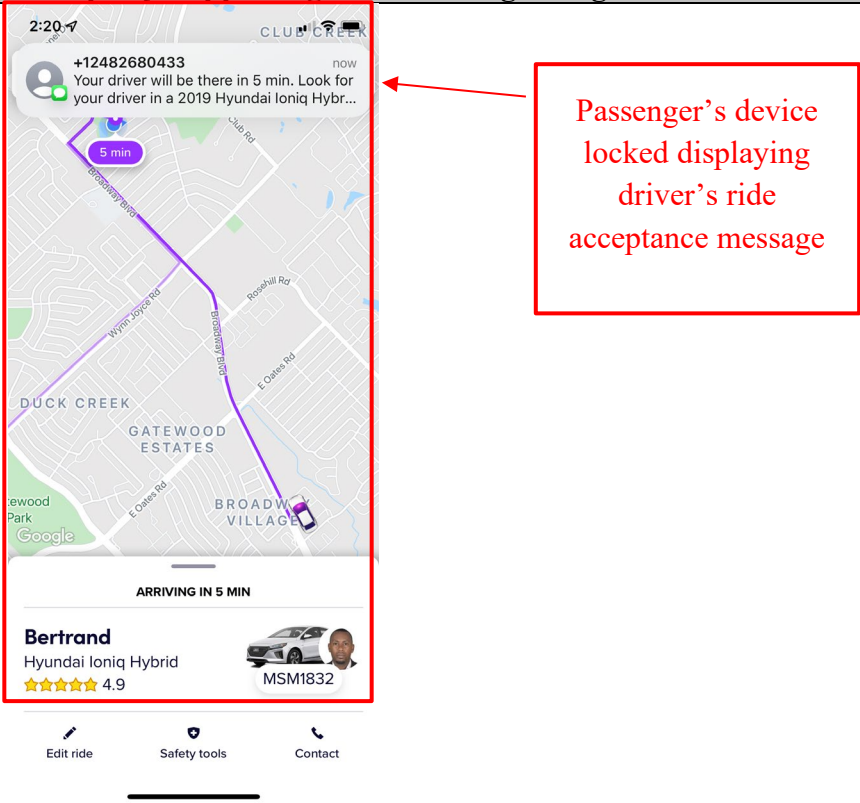
Claim - 8,213,970	Exemplary Supporting Evidence Regarding Accused Products
	 <p>2:20-7 CLU... +12482680433 now Your driver will be there in 5 min. Look for your driver in a 2019 Hyundai Ioniq Hybr... 5 min DUCK CREEK GATEWOOD ESTATES BROADWAY VILLAGE ARRIVING IN 5 MIN Bertrand Hyundai Ioniq Hybrid ★★★★★ 4.9 MSM1832 Edit ride Safety tools Contact</p> <p>Passenger's device locked displaying driver's ride acceptance message</p> <p>See Claim 1[E] above.</p>
<p>10[B] transmitting an automatic acknowledgment of receipt to the sender PDA/cell phone, which</p>	<p>The Lyft Accused Products infringe directly and/or indirectly by performing, inducing others to perform, and/or contributing to the performance of: transmitting an automatic acknowledgment of receipt to the sender PDA/cell phone, which triggers the forced message alert software application program to take control of the recipient PDA/cell phone and show the content of the text message and a required response list on the display recipient PDA/cell phone or to repeat audibly the content of the voice message on the speakers of the recipient PDA/cell phone and show the required response list on the display recipient PDA/cell phone.</p>

RESTRICTED CONFIDENTIAL SOURCE CODE

Attachment D for US Patent No. 8,213,970 Against Lyft Accused Products

Claim - 8,213,970	Exemplary Supporting Evidence Regarding Accused Products
<p>triggers the forced message alert software application program to take control of the recipient PDA/cell phone and show the content of the text message and a required response list on the display recipient PDA/cell phone or to repeat audibly the content of the voice message on the speakers of the recipient PDA/cell phone and show the required response list on the display recipient PDA/cell phone; and</p>	<p>For example, at the backend, each nearby driver’s Lyft app that received a ride request sends an acknowledgement of receipt to Lyft’s servers and further to the passenger’s Lyft app.</p> <p>For example, the ride request takes control of the Lyft driver’s device, displays a message with at least a pickup location and list of responses including but not limited to accept or decline (cross button). Further, the Lyft driver app plays an alert until a response is selected.</p> <div data-bbox="478 646 1768 1377" data-label="Image"> <p>The image is a screenshot of the Lyft mobile application interface. At the top, it shows a map with a purple line indicating the route from a pickup location to a drop-off location. The pickup location is labeled 'Pickup Radisson Hotel ML...' with a '6 min' estimated time. The drop-off location is 'Drop-off Petco Animal Supplies'. Below the map, there are two ride options: 'Lyft' for \$7.10 (4:13 PM) and 'Lyft XL' for \$8.75 (4:14 PM). At the bottom, there is a large purple button labeled 'Request Lyft' which is highlighted with a red rectangular box. The interface also shows 'PayPal' and 'Schedule' options.</p> </div> <p>https://www.youtube.com/watch?v=j0RDMLcmOgU at 4:01</p>

RESTRICTED CONFIDENTIAL SOURCE CODE

Attachment D for US Patent No. 8,213,970 Against Lyft Accused Products

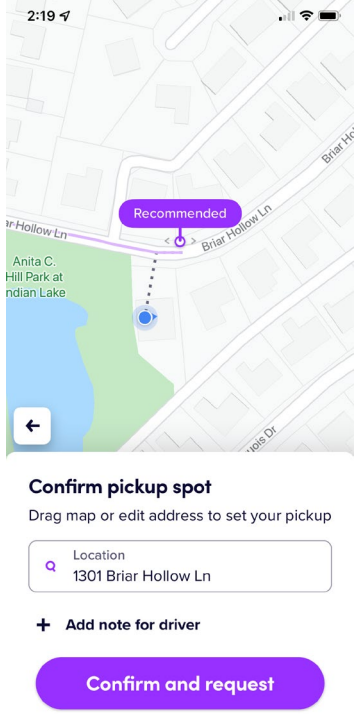
Claim - 8,213,970	Exemplary Supporting Evidence Regarding Accused Products
	 <p>The screenshot displays a mobile application interface for selecting a pickup location. At the top, a map shows a residential area with a purple dot indicating a 'Recommended' pickup spot at 1301 Briar Hollow Ln. Below the map, the text 'Confirm pickup spot' is followed by the instruction 'Drag map or edit address to set your pickup'. A search bar contains the text 'Location 1301 Briar Hollow Ln'. Below the search bar, there is a plus sign icon and the text '+ Add note for driver'. At the bottom, a large purple button is labeled 'Confirm and request'.</p>

RESTRICTED CONFIDENTIAL SOURCE CODE

Attachment D for US Patent No. 8,213,970 Against Lyft Accused Products

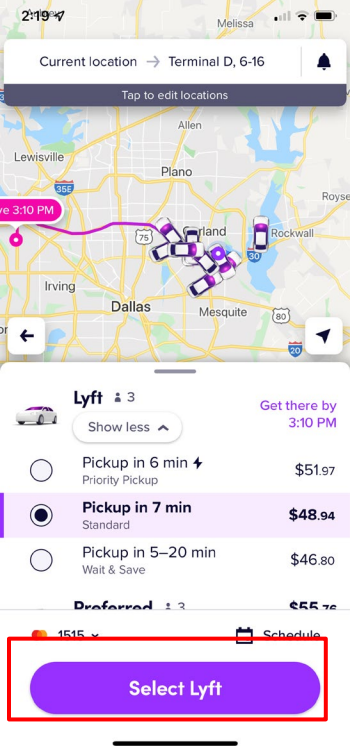
Claim - 8,213,970	Exemplary Supporting Evidence Regarding Accused Products												
	 <p>The screenshot displays the Lyft app interface. At the top, the current location is set to 'Terminal D, 6-16'. Below the map, three Lyft ride options are listed:</p> <table border="1"><thead><tr><th>Option</th><th>Estimated Time</th><th>Price</th></tr></thead><tbody><tr><td>Priority Pickup</td><td>Pickup in 6 min</td><td>\$51.97</td></tr><tr><td>Standard</td><td>Pickup in 7 min</td><td>\$48.94</td></tr><tr><td>Wait & Save</td><td>Pickup in 5-20 min</td><td>\$46.80</td></tr></tbody></table> <p>Below these options, a 'Preferred' section is partially visible with a price of \$55.76. At the bottom of the screen, a purple button labeled 'Select Lyft' is highlighted with a red rectangular box.</p>	Option	Estimated Time	Price	Priority Pickup	Pickup in 6 min	\$51.97	Standard	Pickup in 7 min	\$48.94	Wait & Save	Pickup in 5-20 min	\$46.80
Option	Estimated Time	Price											
Priority Pickup	Pickup in 6 min	\$51.97											
Standard	Pickup in 7 min	\$48.94											
Wait & Save	Pickup in 5-20 min	\$46.80											

RESTRICTED CONFIDENTIAL SOURCE CODE

Attachment D for US Patent No. 8,213,970 Against Lyft Accused Products

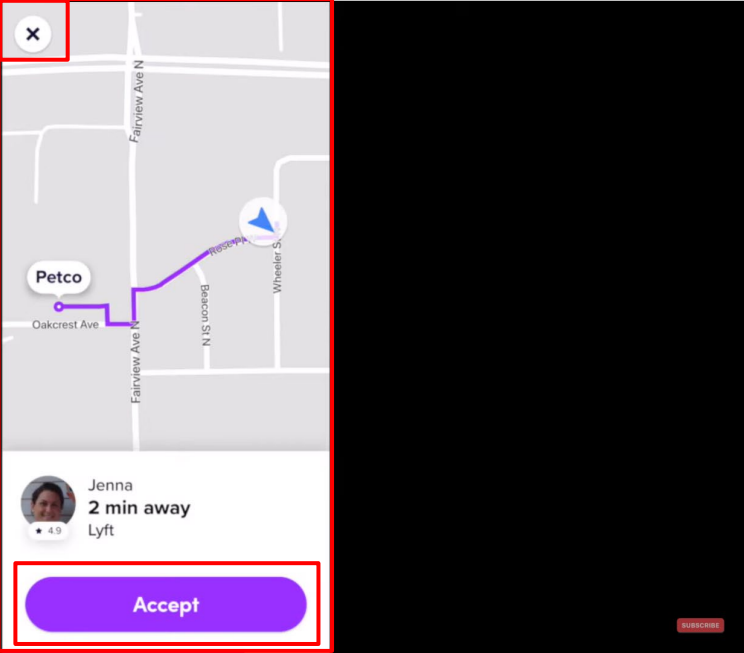
Claim - 8,213,970	Exemplary Supporting Evidence Regarding Accused Products
	<p data-bbox="520 302 751 505">Driver's device screen locked displaying passenger's ride request messages</p>  <p data-bbox="478 935 1398 969">https://www.youtube.com/watch?v=jVUy9poJDng at 10:24, Annotated</p>

RESTRICTED CONFIDENTIAL SOURCE CODE

Attachment D for US Patent No. 8,213,970 Against Lyft Accused Products

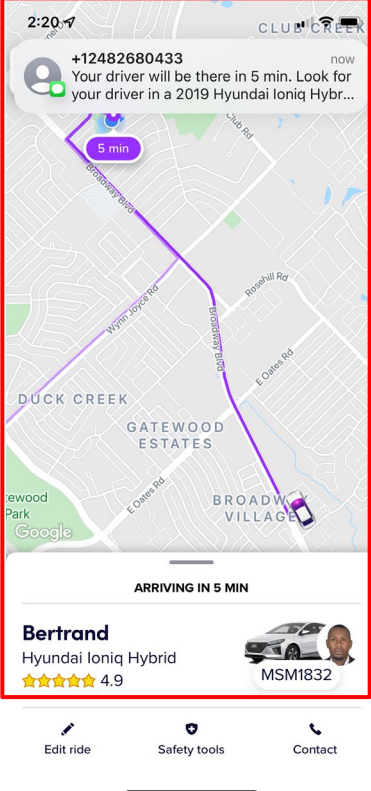
Claim - 8,213,970	Exemplary Supporting Evidence Regarding Accused Products
	<div data-bbox="472 284 840 1071"></div> <div data-bbox="1003 341 1323 592"><p>Passenger's device locked displaying driver's ride acceptance message</p></div> <p data-bbox="472 1120 892 1161">See Claims 1[E] and 1[F] above.</p> <p data-bbox="472 1193 1890 1307">Further, to the extent this element is performed at least in part by Lyft's software source code, AGIS reserves the right to supplement these contentions pursuant to production of such source code by Lyft and to the extent Lyft requires additional information in accordance with P.R. 3-1 and for any other reasons.</p>

RESTRICTED CONFIDENTIAL SOURCE CODE**Attachment D for US Patent No. 8,213,970 Against Lyft Accused Products**

Claim - 8,213,970	Exemplary Supporting Evidence Regarding Accused Products
<p>10[C] transmitting a selected required response from the response list in order to allow the message required response list to be cleared from the recipient's cell phone display, whether said selected response is a chosen option from the response list, causing the forced message alert software to release control of the recipient PDA/cell phone and stop showing the content of the text message and a response list on the display recipient PDA/cell phone and or stop repeating the content of the voice message on the speakers of the</p>	<p>The Lyft Accused Products infringe directly and/or indirectly by performing, inducing others to perform, and/or contributing to the performance of: transmitting a selected required response from the response list in order to allow the message required response list to be cleared from the recipient's cell phone display, whether said selected response is a chosen option from the response list, causing the forced message alert software to release control of the recipient PDA/cell phone and stop showing the content of the text message and a response list on the display recipient PDA/cell phone and or stop repeating the content of the voice message on the speakers of the recipient PDA/cell phone.</p> <p>For example, the Lyft driver app requires selecting to accept or dismiss a ride request to release control of the driver's device (clear the locked display showing ride request message). Selecting a response also stops the alerts in driver's device.</p>

RESTRICTED CONFIDENTIAL SOURCE CODE

Attachment D for US Patent No. 8,213,970 Against Lyft Accused Products

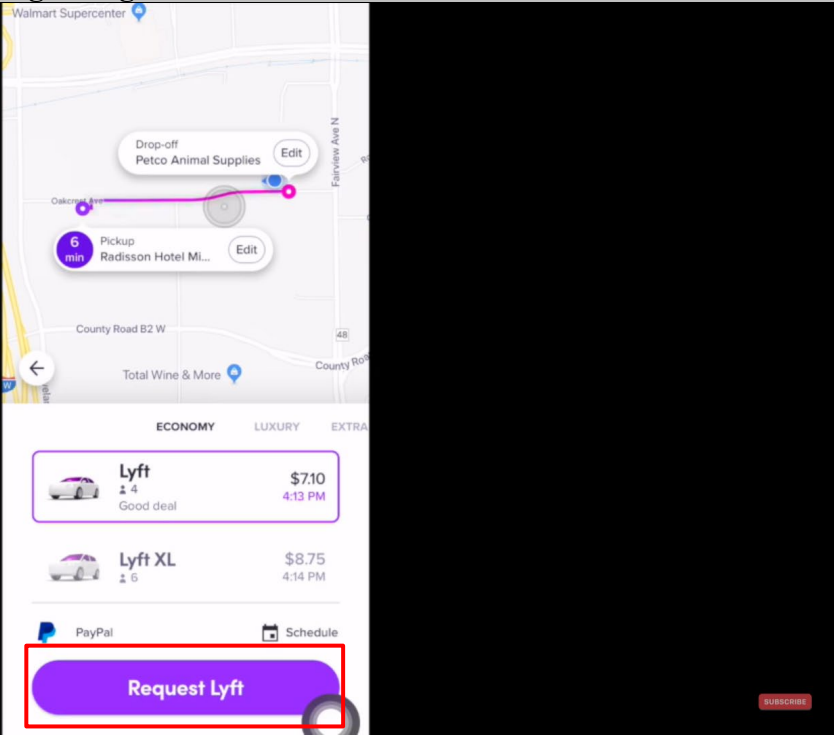
Claim - 8,213,970	Exemplary Supporting Evidence Regarding Accused Products
recipient PDA/cell phone;	 <p>https://www.youtube.com/watch?v=j0RDMLcmOgU at 4:01</p>

RESTRICTED CONFIDENTIAL SOURCE CODE

Attachment D for US Patent No. 8,213,970 Against Lyft Accused Products

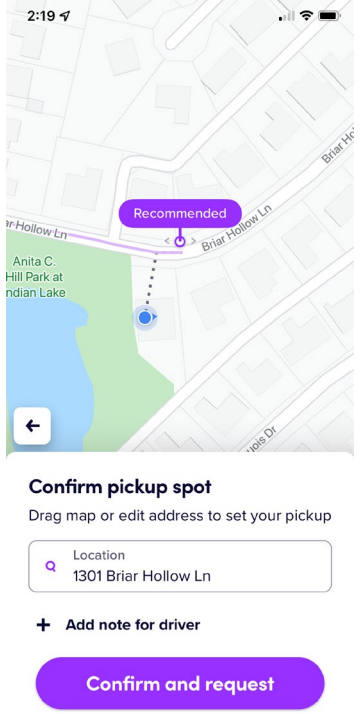
Claim - 8,213,970	Exemplary Supporting Evidence Regarding Accused Products
	 <p>The screenshot displays a mobile application interface for selecting a pickup location. At the top, a map shows a residential area with a purple dot indicating a 'Recommended' pickup spot at 1301 Briar Hollow Ln. Below the map, the text 'Confirm pickup spot' is followed by the instruction 'Drag map or edit address to set your pickup'. A search bar contains the text 'Location 1301 Briar Hollow Ln'. Below the search bar, there is a plus sign icon and the text '+ Add note for driver'. At the bottom, a large purple button is labeled 'Confirm and request'.</p>

RESTRICTED CONFIDENTIAL SOURCE CODE

Attachment D for US Patent No. 8,213,970 Against Lyft Accused Products

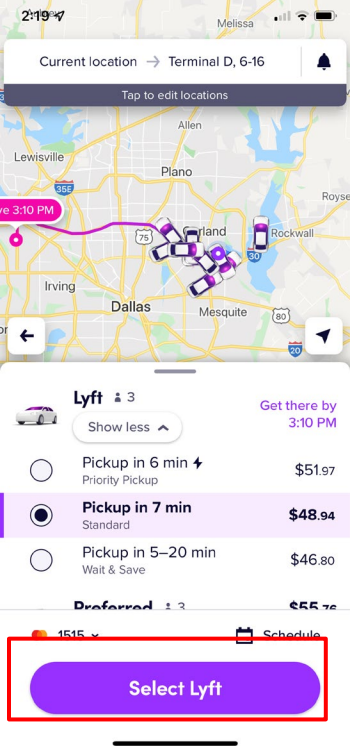
Claim - 8,213,970	Exemplary Supporting Evidence Regarding Accused Products												
	 <p>The screenshot shows the Lyft app interface for a ride request. The current location is Terminal D, 6-16. The destination is not explicitly named but is located in the Dallas area. The app displays three Lyft options:</p> <table border="1"><thead><tr><th>Option</th><th>Estimated Time</th><th>Price</th></tr></thead><tbody><tr><td>Priority Pickup</td><td>Pickup in 6 min</td><td>\$51.97</td></tr><tr><td>Standard</td><td>Pickup in 7 min</td><td>\$48.94</td></tr><tr><td>Wait & Save</td><td>Pickup in 5-20 min</td><td>\$46.80</td></tr></tbody></table> <p>A red box highlights the "Select Lyft" button at the bottom of the screen.</p>	Option	Estimated Time	Price	Priority Pickup	Pickup in 6 min	\$51.97	Standard	Pickup in 7 min	\$48.94	Wait & Save	Pickup in 5-20 min	\$46.80
Option	Estimated Time	Price											
Priority Pickup	Pickup in 6 min	\$51.97											
Standard	Pickup in 7 min	\$48.94											
Wait & Save	Pickup in 5-20 min	\$46.80											

RESTRICTED CONFIDENTIAL SOURCE CODE

Attachment D for US Patent No. 8,213,970 Against Lyft Accused Products

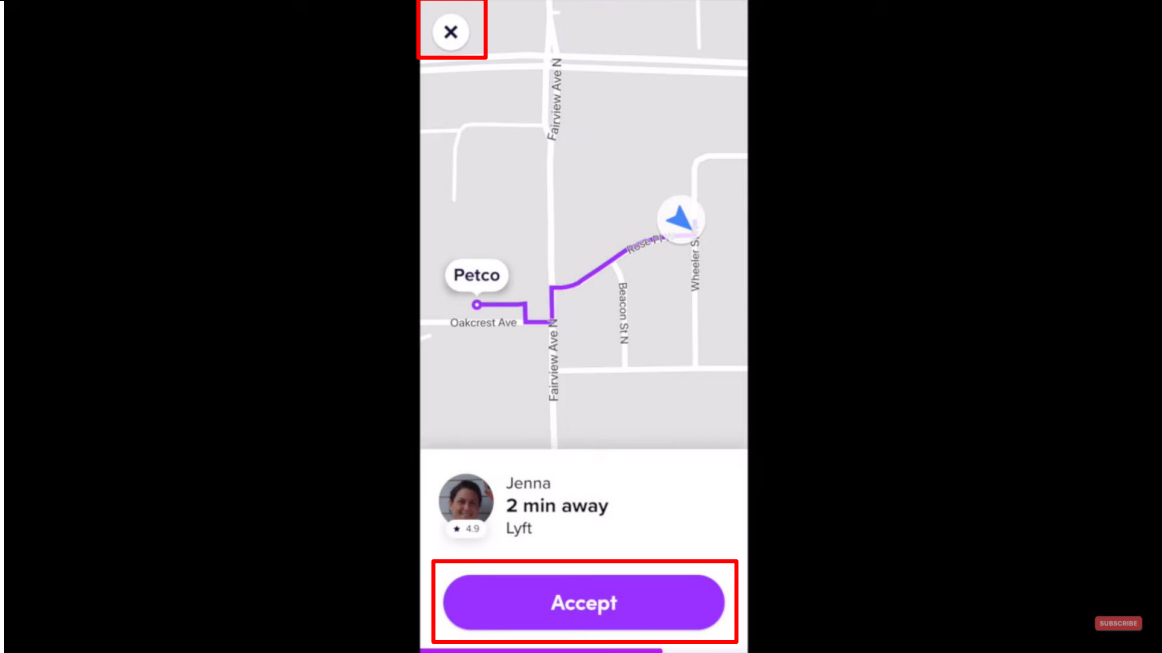
Claim - 8,213,970	Exemplary Supporting Evidence Regarding Accused Products
	 <p>https://www.youtube.com/watch?v=jVUy9poJDng at 10:24, Annotated</p>

RESTRICTED CONFIDENTIAL SOURCE CODE

Attachment D for US Patent No. 8,213,970 Against Lyft Accused Products

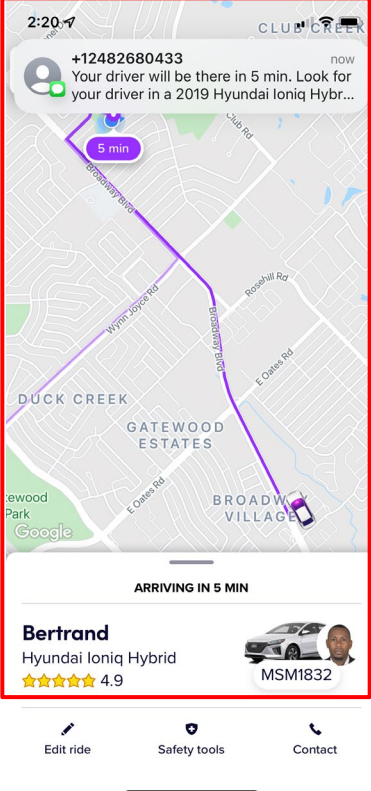
Claim - 8,213,970	Exemplary Supporting Evidence Regarding Accused Products
	<div data-bbox="472 284 840 1071"></div> <div data-bbox="1003 341 1323 592"><p>Passenger's device locked displaying driver's ride acceptance message</p></div> <p data-bbox="472 1120 766 1161">See Claim 1[E] above.</p> <p data-bbox="472 1193 1890 1307">Further, to the extent this element is performed at least in part by Lyft's software source code, AGIS reserves the right to supplement these contentions pursuant to production of such source code by Lyft and to the extent Lyft requires additional information in accordance with P.R. 3-1 and for any other reasons.</p>

RESTRICTED CONFIDENTIAL SOURCE CODE

Attachment D for US Patent No. 8,213,970 Against Lyft Accused Products

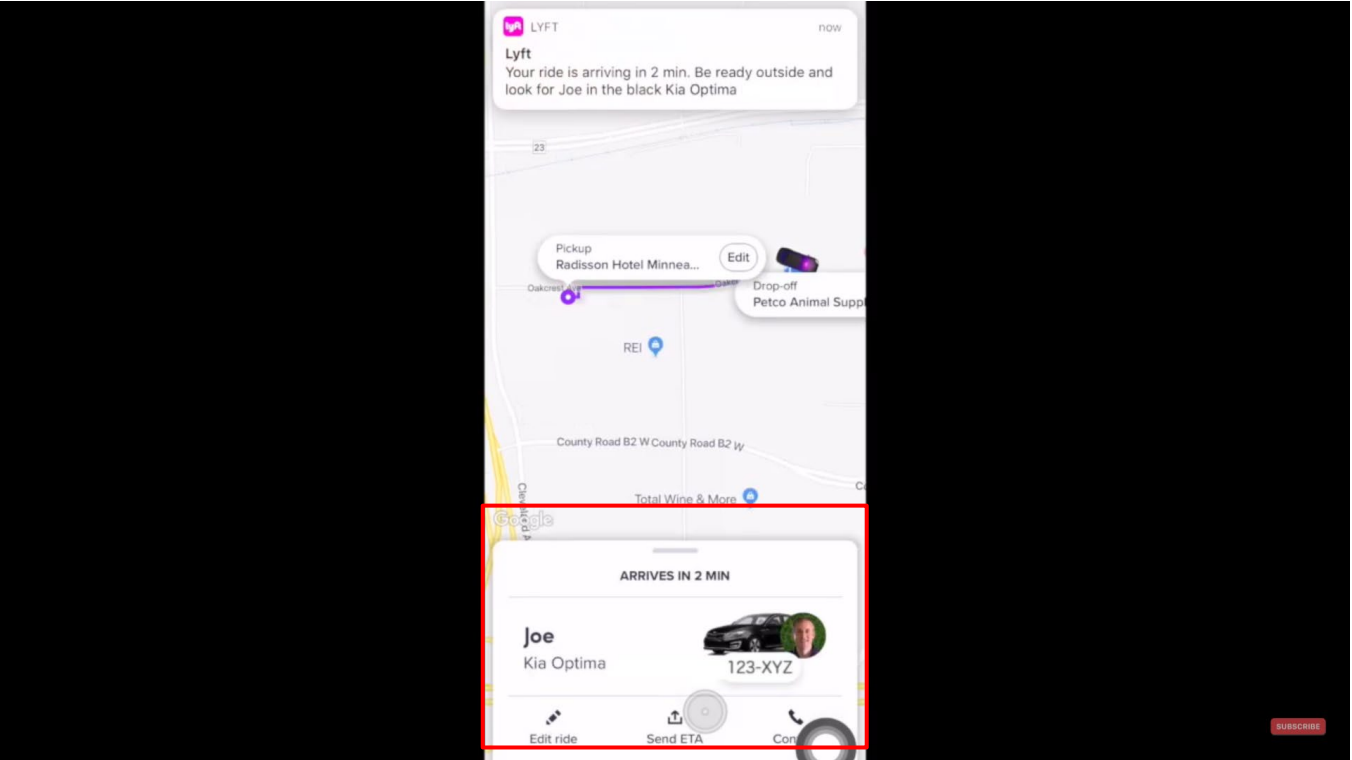
Claim - 8,213,970	Exemplary Supporting Evidence Regarding Accused Products
<p>10[D] displaying the response received from the PDA cell phone that transmitted the response on the sender of the forced alert PDA/cell phone; and</p>	<p>The Lyft Accused Products infringe directly and/or indirectly by performing, inducing others to perform, and/or contributing to the performance of: displaying the response received from the PDA cell phone that transmitted the response on the sender of the forced alert PDA/cell phone.</p> <p>For example, the Lyft app displays a driver's response of accepting the request for a ride on the passenger's device. For example, the screenshot below shows Joe (driver) who accepted a passenger's request for a ride.</p>  <p>https://www.youtube.com/watch?v=j0RDMLcmOgU, at 5:05</p>

RESTRICTED CONFIDENTIAL SOURCE CODE

Attachment D for US Patent No. 8,213,970 Against Lyft Accused Products

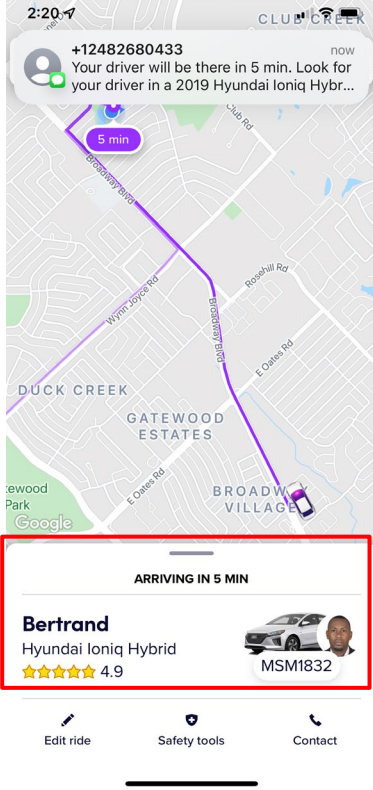
Claim - 8,213,970	Exemplary Supporting Evidence Regarding Accused Products
	 <p>See Claim 1[G] above.</p>
<p>10[E] providing a list of the recipient PDA/cell phones have automatically acknowledged receipt of a forced</p>	<p>The Lyft Accused Products infringe directly and/or indirectly by performing, inducing others to perform, and/or contributing to the performance of: providing a list of the recipient PDA/cell phones have automatically acknowledged receipt of a forced alert message and their response to the forced alert message.</p>

RESTRICTED CONFIDENTIAL SOURCE CODE

Attachment D for US Patent No. 8,213,970 Against Lyft Accused Products

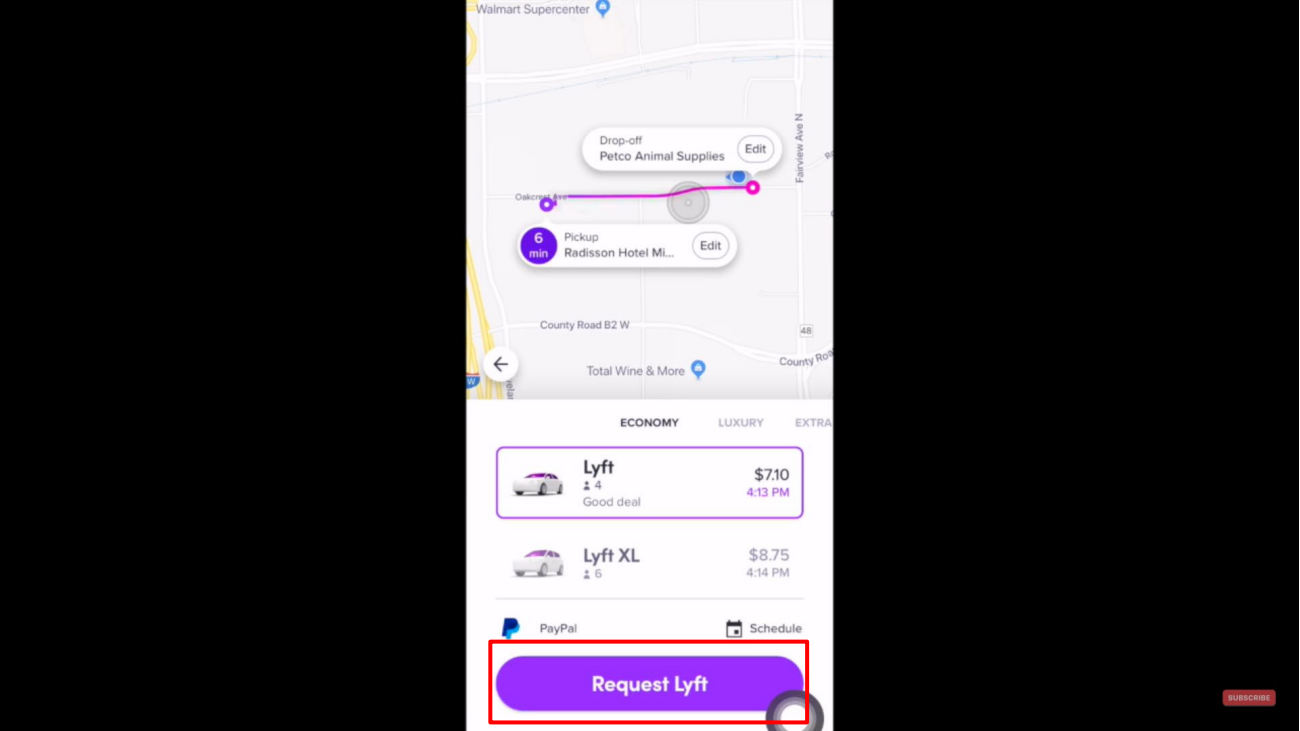
Claim - 8,213,970	Exemplary Supporting Evidence Regarding Accused Products
<p>alert message and their response to the forced alert message.</p>	<p>For example, at the backend, a list of all drivers' devices that automatically acknowledged the ride request of the passenger along with their response to the ride request message are maintained at Lyft's server. This ensures that the same drivers do not receive any further ride requests from the same passenger in case the ride request has not been matched yet thus lowering the traffic on network.</p>  <p>https://www.youtube.com/watch?v=j0RDMLcmOgU at 4:01</p>

RESTRICTED CONFIDENTIAL SOURCE CODE

Attachment D for US Patent No. 8,213,970 Against Lyft Accused Products

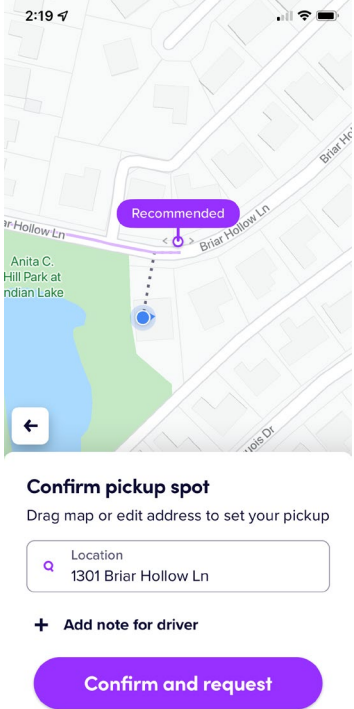
Claim - 8,213,970	Exemplary Supporting Evidence Regarding Accused Products
	 <p>The screenshot displays a mobile application interface for selecting a pickup location. At the top, a map shows a residential area with a purple dot indicating a 'Recommended' pickup spot at 1301 Briar Hollow Ln. Below the map, the text 'Confirm pickup spot' is followed by the instruction 'Drag map or edit address to set your pickup'. A search bar contains the text 'Location 1301 Briar Hollow Ln'. Below the search bar, there is a plus sign icon and the text '+ Add note for driver'. At the bottom, a large purple button is labeled 'Confirm and request'.</p>

RESTRICTED CONFIDENTIAL SOURCE CODE

Attachment D for US Patent No. 8,213,970 Against Lyft Accused Products

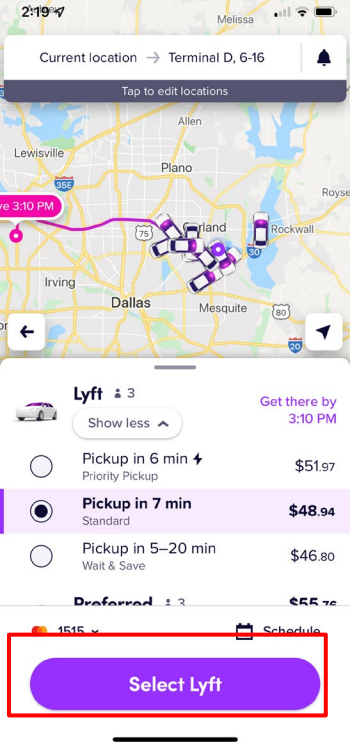
Claim - 8,213,970	Exemplary Supporting Evidence Regarding Accused Products												
	 <p>The screenshot shows the Lyft app interface for a ride request. The current location is Terminal D, 6-16. The destination is not explicitly named but is located in the Dallas area. The app displays three Lyft options:</p> <table border="1"><thead><tr><th>Option</th><th>Estimated Time</th><th>Price</th></tr></thead><tbody><tr><td>Priority Pickup</td><td>Pickup in 6 min</td><td>\$51.97</td></tr><tr><td>Standard</td><td>Pickup in 7 min</td><td>\$48.94</td></tr><tr><td>Wait & Save</td><td>Pickup in 5-20 min</td><td>\$46.80</td></tr></tbody></table> <p>A red box highlights the "Select Lyft" button at the bottom of the screen.</p>	Option	Estimated Time	Price	Priority Pickup	Pickup in 6 min	\$51.97	Standard	Pickup in 7 min	\$48.94	Wait & Save	Pickup in 5-20 min	\$46.80
Option	Estimated Time	Price											
Priority Pickup	Pickup in 6 min	\$51.97											
Standard	Pickup in 7 min	\$48.94											
Wait & Save	Pickup in 5-20 min	\$46.80											

RESTRICTED CONFIDENTIAL SOURCE CODE

Attachment D for US Patent No. 8,213,970 Against Lyft Accused Products

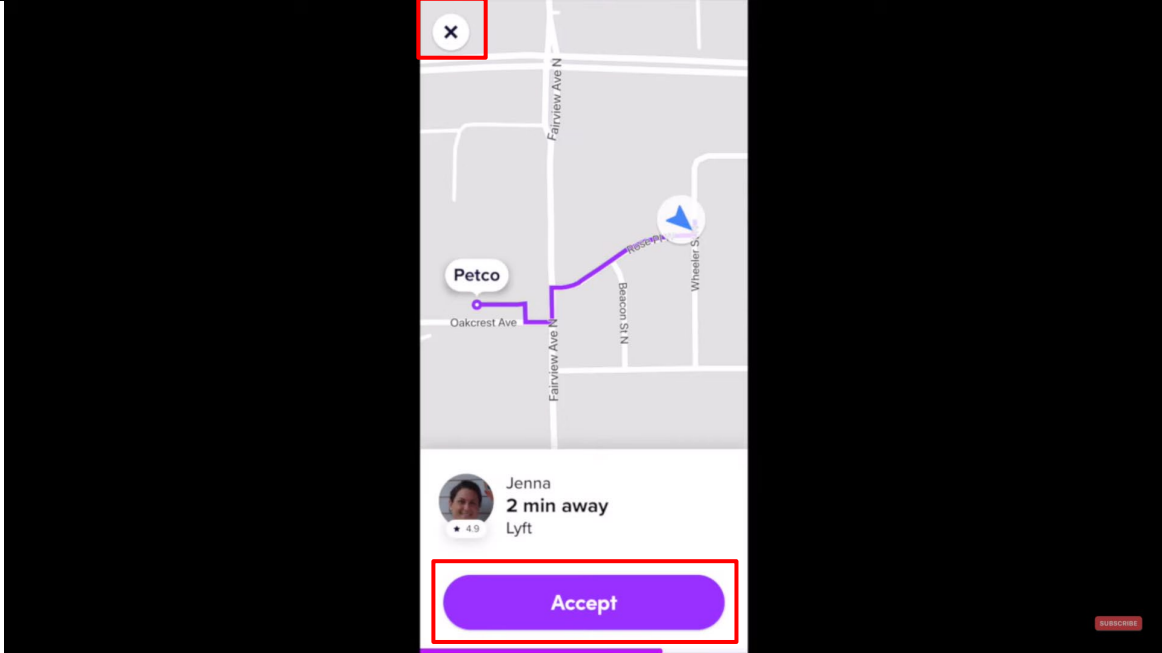
Claim - 8,213,970	Exemplary Supporting Evidence Regarding Accused Products
	 <p>https://www.youtube.com/watch?v=jVUy9poJDng at 10:24, Annotated</p>

RESTRICTED CONFIDENTIAL SOURCE CODE

Attachment D for US Patent No. 8,213,970 Against Lyft Accused Products

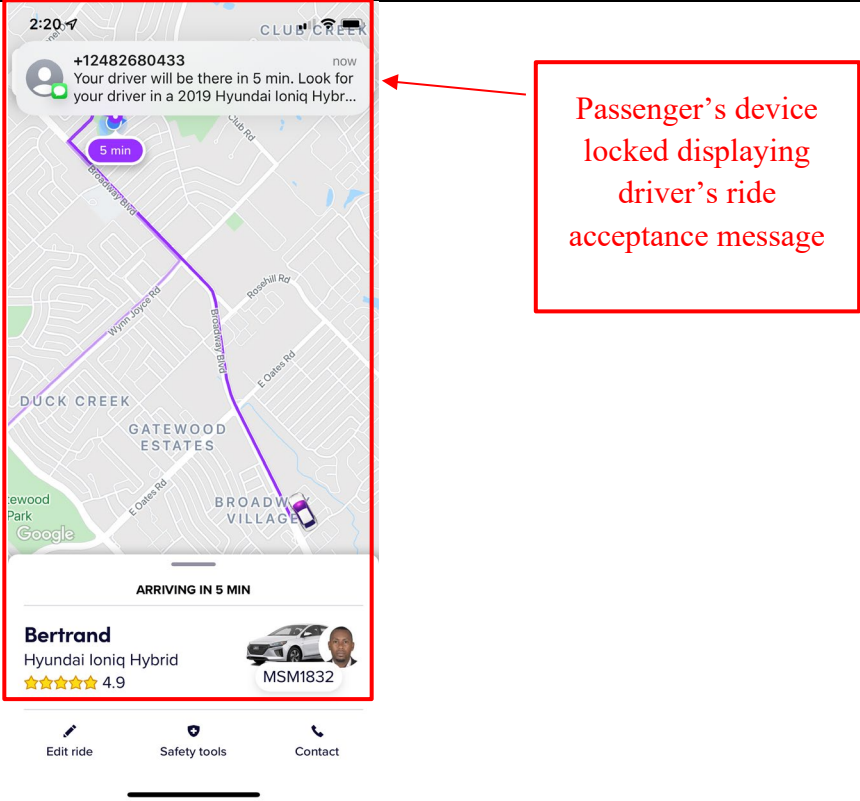
Claim - 8,213,970	Exemplary Supporting Evidence Regarding Accused Products
	 <p>2:20-7 CLU... +12482680433 now Your driver will be there in 5 min. Look for your driver in a 2019 Hyundai Ioniq Hybr... 5 min DUCK CREEK GATEWOOD ESTATES BROADWAY VILLAGE ARRIVING IN 5 MIN Bertrand Hyundai Ioniq Hybrid ★★★★★ 4.9 MSM1832 Edit ride Safety tools Contact</p> <p>Passenger's device locked displaying driver's ride acceptance message</p> <p>See Claim 1[G] above.</p>
<p>12. The method as in claim 10, wherein said forced message alert application software packet</p>	<p>The Lyft Accused Products infringe directly and/or indirectly by performing, inducing others to perform, and/or contributing to the performance of: the method as in claim 10, wherein said forced message alert application software packet contains a response list, wherein said response list is a default list embedded in the forced message alert software application program.</p>

RESTRICTED CONFIDENTIAL SOURCE CODE

Attachment D for US Patent No. 8,213,970 Against Lyft Accused Products

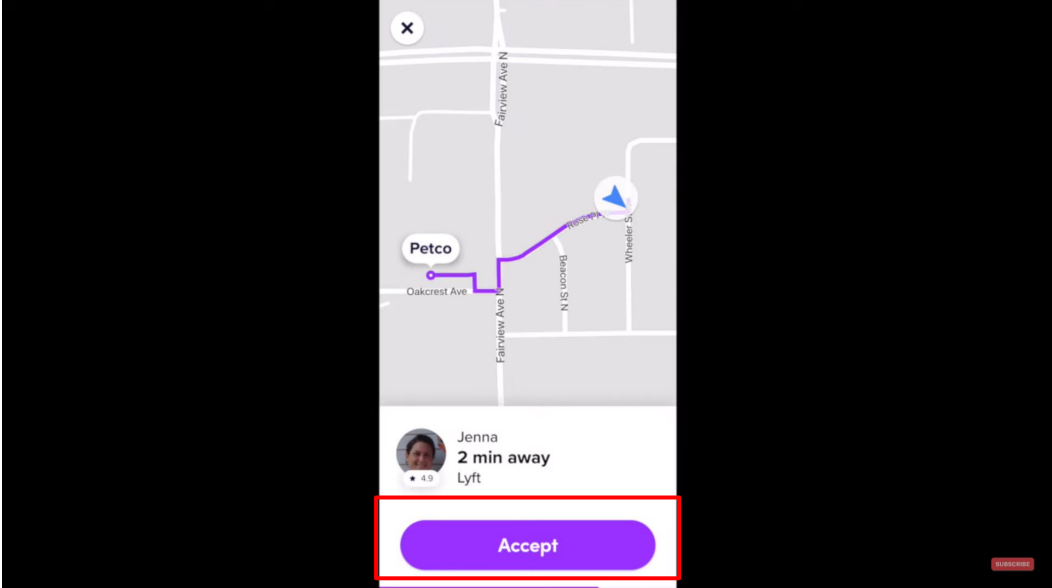
Claim - 8,213,970	Exemplary Supporting Evidence Regarding Accused Products
<p>contains a response list, wherein said response list is a default list embedded in the forced message alert software application program.</p>	<p>For example, a ride request message transmitted to the driver's Lyft Driver app comprises an accept or decline option to respond to the passenger's request (default list embedded in the forced message alert software application program).</p>  <p>The screenshot shows a Lyft driver app interface. At the top, there is a map with a purple route line starting from 'Petco' and ending at a destination. Below the map, the driver's name 'Jenna' is displayed, along with a profile picture, a 4.9 star rating, and the text '2 min away Lyft'. A prominent purple button labeled 'Accept' is highlighted with a red rectangular border. The entire screenshot is set against a black background.</p> <p>https://www.youtube.com/watch?v=jVUy9poJDng at 10:24, Annotated</p>

RESTRICTED CONFIDENTIAL SOURCE CODE

Attachment D for US Patent No. 8,213,970 Against Lyft Accused Products

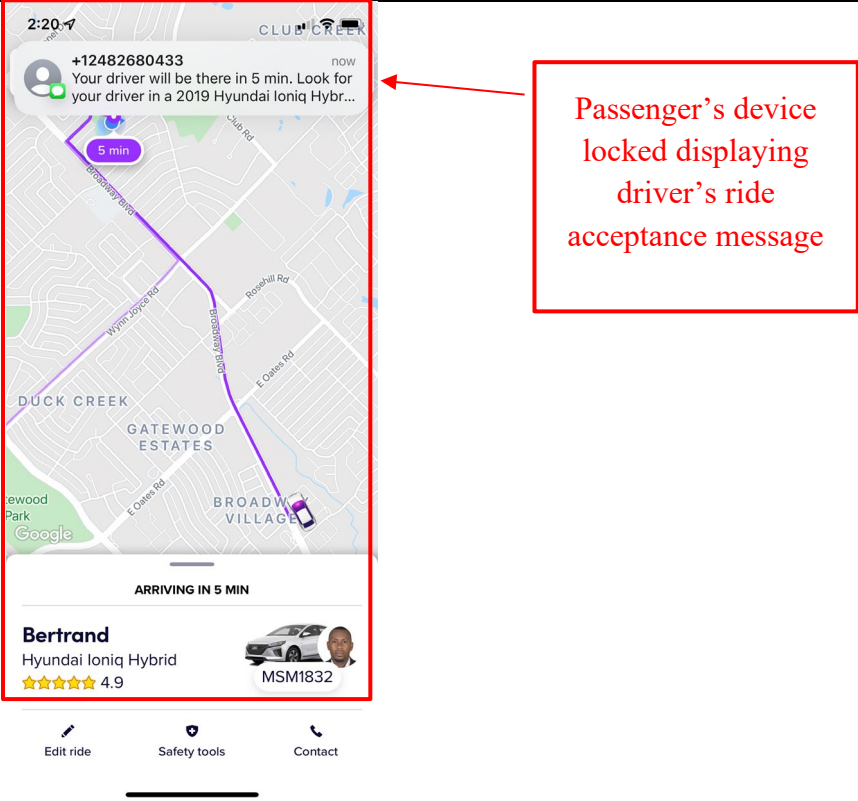
Claim - 8,213,970	Exemplary Supporting Evidence Regarding Accused Products
	 <p data-bbox="470 1122 768 1154">See Claim 1[D] above.</p>
<p>13. The method as in claim 10, wherein said forced message alert application software packet</p>	<p>See claim 1E above.</p>

RESTRICTED CONFIDENTIAL SOURCE CODE

Attachment D for US Patent No. 8,213,970 Against Lyft Accused Products

Claim - 8,213,970	Exemplary Supporting Evidence Regarding Accused Products
contains a response list, wherein said response list is a custom response list that is created at the time the specific forced message alert is created on the sender PDA/cell phone.	

Attachment E for US Patent No. 7,031,728 Against Lyft Accused Products

Based on information presently available,¹ Defendant AGIS Software Development LLC (“AGIS Software”) contends that Defendant Lyft Inc. (“Lyft” or “Plaintiff”) infringes claim 7 (the “Asserted Claim”) of U.S. Patent No. 7,031,728 (the “728 Patent”) through the Accused Products, Services which are manufactured, sold, offered for sale, and/or used by Lyft.

The Accused Products comprise the Lyft and Lyft Driver applications, servers, and services manufactured, used, or sold by Lyft, Inc. during and after 2016. AGIS Software reserves the right to seek leave of court to amend this list of Accused Products after the filing of an amended complaint or as discovery progresses.

Lyft directly infringes each of the Asserted Claims by making, using, importing, testing, distributing, selling, and/or offering for sale the Accused Products in violation of 35 U.S.C. § 271(a).

Lyft indirectly infringes the Asserted Claims in violation of 35 U.S.C. § 271(b) by inducing third parties, including its users and/or customers, to directly infringe through their operation and use of the Accused Products. Lyft has knowingly and intentionally induced this direct infringement by, *inter alia*, (i) selling, importing, or otherwise providing the Accused Products to third parties with the intent that the Accused Products will be operated and used in a manner that practices the Asserted Claims; and (ii) marketing and advertising the Accused Products. Lyft’s marketing and promotional materials for the Accused Products are found, for example, on Lyft’s website, and in App stores of operating systems for which the Accused Products are made available. For example, Lyft’s website offers customers instructions and/or manuals for the Accused Products that instruct customers to, among other things, use the accused services in the Accused Products. Lyft’s website also offers support to customers, including instruction to, among other things, use the Accused Products share location information with a group of users. Lyft knows, or should have known, that its actions will result in infringement of the Asserted Claims, or subjectively believes that there is a high probability that its actions will result in infringement of the Asserted Claims but has taken deliberate actions to avoid learning these facts.

Lyft also contributorily infringes each of the Asserted Claims in violation of 35 U.S.C. § 271(c) by selling, importing, offering for sale, and otherwise providing the Accused Products, which when used directly infringe the Asserted Claims. The Accused Products constitute a material part of the Asserted Claims.

¹ There is no operative complaint asserting non-infringement of any patent claim in this action at this time. AGIS Software reserves the right to update its contentions upon receipt of any future amended complaint.

Attachment E for US Patent No. 7,031,728 Against Lyft Accused Products

The following chart identifies specifically where each limitation of each Asserted Claim is found within the Accused Products, and in particular, the corresponding elements that meet the limitations in the Lyft and Lyft Driver applications, services, and services. On information and belief, each charted version of the Lyft Rider and Driver Apps are representative of all versions of the Accused Products, including all variants of the Accused Products made, sold, offered for sale, or used on any version of the Android and iOS operating systems.

AGIS Software does not concede that any claims of the '728 Patent that are not listed below are not infringed by the identified Accused Products. Moreover, the citations to certain documents and other information below are intended to be exemplary only and in no way foreclose AGIS from citing or relying on additional documents, information, source code, and/or testimony at a later time. These contentions are preliminary in nature and an analysis of Lyft's products, internal documentation, source code, and/or testimony from relevant witnesses may more fully and accurately describe the infringing features of its accused products. Accordingly, AGIS Software reserves the right to seek leave of court to supplement, correct, modify, and/or amend these contentions once such additional information is made available to AGIS Software. Furthermore, AGIS Software reserves the right to seek leave of court to supplement, correct, modify, and/or amend these contentions as discovery in this case progresses; in view of the Court's claim construction order(s);² in view of any positions taken by Lyft, including but not limited to positions on claim construction, invalidity, and/or non-infringement; and in connection with the preparation and exchange of expert reports.

The contents of each claim cell below on which another claim cell depends are expressly incorporated by reference in that dependent cell, as if set forth in their entirety therein.

² The construction of claim terms herein is consistent with the constructions in *AGIS Software Dev. LLC v. Huawei Device USA, Inc.*, No. 2:17-cv-00513-JRG, Dkt. 205 (E.D. Tex. Oct. 10, 2018); *AGIS Software Dev. LLC v. Google LLC*, No. 2:19-cv-00361-JRG, Dkt. 147 (E.D. Tex. Dec. 8, 2020); *AGIS Software Dev. LLC v. T-Mobile USA, Inc., et al.*, No. 2:21-cv-00072-JRG, Dkt. 213 (E.D. Tex. Nov. 10, 2021). AGIS Software reserves the right to update its constructions and contentions in view of this Court's claim construction order.

Attachment E for US Patent No. 7,031,728 Against Lyft Accused Products

Claim – 7,031,728	Exemplary Supporting Evidence Regarding Accused Products
<p>7[P]. A method of establishing a cellular phone communication network for designated participants, each having a similarly equipped cellular phone that includes voice communication, free and operator selected text messages, photograph and video, a CPU, a GPS navigation system and a touch screen display comprising the steps of:</p>	<p>The Lyft Accused Products practice the method of establishing a cellular phone communication network for designated participants, each having a similarly equipped cellular phone that includes voice communication, free and operator selected text messages, photograph and video, a CPU, a GPS navigation system and a touch screen display.</p> <p>For example, Lyft provides Lyft app for passengers and Lyft Driver app for drivers. The Lyft apps for riders and drivers, in conjunction with Lyft’s servers and services, provide users with interactive methods to request, view, and track locations of passengers/riders using real-time maps and communications. The Lyft server(s) and their services communicate with the Lyft apps for riders and drivers. The Lyft server(s) and their services host information related to and instructions for processing user/device/vehicle accounts, location data, and map data. The claimed methods are distributed by Lyft in the Lyft apps. The claimed methods are used/tested by Lyft using the Lyft apps. The claimed methods are downloaded and installed by Lyft’s customers (riders) and personnel (drivers, personnel) at the direction/encouragement of Lyft and used by Lyft’s customers and Lyft’s personnel.</p> <p>For example, when the passenger requests a ride from the Lyft app installed on their mobile phone, the ride request message is broadcasted to the nearby drivers who are online on the Lyft driver app. The message comprises the passenger’s name and profile photo.</p> <p>For example, when the driver accepts the ride request of the passenger, the passenger’s mobile phone receives the driver’s information such as name, location, and driver’s photo. After the passenger and the driver match, both of them get the option to text each other.</p>

Attachment E for US Patent No. 7,031,728 Against Lyft Accused Products

Claim – 7,031,728	Exemplary Supporting Evidence Regarding Accused Products
	<h2 data-bbox="583 240 1073 318">Lyft Driver app</h2> <div data-bbox="583 354 1814 440" style="border: 1px solid red; padding: 5px;"><p data-bbox="583 362 1814 431">We've separated the passenger and driver experiences into two separate mobile apps — one exclusively for passengers (named the Lyft app) and the other exclusively for drivers (named the Lyft Driver app).</p></div> <p data-bbox="583 461 1843 558">The Lyft Driver app will eventually be standard for all drivers and required for driving. At this time, drivers can keep using the Lyft app to give rides. Don't worry! While we have some planned improvements to the Lyft Driver app, we've kept its features the same.</p> <p data-bbox="583 589 1472 621">https://help.lyft.com/hc/en-ca/articles/115013079208-Lyft-Driver-app</p> <h2 data-bbox="583 675 884 724">What is Lyft?</h2> <p data-bbox="583 776 1654 846">Lyft is a platform that connects drivers with individuals and organizations that need rides.</p> <p data-bbox="583 873 1052 906">https://www.lyft.com/drive-with-lyft</p>

Attachment E for US Patent No. 7,031,728 Against Lyft Accused Products

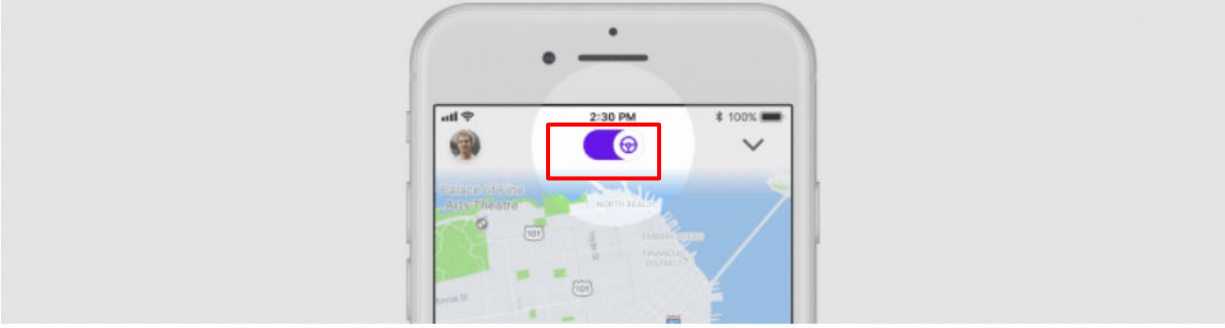
Claim – 7,031,728	Exemplary Supporting Evidence Regarding Accused Products
	 <p>Go online</p> <p>Open your Lyft Driver app and tap the steering wheel icon. Lyft will now find the closest passenger to your location requesting a ride. Turn on some music and get comfortable: that first ride request may come quickly or may take a while, depending on the number of current passenger requests.</p> <p>https://www.lyft.com/hub/posts/how-to-give-a-ride</p>

Attachment E for US Patent No. 7,031,728 Against Lyft Accused Products

Claim – 7,031,728	Exemplary Supporting Evidence Regarding Accused Products
	<p data-bbox="625 261 840 423">Driver's device displaying passenger's ride request message</p>  <p data-bbox="575 883 1493 912">https://www.youtube.com/watch?v=jVUy9poJDng at 10:24, Annotated</p>

Attachment E for US Patent No. 7,031,728 Against Lyft Accused Products

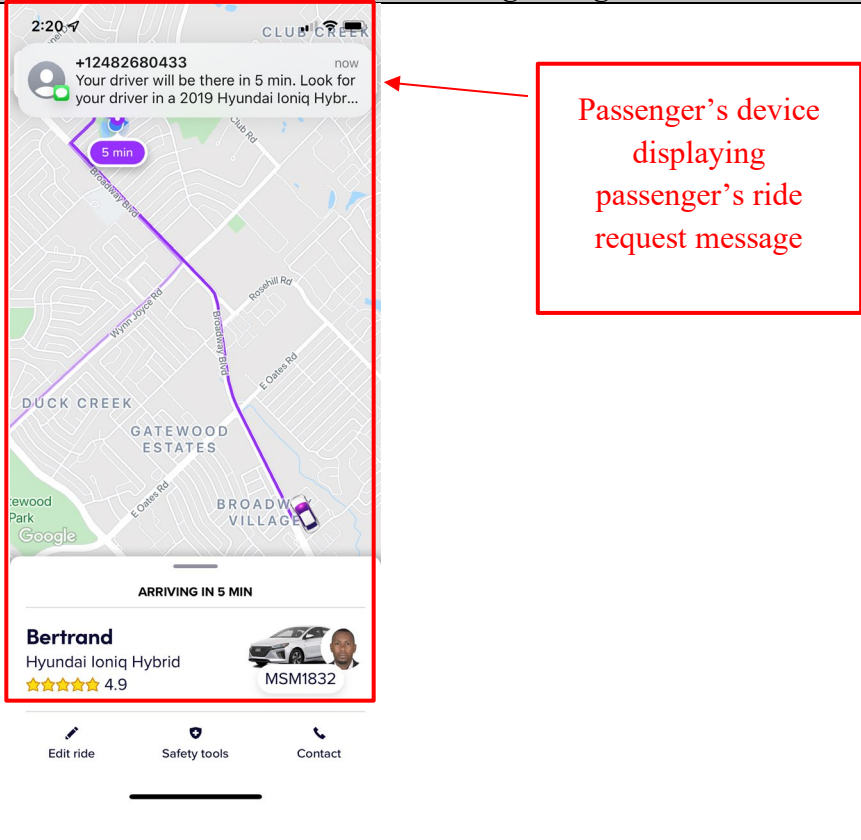
Claim – 7,031,728	Exemplary Supporting Evidence Regarding Accused Products
	 <p>2:20</p> <p>CLUB CREEK</p> <p>+12482680433 now Your driver will be there in 5 min. Look for your driver in a 2019 Hyundai Ioniq Hybr...</p> <p>5 min</p> <p>DUCK CREEK GATEWOOD ESTATES BROADWAY VILLAGES</p> <p>ARRIVING IN 5 MIN</p> <p>Bertrand Hyundai Ioniq Hybrid ★★★★★ 4.9 MSM1832</p> <p>Edit ride Safety tools Contact</p> <p>Passenger's device displaying passenger's ride request message</p>

Attachment E for US Patent No. 7,031,728 Against Lyft Accused Products

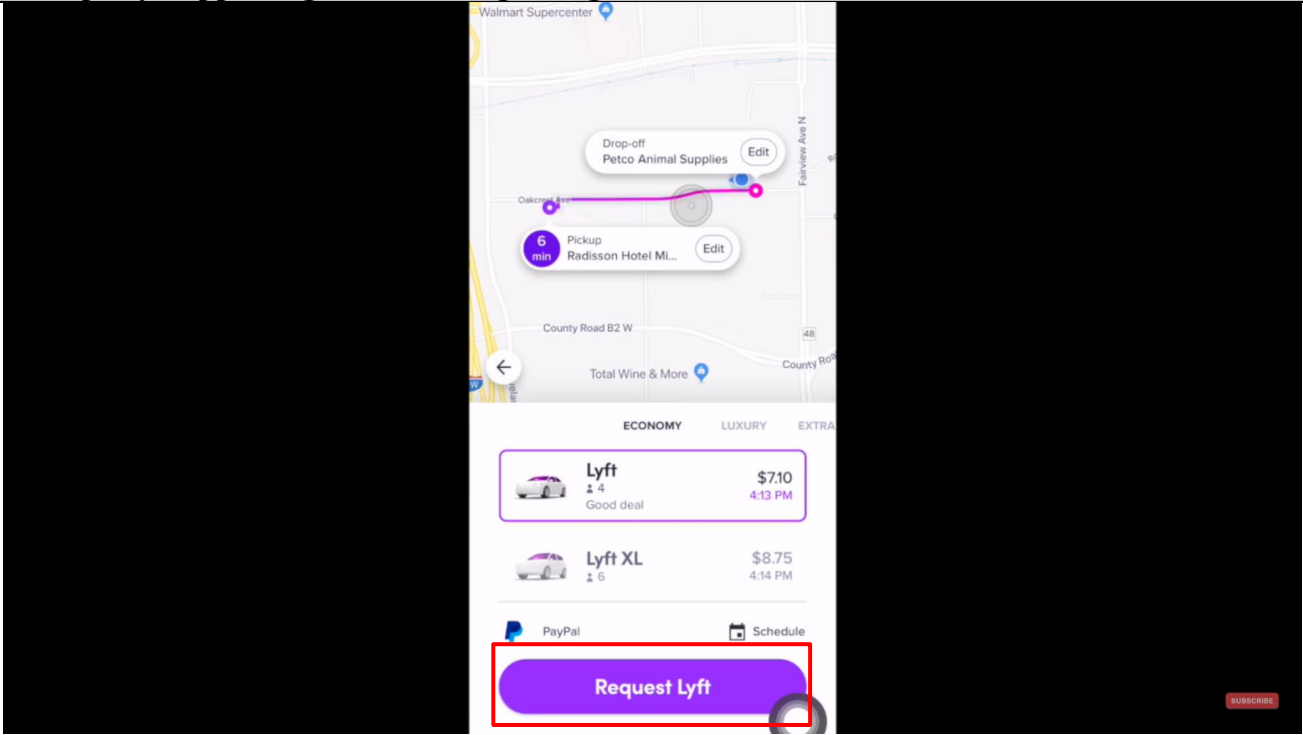
Claim – 7,031,728	Exemplary Supporting Evidence Regarding Accused Products
	 <p>https://www.youtube.com/watch?v=j0RDMLcmOgU at 4:01</p>

Attachment E for US Patent No. 7,031,728 Against Lyft Accused Products

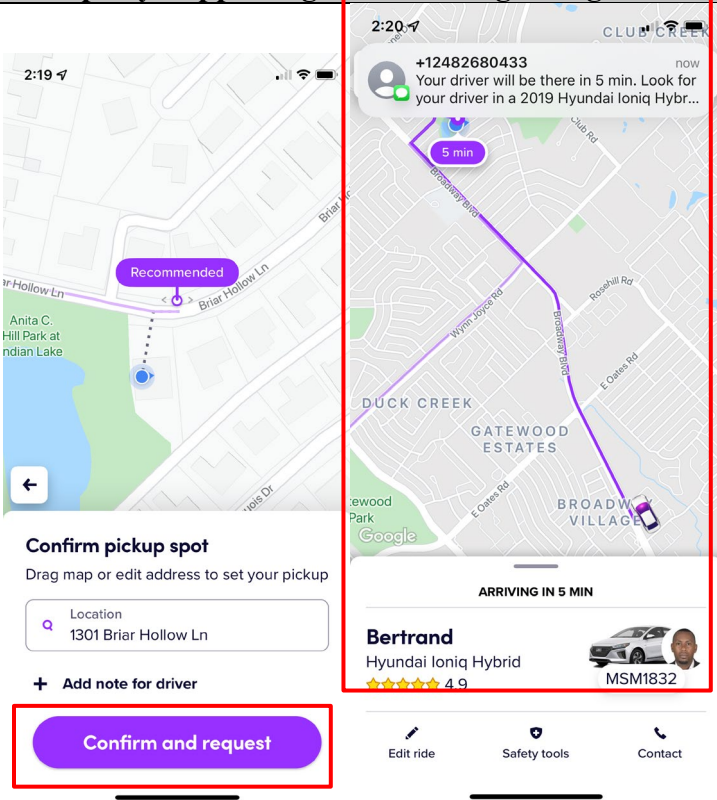
Claim – 7,031,728	Exemplary Supporting Evidence Regarding Accused Products
	 <p data-bbox="1472 310 1724 472">Passenger's device displaying passenger's ride request message</p> <p data-bbox="646 954 842 976">Confirm and request</p>

Attachment E for US Patent No. 7,031,728 Against Lyft Accused Products

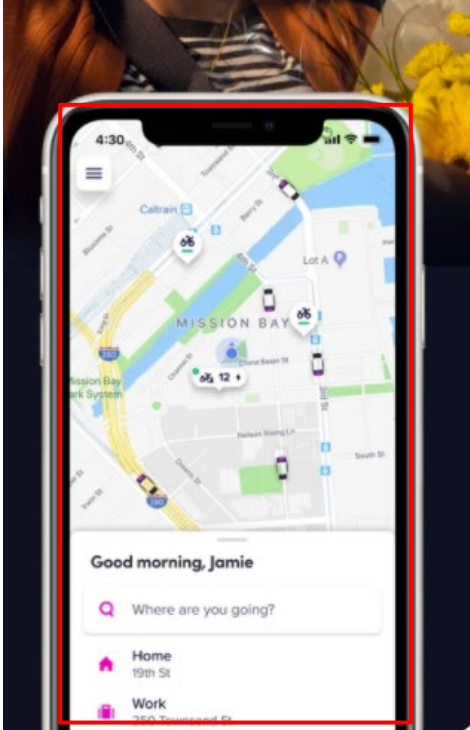
Claim – 7,031,728	Exemplary Supporting Evidence Regarding Accused Products
	 <p>https://apps.apple.com/in/app/lyft/id529379082</p>

Attachment E for US Patent No. 7,031,728 Against Lyft Accused Products

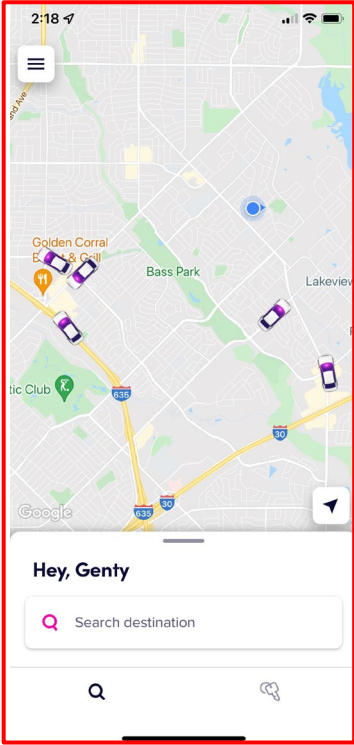
Claim – 7,031,728	Exemplary Supporting Evidence Regarding Accused Products
	 <p>The screenshot displays a mobile application interface. At the top, the time is 2:18. Below the time is a hamburger menu icon. The main area is a map showing a residential neighborhood with several purple car icons scattered across it. Labels on the map include 'Golden Corral E. & Grill', 'Bass Park', 'Lakeview', and 'Tennis Club'. At the bottom of the screen, there is a white search bar with the text 'Hey, Genty' and a magnifying glass icon. Below the search bar is a search input field with the placeholder text 'Search destination'. At the very bottom, there are two icons: a magnifying glass and a location pin.</p>









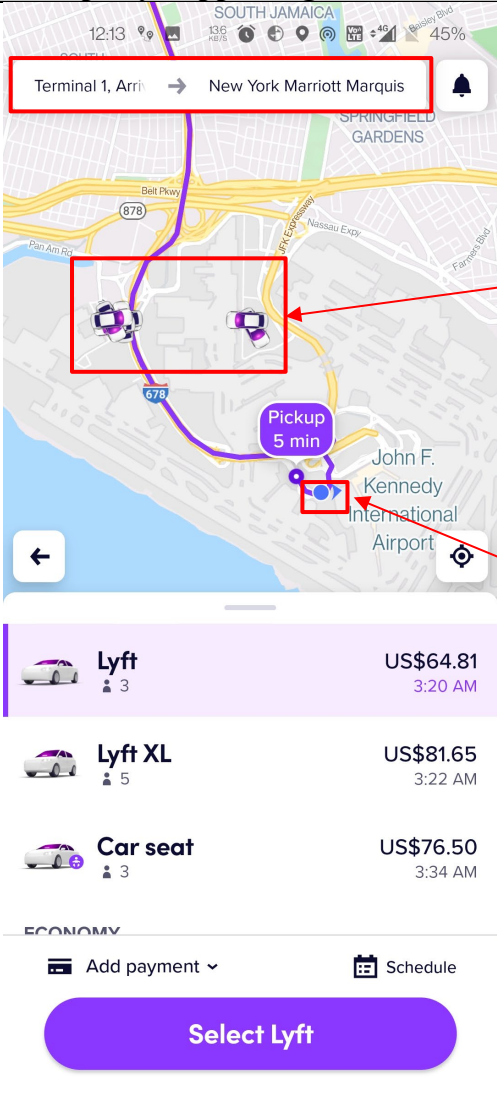

Attachment E for US Patent No. 7,031,728 Against Lyft Accused Products

Claim – 7,031,728	Exemplary Supporting Evidence Regarding Accused Products
	<p data-bbox="583 240 1808 396">Combining multiple components into a single chip saves on space, cost, and power consumption. Essentially, an SoC is the brain of your smartphone that handles everything from the Android operating system to detecting when you press the power off button. SoCs connect to other components too, such as cameras, a display, RAM, flash storage, and much more.</p> <p data-bbox="583 443 1787 513">The list below contains the most common components that you will find inside a smartphone System-on-a-Chip. We're going to cover a few of the most important ones later on in this article.</p> <ul data-bbox="642 540 1782 1138" style="list-style-type: none"> · Central Processing Unit (CPU) — The “brains” of the SoC. Runs most of the code for the Android OS and most of your apps. · Graphics Processing Unit (GPU) — Handles graphics-related tasks, such as visualizing an app’s user interface and 2D/3D gaming. · Image Processing Unit (ISP) — Converts data from the phone’s camera into image and video files. · Digital Signal Processor (DSP) — Handles more mathematically intensive functions than a CPU. Includes decompressing music files and analyzing gyroscope sensor data. · Neural Processing Unit (NPU) — Used in high-end smartphones to accelerate machine learning (AI) tasks. These include voice recognition and camera processing. · Video encoder/decoder — Handles the power-efficient conversion of video files and formats. · Modems — Converts wireless signals into data your phone understands. Components include 4G LTE, 5G, WiFi, and Bluetooth modems. <p data-bbox="569 1149 1745 1182">https://www.androidauthority.com/what-is-an-soc-smartphone-chipsets-explained-1051600/</p>

Attachment E for US Patent No. 7,031,728 Against Lyft Accused Products

Claim – 7,031,728	Exemplary Supporting Evidence Regarding Accused Products
	<p data-bbox="577 235 1738 414">You must have seen that every Android and iOS device in today's age comes with GPS right inside it. This is one feature that will be there in every smartphone no matter what the price of that device might be. And that is because of the fact that GPS is the most basic yet most useful feature on every smartphone.</p> <p data-bbox="577 462 1766 730">Just for information, the GPS stands for Global Positioning System and it provides accurate geolocation and time information for every equipment that is equipped with a GPS receiver. Now, the best example of using GPS is with services such as Google Maps, Apple Maps, and others where you can see where exactly you are right now on the Map. This is thanks to the GPS receiver which sends a signal to the GPS satellite.</p> <p data-bbox="577 738 1522 776">https://www.cashify.in/how-to-turn-off-gps-on-any-android-or-ios-device</p>

Attachment E for US Patent No. 7,031,728 Against Lyft Accused Products

Claim – 7,031,728	Exemplary Supporting Evidence Regarding Accused Products						
	 <p data-bbox="569 228 1062 341">Terminal 1, Arrivals → New York Marriott Marquis</p> <p data-bbox="1228 349 1428 552">Nearby Drivers' location</p> <p data-bbox="1201 673 1434 868">Passenger's location</p> <table border="1" data-bbox="569 852 1062 1136"><tbody><tr><td> Lyft</td><td>US\$64.81</td></tr><tr><td> Lyft XL</td><td>US\$81.65</td></tr><tr><td> Car seat</td><td>US\$76.50</td></tr></tbody></table> <p data-bbox="569 1144 1062 1201">ECONOMY Add payment Schedule</p> <p data-bbox="611 1218 1024 1291">Select Lyft</p>	 Lyft	US\$64.81	 Lyft XL	US\$81.65	 Car seat	US\$76.50
 Lyft	US\$64.81						
 Lyft XL	US\$81.65						
 Car seat	US\$76.50						

Attachment E for US Patent No. 7,031,728 Against Lyft Accused Products

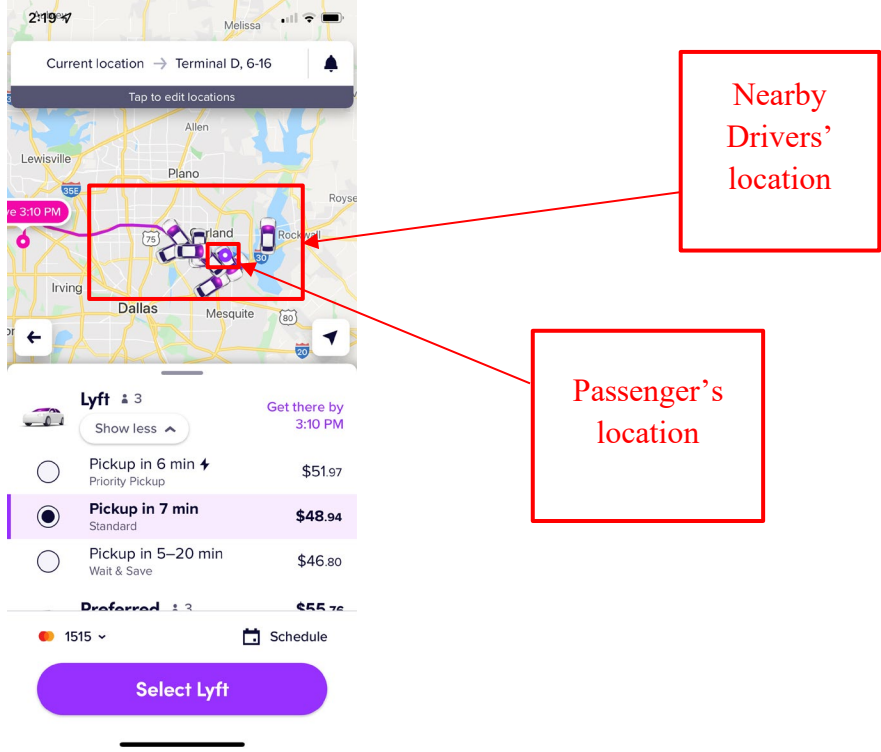
Claim – 7,031,728	Exemplary Supporting Evidence Regarding Accused Products												
	 <p>The screenshot displays the Lyft app interface. At the top, the current location is set to 'Terminal D, 6-16'. Below the map, there are three ride options listed:</p> <table border="1"><thead><tr><th>Pickup Time</th><th>Service Type</th><th>Price</th></tr></thead><tbody><tr><td>Pickup in 6 min</td><td>Priority Pickup</td><td>\$51.97</td></tr><tr><td>Pickup in 7 min</td><td>Standard</td><td>\$48.94</td></tr><tr><td>Pickup in 5-20 min</td><td>Wait & Save</td><td>\$46.80</td></tr></tbody></table> <p>The 'Pickup in 7 min' option is selected. A 'Select Lyft' button is visible at the bottom. Red annotations include a box labeled 'Nearby Drivers' location' pointing to a cluster of driver icons on the map, a box labeled 'Passenger's location' pointing to a specific driver icon, and a box labeled 'Pickup in 7 min' pointing to the selected option in the list.</p>	Pickup Time	Service Type	Price	Pickup in 6 min	Priority Pickup	\$51.97	Pickup in 7 min	Standard	\$48.94	Pickup in 5-20 min	Wait & Save	\$46.80
Pickup Time	Service Type	Price											
Pickup in 6 min	Priority Pickup	\$51.97											
Pickup in 7 min	Standard	\$48.94											
Pickup in 5-20 min	Wait & Save	\$46.80											

Attachment E for US Patent No. 7,031,728 Against Lyft Accused Products

Claim – 7,031,728	Exemplary Supporting Evidence Regarding Accused Products
	 <p>Driver's device displaying passenger's ride request message</p> <p>Passenger's location when pickup location is set to current location</p> <p>Driver's location</p> <p>Jenna 2 min away Lyft</p> <p>Accept</p> <p>https://www.youtube.com/watch?v=jVUy9poJDng at 10:24, Annotated</p>

Attachment E for US Patent No. 7,031,728 Against Lyft Accused Products

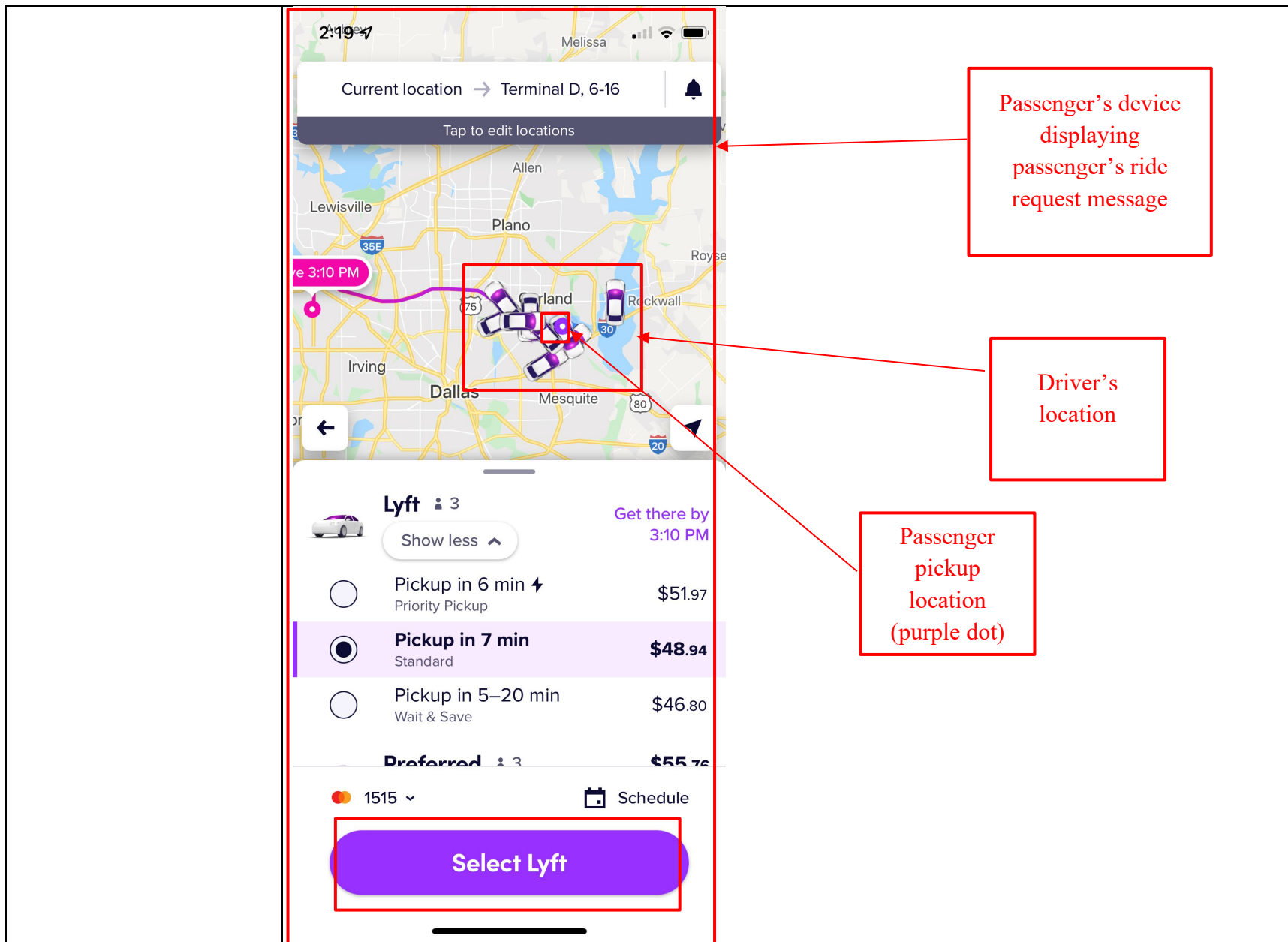

Attachment E for US Patent No. 7,031,728 Against Lyft Accused Products

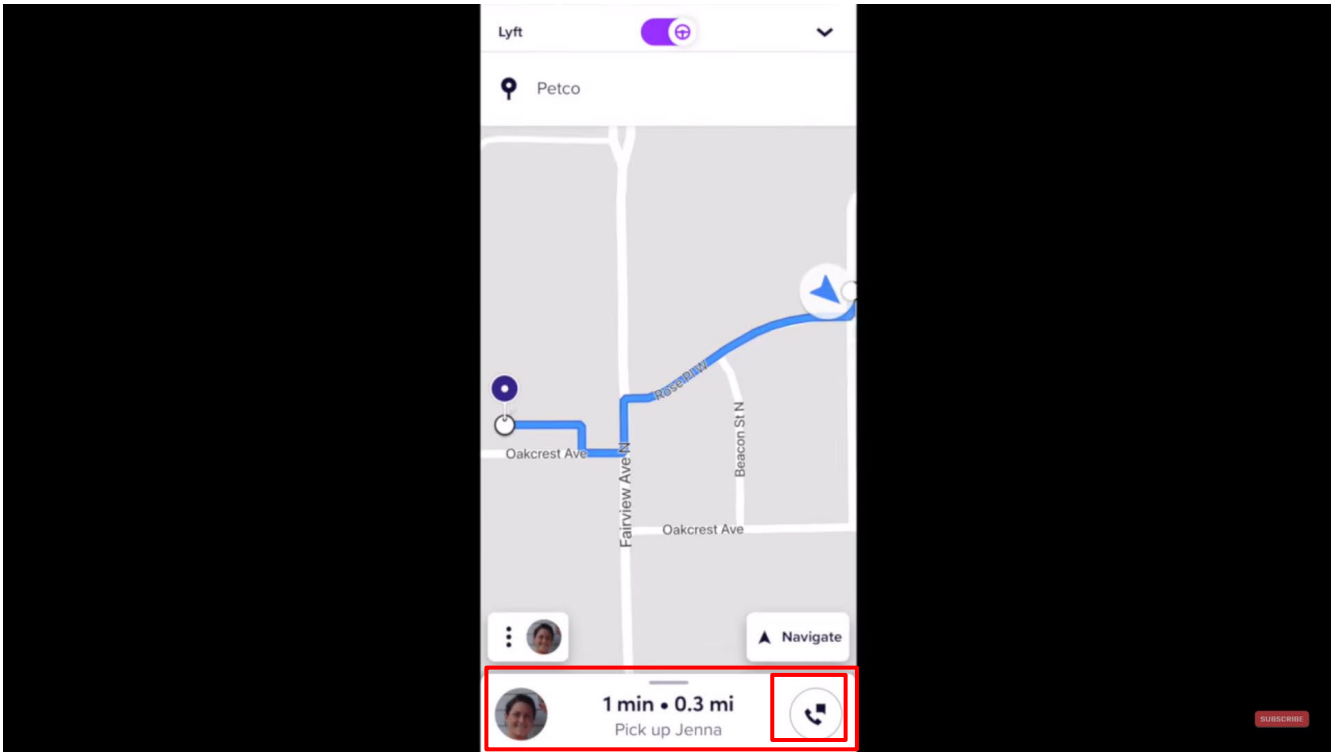
Claim – 7,031,728	Exemplary Supporting Evidence Regarding Accused Products
	 <p>https://www.youtube.com/watch?v=jVUy9poJDng at 10:46</p>

Attachment E for US Patent No. 7,031,728 Against Lyft Accused Products

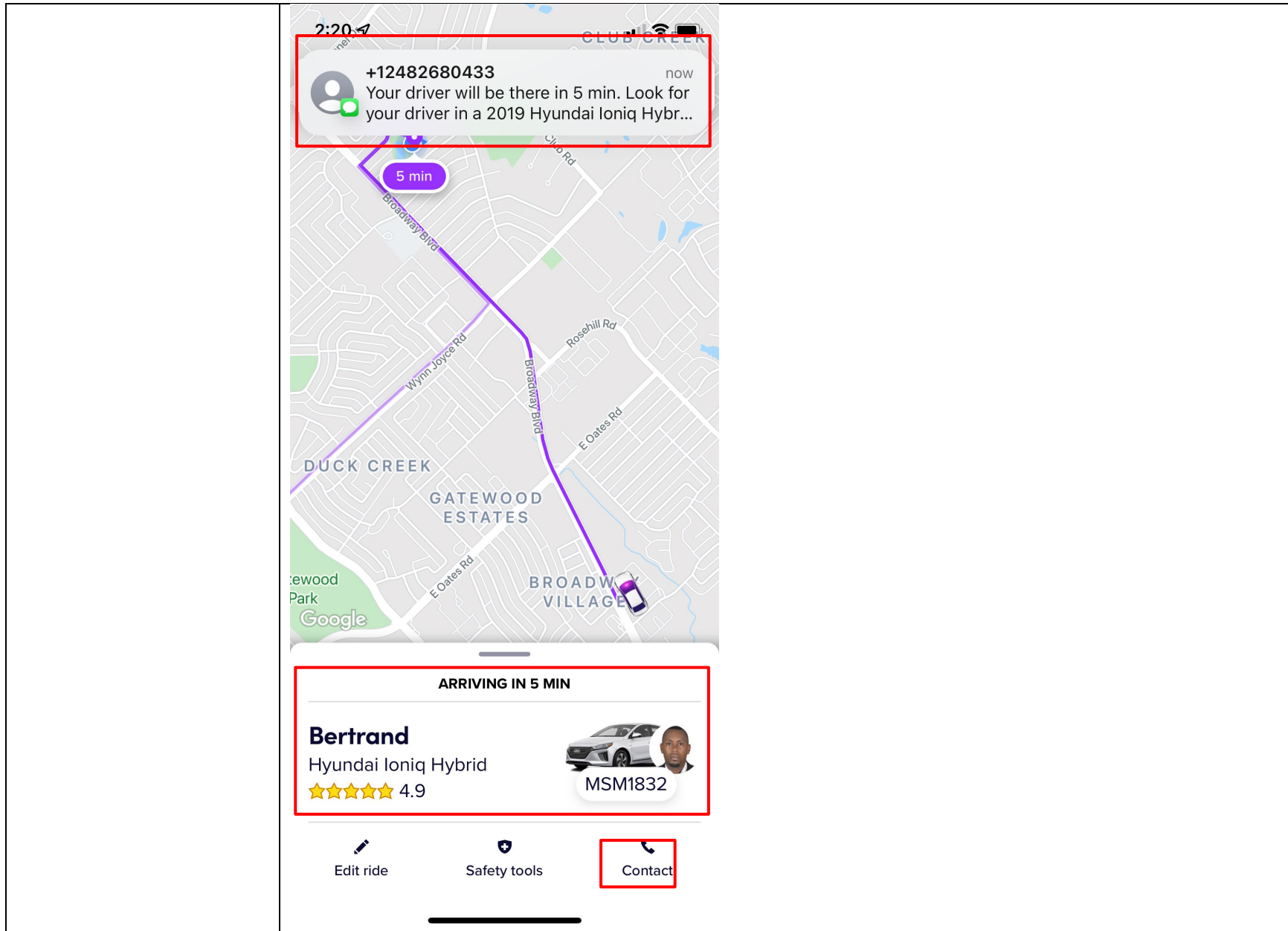

Attachment E for US Patent No. 7,031,728 Against Lyft Accused Products

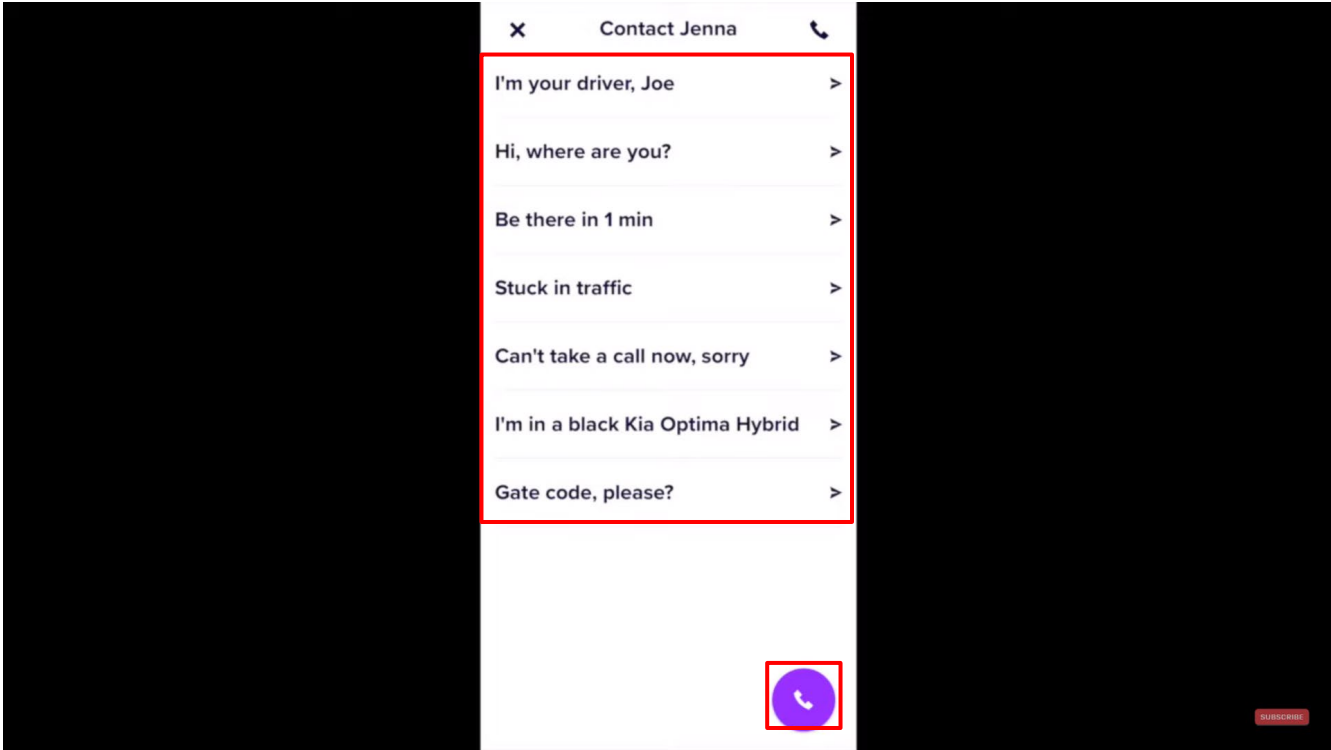
Claim – 7,031,728	Exemplary Supporting Evidence Regarding Accused Products
	 <p>The screenshot shows a mobile application interface for a Lyft driver. At the top, there is a header with a close button (X), the name 'Contact Jenna', and a phone icon. Below this is a list of seven menu items, each with a right-pointing chevron: 'I'm your driver, Joe', 'Hi, where are you?', 'Be there in 1 min', 'Stuck in traffic', 'Can't take a call now, sorry', 'I'm in a black Kia Optima Hybrid', and 'Gate code, please?'. A red rectangular box highlights this entire list. At the bottom right of the screen, there is a purple circular button with a white phone icon, also highlighted by a red rectangular box. A 'SUBSCRIBE' button is visible in the bottom right corner of the video frame. Below the screenshot, the URL https://www.youtube.com/watch?v=jVUy9poJDng is displayed, followed by the text 'at 11:21'.</p>

Attachment E for US Patent No. 7,031,728 Against Lyft Accused Products

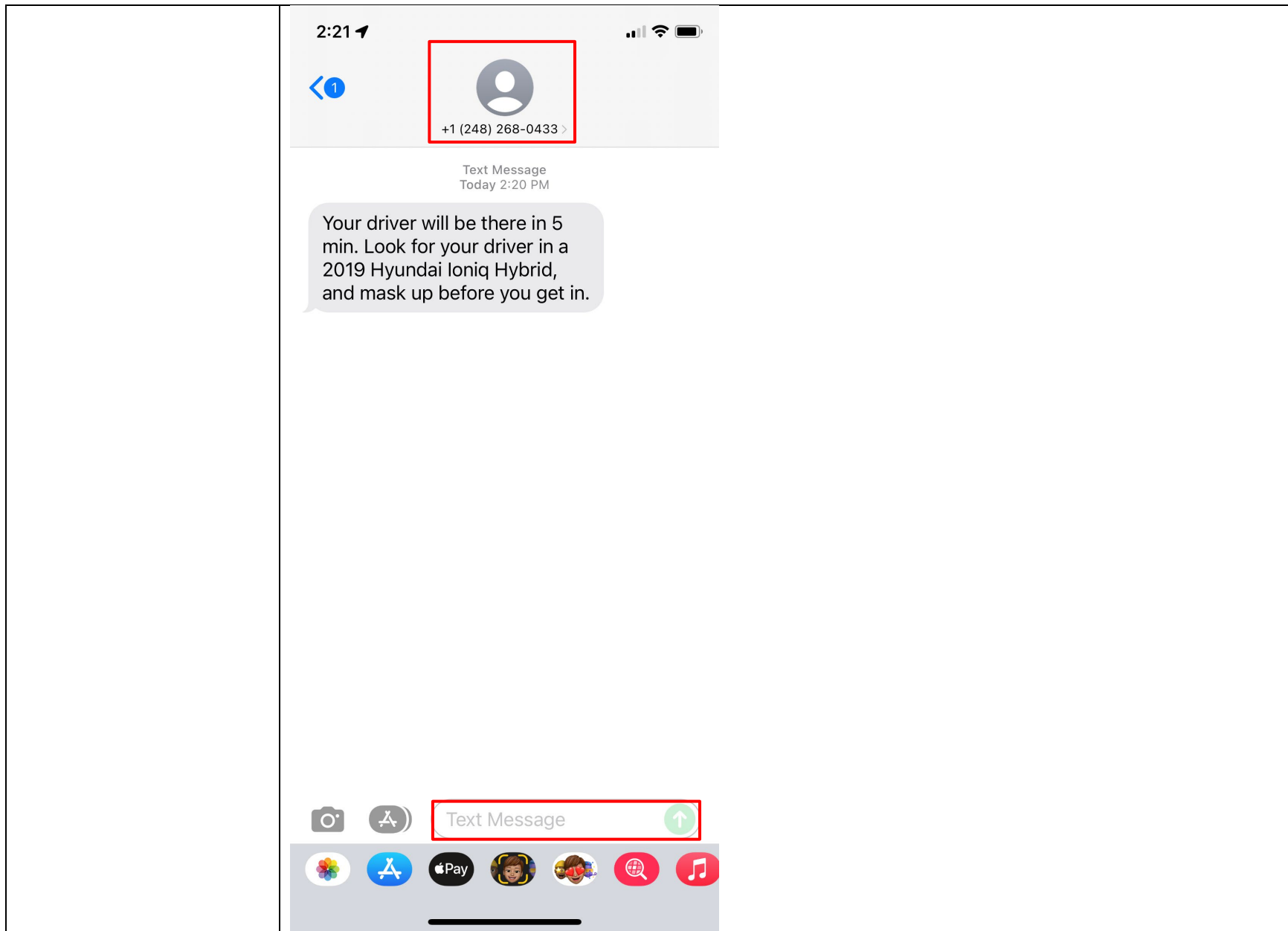

Attachment E for US Patent No. 7,031,728 Against Lyft Accused Products

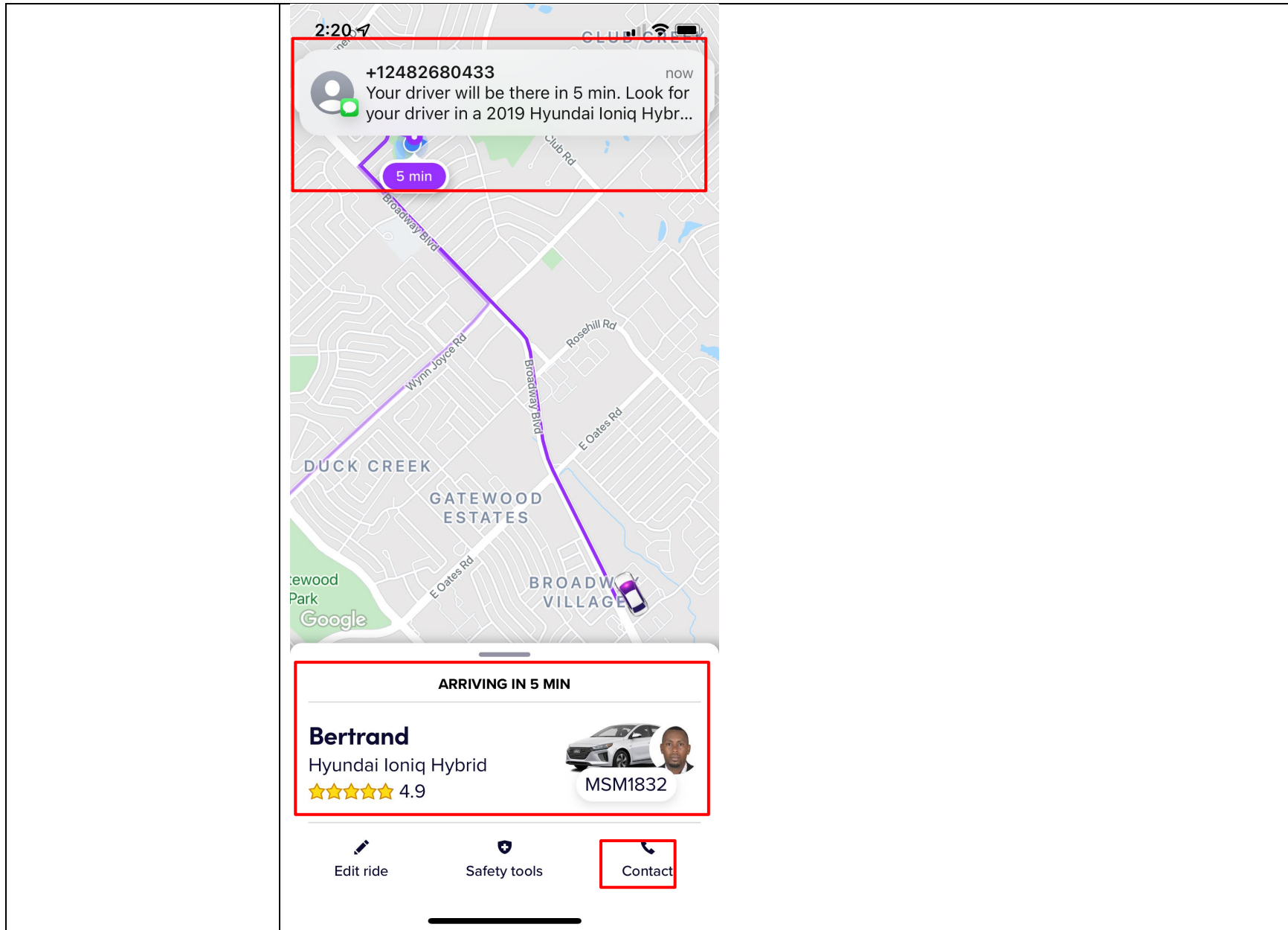

Attachment E for US Patent No. 7,031,728 Against Lyft Accused Products

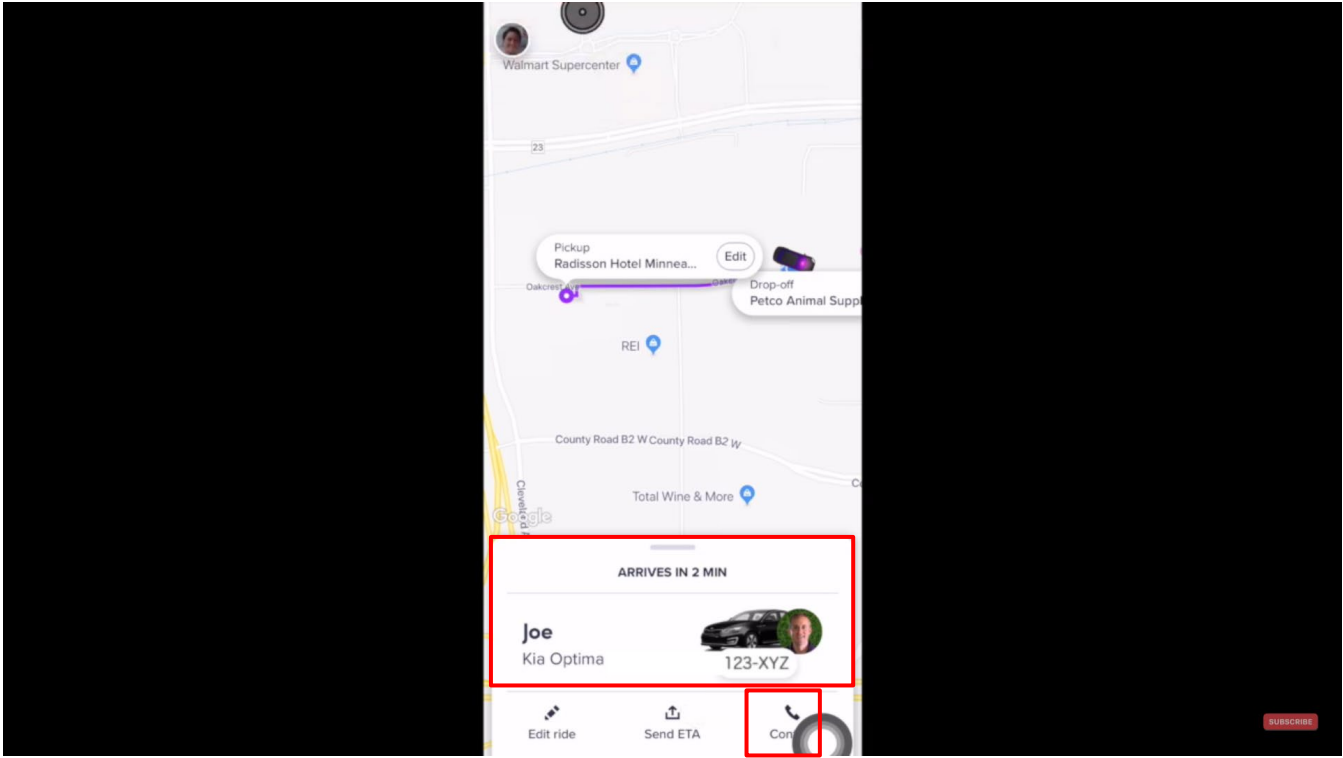
Claim – 7,031,728	Exemplary Supporting Evidence Regarding Accused Products
	 <p>https://www.youtube.com/watch?v=j0RDMLcmOgU at 5:07</p>

Attachment E for US Patent No. 7,031,728 Against Lyft Accused Products

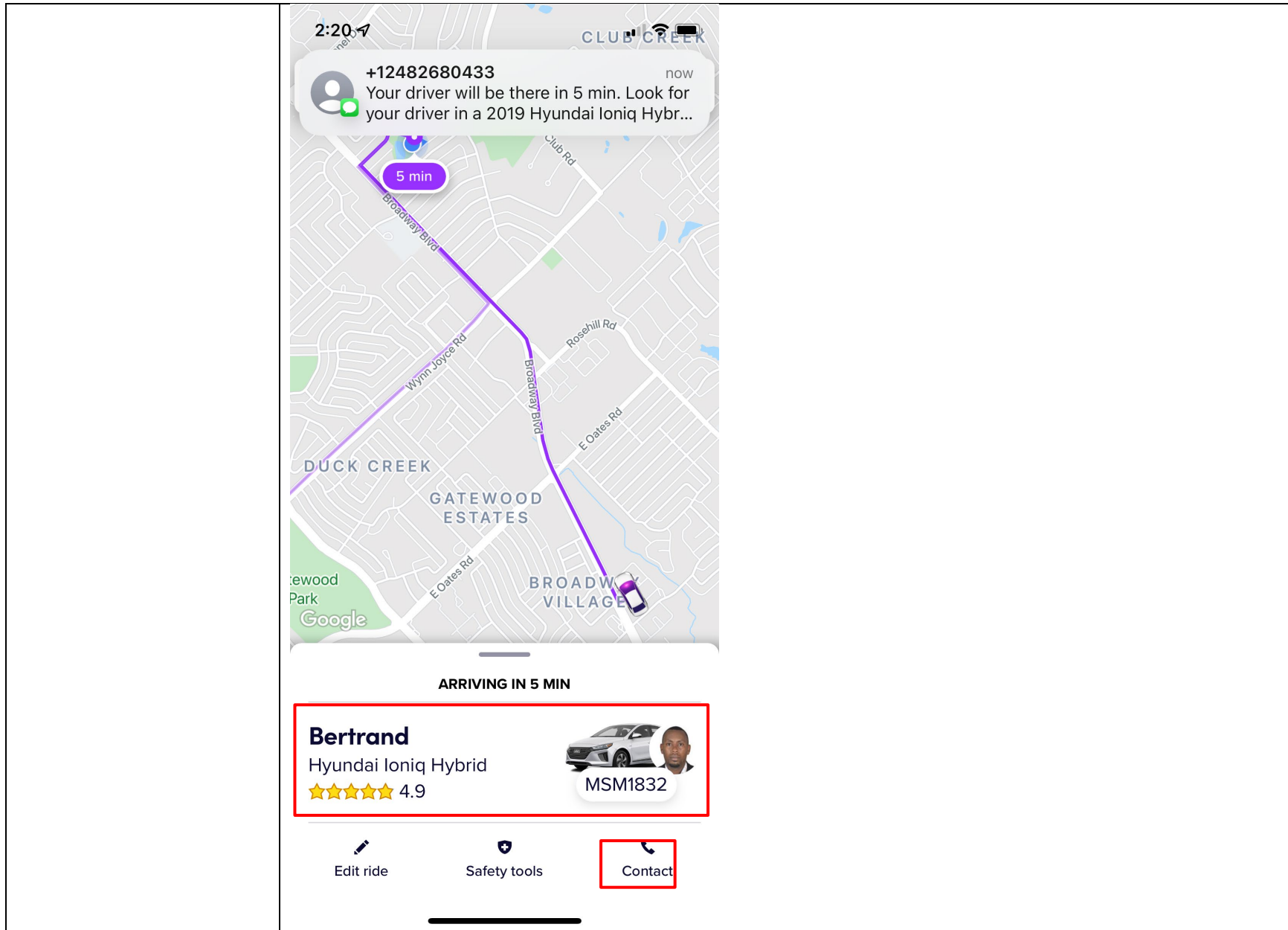

Attachment E for US Patent No. 7,031,728 Against Lyft Accused Products

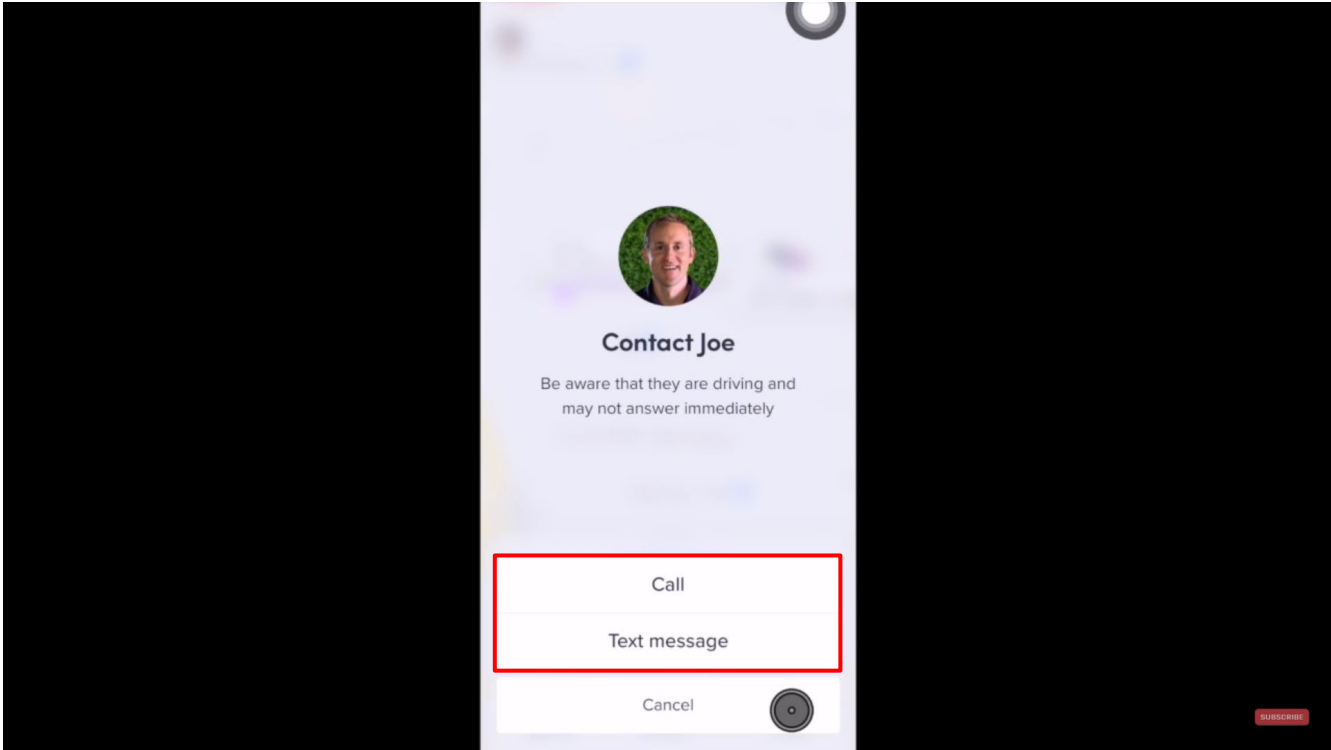
Claim – 7,031,728	Exemplary Supporting Evidence Regarding Accused Products
	 <p>The screenshot shows a mobile application interface for a contact named 'Contact Joe'. The contact's name is displayed in bold black text. Below the name, a warning message reads: 'Be aware that they are driving and may not answer immediately'. At the bottom of the contact card, there are three buttons: 'Call', 'Text message', and 'Cancel'. The 'Call' and 'Text message' buttons are enclosed in a red rectangular box. A 'SUBSCRIBE' button is visible in the bottom right corner of the app interface.</p> <p>https://www.youtube.com/watch?v=j0RDMLcmOgU at 5:32</p>

Attachment E for US Patent No. 7,031,728 Against Lyft Accused Products

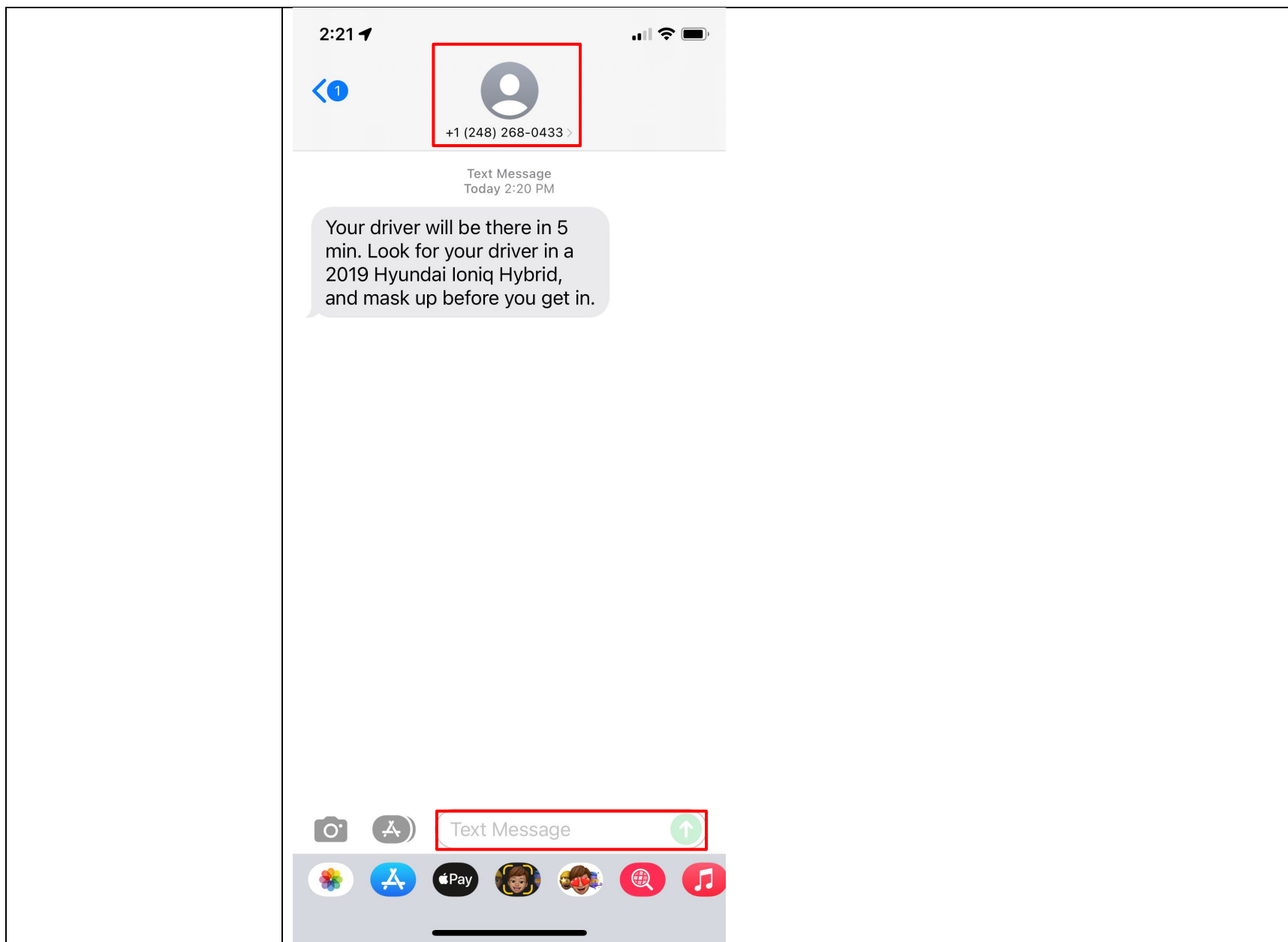

Attachment E for US Patent No. 7,031,728 Against Lyft Accused Products

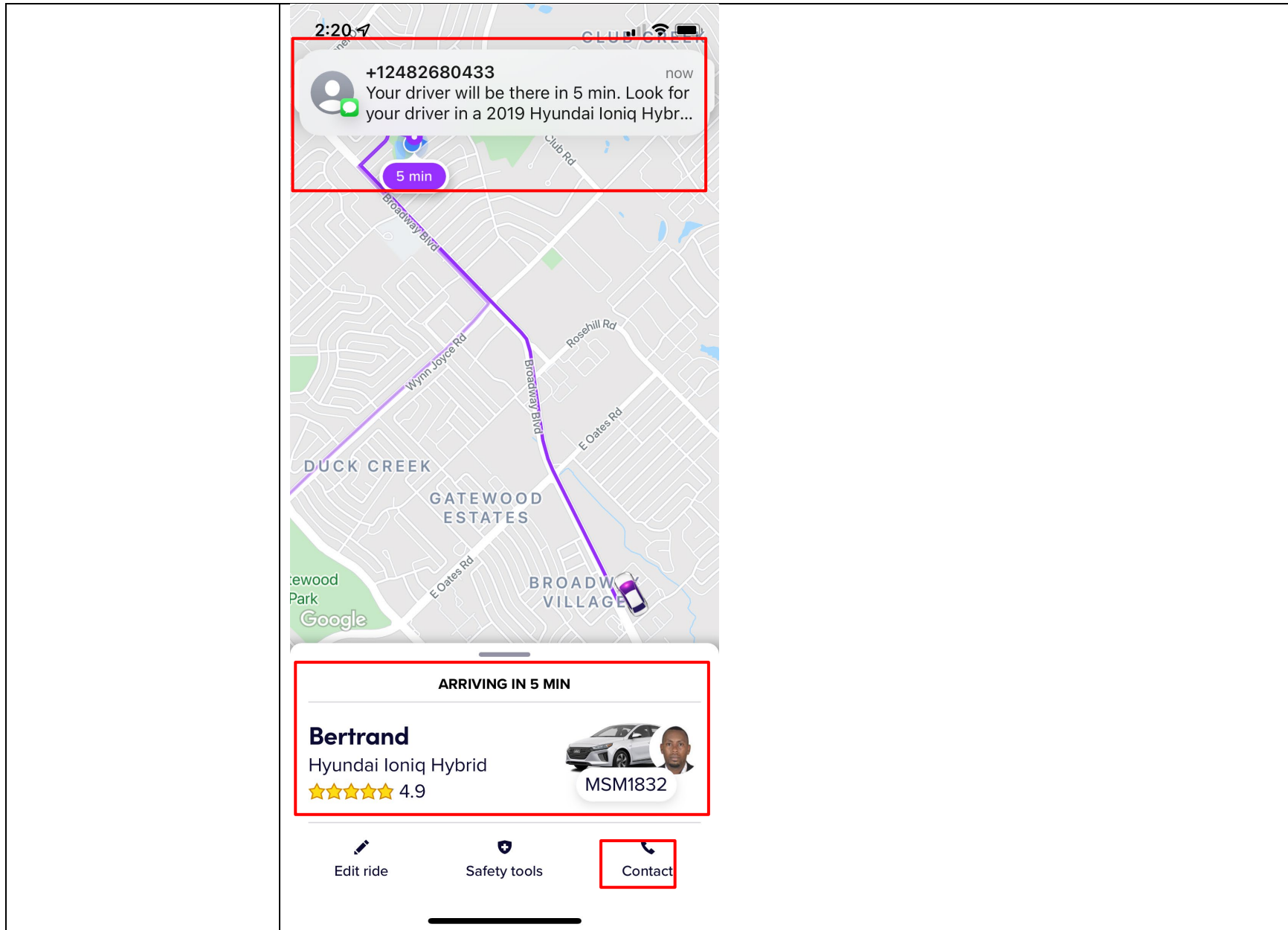

Attachment E for US Patent No. 7,031,728 Against Lyft Accused Products

Claim – 7,031,728	Exemplary Supporting Evidence Regarding Accused Products
	<p>Further, to the extent this element is performed at least in part by Lyft's software source code, AGIS reserves the right to supplement these contentions pursuant to production of such source code by Lyft and to the extent Lyft requires additional information in accordance with P.R. 3-1 and for any other reasons.</p>
<p>7[A] a) generating one or more symbols on the touch display screen, each representing a different participant that has a cellular phone that includes said voice communication, free and operator selected text messages, photograph and video, a CPU, said GPS system and a touch screen display;</p>	<p>See Claim 7P above. The Lyft Accused Products practice generating one or more symbols on the touch display screen, each representing a different participant that has a cellular phone that includes said voice communication, free and operator selected text messages, photograph and video, a CPU, said GPS system and a touch screen display.</p> <p>This element is infringed literally, or in the alternative, under the doctrine of equivalents.</p> <p>For example, drivers' and passengers' mobile phones with the Lyft Driver and the Lyft app installed generates symbols including but not limited to blue dot denoting passenger's location, blue navigate icon denoting driver's location, and vehicle icons denoting nearby driver's location on the display of the mobile phones.</p> <p>Lyft Driver app</p> <p>We've separated the passenger and driver experiences into two separate mobile apps — one exclusively for passengers (named the Lyft app) and the other exclusively for drivers (named the Lyft Driver app).</p> <p>The Lyft Driver app will eventually be standard for all drivers and required for driving. At this time, drivers can keep using the Lyft app to give rides. Don't worry! While we have some planned improvements to the Lyft Driver app, we've kept its features the same.</p> <p>https://help.lyft.com/hc/en-ca/articles/115013079208-Lyft-Driver-app</p>

Attachment E for US Patent No. 7,031,728 Against Lyft Accused Products

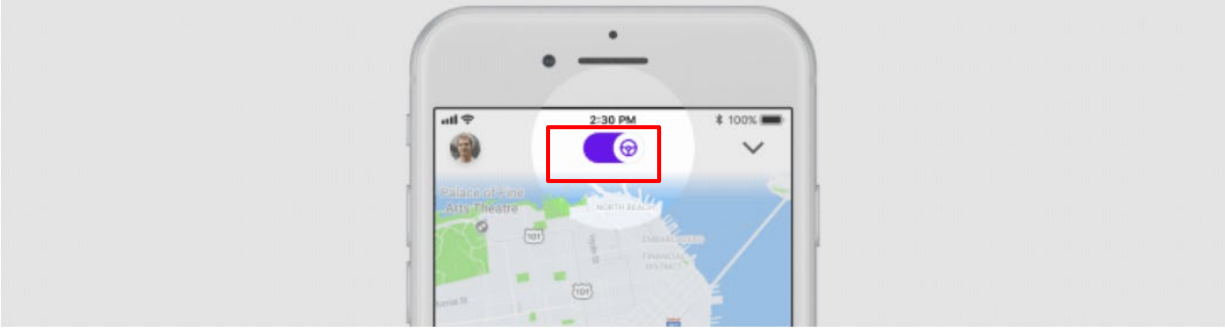
Claim – 7,031,728	Exemplary Supporting Evidence Regarding Accused Products
	<p data-bbox="583 245 884 293">What is Lyft?</p> <p data-bbox="583 347 1654 415">Lyft is a platform that connects drivers with individuals and organizations that need rides.</p> <p data-bbox="573 444 1050 477">https://www.lyft.com/drive-with-lyft</p>  <p data-bbox="573 911 699 935">Go online</p> <p data-bbox="573 976 1774 1081">Open your Lyft Driver app and tap the steering wheel icon. Lyft will now find the closest passenger to your location requesting a ride. Turn on some music and get comfortable: that first ride request may come quickly or may take a while, depending on the number of current passenger requests.</p> <p data-bbox="573 1089 1230 1122">https://www.lyft.com/hub/posts/how-to-give-a-ride</p>

Attachment E for US Patent No. 7,031,728 Against Lyft Accused Products

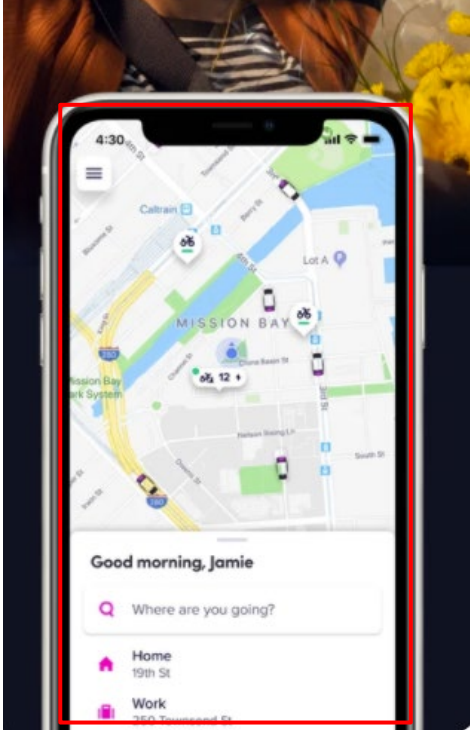
Claim – 7,031,728	Exemplary Supporting Evidence Regarding Accused Products
	 <p>https://apps.apple.com/in/app/lyft/id529379082</p>

Attachment E for US Patent No. 7,031,728 Against Lyft Accused Products

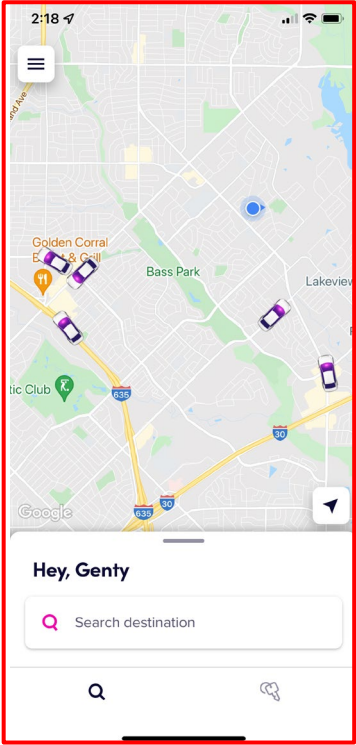
Claim – 7,031,728	Exemplary Supporting Evidence Regarding Accused Products
	 <p>The screenshot displays a mobile application interface. At the top, the time is 2:18. Below the time is a menu icon. The main area is a map showing a residential neighborhood with several purple car icons representing vehicles. Labels on the map include 'Golden Corral E. & Grill', 'Bass Park', 'Lakeview', and 'Tennis Club'. At the bottom of the screen, there is a white search bar with the text 'Hey, Genty' and a magnifying glass icon. Below the search bar are two icons: a magnifying glass and a hand cursor.</p>

Attachment E for US Patent No. 7,031,728 Against Lyft Accused Products

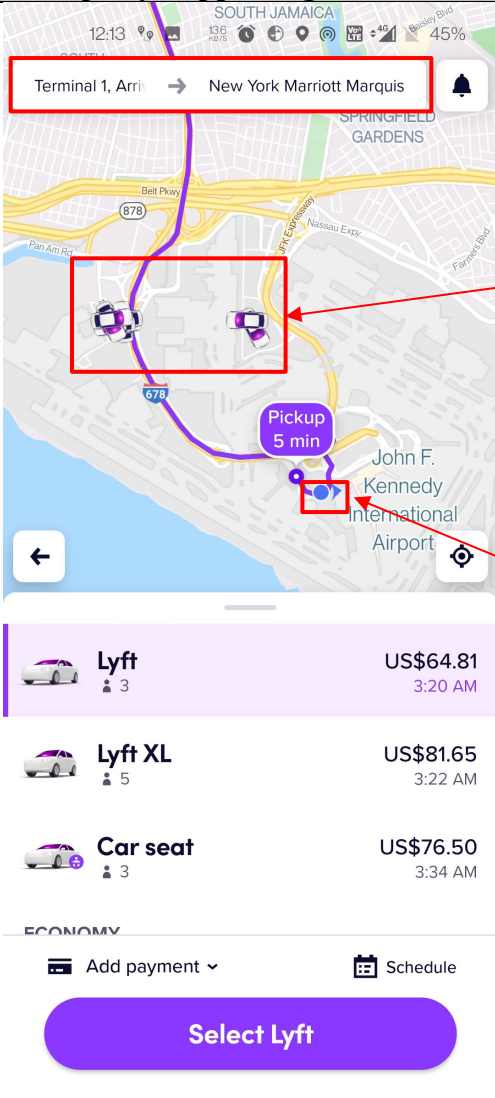
Claim – 7,031,728	Exemplary Supporting Evidence Regarding Accused Products
	 <p>The screenshot displays the Lyft app interface. At the top, the route is set from 'Terminal 1, Arrivals' to 'New York Marriott Marquis'. The map shows the pickup location at John F. Kennedy International Airport, with a 'Pickup 5 min' indicator. Two nearby driver locations are marked with car icons and highlighted by a red box. A red arrow points from a text box labeled 'Nearby Drivers' location' to this red box. Another red arrow points from a text box labeled 'Passenger's location' to a red box around the pickup location on the map. Below the map, three ride options are listed: 'Lyft' (US\$64.81, 3:20 AM), 'Lyft XL' (US\$81.65, 3:22 AM), and 'Car seat' (US\$76.50, 3:34 AM). At the bottom, there is a 'Select Lyft' button.</p>

Attachment E for US Patent No. 7,031,728 Against Lyft Accused Products

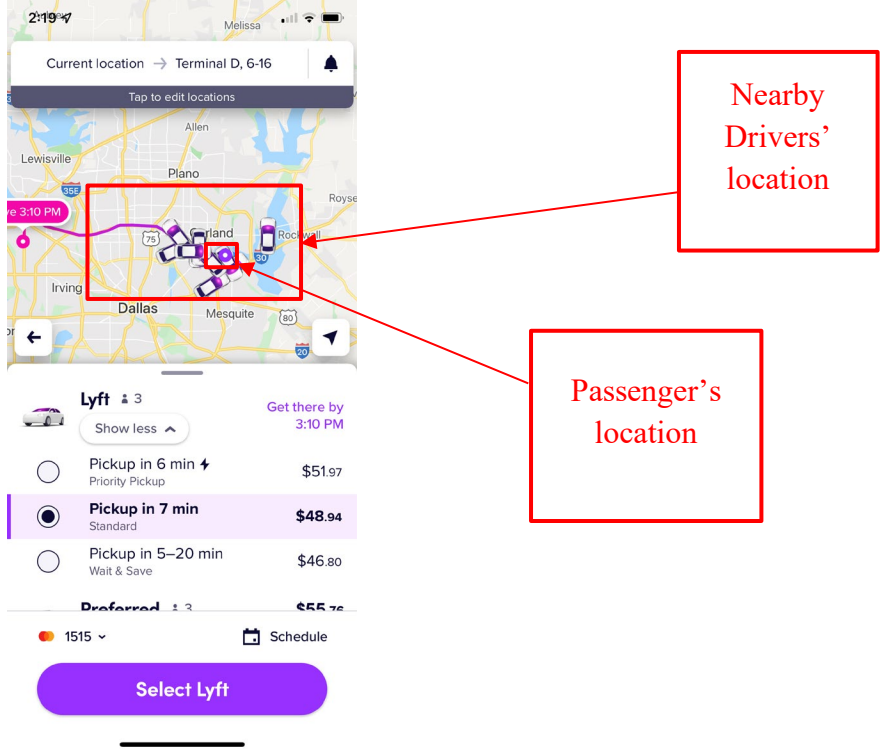
Claim – 7,031,728	Exemplary Supporting Evidence Regarding Accused Products
	 <p>The screenshot displays the Lyft app interface. At the top, the current location is set to 'Terminal D, 6-16'. Below the map, there are three pickup options: 'Priority Pickup' (6 min, \$51.97), 'Standard' (7 min, \$48.94), and 'Wait & Save' (5-20 min, \$46.80). A red box on the map highlights the area around the passenger's location, with an arrow pointing to a text box labeled 'Passenger's location'. Another red box highlights the area around nearby drivers, with an arrow pointing to a text box labeled 'Nearby Drivers' location'.</p>

Attachment E for US Patent No. 7,031,728 Against Lyft Accused Products

Claim – 7,031,728	Exemplary Supporting Evidence Regarding Accused Products
	 <p>Driver's device displaying passenger's ride request message</p> <p>Passenger's location when pickup location is set to current location</p> <p>Driver's location</p> <p>https://www.youtube.com/watch?v=jVUy9poJDng at 10:24, Annotated</p>

Attachment E for US Patent No. 7,031,728 Against Lyft Accused Products

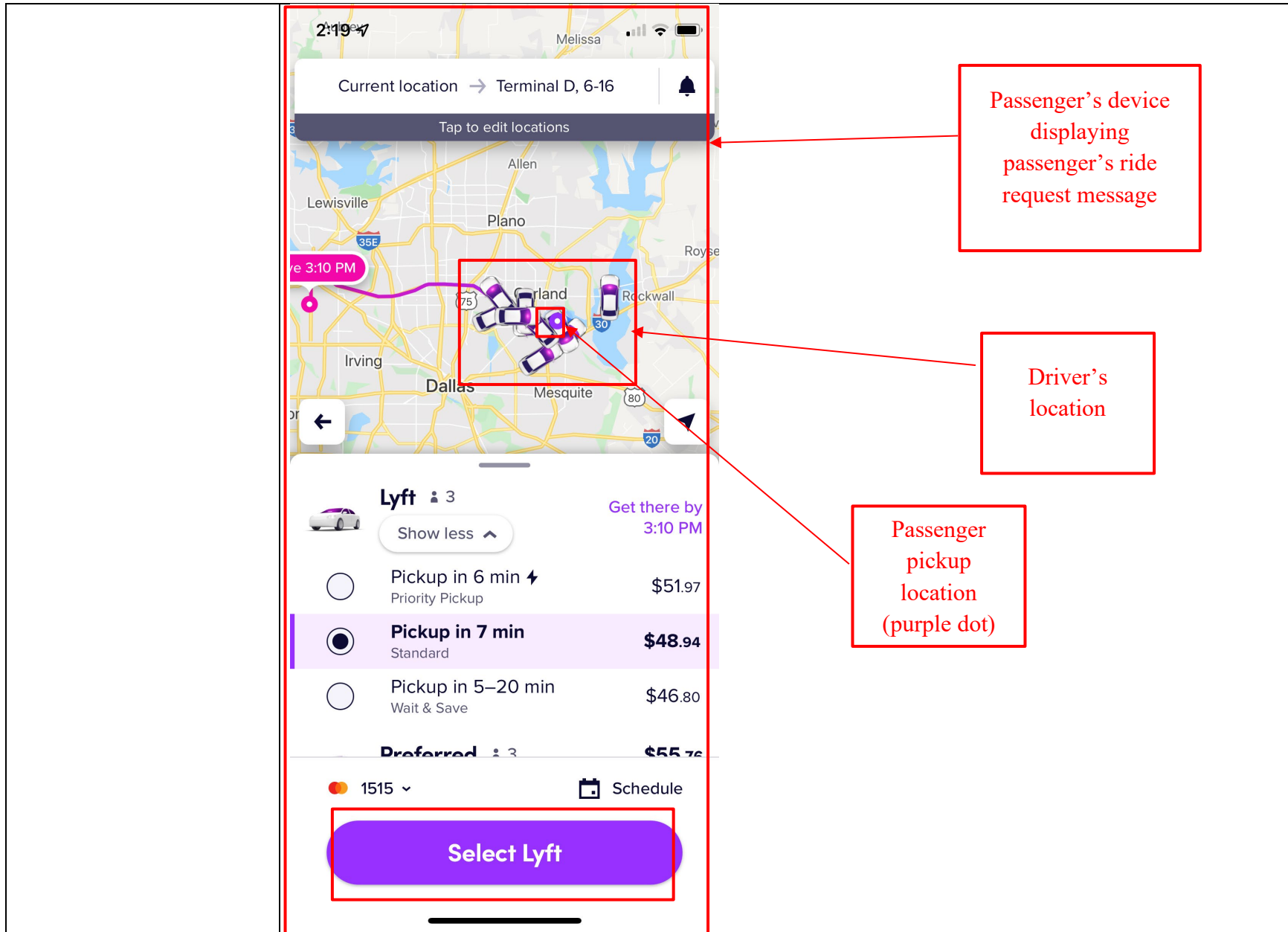

Attachment E for US Patent No. 7,031,728 Against Lyft Accused Products

Claim – 7,031,728	Exemplary Supporting Evidence Regarding Accused Products
	<p>Further, to the extent this element is performed at least in part by Lyft's software source code, AGIS reserves the right to supplement these contentions pursuant to production of such source code by Lyft and to the extent Lyft requires additional information in accordance with P.R. 3-1 and for any other reasons.</p>
<p>7[B]. b) providing and storing in each of the participant cellular phones one or more cellular phone telephone numbers, each cellular phone number of which relates to a different symbol of each of the participants in the communication network;</p>	<p>The Lyft Accused Products practice providing and storing in each of the participant cellular phones one or more cellular phone telephone numbers, each cellular phone number of which relates to a different symbol of each of the participants in the communication network.</p> <p>This element is infringed literally, or in the alternative, under the doctrine of equivalents.</p> <p>For example, Lyft designates virtual numbers for each rider and driver when they join the Lyft network and initiate communications with each other. Lyft stores and provides the virtual phone numbers in the Lyft apps and/or the Lyft server(s). Respective phone numbers for each driver/rider is associated with the corresponding rider/driver and their symbols.</p> <p>How to start an application</p> <p>Create a Lyft account through the app or on the web at lyft.com/drivers.</p> <p>Enter your name, phone number, and email address, then submit all the info we need to ensure you meet the requirements. If you sign out of your account, any application info you've submitted will be saved.</p> <p>If you have a promo code, enter it when creating an account. If you apply through a link on a website, the code will be added automatically.</p> <p>Back to top</p> <p>https://help.lyft.com/hc/e/articles/115013081188</p>

Attachment E for US Patent No. 7,031,728 Against Lyft Accused Products

Claim – 7,031,728	Exemplary Supporting Evidence Regarding Accused Products
	<p data-bbox="583 237 1192 264">Before you begin, be sure you have the following:</p> <ul data-bbox="653 302 961 435" style="list-style-type: none"><li data-bbox="653 302 961 329">• Your phone number<li data-bbox="653 354 926 381">• Your email address<li data-bbox="653 406 926 435">• A photo of yourself <p data-bbox="583 488 722 516">Get started</p> <ol data-bbox="653 553 1900 862" style="list-style-type: none"><li data-bbox="653 553 1136 581">1. Type in your device's phone number<li data-bbox="653 605 1900 670">2. To verify your identity, we'll send a verification code via text to your phone number. We want to make sure you're human!<li data-bbox="653 695 1801 722">3. The text message should arrive immediately. If you don't see it after a bit, tap 'Resend code.'<li data-bbox="653 747 1759 774">4. Type in your name, email address, and take a selfie so your driver knows who to pick up<li data-bbox="653 799 1900 862">5. That's it! Once you've set up your account, you'll be able to request a ride (Learn How to request a ride). <p data-bbox="583 886 1598 914">https://help.lyft.com/hc/e/articles/115012926947-How-to-create-a-Lyft-account</p>

Attachment E for US Patent No. 7,031,728 Against Lyft Accused Products

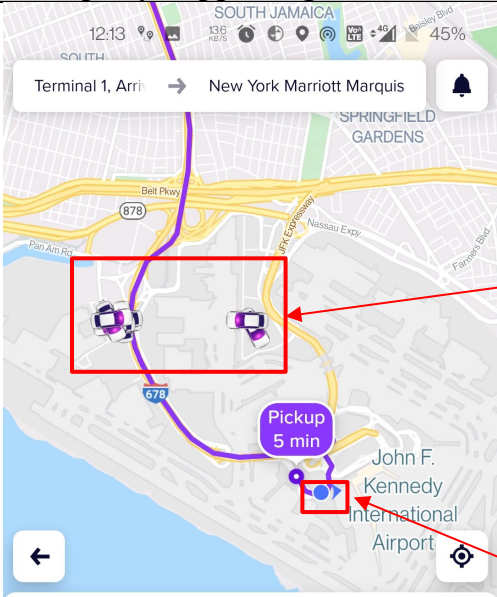
Claim – 7,031,728	Exemplary Supporting Evidence Regarding Accused Products
	 <p>The screenshot displays the Lyft app interface. At the top, the route is set from 'Terminal 1, Arrivals' to 'New York Marriott Marquis'. The map shows the area around JFK Airport, with a red box highlighting two nearby driver icons and another red box highlighting the passenger's location icon. Below the map, three ride options are listed: 'Lyft' (US\$64.81, 3:20 AM), 'Lyft XL' (US\$81.65, 3:22 AM), and 'Car seat' (US\$76.50, 3:34 AM). A large purple button at the bottom says 'Select Lyft'.</p> <p>Nearby Drivers' location</p> <p>Passenger's location</p>

Attachment E for US Patent No. 7,031,728 Against Lyft Accused Products

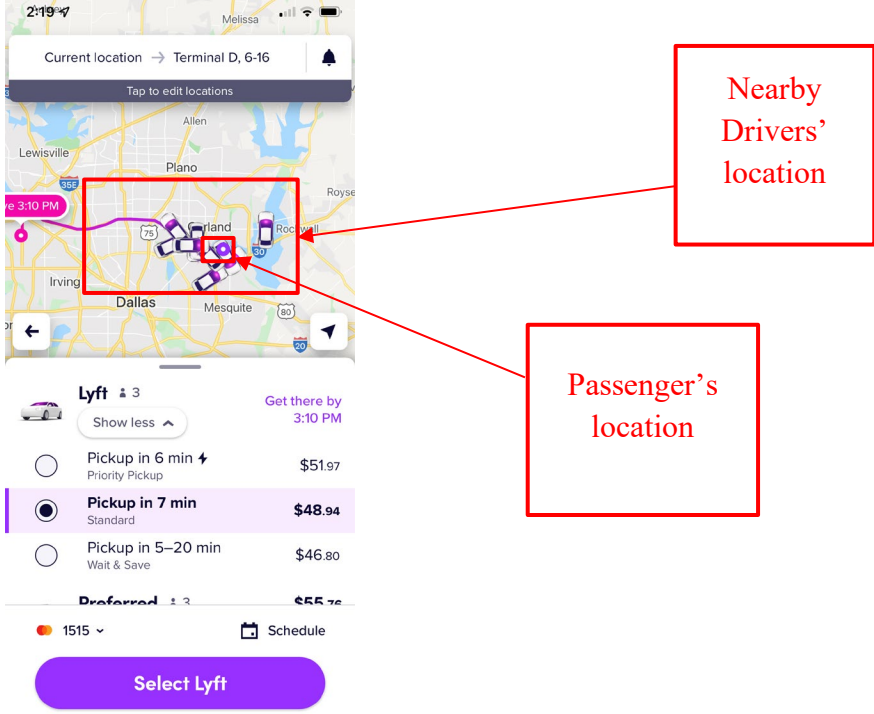
Claim – 7,031,728	Exemplary Supporting Evidence Regarding Accused Products
	 <p>The screenshot displays the Lyft app interface. At the top, the current location is set to "Terminal D, 6-16". Below the map, there are three ride options: "Priority Pickup" (6 min, \$51.97), "Standard" (7 min, \$48.94), and "Wait & Save" (5-20 min, \$46.80). A "Select Lyft" button is at the bottom. Red annotations highlight the passenger's location on the map and nearby drivers' locations.</p> <p>Nearby Drivers' location</p> <p>Passenger's location</p>

Attachment E for US Patent No. 7,031,728 Against Lyft Accused Products

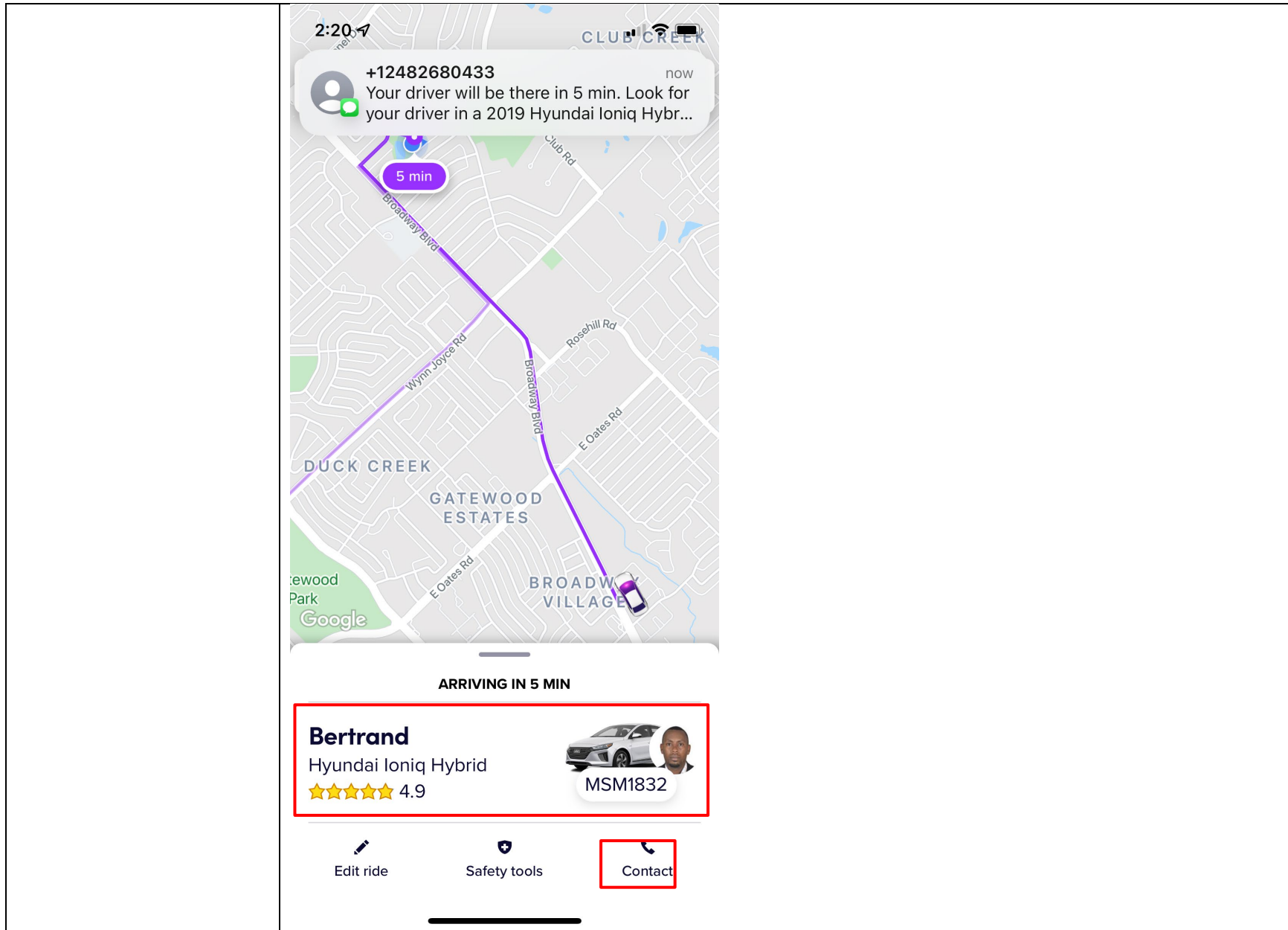

Attachment E for US Patent No. 7,031,728 Against Lyft Accused Products

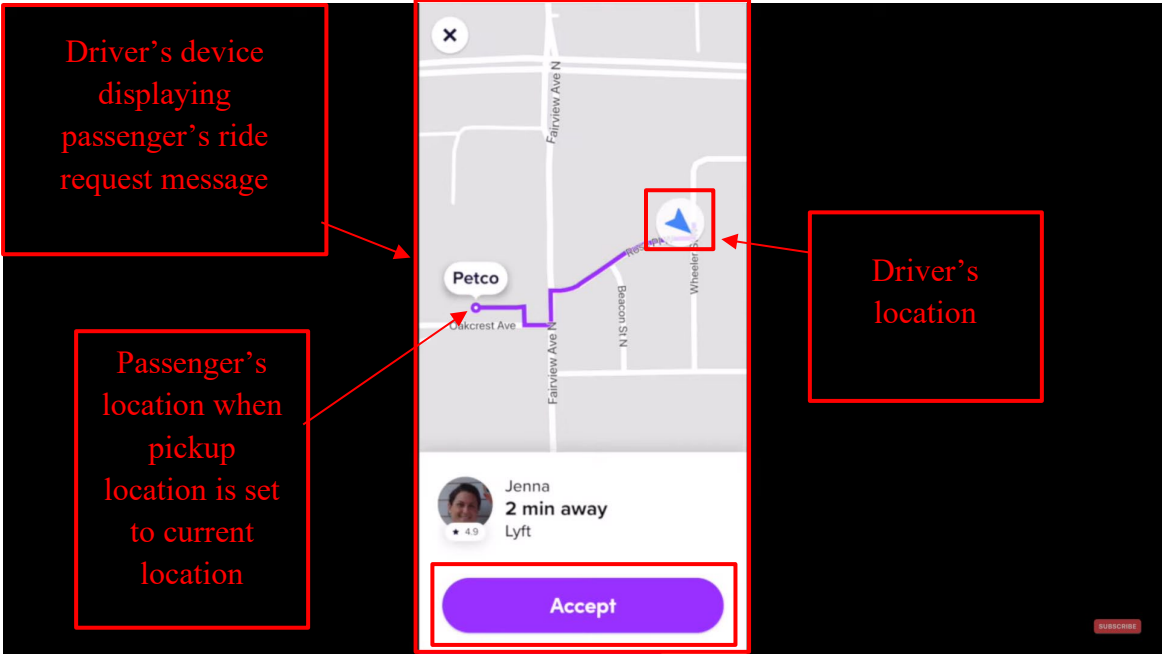
Claim – 7,031,728	Exemplary Supporting Evidence Regarding Accused Products
	 <p>The screenshot shows a Lyft ride request interface. A map displays a route from a pickup location (marked with a red dot) to a destination (Petco). A driver's location is indicated by a blue arrow on the map. Below the map, the driver's name is Jenna, with a 4.9 rating and a 2-minute estimated arrival time. A purple 'Accept' button is visible at the bottom. Three red boxes with arrows point to specific elements: 'Driver's device displaying passenger's ride request message' points to the top of the map area; 'Passenger's location when pickup location is set to current location' points to the red dot on the map; and 'Driver's location' points to the blue arrow on the map.</p> <p>https://www.youtube.com/watch?v=jVUy9poJDng at 10:24, Annotated</p>

Attachment E for US Patent No. 7,031,728 Against Lyft Accused Products

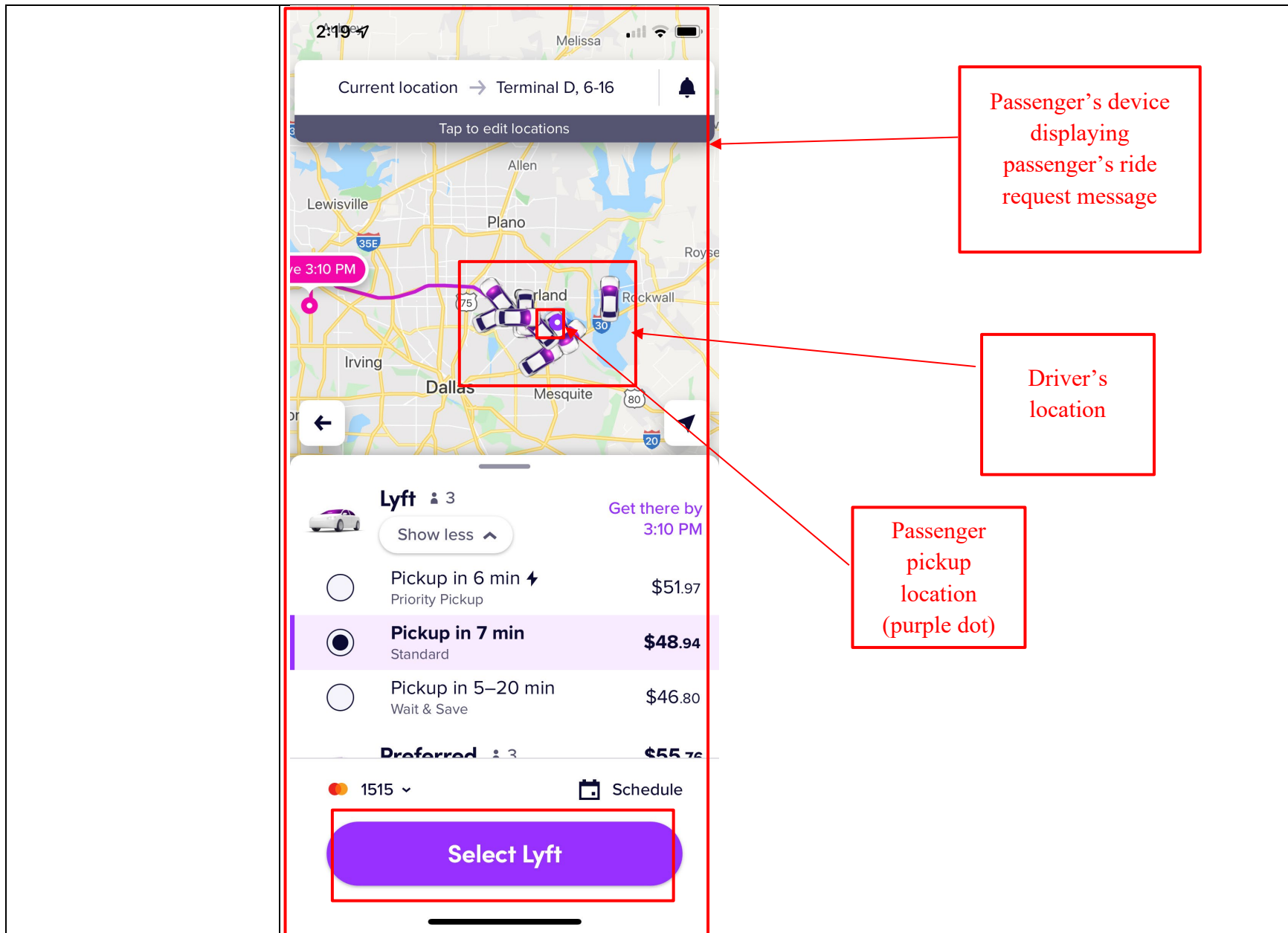

Attachment E for US Patent No. 7,031,728 Against Lyft Accused Products

Claim – 7,031,728	Exemplary Supporting Evidence Regarding Accused Products
	<p>Further, to the extent this element is performed at least in part by Lyft's software source code, AGIS reserves the right to supplement these contentions pursuant to production of such source code by Lyft and to the extent Lyft requires additional information in accordance with P.R. 3-1 and for any other reasons.</p> <p>With respect to the limitations reciting the cellular phone number(s) or telephone number(s), the claim is met either literally or under the doctrine of equivalents.</p>
<p>7[C]. c) providing initiating cellular phone calling software in each cellular phone that is activated by touching a symbol on the touch display that automatically initiates a cellular phone call using the stored cellular phone number to the participant represented by the symbol; and</p>	<p>The Lyft Accused Products practice providing initiating cellular phone calling software in each cellular phone that is activated by touching a symbol on the touch display that automatically initiates a cellular phone call using the stored cellular phone number to the participant represented by the symbol.</p> <p>This element is infringed literally, or in the alternative, under the doctrine of equivalents.</p> <p>For example, the Lyft app provides selectable interface elements within the Lyft app to call the rider/driver represented by a symbol. For example, when the driver is matched to the passenger, both the driver and the passenger receive the call icon on their respective Lyft apps through which both the driver and the passenger are given the functionality to call each other from within the apps. The call is placed using a virtual phone number.</p>

Attachment E for US Patent No. 7,031,728 Against Lyft Accused Products

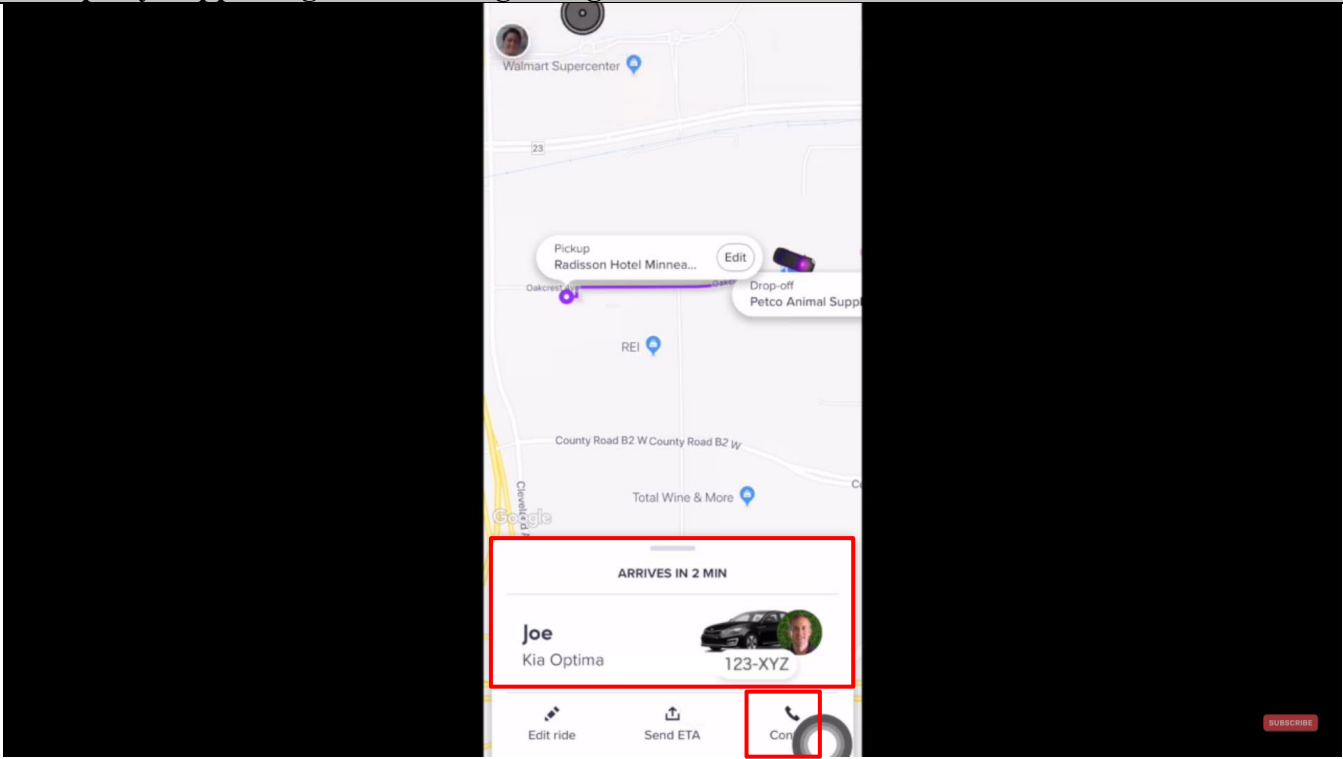
Claim – 7,031,728	Exemplary Supporting Evidence Regarding Accused Products
	 <p>https://www.youtube.com/watch?v=j0RDMLcmOgU at 5:07</p>

Attachment E for US Patent No. 7,031,728 Against Lyft Accused Products

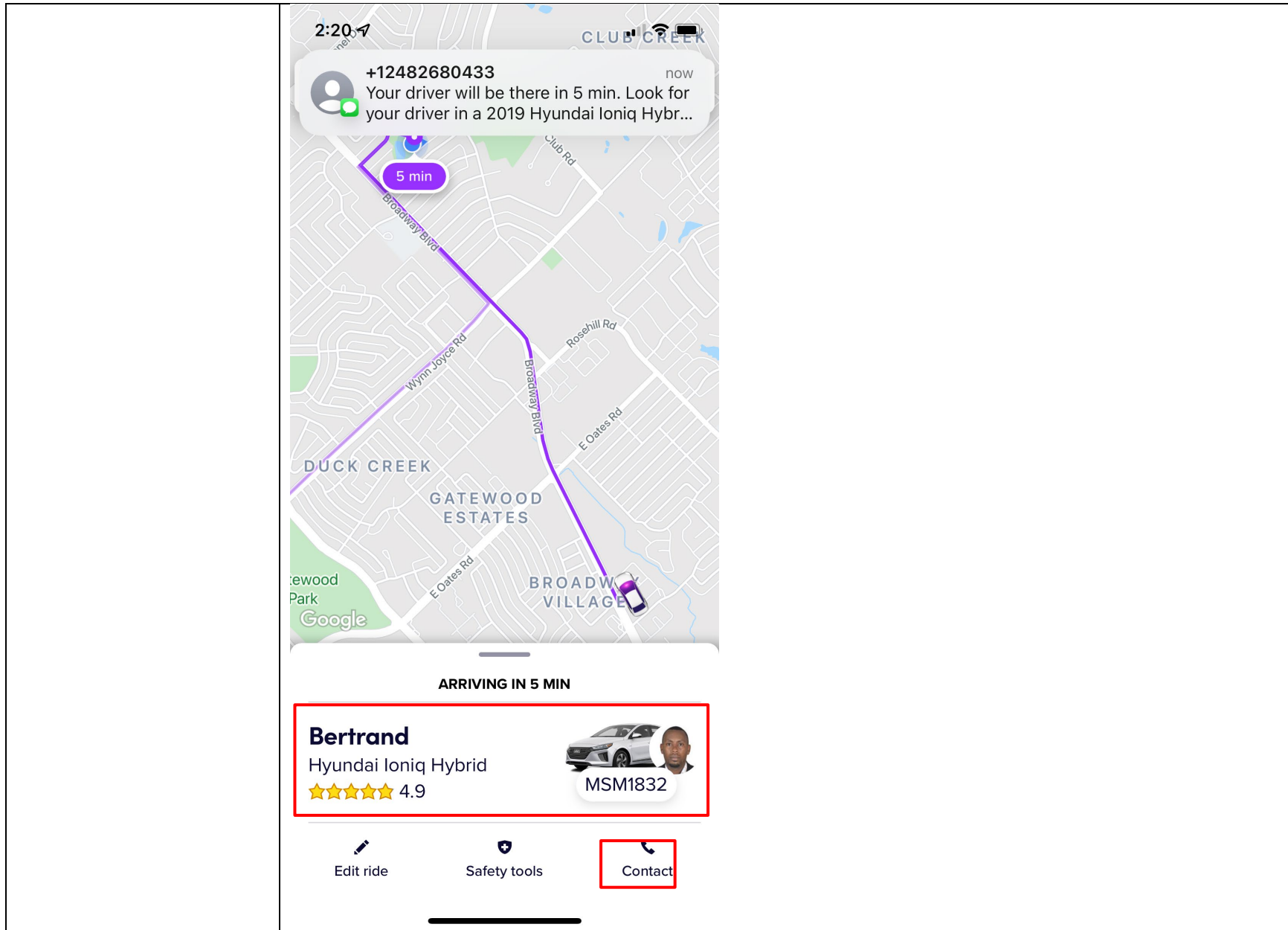

Attachment E for US Patent No. 7,031,728 Against Lyft Accused Products

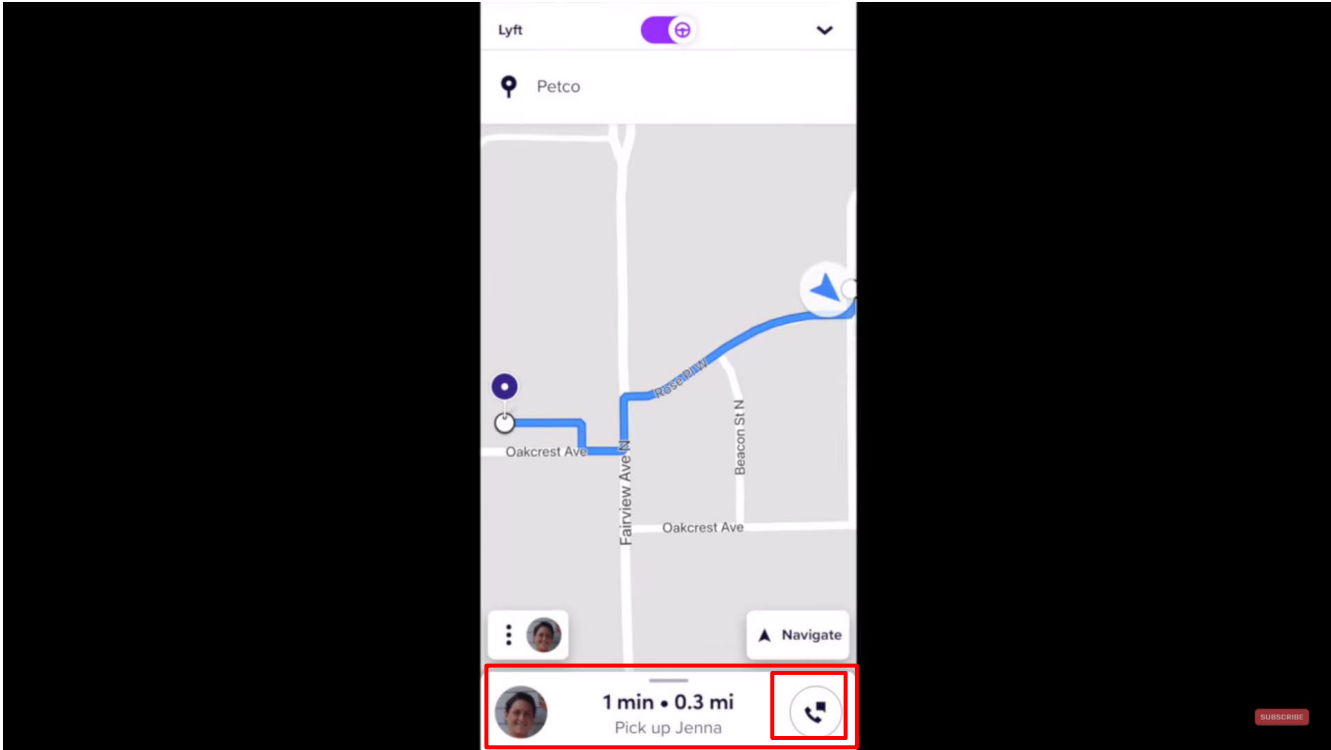
Claim – 7,031,728	Exemplary Supporting Evidence Regarding Accused Products
	 <p>The screenshot shows the Lyft app interface. At the top, the destination is 'Petco'. A blue route is displayed on a map, starting from a pickup location and ending at Jenna's location. The estimated time and distance are '1 min • 0.3 mi'. Below this information, there is a driver's profile picture and a 'Call' button, which is highlighted with a red box. The 'Call' button is a circular icon with a telephone handset. The map shows streets including Oakcrest Ave, Fairview Ave N, Beacon St N, and Rosenblum. A 'Navigate' button is visible at the bottom right of the map area.</p> <p>https://www.youtube.com/watch?v=jVUy9poJDng at 10:46</p>

Attachment E for US Patent No. 7,031,728 Against Lyft Accused Products

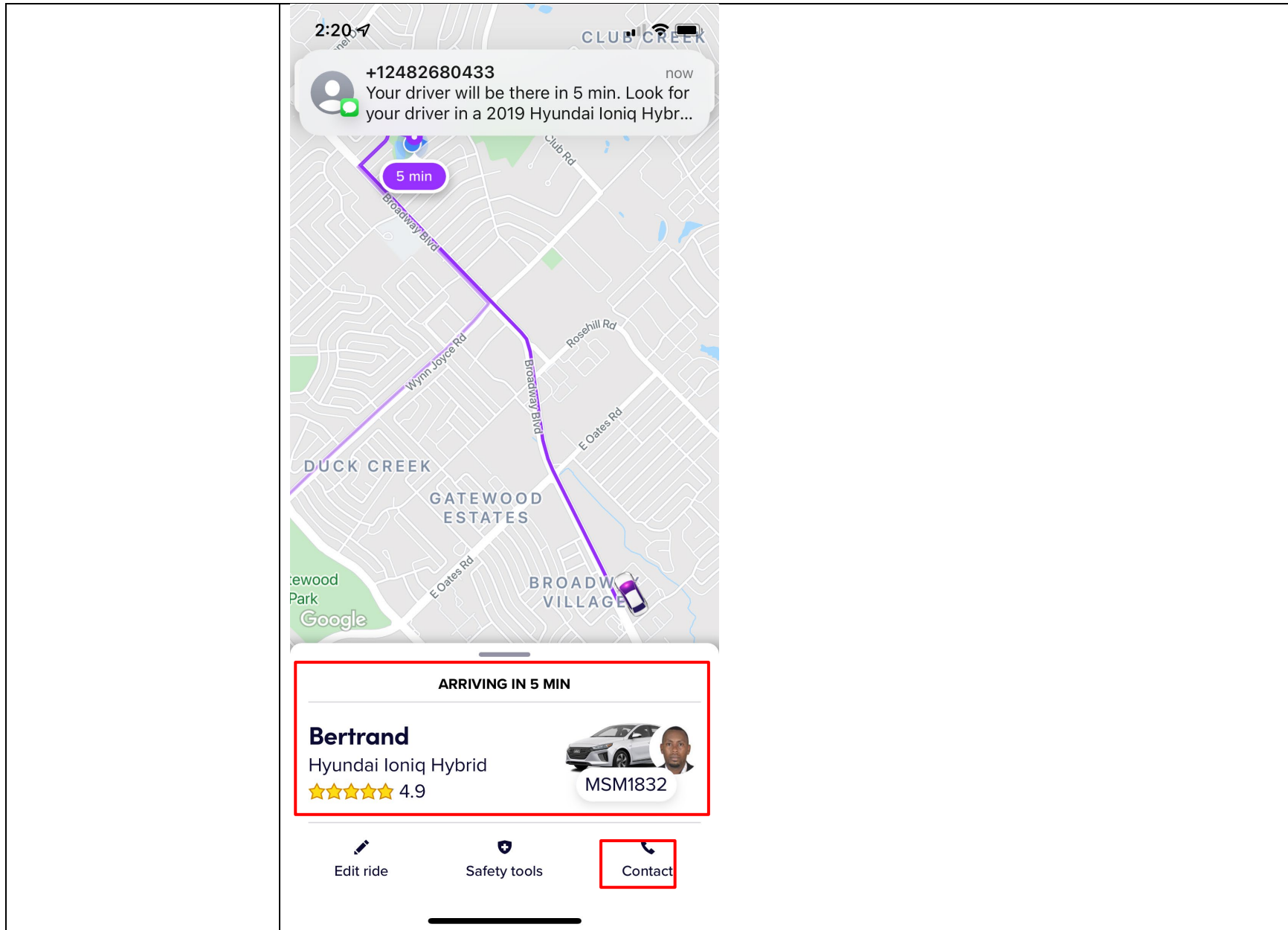

Attachment E for US Patent No. 7,031,728 Against Lyft Accused Products

Claim – 7,031,728	Exemplary Supporting Evidence Regarding Accused Products
	<p>Further, to the extent this element is performed at least in part by Lyft's software source code, AGIS reserves the right to supplement these contentions pursuant to production of such source code by Lyft and to the extent Lyft requires additional information in accordance with P.R. 3-1 and for any other reasons.</p> <p>The With respect to the limitations reciting the cellular phone number(s) or telephone number(s), the claim is met either literally or under the doctrine of equivalents.</p>
<p>7[D]. d) generating a geographical location chart on said display screen to show the geographical location of each of the symbols representing the participants in the communication network by latitude and longitude.</p>	<p>The Lyft Accused Products practice generating a geographical location chart on said display screen to show the geographical location of each of the symbols representing the participants in the communication network by latitude and longitude.</p> <p>This element is infringed literally, or in the alternative, under the doctrine of equivalents.</p> <p>Lyft meets this limitation because it generates a display with a geographical map presenting symbols representing drivers/riders in the Lyft platform/network. A person of ordinary skill In the art would understand that a map is a type of chart. The symbols are presented in the geographical map based on their respective latitude and longitude. For example, drivers' and passengers' mobile phones with the Lyft Driver and the Lyft app installed generates symbols for riders/drivers. The maps in Lyft and Lyft Driver app also highlight the facility symbols such as a park, airport, and shops. The map in the Lyft app shows the location of the pickup address and the destination address when the passenger requests the ride.</p>

Attachment E for US Patent No. 7,031,728 Against Lyft Accused Products

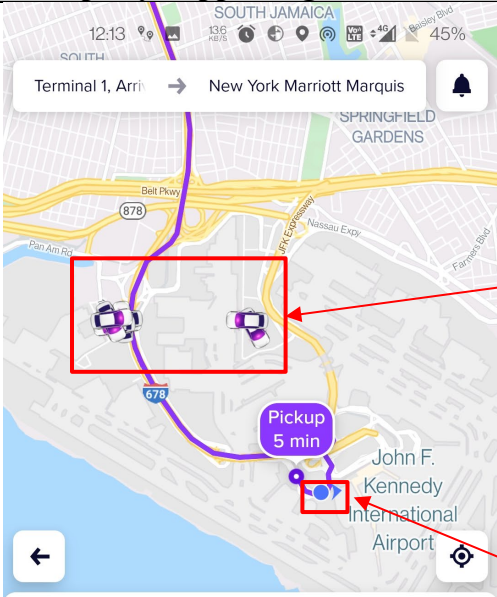
Claim – 7,031,728	Exemplary Supporting Evidence Regarding Accused Products												
	 <p>The screenshot shows the Lyft app interface. At the top, the route is from Terminal 1, Arrivals to New York Marriott Marquis. The map displays the JFK Airport area with a pickup location marked 'Pickup 5 min' near John F. Kennedy International Airport. Two red boxes on the map highlight 'Nearby Drivers' location' and 'Passenger's location'. Below the map, three ride options are listed: Lyft (US\$64.81, 3:20 AM), Lyft XL (US\$81.65, 3:22 AM), and Car seat (US\$76.50, 3:34 AM). At the bottom, there are options to 'Add payment' and 'Schedule', and a large purple button labeled 'Select Lyft'.</p> <table border="1"><thead><tr><th>Option</th><th>Price</th><th>ETA</th></tr></thead><tbody><tr><td>Lyft</td><td>US\$64.81</td><td>3:20 AM</td></tr><tr><td>Lyft XL</td><td>US\$81.65</td><td>3:22 AM</td></tr><tr><td>Car seat</td><td>US\$76.50</td><td>3:34 AM</td></tr></tbody></table>	Option	Price	ETA	Lyft	US\$64.81	3:20 AM	Lyft XL	US\$81.65	3:22 AM	Car seat	US\$76.50	3:34 AM
Option	Price	ETA											
Lyft	US\$64.81	3:20 AM											
Lyft XL	US\$81.65	3:22 AM											
Car seat	US\$76.50	3:34 AM											

Attachment E for US Patent No. 7,031,728 Against Lyft Accused Products

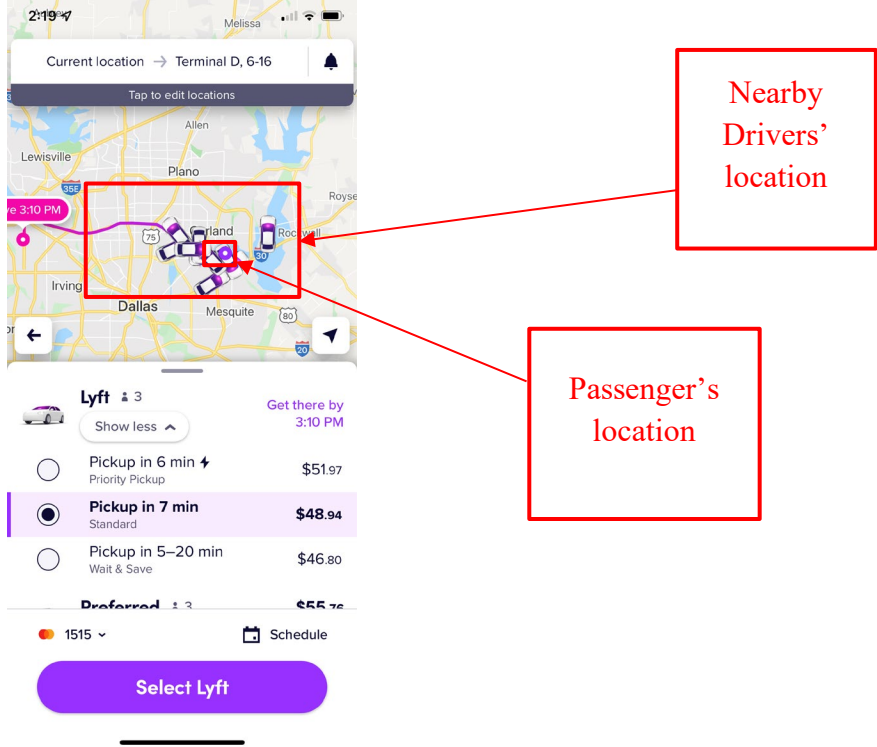
Claim – 7,031,728	Exemplary Supporting Evidence Regarding Accused Products
	 <p>The screenshot displays the Lyft mobile application interface. At the top, the current location is set to 'Terminal D, 6-16'. Below the map, there are three pickup options: 'Priority Pickup' (6 min, \$51.97), 'Standard' (7 min, \$48.94), and 'Wait & Save' (5-20 min, \$46.80). A 'Select Lyft' button is at the bottom. Red annotations highlight a cluster of driver icons on the map as 'Nearby Drivers' location' and a single passenger icon as 'Passenger's location'.</p>

Attachment E for US Patent No. 7,031,728 Against Lyft Accused Products

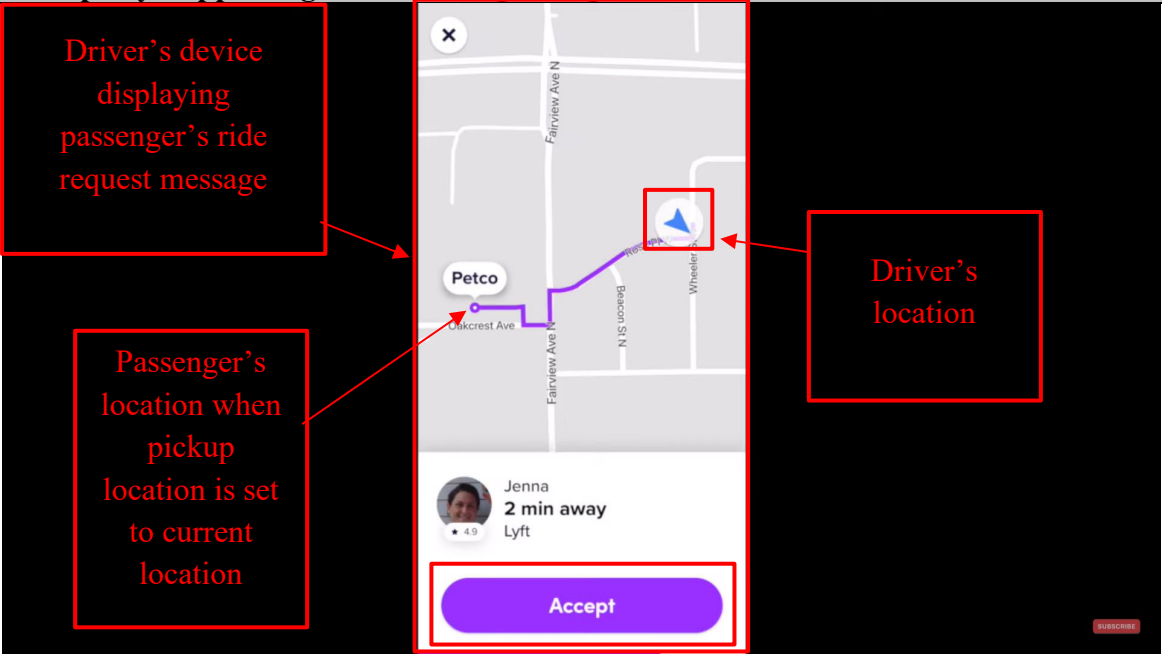
Claim – 7,031,728	Exemplary Supporting Evidence Regarding Accused Products
	 <p>The screenshot shows a Lyft ride request interface. A map displays a route from a pickup location (marked with a red dot) to a destination (Petco). A driver's location is indicated by a blue arrow on the map. The driver's profile shows the name Jenna, a 4.9 rating, and the text "2 min away Lyft". A purple "Accept" button is visible at the bottom. Red boxes and arrows highlight specific elements: "Driver's device displaying passenger's ride request message" points to the top of the interface; "Passenger's location when pickup location is set to current location" points to the red dot on the map; "Driver's location" points to the blue arrow on the map.</p> <p>https://www.youtube.com/watch?v=jVUy9poJDng at 10:24, Annotated</p>

Attachment E for US Patent No. 7,031,728 Against Lyft Accused Products

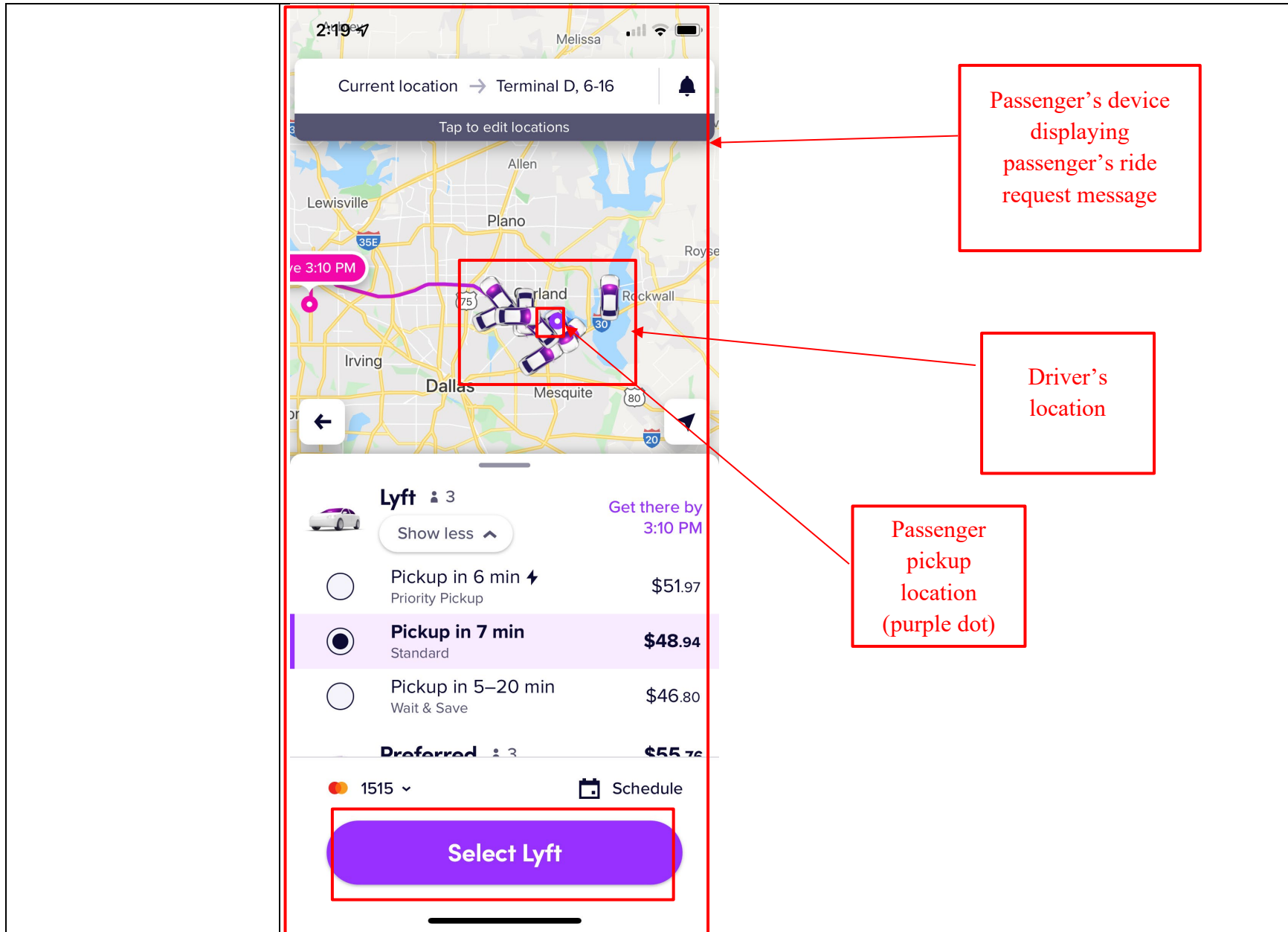

Attachment E for US Patent No. 7,031,728 Against Lyft Accused Products

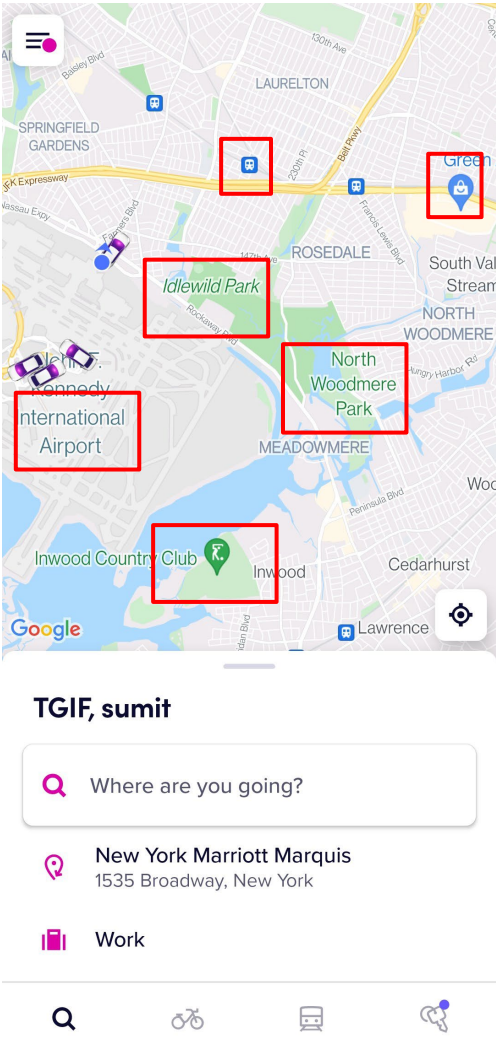
Claim – 7,031,728	Exemplary Supporting Evidence Regarding Accused Products
	 <p>The screenshot displays a mobile application interface. At the top, a map of Queens, New York, is shown with several locations highlighted by red rectangular boxes. These locations include Idlewild Park, North Woodmere Park, Inwood Country Club, and Kennedy International Airport. Below the map, the text "TGIF, sumit" is displayed. Underneath this text is a search bar containing the text "Where are you going?". Below the search bar is a list of suggestions, including "New York Marriott Marquis" with the address "1535 Broadway, New York" and "Work". At the bottom of the screen, there is a navigation bar with icons for search, bicycle, train, and a person with a bicycle.</p>

Attachment E for US Patent No. 7,031,728 Against Lyft Accused Products

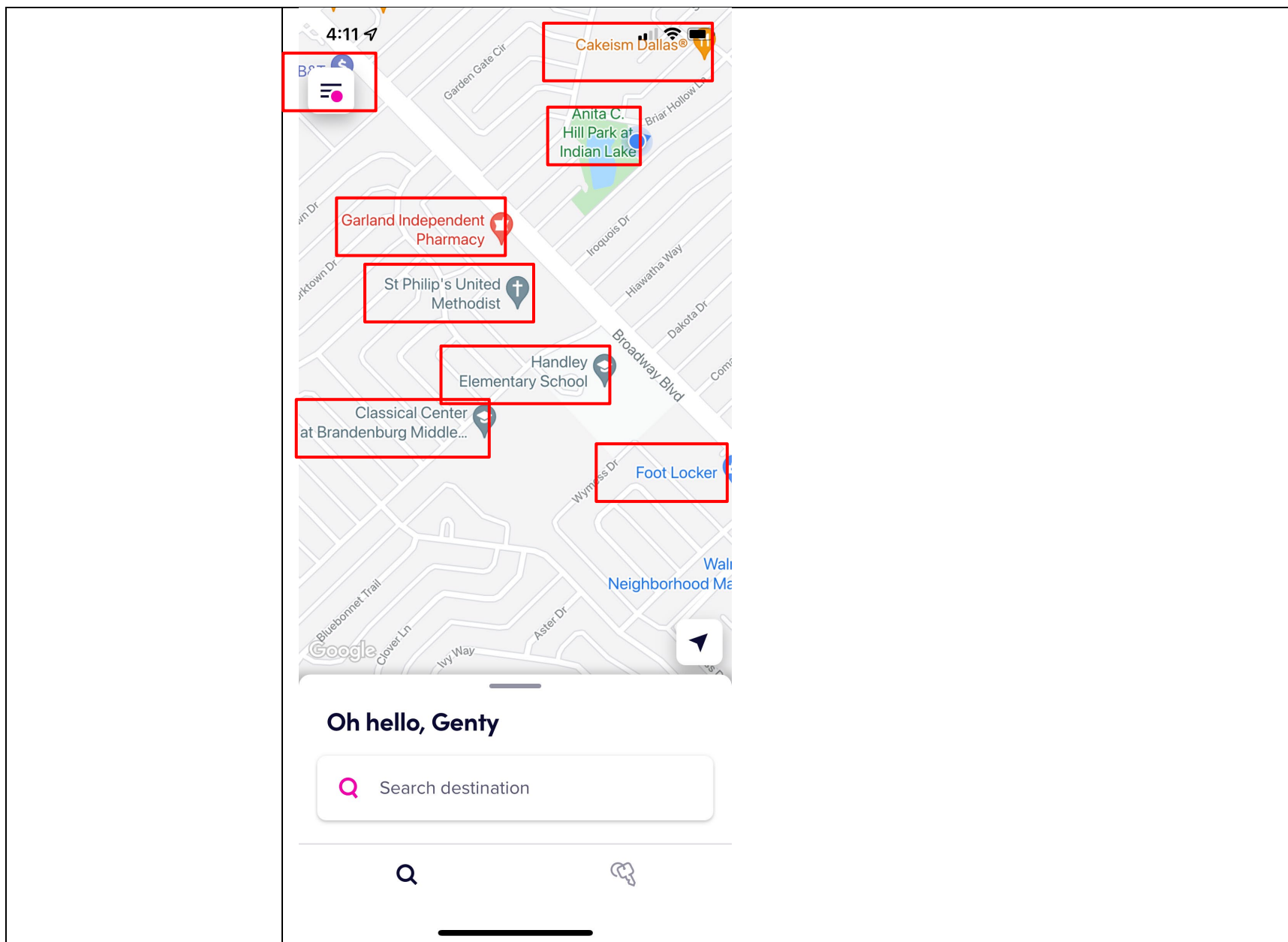

Attachment E for US Patent No. 7,031,728 Against Lyft Accused Products

Claim – 7,031,728	Exemplary Supporting Evidence Regarding Accused Products
	 <p>https://www.youtube.com/watch?v=j0RDMLcmOgU at 4:01</p>

Attachment E for US Patent No. 7,031,728 Against Lyft Accused Products

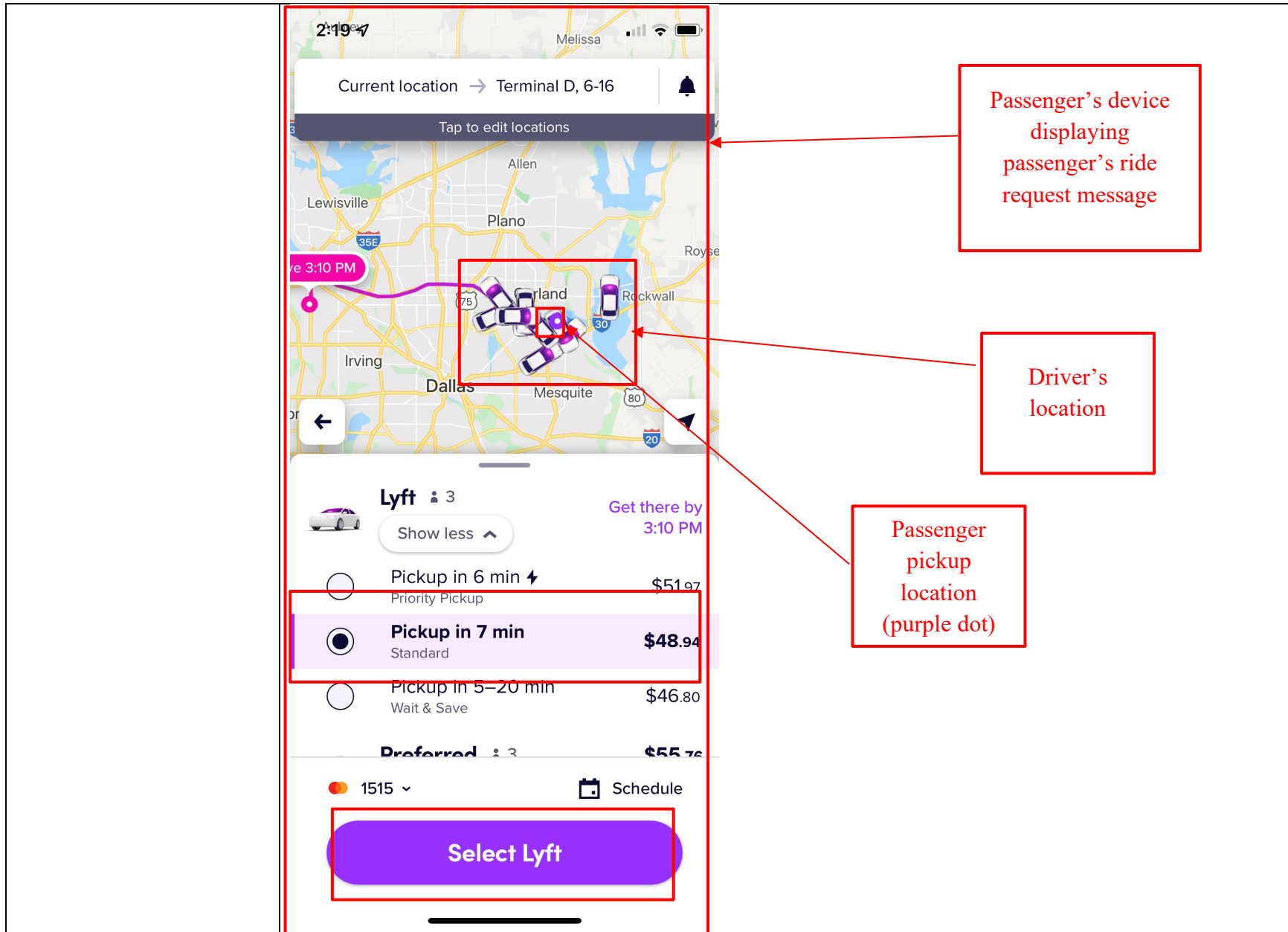

Attachment E for US Patent No. 7,031,728 Against Lyft Accused Products

Claim – 7,031,728	Exemplary Supporting Evidence Regarding Accused Products
	<p>Further, to the extent this element is performed at least in part by Lyft's software source code, AGIS reserves the right to supplement these contentions pursuant to production of such source code by Lyft and to the extent Lyft requires additional information in accordance with P.R. 3-1 and for any other reasons.</p> <p>See Claim 7[A] above.</p>